

HEWLETT-PACKARD

ThinkJet Printer

The Personal Printer from Hewlett-Packard

OWNER'S MANUAL
BENUTZERHANDBUCH
MANUEL UTILISATEUR
MANUAL DEL USUARIO
MANUALE DELL'OPERATORE
GEBRUIKER'S HANDBOEK
SYSTEM HÅNDBOG
BRUKERHÅNDBOK
ÄGAR MANUAL
OMISTAJAN KÄSIKIRJA



HEWLETT-PACKARD



**OPERATOR'S
BEDIENUNGS
UTILISATION
LOS OPERADORES
OPERATIVO
GEBRUIKERS
BRUGERVEJLEDNING
BRUKER
OPERATORS
KÄYTTÄÄN**

OPERATOR'S

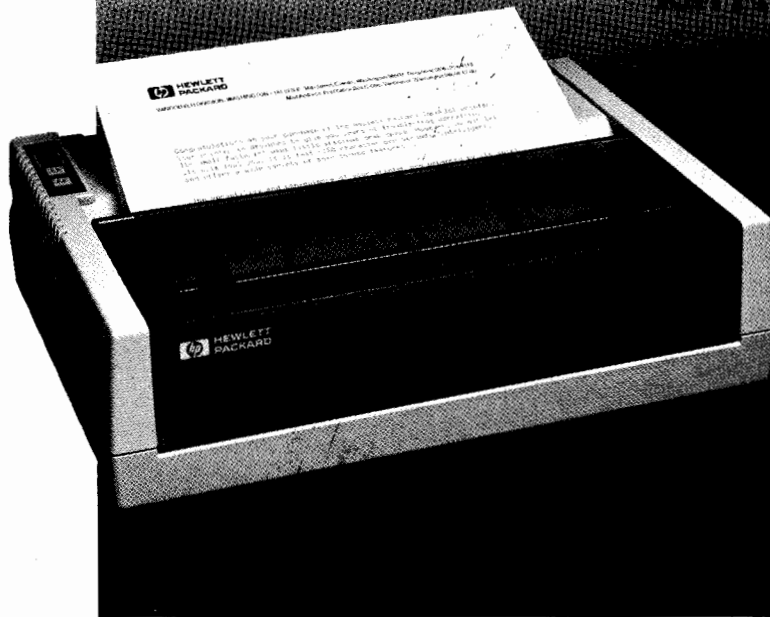

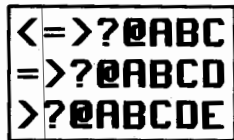
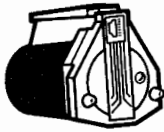
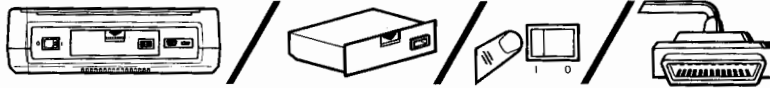
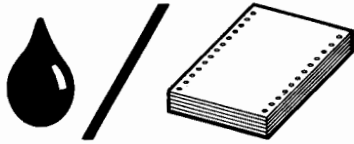



The ink in the print head cartridge contains diethylene glycol which is HARMFUL IF SWALLOWED. Keep new or used cartridges OUT OF THE REACH OF CHILDREN.

Die Tinte der Druckkopfpatrone enthält Diäthylen Glycol. EINNAHME IST SCHADLICH! Bewahren Sie deshalb die Druckkopfpatronen AUSSERHALB DER REICHWEITE VON KINDERN auf.

L'encre de la cartouche destinée à la tête d'impression contient du glycol-diéthylène dont L'ABSORPTION EST DANGEREUSE. Conservez les cartouches neuves ou usagées HORS DE LA PORTEE DES ENFANTS.

La tinta que va en el interior de la cabeza impresora contiene dietilenglicol, el cual puede ser dañino si es ingerido. Mantenga las cabezas nuevas o usadas fuera del alcance de los niños.

L'inchiostro nella cartuccia della testina di stampa contiene dietilen-glicole, una sostanza molto pericolosa se ingerita. Tenete le cartucce, nuove o usate, fuori dalla portata dei bambini.

De inkt in de inktpatroon bevat diethylene glycol, dat schadelijk is bij inwendig gebruik. NIEUWE OF GEBRUIKTE PATRONEN MOETEN BUITEN HET BEREIK VAN KINDEREN WORDEN GEHOUDEN.

Blækket i skrivehoved-beholderen indeholder diethylene glycol, hvilket er farligt at indtage. Opbevar brugte og ubrugte beholdere uden for børns rækkevidde.

Bläcket i skrivhuvudets behållare innehåller dietylen glykol som är farligt att förtära. Förvara dessa behållare utom räckhåll för barn.

Kirjoitinpääyksikön muste sisältää dietyleeni glykolia, joka on haitallista nautittuna. Pidä uudet tai käytetyt kirjoitinpääyksiköt POISSA LASTEN ULOTTUVILTA.

HP Computer Museum
www.hpmuseum.net

For research and education purposes only.

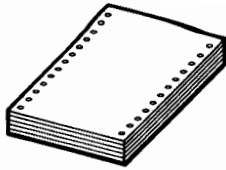

Use Hewlett-Packard ink jet paper for best print quality.

Benutzen Sie das ThinkJet-Papier von Hewlett-Packard, um eine hochwertige Druckqualität zu erreichen.

Pour obtenir une meilleure qualité d'impression, utilisez le papier spécial Hewlett-Packard pour imprimante à jet d'encre.

Use el papel especial de Hewlett-Packard para una mayor calidad de impresión.

Per una migliore qualità di stampa usate la carta speciale della Hewlett-Packard per la tinkjet.

Gebruik Hewlett-Packard ThinkJet papier voor het beste afdrukresultaat.

Anvend Hewlett-Packard ThinkJet papir for at opnå den bedste skrivekvalitet.

Bruk Hewlett-Packard's spesielle Thinkjet-papir for å oppnå best skrivekvalitet.

Hewlett-Packard speciella ThinkJet papper använd för bästa resultat vid utskrift.

Käytä Hewlett-Packard "THINKJET"-paperia parhaan kirjoituslaadun saavuttamiseksi.

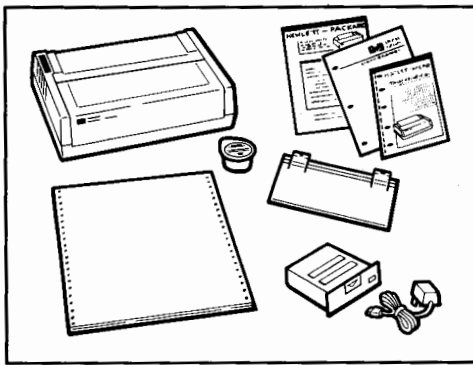
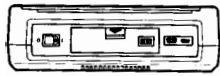

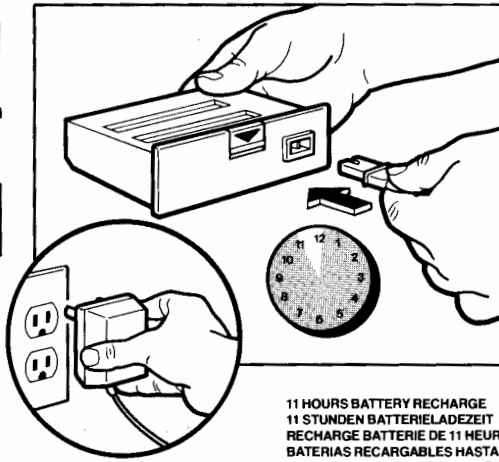
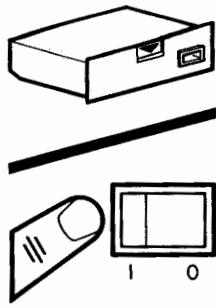

11 HOURS BATTERY RECHARGE
11 STUNDEN BATTERIELADEZEIT
RECHARGE BATTERIE DE 11 HEURES
BATERIAS RECARGABLES HASTA 11 HORAS
11 ORE DI RICARICA DELLA BATTERIA
11 UUR BATTERY LADEN
DET TATER 11 TIMER AT GENOPLADE BATTERIET
11 TIMER LADETID
11 TIMMARS LADDNINGSTID
11 TUNNIN PARISTOVAARUS

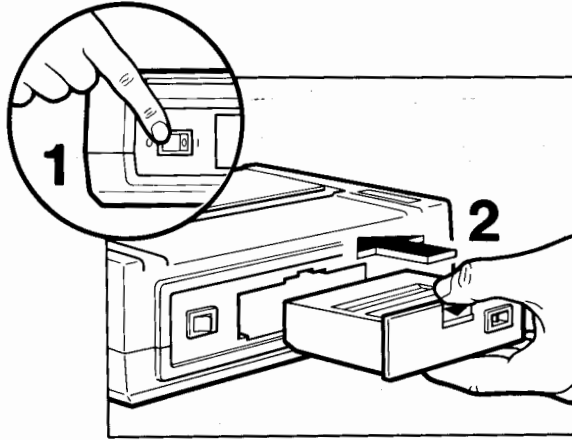

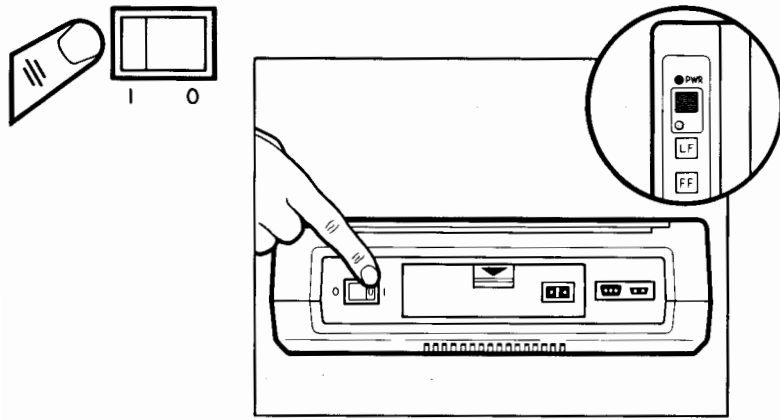

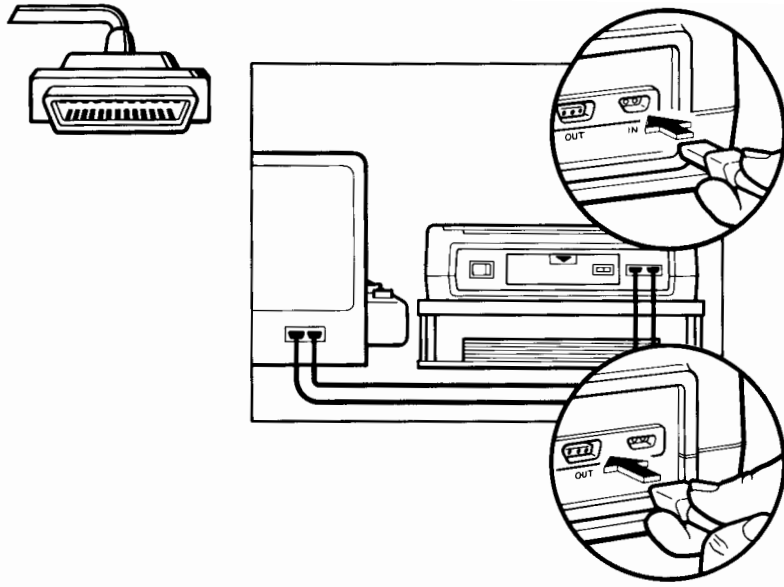

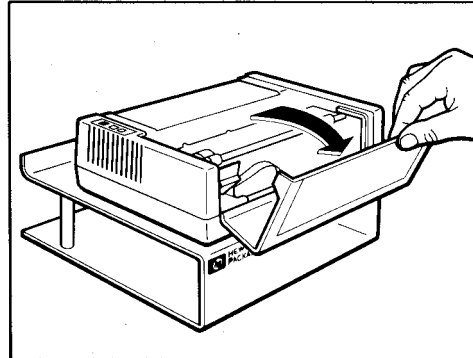
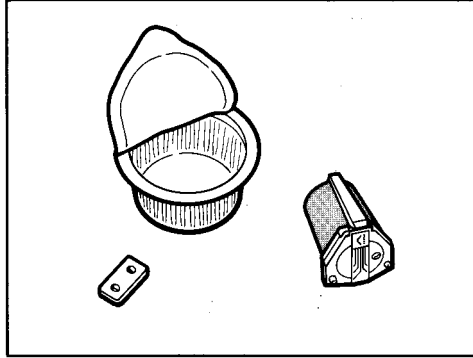
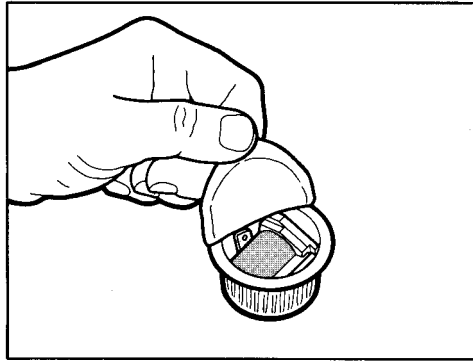
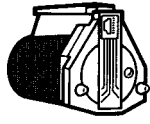

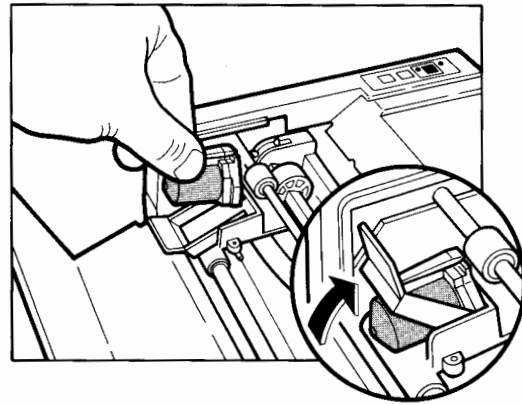
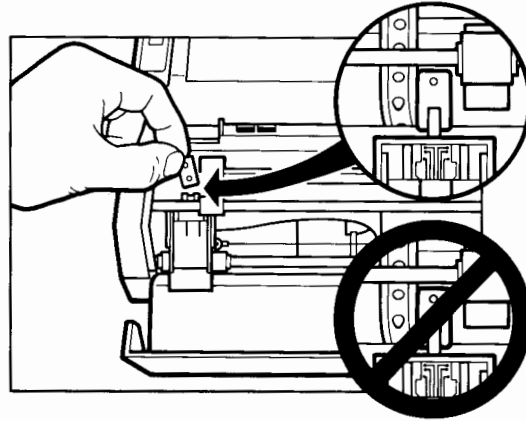
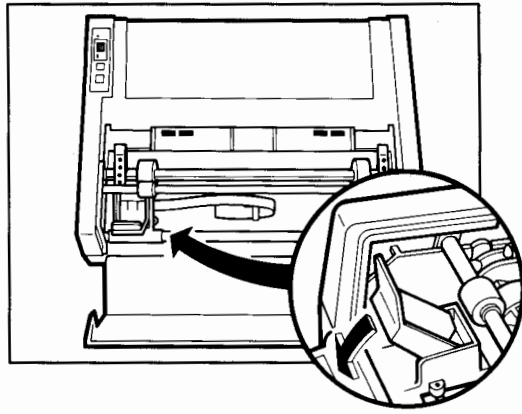
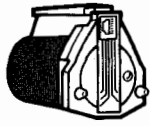

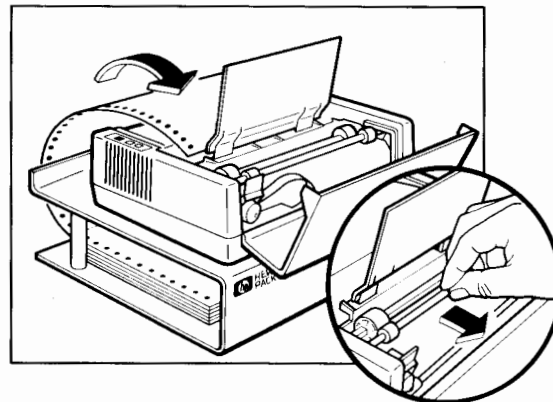
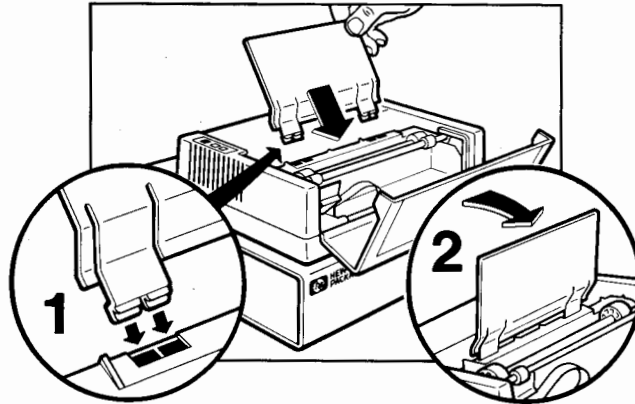
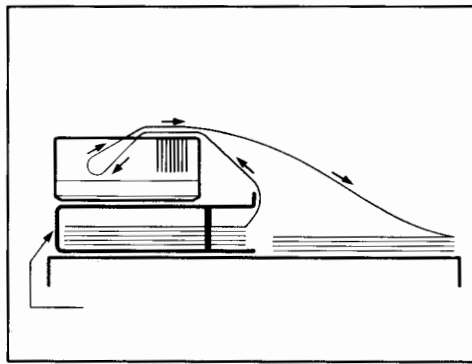
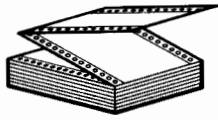

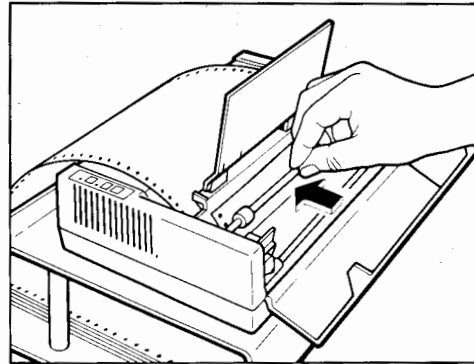
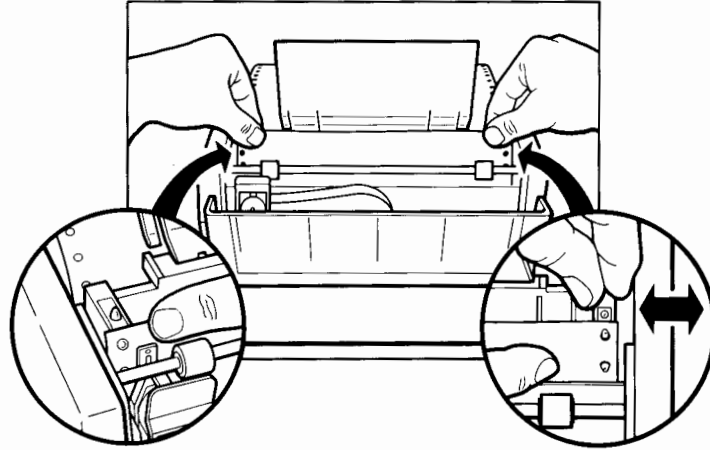
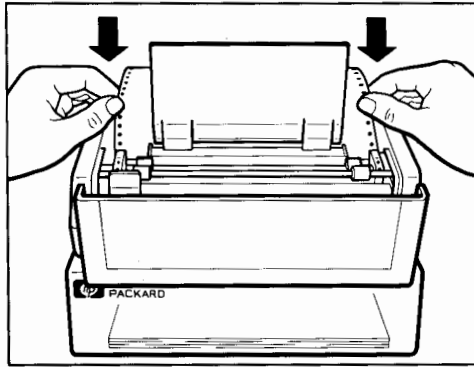
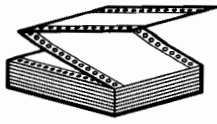

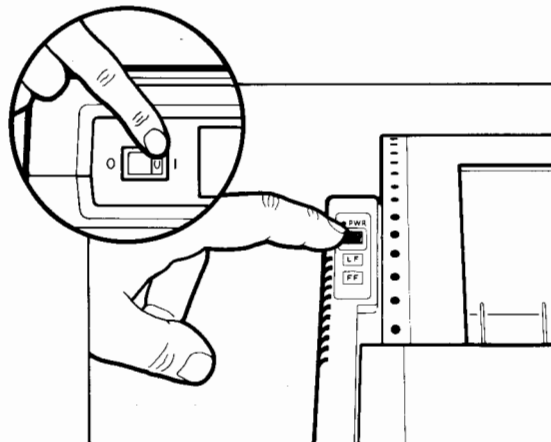
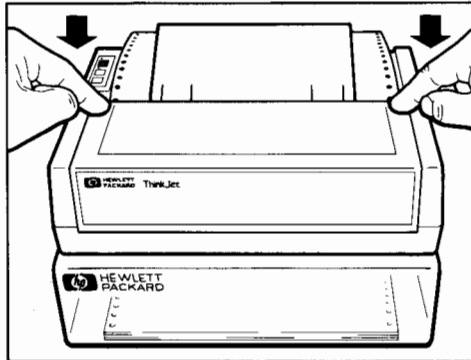
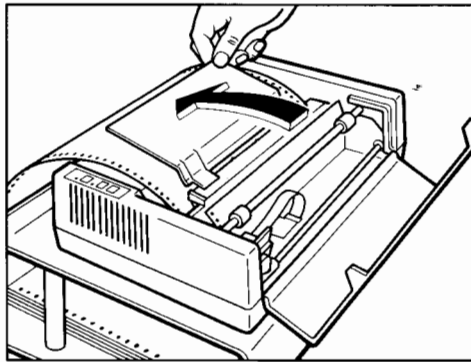
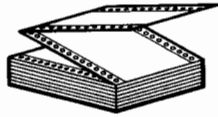

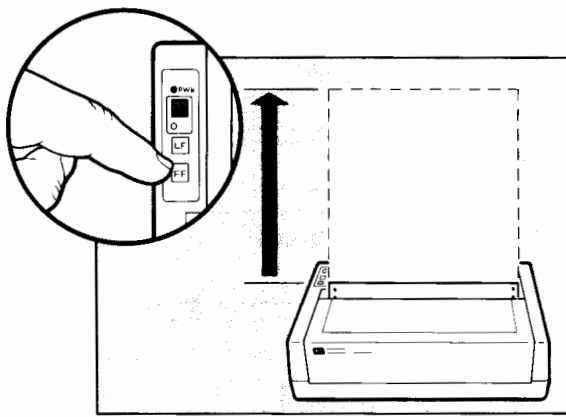
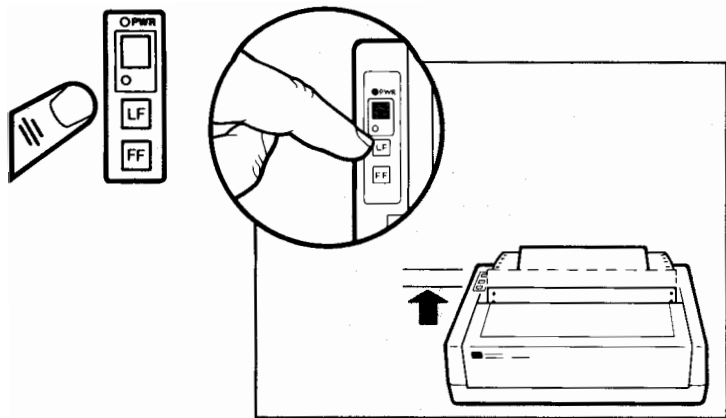



Top of form is set to the current line each time the printer is turned on or the blue button is pushed.

Seitenvorschub wird immer auf die aktuelle Zeile gesetzt, wenn der Drucker eingeschaltet oder der blaue Knopf gedrückt wird.

L'imprimante se positionne en HAUT DE PAGE sur la ligne en cours à chaque remise en marche, ou à chaque fois que vous pressez la touche bleue.

El límite superior del formato se fija en la línea en que se encuentra la cabeza cada vez que se enciende la impresora o se oprime el botón azul.

L'inizio della pagina e' fissato alla linea corrente ogni volta che la stampante viene accesa o il pulsante blu viene premuto.

De bladzijde bovenkant wordt ingesteld op de huidige lijn, waar de printkop staat, iedere keer wanneer de printer aangezet wordt of wanneer de blauwe knop wordt ingedrukt.

Skrivehovedet vil være i startposition (d.v.s. dem linje, hvor shrivehovedet er i position vil blive toppen of papiret) hver gang skriveren tændes eller hver gang der trykkes på den blå tast.

Når skriveren slås på eller den blå knappen trykkes inn, vil skriveren være innstilt i skriveposisjon.

Skrivhuvudets startpunkt ("Top Of Form") i förhållande till papperet bestäms när skrivaren slås på eller när den blå knappen trycks ned.

Sivun yläreuna asettuu aina sen hetkiselle riville, kun virta kytketään päälle tai kun painetaan sinistä painiketta.

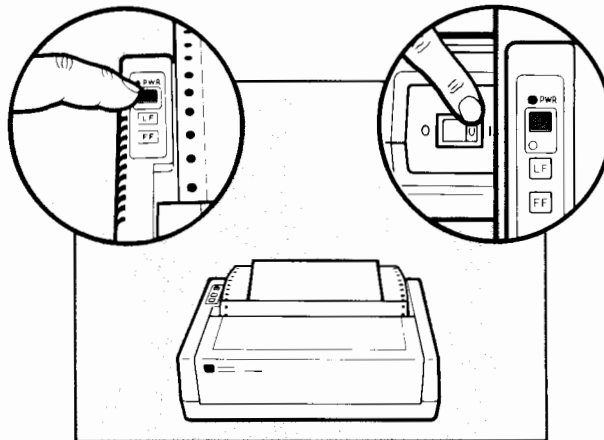

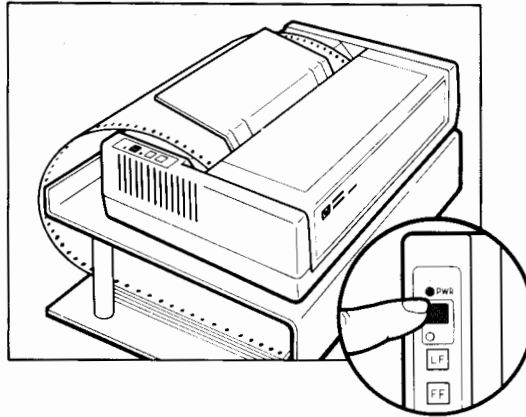
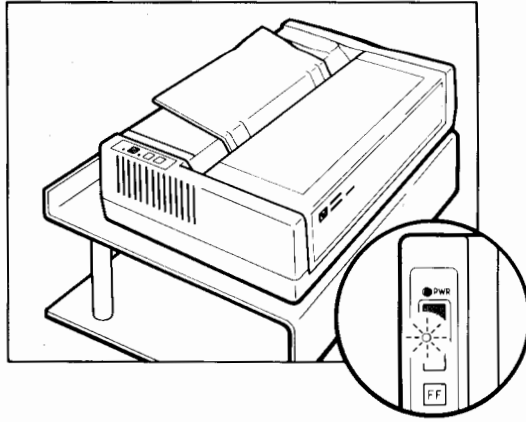

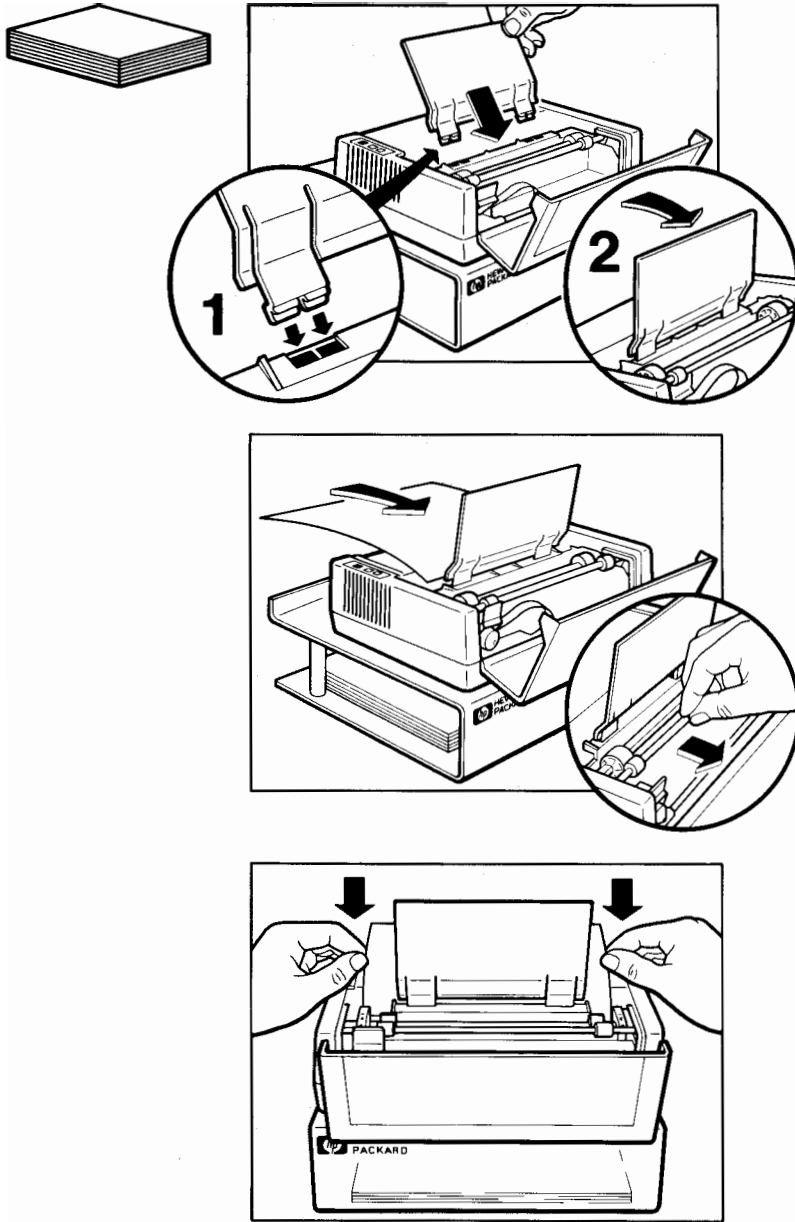

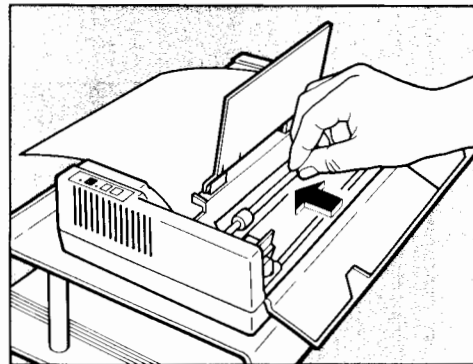
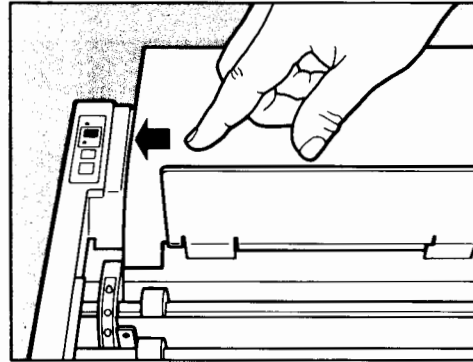
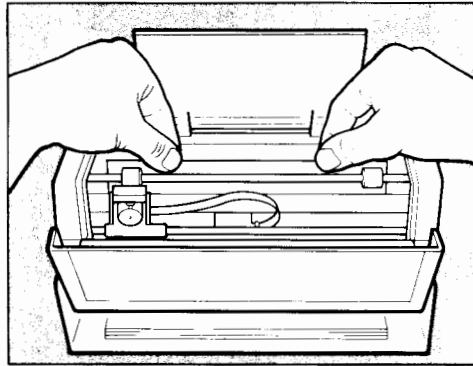
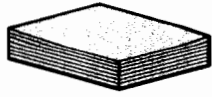

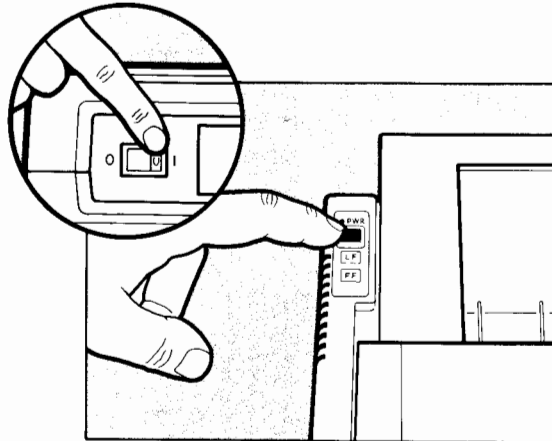
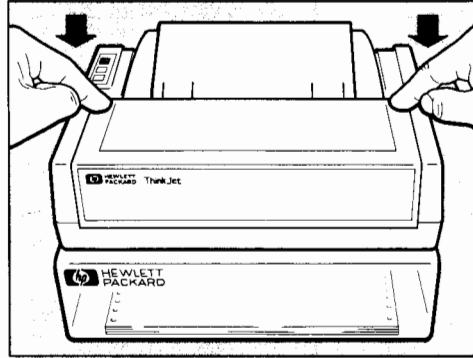
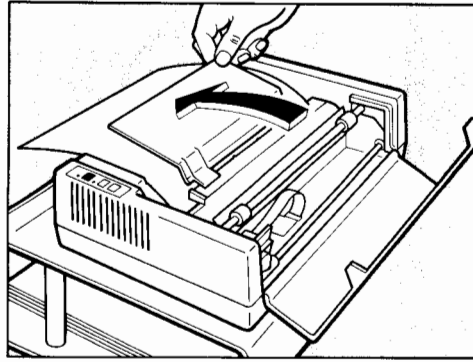
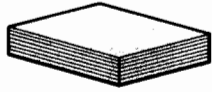



<=>?@ABC
 =>?@ABCD
 >?@ABCDE

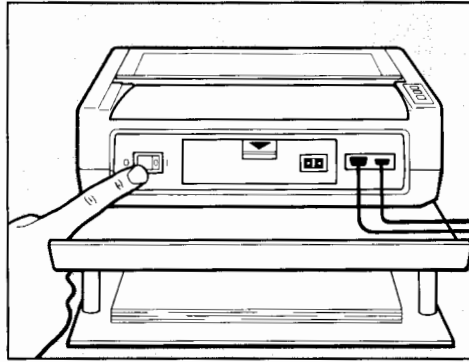

HOLD
 HALTEN
 MAINTENIR
 MANTENER OPRIMIDO
 TENERE PREMUTO
 HOUD VAST
 HOLD
 TRYKK
 HALL KNAPPEN NEDTRYCKT.
 PIDÄ PAINETTUNA

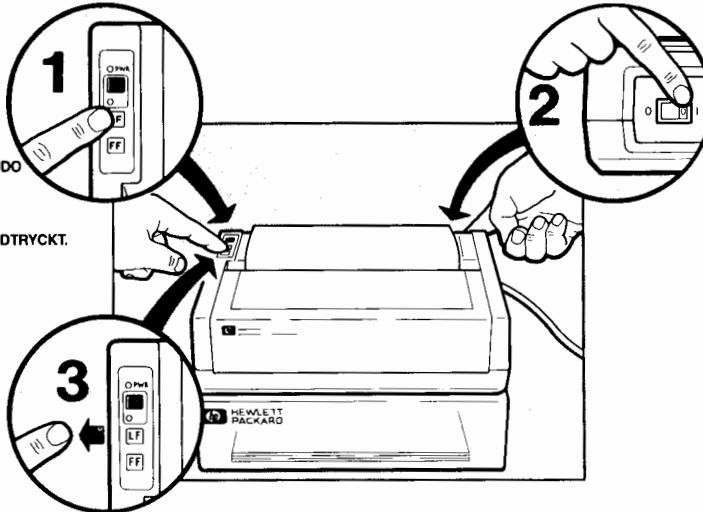

RELEASE
 LOSLASSEN
 RELÂCHER
 SOLTAR
 RILASCIARE
 LAAT LOS
 SLIP
 FRIGJØR
 SLÄPP KNAPPEN.
 VÄPAUTA

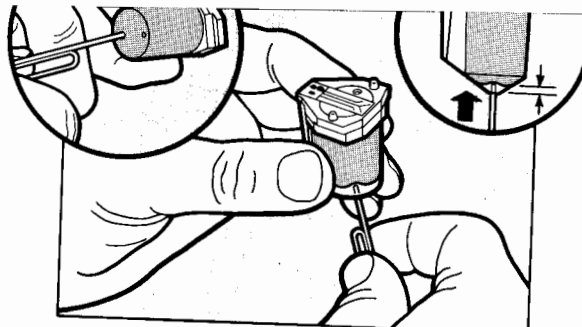
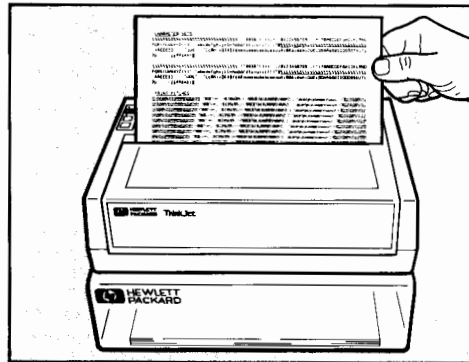

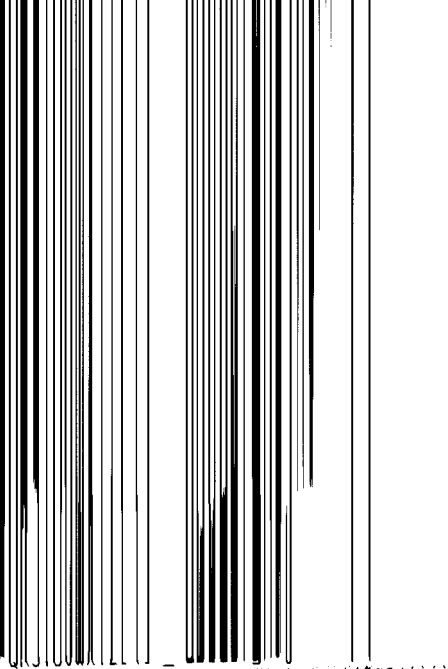
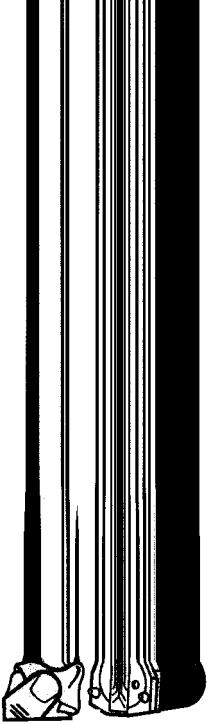

æeouæeouæeouæeouA10RäiøæA100E1B0AAæd110006S80ÿÿP
 123456789;(<=>?@ABCDEFGHIJKLMNPOQRSTUVWXYZ\|}~`^_` abj
 ÅĖĖĖii'-'-'-'U0Ė" "CçŃñlĹČŁ¥§7¢æeouæeouæeouæeouA10Rä
 -½¼¾κ=»½

PRINT PITCHES

```

0123456789;(<=>?@ABCDEFGHIJKLMNPOQRSTUVWXYZ[\]^_`^_` abj
æeouæeouæeouæeouA10RäiøæA100E1B0AAæd110006S80ÿÿP
123456789;(<=>?@ABCDEFGHIJKLMNPOQRSTUVWXYZ\|}~`^_` abj
ÅĖĖĖii'-'-'-'U0Ė" "CçŃñlĹČŁ¥§7¢æeouæeouæeouæeouA10Rä
-½¼¾κ=»½

```

æeouæeouæeouæeouA10RäiøæA100E1B0AAæd110006S80ÿÿP
 123456789;(<=>?@ABCDEFGHIJKLMNPOQRSTUVWXYZ\|}~`^_` abj
 ÅĖĖĖii'-'-'-'U0Ė" "CçŃñlĹČŁ¥§7¢æeouæeouæeouæeouA10Rä
 -½¼¾κ=»½

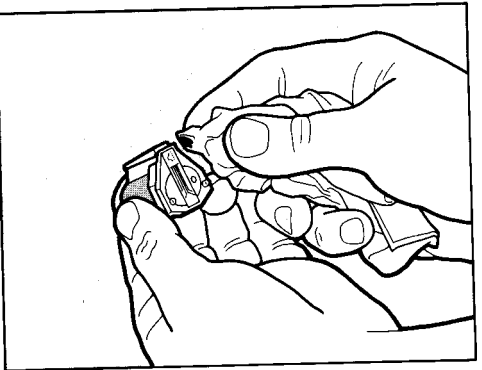

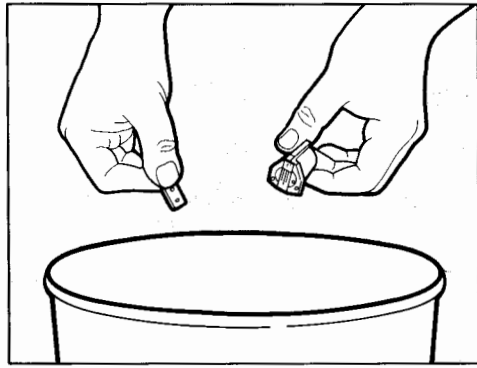
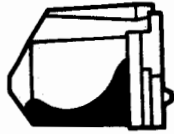

ThinkJet Printer

The Personal Printer from Hewlett-Packard

Reference Section

November 1984



Printed in Singapore

NOTICE

The information contained in this document is subject to change without notice.

HEWLETT-PACKARD MAKES NO WARRANTY OF ANY KIND WITH REGARD TO THIS MATERIAL, INCLUDING, BUT NOT LIMITED TO, THE IMPLIED WARRANTIES OF MERCHANTABILITY AND FITNESS FOR A PARTICULAR PURPOSE. Hewlett-Packard shall not be liable for errors contained herein or for incidental or consequential damages in connection with the furnishing, performance or use of this material.

Hewlett-Packard assumes no responsibility for the use or reliability of its software on equipment that is not furnished by Hewlett-Packard.

Table of Contents

GENERAL INFORMATION	
How to Use Your Reference Section	v
CHAPTER 1 USING PRINT FEATURES	1-1
Print Pitches	1-2
Bold Print	1-3
Underlining	1-3
Mixing Modes	1-3
Line Spacing	1-4
Perforation Skip	1-4
Page Length	1-5
Text Length	1-6
CHAPTER 2 MORE ON PRINT FEATURES	2-1
Control Features	2-1
Overstrike	2-2
Graphics	2-2
Selecting Unidirectional or Bidirectional Print	2-4
End of Line Wrap-Around	2-4
Linking Escape Sequences	2-5
Display Functions Mode	2-5
Self Test	2-6
Resets	2-6
Ready to Print	2-7
Automatic Line Termination	2-7
CHAPTER 3 MAINTENANCE AND TROUBLESHOOTING	3-1
Maintenance of the Battery Pack and Recharger	3-1
Power (Red) Light	3-1
Maintenance of the Print Head Cartridge	3-2
Maintenance of the Printer	3-4
Troubleshooting	3-4
APPENDICES	A-1
Appendix A: Table of Print Features	A-1
Appendix B: Reference Table of ASCII Characters	B-1
Appendix C: Using Your Printer with the HP-75	C-1
Appendix D: Using Your Printer with the HP-71	D-1
Appendix E: Using Your Printer with the HP-41	E-1

Appendix F: Using Your Printer with the HP110 Portable F-1
Appendix G: Using Your Printer with an HP Series 80 Computer .. G-1
Appendix H: Using Your Printer with an HP-IL/HP-IB Interface .. H-1
Appendix I: ThinkJet Printer Interface with HP-IL I-1
Appendix J: Alternate Controls Mode J-1
Appendix K: List of Accessories and Supplies K-1
Appendix L: Warranty and Service Information L-1
INDEX Index-1

General Information

Congratulations on your purchase of the Hewlett-Packard ThinkJet Printer. Your printer is designed to give you years of trouble-free operation. Its small size, lightweight design and battery operation allow the printer to be easily transported anywhere. However, do not let its small size fool you. It is fast (150 characters per second), intelligent and offers a wide variety of easy-to-use print features.

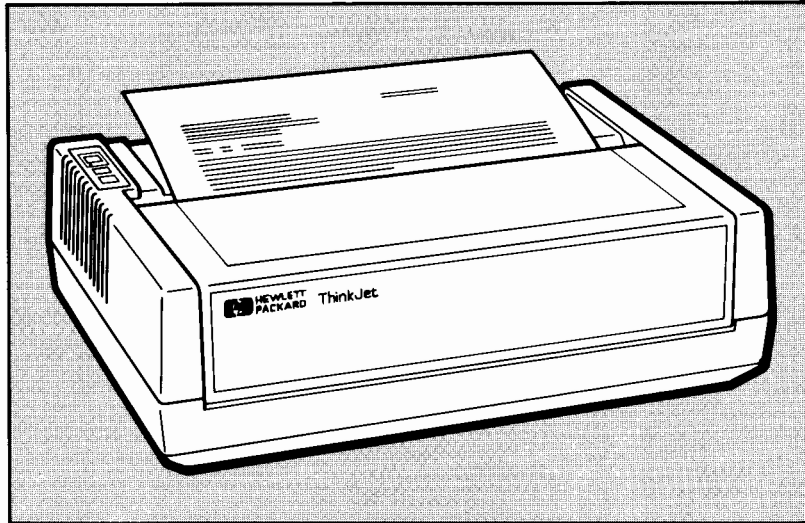

ThinkJet Printer

The versatility and convenience of your printer are enhanced by the quietness of its ink jet printing. The ink jet print head cartridge contains ink to print approximately 500 pages. The cartridge is completely disposable and easy to replace. In addition, the ThinkJet printer uses the Hewlett-Packard Interface Loop (HP-IL) to communicate with many HP computers and instruments.

How to Use Your Reference Section

Chapters 1 and 2, "Using Print Features" and "More on Print Features," describe how to use the many print features of the ThinkJet printer.

Chapter 3, "Maintenance and Troubleshooting," offers easy-to-use tips and recommendations on keeping your printer trouble-free.

The Appendices provide additional information to enable you to use your printer with selected Hewlett-Packard computers and peripherals. Also included in the Appendices are the List of Accessories, Warranty and Service Information, and reference tables for using print features.

Using Print Features

The Operator's Section told you how to set up and begin operating your ThinkJet printer. This chapter describes how to use the most commonly selected print modes and form control features: print pitches, bold mode, underlining, line spacing and perforation skip. Chapter 2 introduces less frequently used print features.

You may already have a software program which allows you to use many of the print features of your ThinkJet printer. If, however, you wish to use any of these print features on your own, the following two chapters provide you with examples of each of the print features and the procedures for generating those examples.

To generate printout using these print features, you will need to become familiar with the combination of computer keys used to enter the escape sequences and control codes that control the printer. The key or combination of keys required for escape [ESC] and control [CTL] are provided in Table 1-1 below or in your computer owner's manual.

NOTE

When reading this manual be very careful not to confuse O (uppercase oh) with 0 (zero) or l (lowercase ell) with 1 (one).

Table 1-1

[ESC] and [CTL] Keystrokes

Symbol	HP-75 Keystrokes
[ESC]	CTL BACK
[CTL]	CTL

The control codes and escape sequences are sent to the printer using a print command or can be included directly in data sent to the printer. The control codes and escape sequences transmitted are recognized by the printer but are not printed.

The procedures for using escape sequences and control codes on other Hewlett-Packard computers are included in the Appendices and your computer owner's manual. A complete listing of print features and their escape sequences or control codes is provided in Appendix A.

1-1

All characters then sent to the printer will be printed and underlined until the following escape sequence is sent: [ESC]&d@

To print the example of underline, enter the following:

```
PRINT "[ESC]&dD Entire lines can be underlined.[ESC]&d@"
```

```
PRINT "Underline can be used for a [ESC]&dSingle[ESC]&d@ word."
```

Mixing Modes

Print modes can be **mixed** on a single line.

To generate the preceding example, enter the following:

```
PRINT "Print modes can be [ESC]&k1Mixed[ESC]&k0S on a ";
```

```
PRINT "[ESC]&k2S[ESC]&dSingle[ESC]&d@[ESC]&k0S line."
```

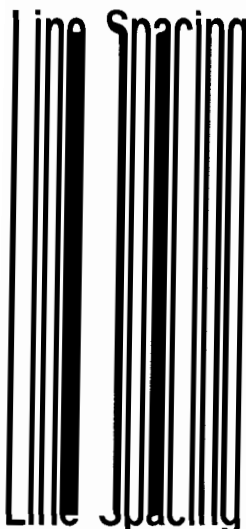

This group of line is printed at a line spacing of 8 lines per inch. Notice how they are close together. These lines are printed at a line spacing of 6 lines per inch.

The ThinkJet printer offers two different line spacings. The default line spacing is 6 lines/inch. To print at 8 lines/inch, use the following escape sequence: `[ESC]&l 8D`

To return to the default setting, use: `[ESC]&l 6D`

The preceding example can be generated by entering the following:

```
PRINT "[ESC]&l 8DThis group of lines is printed at a"
PRINT "line spacing of 8 lines per inch. Notice"
PRINT "how they are close together.[ESC]&l 6D"
PRINT "These lines are printed at a line"
PRINT "spacing of 6 lines per inch."
```

Perforation Skip

The perforation skip mode can be used to prevent text or graphics from being printed in the perforation area of fanfold paper. In this mode the printer prints text and graphics only in that area called the "text area," and then skips over that space known as the "perforation skip area." The text area and the perforation skip area together form the "logical page."

The preset length of the logical page is 66 lines (6 lines per inch for 11 inches), where the text area is 60 lines, and the perforation skip area is 6 lines. The length of the logical page and the text area can be changed using escape sequences, as described on pages 1-5 and 1-6. Changing the text length will change the perforation skip area. For example, if you want a 20 line perforation skip area, change the text length to 46 lines.

The following example is text area centered on a sheet with perforation skip mode enabled.

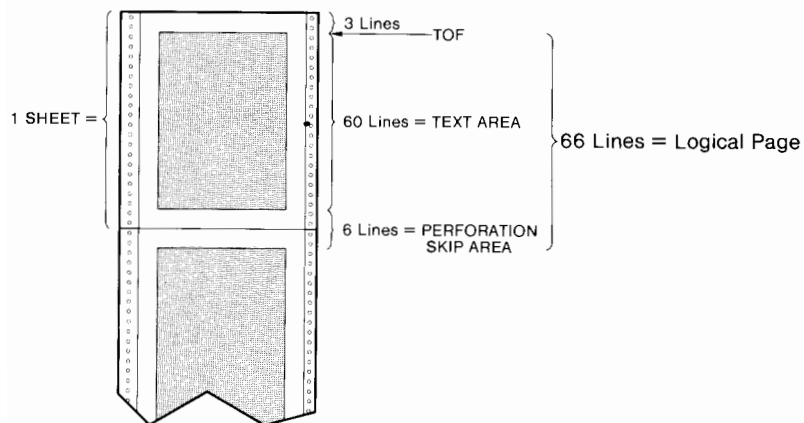

Figure 1-1 Text Area

Text is printed without regard to the actual position of the perforation. Top of form determines the exact position of the perforation skip area. If any part of a character in the current text line falls within the perforation skip area when perforation skip mode is enabled, then a form feed is executed before the line is printed.

To use the perforation skip mode, send the following escape sequence:

`[ESC]&l1L`

To return to the default setting of perforation skip mode disabled, send:

`[ESC]&l0L`

Page Length

Your ThinkJet printer allows you to set page length from 1 to 255 lines. To set page length, use `[ESC]&l#P` where # is the number of lines per page. For example, to set page length to 33 lines, use `[ESC]&l33P`.

Text Length

Text length can be changed using: `[ESC]&#F` where # is any number from zero up to the value selected for page length.

- Note that if page length is changed, then text length is automatically changed to one inch less than page length.
- If line spacing is changed, then text length and page length remain the same in inches.

More on Print Features

In the previous chapter we discussed the most frequently used print features. In this chapter we will discuss those print features which are less frequently used.

Control Features:

Your ThinkJet printer has control features which allow you to determine the position at which the next character received will be printed. This position is called the current active position. These control features are described below.

- Back Space (**[CTL] H**): Moves the current active position one character to the left. If the current active position is already the leftmost character position, no action is taken.
- Line Feed (**[CTL] J**): Moves the current active position to the same character position on the next line. An exception occurs when perforation skip is enabled and the current active position is on the last line of the text area. The current active position is then moved to the first line of the next logical page.
- Half Line Feed (**[ESC] =**): Identical to line feed, except that each half line feed causes a single paper advance equal to half the current line spacing. Half line feed is useful for printing subscripts and, when combined with backspace, for printing superscripts.

Enter the following:

```
PRINT "Ex[ESC] = sub"
```

Printer output:

```
Exsub
```

Enter the following:

```
PRINT " Y[ESC] = [CTL] H [CTL] H X"
```

NOTE: For the HP-75, **Shift I/R** must be pressed before each **[CTL] H**.

Printer output:

- Carriage Return (**[CTL]M**): Moves the current active position to the first character position on the current line.
- Form Feed (**[CTL]L**): Moves the current active position to the same character position on the first line of the next page.

Overstrike

There are two methods of overstriking text:

- Sending two lines of text separated only by a carriage return. The paper does not advance after the first line. This causes the printer to print the second line over the first line.
- Using back space. Each time the printer receives a back space command, the current active position is moved one to the left before printing the next character. For example, if two characters are sent to the printer separated only by a back space, then the second character is printed over the first.

Graphics

Many computer systems allow you to draw pictures on your computer screen using the computer's capabilities and a graphics software program. The computer handles the details of transferring the graphics data to the printer. You may, however, be interested in writing your own graphics software program. The information below provides the details of the ThinkJet graphics capabilities.

The ThinkJet printer is capable of printing in two modes, text mode and graphics mode. In text mode, the printer interprets each data byte it receives from the computer as an ASCII character. It then looks that character up in its internal character table and prints the dot pattern which it finds. In graphics mode, however, the data received from the computer directly specifies the dot pattern which is to be printed.

The ThinkJet printer uses a form of graphics called "raster graphics." In this system, the paper can be thought of as consisting of a grid of dot positions. The user can select one of two dot densities for this grid. The default dot density is 96 dots/inch in both the horizontal and vertical directions, and the print region is 640 dots wide. The alternate dot density is 192 dots/inch in the horizontal direction and 96 dots/inch in the vertical direction, and the print region is 1280 dots wide. Use the following escape sequence to select the graphics dot density:

region is 1280 dots wide. Use the following escape sequence to select the graphics dot density:

`[ESC] * r # S`

If the value field, #, is less than or equal to 640, the default dot density is used. If the value field is greater than 640, the higher dot density is used. Once the graphics resolution is specified, it stays in effect until explicitly changed.

Graphics data is sent to the printer one byte (8 bits) at a time. Each bit specifies one dot position. If a bit is zero, the corresponding dot position is left blank. If a bit is one, a dot is printed at the corresponding position. The first (most significant) bit of a graphics data byte specifies the leftmost dot; the last (least significant) bit specifies the rightmost dot. All of the data for a complete dot row must be sent as a group. The following escape sequence:

`[ESC] * b # W`

initiates the transfer of data for one dot row. The value field, #, specifies the number of graphics data bytes which follow the escape sequence. For example, if the printer receives `[ESC] * b 20 W`, it interprets the next 20 bytes of data as specifying 160 dots (20 x 8 bits) of the current dot row. If less data is sent for a dot row than will fit in the print region (640/8 = 80 bytes or 1280/8 = 160 bytes), the rightmost dots of the row are left blank. If more data is sent than will fit in the print region, the extra dots are ignored.

When the printer receives graphics data, it places that data in its storage buffer. Normally the graphics data is not actually printed until the buffer contains 12 dot rows of graphics in normal resolution or 6 dot rows in higher resolution.

Paper advance automatically occurs after graphics data is printed. Therefore, it is not necessary to send any explicit paper advance controls.

Some computers automatically add carriage returns, line feeds, and blanks to the data being sent to the printer. These characters are necessary when printing text. In graphics mode, however, they may be interpreted as graphics data and give unexpected results. Before writing programs which generate graphics, you should consult the manual for your computer to determine how to prevent your computer from sending these extra characters to the printer.

If the printer has a partial line of text data in its storage buffer and it receives the raster dot row escape sequence, it terminates the line of text with a carriage return (but no line feed), prints it, and then accepts the graphics data. This may cause the graphics data to be printed over the text data. To avoid printing graphics over text data, use the following escape sequence before sending any graphics:

`[ESC] * r A`



This escape sequence causes any partial lines of text to be terminated with a carriage return and line feed. If there is no text in the buffer, this escape sequence has no effect.

After all of the graphics data has been sent to the printer, you should send the escape sequence to terminate raster graphics. This escape sequence is:

`[ESC] * r B`

If graphics data is still stored in the printer, the escape sequence to terminate raster graphics causes it to be printed. The following is an example of a program creating graphics using the HP-75:

Enter	Description
10 PWIDTH INF	The HP-75 must not send CR,LF
20 PRINT CHR\$(27)&" *r640S";	Select default graphics density
30 PRINT CHR\$(27)&" *rA";	Begin raster graphics
40 FOR I=1 TO 55	55 dot rows will be sent
50 PRINT CHR\$(27)&" *b5W";	Initiate a dot row of length 5 bytes (40 dots)
60 FOR J=1 TO 5	
70 PRINT CHR\$(136);	Send 1 byte of graphics data * note: 136 decimal = 10001000 binary
80 NEXT J	
90 NEXT I	
100 PRINT CHR\$(27)&" *rB";	Terminate raster graphics

Printer output:



Selecting Unidirectional or Bidirectional Print

The ThinkJet printer normally prints text bidirectionally. To disable bidirectional text printing, use the following escape sequence: `[ESC] & k 0 W`

To return to bidirectional text printing, use: `[ESC] & k 1 W`

NOTE: The ThinkJet printer automatically prints graphics unidirectionally.

End of Line Wrap-Around

In normal operation, characters which exceed the line length of the current print pitch are not printed. When wrap-around mode is used, the first character sent which exceeds the specified line length causes a carriage

return/line feed to be executed before the character is printed. This causes long lines to be broken and printed in several lines. To use the wrap-around mode, send the following escape sequence: `[ESC]& s 0 C`
 To return to the default mode, which is wrap-around disabled, use:
`[ESC]& s 1 C`

Linking Escape Sequences

You can link several escape sequences into one escape sequence string. For example, you can use perforation skip mode and vertical line spacing of 8 lines/inch by entering either:

`[ESC]& l 8 D` and `[ESC]& l 1 L`
 or
`[ESC]& l 8 d 1 L`

There are three important rules to remember in linking escape sequences:

- The first two characters after the `[ESC]` character must be the same. In the example above these are `&` and `l`. The escape character and the first two characters following it are used only once in a string of linked escape sequences.
- The final character of the internal escape sequences must be lower case. In the example above, `D` becomes `d`.
- The escape sequences will be performed in the order in which they are sent to the printer.

Display Functions Mode

Control characters and escape sequences are not normally printed. However, the display functions mode allows you to print control characters and escape sequences that are sent to the printer without executing them. The only exceptions are the following:

- Carriage return control code, which is printed and then executed as a carriage return and line feed.
- `[ESC]Z`, which is printed and then executed.

In **Display Functions mode**, escape sequences and control codes are not **executed**, they are printed.

¶

¶ In ¶Display Functions mode¶, escape sequences and¶
 ¶control codes are not ¶&&k3Sexecuted&&k0S, they are printed.¶
 ¶¶Z

To enable display functions mode, enter:

`[ESC]Y`

To disable display functions mode (default), use:

`[ESC]Z`

To generate the preceding example, enter the following:

```
PRINT "In [CTL]N Display Functions mode[CTL]O, control codes"  
PRINT "are printed, [ESC] &dDnot[ESC] &d@ executed."  
PRINT "[ESC]Y"  
PRINT "In [CTL]N Display Functions mode[CTL]O, control codes"  
PRINT "are printed, [ESC] &dDnot[ESC] &d@ executed."  
PRINT "[ESC]Z"
```

Self Test

Your ThinkJet printer can perform a self test to ensure that it is properly operating. To perform self test use:

`[ESC] z`

The printer then performs a test of the electronics and prints one page of characters.

Resets

There are three different methods for returning your printer to its preset (default) print features. These are as follows:

- Simply turn the printer "off" and then "on." All print features return to their default settings and top of form is set to the current line.
- Enter the escape sequence:

`[ESC] E`

This causes the printer to print whatever data is in the print buffer, set all changeable features to their default settings, and, if the paper is not at the top of form, execute a form feed.

- Send a device clear frame (DCL) to the printer. (See Appendix G, "ThinkJet Printer Interface with HP-IL.") This reset causes the printer to stop printing (immediately), clear all remaining data in the print buffer, set all changeable features to their default setting, and execute a form feed if the paper is not at the top of the form.

In addition if the print head carriage jams or is moved manually while the printer is on, the printer will stop printing. In this event, the print buffer is

emptied, all print features return to their default settings, and the attention light begins blinking.

Ready to Print

The ThinkJet printer is now prepared for printing. The ThinkJet has a 1" fixed margin on the left and gives the convenience of a 1" margin on the right. This gives a fixed printing area of 6.7 inches, which can accommodate 80 characters in normal print mode. You can increase the margins (i.e., wider) by setting them on your computer. The printer is also pre-set to the following (default) printing specifications:

- 12 characters/inch
- 80 characters/line
- 6 lines/inch
- 66 lines/page

Automatic Line Termination

Most HP computers terminate lines with a carriage return and a line feed. However, there are computers which terminate with either a carriage return or a line feed. In order for your printer to operate normally with these systems, you will need to use one of the following escape sequences.

Table 2-1
Automatic Line Termination Escape Sequences

Character* received by printer	Character executed by printer	Escape Sequence
CR LF FF	CR LF FF } (default)	<code>[ESC]&k0G</code>
CR LF FF	CR, LF LF FF	<code>[ESC]&k1G</code>
CR LF FF	CR CR, LF CR, FF	<code>[ESC]&k2G</code>
CR LF FF	CR, LF CR, LF CR, FF	<code>[ESC]&k3G</code>

*NOTE: CR = Carriage Return
 LF = Line Feed
 FF = Form Feed

Maintenance and Troubleshooting

Your ThinkJet printer is designed for durability and portability. This chapter provides a few basic instructions on care and some simple troubleshooting instructions for printer malfunctions.

Your printer should be maintained and operated under the following environmental conditions:

- Operate only at temperatures between 50°F to 104°F (10°C and 40°C)
- Recharge only at temperatures between 50°F to 104°F (10°C and 40°C)
- Store at temperatures from –4°F to 140°F (–20°C to 60°C)
- Operate in relative humidity between 10% and 90%

Maintenance of the Battery Pack and Recharger

Under normal operating conditions, a fully charged battery pack is capable of the following:

- Continuous printing without recharger: over one and a half hours, or approximately 200 pages
- Storage: several weeks without recharging
- Not printing with power left on: five days

To maximize battery pack life, recharge the battery pack only when it is nearly discharged, as indicated by the printer power light. Approximately eleven hours is required to recharge a battery pack fully. The battery pack may be charged in or out of the printer.

NOTE

The battery pack is **not** user serviceable.

Do not incinerate or mutilate the battery pack. The battery pack may release toxic materials or burst under extreme heat. Do not connect together or otherwise short circuit the battery pack terminals. The battery pack may melt or cause serious burns.

Use only HP battery packs with your printer. Use only HP rechargers with your battery pack.

Power (Red) Light

The red power light, located on the control panel, indicates the status of the printer's power source.

- The power light “on” indicates that power is available to operate the printer.
- A blinking power light indicates the battery pack should be recharged. During printing in this condition the power light is “off.” When printing is completed, the power light will begin blinking again.

Maintenance of the Print Head Cartridge

The print head cartridge is durable, disposable, and easy to maintain. Observing a few simple rules of care should keep your print head trouble-free.

- Avoid touching the print head face with your fingers.
- Periodically check the ink level of the print head cartridge. Hold the print head up and view the bladder inside. If the bladder is collapsed, then the ink supply is nearly depleted and the cartridge needs to be replaced.
- If the printer has not been used for a prolonged period, or if dust has accumulated on the print head face, you may need to gently wipe the face of the print head with a tissue to maintain best print quality. If print quality problems remain, see Table 3-1.

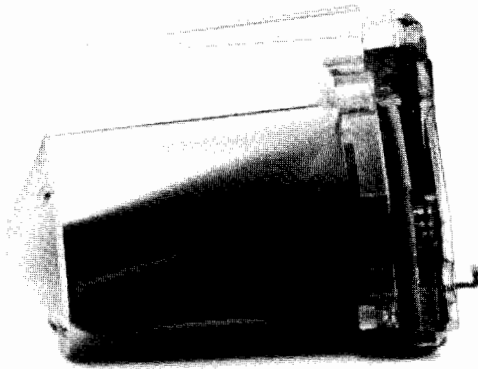
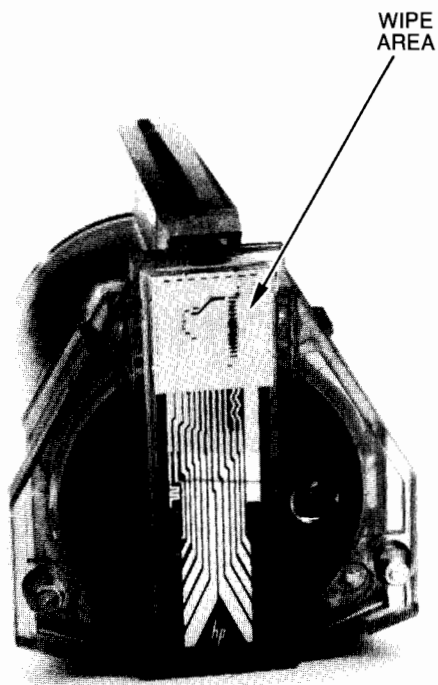

Figure 3-1 Empty Cartridge



- Avoid allowing the print head face to come into prolonged contact with other materials. This may cause the ink to wick out of the print head.
- Use the print head cartridge prior to the month and year of expiration printed on the package.

WARNING

The ink in the print head cartridge contains diethylene glycol which is HARMFUL IF SWALLOWED. Keep new or used cartridges OUT OF REACH OF CHILDREN.

Maintenance of the Printer

Ideally your printer should be stored and operated in a clean, dust-free environment. However, it can endure some rugged use.

- To remove dirt and smudges, use a mild solution of dishwashing detergent and water. Never use harsh chemicals to clean the printer.

Troubleshooting

Provided below is a list of the possible error conditions which may exist due to printer malfunction. In most instances, performing the corrective action described will eliminate the problem. If the problem persists, however, the printer should be returned for repair.

Table 3-1
Error Conditions

Error Condition	Correction Action
1. Red power light "off" or flashing.	<ul style="list-style-type: none"> • Ensure that the battery pack is installed correctly and the power switch is turned on. • If the power light remains "off," the battery pack should be recharged. • If the power light is blinking, the battery pack should be recharged.
2. Yellow attention light "on" continuously.	<ul style="list-style-type: none"> • Load paper into the printer. The attention light will begin blinking.
3. Yellow attention light blinking.	<ul style="list-style-type: none"> • Press the blue button. The print head carriage will move and the attention light will turn off. • Remove any obstruction from around the print head carriage and push the blue button again. • If the attention light continues blinking, the printer is signaling an error condition and should be returned for repair.

<p>4. Printer does not respond to computer.</p>	<ul style="list-style-type: none"> • Make sure that the power light is "on" or blinking and the attention light is "off." If this is not the case, refer to Error Conditions 1 through 3 above. • Verify that the printer is operational by running the self test as described in Operator's Section (Self Test). • Verify that the HP-IL cables are properly connected. Then repeat the procedure for assigning the printer as your system's print device. This procedure is explained for several different HP systems in the Appendices to this manual. You may also need to refer to the owner's manual for your computer. • Your computer may not be sending the printer a carriage return and line feed at the end of each line. In this case the printer will continue storing data because it never recognizes the end of the line. Refer to Automatic Line Termination on page 2-7 and your computer owner's manual for the reset procedures.
<p>5. Paper does not feed properly.</p>	<ul style="list-style-type: none"> • Remove the paper from the printer and discard any that is crumpled. • If you are using fanfold paper, verify that it can travel freely without catching, and that the right side pinwheel is adjusted correctly for the width of your paper. • Reload the paper following the instructions found in Operator's Section (Loading Think-Jet Paper).

<p>6. Print quality is poor.</p>	<ul style="list-style-type: none"> • If your print head stops printing after a few lines, it was probably jarred in shipment and needs to be activated. See Operator's Section (Maintenance). • Check that there is sufficient ink in the cartridge by viewing the bladder. If the bladder is collapsed, replace the cartridge. See Operator's Section (Maintenance). • Check that the paper used is an ink jet paper. • Gently wipe the face of the print head using a tissue to remove any accumulated dust. See Operator's Section (Maintenance). If the print head cartridge has not been used for a prolonged period, moisten the tissue with water before wiping.
<p>7. Dot rows are missing.</p>	<ul style="list-style-type: none"> • Gently wipe the face of the print head using a tissue to remove any accumulated dust. See Operator's Section (Maintenance). If the print head cartridge has not been used for a prolonged period, moisten the tissue with water before wiping. • Lightly wipe the electrical connector of the print head carriage using a cotton swab dipped in alcohol. • If the problem continues, replace the print head cartridge.
<p>8. Carriage moves but printer does not print.</p>	<ul style="list-style-type: none"> • Check that there is sufficient ink in the cartridge by viewing the bladder. If the bladder is collapsed, replace the cartridge. See Operator's Section (Maintenance). • Gently wipe the face of the print head using a tissue to remove any accumulated dust. See Operator's Section (Maintenance). If the print head cartridge has not been used for a prolonged period, moisten the tissue with water before wiping. • Lightly wipe the electrical connector of the print head carriage using a cotton swab dipped in alcohol. • If the problem continues, replace the print head cartridge.

Table of Print Features

Print Feature Description	Escape/Control Code	ASCII Decimal Equivalents
PRINT PITCHES		
Normal (default): 12 cpi, 80 cpl	<code>ESC & k 0 S</code>	27, 38, 107, 48, 83
Expanded: 6 cpi, 40 cpl	<code>ESC & k 1 S</code>	27, 38, 107, 49, 83
Compressed: 21.3 cpi, 142 cpl	<code>ESC & k 2 S</code>	27, 38, 107, 50, 83
Expanded-Compressed: 10.7 cpi, 71 cpl	<code>ESC & k 3 S</code>	27, 38, 107, 51, 83
BOLD MODE		
Bold print	<code>ESC (s1B</code>	27, 40, 115, 49, 66
Normal print (default)	<code>ESC (s0B</code>	27, 40, 115, 48, 66
UNDERLINE		
Underline	<code>ESC & d D</code>	27, 38, 100, 68
Normal (default)	<code>ESC & d @</code>	27, 38, 100, 64
LINE SPACING		
6 lines/inch (default)	<code>ESC & l 6 D</code>	27, 38, 108, 54, 68
To print at 8 lines/inch	<code>ESC & l 8 D</code>	27, 38, 108, 56, 68
PERFORATION SKIP		
Off (default)	<code>ESC & l 0 L</code>	27, 38, 108, 48, 76
On	<code>ESC & l 1 L</code>	27, 38, 108, 49, 76
PAGE LENGTH		
Set page length (given in lines) where # is any number from 0 up to and including 255*	<code>ESC & l # P</code>	27, 38, 108, #, ..#, 80
TEXT LENGTH		
Set text length (given in lines) where # is any number from 0 up to and including the value selected for page length*	<code>ESC & l # F</code>	27, 38, 108, #, ..#, 70
END OF LINE WRAP-AROUND		
Wrap-around	<code>ESC & s 0 C</code>	27, 38, 115, 48, 67
Without wrap-around (default)	<code>ESC & s 1 C</code>	27, 38, 115, 49, 67
DISPLAY FUNCTIONS MODE		
Display functions	<code>ESC Y</code>	27, 89
Normal (default)	<code>ESC Z</code>	27, 90
SELECTING UNIDIRECTIONAL OR BIDIRECTIONAL TEXT PRINTING		
Unidirectional text printing	<code>ESC & k 0 W</code>	27, 38, 107, 48, 87
Bidirectional printing (default)	<code>ESC & k 1 W</code>	27, 38, 107, 49, 87

*If you are using the decimal representation of an escape sequence, you must look up each digit of the value field (#) in the ASCII table. For example, the decimal representation of `ESC & l 40 P` is 27, 38, 108, 52, 48, 80.

Reference Table of ASCII Characters

Each character that your printer is capable of printing is assigned a numerical equivalent. The complete list of 256 characters follows. This list of characters is comprised of two parts, identified below:

1. Control Codes, identified as characters 0-31 (␣ through ␣) 127 (␣), characters 128-159 (␣ through ␣), and 255 (␣). These codes are not printed except in display functions mode. Only control codes 8, 10, 12, 13, 14, 15 and 27 are executed. All others are ignored.
2. Printed Characters, which consist of the following two types:
 - a. Standard U.S. ASCII, identified as characters 32-126 (space through ~)
 - b. Roman Extension (international), identified as characters 160-254 (space through ±)

Table B-1
Roman-8 Characters (ASCII)

CHAR.	DEC.	HEX.
ctrl@	N _U	0 00
ctrlA	S _H	1 01
ctrlB	S _X	2 02
ctrlC	E _X	3 03
ctrlD	E _T	4 04
ctrlE	E _Q	5 05
ctrlF	A _X	6 06
ctrlG	Q	7 07
ctrlH	B _S	8 08
ctrlI	H _T	9 09
ctrlJ	L _T	10 0A
ctrlK	V _T	11 0B
ctrlL	F _F	12 0C
ctrlM	C _R	13 0D
ctrlN	S _D	14 0E
ctrlO	S _T	15 0F
ctrlP	D _L	16 10
ctrlQ	D _I	17 11
ctrlR	D ₂	18 12
ctrlS	D ₃	19 13
ctrlT	D ₄	20 14
ctrlU	N _K	21 15
ctrlV	S _Y	22 16
ctrlW	E _B	23 17
ctrlX	C _N	24 18
ctrlY	E _M	25 19
ctrlZ	S _B	26 1A
ctrl[E _C	27 1B
ctrl\	E _S	28 1C
ctrl]	G _S	29 1D
ctrl^	R _S	30 1E
ctrl_	U _S	31 1F

CHAR.	DEC.	HEX.
	32	20
!	33	21
"	34	22
#	35	23
\$	36	24
%	37	25
&	38	26
'	39	27
(40	28
)	41	29
*	42	2A
+	43	2B
,	44	2C
-	45	2D
.	46	2E
/	47	2F
0	48	30
1	49	31
2	50	32
3	51	33
4	52	34
5	53	35
6	54	36
7	55	37
8	56	38
9	57	39
:	58	3A
;	59	3B
<	60	3C
=	61	3D
>	62	3E
?	63	3F

CHAR.	DEC.	HEX.
a	64	40
A	65	41
B	66	42
C	67	43
D	68	44
E	69	45
F	70	46
G	71	47
H	72	48
I	73	49
J	74	4A
K	75	4B
L	76	4C
M	77	4D
N	78	4E
O	79	4F
P	80	50
Q	81	51
R	82	52
S	83	53
T	84	54
U	85	55
V	86	56
W	87	57
X	88	58
Y	89	59
Z	90	5A
[91	5B
\	92	5C
]	93	5D
^	94	5E
_	95	5F

CHAR.	DEC.	HEX.
`	96	60
a	97	61
b	98	62
c	99	63
d	100	64
e	101	65
f	102	66
g	103	67
h	104	68
i	105	69
j	106	6A
k	107	6B
l	108	6C
m	109	6D
n	110	6E
o	111	6F
p	112	70
q	113	71
r	114	72
s	115	73
t	116	74
u	117	75
v	118	76
w	119	77
x	120	78
y	121	79
z	122	7A
{	123	7B
	124	7C
}	125	7D
~	126	7E
■	127	7F

NOTE: Character Dec. 0-31, 127-159 and 255 are only printed when display functions are enabled.

Table B-2
Roman-8 Characters (Roman Extension)

CHAR.	DEC.	HEX.
N _U	128	80
S _H	129	81
S _X	130	82
E _X	131	83
E _T	132	84
E _D	133	85
A _X	134	86
Q	135	87
B _S	136	88
H _T	137	89
L _F	138	8A
V _T	139	8B
F _F	140	8C
C _B	141	8D
S _D	142	8E
S _I	143	8F
D ₁	144	90
D ₁	145	91
D ₂	146	92
D ₃	147	93
O _A	148	94
N _X	149	95
S _Y	150	96
E _B	151	97
C _M	152	98
L _M	153	99
S _B	154	9A
E _C	155	9B
F _S	156	9C
G _S	157	9D
R _S	158	9E
U _S	159	9F

CHAR.	DEC.	HEX.
	160	A0
À	161	A1
Á	162	A2
Ê	163	A3
Ë	164	A4
É	165	A5
Ï	166	A6
Ì	167	A7
	168	A8
	169	A9
	170	AA
	171	AB
˘	172	AC
Û	173	AD
Ü	174	AE
£	175	AF
—	176	B0
	177	B1
	178	B2
°	179	B3
Ç	180	B4
ç	181	B5
Ñ	182	B6
ñ	183	B7
ı	184	B8
ı	185	B9
ı	186	BA
£	187	BB
¥	188	BC
§	189	BD
f	190	BE
ç	191	BF

CHAR.	DEC.	HEX.
â	192	C0
ê	193	C1
ô	194	C2
û	195	C3
à	196	C4
é	197	C5
ó	198	C6
ü	199	C7
à	200	C8
è	201	C9
ò	202	CA
ù	203	CB
ä	204	CC
ë	205	CD
ö	206	CE
ü	207	CF
À	208	D0
ı	209	D1
Ø	210	O2
Æ	211	D3
á	212	D4
í	213	D5
ø	214	D6
æ	215	D7
À	216	D8
ı	217	D9
Ö	218	DA
Ü	219	DB
Ë	220	DC
ı	221	DD
ß	222	DE
Ô	223	DF

CHAR.	DEC.	HEX.
Á	224	E0
À	225	E1
à	226	E2
ð	227	E3
đ	228	E4
ı	229	E5
ı	230	E6
Ó	231	E7
Ò	232	E8
Ô	233	E9
ó	234	EA
Š	235	EB
š	236	EC
Ú	237	E0
ÿ	238	EE
ÿ	239	EF
ƒ	240	F0
ƒ	241	F1
	242	F2
	243	F3
	244	F4
	245	F5
—	246	F6
¼	247	F7
½	248	F8
¾	249	F9
º	250	FA
«	251	FB
■	252	FC
»	253	FD
±	254	FE
■	255	FF



Using Your Printer with the HP-75

To use your ThinkJet printer with an HP-75 computer, connect the HP-IL cables as described in Chapter 1 and turn on the printer. Then turn on your HP-75 and enter:

ASSIGN ID

The HP-75 responds with the number of peripheral devices on the HP-IL system and then prompts you for a two letter code for each device. A typical device code for a printer is P1; if there are additional printers in the system, they can be assigned device codes of P2, P3, etc. Once you have assigned the device codes, you must specify the printer as your print device. This is accomplished by entering:

```
PRINTER IS ': device code'
```

If the printer is P1, enter PRINTER IS ':P1'. Now the output of any PRINT or PLIST statement will be sent to your printer.

The procedure described above is done automatically each time the HP-75 is turned on if the HP User's Library Program "AUTOLOOP" (75-0104) is loaded in the HP-75.

For further discussion of these and other HP-IL commands, refer to Section 9 of your HP-75 Owner's Manual.

PWIDTH

If the printer receives more characters than will fit on a single line in nonwrap-around mode, the line is truncated and the excess characters are lost. The HP-75 computer has the capability to break long lines of print appropriately so that the printer does not truncate them. The maximum number of characters to be sent before breaking the line can be input as:

```
PWIDTH #
```

where # is the number of characters.

The ThinkJet printer prints 80 characters on a line in its default print pitch. In other print pitches, the ThinkJet can fit from 40 to 142 characters on a line. Therefore, different PWIDTH commands are required for these print pitches. For details on these print pitches see Chapter 1.

In some cases the PWIDTH command will not give the desired results. For example, the characters in an escape sequence are not printed and do not

take any space on the line. However, every character in an escape sequence is counted by the HP-75. This causes the HP-75 to occasionally break lines of print which could fit on a single line. To avoid this problem you can set PWIDTH to some number greater than the width of the printer. If you execute PWIDTH INF (INF means infinity) the HP-75 will not break any lines. When operating in this mode the printout should be inspected for any lines which were truncated at the right margin. If any are found the program or text file should be edited and reprinted.

ENDLINE

The HP-75 normally terminates each line of print sent to the printer with a carriage return, CHR\$(13), and line feed, CHR\$(10). This single spaces the output and starts each line of print at the left margin. The HP-75 has the capability to allow the user to specify line termination using any combination of up to 3 characters. This is done by entering:

```
ENDLINE string function
```

For example, to cause all lines to be terminated by a carriage return and a half line feed (see Chapter 2), enter the following:

```
ENDLINE CHR$(13)&CHR$(27)&'='
```

If you do not want the HP-75 to add any characters to the ends of lines, enter ENDLINE"". If no string function is provided in the ENDLINE statement, the HP-75 returns to the default setting of carriage return, line feed.

Character Set

The character sets used by the HP-75 computer and the HP 2225B printer differ in some respects. Therefore some of the characters that can be displayed by the HP-75 do not look the same when printed by the printer.

CLEAR LOOP

The HP-75 can send a DCL command (referred to on pages 2-6 and H-1) by using the following command:

```
CLEAR LOOP
```

HP-75 Text Formatter

The HP-75 Text Formatter requires that the print device be specified prior to running FORMAT75. The details of specifying the print device are explained in the HP-75 Owner's Manual and in the section above, Assign Printer.

Appendices C and G of the Text Formatter Owner's Manual describe advanced printing techniques. One of the printers used in the examples is

the HP 82905B. All examples which make use of the HP 82905B, with the exception of examples that use **[ESC]** & k 9 S will work equally well with your ThinkJet printer. To run the examples using **[ESC]** & k 9 S, substitute the bold mode control character, **[CTL]N**, for this escape sequence. To return to normal mode, use **[CTL]O**.

The Text Formatter uses default values of 13 and 73 for left and right margins. For the ThinkJet printer, you may wish to begin your text files with:

10^ma 1 80

which will give you a wider print area and more characters per line.

HP-75 VisiCalc*

If you wish to print your VisiCalc file, you must specify the print device prior to entering VisiCalc. The details of specifying the print device are explained in the HP-75 Owner's Manual and in this Appendix, Assign Printer.

Section 6 of the VisiCalc Owner's Manual gives an extensive explanation of printing techniques. All references to the HP 82905B are applicable to the ThinkJet with the exception that compressed mode on your ThinkJet allows 142 characters per line instead of 132.

Escape sequences and print control characters can also be imbedded within VisiCalc cells. To do this, press:

SHIFT '

This will get you into the VisiCalc label mode. Then enter the escape sequence or control characters required. For example, if you want to include a form feed command in a particular cell: Press

SHIFT 'CTL L

You will see the Greek letter μ in the display. When the worksheet is printed, the printer will do a form feed instead of printing the μ .

*VisiCalc is a registered trademark of VisiCorp.

Using Your Printer with the HP-71

Your ThinkJet printer can be interfaced with an HP-71 equipped with the HP 82401A HP-IL interface module.

Assign Printer

Connect your ThinkJet printer to your HP-71 and turn the printer on before turning on the HP-71. If this is done, the HP-71 will automatically assign the ThinkJet as the system printer. There are several other methods you may use to assign the ThinkJet as your system printer. Try entering any of the following:

- `PRINTER IS :%35`
Uses the printer's HP-IL accessory ID of 35
- `PRINTER IS :HP2225B`
Uses the printer's model number
- `PRINTER IS :HP-IL address`
Uses the printer's position number in the loop
- `PRINTER IS :device code`
Uses a device code compatible with the HP-75 computer (see Appendix C, Using Your Printer with the HP-75).

Escape Sequences

The HP-71 does not allow you to embed escape sequences in character strings directly from the keyboard. You must use the BASIC function `CHR$`. Some software programs, however, allow you to use escape sequences directly.

Control Characters

Pressing the **g** and **RUN** keys on the HP-71 simultaneously allows you to generate control codes. For example, `[CTL]N` is generated by pressing **g** **RUN** **N** simultaneously. Three of the control codes used by the ThinkJet printer can be entered directly from the keyboard in this manner. They are `[CTL]L` (form feed), `[CTL]N` (bold on), and `[CTL]O` (bold off). If you wish to use other ThinkJet control codes, such as `[CTL]H` (backspace), you must generate them by using the BASIC function `CHR$` or through an applications program.

PWIDTH

If the printer receives more characters than will fit on a single line in nonwrap-around mode, the line will be truncated and the excess characters will be lost. The HP-71 computer has the capability to break long lines of print at the appropriate place so that the printer does not truncate them.

The maximum number of characters to be sent before breaking the line can be input as:

```
PWIDTH #
```

where # is the number of characters.

The ThinkJet printer prints 80 characters on a line in its default pitch. In other print pitches, the ThinkJet can fit from 40 to 142 characters on a line. Therefore, different PWIDTH commands are required for these print pitches. For details on these print pitches see Chapter 1.

In some cases the PWIDTH command will not give the desired details. For example, the characters in an escape sequence are not printed and do not take any space on the line. However, every character in an escape sequence is counted by the HP-71. This causes the HP-71 to occasionally break lines of print which could fit on a single line. To avoid this problem you can set PWIDTH to some number greater than the width of the printer. If you execute PWIDTH INF (INF means infinity), the HP-71 will not break any lines. When operating in this mode the printout should be inspected for any lines which were truncated at the right margin. If any are found, the program or text file should be edited and reprinted.

ENDLINE

The HP-71 normally terminates each line of print sent to the printer with a carriage return, CHR\$(13), and line feed, CHR\$(10). This single spaces the output and starts each line of print at the left margin. The HP-71 has the capability of allowing the user to specify line termination using any combination of up to 3 characters. This is done by entering:

```
ENDLINE string function
```

For example, to cause all lines to be terminated by a carriage return and a half line feed (see Chapter 2), enter the following:

```
ENDLINE CHR$(13)&CHR$(27)&'='
```

If you do not want the HP-71 to add any characters to the ends of lines, enter ENDLINE"". If no string function is provided in the ENDLINE statement, the HP-71 will return to the default setting of carriage return, line feed.

Using Your Printer with the HP-41

Your ThinkJet printer can be connected to the HP-41 computer using the HP 82160A HP-IL Module. This module has a switch on its lower side which must be set in the "enable" position for proper operation.

Connect the printer in the HP-IL loop as you would any other HP-IL peripheral.

Make sure the HP-41 is in its automatic addressing mode. You can do this by executing the AUTOIO command.

XEQ ALPHA AUTOIO **ALPHA**

HP-41 Printer Control Flags 55 and 21

Several of the HP-41's flags are used to control printing modes and functions. Flags 55 and 21 are the printer existence flag and the printer enable flag, respectively. They work with your new printer just as they would with any other HP-IL printer. Flag 55 is set by the HP-41 when a printer is present in the system. Flag 21 is also set by the system when a printer is present but you can set and clear the flag to enable or disable printer operation. If the printer does not respond to print commands from the HP-41, you should check to make sure that AUTO mode is set and that Flags 55 and 21 are set. Refer to your HP-41 Owner's Manual.

HP-41 Printer Control Flags 15 and 16

Flags 15 and 16 are used in combination to set MANUAL, NORMAL, TRACE, and STACK TRACE modes. These modes are useful for the following: 1) doing arithmetic where a printed audit trail is desired; and 2) debugging programs. Manual mode is the default mode of the HP-41 when it is turned on and is the mode most commonly used for running programs. Table E-1 summarizes the uses of Flags 15 and 16:

Table E-1
Use of Flags 15 and 16

MODE	FLAG 15	FLAG 16	ACTION
Manual	Clear	Clear	Prints only on specific print commands.
Normal	Clear	Set	Gives an audit trail of inputs.
Trace	Set	Clear	Traces all operations and results.
Stack Trace	Set	Set	Traces all operations plus the stack content.

HP-41 Printer Functions

The following printer functions are applicable when using the ThinkJet printer with your HP-41. Functions not listed do not work or produce unpredictable results. The syntax for these functions is as follows:

XEQ ALPHA *function name* **ALPHA**

(ACA)—Accumulates the ALPHA register contents in the printer's buffer.

(ACCHR)—Accumulates the character specified by the numeric value of the X-register from 0 to 127 in the printer's buffer.

(ACSPEC)—Accumulates a special character from the X-register to the printer's buffer.

(ADV)—Causes the content of the printer's buffer to be printed and advances the paper one line.

(ACX)—Accumulates the formatted content of the X-register in the printer's buffer.

(LIST)—Lists the specified program lines on the printer. If Flag 15 is set, the listing will be in "packed" format.

(OUTA)—Sends the contents of the ALPHA register to the selected HP-IL device.

(PRA)—Prints the content of the ALPHA register and advances the paper one line.

(PRBUF)—Causes the content of the printer's buffer to be printed and advances the paper one line.

(PRFLAGS)—Prints the status of the HP-41. The sigma (Σ) character, which is not available in the ThinkJet character set, is omitted from the third line of the PRFLAGS output.

(PRKEYS)— Prints a listing of the current key assignments.

(PRP)— Prints a listing of the specified program. If Flag 15 is set, the listing will come out in “packed” format.

(PRREG)— Prints the contents of the data registers.

(PRREGX)— Prints the contents of the data registers as directed by the X-register.

(PRΣ)— Prints the contents of the sigma registers.

(PRSTK)— Prints the contents of the stack.

(PRX)— Prints the X-register.



Printing More than 24 Characters on a Line

The HP-41 ALPHA register is frequently used as a place in which to store a line of up to 24 characters prior to printing. With the ThinkJet printer, it may be desirable to print more than 24 characters on a line.

To do this, simply accumulate the content of the ALPHA register into the printer’s buffer several times using the ACA function. When the buffer has the complete line and is ready to print, use the PRBUF command to cause the line to be printed.

For example, fill the ALPHA register with A’s, then accumulate it three times, then print it.

<p>ALPHA AAAAAAAAAAAAAAAAAAAAAAAAAA ALPHA</p> <p>XEQ ALPHA ACA ALPHA XEQ ALPHA ACA ALPHA XEQ ALPHA ACA ALPHA</p> <p>XEQ ALPHA PRBUF ALPHA</p>	<p>Fill the ALPHA register with 24 A’s.</p> <p>Accumulate the 24 A’s three times.</p> <p>Print the 72 A’s.</p>
---	--

The HP-41 Character Set

The HP-41, in combination with 24 character strip printers, can print most standard ASCII characters with character codes between 32 and 122. Outside this range, the HP-41 defines special characters which cannot be accessed easily by the ThinkJet printer. Characters between 123 and 127, and character 96, which are frequently used in the HP-41 applications software, are incompatible with the ThinkJet. Table E-2 summarizes these differences.

Table E-2
Table of Character Set Differences

Character Code	ThinkJet Character	HP-41 Character
96	ˆ	ˆ
123	{	{
124		
125	}	}
126	~	~
127	■	■

Sending Escape Sequences, Control Codes, and Special Characters with the HP-41

The ACCHR function of the HP-41 can be used to send characters between 0 and 127 to the printer. The decimal value of the character is keyed into the X-register, and then ACCHR is executed. Several examples follow which illustrate the use of ACCHR.

1. Control Code: Send a form feed (FF) to the printer. The control code for form feed is 12. To generate a form feed, enter the following:

12 **XEQ ALPHA** ACCHR **ALPHA**

2. Special Characters: Send a lower case q to the printer buffer and then cause it to be printed. The character code for lower case q is 113.

113 **XEQ ALPHA** ACCHR **ALPHA**
XEQ ALPHA PRBUF **ALPHA**

3. Escape Sequence: Send the escape sequence to the printer which will cause it to compress the print to a pitch of 21.3 characters per inch and then print the characters ABC. The escape sequence for this pitch is

[ESC] & k 2 S

Using Appendix A, Table of Print Features, we find that the decimal equivalent of [ESC]&k2S is 27, 38, 107, 50, 83.

These codes are sent with ACCHR, followed by the characters ABC.

27 **XEQ ALPHA** ACCHR **ALPHA**
38 **XEQ ALPHA** ACCHR **ALPHA**
107 **XEQ ALPHA** ACCHR **ALPHA**
50 **XEQ ALPHA** ACCHR **ALPHA**
83 **XEQ ALPHA** ACCHR **ALPHA**
ALPHA ABC **ALPHA**
XEQ ALPHA PRA **ALPHA**

HP-41 Printer Control Flags 12 & 13

Flags 12 and 13, the double wide and lower case flags respectively, do not work with the ThinkJet printer. You can, however, send the escape sequence for 6.0 characters per inch (expanded print) to the printer to emulate double wide mode.

The subroutines below can be used to set expanded and normal printing on the ThinkJet printer.

Expanded Printing	Normal Printing	Comments
01 LBL "WIDE "	01 LBL "NORMAL "	
02 27	02 27	
03 ACCHR	03 ACCHR	Send ESC
04 38	04 38	
05 ACCHR	05 ACCHR	Send &
06 107	06 107	
07 ACCHR	07 ACCHR	Send k
08 49	08 48	
09 ACCHR	09 ACCHR	Send 1 or 0
10 83	10 83	
11 ACCHR	11 ACCHR	Send S
12 RTN	12 RTN	

Locating The ThinkJet Printer

In some specialized applications it may be necessary for the HP-41 to determine the location of the printer and select it as the primary output device. The following subroutine can be used for this purpose:

```

01 LBL "FIND225 "
02 "HP2225B "
03 FINDID
04 SELECT
05 RTN

```

Using Optional Extended HP-41 Capabilities

If you have the HP 82180A Extended Functions/Memory Module or the HP-41CX, you have additional functions which make it easier to send special characters to the printer. The XTOA function allows you to append the character specified by the character code in the X-register to the string in the ALPHA register. This allows you to build up an arbitrary string and then send it using either PRA or OUTA. However, if you want to send characters with values greater than 127, you must use OUTA since PRA limits characters to a range between 0 and 127. An example is provided below.

Using OUTA and XTOA, write a program which will send all character codes between 32 and 255 to the printer.

Program	Comments
01 LBL "ALL CHR "	
02 "HP2225B "	
03 FINDID	
04 SELECT	Find the printer in the HP-IL loop and select it for output.
05 FIX 0	
06 CF 29	Set the display to integer format without decimal points.
07 32.255	Set X-register to count from 32 to 255.
08 LBL 01	
09 CLA	Start loop and clear ALPHA.
10 ARCL X	
11 " "	Format character code and move it to ALPHA followed by spaces.
12 XTOA	
13 OUTA	Append character specified by value of integer part of X-register and send the entire ALPHA register to printer.
14 ISG X	
15 GTO 01	Add one to the count in the X-register and loop.
16 END	

If you have the HP 82180A Extended Function/Memory Module or the HP-41CX, you have the added capability of using ASCII files. ASCII files provide an alternate, highly flexible means of formatting lines longer than 24 characters. Using the ASCII file manipulation functions or the ASCII Editor in the HP-41CX, you may create files with line lengths up to 254 characters. The program below is designed to list ASCII files.

It lists the current, working ASCII file. This is the ASCII file that you most recently named using a file management command.

Program	Comments
01 LBL "ASCII L "	
02 CLX	Set the character pointer to the start of the file.
03 SEEKPT	
04 SF25	Set the error ignore flag.
05 LBL01	Start of loop.
06 GETREC	Get up to 24 characters from the file.
07 FC?25	Are we past the end of the file?
08 RTN	Yes, then return to calling program.
09 ACA	Accumulate characters in the printer.
10 FS?17	End of a line?
12 GT001	If not, get the rest of the line.
13 PRBUF	If end of the line, print the buffer.
14 GT001	Go print the next line.

If you have the HP 82180A Extended Functions/Memory Module installed in your HP-41 or if you have an HP-41CX, you can execute the subroutine below to print the alphabetic characters in the ALPHA register in lower case.

Program	Comments
01 LBL "PRALC "	
02 ALENG	Get the length of the string in the ALPHA register.
03 X = 0?	
04 GTD00	Quit if there is nothing in ALPHA.
05 LBL01	
06 ATOX	Start of loop.
07 XTOA	Get the left-most character from ALPHA. Put character back at right end of ALPHA.
08 65	
09 X > Y?	Go to LBL 02 for any characters that are not upper case alpha characters.
10 GTD02	
11 CLX	
12 91	
13 X <= Y?	
14 GTD02	
15 CLX	Convert upper case alpha characters to lower case.
16 32	
17 +	
18 Enter	
19 LBL02	Send the character to the printer's buffer.
20 RDN	
21 ACCHR	
22 RDN	
23 DSEX	Check to see if all characters have been sent.
24 GTD01	If not, go back to LBL 01.
25 LBL00	
26 PRBUF	Instruct the printer to print its buffer and return to the calling program or stop.
27 RTN	

Using Your Printer with the HP110 Portable

Terminal Emulator

There are two ways of using the HP-IL ThinkJet with the Terminal Emulator:

- To print a copy of the display to ThinkJet press the **SHIFT** and **PRINT ENTER** keys simultaneously.
- To print all text sent to the display on the Portable a download must be set up with the printer:
 1. Press the **USER SYSTEM** key to display the system softkeys.
 2. Press **Download Config** (**f4**) to enter the Download Configuration menu.
 3. Fill out the Download Configuration Menu as follows:

To local file: **PRN**

Protocols: **OFF**

and leave all other fields defaulted.

4. Press **EXIT** to return to main menu then ...
5. Press **From Host** (**f1**). All text directed to the display will also be sent to the ThinkJet printer.

NOTE: The Portable has a large buffer that accumulates text before being printed, so printing won't start until over a page has been displayed. At the end of your printing, press **EXIT** (**f8**) to print the remaining portion of the buffer and end the download. To re-initiate printing, press **From Host** (**f1**) as in 4 above.

The line length can be any value from 1 to 220 on the HP-86/87, and from 1 to 140 on the HP-85. If you are not using 12 characters per inch print pitch (the default), refer to Appendix A for the correct value of line length. In some cases the line length parameter will not give the desired result. For example, the characters in an escape sequence are not printed and do not take any space on the line, but are counted by the computer. This causes the computer to occasionally break lines of print which could fit on a single line. To avoid this problem you must specify a line length greater than the actual line length of the printer. When operating in this mode the printout should be inspected for any lines which are truncated at the right margin. If any are found the program or text should be edited and reprinted.

End Of Line Sequence

The computer normally terminates each line of print sent to the printer with a carriage return, and line feed. This single spaces the output and starts each line of print at the left margin. The HP-IL Interface for the Series 80 has the capability of terminating lines of print with any combination of 0 to 7 characters. For details on the end of line sequence, see the Advanced Operations section of your HP-IL Interface Owner's Manual.

Graphics Capabilities

If you are using your ThinkJet printer with an HP-85, and your HP-85 contains the PCOPY Binary Utility (Binary Utility programs can be obtained from the Series 80 Users' Library), you can copy the CRT graphics to your printer by entering:

```
RDUMP device selector, offset
```

If you are using your ThinkJet printer with an HP-86/87 computer, you must have the 00087-15002 HP-86/87 Plotter ROM to dump the CRT graphics to your printer. Enter:

```
DUMP GRAPHICS lower bound, upper bound,  
rotate, printer type
```

For the ThinkJet printer, the printer type must be an integer greater than 0. To dump the entire contents of the screen without rotation, enter:

```
DUMP GRAPHICS 0,0,0,1
```

Using Your Printer with an HP Series 80 Computer

Hardware

To use your ThinkJet printer with an HP Series 80 computer, you must have an 82938A HP-IL Interface. In addition, for an HP-85, you must have an 00085-15001 HP-85 Plotter/Printer ROM.

Assign Printer

Once you have all of the devices properly connected and turned on, the Series 80 computer must be instructed where the printer is located. This is accomplished by entering:

`PRINTER IS device selector`

When using the HP-IL interface, the device selector is a 3 digit combination of the interface select code and the printer address. The select code for the HP-IL interface is factory preset to 9. (If it has been changed, refer to the Installation section of the HP-IL Interface Owner's Manual for the correct interface select code.) If the interface select code is 9, the device selector for the first device on the HP-IL system is 901. If the printer were the first device on the loop, you would enter `PRINTER IS 901`. Any of the examples contained throughout this manual can be used to verify the operation of your ThinkJet printer with your Series 80 computer.

Line Length

In nonwrap-around (see pages 3-4 and 3-5) mode, if the printer receives more characters than will fit on a single line, the line will be truncated and the excess characters will be lost. The Series 80 computers have the capability to break long lines of print at the appropriate place so that the printer will not truncate them. The HP-86/87 assumes that the printer can fit 80 characters on a line; the HP-85 assumes that the printer fits 32 characters. You can change the line length with the `PRINTER IS` command. The complete syntax for this command is:

`PRINTER IS device selector, line length`

If you are using your ThinkJet printer with an HP-85 computer, you can identify the printer device and specify its line length by typing:

`PRINTER IS 901,80`

The line length can be any value from 1 to 220 on the HP-86/87, and from 1 to 140 on the HP-85. If you are not using 12 characters per inch print pitch (the default), refer to Appendix A for the correct value of line length. In some cases the line length parameter will not give the desired result. For example, the characters in an escape sequence are not printed and do not take any space on the line, but are counted by the computer. This causes the computer to occasionally break lines of print which could fit on a single line. To avoid this problem you must specify a line length greater than the actual line length of the printer. When operating in this mode the printout should be inspected for any lines which are truncated at the right margin. If any are found the program or text should be edited and reprinted.

End Of Line Sequence

The computer normally terminates each line of print sent to the printer with a carriage return, and line feed. This single spaces the output and starts each line of print at the left margin. The HP-IL Interface for the Series 80 has the capability of terminating lines of print with any combination of 0 to 7 characters. For details on the end of line sequence, see the Advanced Operations section of your HP-IL Interface Owner's Manual.

Graphics Capabilities

If you are using your ThinkJet printer with an HP-85, and your HP-85 contains the PCOPY Binary Utility (Binary Utility programs can be obtained from the Series 80 Users' Library), you can copy the CRT graphics to your printer by entering:

```
RDUMP device selector, offset
```

If you are using your ThinkJet printer with an HP-86/87 computer, you must have the 00087-15002 HP-86/87 Plotter ROM to dump the CRT graphics to your printer. Enter:

```
DUMP GRAPHICS lower bound, upper bound,
rotate, printer type
```

For the ThinkJet printer, the printer type must be an integer greater than 0. To dump the entire contents of the screen without rotation, enter:

```
DUMP GRAPHICS 0,0,0,1
```

Using Your Printer with an HP-IL/HP-IB Interface

With the addition of the HP 82169A HP-IL/HP-IB Interface, your ThinkJet Printer can be used with any standard HP-IB controller (HP-IB is Hewlett-Packard's implementation of the IEEE-488 Interface Bus). To use your printer in this manner, connect the HP-IB side of the Interface to your controller using an HP-IB cable. Then connect your printer to the HP-IL side of the Interface. If you have additional HP-IL devices, they can be connected to the HP-IL system in the usual manner. Refer to your HP-IL/HP-IB Interface Owner's Manual for details.

The Interface has 6 switches located next to the HP-IB connector. These switches must be set before you can begin printing operation. The leftmost of these switches (there is a dot below it) should be set to 0, the other 5 switches are used to select the HP-IB address of the Interface. For details, see your HP-IL/HP-IB Interface Owner's Manual.

Once the cables are connected and the switches are set, plug the recharger into the Interface. The HP-IB controller can now access the HP-IL devices using the addresses assigned by the Interface. An HP-IL device's address is determined by adding its position (relative to the Interface) to the Interface's HP-IB address (as determined by its address switch).

For example, if you set the address of the Interface to 0 and your printer is the only device on the HP-IL system, your printer will respond as though it were at HP-IB address 1. For information on how to send data to the printer, refer to the owner's manual for your HP-IB controller.



ThinkJet Printer Interface with HP-IL

This discussion of the ThinkJet printer's interface with the Hewlett-Packard Interface Loop (HP-IL) assumes that the reader has a general understanding of HP-IL. (To learn more about HP-IL, refer to the HP-IL Interface Specification, HP part number 82166-90017.) The information provided below relates specifically to sending and receiving individual HP-IL messages to and from the printer.

Addressing

The ThinkJet can have either a one-byte (simple) or two-byte (extended) address. When first turned on, or after an AAU, the ThinkJet printer is at address 5.

Listener Active

To cause the ThinkJet printer to power up in the listener active state, perform the following:

- Press and hold the blue button.
- Turn on the power switch.
- When the print head carriage moves, release the blue button.

The printer is now in the listener active state.

This capability is useful for applications which require the printer to have listen-only capability.

Device Clear

When the printer receives a DCL or is an addressed listener and receives an SDC, the buffer is immediately cleared, all user-defined modes are set to their default values, the current active position is set to the leftmost column, and, if the paper is not at the top of the form, a form feed is executed.

ID

Accessory ID: returns 1 data byte (35 dec)

Device ID: returns 9 data bytes ("HP2225B," carriage return, line feed)

Status

Returns two data bytes:

The first byte of status returned is the first item in this list that applies:

- 198 or 134—self test failed
- 193 or 129—low battery
- 194 or 130—out of paper or carriage motion disabled
- 227 or 163—buffer full
- 225 or 161—everything's fine

The first number is returned if the printer is requesting service. The second number is returned if it is not. For more details on requesting service, see "Service Requests" below.

In the second byte, each bit refers to a particular condition:

- Bit 7 (most significant)—self test failed
- 6 —low battery
- 5 —out of paper
- 3 —buffer full
- 2 —buffer empty
- 0 —carriage motion disabled

Bits 1 and 4 are always zero.

Service Requests

When the self test fails, the printer runs out of paper, the batteries get low, or the carriage motion is disabled, the printer will request service by setting the service request bit in DOE's and IDY's, and by responding to parallel polls. The printer never sends asynchronous service requests.

The printer will stop requesting service when it is asked for status or when the error condition is corrected.

Data Interrupts

When the buffer fills, self test fails, or carriage motion is disabled, the printer will attempt to interrupt the data transfer with an NRD. The NRD can be sent only if the controller has enabled listener NRD's by sending an ELN frame.

Loop Power Down

Because the printer uses so little power when it is not printing, LPD frames have no effect on the printer.

Alternate Controls Mode

The ThinkJet printer has an "alternate controls mode," in which it uses a second set of escape sequences and control codes. When operating in alternate controls mode, the ThinkJet only recognizes the escape sequences and control codes listed in the table below. All others, including the escape sequences and control codes discussed in Chapters 1 and 2, are not recognized by the printer. If the printer is switched off when in alternate controls mode, it returns to normal mode when switched on again.

Some HP computer systems have associated software with the capability of configuring the ThinkJet printer in alternate controls mode. Refer to your owner's manual for details. If your computer does not have this software capability, the printer will enter alternate controls mode if it is an addressed listener and receives the following HP-IL frames:

DDL6, RFC, data byte 18 (decimal), SDC, RFC

The printer will return to its normal controls mode when power is turned off and on, or when it is an addressed listener and receives the following HP-IL frames:

DDL6, RFC, data byte 0, SDC, RFC

Alternate Controls Mode Table

	Escape/Control Code	ASCII Decimal Equivalent
PRINT PITCHES		
Expanded on	[CTL] N	14
Expanded off (default)	[CTL] T	20
Compressed on	[CTL] O	15
Compressed off (default)	[CTL] R	18
Expanded-compressed on	[CTL] N [CTL] O	14, 15
Expanded-compressed off (default)	[CTL] T [CTL] R	20, 18
BOLD MODE		
Bold print	[ESC] E	27, 69
Normal print (default)	[ESC] F	27, 70
UNDERLINE MODE		
Underline on	[ESC] -1	27, 45, 49
Underline off (default)	[ESC] -0	27, 45, 48
LINE SPACING		
6 lines/inch (default)	[ESC] 2	27, 50
8 lines/inch	[ESC] 0	27, 48
7 dot row line spacing	[ESC] 1	27, 49
# dot row line spacing	[ESC] A CHR\$(#)	27, 65, #
#/3 dot row line spacing note: #/3 is rounded to nearest integer.	[ESC] 3 CHR\$(#)	27, 51, #
PERFORATION SKIP MODE		
Set perf skip length (in lines)	[ESC] N CHR\$(#)	27, 78, #
Perforation skip off (default)	[ESC] O	27, 79
PAGE LENGTH		
Set page length in lines	[ESC] C CHR\$(#)	27, 67, #
Set page length in inches	[ESC] C CHR\$(0) CHR\$(#)	27, 67, 0, #
SELECTING UNIDIRECTIONAL OR BIDIRECTIONAL PRINTING		
Unidirectional printing	[ESC] U 1	27, 85, 49
Bidirectional printing (default)	[ESC] U 0	27, 85, 48
CONTROL FEATURES		
Line feed note: line feed implies carriage return.	[CTL] J	10 or 138
Carriage return	[CTL] M	13 or 141
Form feed	[CTL] L	12 or 140
Back space	[CTL] H	8 or 136
RESET		
Reset print features	[ESC] @	27, 64

Alternate Controls Mode Table (cont.)

	Escape/Control Code	ASCII Decimal Equivalent
GRAPHICS		
Single density column graphics	<code>ESC K #1 #2</code>	27, 75, #, #
Double density column graphics	<code>ESC L #1 #2</code>	27, 76, #, #

NOTE: • #1 and #2 define the binary number of bytes (columns) of graphics data to be sent to the printer. For numbers greater than 256, #2 is the most significant byte of the binary number, and #1 is the least significant byte. For numbers 256 or less, #2 is always 0.

- The most significant bit of a graphics data byte is the top dot of the column; the least significant bit is the bottom dot of the column.
- To advance the paper, line feeds must be sent between rows of column graphics data.

NOTE: In other computer languages, equivalent forms of the BASIC language function `CHR$(#)` may be used. When embedding commands in text, replace the `CHR$(#)` function with the ASCII character equivalent to decimal #.

List of Accessories and Supplies

Part No.	Description
82059D	Recharger, U.S.
82066B	Recharger, Euro-220V
82067B	Recharger, U.K.
82067B OPT 1	Recharger, S. African
82068B	Recharger, Australian
82069B	Recharger, Euro-110V
82167A	HP-IL Cable (.5 meter)
82167B	HP-IL Cable (1 meter)
82167D	HP-IL Cable (5 meters)
82199A	Battery Pack
92261A	Print Head Cartridge
92261M	Ink Jet Paper — 2000 sheets, single sheets
92261N	Ink Jet Paper — 2500 sheets, Z-fold
92261S	Printer Stand — Clear Acrylic

These accessories and supplies are available through your local dealer or directly from Hewlett-Packard. For direct ordering information call 800-538-8787. In Alaska, California, or Hawaii, call 408-738-4133.

Warranty and Service Information

Warranty Information

The complete limited 90-day warranty statement is included with your printer. Additional copies may be obtained from any authorized Hewlett-Packard dealer, or the sales and service office where you purchased your printer.

If you have any questions concerning this warranty, please contact an authorized Hewlett-Packard dealer or a Hewlett-Packard sales and service office. Should you be unable to contact them, please contact:

• **In the United States:**

Hewlett-Packard Company
Personal Computer Group
Customer Support
11000 Wolfe Road
Cupertino, CA 95014
Telephone: (503) 758-1010



Toll-Free Number: (800) FOR-HPPC (800 367-4772)

• **In Europe:**

Hewlett-Packard S.A.
150, route de Nant-d'Avril
P.O. Box CH-1217 Meyrin 2
Geneva
Switzerland
Telephone: (022) 83 81 11

NOTE: Do **not** send units to this address for repair.

• **In other countries:**

Hewlett-Packard Intercontinental
3495 Deer Creek Rd.
Palo Alto, CA 94304
U.S.A.
Telephone: (415) 857-1501

NOTE: Do **not** send units to this address for repair.

How to Obtain Repair Service

For information on service in your area, contact an authorized HP dealer or the nearest Hewlett-Packard service facility listed in the limited 90-day warranty statement included with your printer.

If your printer malfunctions and repair is required, you can help assure efficient servicing by having the following items with your printer at the time of service:

- A description of the configuration of the system you were using at the time of failure.
- A brief description of the malfunction symptoms for the service personnel.
- Printouts or other material that illustrate the problem area(s).
- A copy of the sales slip or other proof of purchase to establish the warranty coverage period.

Serial Number

Each printer carries an individual serial number. It is a good idea to keep a separate record of this number. Should your printer be stolen or lost, the serial number is required for insurance claims and is often helpful for tracing and recovery. Hewlett-Packard does not maintain records of individual owners' names and printer serial numbers.

General Shipping Instructions

Should you ever need to ship the printer, be sure that all components are packed in a protective package (use the original shipping case) to avoid in-transit damage. We suggest that you always insure shipments.

If you happen to be outside of the country where you bought your printer, contact the nearest authorized dealer or local Hewlett-Packard office for shipping instructions. All customs and duty charges are your responsibility.

Index

- A**
Accessories K-1
Addressing I-1
Alternate Controls Mode J-1 thru J-3
ASCII
 Characters 2-2, B-1, E-3, J-3
 Files E-6
 Table 1-2, B-2, B-3
Attention (Yellow) Light 3-4
- B**
Back Space 2-1, 2-2, A-2, B-2, D-1, J-2
Battery Pack 3-1, 3-4
Battery Recharger 3-1
Bidirectional Print 2-4, A-1, J-2
Blue Button 3-4, I-1
Bold Print 1-3, A-1, B-2, C-3, D-1, J-2
Buffer 2-3, 2-4, 2-6, E-3, E-4, I-1
- C**
Carriage Return 2-2 thru 2-5, 2-7, 3-5, A-2, B-2, C-2, D-2, G-2, J-2
CHR\$() Function 1-2, D-1, J-3
Control Codes 1-1 thru 1-3, 2-1, 2-2, 2-5, B-1, B-2, C-3, D-1, E-4, J-1
Control Features 2-1, A-2, J-2
Current Active Position 2-1, 2-2, I-1
- D**
Data Interrupts I-2
Default Printing Specifications 2-7
Device Clear 2-6, C-2, I-1
Display Functions 2-5, 2-6, A-1, B-1
- E**
Environmental Conditions 3-1
Error Conditions 3-4 thru 3-6
Escape Sequences 1-1 thru 1-6, 2-1 thru 2-7, A-1, A-2,
 C-1 thru C-3, D-1, E-4, G-2, J-1 thru J-3
 Linking 2-5
- F**
Form Feed 1-5, 2-6, I-1
 Control 2-2, 2-7, A-2, B-2, C-3, D-1, E-4, I-1, J-2



G	
Graphics	2-2, A-2, G-2
Begin	2-4
Column	J-3
Data	2-3
Density	2-3, 2-4
Dot Row	2-3
Mode	2-2
Raster	2-2
Terminate	2-4
H	
Half Line Feed	2-1, A-2, C-2, D-2
HP Series 80 Computer	G-1, G-2
HP-41 Computer	E-1 thru E-8
HP-71 Computer	D-1, D-2
HP-75 Computer	C-1 thru C-3
HP110 Portable	F-1
HP-IL	
Cables	3-5, C-1, K-1
Specifications	I-1, I-2
HP-IL/HP-IB Interface	H-1
I	
ID	I-1
L	
Line Feed	
Control	2-1, 2-3 thru 2-5, 2-7, 3-5, A-2, B-2, C-2, D-2, G-2, J-2
Line Spacing	1-4, 1-6, 2-1, 2-5, A-1, J-2
Line Termination	2-7, 3-5, A-2, C-2, D-2, G-2
Listen Only	I-1
Listener Active	I-1
Logical Page	1-4, 2-1
Loop Power Down	I-2
M	
Maintenance	3-1 thru 3-4
Battery Pack	3-1
Print Head Cartridge	3-2
Printer	3-3
Margins	2-7, C-3
Mixing Modes	1-3
O	
Operating Conditions	3-1
Overstrike	2-2

P	
Page Length	1-5, 1-6, A-1, J-2
Paper	3-4
Fanfold	1-4, 3-5
Ink Jet	3-5, K-1
Perforation Area	1-4, 1-5
Perforation Skip	1-4, 1-5, 2-1, 2-5, A-1, J-2
Power (Red) Light	3-4
Power Switch	3-4
Print Head Cartridge	3-2, K-1
Bladder	3-2, 3-6
Empty	3-2
Expiration Date	3-3
Face	3-2, 3-3, 3-6
Print Pitches	1-2, 1-3, A-1, C-1, D-2, E-4, G-2, J-2
Printed Characters	B-1
Printer Stand	K-1
Printing Self Test	A-2
R	
Radio/Television Interference	Inside Back Cover
Recharger	K-1
Repair	L-1, L-2
Reset	2-6, A-2, J-2
Roman Extension	B-1
S	
Status	I-2
Self Test	2-6, 3-5
Serial Number	L-2
Service Requests	I-2
Shipping Instructions	L-2
Storing Conditions	3-1
Subscripts	2-1
Superscripts	2-1
Supplies	K-1
T	
Text Area	1-4, 1-5, 2-1
Text Length	1-6, A-1
Text Mode	2-2
Top of Form	1-5, 2-6, I-1
Troubleshooting	3-1, 3-4 thru 3-6

U
Underline 1-3, A-1, I-2
Unidirectional Print 2-4, A-1, I-2

W
Warranty Information K-1
Wrap-Around 1-3, 2-4, 2-5, A-1, C-1, D-2, F-1

Print Features
 Druckeigenschaften
 Caractéristiques d'impression
 Posibilidades de impresión
 Caratteristiche di stampa
 Afdruk eigenschappen
 Udskrifts-faciliteter
 Utskrifts-funksjoner
 Utskriftsmöjligheter
 Kirjoittimen toimintamuodot

<p> ABCDEFGHIJKLMNOPQRSTUVWXYZ ABCDEFGHIJKLMNOPQRSTUVWXYZ ABCDEFGHIJKLMNOPQRSTUVWXYZ ABCDEFGHIJKLMNOP ABCDEFGHIJKLMNOP ABCDEFGHIJKLMNOP <u>ABCDEFGHIJKLMN</u> <u>ABCDEFGHIJKLMN</u> </p>	<p> [ESC] & k 2 S [ESC] & k 0 S [ESC] & k 3 S [ESC] & k 1 S [ESC] (s 1 B [ESC] (s 0 B [ESC] & d D [ESC] & d @ </p>
<p>   </p>	<p> [ESC] & l 1 L [ESC] & l 0 L </p>