

Service Manual

HP OmniBook 300, 425, 430, 530



Notice

In a continuing effort to improve the quality of our products, technical and environmental information in this document is subject to change without notice.

Hewlett-Packard makes no warranty of any kind with regard to this material, including, but not limited to, the implied warranties of merchantability and fitness for a particular purpose. Hewlett-Packard shall not be liable for errors contained herein or for incidental or consequential damages in connection with the furnishing, performance, or use of this material.

Hewlett-Packard assumes no responsibility for the use or reliability of its software on equipment that is not furnished by Hewlett-Packard.

As an ENERGY STAR partner, HP has determined that these products meet the ENERGY STAR guidelines for energy efficiency.

All Certifications may not be completed at product introduction. Please check with your HP reseller for certification status.

This equipment is subject to FCC rules. It will comply with the appropriate FCC rules before final delivery to the buyer.

ENERGY STAR is a service mark of the U.S. Environmental Protection Agency. IBM and OS/2 are registered trademarks of International Business Machines Corporation. Pentium and the Intel Inside logo are registered trademarks of Intel Corporation. LapLink Remote Access is a trademark of Traveling Software, Inc. Microsoft, MS-DOS, and Windows are registered trademarks, and the Genuine Microsoft Products logo is a trademark of Microsoft Corporation in the United States of America and in other countries.

© Hewlett-Packard Company 1996.

All Rights Reserved. Reproduction, adaptation, or translation without prior written permission is prohibited except as allowed under copyright laws.

Printed in U.S.A.
5965-0244

HP Computer Museum
www.hpmuseum.net

For research and education purposes only.

Table of Contents

Table of Figures	iv
Introduction.....	v
Product Overview	1
Product Features	2
OmniBook 300, 425, and 430	2
OmniBook 530	3
Product Comparisons	4
Product at a Glance	6
Troubleshooting.....	9
OmniBook Self-Test	10
Loop Back Connectors.....	10
Troubleshooting Flowchart	12
Main Troubleshooting Flowchart.....	13
Power Source Problems	15
Boot-Up Problems.....	18
Display Problems	19
Hard Disk Problems	20
Memory Problems.....	23
Power Management Problems.....	25
Pop-Out Mouse Problems.....	28
Floppy Drive Problems.....	32
Parallel Port Problems	35
Serial Port Problems	37
PCMCIA Problems	39
IR Port Problems.....	43
Hardware Repair.....	45
Battery (End User Replaceable).....	46
Memory (End User Replaceable)	48
Hard Disk Drive/Flash Card and System ROM (End User Replaceable).....	50
Mouse (End User Replaceable)	52
Small Parts (End User Replaceable)	53
Battery Door	53
Battery Door Latch	53
Blank Modem Door	53
Memory Door	53
I/O Door.....	53
Rubber Feet.....	53
PCMCIA Card Tray	53
Display (HP Authorized Service Providers Only)	54
Keyboard (HP Authorized Service Providers Only)	61
Logic PCA Board (HP Authorized Service Providers Only)	62
Paw Carrier (Paw Active) (HP Authorized Service Providers Only)	64
Other Components (HP Authorized Service Providers Only)	65
Appendix A - Technical and Resource Specifications	66
Mass Storage Specifications	66
Card Services and Socket Services Version Matrix	66
Memory Map.....	67
Upper Memory Block Space.....	67
DOS Conventional Memory.....	67
Appendix B - Power On Self Test Codes	68
Beep Codes	68



Display Codes	69
Appendix C - Password Policy	74
Appendix D - Part Numbers	76

Table of Figures

Figure 1 - OmniBook 300, 425, and 430 Features	2
Figure 2 - OmniBook 530 Features	3
Figure 3 - Serial Loop Back Connector	11
Figure 4 - Parallel Loop Back Connector	11
Figure 5 - OmniBook Memory Modules	48
Figure 6 - Removing the Memory Module	49
Figure 7 - Removing Card Slot Tray	51
Figure 8 - Removing the Mouse	52
Figure 9 - Outer Bottom Case Components	54
Figure 10 - Backplane Standoffs	55
Figure 11 - Bottom Case Tabs	55
Figure 12 - Bottom Case Prying Locations	56
Figure 13 - I/O Port Prying Location	56
Figure 14 - Disconnecting Display Cable	57
Figure 15 - Keyboard Flex Cables	57
Figure 16 - Display Grounding Eyelets	58
Figure 17 - Display Cable Probe Position	59
Figure 18 - Reconnecting Display Cable	59
Figure 19 - I/O Port Eyelets (all present)	60
Figure 20 - I/O Port Eyelets (two matched sets)	60
Figure 21 - I/O Port Eyelets (only one matched set)	60
Figure 22 - I/O Port Eyelets (no eyelet in position one)	60
Figure 23 - Logic Board PCA Removal	62
Figure 24 - Paw Carrier Removal	64

Introduction

This document provides reference information for the HP OmniBook 300, HP OmniBook 425, HP OmniBook 430, and HP OmniBook 530. It is intended to be used by HP-qualified service personnel to help with the installation, servicing, and repair of these HP OmniBook PCs.

It is a self-paced guide designed to train you to install, configure, and repair the OmniBook Notebook PC. You can follow it without having any equipment available.

The following table lists additional sources where supplementary information can be obtained:

Resource	Number/Address	Comments
HP External Web	http://hpcc998.external.hp.com/mcd/	No usage restriction
HP-MCD Internal Web	http://webmcd.cv.hp.com	Restricted to HP internet access only
HP MCD Service Engineer	svc-eng_mcd@om.cv.hp.com	Email address for service related questions and issues

Part 1

Product Overview

- Product Features
- Product Comparisons
- Product at a Glance

Product Features

OmniBook 300, 425, and 430

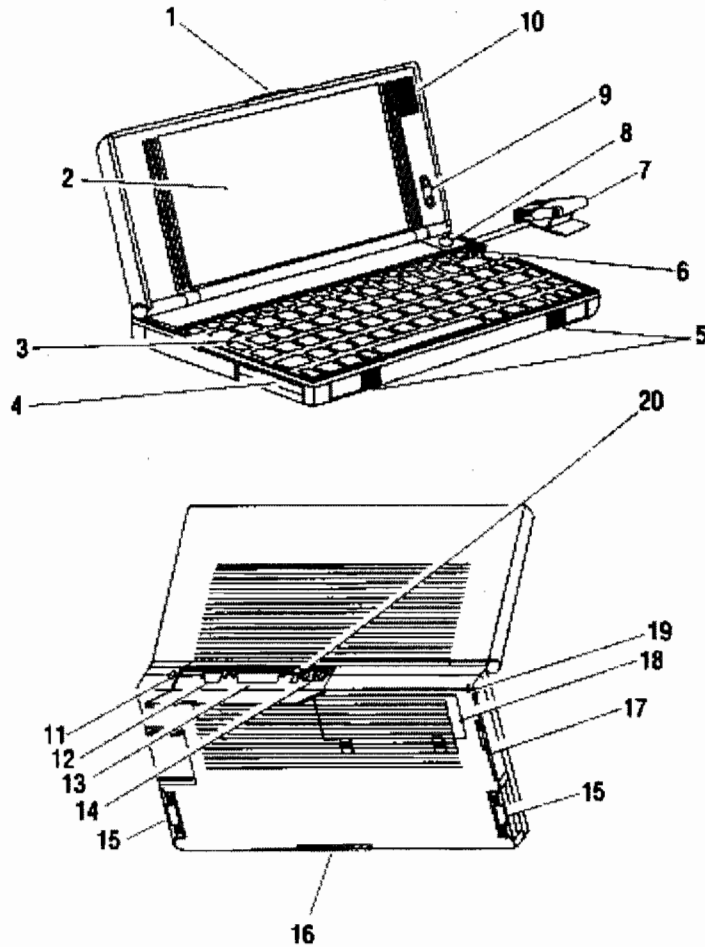

Figure 1 - OmniBook 300, 425, and 430 Features

- | | |
|-----------------------------|-----------------------------|
| 1. Latch | 11. AC adapter socket |
| 2. Display | 12. Serial port connector |
| 3. Keyboard | 13. Parallel port connector |
| 4. Card slot A | 14. Infrared port |
| 5. Card-eject levers | 15. System slots (C and D) |
| 6. On/Off key | 16. Memory-expansion slot |
| 7. Mouse | 17. Modem port |
| 8. Mouse-eject button | 18. Battery compartment |
| 9. Display contrast buttons | 19. Security ring |
| 10. Speaker | 20. Reset button |

OmniBook 530

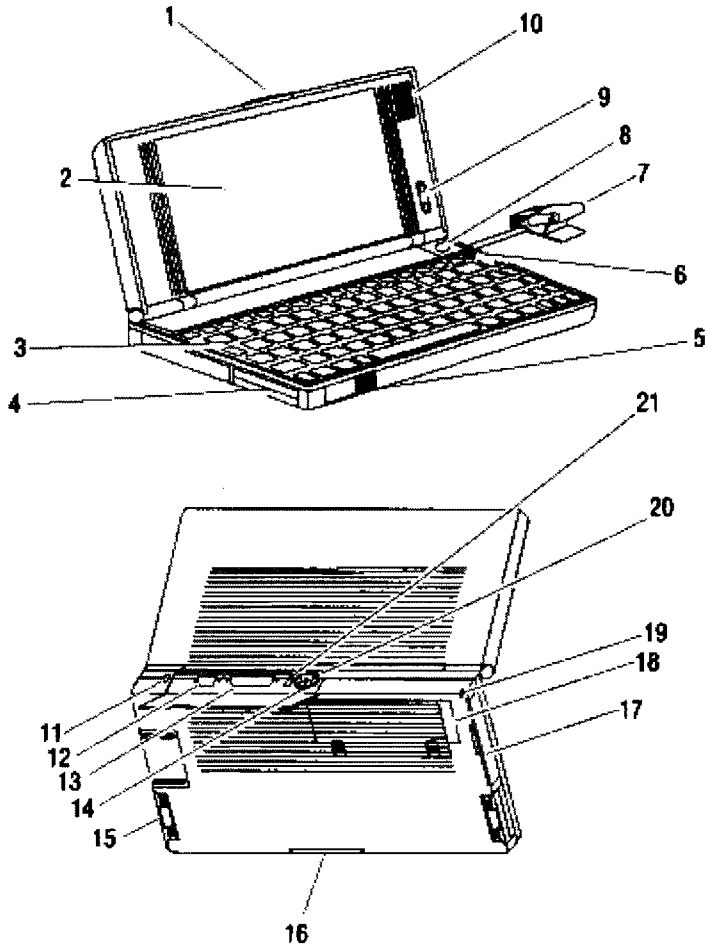

Figure 2 - OmniBook 530 Features

- | | |
|-----------------------------|-----------------------------|
| 1. Latch | 12. Serial port connector |
| 2. Display | 13. Parallel port connector |
| 3. Keyboard | 14. VGA output connector |
| 4. Card slots | 15. System slots |
| 5. Card-eject levers | 16. Memory-expansion slot |
| 6. On/Off key | 17. Modem port |
| 7. Mouse | 18. Battery compartment |
| 8. Mouse-eject button | 19. Security ring |
| 9. Display contrast buttons | 20. Infrared port |
| 10. Speaker | 21. Reset button |
| 11. AC adapter socket | |

Product Comparisons

	OmniBook 300	OmniBook 425	OmniBook 430	OmniBook 530
Size Closed	16.3 x 28.2 x 3.6 cm (6.4 x 11.1 x 1.4 in)	16.3 x 28.2 x 3.6 cm (6.4 x 11.1 x 1.4 in)	16.3 x 28.2 x 3.6 cm (6.4 x 11.1 x 1.4 in)	16.3 x 28.2 x 3.6 cm (6.4 x 11.1 x 1.4 in)
Weight	1.31 kg (2.888 lb) w/flash 1.36 kg (2.998) w/hdd	1.31 kg (2.888 lb) w/flash 1.36 kg (2.998) w/hdd	1.36 kg (2.998 lb)	1.36 kg (2.998 lb)
Processor	386SXLV	486SLC/e	486SLC/e	Intel® 486SX
Clock Speed	20 MHz	25 MHz	25 MHz	33 MHz
Display	640 x 480 VGA 9-inch diagonal LCD 16 shades of gray	640 x 480 VGA 9-inch diagonal LCD 16 shades of gray	640 x 480 VGA 9-inch diagonal LCD	640 x 480 VGA 9-inch diagonal LCD
VGA-out Support	none	none	none	640 x 480, 16 or 256 colors 800 x 600, 16 colors
Battery	4.8 Vdc nickel-metal-hydride rechargeable 1.5 V alkaline AA (flash version only)	4.8 Vdc nickel-metal-hydride rechargeable 1.5 V alkaline AA (flash version only)	4.8 Vdc nickel-metal-hydride rechargeable 1.5 V lithium AA	4.8 Vdc nickel-metal-hydride rechargeable
Battery Life	5 hours w/hdd 9 hours w/flash	4.5 hours w/hdd 8 hours w/flash	4.5 hours	4 hours
AC Adapter	100 to 240 Vac (50 to 60 Hz) input 12 Vdc output	100 to 240 Vac (50 to 60 Hz) input 12 Vdc output	100 to 240 Vac (50 to 60 Hz) input 12 Vdc output	100 to 240 Vac (50 to 60 Hz) input 12 Vdc output
Recharge Time	less than 1.5 hours w/ac adapter	less than 1.5 hours w/ac adapter	less than 1.5 hours w/ac adapter	less than 1.5 hours w/ac adapter
Operating Temperature	0 to 40 C (32 to 104 F)	0 to 40 C (32 to 104 F)	0 to 40 C (32 to 104 F)	0 to 40 C (32 to 104 F)
Storage Temperature (with data retention)	0 to 55 C (32 to 131 F)	0 to 55 C (32 to 131 F)	0 to 55 C (32 to 131 F)	0 to 55 C (32 to 131 F)
Operating and Storage Humidity	90% relative humidity at 40 C (104 F) maximum	90% relative humidity at 40 C (104 F) maximum	90% relative humidity at 40 C (104 F) maximum	90% relative humidity at 40 C (104 F) maximum
Mass Storage Available	40-MB hard disk 10-MB flash disk 2 MB RAM	40-MB hard disk 10-MB flash disk 2 MB RAM	105-MB hard disk 40-MB hard disk 2 MB RAM on 40-MB version 4 MB RAM on 105-MB version	130-MB hard disk 4 MB RAM
Memory Expansion Available	2-MB, 4-MB	2-MB, 4-MB	2-MB, 4-MB	4-MB, 8-MB
Input/Output	9-pin, 115K baud, RS-232 port 25-pin parallel port 115K baud, bidirectional infrared port Communication port for optional fax/modem	9-pin, 115K baud, RS-232 port 25-pin parallel port 115K baud, bidirectional infrared port Communication port for optional fax/modem	9-pin, 115K baud, RS-232 port 25-pin parallel port 115K baud, bidirectional infrared port Communication port for optional fax/modem	9-pin, 115K baud, RS-232 port 25-pin parallel port 115K baud, bidirectional infrared port Communication port for optional fax/modem
Keyboard and Mouse	85 keys Industry-standard, full-sized key spacing Embedded numeric keypad 9 Fn keys Built-in pop-up mouse	85 keys Industry-standard, full-sized key spacing Embedded numeric keypad 12 Fn keys Built-in pop-up mouse	85 keys Industry-standard, full-sized key spacing Embedded numeric keypad 12 Fn keys Built-in pop-up mouse	85 keys Industry-standard, full-sized key spacing Embedded numeric keypad 12 Fn keys Built-in pop-up mouse
Expandability	PCMCIA, Type II,	PCMCIA, Type II,	PCMCIA, Type II,	Two PCMCIA Type II

	OmniBook 300	OmniBook 425	OmniBook 430	OmniBook 530
	Version 2.0 card slots Two slots available with the flash disk version One slot available with the hard disk version	Version 2.0 card slots Two slots available with the flash disk version One slot available with the hard disk version	Version 2.0 card slots One slot available with the hard disk version	slots (one Type III slot) Optional floppy disk drive
Pre-installed Software	MS [®] Windows 3.1* MS DOS [®] 5.0* MS Word 2.0* MS Excel 4.0* LapLink Remote Access™ Phone Book Appointment Book HP Financial Calculator	MS [®] Windows 3.1* MS DOS [®] 5.0* MS Word 2.0* MS Excel 4.0* LapLink Remote Access™ Phone Book Appointment Book HP Financial Calculator	MS [®] Windows 3.1 MS DOS [®] 6.2 LapLink Remote Access™ Phone Book Appointment Book HP Financial Calculator	MS [®] Windows 3.11 MS DOS [®] 6.2 LapLink Remote Access™ Phone Book Appointment Book HP Financial Calculator

*(Note: All components not included can be installed from a retail copy. License for full Microsoft Word, Microsoft Excel, MS-DOS, and Microsoft Windows is included with purchase.)

Product at a Glance

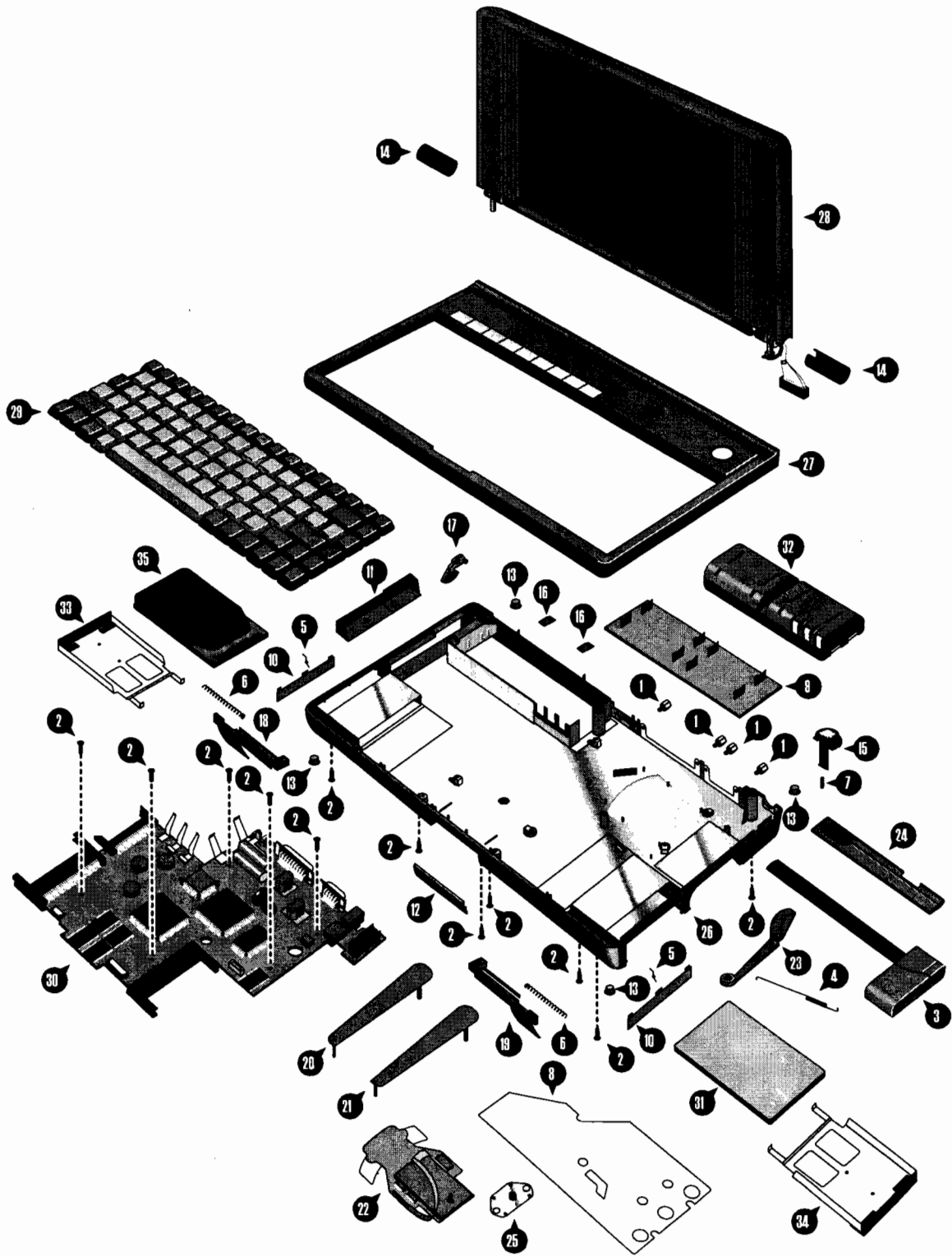

	Description	Part Number	OB300	OB425	OB430	OB530
1	Standoff	0380-4060	✓	✓	✓	✓
2	Screw M2x4.6mm (T6)	0515-2396	✓	✓	✓	✓
3	Mouse	5061-4390	✓	✓	✓	✓
4	Arm Eject Mouse Spring	F1030-00016	✓	✓	✓	✓
5	Pivot Door Spring	F1030-00026	✓	✓	✓	✓
6	Spring Card Eject	F1030-00029	✓	✓	✓	✓
7	Mouse Latch Spring	F1030-00030	✓	✓	✓	✓
8	Mylar Mouse Shield	F1030-20001	✓	✓	✓	✓
9	Door Battery					
	Door Battery (10 pack)	F1030-60912	✓	✓	✓	✓
	Door Battery (silver)	F1052-40012	✓	✓	✓	✓
10	Pivot Door					
	Pivot Door (PCMCIA) A	F1030-40013	✓	✓	✓	✓
	Pivot Door (PCMCIA) B	F1030-40014	✓	✓	✓	✓
	Pivot Door (PCMCIA) Left	F1052-40007	✓	✓	✓	✓
11	Door Modem Blank	F1030-40016	✓	✓	✓	✓
12	Door RAM	F1030-40017	✓	✓	✓	✓
13	Rubber Foot	F1030-40018	✓	✓	✓	✓
14	Hinge Cap	F1030-40019	✓	✓	✓	✓
15	Mouse Button Latch	F1030-40021	✓	✓	✓	✓
16	Battery Door Latch	F1030-40025	✓	✓	✓	✓
17	Security Latch	F1030-40033	✓	✓	✓	✓
18	Eject Button A	F1030-40044	✓	✓	✓	✓
19	Eject Button B	F1030-40045	✓	✓	✓	✓
20	Eject Arm Left	F1030-40046	✓	✓	✓	✓
21	Eject Arm Right	F1030-40047	✓	✓	✓	✓
22	Paw Carrier Srvc Assy	F1030-60901	✓	✓	✓	✓
23	Arm Eject Mouse	F1030-40050	✓	✓	✓	✓
24	Door I/O	F1030-60908	✓	✓	✓	✓
25	Pivot Bracket	F1030-60909	✓	✓	✓	✓
26	Bottom Case					
	Bottom Case	F1030-60910	✓	✓	✓	✓
	Bottom Case (silver)	F1052-60908	✓	✓	✓	✓
27	Top Case					
	Top Case	F1030-60911	✓	✓	✓	✓
	Top Case (silver)	F1052-60907	✓	✓	✓	✓
28	LCD Display Assy (new)	F1030-60904	✓	✓	✓	✓
29	Keyboard					
	Keyboard USA	F1030-80013	✓	✓	✓	✓
	Keyboard German	F1030-80031	✓	✓	✓	✓
	Keyboard Spanish	F1030-80032	✓	✓	✓	✓
	Keyboard French	F1030-80033	✓	✓	✓	✓
	Keyboard International English	F1030-80057	✓	✓	✓	✓
30	Logic PCA					
	Logic PCA (new)	F1030-60907	✓	✓	✓	✓
	Logic PCA (new)	F1033-60907	✓	✓	✓	✓
	Logic PCA (new)	F1052-60906	✓	✓	✓	✓
	Logic PCA (exchange)	F1052-69008	✓	✓	✓	✓
31	System ROM					
	System ROM (ABA) - US English	F1033-60908	✓	✓	✓	✓
	System ROM (ABB) Int. English	F1033-60909	✓	✓	✓	✓
	System ROM (ABD) German	F1033-60910	✓	✓	✓	✓
	System ROM (ABF) French	F1033-60911	✓	✓	✓	✓
	System ROM (ABE) Spanish	F1033-60912	✓	✓	✓	✓
	System ROM (ABA) US English	F1037-60903	✓	✓	✓	✓
	System ROM (ABB) Int. English	F1037-60904	✓	✓	✓	✓
	System ROM (ABD) German	F1037-60905	✓	✓	✓	✓
	System ROM (ABE) Spanish	F1037-60906	✓	✓	✓	✓
	System ROM (ABF) French	F1037-60907	✓	✓	✓	✓
32	Battery Pack	F1045-60901	✓	✓	✓	✓
33	Hard Drive Tray	F1065-60029	✓	✓	✓	✓
34	Flash Tray	F1030-60923	✓	✓	✓	✓
35	Mass Storage					
	5 MB Flash Disk Card	F1012-60902	✓	✓	✓	✓
	10 MB Flash Disk Card	F1013-60901	✓	✓	✓	✓
	20 MB Flash Disk Card	F1014-60901	✓	✓	✓	✓
	40 MB Hard Drive (DOS/Win/PIM)	F1035-60901	✓	✓	✓	✓
	40 MB Hard Drive (unprogrammed)	F1050-60901	✓	✓	✓	✓
	105 MB Hard Drive (DOS/Win/PIM)	F1037-60908	✓	✓	✓	✓
	105 MB Hard Drive (Word/Excel)	F1037-60909	✓	✓	✓	✓
	105 MB Hard Drive (unprogrammed)	F1039-60901	✓	✓	✓	✓
	130 MB Hard Drive (unprogrammed)	F1057-60901	✓	✓	✓	✓
	130 MB Hard Drive (programmed)	F1052-60909	✓	✓	✓	✓

Note, this is a partial parts list. For a complete parts list, please refer to Appendix D or the current Product Support Plan.



Part 2

Troubleshooting

- OmniBook Self Test
- Troubleshooting Flowchart

OmniBook Self-Test

The OmniBook Self-Test provides on-board hardware and firmware diagnostics. To operate the self-test, perform the following steps:

1. Save all files and close all applications: The OmniBook is reset at the end of the self-test.
2. Turn the OmniBook OFF.
3. Press and hold the [Esc] key and press [ON]. You will hear a short three-tone beep.
4. Self Test will initialize and start.
5. To run a test:
 - Highlight the test name and press [ENTER].
 - Highlight the test name and press [Ctrl][ENTER] to run a longer and more extensive version of a test--not available for all tests.
 - The test runs and its results are reported.
6. To run several tests in a continuous loop:
 - Highlight one or more using [space bar] and press [ENTER].
 - Each test runs and its results are reported.
 - Press [Backspace] to stop the loop.
7. To exit the self-test, press [Esc].

Interpretation of test results

A result of "OK" on any test indicates that the test did not find problems while the unit was operating in its current state. A "BAD" result indicates that the test found a problem while the unit was operating in its current state. A "BAD" result should always be confirmed by running the test in a loop for several iterations or running the long version of the test. Further inspection of the unit to rule out configuration or installation conflicts is necessary prior to diagnosing the unit as needing repair.

Any test that is halted by [Backspace] is shown as "aborted" and no results are displayed.

The OmniBook will not enter sleep mode while the self-test is executing.

Loop Back Connectors

In order to run the RS232 serial port or parallel port self-test, a loop back connector is needed. The loop back may be placed on either the OmniBook port or at the end of the corresponding cable. This feature is also helpful in diagnosing a defective serial or parallel cable.

Loop back connectors may be purchased or can easily be constructed. The following illustrations identify the correct pin-out configurations for the serial and parallel loop back connectors.

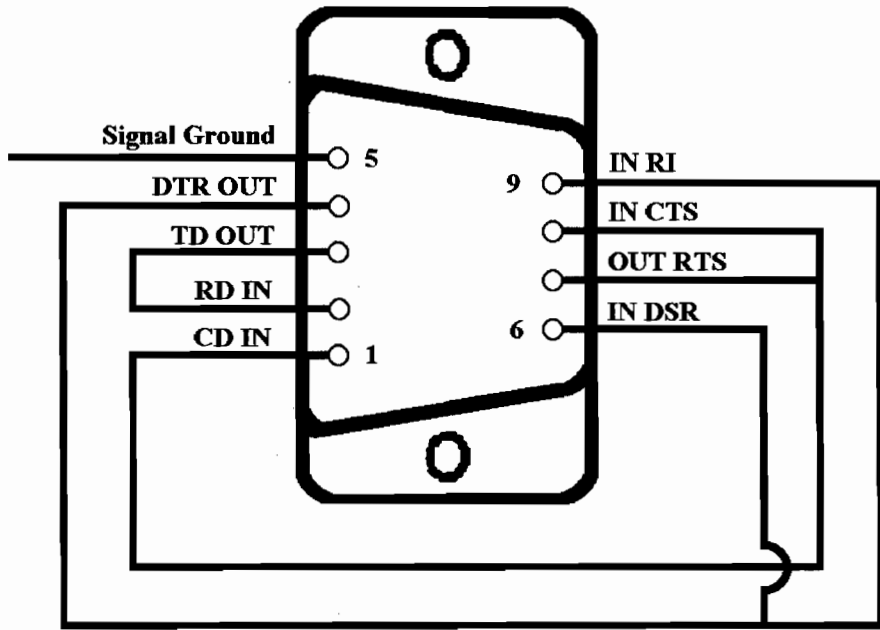

Figure 3 - Serial Loop Back Connector

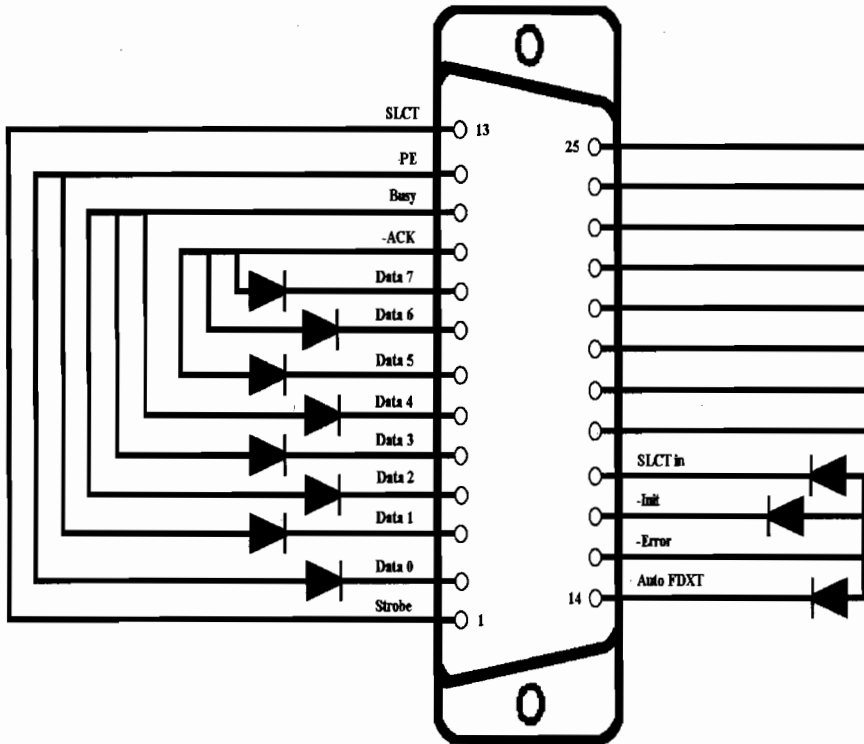

Figure 4 - Parallel Loop Back Connector

Troubleshooting Flowchart

The following series of flowcharts is intended as a guide for troubleshooting the OmniBook 300, 425, 430, and 530. Each technician should still rely on personal experience and supplemental knowledge when diagnosing a problem.

These tips should be kept in mind when referencing the troubleshooting flowcharts:

- Use the Main Troubleshooting Flowchart to isolate the problem to a particular area.
- Use the additional individual troubleshooting flowcharts to narrow down the problem to a specific component or item.
- Always use supplemental information resources, including the Product Support Plan, Service Notes, and the World Wide Web, to aid in diagnosing problem areas.

Main Troubleshooting Flowchart

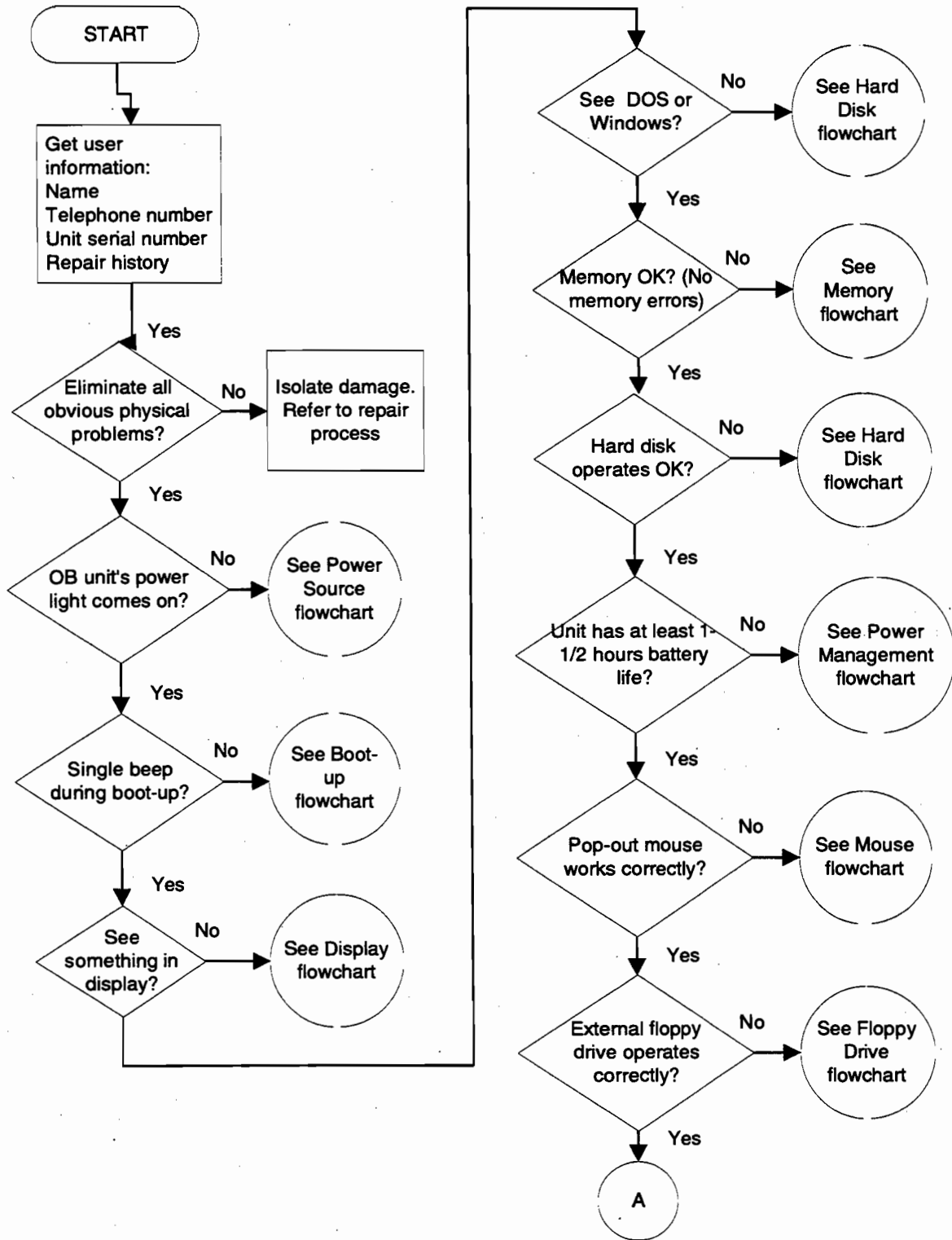

Main Troubleshooting Flowchart (continued)

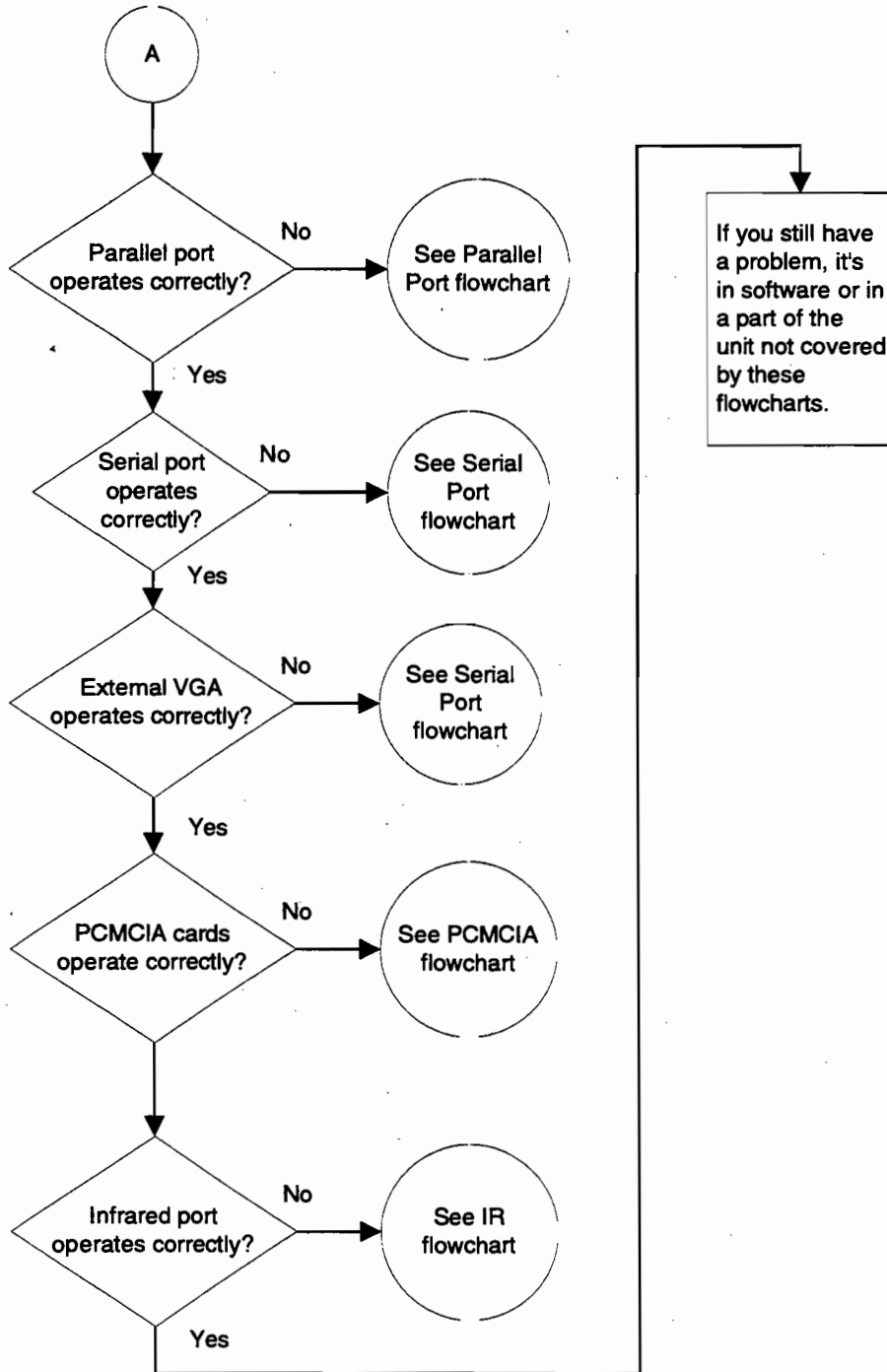

Power Source Problems

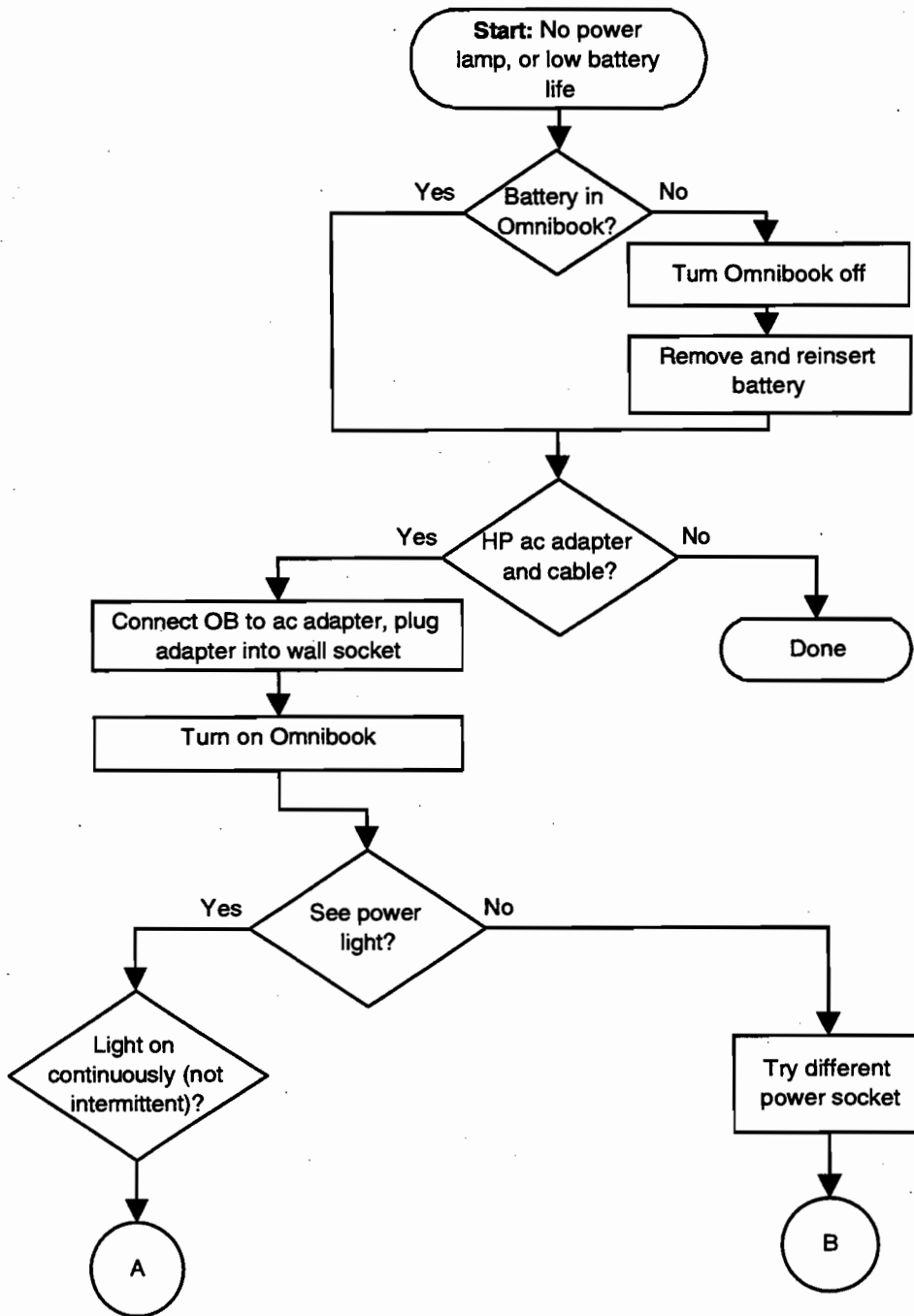

Power Source Problems (continued)

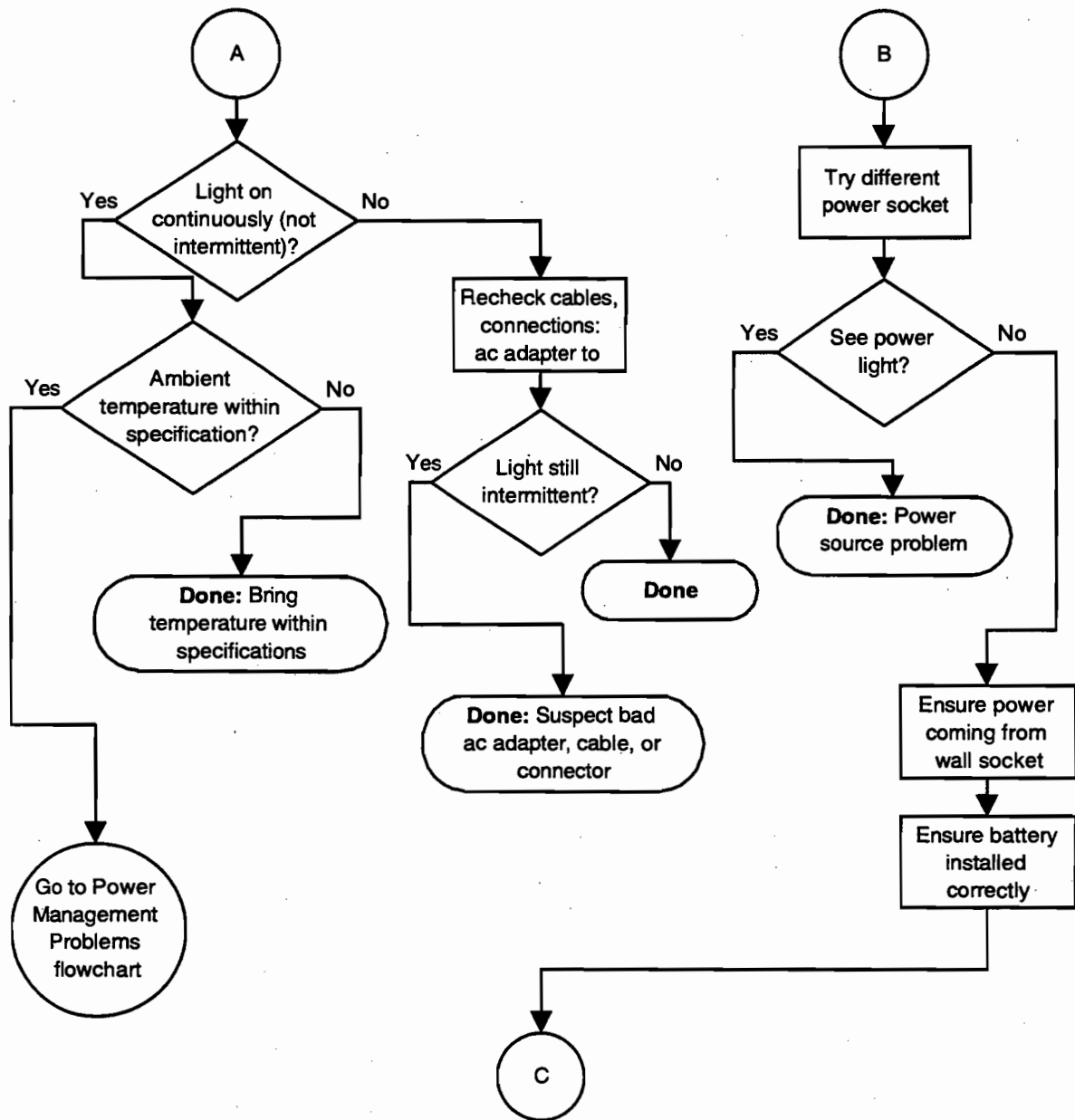

Power Source Problems (continued)

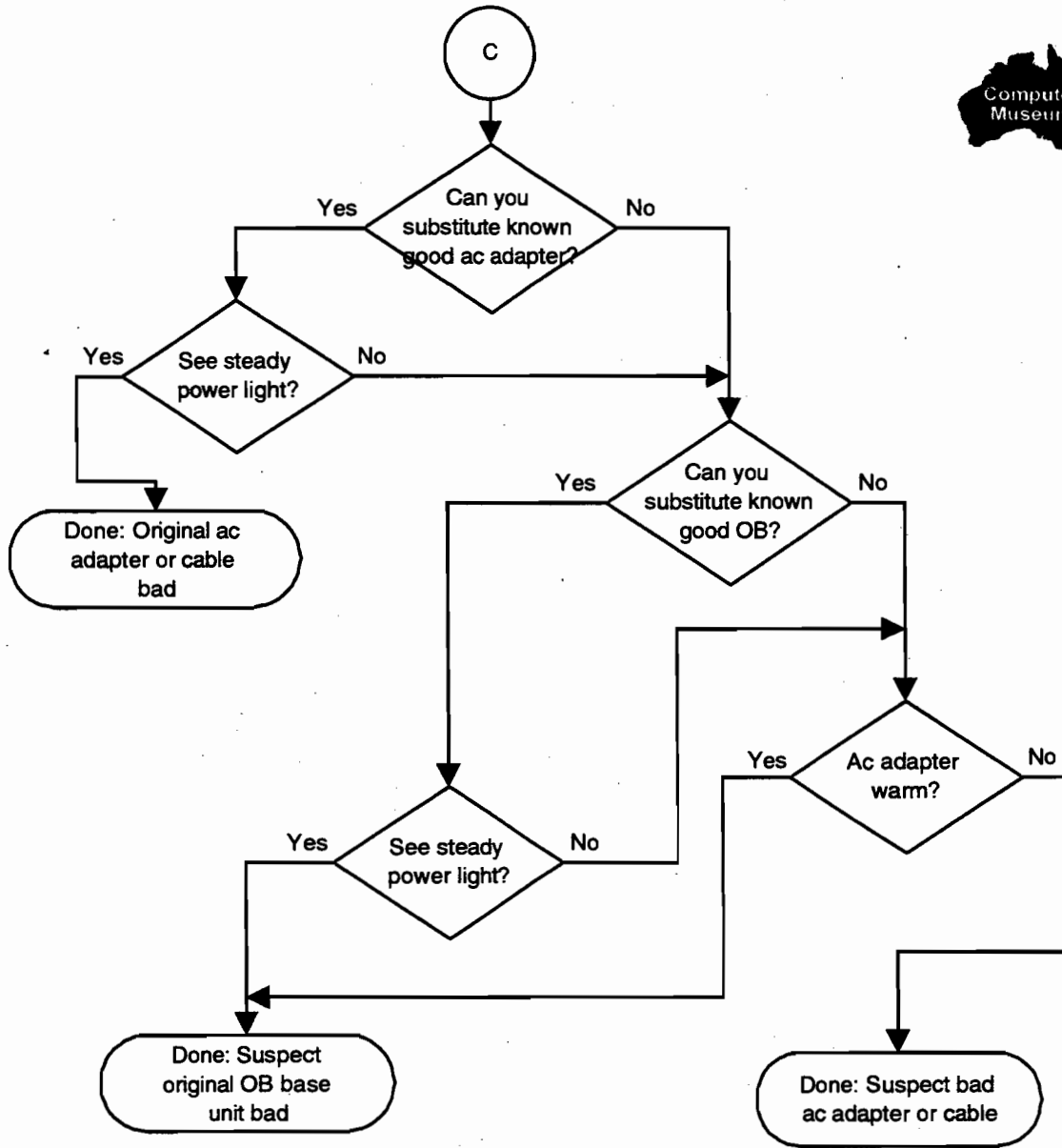

Boot-Up Problems

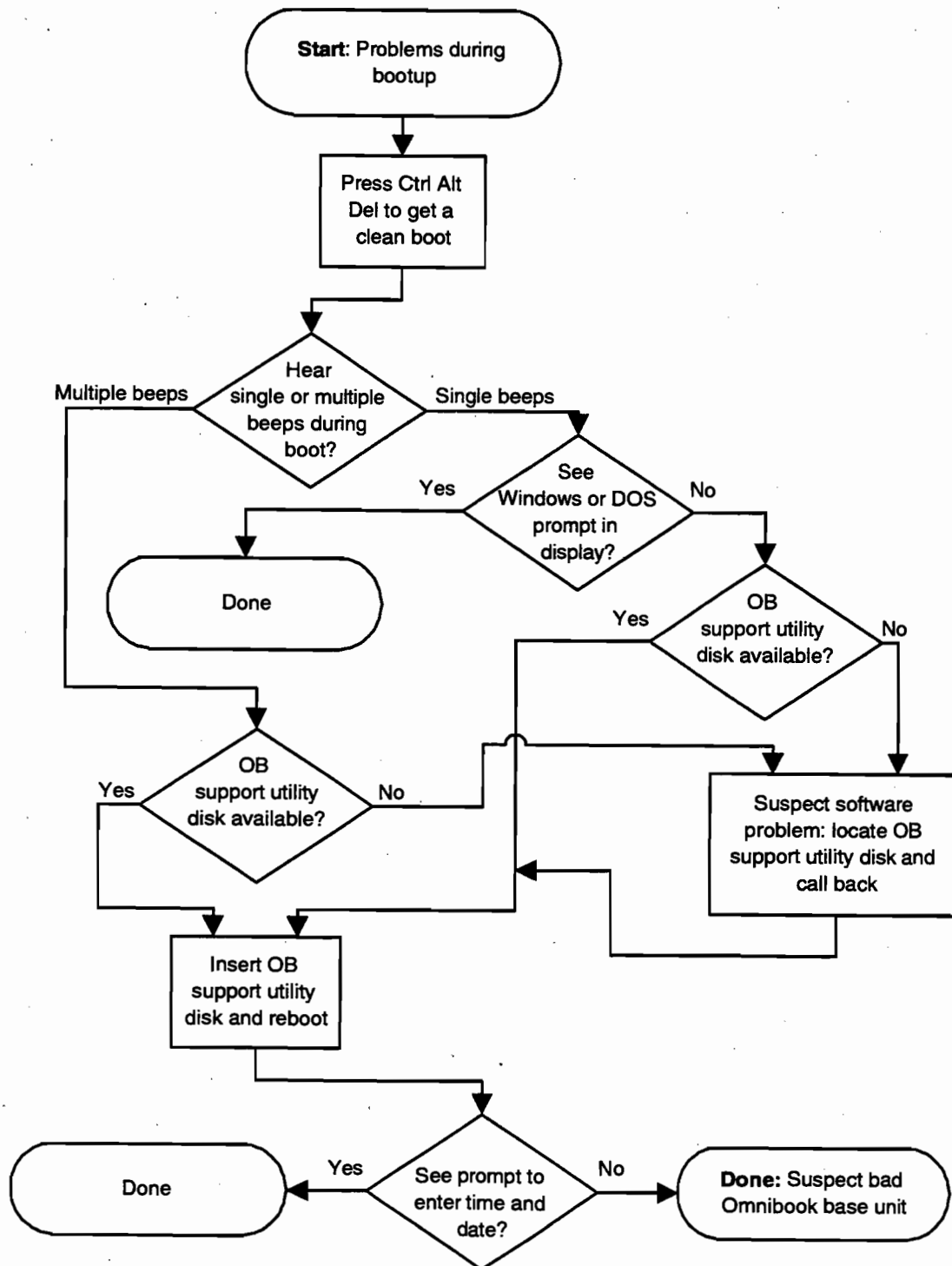

Display Problems

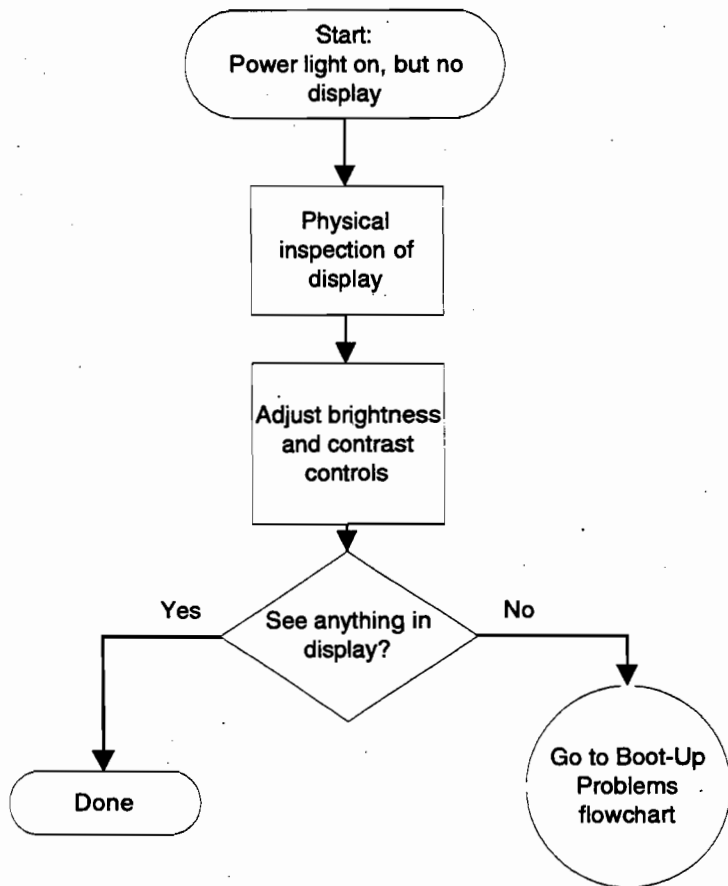

Hard Disk Problems

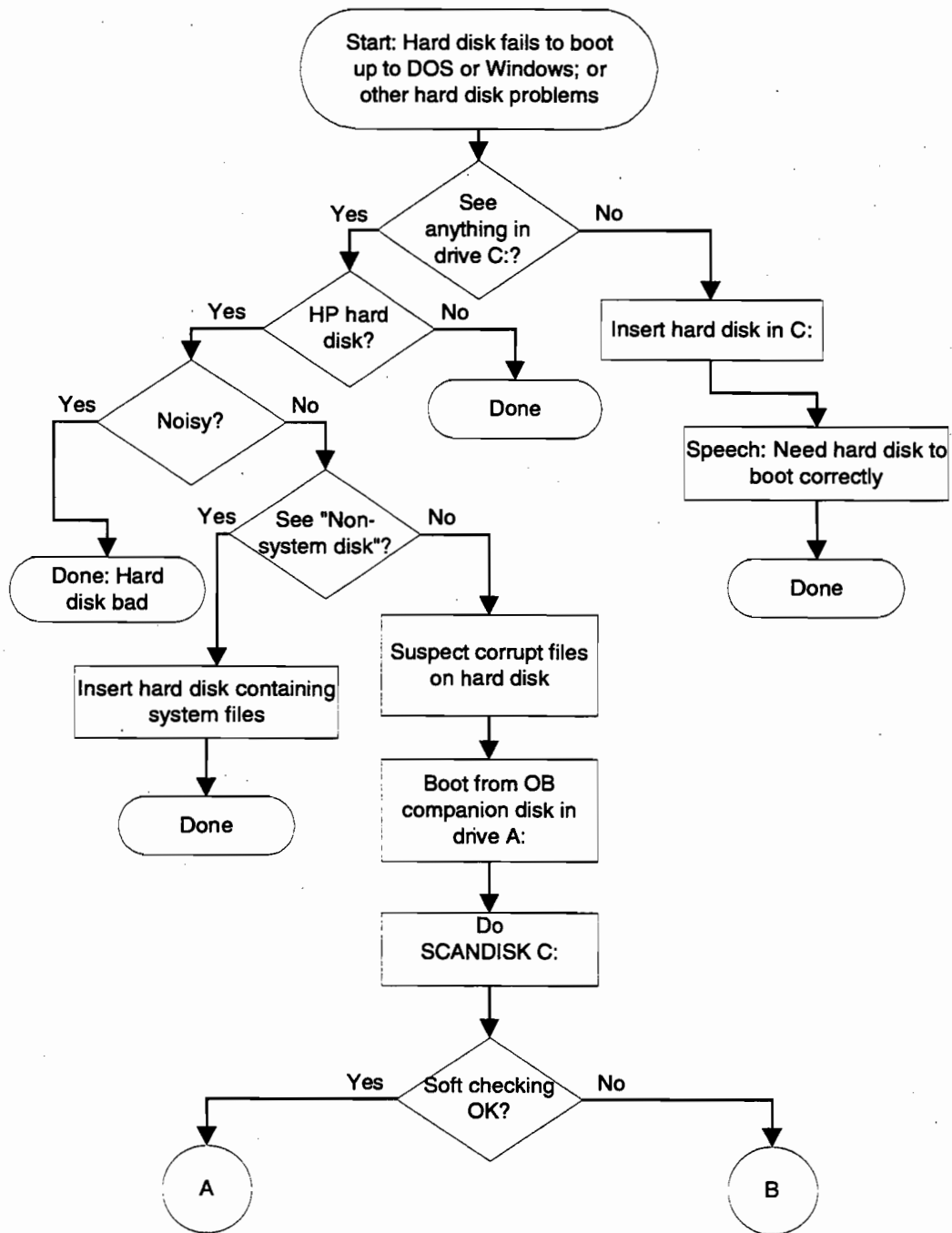

Hard Disk Problems (continued)

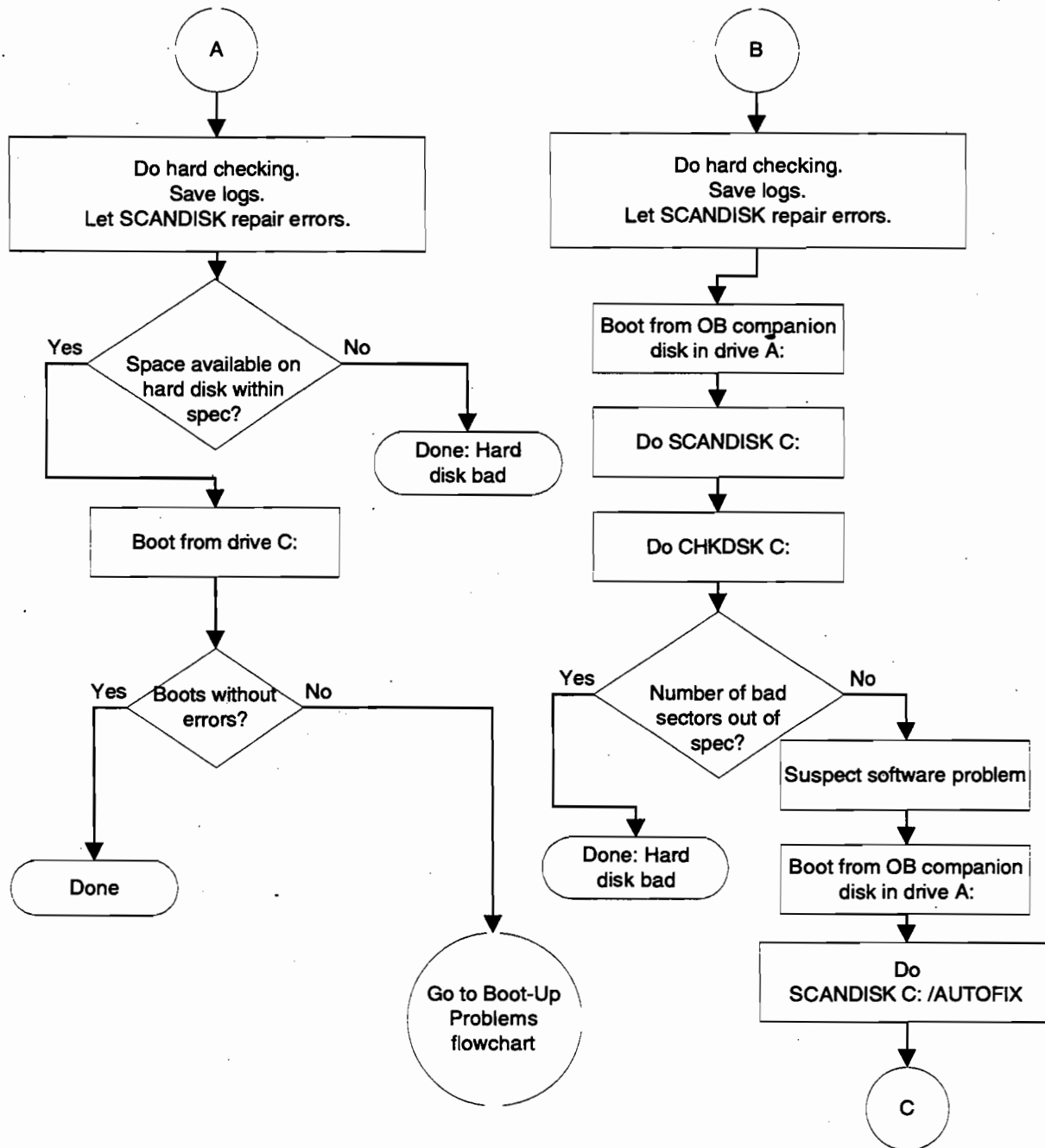

Hard Disk Problems (continued)

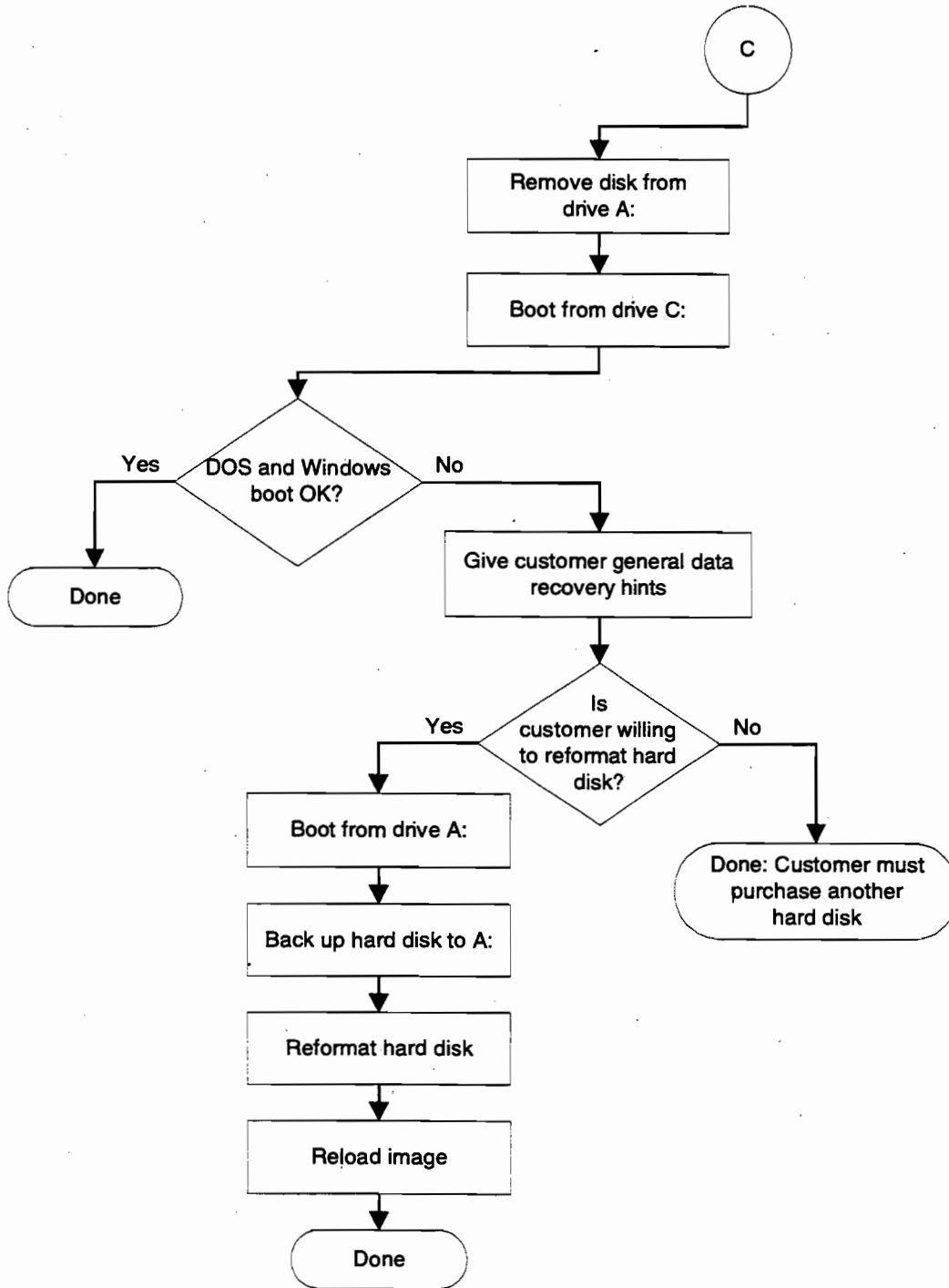

Memory Problems

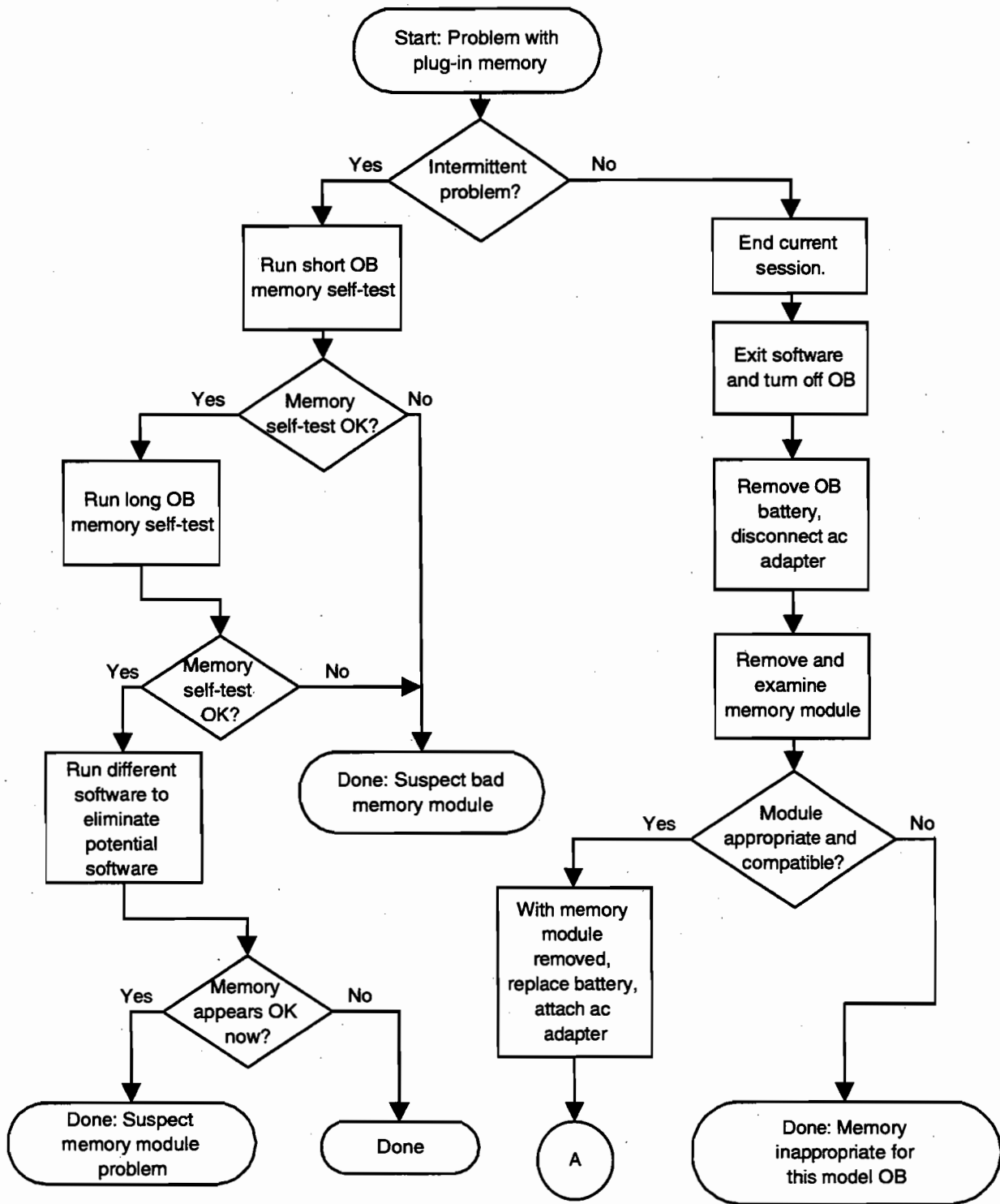

Memory Problems (continued)

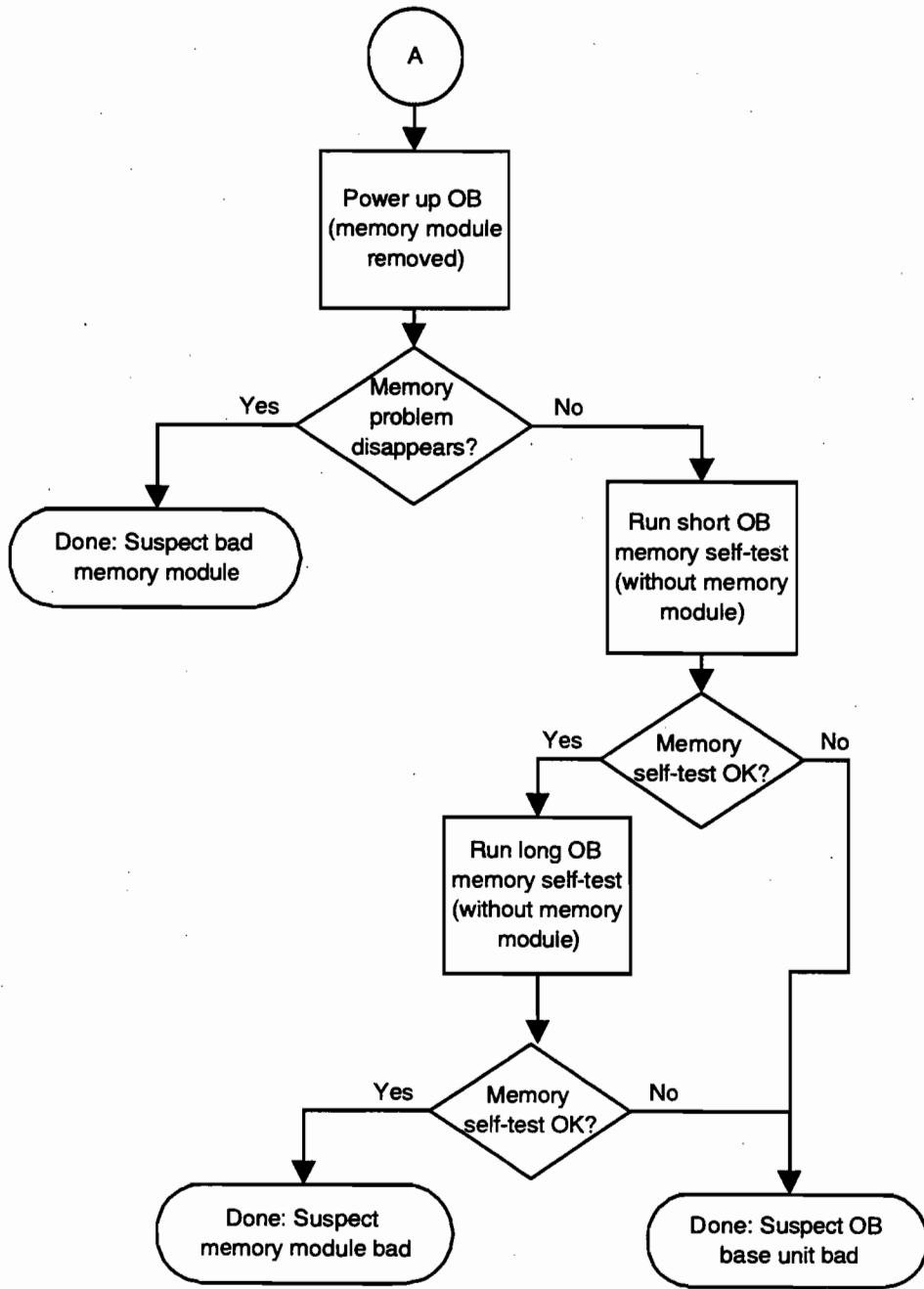

Power Management Problems

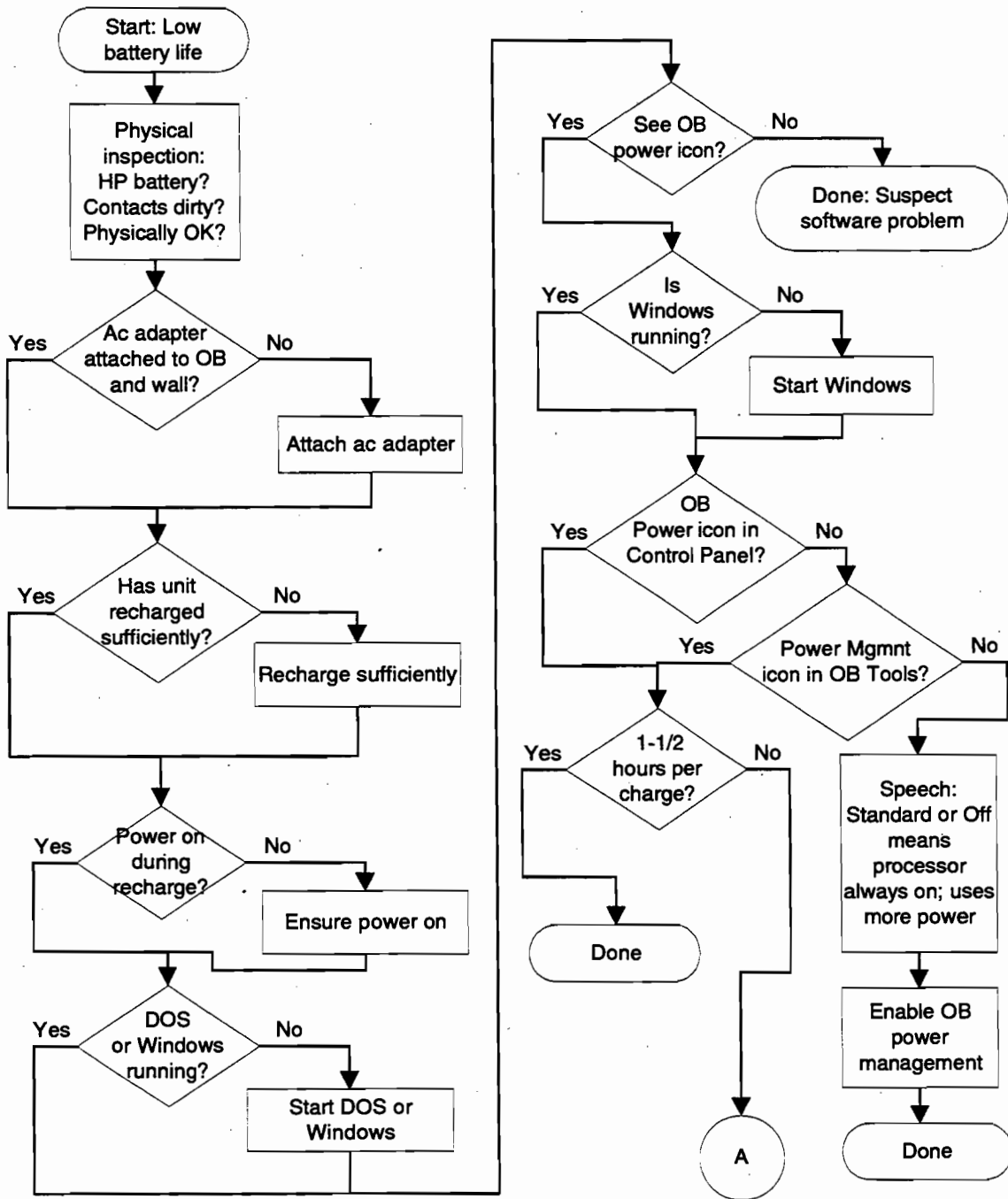

Power Management Problems (continued)

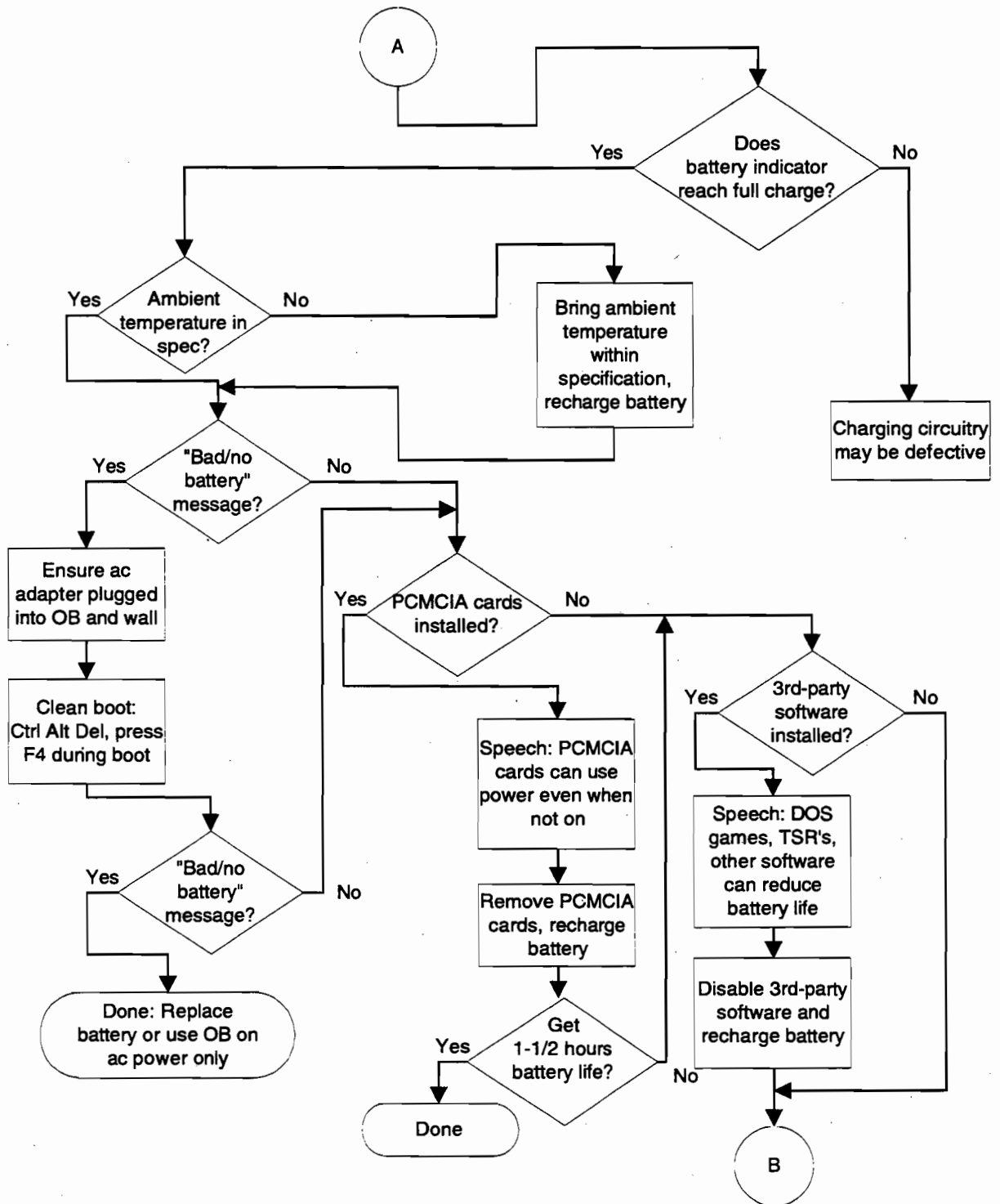

Power Management Problems (continued)

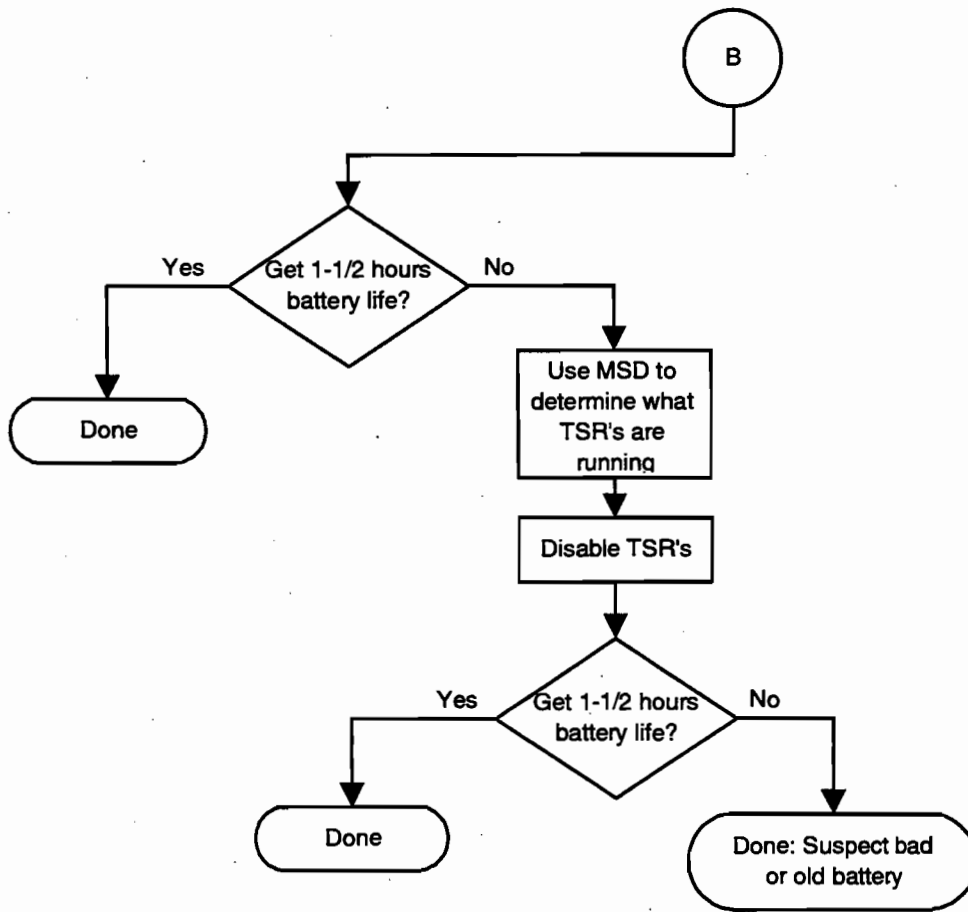

Pop-Out Mouse Problems

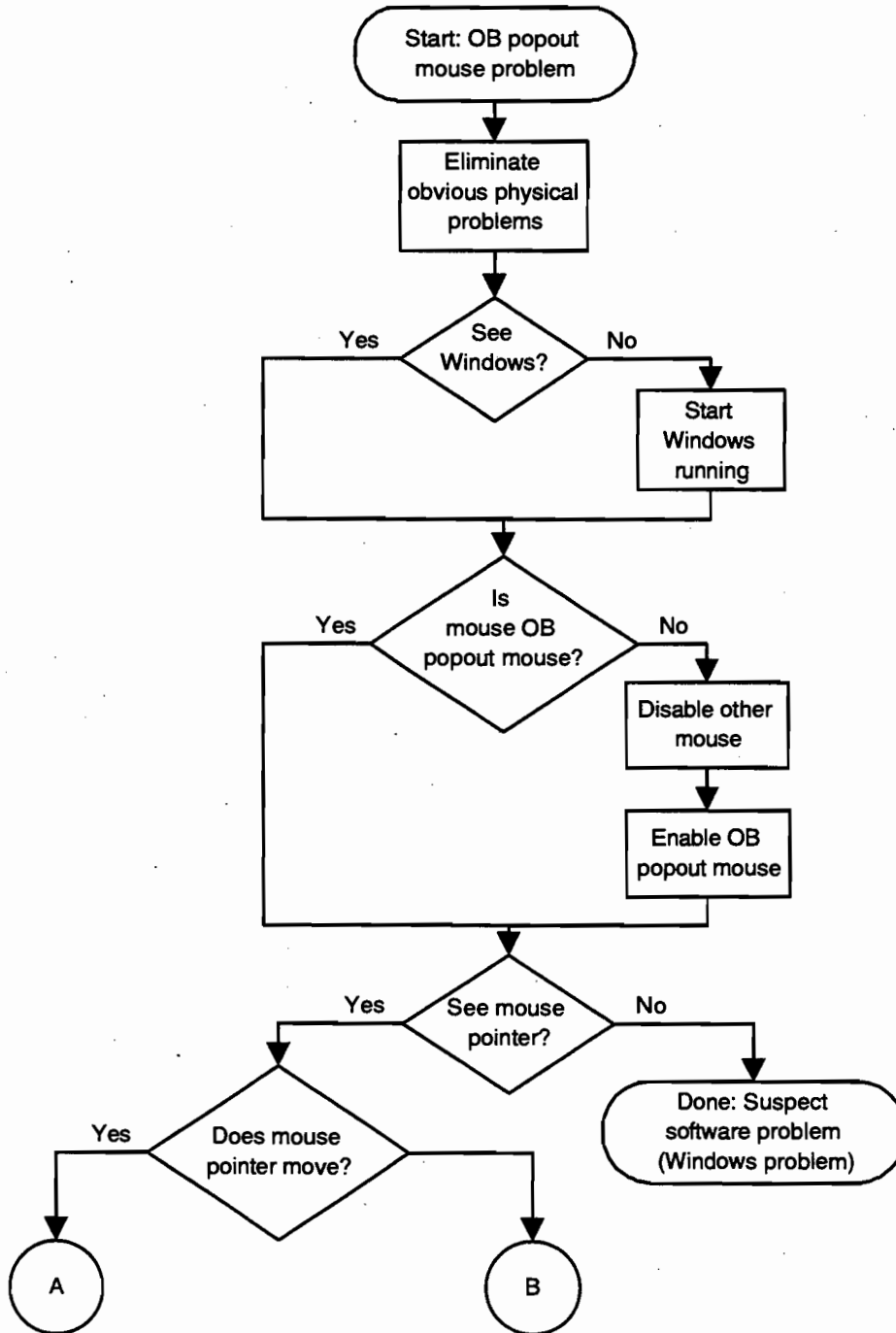

Pop-Out Mouse Problems (continued)

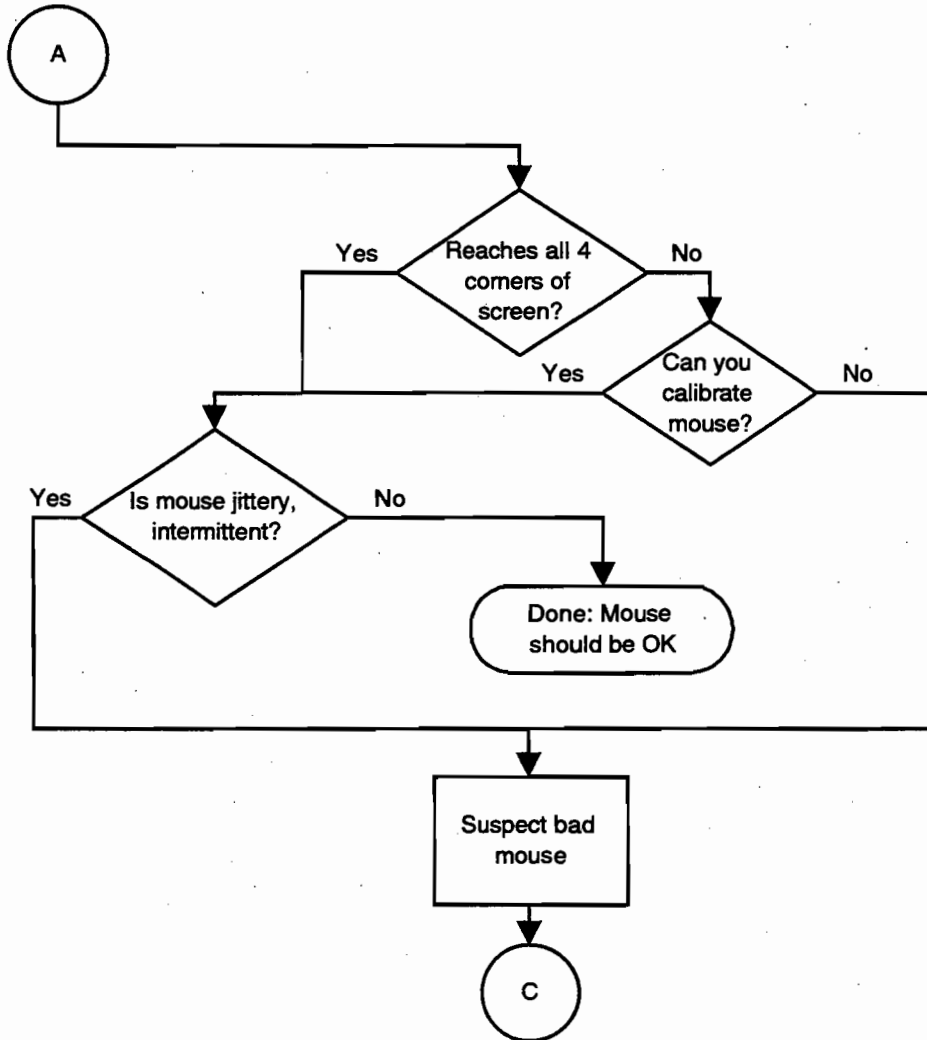

Pop-Out Mouse Problems (continued)

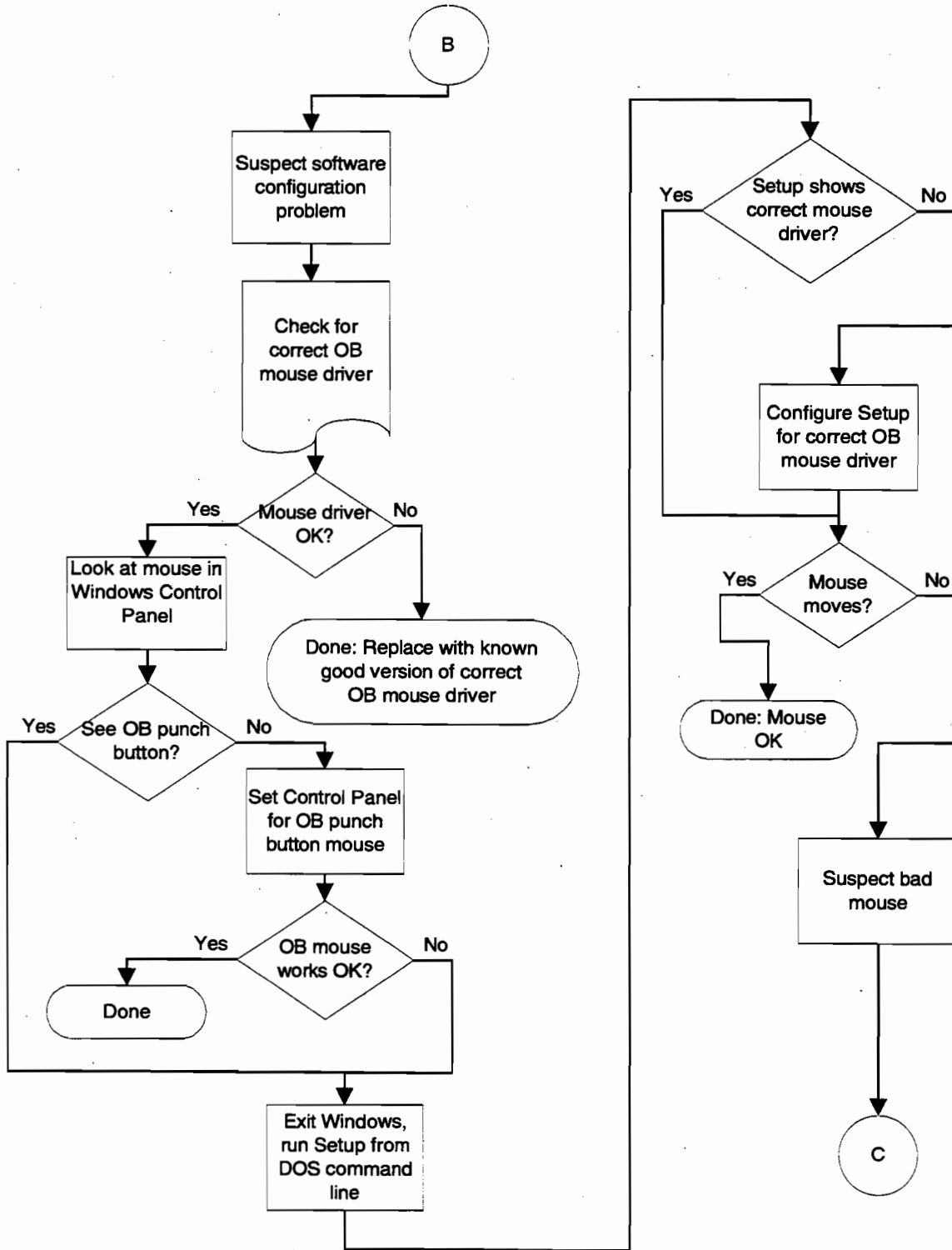

Pop-Out Mouse Problems (continued)

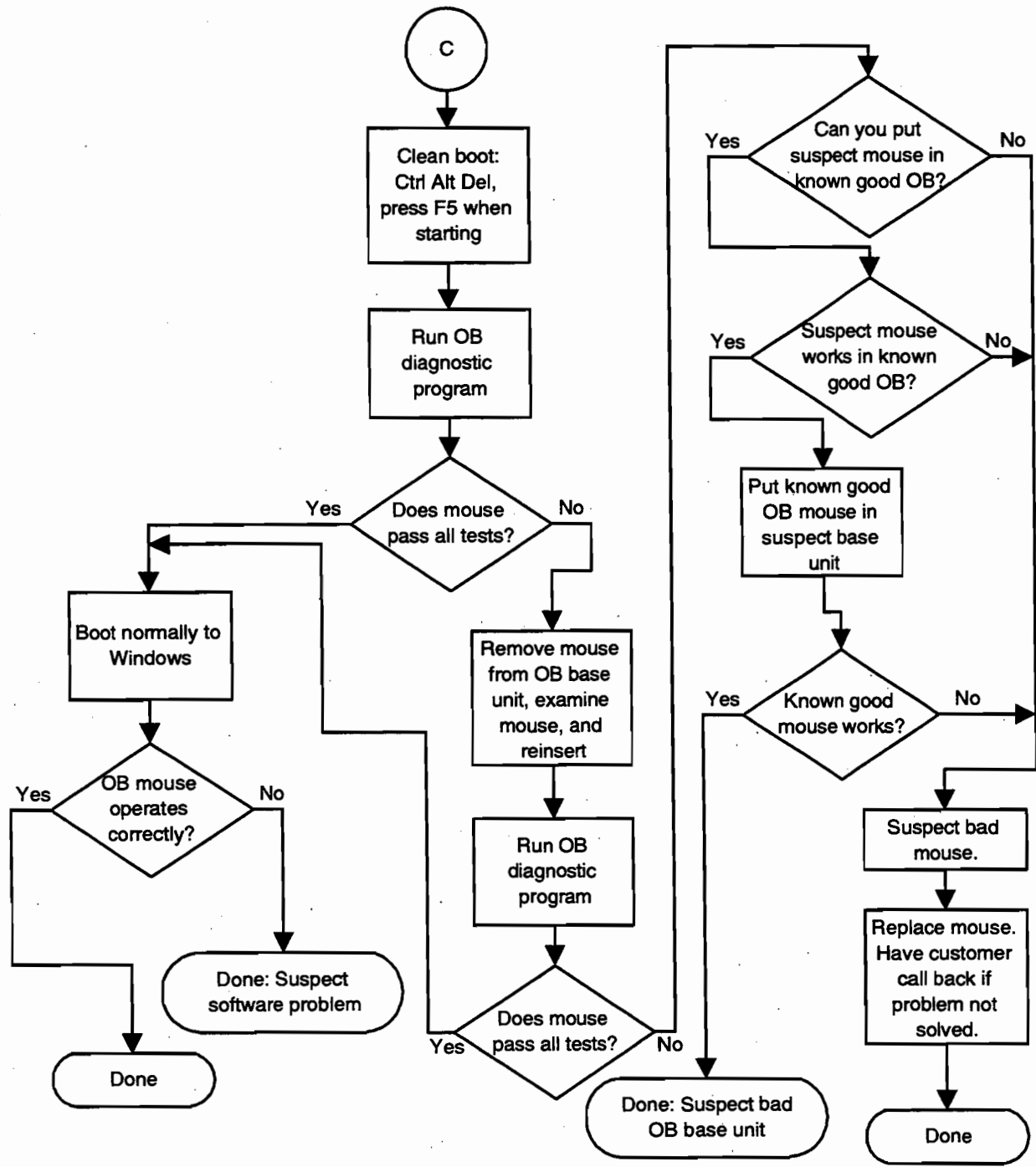

Floppy Drive Problems

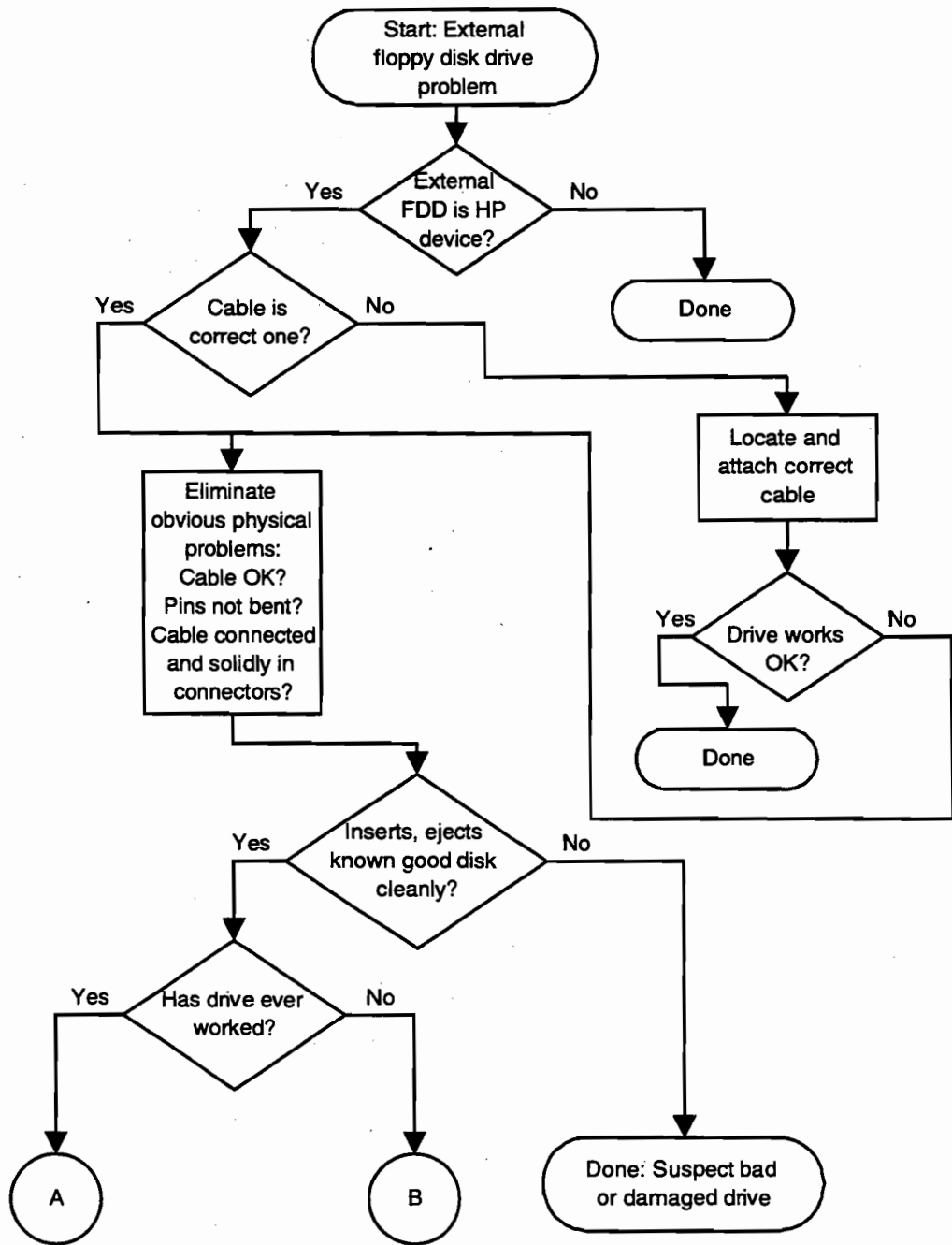

Floppy Drive Problems (continued)

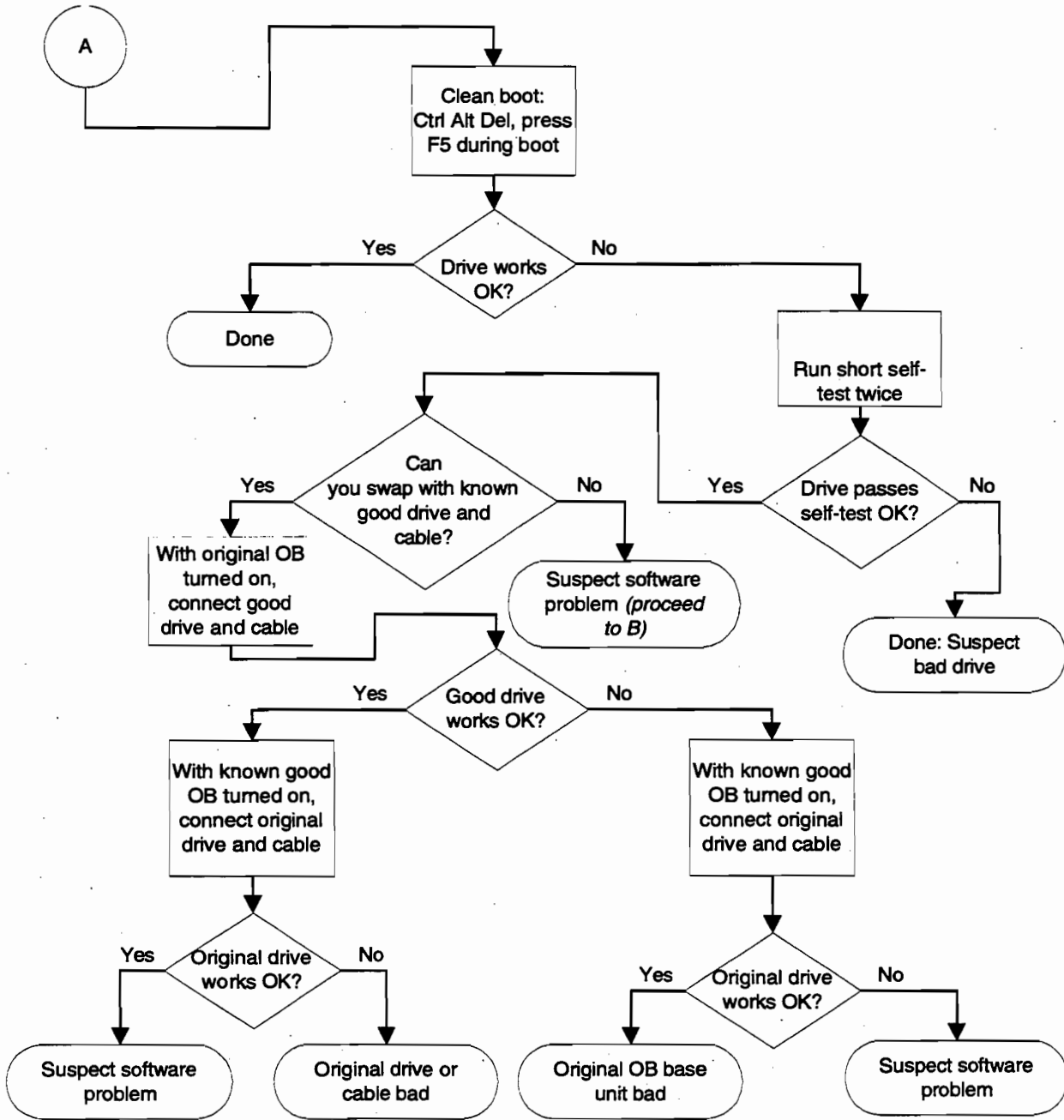

Floppy Drive Problems (continued)

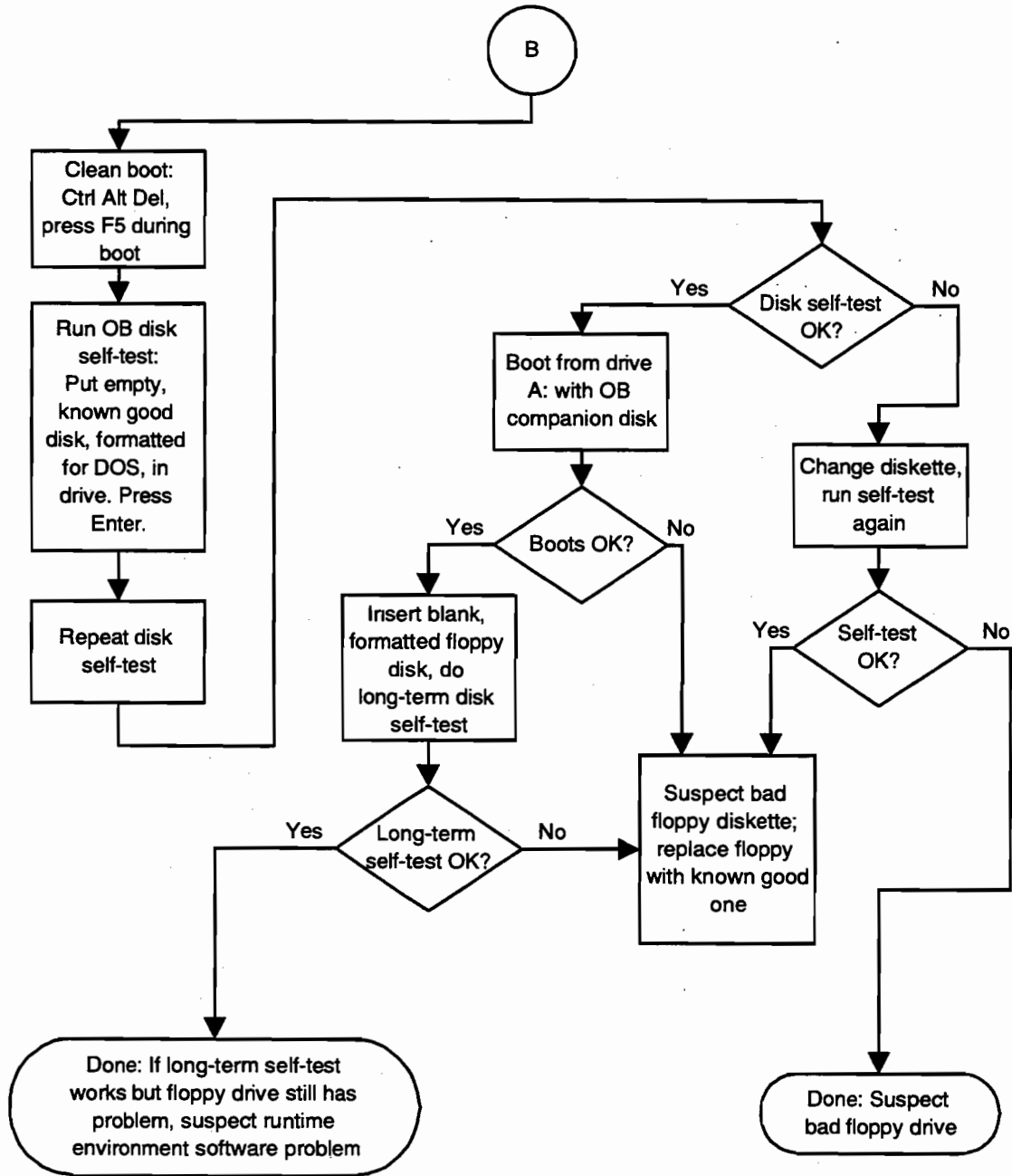

Parallel Port Problems

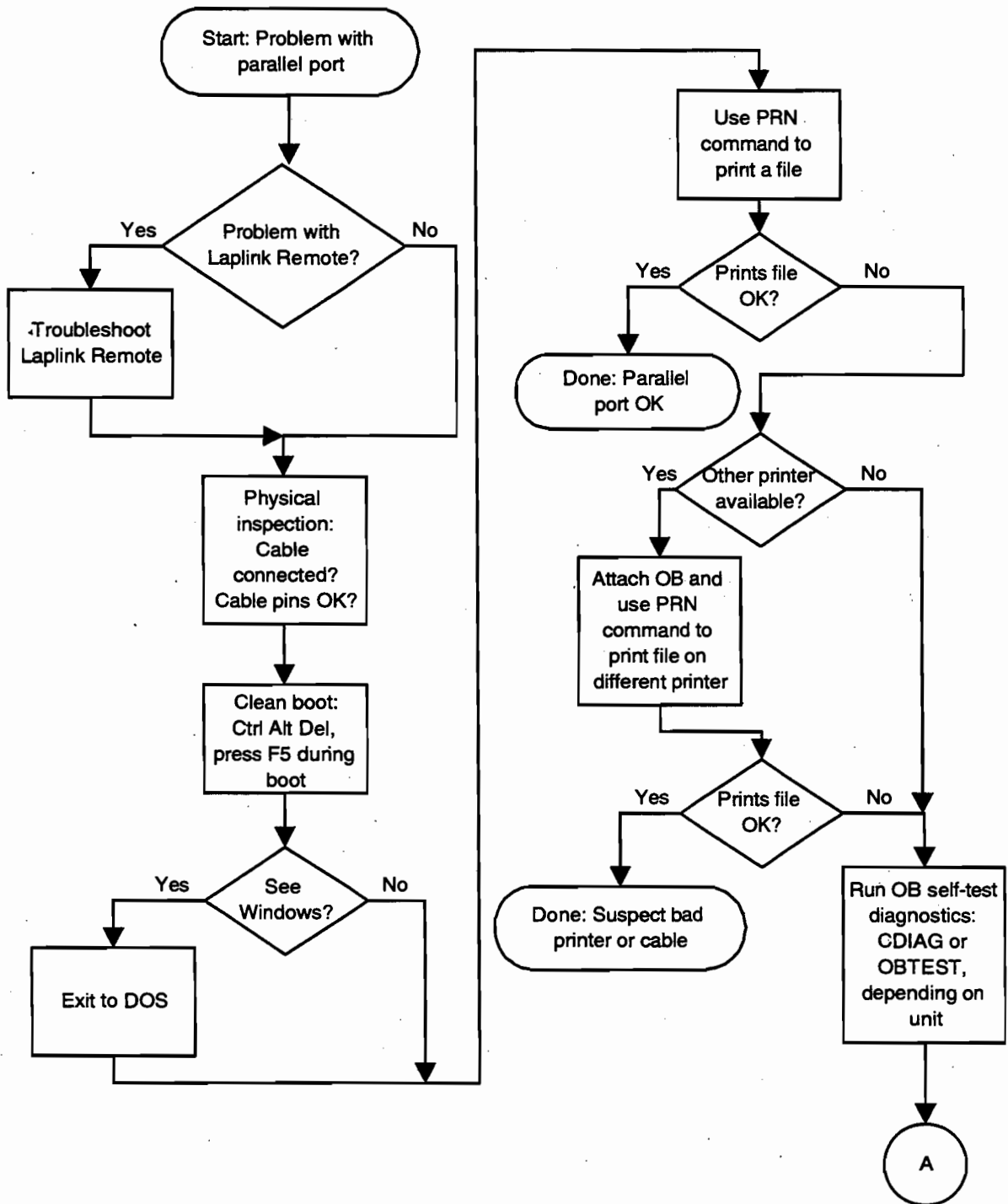

Parallel Port Problems (continued)

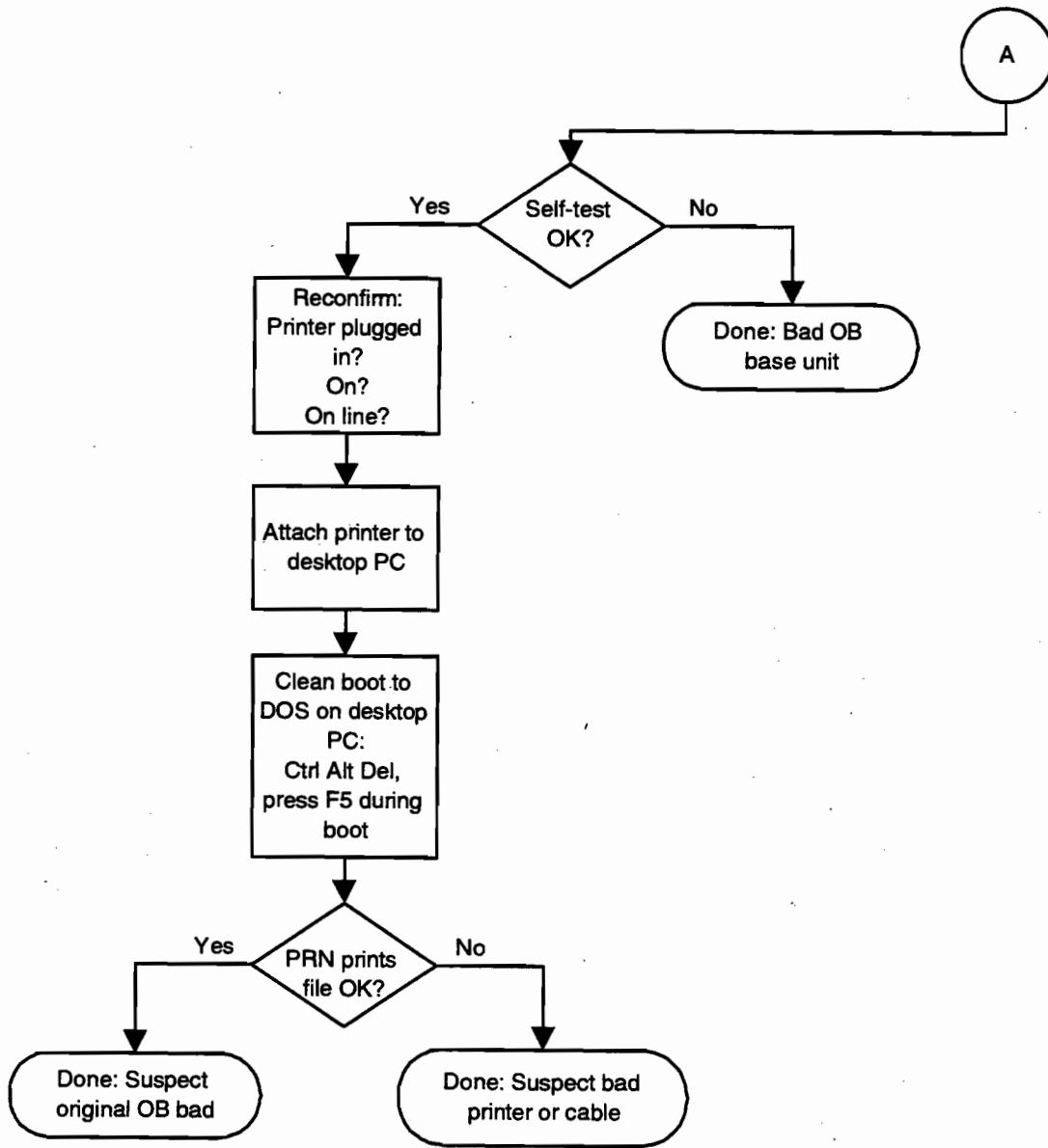

Serial Port Problems

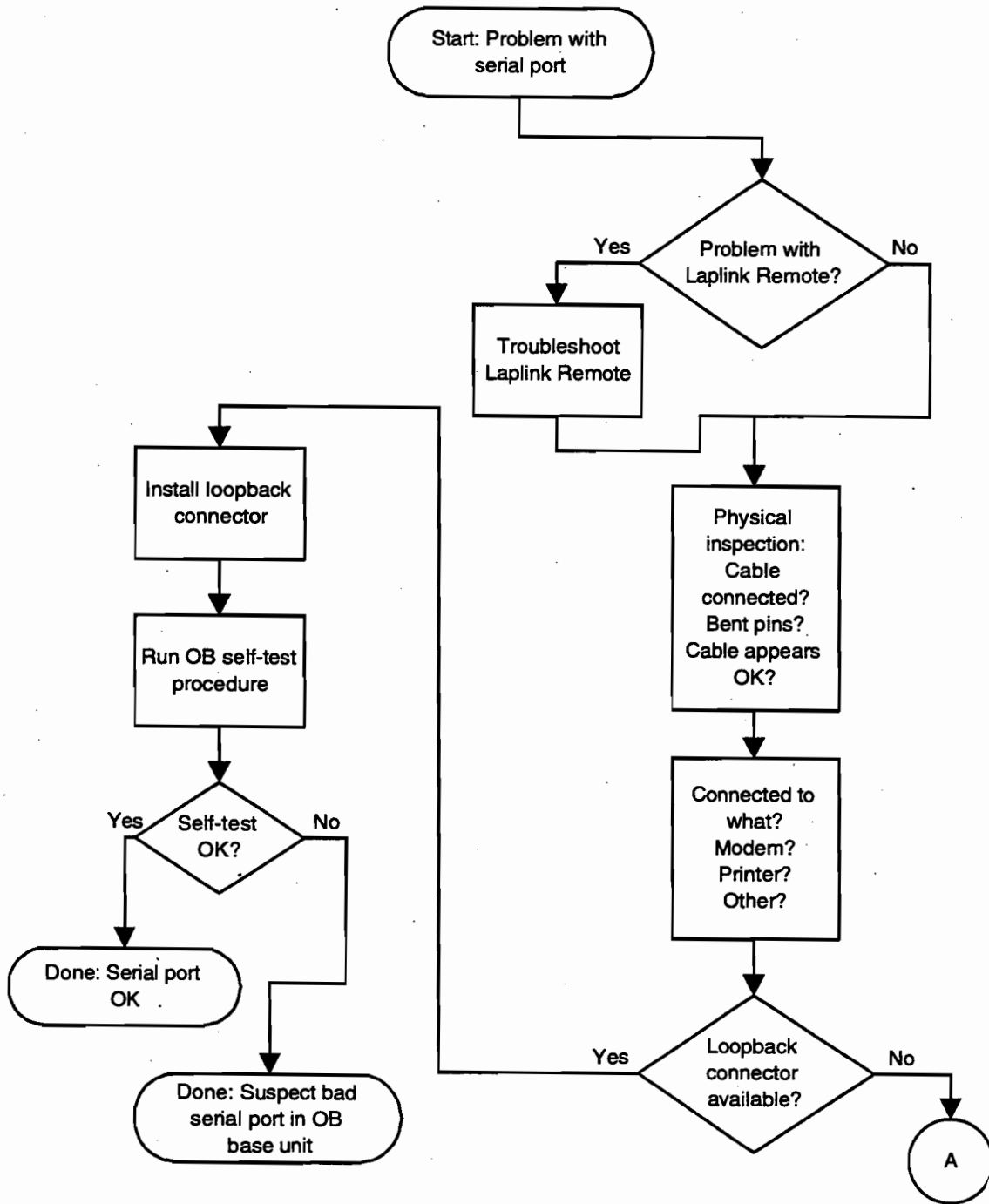

Serial Port Problems (continued)

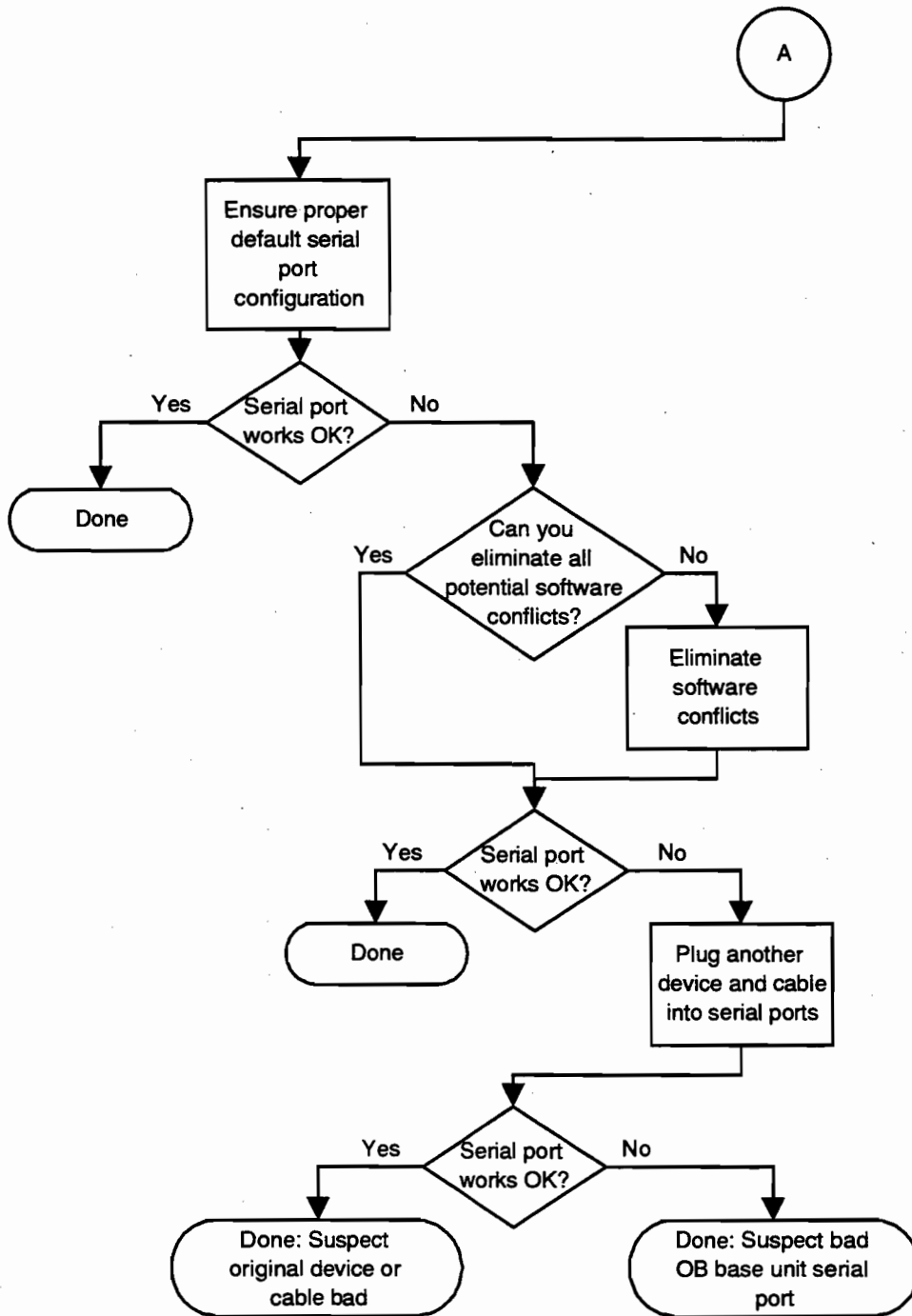

PCMCIA Problems

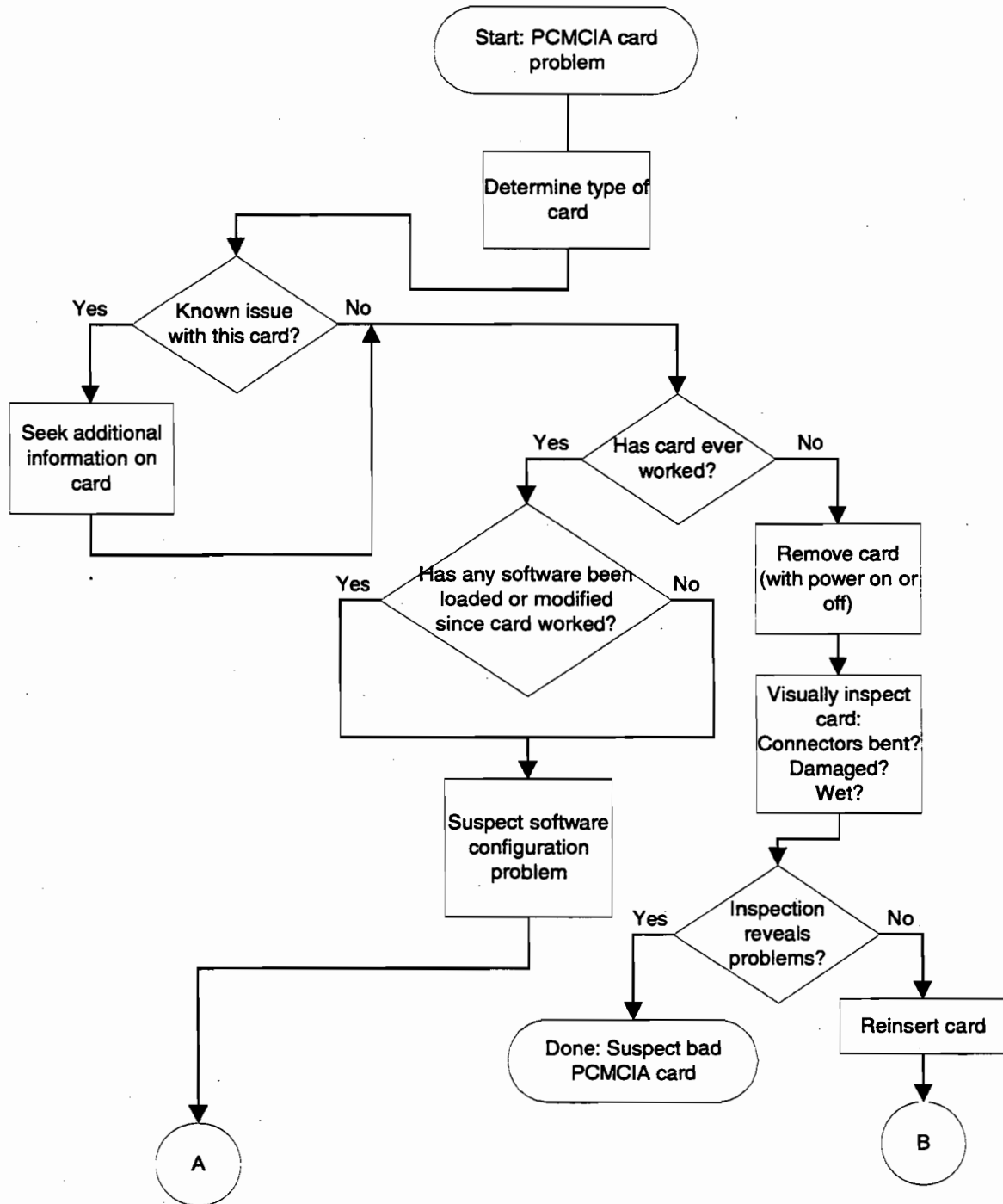

PCMCIA Problems (continued)

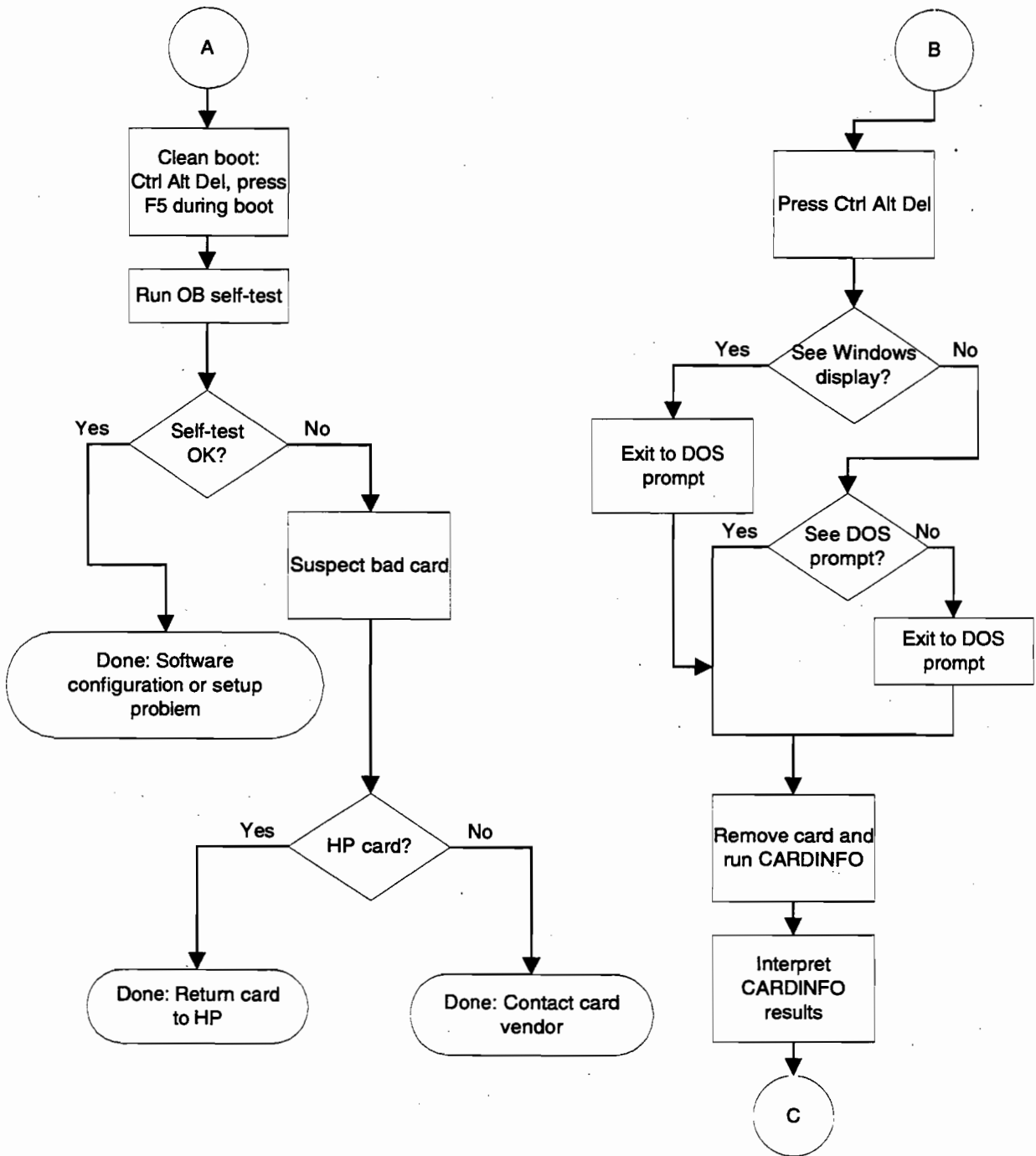

PCMCIA Problems (continued)

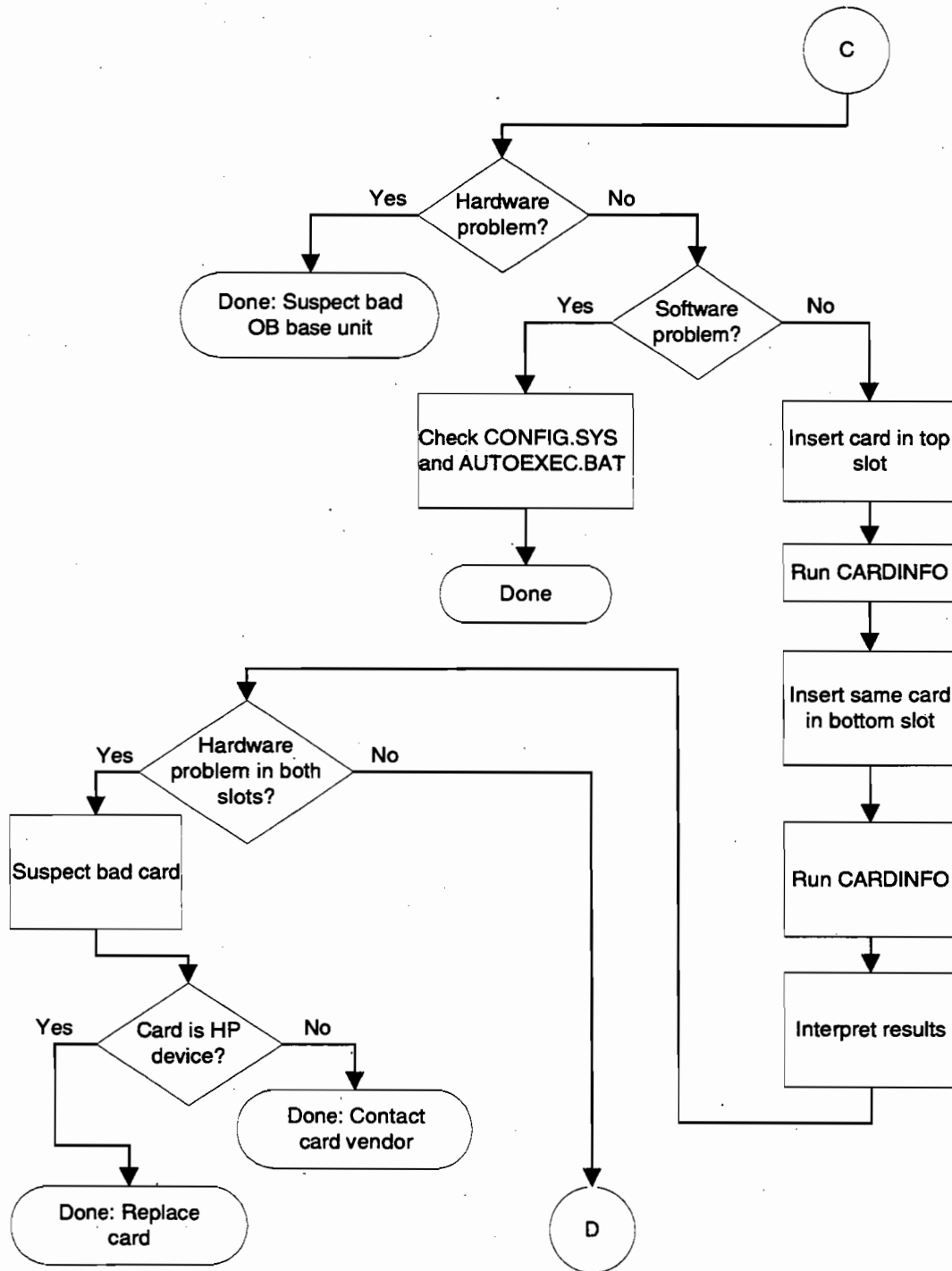

PCMCIA Problems (continued)

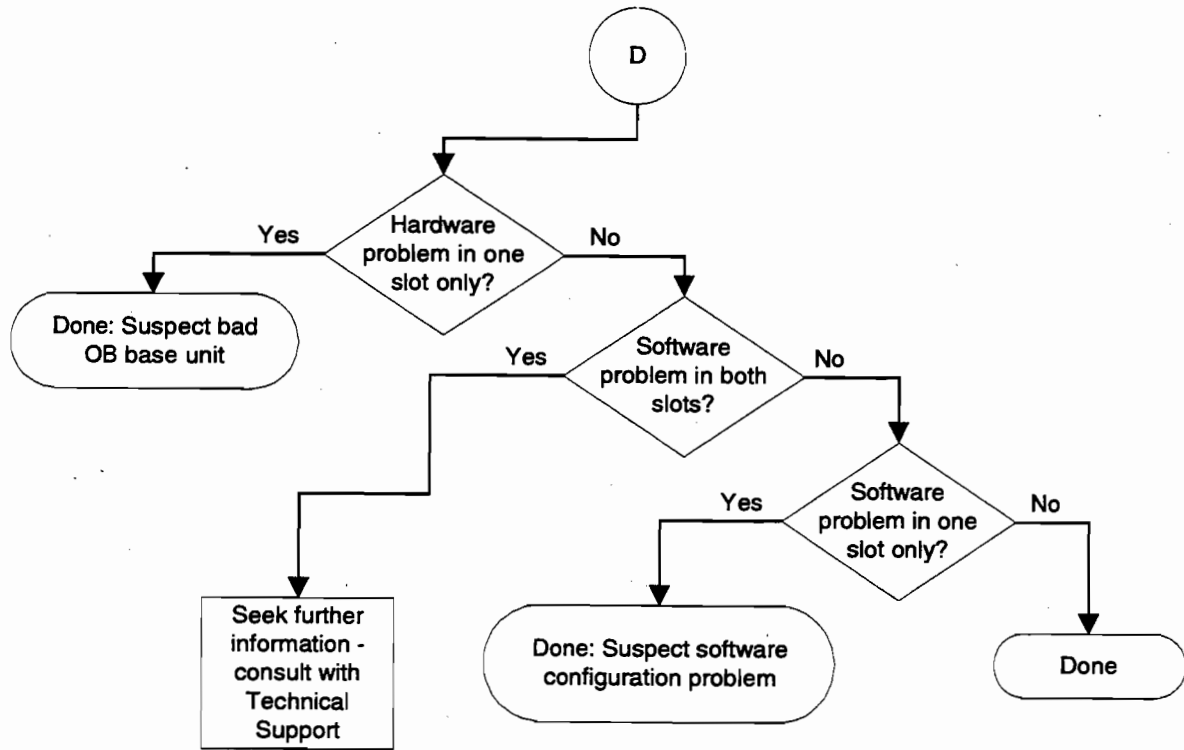

IR Port Problems

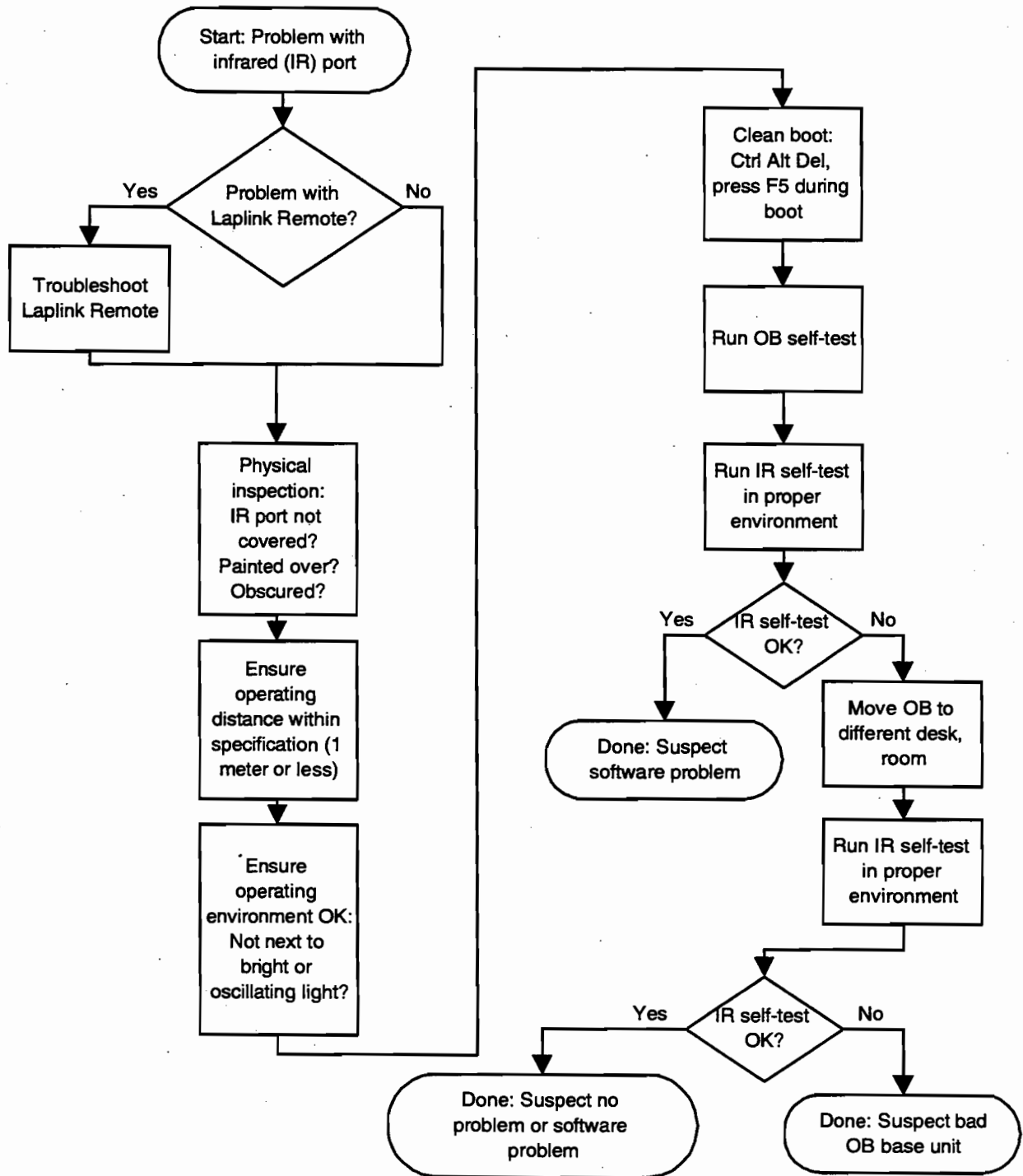

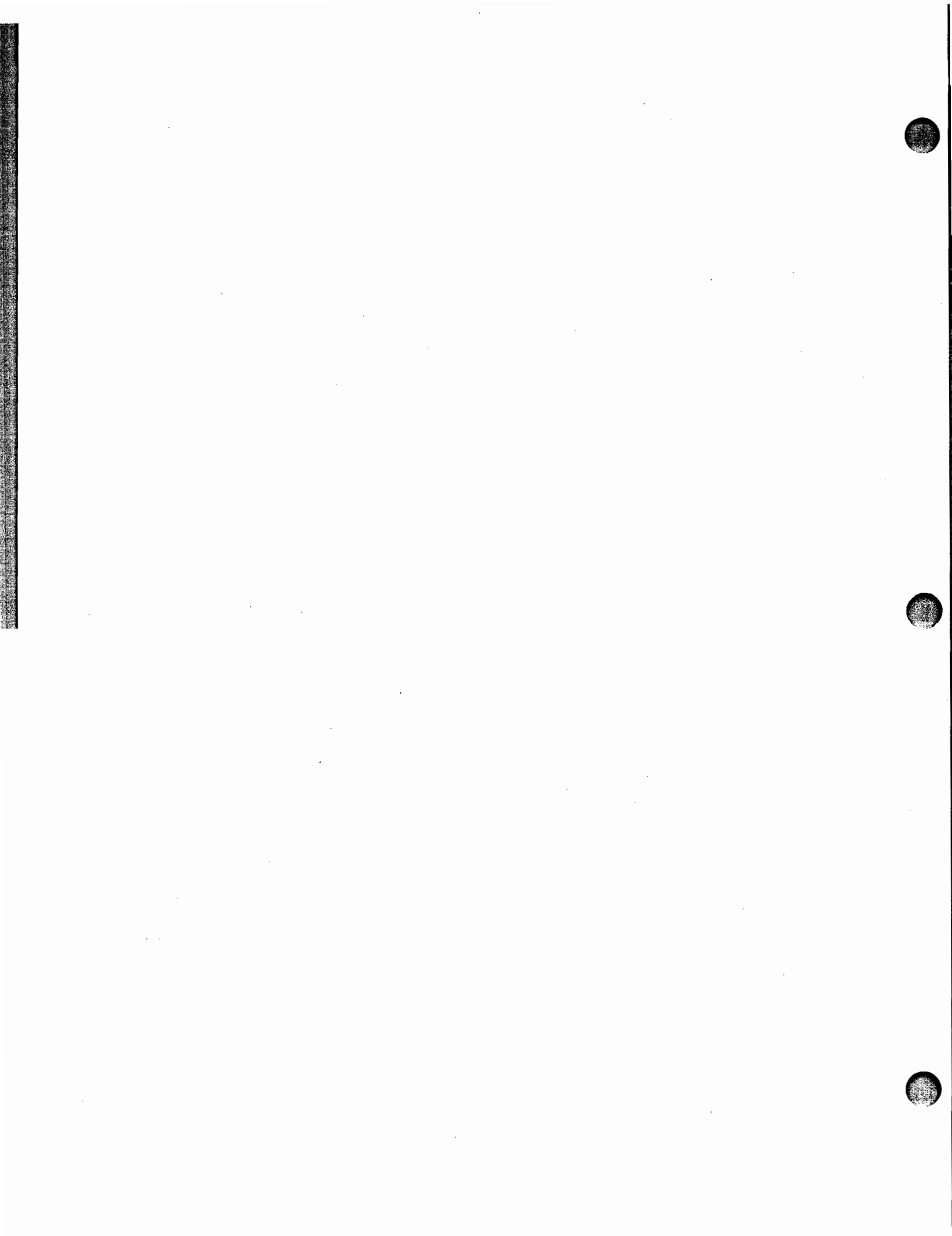

Part 3

Hardware Repair

- Battery
- Memory
- Hard Disk Drive/Flash Card and System ROM
- Mouse
- Small Parts
- Display
- Keyboard
- Logic PCA Board
- Paw Carrier
- Other Components

CAUTION: Always provide proper grounding when performing any of the following repairs. An electrostatic discharge may cause irreparable damage to the OmniBook and its components.

Battery

(End User Replaceable)

All of the monochrome OmniBook models use the same HP Nickel-Metal-Hydride (NiMH) Battery Pack, part number F1045A (service replacement part number F1045-60901). However, for some models, 1.5 V AA batteries can be used in place of the NiMH battery pack. The following table lists all of the monochrome OmniBooks and the batteries that can be used safely in each model.

	OmniBook 300	OmniBook 425	OmniBook 430	OmniBook 530
Flash Disk Version	<ul style="list-style-type: none">• NiMH Battery Pack• AA Alkaline• AA Lithium	<ul style="list-style-type: none">• NiMH Battery Pack• AA Alkaline• AA Lithium	not applicable	not applicable
Hard Disk Version	<ul style="list-style-type: none">• NiMH Battery Pack• AA Lithium	<ul style="list-style-type: none">• NiMH Battery Pack• AA Lithium	<ul style="list-style-type: none">• NiMH Battery Pack• AA Lithium	<ul style="list-style-type: none">• NiMH Battery Pack

WARNING: Do not mutilate, puncture, or dispose of batteries in fire. The batteries can burst or explode, releasing hazardous chemicals.

A nickel-metal-hydride rechargeable battery pack must be recycled or disposed of properly. Recycle or discard used size-AA batteries according to the manufacturer's instructions.

Required Equipment

- none

Removal Procedure

1. Release the two latches on the battery cover on the bottom case, then remove the cover. Refer to the below illustration.
2. Do one of the following to remove the battery:
 - If an OmniBook battery pack is installed, lift it out by its tab.
 - If AA batteries are installed in place of the OmniBook battery pack, lift each out individually.

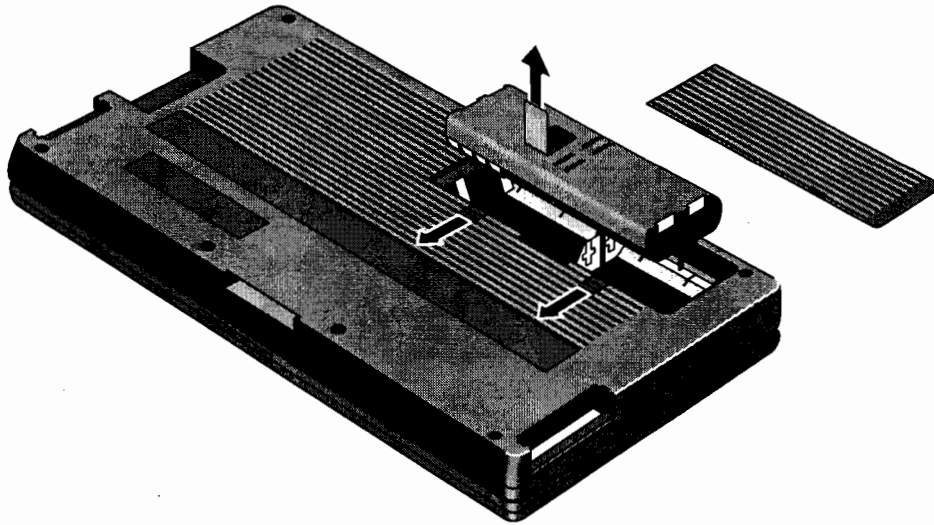

Replacement Procedure

1. To replace the battery, do one of the following:
 - To replace the OmniBook battery pack, insert the rounded side of the pack into the compartment first. It is not possible to fully insert the battery pack incorrectly.
 - To replace AA batteries, orient them as shown by the symbols in the battery compartment.
2. Replace and latch the battery cover.

Memory (End User Replaceable)

The OmniBook 530 uses a unique memory module that is not compatible with the OmniBook 300, 425, or 430. The table below summarizes the compatibility of the memory modules for each OmniBook model.

Memory Module	Accessory Number	Service Replacement	OB 300	OB 425	OB 430	OB 530
2-MB	F1041A	F1041-60901	✓	✓	✓	
4-MB	F1042A	F1038-60901	✓	✓	✓	
4-MB	F1054A	F1054-60901				✓
8-MB	F1055B	F1055-60002				✓

The following illustration provides a visual representation of the physical differences between the memory module for the OmniBook 300, 425, and 430 and the memory module for the OmniBook 530.

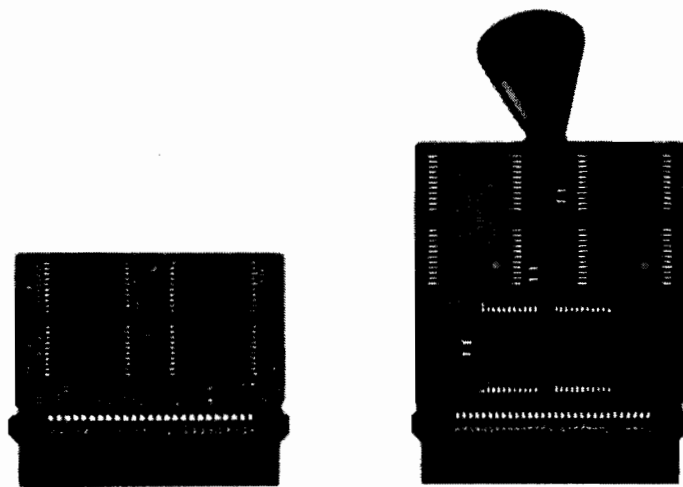

OmniBook 300, 425, and 430

OmniBook 530

Figure 5 - OmniBook Memory Modules

Required Equipment

- Probe (or similar device) for the OmniBook 300, 425, and 430 only

CAUTION: To avoid damage due to electrostatic discharge, handle the memory module by the edges only.

Removal Procedure

1. Remove the battery and ac adapter from the OmniBook.
2. Slide the memory door off (see below illustration).

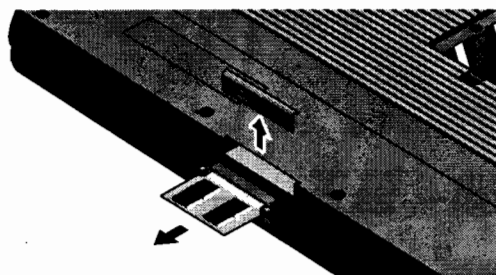

Figure 6 - Removing the Memory Module

3. Perform the appropriate action for the corresponding OmniBook:
 - OmniBook 300, 425, or 430 -- Use a probe or similar device to pull on the small post located on the front edge of the memory module.
 - OmniBook 530 -- Flip out the plastic tab on the memory module and pull the module out.

Replacement Procedure

1. Insert the memory module into the slot. (It is *not* possible to completely insert the memory if it is upside down.)
 - OmniBook 300, 425, 430 -- the small post on the board faces the bottom surface of the OmniBook.
 - OmniBook 530 -- the plastic tab on the board faces the bottom surface of the OmniBook.
2. Press in the module until it seats fully.
3. Replace the slot cover.
4. Replace the battery and press reset.

Hard Disk Drive/Flash Card and System ROM (End User Replaceable)

The Hard Disk Drives for the OmniBook 300, 425, 430, and 530 can be reimaged if necessary. If the software is corrupted, or otherwise damaged, on the hard drive, it can be reformatted and the software reloaded. Also, if the hard drive fails and must be replaced, a blank hard drive can be ordered and the appropriate software loaded. The below procedures indicate the proper actions necessary for reloading software on each OmniBook model.

For the OmniBook 300 and 425:

1. Place the hard drive into the OmniBook.
2. Reformat the hard drive.
3. Run OBSETUP /F from the System ROM to reload the software onto the hard drive.

For the OmniBook 430:

1. Place the hard drive into the OmniBook.
2. Reboot and press Alt then D to boot from the System ROM.
3. Reformat the hard drive.
4. Reload the software image from a set of OmniBook 430 Recovery Disks. The Recovery Disks are available on the HP Internal WW Web at <http://webmcd.cv.hp.com/prodsupp/archive/>.

For the OmniBook 530:

1. Place the hard drive into the OmniBook.
2. Boot from the Companion Disk or other bootable floppy disk.
3. Reformat the hard drive.
4. Reload the software image from a set of OmniBook 530 Recovery Disks. The Recovery Disks are available on the HP Internal WW Web at <http://webmcd.cv.hp.com/prodsupp/archive/>.

Required Equipment

- none

Removal Procedure

1. Exit all applications, including Windows.
2. Turn the OmniBook off and remove the battery and ac adapter.
3. Turn the OmniBook over, release the two latches on the bottom of the tray, and pull out the tray. See below illustration.

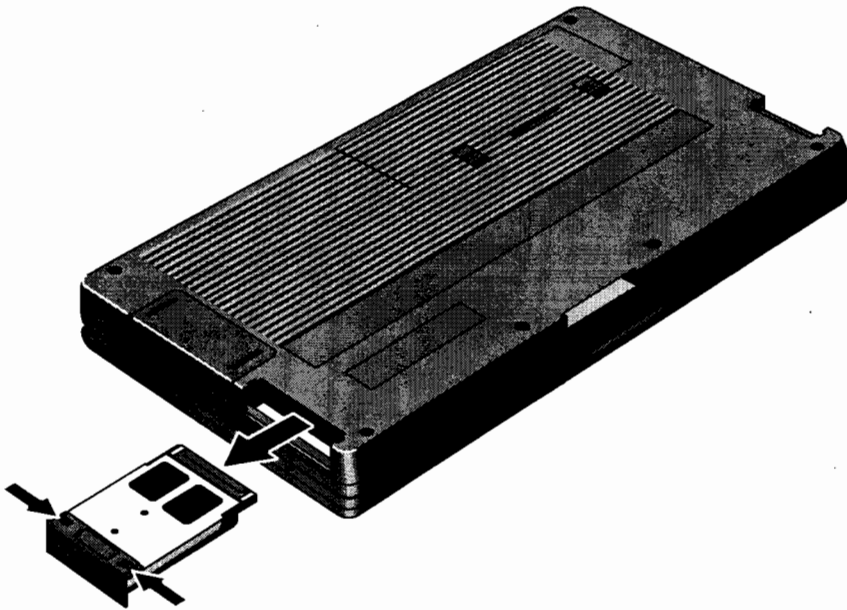

Figure 7 - Removing Card Slot Tray

4. Lift the Hard Disk, Flash Card, or System ROM out of the tray.

Replacement Procedure

1. Reverse the above steps to replace the Hard Disk, Flash Card, or System ROM.
2. Replace the battery and ac adapter.
3. Press reset.

Mouse

(End User Replaceable)

Required Equipment

- none

Removal Procedure

1. Press the mouse-eject button to eject the mouse.
2. Pull the mouse firmly away from the OmniBook (see below illustration). The entire mouse assembly will pull free.

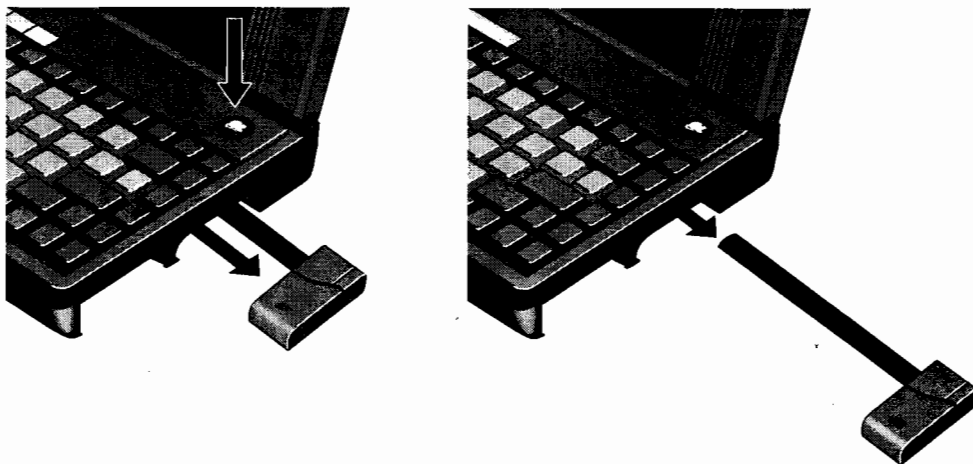

Figure 8 - Removing the Mouse

Replacement Procedure

1. Place the end of the mouse "stick" into the mouse housing.
2. Slide the mouse into the slot and firmly push the mouse until it is completely flush with the side of the OmniBook.

Small Parts

(End User Replaceable)

The following small parts are all end user replaceable.

Battery Door

Push the two battery door latches away from the battery door. Remove the battery door by lifting up at the notch in the bottom case. Place the battery door, tab side first, over the battery compartment. Slide the two battery latches in place to secure the door.

Battery Door Latch

Once the battery door is removed (see above), the battery door latches will slide out of the bottom case. To replace, align the sides of the latches with the groves in the slots. Press firmly into place.

Blank Modem Door

Use a flat-blade screwdriver or similar device to press the small latch on the bottom of the blank modem door. Pull the door free of the bottom case. To replace, simply reinsert the door into the modem slot and press firmly.

Memory Door

Use a flat-blade screwdriver or similar device to pry the memory door from the bottom case. Replace by aligning the edges of the door with the slots on the bottom case. Press firmly into place.

I/O Door

To remove the I/O door, open it fully. Flex the middle of the door until the side pins clear the holes in the back case. Reverse to replace.

Rubber Feet

Place a probe or similar device between the rubber foot and the plastic of the bottom case. Pry upward to pop the foot out. To replace, firmly press the foot into the hole.

PCMCIA Card Tray

Slide the two tray latches toward each other. Pull the tray out of the card slot. If present, remove the PCMCIA card from the tray. To replace the tray, insert into the appropriate card slot. Slide the two latches away from each other to secure the tray.

Display

(HP Authorized Service Providers Only)

Required Equipment

- Appropriate ESD station
- Torx #6 screwdriver
- 5mm Hexdriver
- Two small flat tip screwdrivers (or similar prying devices)
- Probe

Removal Procedure

1. Remove the battery, ac adapter, mass storage, system card (if applicable), memory module (if installed), modem (if installed), mouse, and any installed PCMCIA accessory cards.
2. Remove the four Rubber Feet and seven Screws from the bottom case (see below illustration).

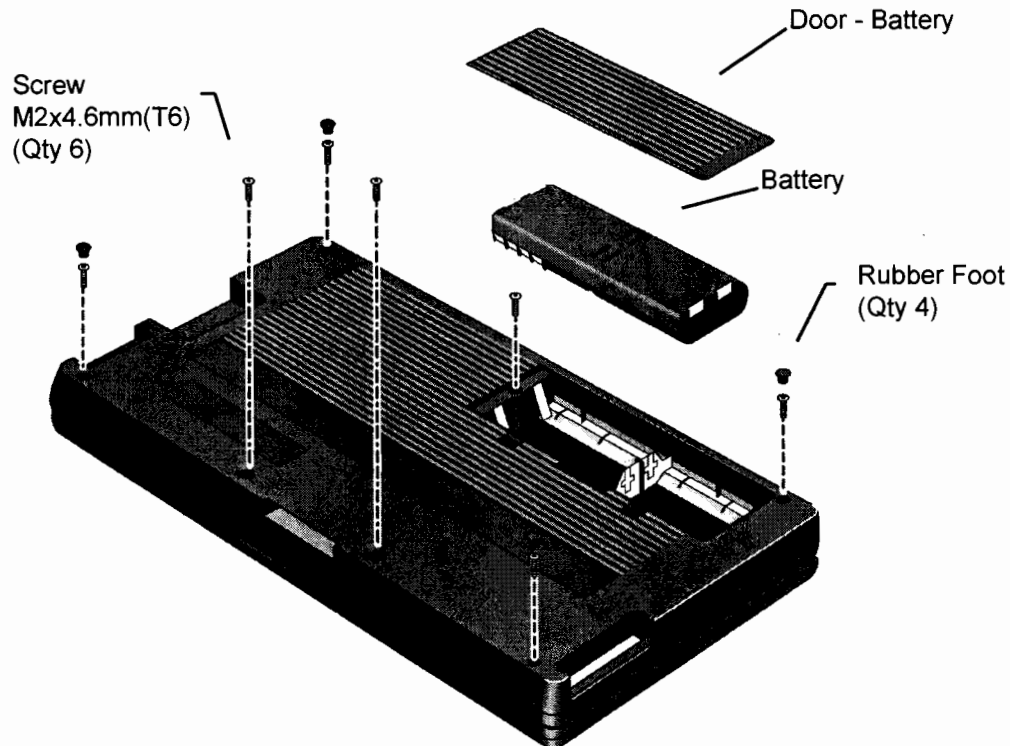

Figure 9 - Outer Bottom Case Components

-
3. Remove the I/O Door and the four standoffs located on the I/O backplane (see figure below).

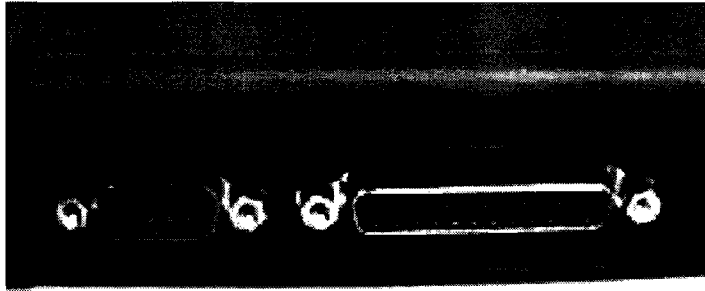

Figure 10 - Backplane Standoffs



4. Two flat tip screwdrivers, or similar prying devices, are needed to remove the Top Case and Display Assemblies. Four plastic tabs hold the Top Case and Bottom Case together. Two tabs are located in each PCMCIA slot (see below illustration). Note, the screws seen in the PCMCIA slot do *not* need to be removed.

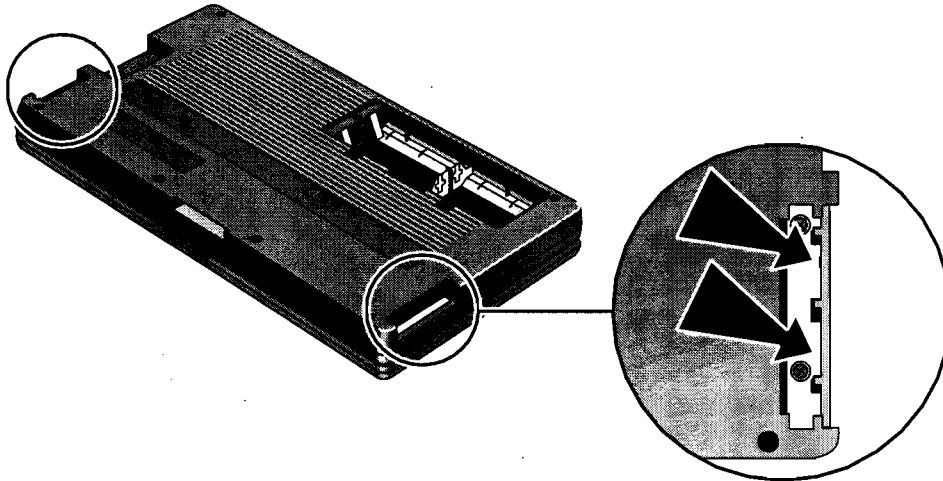

Figure 11 - Bottom Case Tabs

Place a prying device at a tab location between the metal and plastic of the Bottom Case (see figure below, left). Place another prying device in the PCMCIA eject button (see figure below, right). To release the tab, simultaneously twist prying device A while lifting on prying device B. **Use caution with this maneuver, as the plastic tabs can break off the Bottom Case. If this occurs, the Bottom Case must be replaced.**

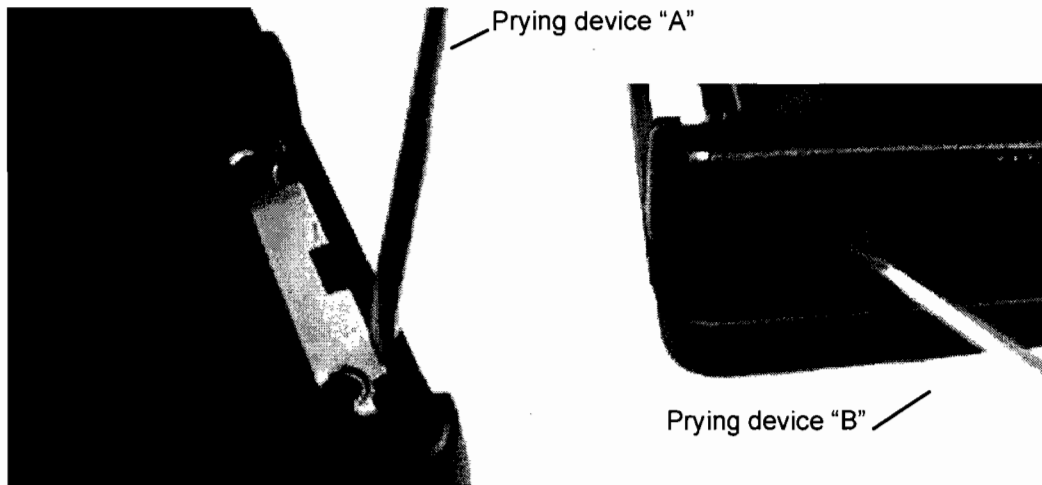

Figure 12 - Bottom Case Prying Locations

5. Perform step four for each of the four tabs.
6. Once the Bottom Case tabs are released, the Bottom Case and Top Case are being held together only by the display cable and the two keyboard cables. **Do not allow the Top Case and Bottom Case to separate at this point. The display cable and keyboard cables will be damaged if they are not properly disconnected.**
7. Use a prying device to increase the separation of the Top Case and Bottom Case (see figure below). **Do not separate the Top Case and Bottom Case more than 1 cm. A separation greater than 1 cm will damage the keyboard flex cables by pulling them out of the zero-force insertion connectors.** The intent is to be able to view the display cable, located to the left of the ac adapter socket.

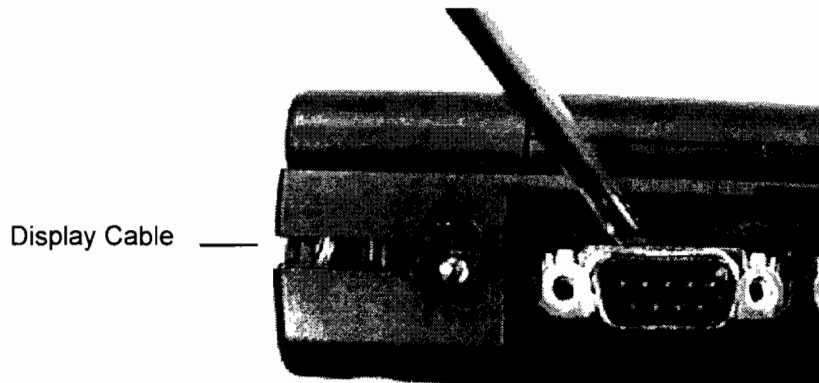

Figure 13 - I/O Port Prying Location

-
8. With the separation increased slightly, the display cable can be disconnected using a probe. **Use caution to keep the OmniBook on a level surface. With the Top Case partially separated, small internal parts may dislodge when the OmniBook is tilted at a sharp angle.** Place the probe at the base of the display cable connector between the two rows of pins. Use a rocking motion to lift the cable from the connector. See the below illustration for proper placement of the probe.

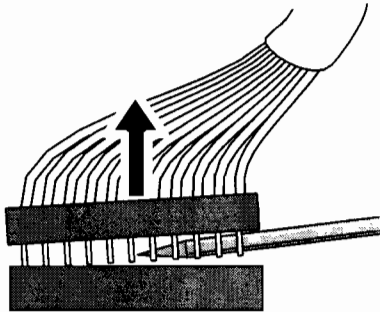

Figure 14 - Disconnecting Display Cable

9. With the display cable removed, the Top Case and Bottom Case can be opened partially to gain access to the keyboard flex cables (see below illustration). **Do not open the unit completely as this will damage the keyboard flex cables by pulling them out of the zero-force insertion connectors.** Open the zero-force insertion connectors and remove the keyboard flex cables. The Top Case can now be removed completely from the Bottom Case.

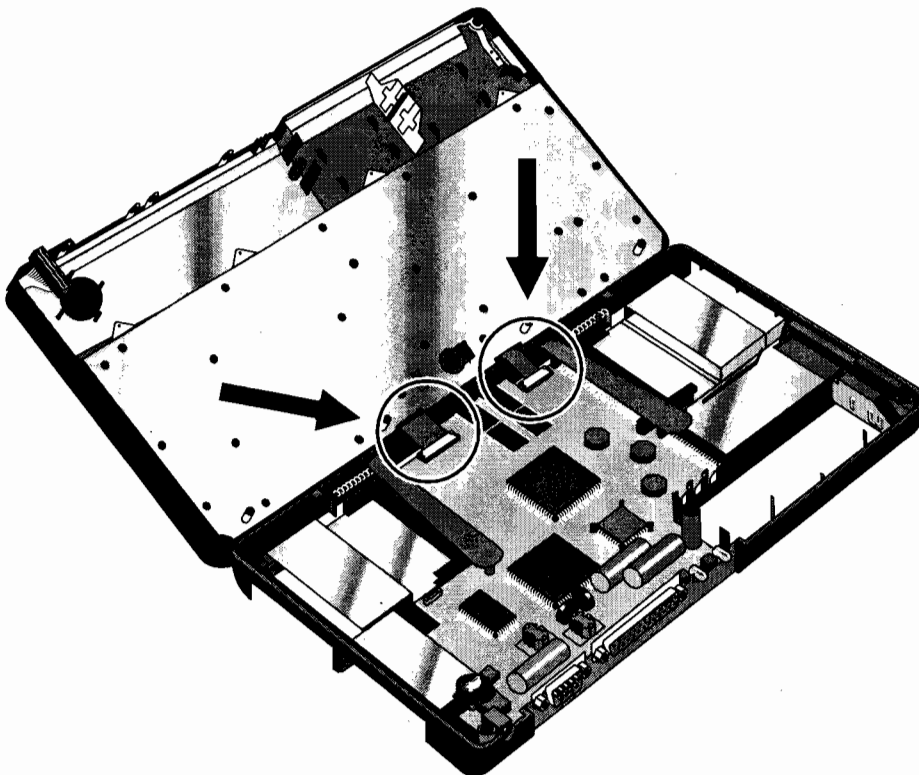

Figure 15 - Keyboard Flex Cables

-
10. To separate the Keyboard from the Display, five grounding eyelets must be removed from the display posts (see below illustration). **Use caution when removing the grounding eyelets, as they can be broken off easily. If this happens, the assembly must be replaced.** To prevent the eyelets from breaking, bend the grounding eyelet tabs at the farthest point from the eyelet.

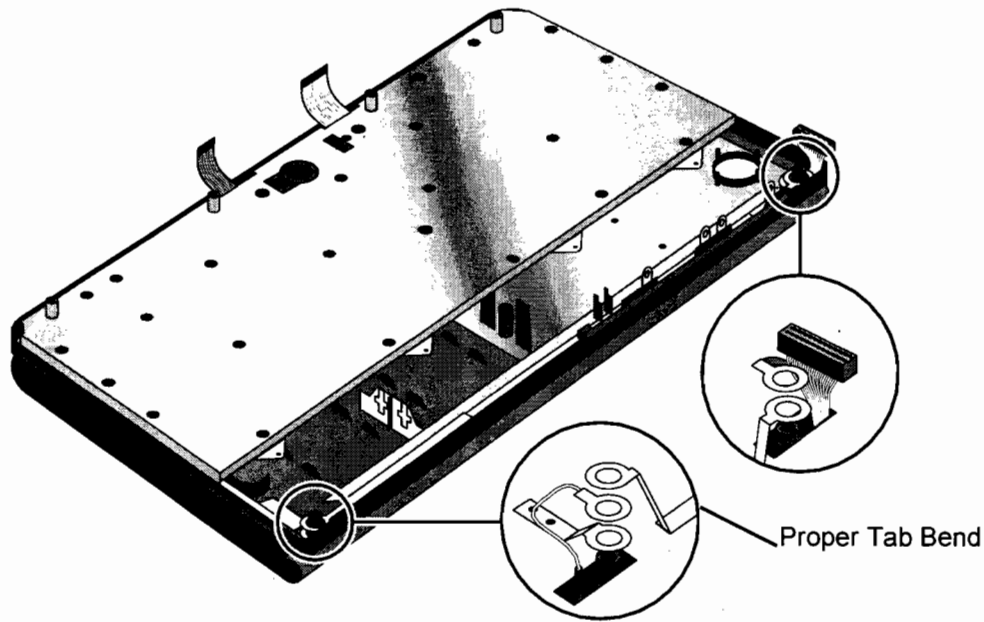

Figure 16 - Display Grounding Eyelets

11. To remove the Display from the Top Case, the display cable and two grounding cables must be guided through the holes in the Top Case.

Replacement Procedure

1. Guide the display posts, display cable and two grounding cables on the Display through the holes in the Top Case.
2. Replace the grounding eyelets over the display posts (see Figure 16). **Use caution when replacing the grounding eyelets, as they can be broken off easily. If this happens, the assembly must be replaced.**
3. Press the Display and Top Case firmly at each display post to snap the assembly in place.
4. Position the Top Case and Display Assembly over the Bottom Case and insert the two keyboard flex cables into the zero-force insertion connectors. Ensure the connectors are fully closed. **Once the keyboard flex cables are secured in the connectors, do not allow them to be pulled out. This will damage the cables.**

-
5. To reconnect the display cable, position a probe in the cable as shown in the below illustration.

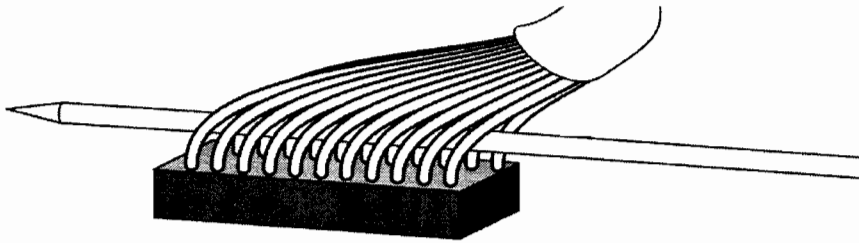

Figure 17 - Display Cable Probe Position

6. Use the probe to connect the display cable into the connector as shown below. **Use caution to keep the OmniBook on a level surface. With the Top Case partially separated, small internal parts may dislodge when the OmniBook is tilted at a sharp angle.**

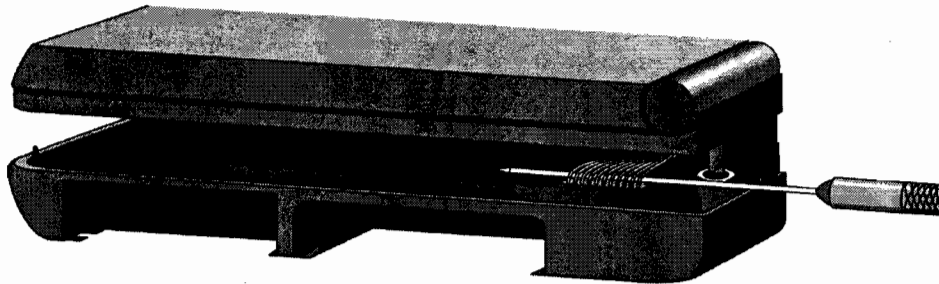

Figure 18 - Reconnecting Display Cable

7. With the display cable reconnected, the I/O grounding eyelets must be slid into place. **Use caution when positioning the I/O grounding eyelets as they can be broken off easily.** It is acceptable to reassemble the OmniBook with certain I/O grounding eyelets broken if there is **at least one eyelet in each of the four positions AND at least two matched sets remaining.** See Figure 19, Figure 20, Figure 21, and Figure 22 for examples.

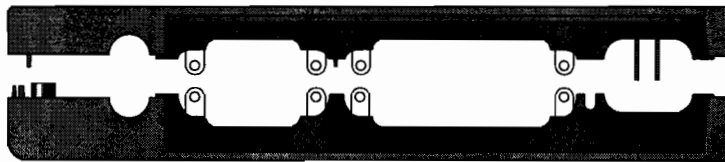

Figure 19 - I/O Port Eyelets (all present)

Acceptable to reassemble
All eyelets are present.

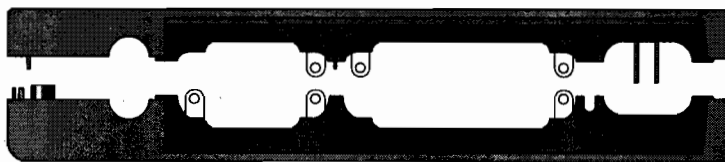

Figure 20 - I/O Port Eyelets (two matched sets)

Acceptable to reassemble
There are two matched sets
and at least one eyelet in
each position.

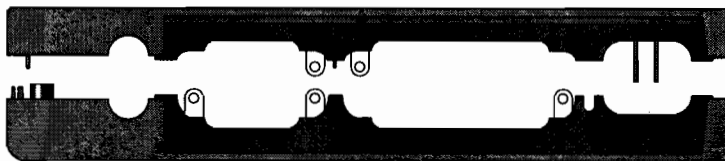

Figure 21 - I/O Port Eyelets (only one matched set)

Not acceptable to reassemble
There is only one matched set.

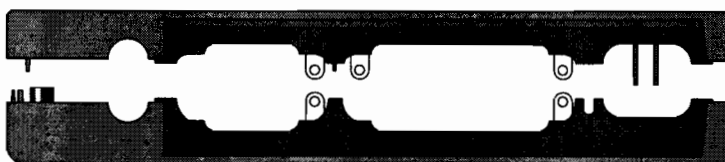

Figure 22 - I/O Port Eyelets (no eyelet in position one)

Not acceptable to reassemble
There are two matched set, but
no eyelet in position one.

8. Open the display and firmly press the Top Case and Bottom Case together around the entire parameter of the OmniBook. This will lock the tabs of the two cases.
9. Replace the seven screws and four standoffs and the remainder of the components.

Keyboard

(HP Authorized Service Providers Only)

Required Equipment

- Appropriate ESD station
- Torx #6 screwdriver
- Two small flat tip screwdrivers (or similar prying devices)
- Probe

Removal Procedure

1. Follow the *Display Removal Procedure* to separate the Display and Top Case from the Bottom Case.
2. Once the Display is removed, the Keyboard must now be separated from the Top Case. Hold the Top Case and Keyboard Assembly *exactly* as shown in the below illustration.

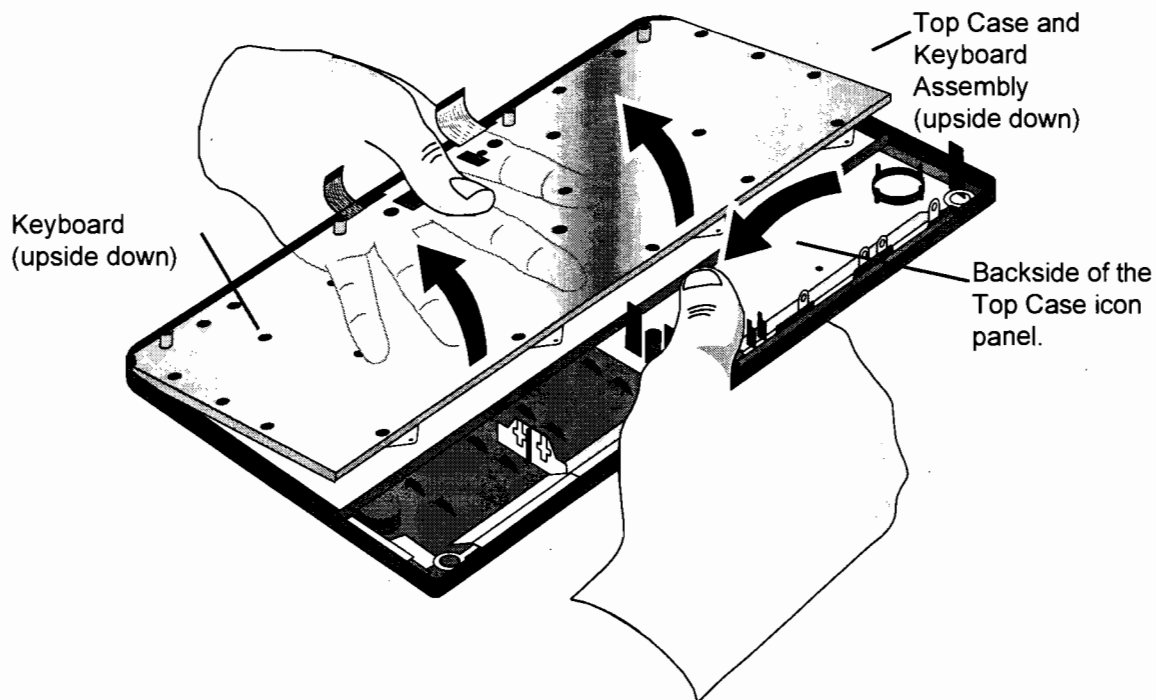

Figure - Keyboard Removal Hand Placement

3. Apply even upward pressure with the fingers of the left hand. At the same time use the tip of the thumb of the right hand to twist the backside of the Top Case icon panel inward and toward the keyboard. There will be a slight bending in the plastic of the Top Case. This is normal and will not damage the assembly.

Replacement Procedure

1. To replace the Keyboard, snap it into the Top Case. Ensure the entire perimeter of the Keyboard is securely snapped into place.
2. Follow the *Display Replacement Procedure* to replace the Display and remaining components.

Logic PCA Board (HP Authorized Service Providers Only)

Required Equipment

- Appropriate ESD station
- Torx #6 screwdriver
- Two small flat tip screwdrivers (or similar prying devices)
- Probe

Removal Procedure

1. Follow the *Display Removal Procedure* to separate the Display and Top Case Assembly from the Bottom Case.
2. Remove the Eject Arms (both right and left) and Mouse Button Latch and Spring (see below illustration). Note, the Mouse Latch Spring is very small and can be misplaced easily.

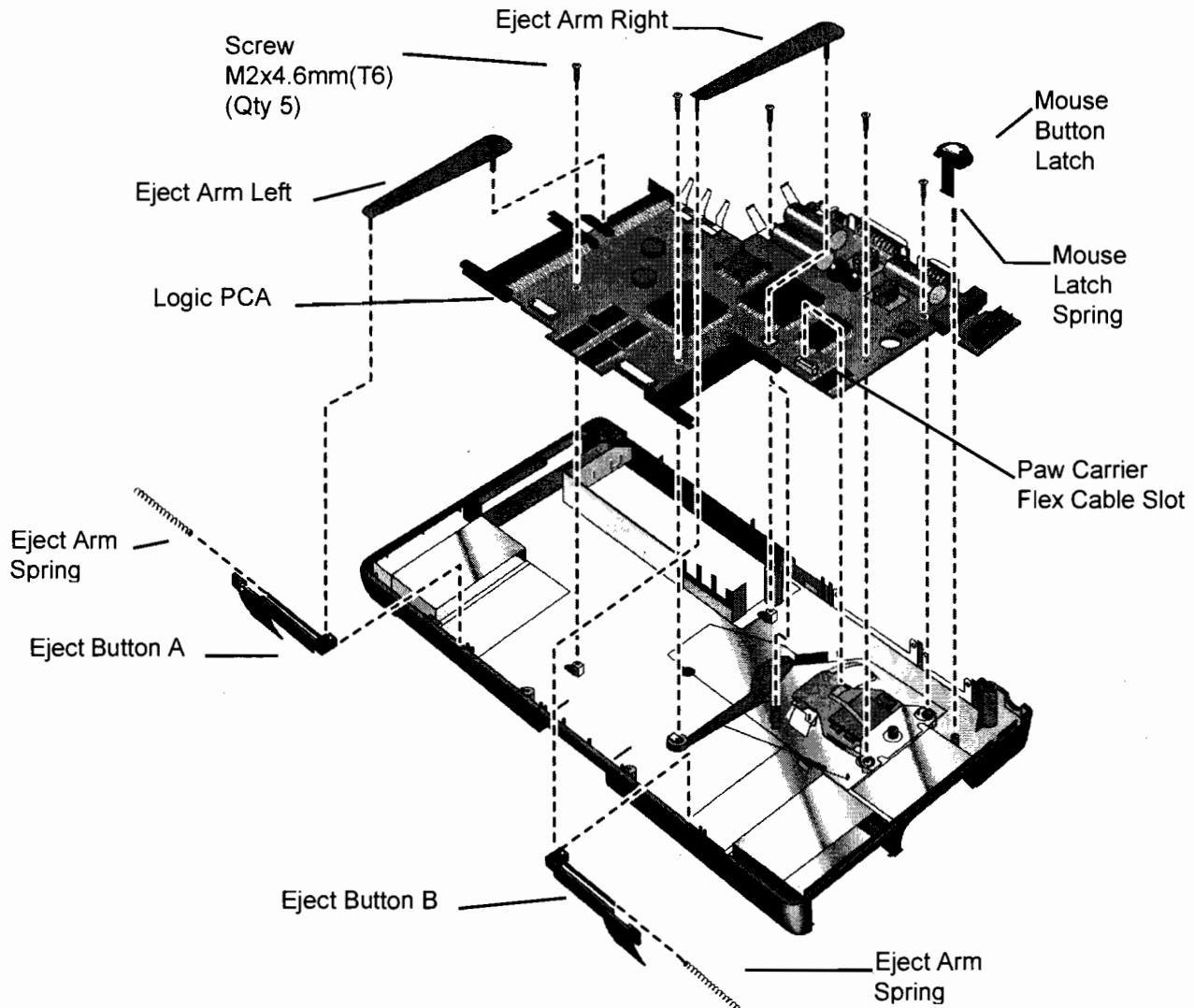

Figure 23 - Logic Board PCA Removal

-
3. The Eject Buttons and Springs do not need to be removed to gain access to the Logic Board. However, because they can be dislodged easily, setting them aside is recommended.
 4. Remove the Paw Carrier Flex Cable from the zero-force insertion slot.
 5. Remove the five (5) screws from the Logic Board (see previous illustration).
 6. The Logic Board can now be lifted from the Bottom Case.

Replacement Procedure

1. To replace the Logic Board, reverse the steps in the *Removal Procedure*. Ensure the Paw Carrier flex cable is positioned properly – the end of the cable should be folded along the holes in the cable. This folded portion then needs to be placed between the posts and guided on the bottom case.
2. Follow the *Display Replacement Procedure* to replace the Display and remaining components.

Paw Carrier (Paw Active) (HP Authorized Service Providers Only)

Required Equipment

- Appropriate ESD station
- Torx #6 screwdriver
- Two small flat tip screwdrivers (or similar prying devices)
- Probe

Removal Procedure

1. Follow the Logic Board PCA Removal Procedure.
2. Remove the Mylar Mouse Shield. Refer to the below illustration for location of components.
3. The Mouse Eject Arm and Eject Arm Spring may be removed at this point for convenience.
4. Gently bend the Pivot Bracket Tabs upward. **Take caution not to break these tabs. If this occurs the Bottom Case must be replaced.**
5. Remove the Pivot Bracket.
6. Lift the Paw Carrier from the plastic posts holding it in place.

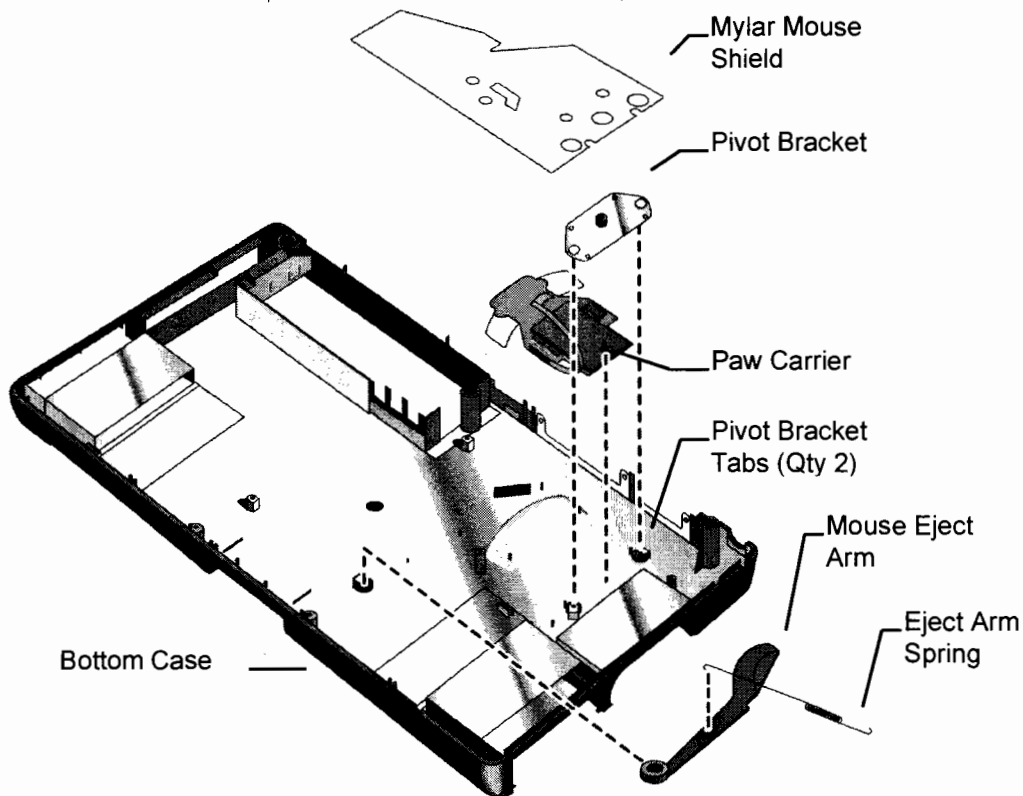

Figure 24 - Paw Carrier Removal

Replacement Procedure

1. To replace the Paw Carrier, reverse the steps in the Removal Procedure.
2. Follow the Logic Board PCA *Replacement Procedure* to replace the Logic Board and remaining components.

Other Components (HP Authorized Service Providers Only)

The below table list additional replaceable components and the disassembly procedure(s) necessary to gain access to each.

Component	Disassembly Procedure(s)	Equipment	Special Notes
Top Case	Display Keyboard	Torx #6 screwdriver 5mm hexdriver Two flat tip screwdrivers Probe	
Bottom Case	Display Logic PCA Board Paw Carrier	Torx #6 screwdriver 5mm hexdriver Two flat tip screwdrivers Probe	
Mouse Button Latch Mouse Latch Spring	Display	Torx #6 screwdriver 5mm hexdriver Two flat tip screwdrivers Probe	
Mylar Mouse Shield Pivot Bracket	Display Logic PCA Board	Torx #6 screwdriver 5mm hexdriver Two flat tip screwdrivers Probe	
Eject Buttons (A&B) Eject Arms (L&R) Eject Arm Spring	Display	Torx #6 screwdriver 5mm hexdriver Two flat tip screwdrivers Probe	
Pivot Doors (A&B) Pivot Door Spring	Display	Torx #6 screwdriver 5mm hexdriver Two flat tip screwdrivers Probe	
Hinge Cap	Display	Torx #6 screwdriver 5mm hexdriver Two flat tip screwdrivers Probe	The Hinge Caps simply slide off of the ends of the Display.
Security Latch	Display	Torx #6 screwdriver 5mm hexdriver Two flat tip screwdrivers Probe	Use a probe to remove the Security Latch from the Bottom Case.

Appendix A - Technical and Resource Specifications

Mass Storage Specifications

	40MB	105MB	131MB	Flash Disk Cards (Typical)
Average seek	< 19 ms	19 ms	19ms	2-3 ms
Track to Track seek	5 ms	6 ms	6 ms	NA
Average Latency	6.67 ms	6.72 ms	6.72 ms	NA
Rotational speed	4503 rev/m	4464 rev/m	4464 rev/m	NA
Data transfer rate				
Buffer to disc	13-21 Mbits /sec	11.4 - 19.2 Mbits/sec	11.4 - 19.2 Mbits/sec	2.5 MBytes/sec
Buffer to host	4.5 Mbytes /sec	4 Mbytes /sec	4 Mbytes/sec	6.0 MBytes/sec
Buffer size	32 Kbytes static RAM	31 Kbytes	31 Kbytes	NA
Spindle start time	1 sec typical 3 sec maximum	<2 sec maximum	<2 sec maximum	NA

Card Services and Socket Services Version Matrix

	OB300	OB425	OB430	OB530
Card Services	Card BIOS 1.0	Card BIOS 1.0	Card BIOS 1.0	2.1
Socket Services	1.01a	1.08	1.14	2.1

Memory Map

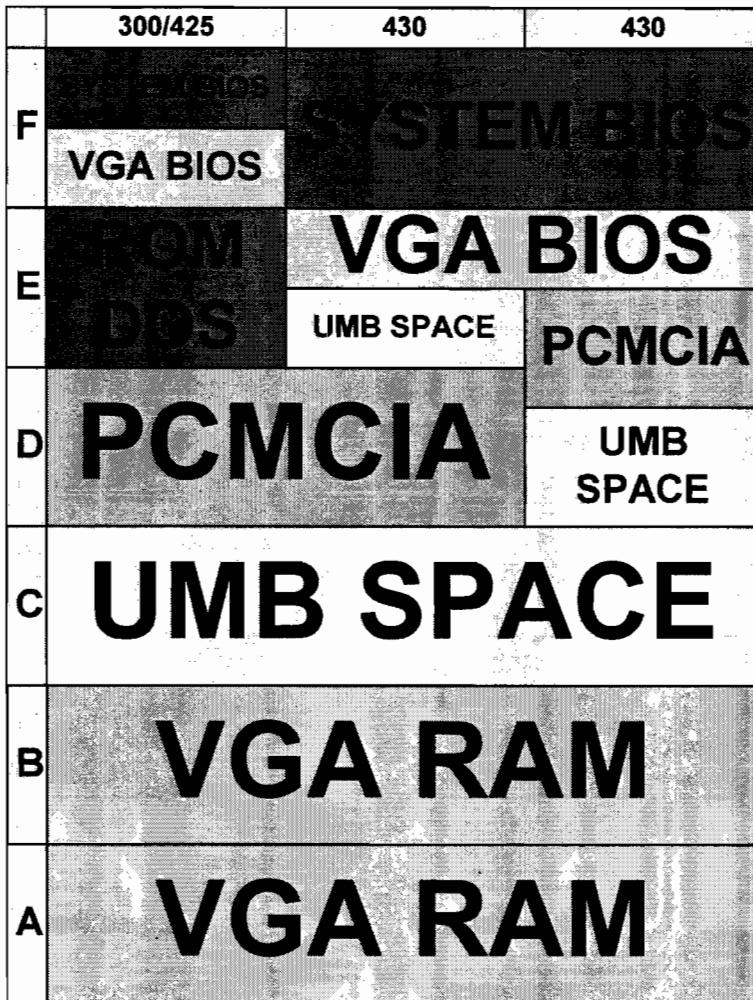

Upper Memory Block Space

	OB300/425	OB430	OB530
UMB Space Available	64k	64k + 32k	112k contiguous

DOS Conventional Memory

	OB300	OB425	OB430	OB530
Windows DOS Box (with LapLink Remote)	315 KB	315	505	404
Exit Windows (with out LapLink Remote)	435 KB	435	533	437

Appendix B - Power On Self Test Codes

Beep Codes

Beep Codes are used to identify a Power On Self Test (POST) error that occurs when the screen is not available. Once the screen is operational, diagnostic messages are reported to the screen. There are beep codes for both fatal and nonfatal system board errors.

The codes are shown as x-y-z where 2-2-1 represents 2 beeps - pause - 2 beeps - pause - 1 beep.

Fatal Errors

1-1-1 CPU failure
1-1-3 CMOS failure
1-1-4 BIOS Checksum failure
1-2-1 8253 timer failure
1-2-2 DMA setup failure
1-2-3 DMA page register failure
1-3-1 RAM refresh not verified
1-3-2 SMI RAM bad
1-3-3 Low 64K RAM failure
1-3-4 Low 64K RAM even/odd failure
1-4-1 Low 64K RAM address line failure
1-4-2 Low 64K RAM parity error
2-1-1 Low 64K RAM bit 0 error
2-1-2 Low 64K RAM bit 1 error
2-1-3 Low 64K RAM bit 2 error
2-1-4 Low 64K RAM bit 3 error
2-2-1 Low 64K RAM bit 4 error
2-2-2 Low 64K RAM bit 5 error
2-2-3 Low 64K RAM bit 6 error
2-2-4 Low 64K RAM bit 7 error
2-3-1 Low 64K RAM bit 8 error
2-3-2 Low 64K RAM bit 9 error
2-3-3 Low 64K RAM bit 10 error
2-3-4 Low 64K RAM bit 11 error
2-4-1 Low 64K RAM bit 12 error
2-4-2 Low 64K RAM bit 13 error
2-4-3 Low 64K RAM bit 14 error
2-4-4 Low 64K RAM bit 15 error
3-1-1 DMA #2 register error
3-1-2 DMA #1 register error
3-1-3 8259 #1 error
3-1-4 8259 #2 error
3-2-4 8042 KB controller error
3-3-4 Video initialization error
3-4-1 Video retrace failure
3-4-2 Video ROM-scan in progress
3-4-3 Video ROM-scan error

Non-Fatal Errors

4-2-1 8253 timer tick test
4-2-2 Shutdown/Restart sequence
4-2-3 Gate A20 failure
4-2-4 Unexpected virtual mode interrupt
4-3-1 RAM test in progress
4-3-3 8253 timer channel 2 test
4-3-4 Time of day clock test
4-4-1 Serial port test
4-4-2 Parallel port test
4-4-3 Math coprocessor test

Display Codes

There are a number of Power On Self Test (POST) tests that are performed after the Beep Code tests. Failure of one or more of these tests will result in a displayed failure code (such as 0240). It is extremely important not to interpret a failure code immediately as a hardware failure. The failure should be confirmed with a clean boot. A clean boot is defined as pressing the reset button after removing all accessories (including memory cards, external floppy drive, modems, PCMCIA cards, and printers) and providing a reliable power source.

The following list explains a number of POST Display Codes. Note, not all codes are available on all models of the OmniBook.

No Error; Self-Test Routine Passed	0000h	test passed
---	-------	-------------

80x86 Microprocessor Error	000fh	MPU failed self test
-----------------------------------	-------	----------------------

BIOS ROM Checksum Errors	0010h	errors relating to the BIOS rom checksums
	0011h	

Real Time Clock Errors	0110h	011X where X = bad register
	0120h	RTC clock tick error

CMOS Errors	0240h	CMOS power bad
	0241h	CMOS checksum bad
	0280h	HP checksum bad
	0282h	EISA checksum bad

error code 0281 was previously used

8041 Errors	0301h	did not read 0AAH command
	0302h	did not respond to 0AAH command
	0303h	bad Response to 0AAH command
	0305h	did not respond when setting keyclick volume
	0306h	did not read 0C0H command
	0307h	did not respond to 0C0H command
	0308h	keyboard fuse is open
	0311h	did not read 060H command
	0312h	did not read data for 060H command
	0341h	did not read kbd interface test cmd
	0342h	did not respond to kbd intrf test
	0342h	add 1-4 to this to get
	00343h	kbd clock line stuck low
	00344h	kbd clock line stuck high
	00345h	kbd data line stuck low
	00346h	kbd clock line stuck high
	0350h	no ACK from kbd test



0351h	bad ACK from kbd test
0352h	kbd not connected
0353h	no response from kbd test
0354h	kbd test failed

error codes 0304, 0313-0314, 0321-0323, 0331-033C were previously used

AUX Self Test Errors

03E0h	send enable-aux cmd to 8042 cmd byte failed
03E1h	8042 failed to accept write-aux-device cmd
03E2h	write-aux-device cmd not sent by 8042
03E3h	reset-aux cmd not accepted by 8042
03E4h	8042 failed to send aux-interface-test
03E5h	no reply for aux-interface-test cmd from 8042
03E6h	aux device clock line stuck low
03E7h	aux device clock line stuck high
03E8h	aux device data line stuck low
03E9h	aux device data line stuck high
03EAh	no reply for aux-reset cmd from aux
03EBh	aux failed to perform reset
03ECh	send default cmd to 8042 cmd byte failed

Protected-Mode Switch Error

0401h	failed to switch to protected mode
-------	------------------------------------

error code 0500 was previously used

Serial and Parallel Test Errors

0503h	no serial port
0505h	bad serial port
0543h	no parallel port

Keyboard Device Errors

0600h	kbd has keys stuck 06XXh where XX = the scan code of the stuck key
-------	---

System Speed Test Errors

0702h	timer failed to interrupt
0703h	CPU clock too slow in SLOW speed
0704h	CPU clock too fast in SLOW speed
0707h	CPU clock too slow in FAST speed
0708h	CPU clock too fast in FAST speed

error codes 0700-0701, 0705-0706, 0709-070C were previously used

Timer Chip Errors

1100h	failed timer test 110Xh where X = failed timer #
1200h	no refresh tick
1201h	refresh signal stuck low

EISA Init Errors

13XY	X = slot number where error occurred Y = error type
1300h	error code displayed if fdc is not configured properly
1301h	error code if board is not ready
1302h	error code if cmos says slot is empty but a card is present in the slot
1303h	error code if cmos says slot does not have board with readable id but can read board id
1304h	error code if cmos id and board id do not match
1305h	error code if incomplete configuration bit is set

Memory Configuration (POST) Errors

2000h	bad port or wrong memory board
2001h	bad port or wrong board type
2002h	port reports null or no SIMMs
2003h	can't mix single and double density SIMM parts
2005h	physical SIMM config. invalid 20X5h X = the memory bank the checking routine stopped at - banks are numbered 0, 1, 2, or 3
2006H	bad memory controller

DMA Errors

21XYh	DMA controller errors XY= 0001 bbbb = register bbbb of controller 01 failed write/read test XY= 0010 bbbb = register bbbb of controller 02 failed write/read test
213Xh	DMA status register errors X=0 => Controller 1's status register failed X=1 => Controller 2's status register failed
22XYh	DMA Page register errors XY= 0001 abbb = channel bbb of page register bad bit a 0 = ISA (0xxh) register 1 = EISA (4xxh) register
0010h	DMA page mask

error codes 3000-3010 were previously used

Real-Mode (0-1Mb) RAM Errors

4000h	4XYZ - the interpretation of this error code is machine dependent
-------	---

error codes 5000-5FFF were previously used

RAM Address Line

6100h	errors relating to the address
-------	--------------------------------

**Independence, Parity,
& IO_CHK Errors**

	independence test of ram XX = xxxx bbbb = address line bbbb is bad (no. 0 to 19)
6200h	errors relating to the RAM parity 620X test (low 640k). x = 64k bank no. with problem (i.e. 6204 = bank 4 is bad = address range 40000h to 4ffffh)
6300h	I/O channel check came active during write read test of protected mode ram 63xx = xx = 256k ram bank/block with problem

**BIOS and Memory
Shadow-RAM Errors**

6500h	shadow RAM BIOS failed
6510h	shadow RAM video BIOS failed
6520h	shadow RAM option ROM failed
65A0h	A000 shadow RAM test failed
65B0h	B000 shadow RAM test failed
65C0h	C000 shadow RAM test failed
65D0h	D000 shadow RAM test failed
65E0h	E000 shadow RAM test failed
65F0h	F000 shadow RAM test failed

**8259 Interrupt
Functionality Errors**

07000h	7XYY where X = 0 master's mask reg. failed X = 1 slave's mask reg. failed YY = XOR of value read & written to the mask reg
07400h	IRQ 0 error
07500h	IRQ 8 error

error code 7600 was previously used

Hard Disk Errors

8310h	controller fail
8311h	fixed disk fail
8312h	drive splitting failure

error codes 8001-8002, 8100, 8200, 8300 were previously
used

Flexible Disk Errors

9X0Z	X = drive number (0..3 correspond to drives A:, B:, FDE#1, FDE#2) Z = determined by the following equates
9000H	FDC input error
9001H	FDC output error
9002H	FDC seek error
9003H	FDC recall error
9005H	FDC reset error
9006H	FDC wrong drive
9008H	FDC no interrupt
9009h	FDC track 0 error

error codes 90XX and 98XX were previously used

80x87 Numerical Co-Processor Errors

0a001h	there is no 80287 in the system
0a002h	problem with the 80287's registers
0a003h	problem with the 80287's stack
0a004h	FXCH or FCOMP didn't work
0a005h	FADD didn't work
0a006h	FMUL didn't work
0a007h	FDIV didn't work
0a008h	FSQRT didn't work
0a009h	FPATAN didn't work
0a00ah	invalid operation exception err
0a00bh	denormal operand exception error
0a00ch	zero divide exception error
0a00dh	overflow exception error
0a00eh	underflow error

**Weitek Numerical Co-Processor Errors**

0af00h	failed to enter protected mode
0af01h	there is no Weitek in the system
0af02h	error in Weitek data register
0af05h	ADD didn't work
0af06h	MULT didn't work
0af0Ch	Zero Divide exception error

Video Errors

0b009h	beep if no video card is installed error codes B001-B008, B100, B200, B301-B307, B400-BFFF were previously used
--------	--

Cache Errors

0b308h	internal cache error
0b300h	P4 cache test failure

Protected Mode RAM Errors

0c000h	0CXYZ - the interpretation of this error code is machine dependent error codes D000, D003-D040, D050, D1XX, EXXX, FFX were previously used
--------	---

Appendix C - Password Policy

If the user forgets the system password, there is a master password that will unlock the OmniBook. The user calls Technical Support to determine this master password as follows:

1. Support will tell the user the keys to type at the password entry screen:
[alt][shft][f10]
2. The OmniBook generates and displays an encoded master password. This is displayed under the normal password entry area. At this point, this is the only password that will unlock the OmniBook unless the user presses [ESC] to remove the encoded master from the password entry screen. Then the user's stored password can be entered.
3. The user reads the encoded master password to Support.
4. Support runs a program that decodes the encoded password, and reads the decoded password (alphanumeric) to the user.
5. The user types in the decoded password.
6. OmniBook decodes the encoded master password it generated and compares it to the decoded password typed in by the user.
7. If the two passwords match, the OmniBook is unlocked. The forgotten password is automatically erased. Support can then guide the user through the process of entering a new password.
8. If the two passwords do not match, the previous sequence must be repeated until the user correctly enters a master password.

The encoded master password is an eight-character alphanumeric sequence that the OmniBook generates at random every time the appropriate keys are pressed in the password entry screen. Because it is generated randomly, a master password can only be used to unlock the OmniBook once. If the user forgets the password at another time, it will require another call to Support. (If the user presses the appropriate keys by mistake, pressing [ESC] will allow entering the stored password.)

The password descramble programs for the HP OmniBook PCs are protected as HP Company Private information. They may not be copied, backed-up, printed or distributed. There are only six official copies of each program.

In addition to the program being protected, its use is also controlled. Hewlett-Packard and authorized support providers must ensure with written evidence that the OmniBook that is being "descrambled" is actually in the hands of the unit's actual and current owner. This requires a sales receipt showing the unit serial number and owner's name, or a written statement from the owner attesting that he or she is the owner of the unit. The statement can be a FAX copy of the document. The fact that the unit is in the hands of an HP representative on behalf of the customer is not evidence of ownership. In addition, HP will not descramble a unit for any non-owner, even if it involves law enforcement agencies. If you receive such a request, you should notify

management and HP Corporate Legal immediately. (These requests may require a court order prior to our participation.)

Further, you must log the name, serial number and date of the running of the descramble program, and file the written backup with the log. The log and backup are subject to standard record retention process and review.

The final issue relating to descramble of passwords is that HP cannot provide information to users that would assist them in improperly descrambling a password and opening a unit.

Appendix D - Part Numbers

Part Number	Description	OB300	OB425	OB430	OB530
0380-4060	Standoff	✓	✓	✓	✓
0515-2396	Screw M2x4.6mm (T6)	✓	✓	✓	✓
F1030-00016	Arm Eject Mouse Spring	✓	✓	✓	✓
F1030-00026	Pivot Door Spring	✓	✓	✓	✓
F1030-00029	Spring Card Eject	✓	✓	✓	✓
F1030-00030	Mouse Latch Spring	✓	✓	✓	✓
F1030-20001	Mylar Mouse Shield	✓	✓	✓	✓
F1030-40013	Pivot Door A	✓	✓	✓	✓
F1030-40014	Pivot Door B	✓	✓	✓	✓
F1030-40016	Door Modem Blank	✓	✓	✓	✓
F1030-40017	Door RAM	✓	✓	✓	✓
F1030-40018	Rubber Foot	✓	✓	✓	✓
F1030-40019	Hinge Cap	✓	✓	✓	✓
F1030-40021	Mouse Button Latch	✓	✓	✓	✓
F1030-40025	Battery Door Latch	✓	✓	✓	✓
F1030-40033	Security Latch	✓	✓	✓	✓
F1030-40044	Eject Button A	✓	✓	✓	✓
F1030-40045	Eject Button B	✓	✓	✓	✓
F1030-40046	Eject Arm Left	✓	✓	✓	✓
F1030-40047	Eject Arm Right	✓	✓	✓	✓
F1030-40050	Arm Eject Mouse	✓	✓	✓	✓
F1030-60901	Paw Carrier Srvc Assy	✓	✓	✓	✓
F1030-60904	LCD Display Assy (new)	✓	✓	✓	✓
F1030-60907	Logic PCA (new)	✓	✓	✓	✓
F1030-60908	Door I/O	✓	✓	✓	✓
F1030-60909	Pivot Bracket	✓	✓	✓	✓
F1030-60910	Bottom Case	✓	✓	✓	✓
F1030-60911	Top Case	✓	✓	✓	✓
F1030-60912	SVC Door Battery (10 pack)	✓	✓	✓	✓
F1030-60923	SVC Flash Tray Assy	✓	✓	✓	✓
F1030-60924	SVC ID Plate (10 pack)	✓	✓	✓	✓
F1030-60925	SVC Short Bar (10 pack)	✓	✓	✓	✓
F1030-60926	SVC Bat Jumper (10 pack)	✓	✓	✓	✓
F1030-80013	Keyboard USA	✓	✓	✓	✓
F1030-80015	Regulatory Label	✓	✓	✓	✓
F1030-80018	Icon Label	✓	✓	✓	✓
F1030-80019	Logo - Display	✓	✓	✓	✓
F1030-80031	Keyboard German	✓	✓	✓	✓
F1030-80032	Keyboard Spanish	✓	✓	✓	✓
F1030-80033	Keyboard French	✓	✓	✓	✓
F1030-80044	Foam Shipping Pouch	✓	✓	✓	✓
F1030-80057	Keyboard Int English	✓	✓	✓	✓
F1030-80063	FFC - Theta	✓	✓	✓	✓
F1033-60901	Regulatory Label (10 pack)	✓	✓	✓	✓
F1033-60902	SVC Icon Label 425 (10 pack)	✓	✓	✓	✓
F1033-60907	Logic PCA (new)	✓	✓	✓	✓
F1033-60908	Sys ROM (ABA) - US English	✓	✓	✓	✓
F1033-60909	Sys ROM (ABB) Int. English	✓	✓	✓	✓
F1033-60910	System ROM (ABD) German	✓	✓	✓	✓
F1033-60911	System ROM (ABF) French	✓	✓	✓	✓

Part Number	Description	OB300	OB425	OB430	OB530
F1033-60912	System ROM (ABE) Spanish	✓	✓		
F1037-60901	SVC Icon Label 430 (10 pack)			✓	
F1037-60902	Custom Icon Kit (10 pack)			✓	
F1037-60903	Sys ROM (ABA) US English			✓	
F1037-60904	Sys ROM (ABB) Int. English			✓	
F1037-60905	System ROM (ABD) German			✓	
F1037-60906	System ROM (ABE) Spanish			✓	
F1037-60907	System ROM (ABF) French			✓	
F1052-40007	PCMCIA Door Left				✓
F1052-40012	Door Battery (silver)				✓
F1052-60005	Flash Tray Assy w/ plug (qty 1)	✓	✓	✓	✓
F1052-60906	SVC Logic PCA (new)				✓
F1052-60907	Top Case (silver)				✓
F1052-60908	Bottom Case (silver)				✓
F1052-60914	Icon Label (10 pack)				✓
F1052-60915	Regulatory Label (10 pack)				✓
F1052-69008	SVC Logic PCA (exchange)				✓
F1065-60029	Hard Drive Tray	✓	✓	✓	✓
	Accessories				
0950-2630	Floppy drive				✓
5061-4390	Mouse	✓	✓	✓	✓
8120-2104	Power Cord Swiss	✓	✓	✓	✓
8120-2956	Power Cord Danish	✓	✓	✓	✓
8120-4211	Power Cord S. Africa	✓	✓	✓	✓
8120-5342	Power Cord Japan	✓	✓	✓	✓
8120-6260	Power Cord US	✓	✓	✓	✓
8120-6261	Power Cord UK	✓	✓	✓	✓
8120-6262	Power Cord Europe	✓	✓	✓	✓
8120-6346	Power Cord Australia	✓	✓	✓	✓
9100-5315	AC Adaptor-worldwide	✓	✓	✓	✓
F1045-60901	Battery Pack	✓	✓	✓	✓
F1041-60901	2MB RAM Exp	✓	✓	✓	
F1054-60901	4MB RAM Exp				✓
F1055-60002	8MB RAM Exp				✓
F1038-60901	4MB RAM Exp	✓	✓	✓	
F1012-60902	5MB Flash disk card	✓	✓	✓	✓
F1013-60901	10MB Flash disk card	✓	✓	✓	✓
F1014-60901	20MB Flash disk card			✓	✓
F1037-60908	105MB HDD DOS/Win/PIM			✓	
F1037-60909	105MB HDD Word/Excel			✓	
F1035-60901	40MB HDD w/ DOS,WIN,PIM			✓	
F1050-60901	40MB Unprogrammed HDD	✓	✓	✓	✓
F1039-60901	105MB Unprogrammed HDD			✓	✓
F1052-60909	130MB HDD Programmed				✓
F1057-60901	130MB Unprogrammed HDD				✓
F1040-60901	F1040A Fax/Modem ABA US	✓	✓		
F1047-60901	Serial cable	✓	✓	✓	✓
F1052-60910	VGA cable				✓
F1059-60901	Floppy drive cable-parallel				✓
F1030-90085	Ops Manual/QuickStart Guide	✓			
F1030-90086	Manual-Vol.2-Excel,PIM,Word	✓			

Note, for the most current parts list, always refer to the latest Product Support Plan.

