

# **Managing Your HP 250**

**Manual Part No. 45260-90003**



**HP Computer Museum**  
**[www.hpmuseum.net](http://www.hpmuseum.net)**

**For research and education purposes only.**

# Printing History

New editions of this manual will incorporate all material updated since the previous edition. Update packages may be issued between editions and contain replacement and additional pages to be merged into the manual by the user. Each updated page will be indicated by a revised date at the bottom of the page. Note that pages which are rearranged due to changes on previous page are not are not considered revised.

The manual printing date and part number indicate its current edition. The printing date changes when a new edition is printed. (Minor corrections and updates which are incorporated at reprint do not cause the date to change.) The manual part number changes when extensive technical changes are incorporated.

November 1981 ..... First Edition  
January 1982...revised pages for 11, 4-3,  
4-10, I-1 through I-5

## NOTICE

The information contained in this document is subject to change without notice.

HEWLETT-PACKARD MAKES NO WARRANTY OF ANY KIND WITH REGARD TO THIS MATERIAL, INCLUDING, BUT NOT LIMITED TO, THE IMPLIED WARRANTIES OF MERCHANTABILITY AND FITNESS FOR A PARTICULAR PURPOSE. Hewlett-Packard shall not be liable for errors contained herein or for incidental or consequential damages in connection with the furnishing, performance or use of this material.

Hewlett-Packard assumes no responsibility for the use or reliability of its software on equipment that is not furnished by Hewlett-Packard.

This document contains proprietary information which is protected by copyright. All rights are reserved. No part of this document may be photocopied, reproduced or translated to another program language without the prior written consent of Hewlett-Packard Company.

# Introduction

With the purchase of your HP 250, you have acquired a powerful business computer designed to further your company's success. Whether you have purchased your computer directly from Hewlett-Packard or from a third party, you have the constantly expanding ability to increase your effectiveness through computing.

This document is designed to help promote your success by showing you how to provide a smooth operational environment after your HP 250 is installed and operational.

The installation of your new computer, whether your first, a conversion, or an addition, affords you an excellent opportunity to establish more effective standards and procedures for your operation. This is a good time to implement new backup and logging procedures, or to evaluate media storage techniques. This manual will provide suggestions that have proven successful in other installations.

You will see many references to your "Principal Operator" in this book. You as a company should choose one person to perform certain tasks such as allocation of resources, backing up of information, and general responsibility for the daily operation of your HP 250.



# Table of Contents

## Chapter 1: Computer Supplies

Tape Cartridges.....	1-2
Discs.....	1-2
Other Supplies.....	1-2

## Chapter 2: Media

Establishing A Media Library.....	2-1
Effects of Environment on Media.....	2-2
Effects of Magnetic Fields on Media.....	2-2
Naming Files.....	2-3

## Chapter 3: Protecting Media From Alteration

Tape Cartridge.....	3-1
Flexible Disc.....	3-2
HP 7906 Disc Drive.....	3-3
Use Backup Procedures.....	3-4

## Chapter 4: Backup

Some Backup Considerations.....	4-2
Backup To Tape.....	4-3
The FVBACK Program.....	4-3
Procedures and Recommendations.....	4-4
How Do I Retrieve Just One File From An FVBACK Tape?.....	4-5
Backup To 7906 Cartridge.....	4-6
The DUPL Program.....	4-6
Procedures and Recommendations.....	4-7
Backup To Flexible Disc.....	4-10
Procedures and Recommendations.....	4-10
BACKUP and RECOVR.....	4-10
The BACKUP Program.....	4-10
The RECOVR Program.....	4-10
The DBSTOR Binary.....	4-11
Security.....	4-11
Your Backup Procedure.....	4-12

## Chapter 5: Logging

Error Log Example #1.....	5-3
Error Log Example #2.....	5-4
Backup Log Example.....	5-5

## Chapter 6: Preventive Maintenance and Upgrades

Installing New Software and Hardware Products.....	6-1
Software Upgrades.....	6-1
Hardware Upgrades.....	6-2
Incorporating Documentation Updates.....	6-2
Documentation Updates.....	6-3
Revisions or New Additions.....	6-4

## Chapter 7: Support

Available Services.....	7-1
Hardware Support Services.....	7-1
Software Support Services.....	7-2

## Chapter 8: In Case of Difficulty

Defining an Error.....	8-1
Where To Start With a System Software Error.....	8-2
The Problem Might Be Hardware.....	8-2
Workstation is Hung.....	8-3
System or Multiple Terminals Are Hung.....	8-3
Peripheral Acting Strangely.....	8-4
Power Failure.....	8-4
Reporting The Problem.....	8-4
Enhancement Requests.....	8-5

# CHAPTER 1

## Computer Supplies

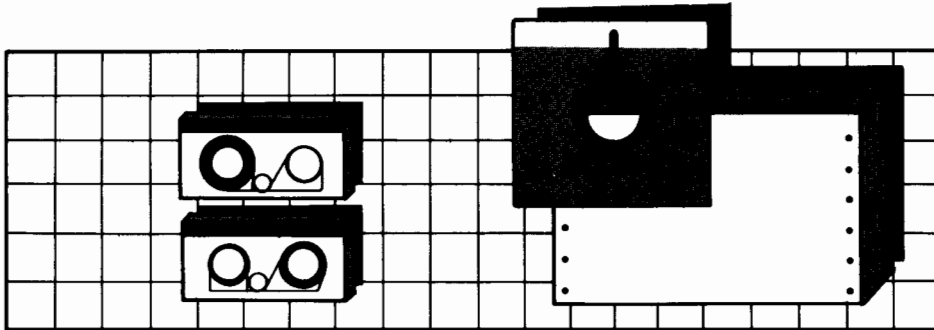

With your HP 250, you will require certain supplies for daily operation. Hewlett-Packard sells tapes, printer ribbons, paper, and all other supplies required with HP equipment.

You should have a copy of Hewlett-Packard's computer supplies catalog (Publication # 5953-2450). If you do not, contact the HP Computer Supplies Operation to get your name on the mailing list:

Hewlett-Packard  
Computer Supplies Operation  
P.O. Box 60008  
Sunnyvale, California 94088  
U.S.A.

The Computer Supplies Catalog is also available in German (5953-2450GE), and in French (5953-2450FR).

Use the computer supplies catalog to order supplies for your HP 250. Look for the words "For use with HP 250" to be sure you are ordering correctly.

In the U.S., you can place your orders by phone for next-day shipment:

- All states, except California, Alaska, and Hawaii, call toll-free: (800) 538-8787
- In California, Alaska, and Hawaii, call collect: (408) 738-4133

In Germany, call (07031) 667-829 for next-day shipment. In other countries, contact your HP Sales and Service Office.



## Tape Cartridges

Use tape cartridges with discs (e.g, HP 7908) having a Cartridge Tape Device built into them. Tape cartridges come in two sizes. The short cartridge is 150 feet long, containing 16.7 megabytes of storage. The long cartridge is 600 feet long and contains about 67 megabytes of storage. See the supply catalog for further information on HP-approved and supported tape cartridges. Hewlett-Packard warranty and service contracts do not cover damage sustained by disc drive heads or media when HP-approved media is not used.

## Discs

Hewlett-Packard designs and manufactures disc drives offering exceptional performance and reliability over a wide range of environments. Using proper disc media is essential for the successful optimum operation of disc drives. Hewlett-Packard warranty and service contracts do not cover damage sustained by disc drive heads or media when HP-approved media is not used.

## Other Supplies

A wide range of HP products is included in the computer supplies catalog. You can order items ranging from terminal glass cleaner to cables.

One section of the computer supplies catalog is entitled "System Startup Supply Recommendations." You may want to refer to these recommendations if you are ordering supplies for the first time.

---

### NOTE

To order manuals, use the latest "HP Communicator," available from your local sales office.

---

Computer Supplies

For more information: OEM you purchased from or HP Sales Office



---

---

# CHAPTER 2

---

## Media

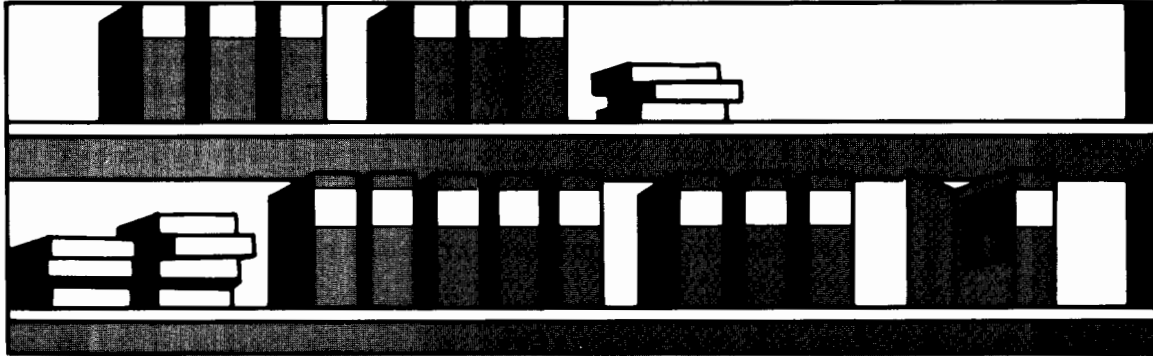

### Establishing A Media Library

In a very short time, you may find your use of the HP 250 is increasing rapidly, with a corresponding rise in the number of discs and tapes to be kept track of by your Principal Operator. Planning at an early stage helps keep your media organized.

Consider providing a storage cabinet for tapes, flexible discs, and disc packs. You may want to develop a numbering and labeling system to identify each medium. As you hand out new media, assign the next available number. This way, you will always know how many of each medium you have in stock, and you can control the disbursement of supplies. You may want to create a data file listing each person's name with the media he or she has in their possession; this will give you even more complete knowledge of the whereabouts of your discs and tapes.

---

#### NOTE

You may want to establish a documentation library in the same area as your media library. This way, you can catalog and keep track of both manuals and media from one place.

---

## Effects of Environment on Media

Provide storage for your media in or near the area where work is performed. This way media is not only easily accessible, but also stored in a clean, dust-free area. Magnetic media has the same requirements as the computer for avoiding extremes of heat, cold, and humidity. Moving a tape from storage in one environment to a tape drive in a very different environment may cause the magnetic oxide coating on the tape to flake off. Moving a flexible disc from storage in one environment to a machine in an extremely different environment can result in warping.

Using damaged media can cause further problems ranging from read errors to damage to the read-write head in the drive.

If working and storage areas cannot be kept at the same relative humidity and temperature, allow an hour or more for the media to achieve a moisture and temperature balance with the system room atmosphere before using the media.

## Effects of Magnetic Fields on Media

Data on discs and tapes are maintained by use of magnetic charges. Placing the media near a magnetic field, therefore, can cause the information on the disc or tape to be altered.

Power generating equipment such as motors (e.g., floor polishing equipment), alternators, or transformers, and data processing disc drives create a magnetic field. Hence, do not place discs or tape cartridges on top of disc drives; discs inside of disc drives are protected.

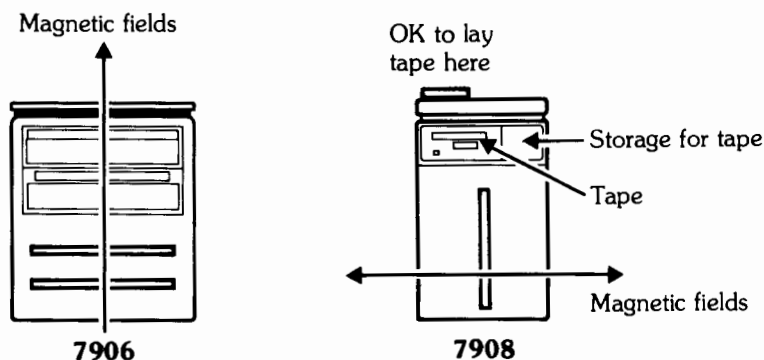

## Naming Files

You may want to adopt file naming conventions to be implemented by all users of your system. Conventions make it easier for people to distinguish their files from those of other users, and also allow you to be aware of who is using disc resources to store their files. This may be especially important if disc space is in short supply.

Here is a simple example of one file naming convention you might use as a guide to formulate standards for your particular needs.

On the HP 250, a maximum of six characters can be used:

XXNNNN

where XX is the initials of the main user of the file, and NNNN is a file name giving a clue to the contents. For example, MLPAYR might contain a payroll roster maintained by Marvin Langren.

Or, you can make your files oriented only toward what they contain. For example, PAY12 may be payroll file #12. That way you could maintain 99 payroll records that would be recognized at a glance (e.g., PAY01 through PAY99).

If you write your own programs, you could use an uppercase name for a program, and the same lowercase name for the data file. For example, your program name could be CHECKS, and the data file associated with it would be checks.

All naming conventions are useful, as all people working with a set of files will then be able to figure out what the files contain. Your file names will be one to six character strings; any character can be used except space, quote mark, comma, colon, NULL or CHR\$(255).

For more information: Software Support Contact



# CHAPTER 3

## Protecting Media From Alteration



You can protect your files by implementing the built-in protection on each HP medium. Protect discs and tapes by using the following procedures. (For password information, see the "HP 250 Basic Manual".

### Tape Cartridge

You can physically protect a tape cartridge from accidental alteration by turning the protect peg on the cartridge to the SAFE position before inserting the tape in the drive. When the peg is in this position, initialization and write operations (STORE, SAVE, PRINT#, etc.) are not allowed. Trying to do a write operation will result in an Error 83, "Medium is Write Protected". To return the tape to both read and write capabilities, turn the peg until the arrow faces left (see below).

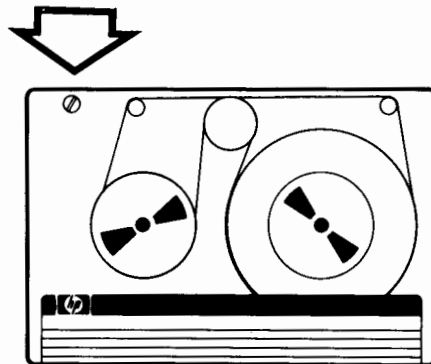



## Flexible Disc

Protect a flexible disc from accidental alteration by removing the write tab. When the tab is removed, initialization and write operations (STORE, SAVE, PRINT#, etc.) are not allowed, and will result in the message "ERROR 83. Medium is Write Protected." If you decide later that you want to make changes to files on the disc, cover the write protect hole with a new tab as shown below.

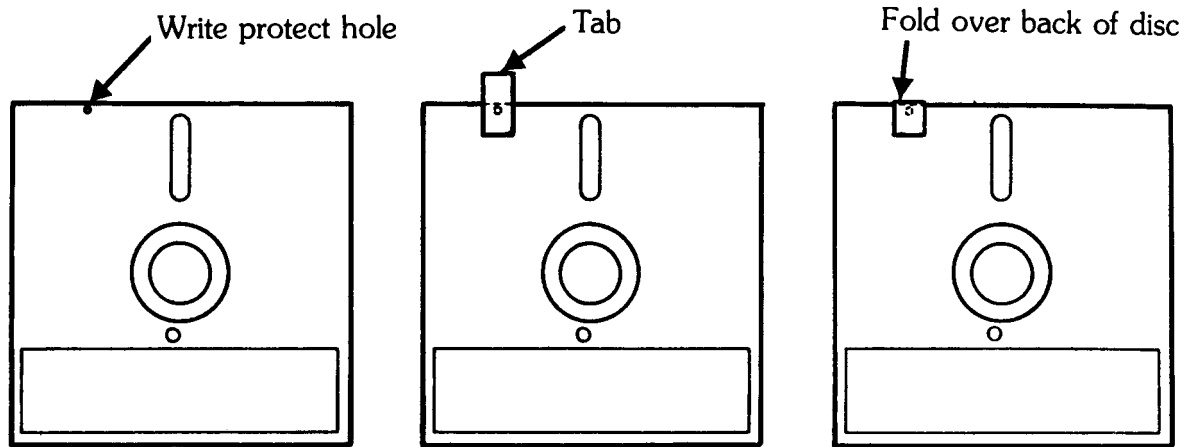

Write tabs are supplied with each package of flexible discs.

---

### NOTE

In addition to removing the write tab, you can protect a disc by taking proper care of it. Return discs to their envelopes when they aren't being used, and follow the guidelines shown on the back of the disc envelope.

---

## HP 7906 Disc Drive

You can physically protect a removable 7906 cartridge or fixed 7906 disc from accidental alteration by turning the drive off, then setting the disc protect switches on the HP 7906 disc drive to the up position (see below). Restart. When the switch(s) are in this position, initialization and write operations (STORE, SAVE, PRINT#, etc.) are not allowed. Trying to do a write operation will result in an Error 83, "Medium is Write Protected.". To return write capability to either the removable or fixed disc, turn the drive off, then flip the disc protect switch to the lower position.

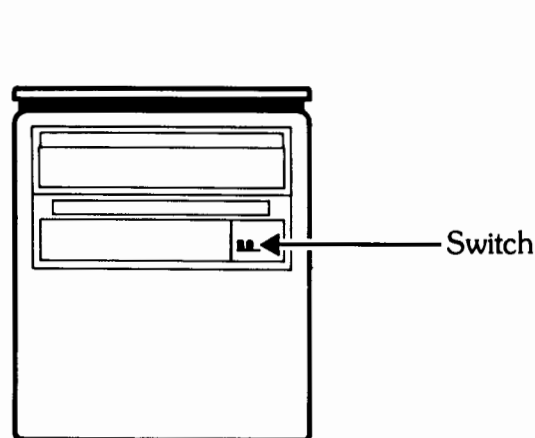

---

### CAUTION

Do not change the position of the write-protect switch on the 7906 drive when the drive is running; doing so can result in a corrupt database. Always turn the drive off before changing the write-protect switch.

---

## **Use Backup Procedures**

The best way to ensure that valuable files will not be damaged or lost is to duplicate the files and keep the duplicates in a safe place. A file may be valuable enough to keep in a vault, or to insure with data processing insurance. At any rate, it should be kept in fireproof storage. (See Chapter 4 for more on backup.)

For more information: Software Support Contact

# CHAPTER 4

## Backup

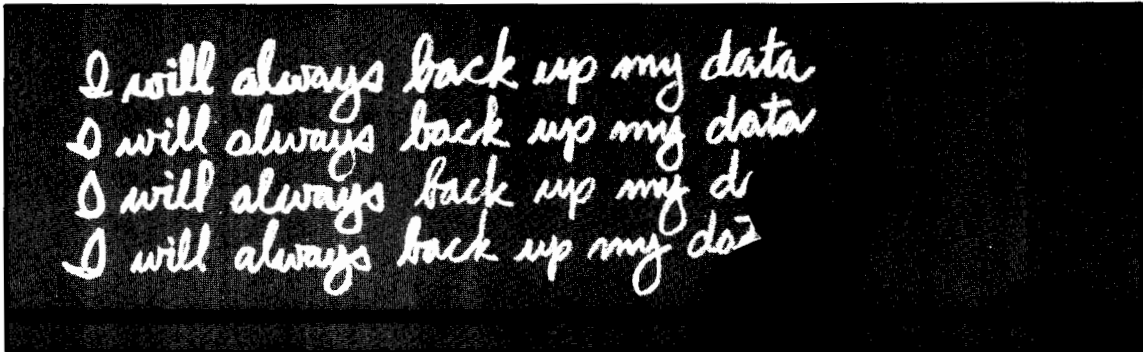

A common mistake made by novice computer users is to underestimate the value of backup. When a system is first delivered, the contents of the new storage media may be negligible. People are not using the new system extensively yet; a few non-essential files may be on the disc. Gradually, as software such as financial, manufacturing and text processing programs are installed, discs begin to fill up with essential, hard-to-replace data. Too often, the Principal Operator is still functioning as though the discs contained only unimportant, experimental files. Absorbed in the large task of bringing this new system into the company as a contributing member, nobody may think of backing up the files located on disc or tape. Unfortunately, some people never give serious thought to backup until a system failure occurs. (A failure is an event that makes your system temporarily inoperable; a power outage can cause a failure.) At that time, it becomes apparent that many hours have gone into the creation of these files; someone may have to replace some or all of them.

You cannot prevent an incident such as a power failure. You can, however, anticipate and minimize such problems by incorporating a backup plan into your operations the very first day that the system is put into use. If nothing else, this will give you practice in backup procedure.

---

#### NOTE

The Customer Support Services Agreement says the following concerning backup:  
"The customer is responsible for maintaining a procedure external to the products for reconstruction of lost or altered files, data or programs to the extent deemed necessary by the Customer, and for actually constructing any lost or altered files, data, or programs."

---

## Backup

The SYSRR DROM should always be included in your system configuration. If you need to configure it, you can do so by following the directions for running CONFIG (found in the "HP 250 Utilities Manual", Chapter 2).

You will recognize a system error (failure) by the list of six-digit numbers that appear down the right-hand side of the main (port 1) screen. Follow the procedure described in "Operating The HP 250", Chapter 10, if you need to deal with a system error.

## Some Backup Considerations

You will consider several factors when implementing your backup strategy. You will need to decide a good time of the day to do backups, and you need to determine the level of assurance you need against loss of data (that is, how often to back up). You need to evaluate how much data you need to back up; more than one backup may fit on a single disc or tape.

Because a backup will "lock up" or monopolize your discs, no disc activity may take place on these volumes during backup or recover. Decide on a backup time when most users wouldn't need the system anyway; the beginning and end of the day are popular backup times.

There are no fixed rules which determine the level of protection you need against loss of data. You have to determine the level of assurance which best suits your needs based on the difficulty in replacing existing data. Backup may be performed, for example, twice daily (once at noon and once at the end of the day), giving a very high level of assurance in the integrity of data. Backup could also be performed daily (either before or after the working day), or weekly (each Friday evening).

You will want to consider saving crucial backups; that is, backups occurring right before month-end posting or clearing. The last Friday of each month might be a good consideration for keeping a backup long-term.

If you decide to have only one tape or disc for backup, you run the risk of having a system failure during a backup, losing all information on that media. It is always a good policy to use alternating discs or tapes to provide a "safety net" for accidents. It is perfectly possible, on the other hand, to do multiple backups to a single tape or disc, utilizing all of the space on the media. You must decide if your data is reasonably protected.

## Backup To Tape

With HP's new tape backup feature (see "The FVBACK Program" in this section), there is no reason to forego a backup, even if the day's activities have been minimal. The entire contents of a 7908 disc can be backed up to a tape in about 10 minutes; a 7911 takes about 20 minutes (40 with verify), while a 7912 takes about 40 minutes (70 with verify). You will always do full (all files) backups with tape cartridges. Therefore, a good backup strategy would use three tapes; two tapes would be labeled "daily", and one tape would be labeled "weekly". A blank label on each cartridge container would be used for dates.

### The FVBACK Program

The new HP 250 backs up to a tape cartridge. This method of backup is easy to implement, and quickly accomplished. Backup to tape was designed to promote frequent and efficient backup.

The FVBACK (full volume backup) program is a utility that allows you to rapidly copy the entire contents of a disc to a special file on a tape cartridge. Backup files are restored from the tape back to the disc by using this same program.

To use FVBACK, your system must have an Integrated Storage Product (HP 7908, 7911, or 7912 disc with a Cartridge Tape Drive). Although FVBACK will work with any HP media, it is most efficient when using a tape with its own HP 7908, 7911, or 7912 drive.

The FVBACK program copies entire volumes only, making it useful for complete backups. Because of the speed of FVBACK, you may choose to do a full daily backup, even if you only need certain files backed up; over two megabytes of information are backed up per minute with an integrated storage product. If you do decide to back up only selected files, use BACKUP (non-IMAGE) or DBSTORE (IMAGE) instead of FVBACK to move the files to tape.

### Procedures and Recommendations

Say that you do your first backup on Monday. After backing up to a daily tape with FVBACK (full volume backup), put the date on the container, and store it in a safe place.

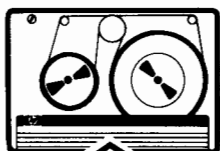

Daily  
12/7/81



Daily



Weekly

On Tuesday, back up to the other daily tape, and store it away.

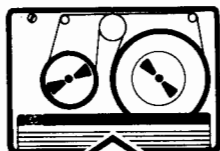

Daily  
12/7/81

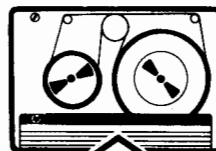

Daily  
12/8/81

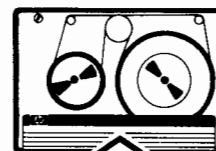

Weekly

On Wednesday, back up to the tape you used on Monday, erasing the Monday backup.



Daily  
12/7/81  
12/9/81

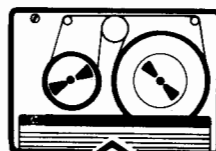

Daily  
12/8/81

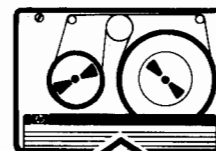

Weekly

On Thursday, back up to the tape you used on Tuesday, erasing the Tuesday backup.

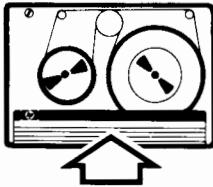

Daily  
12/7/81  
12/9/81

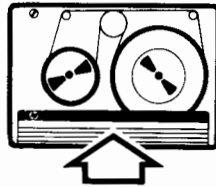

Daily  
12/8/81  
12/10/81

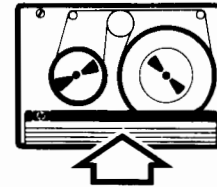

Weekly

On Friday, back up to the weekly tape. For archiving or historical purposes, you may want to keep past weekly backups for a month or so, and month-end weekly backups for a year.

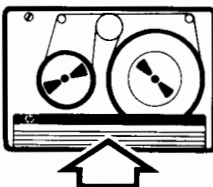

Daily  
12/7/81  
12/9/81

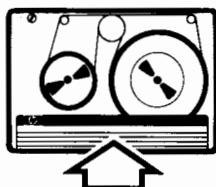

Daily  
12/8/81  
12/10/81

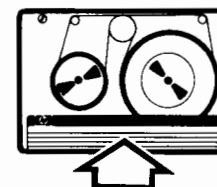

Weekly  
12/11/81

Repeat this process each week.

### How Do I Retrieve Just One File From An FVBACK Tape?

If you want one and only one file from a backup (BACKUP 1), follow these steps:

- Run FVBACK to create BACKUP 2.
- Restore BACKUP 1 to the disc (wiping out the disc contents).
- Copy the file you need from the disc to the tape containing BACKUP 2 using an appropriate utility or the COPY command.
- Restore BACKUP 2 (including the program you copied to it) to the disc, wiping out BACKUP 1. If needed, purge the old file; then, COPY the file from the tape to the disc.



## Backup To 7906 Cartridge

Although you can back your 7906 discs up to a cartridge tape, it is faster to back up both fixed and removable discs up to removable disc. Full backups with DUPL (see "The DUPL Program" in this section) would be a good backup plan. You could implement this as follows. Dedicate three removable cartridges to backup. Label two of them "daily" and one of them "weekly". Put blank labels on each so you can record backup dates.

### The DUPL Program

The DUPL (duplicate) program is a utility which allows you to rapidly copy the entire contents of one medium to another identical type of medium. A typical application would be to copy an HP 7906 cartridge to an HP 7906 fixed disc. The program optionally records a label on the new disc for later identification. The DUPL process also allows you to produce duplicates of flexible discs in only one disc drive by opening a temporary file on another disc.

When you determine your DUPL backup plan, keep in mind the following:

1. Which of the Two Kinds of DUPL is Done

Duplication With Checkread provides the highest possible level of assurance for data integrity, as the backup data is checked back against the source. This mode is as easy to use as Duplication Without Checkread (see below), but is more time consuming.

Duplication Without Checkread is the simplest mode of operating and the least time consuming. The reliability of the HP 7906 Disc Drive means that you have good assurance that your duplicated media will be readable.

2. Where Application Software is Located

It is faster and easier to duplicate one HP 7906 fixed disc, rather than several HP 7906 removable cartridges. This means that you gain a major advantage if you can restrict application data bases and files to the fixed disc. Application programs, overlays, forms and other non-changing files are then stored on the removable cartridge (preferably along with the system files so that the cartridge can be used to power up the machine).

You may decide that your best choice is a mix of duplication strategies. For example you may schedule a daily backup without checkread and a weekly backup with checkread.

You should also be aware that the cleanliness of the machine environment, and proper storage of the duplicate cartridges can be crucial to the integrity of your data. These issues are covered under Media Storage in Chapter 2.

## Procedures and Recommendations

Say that you do your first backup on Monday. After using DUPL to back up to a daily disc cartridge, put the date on the label.

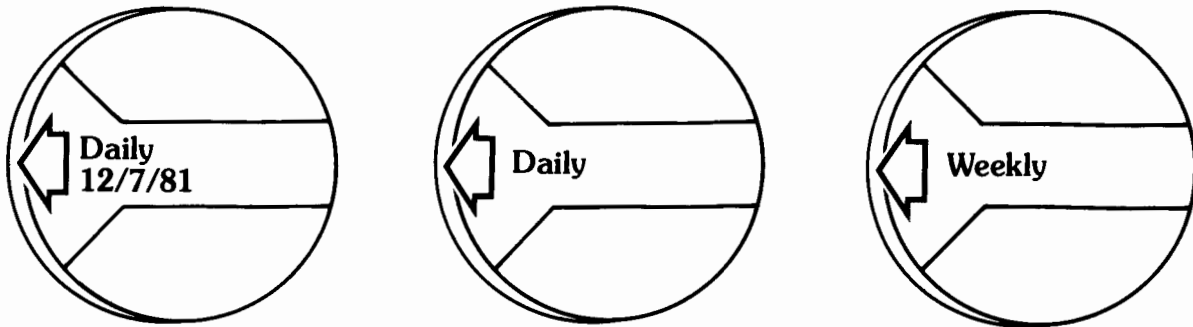

On Tuesday, repeat the procedure with the other daily disc cartridge.

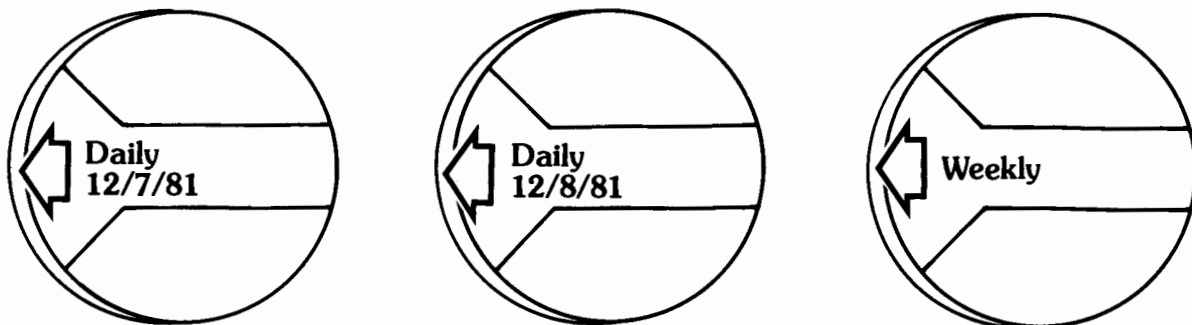

## Backup

On Wednesday, back up to the disc cartridge you used on Monday, erasing the Monday backup.

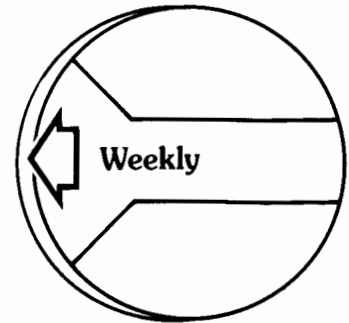
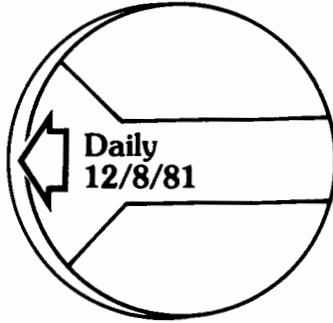
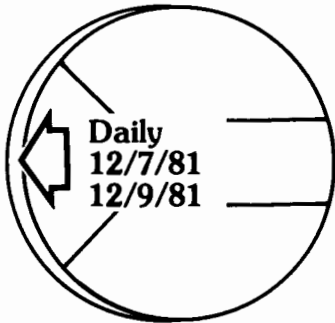

On Thursday, back up to the disc cartridge you used on Tuesday, erasing the Tuesday backup.

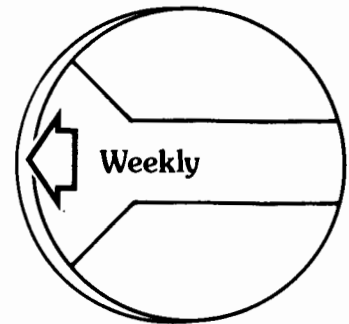
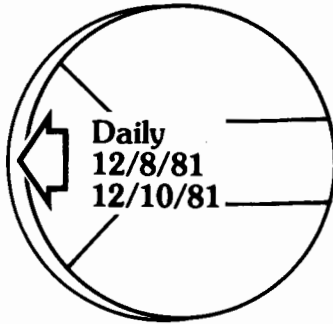
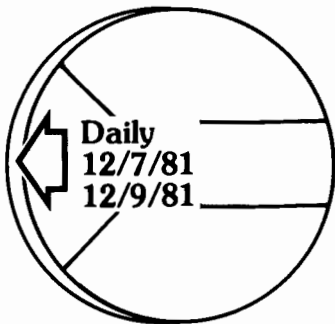

On Friday, back up to a weekly disc cartridge. For archiving or historical purposes, you may want to keep past weekly backups for a month or so, and month-end weekly backups for a year.

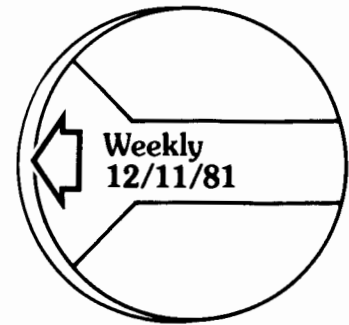
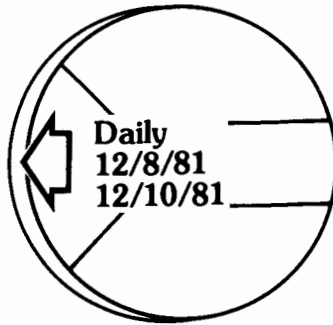
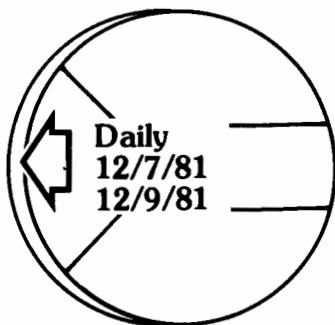

Repeat this process each week. Both the fixed and other removable discs can be backed up this way. You may wish to save the week's paper records (e.g., new addresses, bills, etc.) until Friday's backup is complete. You may also wish to work with four discs, using two "weekly" discs for alternate Friday backups.

## **Backup To Flexible Disc**

Flexible disc backup is recommended for the HP 7910 and 5 Mb. Discs. For flexible disc backup, you will use the BACKUP and RECOVER programs to back up your regular files, and the DBSTOR binary to back up your database files (ROOT and DSET). Using these programs allows you to do what is called a partial backup; only files that have been accessed will be backed up. You can also do a full backup, known as a weekly backup in BACKUP.

### **Procedures and Recommendations**

Using BACKUP and DBSTORE, do a partial backup daily, using one flexible disc (or set of flexible discs) each day. On Friday, do a weekly (or full) backup to one of two weekly discs. On Monday, always back up to Monday flexible discs, on Tuesday to Tuesday flexible discs, etc. You will maintain six sets of flexible discs; one Monday, Tuesday, Wednesday, and Thursday disc, and two Friday discs.

### **BACKUP and RECOVER**

#### **The BACKUP Program**

The BACKUP program is a utility which allows you to store the contents of several non-IMAGE files into one backup file. The source and backup files can be on different types of media. The BACKUP utility will support a backup of any disc type to any other disc or tape. A typical application would be putting parts of several flexible discs into one backup disc file. The BACKUP process is discussed in detail in the "HP 250 Utilities Manual".

#### **The RECOVER Program**

The RECOVER program is a utility which allows you to recover the contents of BACKUP files. The backup source file (tape or disc), and the newly recovered file can be on different media types. The RECOVER program will support the recovery of either the entire BACKUP volume or selected files within this volume. A typical application of this program would be the recovery of a BACKUP file sequence from flexible discs to a 7906 disc.

## The DBSTORE Binary

Use DBSTOR (Data Base STORE) to supplement BACKUP and RECOVER; DBSTOR will take care of IMAGE file backup, while BACKUP does non-IMAGE files. You will need to use these three programs if you are backing up to flexible disc.

To back up each of your data bases independently, use the DBSTORE part of DBSTOR. Keep this backup for use after a hardware or software failure; use the DBRESTORE part of DBSTOR to restore the data to the data base. The advantages of using DBSTORE and DBRESTORE are:

- Data bases may be backed up to tape or disc according to their frequency of use.
- ONLY data within data base files are copied, taking less time than other methods.

If you wish to back up all contents of a disc, you can also use DUPL with IMAGE files. Use DUPL to create the backup, and to restore data after the failure. This backup approach is viable if all frequently used data bases are located on a small number of discs.

---

### NOTE

DBUNLD and DBLOAD are not backup programs. Do not use them as such. Use DBUNLD and DBLOAD only if your data base becomes corrupt, or if you wish to restructure your data base. Always do a DBSTORE before a DBUNLD to ensure that data is not lost.

---

## Security

Something to consider is the security of the backup tapes, diskettes or discs - where they should be kept, and for how long? Many system users consider their backup media so valuable they are stored in a bank or with a commercial vault company. Such security measures prevent the loss of the data on these media by fire, theft or negligence, and prevent unauthorized access to the data on the media.

## Your Backup Procedure

Hewlett-Packard provides three methods for backing up disc files: DUPL, BACKUP and RECOVER, and FVBACK. An HP binary program, DBSTOR, backs up only data bases.

Each of these backup methods merely restores files to their state at backup time. No automatic recovery is provided to recover changes made between the time the backup copy is created and the time that the failure takes place. If many applications modify certain data, you may want to back it up more frequently than you do the rest of your files.

Look in the "Utilities Manual" for instructions on how to use all five of the backup programs discussed here.

PROGRAM	ADVANTAGES	LIMITATIONS
FVBACK	Fast; both IMAGE and non-IMAGE files done	Full backup only - to tape cartridge only
BACKUP	Can do full or partial backup to tape or disc	Time consuming; IMAGE files not backed up
DBSTOR	Fast; to disc or tape	Only IMAGE database files backed up
DUPL	Fast	Must back up to identical type medium- Full backup only

Once you decide which backup procedure is right for your installation, arrange a backup schedule with your Principal Operator. Choose an alternate backup person to step in when the Principal Operator is unavailable. Then, publish the backup procedure, notifying all users as to who will do backups, when the backups will be done, and which files will be backed up. This way, all HP 250 users can arrange their schedules to avoid using the computer during backup. Also, they will know whether or not their most recent files have been backed up simply by knowing what time they last accessed the file. If you keep a crucial backup in a bank vault, users will know what they can retrieve in case of accidents.

For more information: Software Support Contact

# CHAPTER 5

## Logging

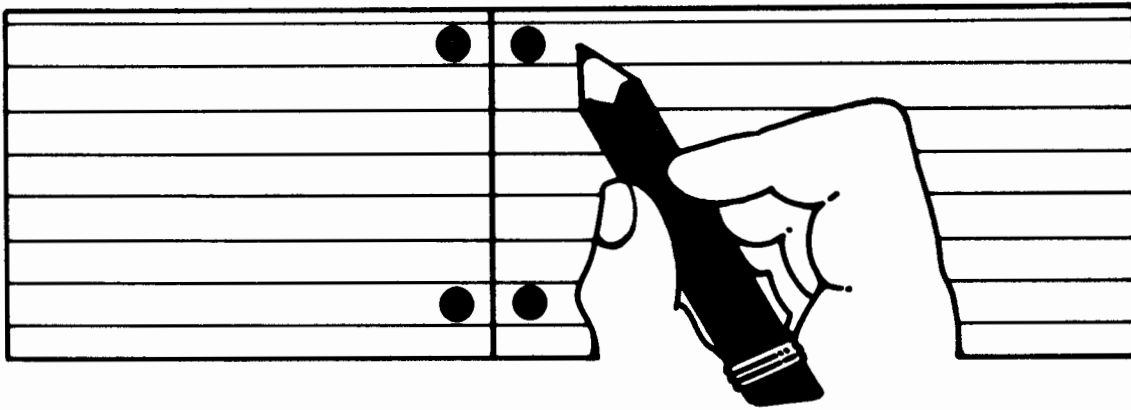

Logging provides a record of certain events that take place with your HP 250. The Principal Operator is responsible for logging. Logging provides needed historical data in the following areas:

- Errors
- Backups
- Installation information
- System Engineer and Customer Engineer Visits

Although it may be a routine, mundane task, logging can save a lot of grief and frustration later on. For example, if a power failure brings the computer down, it is vital to know what day and what hour the last backup was done. You can contact all of the computer users, and tell them that they must replace all data from an exact time. They will know what information they need to replace, and will not waste time searching and checking.

In another case, you may start to experience the same error repeatedly. If the date of all errors has been recorded, the SE, CE, or third party representative can save vast amounts of time by looking over the error log. It may turn out that new software was loaded on September 3rd. On September 5th, the error began to occur on a regular basis. A certain time pattern appears to be occurring. All of these details are vital to a team of specialists looking for a problem; unfortunately, these details are difficult to remember, unless they are written down.

In another instance, you may have called the company you purchased software from to report a repeating error. These people cannot find anything wrong with your software. Hewlett-Packard is contacted, and determines that someone must visit your installation to diagnose the problem. These people will ask you questions similar to those on the following page.



- What software was running when the error occurred?
- Has the environment in the computer's room changed drastically (even for a short time)?
- What was the system configuration (what software packages, how many workstations, etc.) at the time of installation?
- How, to your knowledge, has your procedure or your system configuration changed?
- When were the third party people here, and what did they say and do?
- What kinds of electrical equipment are used in your building?

If you provide information such as what past problems and how they were resolved, a support person can save time by reviewing those log entries. Often, the key to a problem is finding what has changed.

Even if the Principal Operator in your company possesses a photographic memory, that person may be promoted or may leave the company, taking with them all of the vital information that should have been in the log book.

Hewlett-Packard supplies an HP 250 System Support Log with each system shipped. At this printing, the log book contains forms for:

- Installation Record (completed by CE)
- Service Log (completed by CE)
- System Configuration (completed by CE)

You will need to create your own forms for backup and error logging. Two examples of error log pages, and one backup log example are given on the following pages.

---

NOTE

Any time you see the words "Parity Error" on the screen, take especially careful notes; your support person will need to know the circumstances and outcome.

---

---

## Error Log Example #1

---

Principal Operator \_\_\_\_\_

Date \_\_\_\_\_ Workstation Location \_\_\_\_\_

Error Number/Message \_\_\_\_\_  
\_\_\_\_\_

Program in Use \_\_\_\_\_

System Error \_\_\_\_\_ Program Error \_\_\_\_\_ Other \_\_\_\_\_

What happened? \_\_\_\_\_  
\_\_\_\_\_  
\_\_\_\_\_

How was the problem corrected? \_\_\_\_\_  
\_\_\_\_\_  
\_\_\_\_\_  
\_\_\_\_\_  
\_\_\_\_\_  
\_\_\_\_\_

\_\_\_\_\_  
Service Representative

\_\_\_\_\_  
Date

---

## Error Log Example #2

---

TIME |

\*

ERROR # |  
& SUCCESSION |

WORKSTATION |  
ACTIVITY |

PRINTER  
ACTIVITY |

LINE MONITOR |  
ALARM / PRINT|

---

---

\* Succession refers to any message or numbers printed on the screen after the error occurs.

---

### NOTE

This is a more sophisticated error log than the one on the previous page.

---

---

## Backup Log Example

---

Operator \_\_\_\_\_

Date \_\_\_\_\_

Daily Backup \_\_\_\_\_

Weekly Backup \_\_\_\_\_

Data Files \_\_\_\_\_

Program Files \_\_\_\_\_

IMAGE Files \_\_\_\_\_

\*\*\*\*\*  
\*\*\*\*\*

---

## Backup Log Example

---

Operator \_\_\_\_\_

Date \_\_\_\_\_

Daily Backup \_\_\_\_\_

Weekly Backup \_\_\_\_\_

Data Files \_\_\_\_\_

Program Files \_\_\_\_\_

IMAGE Files \_\_\_\_\_

## Logging

For more information:   Software Support Contact  
                          Hardware Support Contact

# CHAPTER 6

## Preventive Maintenance and Upgrades

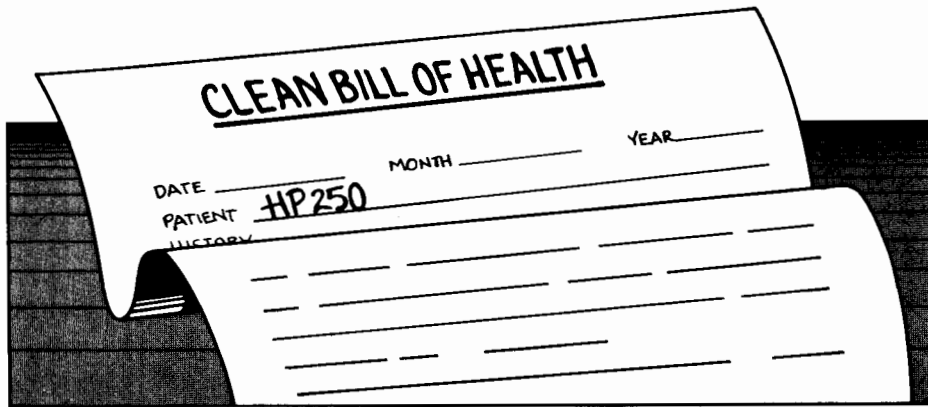

Find out from the company that sold you your computer if any of your peripherals require preventive maintenance. The HP 250 mainframe does not require special attention, but some printers and disc drives do.

You and your Customer Engineer should plan any preventive maintenance for your system; the frequency of the maintenance will depend on what needs to be done. The time of day when the maintenance is performed should not conflict with heavy system usage. Some preventive maintenance requires that the system be devoted to the CE for running diagnostics; certain peripheral devices may not be available for use during maintenance visits. Plan your workload to have all high priority jobs completed before preventive maintenance begins.

### Installing New Software and Hardware Products

To expand the capabilities of your HP 250 system, you may decide to obtain new software or hardware from Hewlett-Packard or from a third party. When the time comes to install the new products, plan your workload accordingly. Do a full backup just before the installation begins to ensure against data loss. Make sure that all critical jobs have been completed prior to starting the upgrade, and do not schedule any critical jobs to start immediately after the upgrade is complete. An upgrade may take longer than anticipated. On the next page are some items to consider when installing new software and hardware products.

## Software Upgrades

- Are your users trained to use the new product?
- Do you know how to configure the system with the new product installed?
- Do you have an adequate supply of manuals for your intended users?
- Will you require Systems Engineering consultation before implementing the new product?

## Hardware Upgrades

- Is the equipment room suitable for the new product (power, space, air conditioning, etc.)? Refer to "Preparing For Your HP 250" for more information.
- Are any new supplies required to use the new product (paper, ribbons, tapes, discs, etc.)?

## Incorporating Documentation Updates

The following manuals are supplied with your HP 250 system:

- QUERY Operator's Guide
- ✓ HP 250 Utilities Manual
- Preparing For Your HP 250
- ✓ Operating The HP 250 (copy included with each workstation)
- ✓ Managing Your HP 250

Call your HP Sales Office for assistance to determine your requirements for additional manuals, to order them, and to arrange their update service. Consider ordering an extra set of manuals to read before your system arrives; use them to become familiar with the product. These extra manuals can become your documentation master set after your system arrives.

One person should be assigned to monitor the distribution of all of the manuals at the installation. This person would then be responsible for knowing which users have manuals in their possession, and ensuring that all documents are kept current. You may want to keep the manuals and media in the same place, and have the same person responsible for both. (See Media Library.)

## Documentation Updates

An update is a modification to an existing manual, containing new or changed information. Manual updates are generally issued in conjunction with software updates.

When successive updates are issued, the latest update contains all the previous ones. This means that the latest update includes all amendments made since the last printing of the manual.

Update packages have no part number. They are numbered sequentially from the time the last edition of the manual was issued. These updates consist of a cover letter, and replacement pages. Always incorporate an update as soon as it arrives, and throw old pages away to prevent confusion.

The following example shows a typical update cover sheet, and a sample update page.

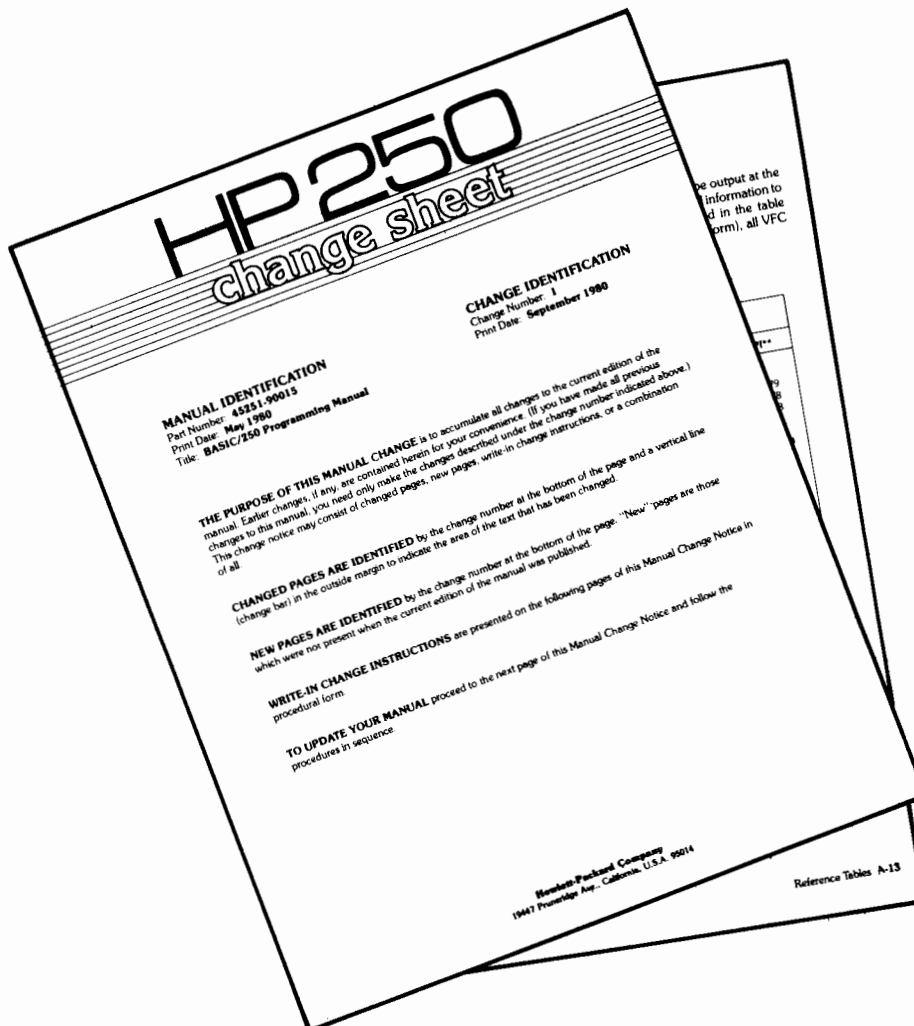



## Preventive Maintenance and Upgrades

The update cover sheet is a yellow page that identifies the manual title, part number, and date the document was printed. It also identifies the update number and date the update was printed.

The most recently changed material on each update page is indicated by a black, vertical "change bar" placed in the outer margin of the page, next to the material that changed. The date the material was changed is included at the bottom of the page. Entirely new pages have only a change number at the bottom of the page.

A reprint includes all updates since the last printing. Future updates are numbered sequentially from the last update.

If you have arranged for Customer Support Service, Software Support Service, or Manual Update Service, a copy of an update package or new addition is automatically sent to the Principal Operator at your site. When you purchase a manual, any updates not yet incorporated will be included in the box. You can order additional manuals which include the updates; you cannot order additional updates by themselves.

### **Revisions or New Additions**

When major changes are made to a manual, issuing an update package may be inappropriate or impractical. In this case, a revision is printed. This new edition obsoletes all previous versions and updates. Look at the Print History page at the front of each manual to learn about previous editions and updates. The date on the title page and back cover reflect the most recent edition. The manual part number remains the same.

For More Information:   Software Support Contact  
                                  Hardware Support Contact

---

---

# CHAPTER 7

---

## Support

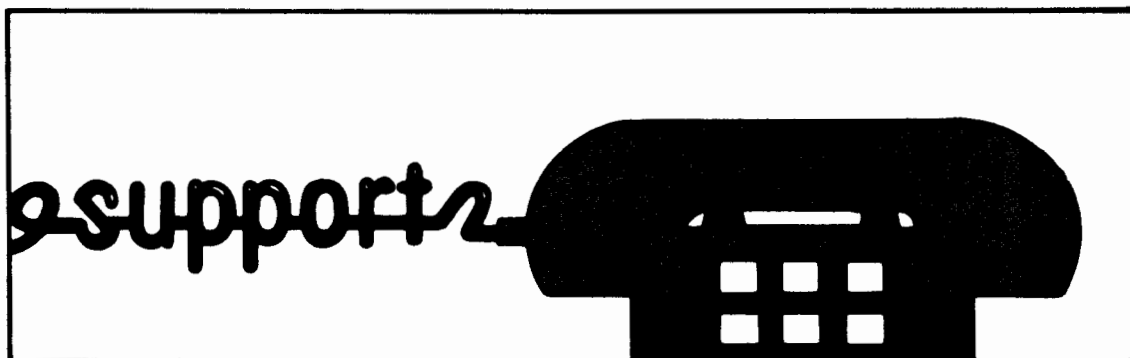

Hewlett-Packard offers a comprehensive set of hardware and software support services to assure optimum performance of your HP 250. Refer to your "HP 250 Configuration Guide" for details concerning each service.

### Available Services

#### Hardware Support Services

Two levels of hardware coverage are available: Standard System Maintenance for which a Standard Monthly Maintenance Charge is made, and Basic System Maintenance for which a Basic Monthly Maintenance Charge is made. Complete terms are described in publication 5953-3318 (HP Computer Systems Support Services Data Book).

The monthly cost of a maintenance plan is based on the type of plan, the service distance, coverage hours, and the equipment under contract. Charges for each product are shown on the HP 250 Office Computer Series Price Sheet.

Customers who prefer to employ HP service on a time-and-materials basis may take advantage of HP's Per-Call service.

Support

**Software Support Services**

You have four basic software support products to choose from:

- Customer Support Service (CSS)
- Software Subscription Service (SSS)
- Software Notification Service (SNS)
- Manual Update Service (MUS)

To determine what each of the above services consists of, consult the following chart.

Why Buy	Close contact – HP-SE of your own; includes the rest			Updates to Software and Manuals		Manual Updates	Know what has changed
	Customer Support Service			Software Subscription Service		Manual Update Service	Software Notification Service
	First System	Central Support of Additional System	Additional Caller to PICS	First System	Right Make One Copy		
	T	V	P	S	W	Q	N
Account-Assigned SE	Yes	+					
On-Site SE Assistance	Yes	+					
Phone-In Consulting	Yes	+	Yes				
Software Problem Reporting	Yes	+		Yes	+		
Software Updates	Yes	•		Yes	•		
Manual Updates	Yes	•		Yes	•	Yes	
Communicator and SSB	Yes	•		Yes	•		Yes

\*Right to make and distribute one copy.  
 + Support of additional site via central site.

For more information: HP Sales Representative

# CHAPTER 8

## In Case of Difficulty

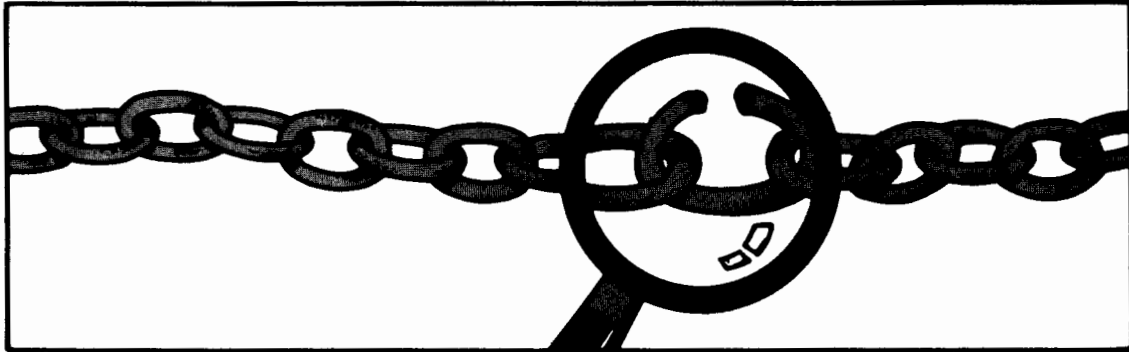

Problems arise during the life of any computer system. Knowing how to handle these problem situations keeps your operation functioning smoothly. In the event of a problem, the Principal Operator should follow the procedures discussed in this chapter. (It is assumed that you have the SYSRR DROM configured, as shown in Chapter 2 of the "Utilities Manual.")

### Defining an Error

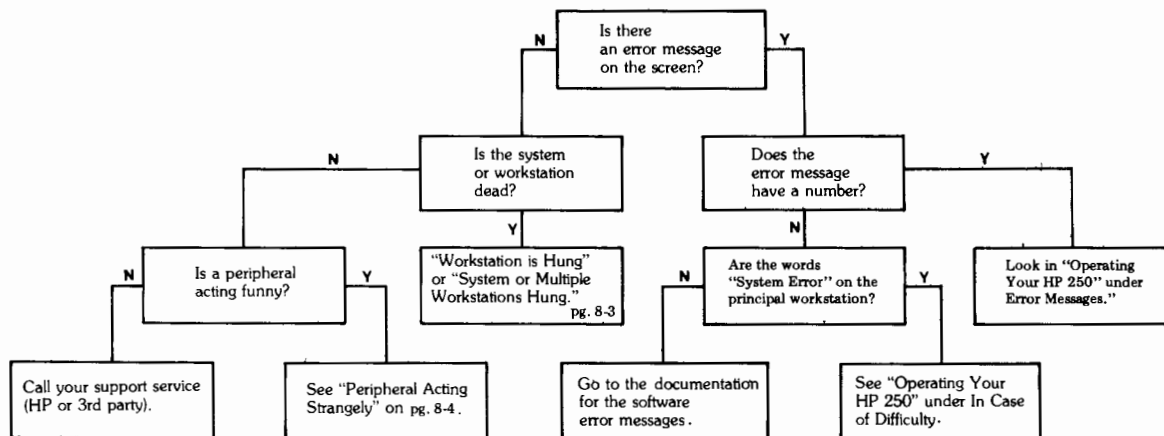

## Where To Start With a System Software Error

1. Isolate and identify the problem using the following steps:
  - Determine which software was running when the error occurred; what combinations of activities were taking place?
  - If the software has been operating in the past, what is different now?
  - Can you make the problem happen again? If not, it may have been a one time occurrence caused by external factors.
2. Contact your support service
  - Check the SSB (Software Status Bulletin) to see if the problem has been reported; if so, is there a workaround?
  - If you have Customer Support Service, call PICS for latest information, advice, and debug help. The PICS SE will determine whether on-site assistance is needed.
  - If you have Software Subscription Service, follow bug reporting procedures, and decide if on-site consulting is needed.
  - If the problem appears to be an unreported bug in HP software, see "Reporting The Problem" in this chapter.

## The Problem Might Be Hardware

Sometimes it is difficult to determine whether hardware or software is causing a particular problem. If your error sounds similar to one of the following, it may be due to a hardware malfunction. (Be sure that the printer isn't turned off.)

- A workstation is "hung", producing no cursor and no reaction to the keyboard, even though it worked previously in this same place.
- A system is "hung"; workstations have no cursor and no reaction to the keyboard, although they previously worked.

- A peripheral (e.g., printer, disc drive, workstation) is reacting strangely. Examples of this would be a printer that is putting extra lines or characters into a printout, a disc drive making an unusual noise, or a workstation producing unusual characters.
- Data is missing after a power failure. (This is not a malfunction, but a possibility with any computer.)

### **Workstation is Hung**

1. Press HALT; if that doesn't help, press both the SHIFT and HALT keys; if that doesn't work, press both CNTRL and HALT.
2. If you still have no cursor, turn your workstation off.
3. Check all cables on the back of the workstation to be sure they are securely connected.
4. Turn the workstation back on.
5. Press the TEST key on the keyboard.
6. Press the RESUME key on the keyboard.

Try to use the workstation again. If the workstation is still not working, call your CE; you will be asked whether the workstation responded to your pressing the TEST key. The CE will take the problem from there.

### **System or Multiple Terminals Are Hung**

First of all, check to see if your operating software is located in a different place during power-on. For example, if you have been "booting up" every day from an HP 7908 disc, and you receive new system software on a cartridge tape, the new software will not know how many workstations you have. Some adjustments need to be made before the new system software is configured for your system.

If the system software has not changed location, turn the system off. Check plugs and cables to be sure they are securely connected. Turn the system back on. If this does not solve the problem, contact a CE at the HP Sales Office.

## Peripheral Acting Strangely

If you have not changed the way you use a peripheral, and it begins to do something out of the ordinary, chances are that you have a hardware problem. Turn the peripheral off, then check cable and plug connections. Perform the self-test. If that fails, call a CE at the HP Sales Office. Further use of a peripheral with a problem could cause damage.

## Power Failure

A power failure, or change in power, can result in anything from no change to a considerable loss of data. Start your system after the power failure, and check your files to determine if anything has been lost. If needed, restore the last backup files to the system.

## Reporting The Problem

A malfunction (bug) is defined as performance that does not comply with published specifications, causes system errors, or causes software to abort. If you have CSS or SSS, you can report these bugs to Hewlett-Packard.

If you have found a bug, fill out an SR (Service Request) and send the SR with all supportive documentation to the SR Monitor at your local HP office.

- Any short programs or routines that demonstrate the failure.
- A SYSRR printout (see Chapter 10 of "Operating Your HP 250").
- A listing of that program (include a copy on disc or tape whenever possible).
- Any printouts.
- A list of commands and input that produce the problem OR the programs and data files that produce the problem.
- A configuration report (generated through CONFIG program, step 11).

The field support team then reviews and verifies the problem. After reproducing the problem (if possible), the SE checks for existing information on the problem. If a workaround is available, the SE will get it to you. If the problem is new, the SE completes a verification form, and forwards it to Hewlett-Packard development engineers for resolution.

Meanwhile, the SE will work with you to provide a temporary workaround.

When your Service Request is received at the factory, it is assigned a reference number. A letter to you and your SE acknowledges your Service Request.

Your SE will notify you of the classification and resolution of the problem, after being contacted by factory personnel.

---

NOTE

The speed with which a problem can be resolved is directly dependent upon how well it is isolated, whether it is reproducible, the accuracy of the Service Request, and the quality of the accompanying documentation.

---

## Enhancement Requests

Enhancement requests are submitted by CSS and SSS customers on a Service Request form, in the same manner as problem reports. HP continually enhances its products, and considers all suggestions submitted by customers. While every effort is made to comply with suitable suggestions, HP is under no obligation to implement a request. Enhancement requests do not appear in the SSB.

For more information: Hardware Support Contact  
Software Support Contact





## A

ADD command.....7-6  
 alternate flexible disc format  
 .....1-6  
 Asynchronous Serial Interface  
 board.....2-13,8-1  
 ports.....8-2  
 auto load.....2-3  
 autostart  
 AFIG configuration...2-9/210  
 in CONFIG.....2-1  
 suppression.....2-10

## B

BACKUP program.....3-16  
 backup  
 data base.....3-30/3-39  
 like media.....3-14/3-15  
 procedures and  
 recommendations.....3-24  
 recovery of (see RECOVER)  
 selected files mode.....3-20  
 selected/daily/weekly  
 .....3-16/3-29  
 to tape.....3-1/3-10  
 BKUP.....3-1,3-31  
 buffer  
 "Buffer ready" (TAPFIX)..6-3  
 "Buffer waiting for tape  
 labeled "Label".....6-3  
 for tape on disc.....6-1  
 label in TAPFIX.....6-2

## C

cartridge tapes  
 diagnose and fix.....6-1/6-8  
 chained mode  
 in DBUNLD program..3-35/3-36  
 improve access time (DBUNLD)  
 .....3-36  
 CHANGE command.....7-7  
 checkread.....3-12  
 common block  
 configure (MFIG).....2-11  
 DROM area.....2-12

multiuser systems.....2-12  
 CONFIG program.....2-1/2-9  
 copy  
 data base files.....5-1  
 data files.....5-1  
 DROMS.....4-6/4-7  
 PROG files.....5-1  
 SYSTEM file.....4-6/4-7  
 run-only files.....4-1/4-3  
 see backup  
 CPU.....2-17,2-18  
 CTD (Cartridge Tape Drive)  
 in FVBACK.....3-1,3-3/3-4

## D

data base utility programs  
 copying.....5-1  
 create in EDITOR....7-1/7-18  
 DBLOAD.....3-31,3-38/3-39  
 DBUNLD.....3-31/3-37  
 data  
 communications interface 5-2  
 file transfer....8-4,8-6/8-8  
 format.....2-13,2-14  
 integrity checks in DUPL  
 .....3-14  
 recovery error.....1-9  
 transfer error.....8-10  
 DBERASE.....3-36  
 DBLD program.....3-38  
 DBLOAD  
 program.....3-38  
 utility.....3-36,3-38  
 DBLOD program.....3-38  
 DBMFIG form file.....3-34  
 DBFM2x form file.....3-34  
 DBFM3x form file.....3-38  
 DBFM4x form file.....3-38  
 DBFM5x form file.....3-38  
 DBPURGE.....3-30  
 DBRESTORE.....3-32  
 DBSTORE statement.....3-30  
 DBUNLD  
 program.....3-34  
 utility.....3-34

## Index

DELETE command.....7-8  
device address....2-5,2-6,2-19  
directory  
  changing.....1-6  
  disc sizes.....1-7  
  tape cartridge.....1-8  
discs  
  "Disc not ready.".....6-3  
  "Disc uninitialized."....6-3  
  5 Mb. Disc  
    backup.....3-10,3-16/3-29  
    directory size.....1-7  
    initialize.....1-2/1-9  
    interleave format.....1-6  
    pattern tests.....1-9  
flexible  
  alternate media format 1-6  
  backup.....3-10,3-16/3-29  
  directory size.....1-7  
  disc interleave format 1-6  
  initialize.....1-1/1-9  
  IBM format.....1-6  
  pattern tests.....1-9  
  purge.....1-10  
7906  
  backup.....3-11  
  initialize.....1-1/1-9  
  interleave format.....1-6  
  directory size.....1-7  
  pattern tests.....1-9  
7908  
  backup.....3-1/3-10  
  directory size.....1-7  
  initialize.....1-1/1-9  
  interleave format.....1-6  
  pattern tests.....1-9  
7910  
  backup.....3-1/3-10  
  directory size.....1-7  
  initialize.....1-1/1-9  
  interleave format.....1-6  
  pattern tests.....1-9  
7911  
  backup.....3/1-3-10  
  directory size.....1-7  
  initialize.....1-1/1-9  
  interleave format.....1-6  
  pattern tests.....1-9  
7912  
  backup.....3-1/3-10  
  directory size.....1-7  
  initialize.....1-1/1-9  
  interleave format.....1-6

  pattern tests.....1-9  
drives  
  list of on-line.....3-19  
  see discs  
DROM  
  allocating memory for  
    .....2-3/2-4,2-11/2-12  
  definition.....2-1  
  edit status.....2-1,2-4  
  list.....2-2,2-3  
  overflow.....2-11  
  print list.....2-18  
DUPL.....3-11/3-15  
  indirect duplication....3-14  
duplication  
  see backup  
  see copy

## E

EDITOR.....7-1/7-18  
  creating run-only files in  
    .....4-1,4-9  
EDITOR/3000.....8-6  
\$ED\$x A file.....7-2  
\$ED\$x B file.....7-2  
\$ED\$x H file.....7-2  
END command.....7-9  
EXIT command.....7-9  
error  
  #2.....2-2  
  #851.....5-1  
  backup.....A-1/A-2  
  buffer.....6-3  
  data transfer.....8-10  
  data recovery.....1-9  
  DBLOAD/DBUNLD.....A-5/A-9  
  disc.....6-3  
  EDITOR.....7-3,A-10  
  RECOVR.....A-3/A-4  
  system.....6-7  
  tape.....6-3/6-7  
"Error during normal system  
operation. Tape data is  
recoverable.".....6-8

## F

FCOPY.....8-9  
file  
  record count.....8-8  
  record size.....8-8

run-only.....4-5  
 transfer to HP3000..8-1/8-12  
 FIND command.....7-10  
 FVBACK.....3-1/3-10

## G

GATHER command.....7-11

## I

IBM flexible disc format...1-6  
 INIT program.....1-1  
 initialize media.....1-1/1-9  
 data reecoverly error.....1-9  
 flexible disc.....1-2  
 5 Mb. Disc.....1-2  
 7908 disc.....1-4  
 7906 disc.....1-4  
 7911 disc.....1-5  
 7912 disc.....1-5  
 pattern tests.....1-9  
 tape cartridge.....1-3  
 time needed.....1-8

## I/O

configuration.....2-13/2-16  
 driver routines  
 .....2-1,2-2,2-5,2-6  
 port numbers.....2-2,2-9  
 task.....2-18

## K

KEEP command.....7-13  
 keyboard sets  
 change.....2-1,2-7/2-8  
 list and edit  
 .....2-1,2-2,2-7/2-8  
 European.....2-8  
 Katkana.....2-8  
 print list of.....2-18

## L

LDERRx file.....3-38  
 LIST command.....7-14  
 LK 3000 utility.....8-1/8-12  
 log-on.....8-2  
 log-off.....8-3  
 operating considerations  
 .....8-12  
 transfer from HP3000 8-4,8-6  
 transfer to HP3000...8-4,8-8

## M

## media

defective tracks 1-1,1-8,1-9  
 file directories 1-1,1-6,1-7  
 initialization.....1-1  
 interleave format.....1-6  
 IBM compatible.....1-6  
 physical records.....1-1  
 purge.....1-10

## memory

configuration  
 ..2-1/2-3,2-9,2-11,2-12/2-14  
 boards.....2-12  
 blocks.....2-12/2-14  
 common block.....2-11,2-12  
 default.....2-18  
 default mass memory device  
 (XFIG).....2-17,2-18  
 DROM.....2-3,2-4,2-11,2-12  
 list.....2-9  
 reconfigure.....2-11  
 user size.....2-9,2-13,2-14  
 modems.....8-11  
 MODIFY command.....7-15  
 MPE III.....8-1  
 "Memory failure.".....2-11  
 Miscellaneous Configuration  
 (XFIG).....2-2,2-17/2-18

## N

nulls.....2-14

## O

## operating system

configuring.....2-1/2-19  
 see system configuration

## P

## pattern tests

initialization.....1-9

## peripheral

edit.....2-1,2-2,2-5  
 list.....2-1,2-2,2-5  
 print list.....2-18

## port

assigning.....2-2,2-13/2-16  
 change configuration (RFIG)  
 .....2-13/2-16  
 field in MFIG.....2-11

## Index

list.....2-9,2-11  
power-on  
  DROMS loaded.....2-2,2-3  
  keyboards loaded.....2-2  
  memory loaded.....2-2  
  message.....2-1,2-2,2-9  
  software loaded.....2-1  
printer  
  configuration.....2-13,2-15  
  in backup.....3-19,3-28  
  I/O.....2-18  
  select code.....3-19  
  set default.....2-19  
purge  
  backup files.....3-5  
  DROM files.....4-6/4-7  
  entire media.....1-10  
  run-only files.....4-1,4-4  
  system files.....4-6/4-7

## R

read/write memory  
  see memory  
RECOVER program.....3-25  
remote configuration  
  information for LK3000...8-1  
  RFIG.....2-13/2-14  
restore files  
  created with BACKUP  
  .....3-25/3-29  
  created with DBSTOR  
  .....3-30/3-31  
  created with FVBACK.....3-2  
root file  
  backup.....3-31  
  copy.....5-1  
RODATA file.....4-9/4-10  
ROUTIL program.....4-1/4-10  
run-only files.....4-1/4-10  
  copy.....4-1/4-3  
  create.....4-5,4-8  
  purge.....4-1,4-4

## S

SAVE statement.....7-1  
schemas  
  create.....7-1  
serial mode  
  in DBUNLD program..3-35/3-36  
SET command.....7-16  
system configuration

autostart.....2-1, 2-9/2-10  
DROM.....2-2/2-4,2-11/2-12  
keyboards.....2-1/2-2,2-7/2-8  
lists.....2-2,2-19  
memory 2-1/2-3,2-9,2-11/2-14  
peripherals.....2-1,2-2,2-5  
priorities.....2-2,2-17  
workstations  
  .....2-2,2-9,2-13,2-16  
system error.....6-7

## T

tape  
  diagnose problems....6-1/6-8  
  directory size.....1-8  
  initialize.....1-1/1-9  
  label in TAPFIX.....6-2  
  maximum spared blocks....1-9  
  not loaded properly.....1-3  
  removed from another drive  
  .....1-3  
  Tapfix (tape fix)  
  .....1-3,6-1/6-8  
  " Tape is unavailable."....1-3  
  " Tape not ready."..6-3,6-5/6-6  
  " Tape ready.".....6-3  
  " Tape removed from another  
  drive.".....6-1,6-3,6-7,6-8  
  " Tape uninitialized."..6-3,6-4  
  TAPFIX utility.....6-1/6-8  
task  
  background.....2-11  
  change priorities.....2-17  
  configuration.....2-9,2-11  
  DROM area added to.....2-12  
  ID.....2-11,2-14  
  I/O port number on ASI..2-13  
  memory.....2-11  
  time slice.....2-17/2-18  
TEXT command.....7-17  
time slice.....2-2,2-17/2-18  
TIMER DROM.....3-4  
TIO DROM.....8-1  
tracks  
  defective.....1-1,1-8  
  spared.....1-8

## U

UNERRx file.....3-34  
"Unexpected memory present."  
  .....2-11

uninitialized media...1-1/1-10  
unit address of tape drive 6-2  
user execution priorities  
.....2-2,2-17/2-18  
USERID.....2-11,2-14  
user memory  
  see memory

V

volume label in TAPFIX.....6-2

W

WHILE command.....7-18  
workstation  
  autostart.....2-9,2-13  
  configuration.....2-2,2-16  
  2622D Personal Workstation  
  .....2-16

X

XCOPY utility.....5-1

