

Introduction to the HP-86B



CASH FLOW ANALYSIS

YEAR:	3	4	5		
SHIPMENTS OF PROPERTY INCOME: TAXABLE INCOME					
Total Gross	9600	105600	116160	127776	140553.6
- Operating	25000	27500	30250	33275	36602.5
Net Operating	78100	85910	94501	103951.1	
- Interest	33388	35322	32417	31865	
- Depreciat	20000	20000	20000	20000	
Taxable Inco	24712	32988	42084	52086.1	



CASH FLOWS

Net Operati	94501	103951.1			
- Prin.&I	52	38652			
Cash Flow	49	65299.1			
- Income	5.6	20834.44			
Cash Flow Aft. Tax	5478.8	29563.2	52.8	39015.4	44464.66

INTERNAL RATE OF RETURN

Sale Proceeds After Tax:			
Discount Rate:			
Cash Flow Aft. Tax (Init. Invest. in Year 0)	-100000	25478.8	29563.2
Net Present Value	-77844.5	-55490.5	-330
IRR (Percent)	-74.5212	-31.41	



**Introduction
to the
HP-86B**

March 1983

Reorder Number
00086-90060

Contents

Section 1: Your HP-86 Computing System	5
Introduction	5
Owner's Documentation	6
HP-86 Features: An Overview	6
Section 2: Owner's Information	9
Inspection Procedure	9
Physical Specifications	10
Rear Panel	10
Power Cords, Voltage, and Fuses	11
Power Requirements	11
Power Cords	11
Grounding Requirements	12
Fuses	12
Selecting a Workspace	12
Initial Set-Up Instructions	13
Connecting a Display Monitor	14
Installing and Removing Plug-In Modules	15
Installing and Removing ROMs	17
Section 3: Connecting Peripherals	19
Introduction	19
Preparations	19
Connecting HP-IB Peripherals	19
Connecting Other Peripheral Devices	21
Connecting Multiple Monitors	21
Section 4: Getting Started	23
Power On	23
The END LINE Key	24
The SHIFT Key	24
Manual Problem Solving	25
Error and Warning Messages	26
Display Editing	27
Variables	28
Typing Aids	29
Addressing Peripheral Devices	29
Accessing the Printer	29
Accessing Mass Storage	30
Programming With the HP-86	31
Erasing Program Memory	31
Entering a BASIC Program	31
Running the Program	32
Storing Programs	32
Initializing a Flexible Disc	33
The STORE Command	33
Generating a Graphics Display	33
Storing and Retrieving a Graphics Display	35
Retrieving Programs	36
Creating Keyboard Overlays	38
Listing a Program	39
Halting Program Execution	39
Appendix A: HP-86 Integrated Interfaces	41
Introduction	41
Plug-In ROMs	41
Peripheral Load	41
Accessory Cables	41
Connecting Peripherals	42
Disconnecting Peripherals	43
Addressing Peripheral Devices	43

HP Computer Museum
www.hpmuseum.net

For research and education purposes only.

HP-86 Talk/Listen Address	45
Setting Peripheral Device Addresses	45
HP-IB Control Registers	46
Control Registers 0 Through 3	47
Registers 16 Through 23: The End-of-Line Registers	49
Register 16	49
Registers 17 Through 23	50
Status Registers	50
HP-IB Errors	52
The Monitor Interface	53
VIDEO Output Signal	55
Appendix B: Compatibility With Other HP Series 80 Products	57
Compatibility of Optional Plug-In Modules	57
Software Compatibility	57
CRT Graphics on the HP-86/87	58
Specifying LIMIT Boundaries and Metric Scaling	59
Scaling Isotropic Units	60
Translating HP-83/85 Programs	60
Translating HP-83/85 Programs That Use Binary Programs	61
Troubleshooting: Sources of Possible Errors	62
Extended File Types	63
Printer and Display Formats	63
Index	65

Your HP-86 Computing System

Introduction

If you've just purchased your HP-86 or if you've never had the opportunity to operate a Hewlett-Packard Series 80 Personal Computer, you should read all or portions of this manual before you start reading the *HP-86/87 Operating and BASIC Programming Manual*. The *Introduction to the HP-86B* manual provides you with step-by-step instructions for setting up your computer system and presents an overview of the HP-86's powerful features.

Sections 2 and 3 include the information you need to properly set up the computer, install various optional modules, and connect peripheral devices. If you are responsible for setting up or altering the configuration of your system, please read sections 2 and 3, carefully following all instructions. As you perform the set-up procedures, pay particular attention to cautions and warnings; they've been provided to protect you and your new computing system from possible harm.

Once your system has been set up, you'll be ready to start learning about the HP-86 by using it. Section 4, Getting Started, is intended to give you "hands on" experience in performing calculations, entering and running programs, and accessing peripheral devices. You'll also have the opportunity to load and run a program provided on the demonstration disc packaged with the computer. Since the HP-86 cannot be harmed by any keyboard operation, you can become familiar with the computer by doing, rather than by merely reading. In some cases, the computer will be your best teacher, informing you when you've made an error and even providing hints on how to remedy your mistake.

After you've completed section 4, you'll be ready for the more in-depth discussion of the HP-86 presented in the *HP-86/87 Operating and BASIC Programming Manual*. Make sure you read the preface of that manual—it includes valuable hints for using the rest of the manual efficiently.

Appendix A of this manual describes the computer's integrated Hewlett-Packard Interface Bus (HP-IB) interface and monitor interface. Refer to appendix A if you need to know more about using those interfaces than is explained in sections 2 and 3.

Appendix B covers compatibility of the HP-86 with other HP Series 80 products. Read appendix B if you will be using the HP-86 to run programs written for other Series 80 computers, or if you have questions about the compatibility of accessories such as ROMs and plug-in modules.

Owner's Documentation

The following literature has been packaged with your HP-86:

- *Introduction to the HP-86B.*
- *HP-86/87 Operating and BASIC Programming Manual.*
- *HP-86/87 Pocket Guide.*
- *Fuse Instruction Card.*
- Warranty and Service Information Sheet.
- *Basic Exchange* and User's Library literature.
- Informational brochures.
- *HP-86/87 Electronic Disc ROM Owners Manual*

Please take the time now to fill out your Basic Exchange form. The form provides us with a mailing address to which we can send your copies of the users' newsletter *Basic Exchange* and is a source of information that enables us to better serve our customers.

Also examine the User's Library literature. As the owner of an HP Series 80 Personal Computer, you have the opportunity to gain access to a large number of programs and programming ideas by purchasing a library membership.

HP-86 Features: An Overview

Most of your owner's documentation is devoted to discussing the computing and programming capabilities of your HP-86. If you are somewhat experienced in programming, however, you might appreciate this list of some HP-86 features:

- Approximately ^{124K}~~64K~~ built-in, usable bytes of computer memory, expandable in increments of 64K and 128K bytes to a maximum of approximately ⁶³⁶~~512~~K bytes. Programs can contain up to 99999 lines.
- An integrated monitor interface for connecting an HP 82912A Monitor (9-inch), an HP 82913A Monitor (12-inch), or other compatible monitor.
- An integrated HP-IB interface for connecting devices such as printers, plotters, and disc drive units to the computer.
- Easy-to-use screen editing that includes cursor control and editing keys for replacing, inserting, and deleting characters anywhere on the screen.
- Four variable types: simple numeric, simple string, numeric array, and string array. Arrays can be one- or two-dimensional.
- Three numeric precisions: INTEGER, SHORT, and REAL (full).
- Multicharacter variable names.
- Multicharacter line labels that allow you to reference program lines by name in branching statements.
- Multiparameter user-defined functions.
- Fourteen user-defined keys used to provide program control and typing aids.
- Multiple binary programs: a maximum of five binary programs can be present simultaneously in computer memory.

- Four ports used to add additional interfaces and enhancement features to the system.
- 16K bytes of CRT memory with variable apportionment of memory between the alpha and graphics display. At power-on, CRT memory provides 54 scrollable, 80-character lines and a 400 × 240-dot graphics display.
- Alpha display formatting that includes variable page size (16 or 24 lines per screen), an inverse video character set, and three line drawing characters.
- Powerful program trace operations for debugging, including an immediate execute key for initiating or cancelling a trace operation while a program is running.
- Built-in Electronic Disc ROM which allows you to designate part of RAM as a high-speed mass storage device. For more information, refer to the HP86/87 Electronic Disc ROM Owner's Manual.

Section 2

Owner's Information

This section covers information you should know about your HP-86 before you begin setting up your computing system. You should become thoroughly familiar with the information in this section before you proceed to operate your HP-86 or connect peripheral devices to the computer.

Section 2 covers:

- Unpacking and inspection.
- Power supply information.
- Description of the computer's rear panel.
- Selecting a workspace.
- Initial set-up instructions.
- Connecting a monitor.
- Installation of plug-in modules.



After you have read the material in this section, you'll be ready to connect your disc drive unit, printer, and other peripheral devices to the computer and to get your system working for you. Section 3, Connecting Peripherals, gives you step-by-step instructions for connecting peripheral devices with the integrated HP-IB interface.

Inspection Procedure

Your HP-86 computer was thoroughly inspected before it was shipped and should be ready to operate as soon as you've completed the set-up procedure. Notify your dealer and file a claim with any carriers involved if you discover any damage to the computer.

Please check to ensure that you have received all of the standard items included with the HP-86:

- Owner's documentation (refer to page 6 for a list of items).
- Demonstration disc.
- Power cord.
- HP-IB Interface cable.
- Video cable.
- Fuses and fuse cap holders.
- Series 80 three-ring binder and dividers.
- One preprinted and one blank keyboard overlay.

If any items are missing, please contact the dealer from whom you purchased the computer. If the computer was purchased directly from Hewlett-Packard, please contact the sales and service facility through which you placed your order.

Physical Specifications

Dimensions

Width	42 cm (16.5 in.).
Depth	46 cm (18 in.).
Height	13 cm (5 in.).

Weight

33 kg (15 lb).

Temperature Ranges

Operating	0° to 55°C (32° to 131°F).
Storage	-40° to 55°C (-40° to 131°F).

Rear Panel

An understanding of the rear panel layout and features of your HP-86 is essential for safe and efficient operation. Use the photograph below to locate the following features:

1. Line Voltage Selector Switch.
2. Fuse Receptacle.
3. Power Cord Receptacle.
4. ON/OFF Switch.
5. HP-IB Cable Receptacle.
6. Ground Information.
7. Module Ports and Covers.
8. Serial Number Plate.
9. Worldwide Safety Approval Nomenclature.
10. RFI (Radio Frequency Interference) Compliance Statement (applicable in U.S.A. only).
11. VIDEO Jack.

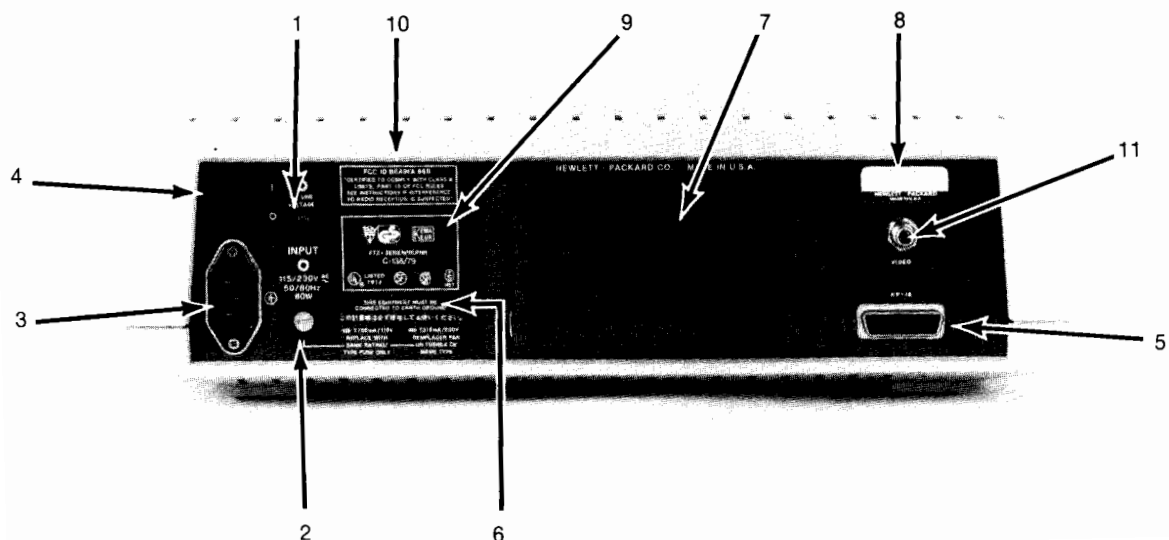

Power Cords, Voltage, and Fuses

The following information relates to the computer's power supply.

Power Requirements

The HP-86 has the following power requirements:

AC Line Voltage

115 Vac Setting	110/117 Vac Nominal
230 Vac Setting	220/240 Vac Nominal

Line Frequency

50 to 60 Hz

Power Consumption

60 Watts Maximum

Power Cords

Power cords supplied by HP have polarities matched to the power cord receptacle on the machine, as shown below.

- L = Line or Active Conductor (also called "line" or "hot").
- N = Neutral or Identified Conductor.
- E = Earth Ground.

Power cords with different plugs are available for the HP-86. The part number of each cord is shown below. Refer to appendix A of the *HP-86/87 Operating and BASIC Programming Manual* for ordering information.

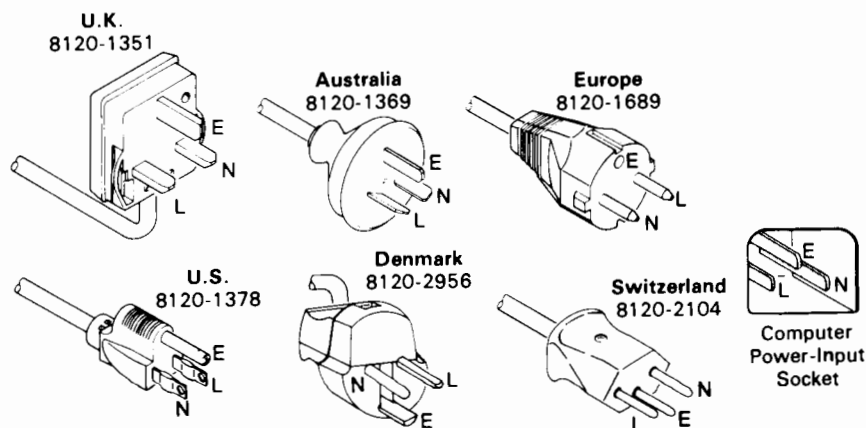

Each plug has a ground connector. The cord packaged with the machine depends upon where the machine was delivered. If your equipment has the wrong power cord for your area, please contact your local authorized HP Series 80 dealer or HP sales and service facility for information on obtaining the proper cord.

Grounding Requirements

To protect operating personnel, the National Electrical Manufacturers' Association (NEMA) recommends that all class 1 equipment be properly grounded. The HP-86 is equipped with a three-conductor power cable which, when connected to an appropriate power receptacle, grounds the machine. To preserve this protection feature, do not operate the machine from a power outlet that has no earth ground connection.

Fuses

For 110/117 Vac Operation:

When the voltage selector switch is set to 115V, use a 750 mA fuse.

For 220/240 Vac Operation:

When the voltage selector switch is set to 230V, use a T315 mA fuse.

Additional Fuses can be ordered from Hewlett-Packard.

750 mA	HP part number 2110-0360
T315 mA	HP part number 2110-0639

Selecting a Workspace

The computer is designed to operate on a flat, hard surface such as a desk or table top. Any workspace you choose should allow the following minimum clearance for adequate air circulation.

Both sides:	15 cm (6 in.).
Rear panel:	15 cm (6 in.).
Overhead:	Allow 15 cm (6 in.) between the monitor and any top enclosure.

To ensure that the air circulation vents in the bottom case are not blocked, avoid placing papers or other items under the computer.

The maximum load that can be placed on the top case is 6.8 kg (15 lb). Equipment placed on top of the computer must not obstruct all the air circulation vents.

CAUTION

To avoid possible damage to equipment, ensure that any item placed on top of the computer provides adequate overhead clearance and does not exceed the top case maximum load or block all the air circulation vents.

Initial Set-Up Instructions

If you have not already done so, please read the preceding pages of this section before continuing.

1. Make sure the power cord is disconnected and that the ON/OFF switch is set to OFF (setting 0; the red "0" on the switch will be visible).

WARNING

Check the voltage selector switch before applying power. Damage to the computer will occur if the selector switch is set to 115 volts ac and 230 volts ac is applied to the power receptacle.

To avoid the possibility of injury, always disconnect the computer from any ac power source before setting the voltage selector switch.

2. Ensure that the voltage selector switch is set for the nominal line voltage in your area. The computer is shipped with the voltage selector switch in the 230V position. If it is necessary to alter the setting of the voltage selector switch, insert the tip of a small screwdriver into the slot on the switch. Slide the switch so that the position of the slot corresponds to the desired voltage as shown below.

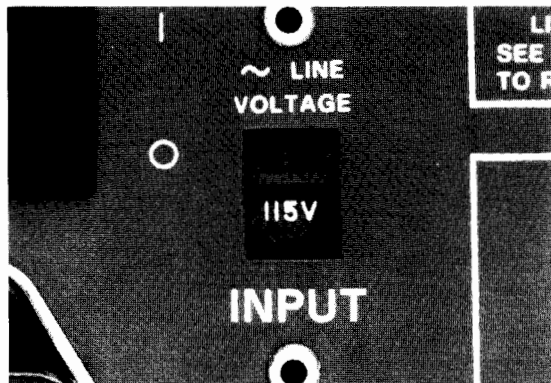

Voltage selector switch in 115V position.

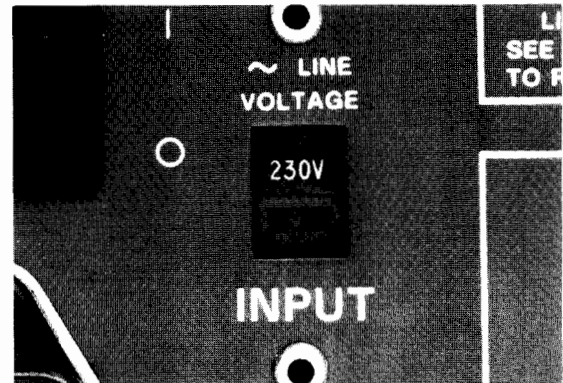

Voltage selector switch in 230V position.

WARNING

Before installing or removing a fuse, make sure the computer is disconnected from the ac power source. Otherwise, a chance of electrical shock to personnel exists, and the new fuse might be immediately overloaded.

3. Install the appropriate fuse. A 750 mA fuse is required for 115 Vac operation; a T315 mA fuse is required for 230 Vac operation. To install or replace the fuse, first disconnect the power cord from the machine. Insert the proper fuse in the fuse cap holder; either end of the fuse can be inserted into the cap. Now, install the fuse and fuse cap into the fuse receptacle by pressing the cap inward and then turning it clockwise until it locks in place.

WARNING

Use only the HP-86 power cord specified by Hewlett-Packard for your area. If it is necessary to replace the power cord, the replacement cord must have the same polarity as the original. Otherwise, a safety hazard from electrical shock might exist, and the equipment could be extensively damaged.

4. Connect the power cord to the power cord receptacle on the back of the computer. Plug the other end of the cord into the ac power outlet.
5. Set the computer ON/OFF switch to ON (setting 1). The amber power light below the keyboard should come on. If the power light is not on, set the ON/OFF switch to OFF and check to see that you've performed steps 2 through 4 correctly. If the power light still fails to come on, the computer requires servicing.

Connecting a Display Monitor

If you've purchased an HP 82912A Monitor or HP 82913A Monitor, you are ready to start the installation procedure. If you will be connecting a different monitor, you should check to be certain the monitor is compatible with the HP-86:

- Compare the monitor's technical specifications with the specifications of the monitor interface on page 53.
- If you intend to stack the monitor on top of the computer, make certain the weight of the monitor does not exceed the weight specification of the computer's top case (6.8 kg, 15 lb) and that the monitor does not block the circulation vents.

The HP-86 allows you to connect multiple monitors. Connecting more than one monitor is discussed in section 3.

To connect a monitor:

1. Set the computer power switch to OFF. Also, turn the monitor power switch to the OFF position.

CAUTION

To prevent possible damage to equipment, set the power switches on both the monitor and the computer to OFF before connecting the monitor to the computer.

2. Place the monitor in its operating position, either on top of or beside the HP-86.
3. Plug the monitor power cord into the power receptacle on the monitor and into an appropriate ac power source.



4. If the monitor controls include a switch for changing the impedance, set the impedance to 75Ω.
5. Attach one end of the video cable to the monitor VIDEO jack on the back of the HP-86. Attach the other end of the video cable to the VIDEO input jack on the monitor.

Turn on the computer and monitor. Within 12 seconds, a cursor (rectangular block) should appear in the upper left corner of the display. When the cursor appears on the screen, the HP-86 is ready for use. If the cursor fails to appear or if it is too pale or too bright, adjust the monitor brightness and contrast controls.

Each time the power is turned on, the system performs a self-test. Should the cursor not appear, or if the computer displays `ERROR 23: SELF TEST`, turn the machine off, then on again. If the problem persists, contact your local authorized HP-86 dealer or the nearest HP sales and service facility.

Note: The length of time required by the computer to complete the power-on self-test depends on the amount of user-available memory present. For example, with four HP 82909A 128K Memory Modules installed, the cursor appears approximately 35 seconds after the power is turned on.

If you will be using your HP-86 without any optional plug-in modules, then you are now ready to begin connecting peripheral devices, following the instructions in section 3. However, if your system includes any plug-in modules (e.g., memory modules, ROM drawer, interface modules), read the remaining material in this section.

Installing and Removing Plug-In Modules

The four module ports on the rear of the computer are designed to accept a number of plug-in modules. The ports are numbered 1 through 4 from top to bottom. Before shipping, each port is covered with a removable protective cover. It is recommended that ports not in use be kept covered.

WARNING

Do not place fingers, tools, or other foreign objects into the module ports. Such actions may result in minor electrical shock hazard and interference with pacemaker devices worn by some persons. Damage to module port contacts and the computer's internal circuitry may also result.

Plug-in modules can be installed or removed as often as you'd like.

It is important that you read all the documentation accompanying each module for instructions, warnings, and any limitations. Each interface module has a factory preset select code in the range 3 through 10. If you will be installing any optional interface modules, make certain each interface module has its own unique select code and that no interface module has a select code of 7, the select code of the integrated HP-IB interface. Instructions for changing the select code of interface modules are provided in the documentation accompanying each interface.

1. Turn off the computer and any connected peripheral devices. However, make sure the computer is plugged into a grounded (three-wire) ac outlet.

Note: Most plug-in modules can be inserted into any of the four ports. However, examine the documentation included with each module for any instructions regarding the use of a specific plug-in port. If it is intended that a module fit into a particular port, it must be inserted into that port.

2. Remove the protective cover from any one of the unused ports, keeping the remaining unused ports covered. You do not need to remove any previously-installed modules.

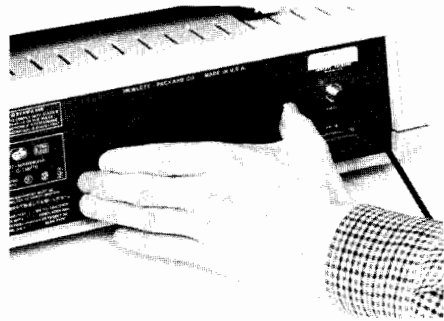

CAUTION

To ensure proper computer operation and to prevent damage to equipment:

- Always switch off the computer and all peripherals before inserting or removing modules. Use only plug-in modules approved by Hewlett-Packard for the HP-86.
- Do not force a module into a port. The port tracks are keyed to prevent the module from being inserted upside down. Forcing an upside down module into a port could result in damage to the module and/or the computer.

3. Line up the module with the port opening and gently slide the module into the port. When you feel a small amount of resistance, firmly press the module into the port until the module grips meet the side of the port. A slight side-to-side motion may be necessary to seat the module in the port.

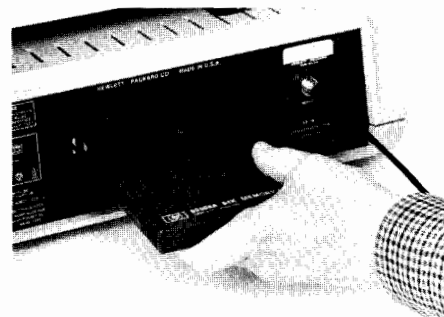

To remove a plug-in module:

1. Turn off the computer and any connected peripherals.
2. Firmly grasp the module and pull it from the port. Side-to-side motion may be necessary to dislodge the module. When not in use, modules should be stored in their original container or in a box where they are protected from damage.
3. Replace the port cover.



Installing and Removing ROMs

ROM modules increase the computer's programming capabilities by providing additional BASIC commands, statements, and functions. All HP-87 ROMs are compatible with the HP-86.

The HP 82936A ROM Drawer contains six rectangular slots for individual plug-in ROMs. Each slot is fitted with its own protective cap. Any HP Series 80 ROM will fit into any of the six positions in the ROM drawer. Before installing a ROM into the drawer, please read the documentation accompanying each plug-in ROM for user instructions, warnings, and any limitations.

Note: Never install duplicate ROMs into the ROM drawer. Duplicate ROMs will not increase your computing power and may create error conditions. The ROM drawer will physically accept both HP-83/85 and HP-87 ROMs. However, the presence of an HP-83/85 ROM causes the HP-86 to return a warning when the power is switched on, and may cause improper computer operation.

To insert a ROM into the ROM drawer:

1. Remove the protective cap from the desired slot in the drawer by inserting the eraser end of a pencil into the circular hole on the underside of the ROM drawer and pressing upwards until the cap snaps off. Leave the cap on any slots not in use.



CAUTION

Do not touch the spring-finger connectors in the ROM drawer with your fingers or insert tools or other foreign objects. Static discharge could damage electrical components.

2. Inside each ROM drawer slot are two rows of spring-finger connectors. These connectors correspond to the two rows of holes on the underside of the ROM. ROMs can be inserted in only one direction; insert the ROM into the slot with its label up and its beveled edge toward the connector side of the ROM drawer. Push the ROM into place so that the top of the ROM is flush with the top of the ROM drawer.



ROMs are removed from the ROM drawer by the same procedure used to remove the protective cap (refer to step 1, above).

Connecting Peripherals

Introduction

If your computing system includes peripheral devices such as a printer, disc drive unit, and plotter, you'll want to connect those devices before you proceed to perform calculations and run programs.

This section explains:

- How to connect peripheral devices using the computer's integrated HP-IB interface or other interface modules.
- How to establish unique addresses for your peripherals which the HP-86 then uses in communicating with these devices.
- How to connect more than one monitor. (Connecting a single monitor is covered in section 2.)

Preparations

Before you start connecting peripheral devices to the computer, you must:

- Plug the computer into a grounded (three-wire) ac outlet. (Read section 2, Owner's Information, before applying power to the computer.) Also plug in any peripheral devices requiring an ac power source.
- Turn off the computer and all peripheral devices.
- Using the instructions in section 2, install each optional interface module to be used into a plug-in port. This step is unnecessary if you will be using only the computer's integrated HP-IB and monitor interfaces. If your system includes optional interface modules, there must be no duplication of interface select codes. The select code of the integrated HP-IB interface is 7.

Connecting HP-IB Peripherals

WARNING

The computer and peripheral devices using an external power source must be properly grounded and switched to power OFF before you start the connecting procedure. Make sure the computer and each peripheral are plugged into grounded (three-wire) ac outlets, and that the power switch on each device is set to OFF. Failure to follow these instructions could result in a shock hazard.

Examine the diagram on page 20. Then, follow this sequence of instructions for connecting your peripherals. The photographs are numbered to match the instructions. If you need additional information, refer to appendix A and to the documentation accompanying your peripheral devices.

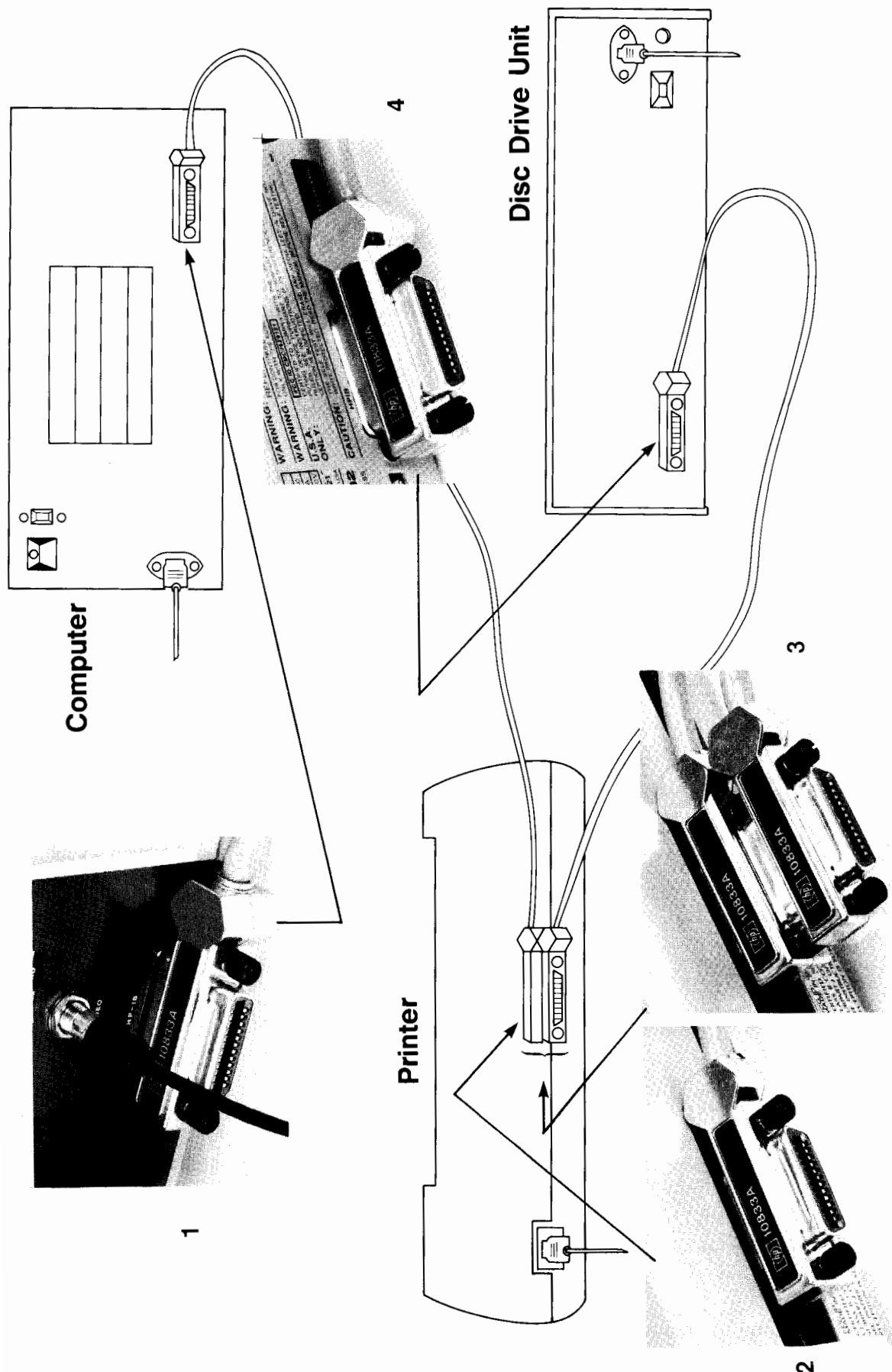

Connecting HP-IB Peripheral Devices

1. Attach and fasten an HP-IB accessory cable to the HP-IB cable receptacle on the rear of the HP-86. The cable connector fits onto the receptacle only when the connector is oriented properly. Hand tighten the two mounting fasteners on the cable housing.
2. Attach the other end of the cable to the HP-IB receptacle on your first peripheral device. (Peripherals can be connected in any order.)

For each additional peripheral device:

3. Attach one end of an HP-IB accessory cable in piggy-back fashion to the connector of any previously connected cable. To avoid mechanical strain, refrain from stacking more than three piggy-back connectors on the same receptacle.
4. Attach the other end of the accessory cable to the HP-IB receptacle on the peripheral device.

Connecting Other Peripheral Devices

If your system includes any plug-in interface modules, connect the peripheral devices requiring those modules. Refer to documentation accompanying both the interface module(s) and the peripheral device(s) for set-up procedures, the preset interface select codes of the interfaces, and, where applicable, the preset device addresses of the peripherals.

Connecting Multiple Monitors

The HP-86 is capable of directing display output to a maximum of four monitors equipped with VIDEO input and VIDEO output jacks. If two or more monitors are connected, the 75-ohm termination switch of each monitor except the last one in the chain must be set to HIGH. The switch on the last monitor in the chain must be set to 75Ω.

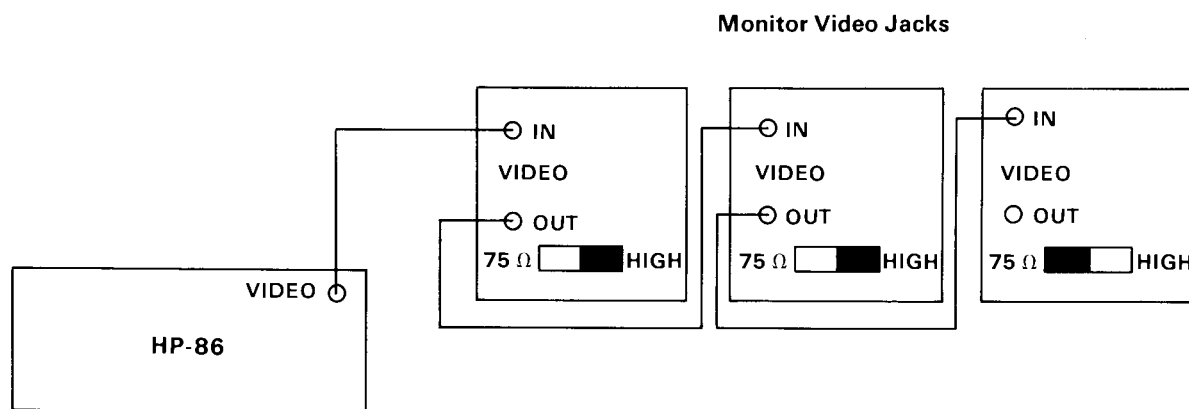

Connecting Multiple Monitors

CAUTION

When using multiple monitors, make certain only the final monitor in the chain has its 75-ohm termination switch set to 75Ω. Damage to the computer can occur if other monitors in the chain are set to 75Ω.

Getting Started

Now that you've installed any plug-in modules and connected the peripheral devices, you are ready to start learning how to put the HP-86 to work for you.

This section is designed to provide you with an overview of the HP-86. In order to get you "up and running" in a few hours, the section introduces a number of topics in relatively few pages. If you key in the examples as shown, you will, by the time you're finished, have acquired some experience in:

- Performing arithmetic calculations from the HP-86 keyboard; that is, using the HP-86 as a desktop calculator.
- Assigning values to variables.
- Editing the contents of the display.
- Entering, running, and halting programs.
- Storing programs onto a flexible disc.
- Generating, storing, and retrieving a graphics display.
- Retrieving and running a prerecorded program provided on the demonstration disc.

Detailed discussions of the HP-86 functions, commands, statements, and other features are presented in the *HP-86/87 Operating and BASIC Programming Manual*.

Discussions throughout this section assume that you've set the device addresses of the disc drive unit and peripheral printer as described in section 3.

Power On

If your system includes a monitor, turn it on. Then, set the power switch on the rear panel of the computer to ON (setting 1). The amber power light below the keyboard indicates that the computer is receiving power. If the power light does not come on, check the power connection and the fuse as described in section 2.

When the cursor (rectangular block) appears in the upper left corner of the display (the *home* position), the computer is ready to use. If your system includes a disc drive unit and if a flexible disc is present in drive 0, the system will automatically search for a program file named `AUTOSET` (*Automatic start*). The automatic start feature enables the computer to load and run a program on its own when power is turned on.

The computer performs a self-test when the power is switched on. If it discovers a problem in its circuitry, the computer informs you it has failed the self-test by beeping and displaying:

```
Error 23 : SELF TEST
```

Failure to pass the self-test indicates the system is not operating properly. Contact your local authorized dealer or your nearest HP sales and service facility (addresses provided in the back of the *HP-86/87 Operating and BASIC Programming Manual*).

Note: If the computer returns `Error 110 : I/O CARD` at power on, make sure that no plug-in interface module has select code 7, which duplicates the select code of the integrated HP-IB interface.

The computer also checks to determine whether any installed ROM modules are incompatible with the HP-86. If an incompatible ROM has been installed, the computer informs you by displaying the message:

```
Warning 27 : 85 ROM IGNORED
```

Incompatible ROMs should be removed to prevent possible improper operation of the computer.

If the power light is on but the display remains blank, hold down the `(SHIFT)` key and press `(RESET)`. (This key has both an unshifted and shifted operation associated with it. Like the number keys on a typewriter, shifted operations are shown on the upper half of the key, unshifted operations on the lower half.) This operation resets the computer to a ready state.

If the cursor has not appeared, or if it is too pale or too bright, adjust the monitor brightness and contrast controls. If the display remains blank, turn off both the computer and monitor and call the nearest HP Series 80 dealer or HP sales and service facility for further assistance.

The `(END LINE)` Key

Before you start performing calculations and entering programs, you need to understand the purpose of the `(END LINE)` key.

When you press `(END LINE)`, the line on which the cursor is located is entered into the computer, where the line is first checked to see that you made no errors in formulating the information to be processed. If the line begins with a line number, the computer interprets the line as a program statement and enters the line into program memory. If the line has no line number, the computer immediately performs the operation. Operations performed immediately “from the keyboard” rather than by running programs are called *calculator-mode* operations.

If the cursor is positioned on an empty line when you press `(END LINE)`, the cursor moves to the first column of the next line.

The `(SHIFT)` Key

Before you start entering information, make sure the `(CAPS LOCK)` key is level with the other keys in its row. With `(CAPS LOCK)` in this position, the HP-86 keyboard produces unshifted uppercase letters and shifted lowercase letters. The `(CAPS LOCK)` key only affects keys with one uppercase letter on the key surface. The rest of the keyboard operates like a typewriter in that unshifted keys access the character or operation printed on the lower portion of the key; shifted keys (holding down `(SHIFT)` while you press the key) access the character or operation printed on the upper portion of the key.

Manual Problem Solving

Type in the following lines exactly as shown, pressing **END LINE** to obtain the answer on the line below the input. The number keys and arithmetic symbol keys are located both on the typewriter and numeric keypad parts of the keyboard and can be used interchangeably.

Note: Spacing between numbers and symbols is arbitrary.

If you make a typing mistake, press **BACK SPACE** to erase incorrect characters and then retype the correct information.

```
5+6
  11
```

Enter this expression.

The computer returns this answer, indented one space for the sign.

```
9*8
  72
```

Enter this expression (* indicates multiplication).

The computer returns this answer.

```
2^9
  512
```

The ^ symbol indicates exponentiation.

The computer returns this answer, 2⁹.

```
SQR(16)
  4
```

SQR is the square root function.

The computer returns this answer, $\sqrt{16}$.

```
SIN(4)
-.756802495308
```

SIN is the sine function. At power-on, the computer is in *radians* mode. The computer returns the sine of 4 radians.

```
8.8E12/2.2E10
  400
```

Scientific notation; $(8.8 \times 10^{12}) / (2.2 \times 10^{10})$.

The computer returns this answer.

```
1234567*12345678
  1.52415666514E13
```

Enter this expression.

The computer displays very large and very small numbers in scientific notation.

Arithmetic expressions are typed algebraically. Parentheses are used to enclose the argument(s) on which a function operates. Parentheses are also used to enclose parts of the expression to change the order in which the computer performs arithmetic operations. (The arithmetic hierarchy, which establishes the order in which algebraic operations are performed, is discussed on page 32 of the *HP-86/87 Operating and BASIC Programming Manual*).

For example, the expression:

$$.938 (50 \sin .646) - \frac{(32) (.938)^2}{4 (.5)}$$

is evaluated by typing and entering the expression:

Parentheses enclose argument of SIN function.

```
.938*50*SIN(.646)-32*.938^2/(4*.5) (END LINE)
14.156166441
```

Exponentiation performed before multiplication.

Multiplication performed before division.

Error and Warning Messages

No keyboard operation is capable of damaging your computer system. The computer will return an error or warning message if you attempt an improper operation.

If you attempt to enter a line that contains an improperly constructed expression, statement, or command, the computer beeps and displays the word `ERROR` followed by a number and short description. Errors received when you attempt to enter a line, called *syntax* errors, are usually easily remedied; simply correct the error using the computer's editing features and enter the corrected line. Display editing is covered on pages 27 and 28.

If, after receiving an error message, you desire additional information about the nature of the error, refer to the list of error messages in appendix F of the *HP-86/87 Operating and BASIC Programming Manual*.

Example: Attempt to enter the expression:

```
3*(5-2
```

The expression is incomplete because the right parenthesis is missing. Since the computer cannot interpret the expression, it returns an error message and moves the cursor to the position in the expression where it first detected the error—in this case, the `*` symbol.

```
3*(5-2
Error 88 : BAD STMT
```

To correct the line, use the \rightarrow key to move the cursor past the `2` and type a right parenthesis. Then, enter the line; the line beneath the expression is cleared before the result is displayed. If you'd rather not correct the line, you can move the cursor to a new line and enter another expression.

Certain math calculations, though properly constructed, cannot be evaluated (for example, expressions that generate answers too large or too small for the computer to handle). For errors numbered 1 through 8, the computer displays a warning message and automatically provides a default value for the answer.

Example:

```
5/0
Warning 8 : /ZERO
9.999999999999E499
```

Attempt to divide by zero.
Computer displays warning message
and the default value.

If you'd prefer to receive error messages for errors 1 through 8, you can change the computer's method for handling math errors (discussed on page 82 of the *HP-86/87 Operating and BASIC Programming Manual*).

Display Editing

In addition to **(BACK SPACE)**, the HP-86 provides a set of display editing keys located on the upper right part of the keyboard.

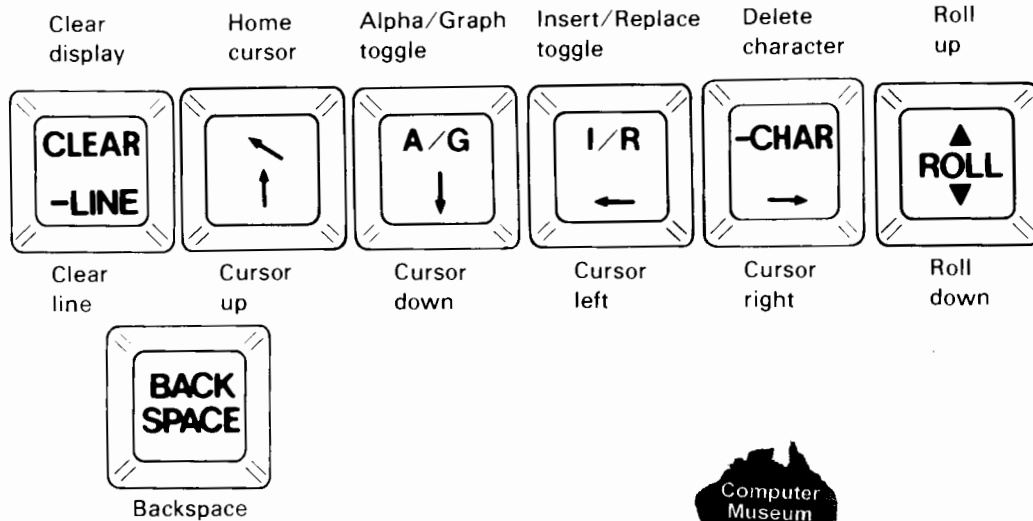

Suppose you'd like to edit a previously entered expression:

Original expression:

```
.938*50*SIN(.646)-32*.938^2/(4*.5)
```

Changes:

Change .646 to .7

Change 50 to 55.67

First, the cursor must be positioned on the line in which the expression appears. The **(↑)** and **(↓)** keys move the cursor up and down without changing the contents of the screen. If the previously entered expression has rolled up out of view, use the **(ROLL)** key to bring the expression back down onto the screen. (**(SHIFT) (ROLL)** rolls the screen contents upwards.)

Now that the cursor is on the proper line, use the **(←)** or **(→)** key to position the cursor over the first change:

```
.938*50*SIN(█.646)-32*.938^2/(4*.5)
```

Type **7** over the first digit of **.646**. Then, when the cursor is positioned over the **4**, press the **(-CHAR)** (*delete character*) key twice. The **46** will be deleted, and characters to the right will move to the left to fill the gap. The expression should now be:

```
.938*50*SIN(.7█)-32*.938^2/(4*.5)
```

Next, position the cursor over the **0** in **50** and type **5** over the **0**. To make room for the next two digits, you'll need to place the keyboard into insert mode by pressing **(I/R)** (*insert/replace*). When you press **(I/R)**, the cursor doubles in width.

```
.938*5█5█*SIN(.7)-32*.938^2/(4*.5)
```

Characters typed in are inserted between the two characters highlighted by the cursor. When you've typed in the characters `.67` press `(I/R)` again to return the display to replace mode. Then press `(END LINE)` to compute the answer.

```
.938*55.67*SIN(.7)-32*.938^2/(4*.5)
19.5625515323
```

Now, suppose you'd like to evaluate the expression `.938*55.67*SIN(.7)`. You could place the cursor over the minus sign and hold down the `(-CHAR)` key until the rest of the line was deleted. An easier way is to use the `(-LINE)` key to clear the line from the cursor position to the end of the line. Position the cursor over the minus sign and press `(-LINE)`. Then press `(END LINE)` to evaluate the expression.

```
.938*55.67*SIN(.7)
33.6400555323
```

The `(CLEAR)` (shifted) key clears the display and returns the cursor to the *home* position (upper left corner). You can home the cursor at any time without erasing the display using the `(↵)` (shifted) key.

Variables

So far, the examples have evaluated expressions composed of numbers. In many applications, it is preferable to evaluate expressions using variables. A variable specifies a location in computer memory where information is stored. Each variable is given a unique name which is used to retrieve or alter the stored information.

The HP-86 provides four types of variables:

- Simple numeric.
- Simple string.
- Numeric array (subscripted).
- String array (subscripted).

Each variable name can be up to 31 characters long. Names can contain any combination of letters, digits, and the underscore character, with the following constraints:

- The first character of any variable name must be a letter.
- The last character of any string variable name, simple or array, must be the character `⌘`.
- Uppercase and lowercase letters are not interchangeable. For example, `LENGTH`, `Length`, and `length` are each unique variable names.
- Variable names cannot be BASIC keywords (for example, `PRINT`, `RUN`).

Example:

```
LENGTH=5
WIDTH=2
AREA=LENGTH*WIDTH
AREA
10
```

```
Assigns value 5 to numeric variable LENGTH.
Assigns value 2 to numeric variable WIDTH.
Evaluates LENGTH*WIDTH and assigns value to AREA.
Directs computer to fetch and display value of AREA.
```

Typing Aids

Keys (k1) through (k14) operate in calculator mode (when no program is running) as typing aids for certain BASIC keywords. To view the typing aid assignments, press (SHIFT) (KEY LABEL). The *key labels* for all 14 keys will appear in seven inverse video boxes at the bottom of the screen.

TRACE VAR	CRT IS	PRINTER IS	INITIALIZE	SCRATCH	LOADBIN	STOREBIN
AUTO	DISP	PRINT	MASS STORA	DELETE	LOAD	STORE

Pressing unshifted ((k1) through (k7)) or shifted ((k8) through (k14)) keys displays the assigned BASIC keyword or sequence of keywords at the current cursor position. You'll have an opportunity to use the typing aids later in this section.

The typing aid assignments have been printed onto one of the keyboard overlays packaged with the computer. To position the overlay around the keys, insert the right-hand side into the slot on the computer case; then flex the overlay to insert the other side into the two slots to the left of the keys.



Addressing Peripheral Devices

If your system includes a peripheral printer and a disc drive unit, you must supply the computer with certain information before it can access those devices.

To access a peripheral plotter your system must include a Plotter ROM (HP part number 00087-15002). Refer to documentation accompanying the Plotter ROM for information on addressing your plotter. Graphics output is automatically directed to the display when no peripheral plotter has been addressed.

Accessing the Printer

At power-on, the computer assumes that the printer address is 1, the address (*select code*) of the monitor. If your system doesn't include a printer, output ordinarily printed is directed to the monitor.

If your system includes a printer, a `PRINTER IS` statement must be executed to establish an address to which printed output is routed.

Turn your printer on and set it to ON-LINE.

If the printer is connected to the HP-IB interface, press (k10) to display `PRINTER IS` and then type in the rest of the line:

```
PRINTER IS 701,80
```

If you prefer, you can type `PRINTER IS` instead of using the typing aid.

The optional parameter `80` is the number of characters per line.

If your printer is connected using a different interface, enter the appropriate statement(s):

```
PRINTER IS 8,80          HP 82949A (Parallel) Printer Interface.  
PRINTER IS 10,80       HP 82939A Serial Interface.
```

Now, test your system by entering this statement:

```
PRINT "THIS IS A TEST!"
```

Your printer should print the text that is enclosed in quotes. If it doesn't, make certain the printer is on and on-line and that its device address has been properly set.

Accessing Mass Storage

If you turned on your disc drive unit before you turned on the computer, the computer will automatically access drive 0 for all operations involving mass storage. If you didn't turn on the disc drive unit first, enter the statement:

```
MASS STORAGE IS ":D700"
```

Now, insert the demonstration disc provided with the computer into drive 0. Insertion of a micro-flexible disc is shown below. With micro-flexible discs, you must first slide the disc guard away to expose the recording surface. Then, with the centering hub facing down, insert the disc so the disc guard will contact the rear of the drive.

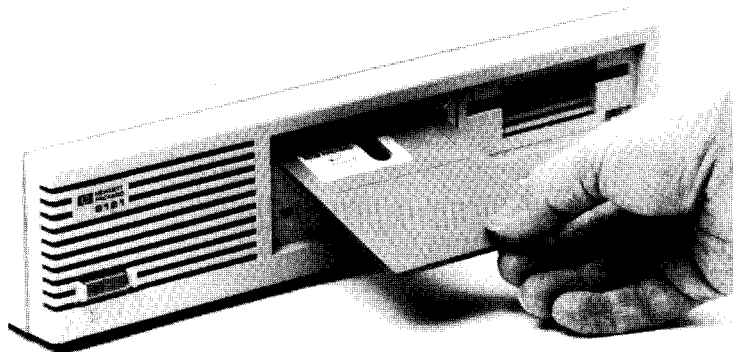

For 5¼-inch discs, insert the disc with the label side up and nearest you. Then close the drive latch gently to secure the disc in the drive.

CAUTION

Attempting to force the drive latch closed when the flexible disc is improperly aligned in the drive could cause damage to the disc.

To test your mass storage system, obtain a directory, or catalog, of the contents of the disc by executing the `CAT` statement.

```
CAT
```

The drive light will come on while the computer accesses the disc. The directory heading is then displayed,

```
CAT
C Volume D: DEMO
Name      Type Bytes  Recs
```

followed by an entry for each file stored on the disc. Directory listings are discussed in section 20 of the *HP-86/87 Operating and BASIC Programming Manual*.

Later in this section, you'll use your mass storage system to store and retrieve programs.

Programming With the HP-86

Programming, like performing keyboard calculations, is a problem-solving process. When you run a computer program, you are directing the computer to perform a series of operations in a particular order. Programs can direct the computer to make decisions and request, obtain, manipulate, and provide information.

The BASIC language consists of a number of functions, statements, and commands that provide you with a "vocabulary" the computer understands. You've already seen some examples of functions—`SIN` and `SQR`. You've also already directed the computer to perform, or execute, the `PRINTER IS` and `CAT` statements. In the next few pages, you'll be briefly introduced to a number of other statements and commands as you enter and run two programs.

Erasing Program Memory

Programs are stored in the computer in program memory. Before you enter a program, you should erase, or scratch, any current contents of program memory. To erase program memory, execute the `SCRATCH` command. You can type the word `SCRATCH`, or use the typing aid `(k12)`.

```
SCRATCH
```

`SCRATCH` is categorized as a command, rather than a statement, because it cannot be executed in a program.

Entering a Basic Program

The following BASIC program requests you to input the length and width of a rectangle and prints the data you input. It then computes the area and prints the answer.

Before you start entering the program, you may wish to clear the display by pressing `(CLEAR)` (a shifted key).

Now enter the following short program by typing one line at a time. When you've finished typing each line, press **(END LINE)** to enter the line into program memory.

```

10 REM *****THIS PROGRAM COMPUTES THE AREA OF A RECTANGLE*****
20 DISP "ENTER LENGTH"
30 INPUT LENGTH ! Enter LENGTH.
40 PRINT "LENGTH =";LENGTH
50 DISP "ENTER WIDTH"
60 INPUT WIDTH ! Enter WIDTH.
70 PRINT "WIDTH =";WIDTH
80 AREA=LENGTH*WIDTH ! Compute AREA.
90 PRINT "AREA =";AREA
100 END

```

Running the Program

To run the program, press **(RUN)**. As long as the program is running, the power light will blink on and off.

The following chart shows the information you must input from the keyboard and the program's output to the display and printer. Each time the program requests data, program execution temporarily halts until you've entered the required information. However, the power light continues to blink. After you type in the requested information and press **(END LINE)**, program execution resumes.

Statement(s) Being Executed	Key in This Information	Output to Display	Output to Printer
	Press (RUN)		
20,30		ENTER LENGTH ?	
30	5		
40			LENGTH = 5
50,60		ENTER WIDTH ?	
60	2		
70			WIDTH = 2
90			AREA = 10

Storing Programs

If your system includes a disc drive unit, you can store the program onto a flexible disc. You may use the demonstration disc or a new, empty disc.

If you choose to use an empty disc, you must first prepare the disc by a process called *initialization*, discussed next. If you'll be using the 5¼-inch demonstration disc, you must first remove the write-protect tab. (Refer to page 305 of the *HP-86/87 Operating and BASIC Programming Manual*. Then, skip the discussion Initializing a Flexible Disc and go on to The Store Command.)

Initializing a Flexible Disc

Before you use an empty disc for the first time, it must be initialized. Initializing the disc prepares it to accept information from the computer. During the initialization process, any previously stored information is erased; therefore, never initialize a disc that contains information you may later wish to access.

If you intend to store the program you've just entered, remove the demonstration disc from drive 0 and place an empty disc in drive 0.

Note: The initialization process erases any previous contents of the disc. Make sure you have removed the demonstration disc from drive 0 before you execute the INITIALIZE statement.

Next, execute the INITIALIZE statement. You can type the statement or use the typing aid provided on **(k11)**.

```
INITIALIZE
```

Initialization takes approximately three minutes. When the drive light goes out, the disc is initialized and ready to use. Use the CAT statement to display the empty disc directory.

```

E Volume 0:
Name      Type  Bytes  Recs

```

The STORE Command

To store the program in computer memory onto the flexible disc, execute a STORE command. The name you wish to assign to the file is enclosed in quotation marks.

```
STORE "RECTANGLE"
```

The file name can be up to 10 characters long; you can use any characters except quotation marks ("), colon (:), or period (.).

The drive light for drive 0 will be on while the program is being stored. Now, execute the CAT statement to obtain a directory listing that includes the new entry for the program (PROG) file you've just created.

```

E Volume 0:
Name      Type  Bytes  Recs
RECTANGLE  PROG   256    2

```

Generating a Graphics Display

This next program introduces you to the HP-86 graphic capabilities. Before you enter the program, you should erase the previous program from memory using the SCRATCH command.

So far, you've been viewing up to 16 lines of information at a time. The PAGESIZE statement allows you to choose whether the monitor displays a maximum of 16 or 24 lines. To display 24 lines of information, execute:

```
PAGESIZE 24
```

When you want to return the display to the 16-line format, execute PAGESIZE 16.

To make entering the program easier, the HP-86 provides automatic line numbering when you execute the AUTO command. You can type in the word or use the typing aid on **(k1)**.

```
AUTO
```

The first line number, 10, is displayed and the cursor is positioned on the line, awaiting the statement you'll enter.

```
AUTO
10 █
```

After you've typed in and entered the statement, the computer automatically displays the next line number, 20, on the following line. Each time a statement is entered, the computer automatically increments the line number by 10. (You can change the starting line number and increment value using optional parameters with the AUTO command. This feature is discussed in section 5 of the *HP-86/87 Operating and BASIC Programming Manual*.)

Now, enter the following program:

```
10 GCLEAR
20 PLOTTER IS 1
30 SCALE 0,100,0,110
40 GRID 2,2
50 LOCATE 27,RATIO *100-27,18,82
60 PEN -1
70 GRID 2,2
80 PEN 1
90 FRAME
100 SCALE -50,50,-50,50
110 MOVE 50,0
120 DEG
130 FOR ANGLE=0 TO 360 STEP 10
140 DRAW 50*COS (ANGLE),50*SIN (ANGLE)
150 NEXT ANGLE
160 CSIZE 10,.5,0
170 MOVE -20,25 @ LABEL "Welcome To"
180 CSIZE 15,1,30
190 MOVE -35,-5 @ LABEL "GRAPH"
200 CSIZE 10,.5,0
210 MOVE -8,-30 @ LABEL "Mode"
220 END
```

When you've entered statement 220, the computer displays 230 on the next line. To stop automatic numbering, backspace over 230 and execute the NORMAL statement.

```
220 END
NORMAL
```

Now, press **(RUN)**. The display enters *graph* mode as the program produces graphics output, and you will be viewing the computer's graphics display. (The display you are viewing when you perform calculations and enter programs is called the alpha display.)

When the computer has finished executing the program (the power light will stop blinking), the graphics display contains a greeting.

Note: The actual shape of displayed graphics output depends on the dot spacing of your display device.

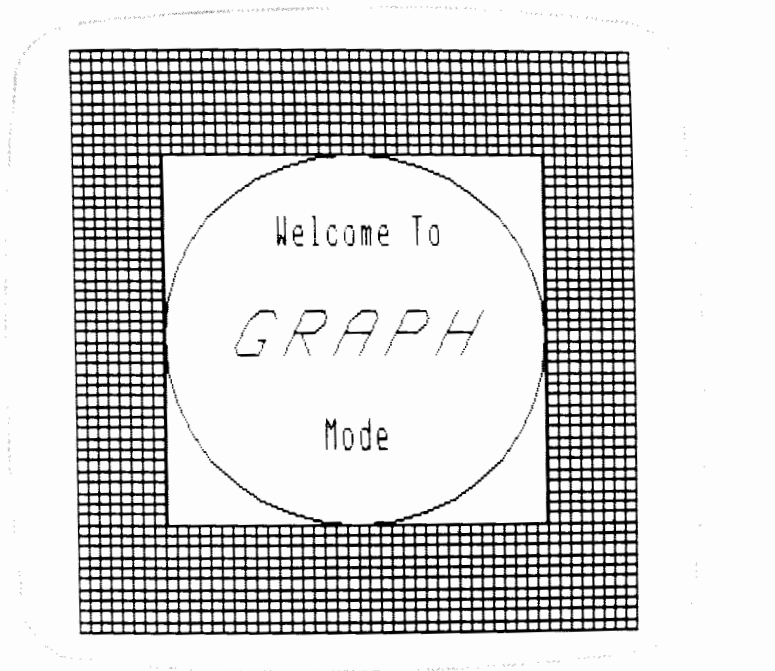

Press the `(A/G)` (*alpha/graphics*) toggle key to return the display to *alpha* mode. To view the display again, press the `(A/G)` toggle once again.

Note: Actually, when the HP-86 is in *graph* mode, pressing almost any key causes the display to revert to *alpha* mode.

If you'd like to preserve the program for future use, switch to *alpha* mode and execute:

```
STORE "GREETING"
```

Your directory listing should now contain two entries by you:



```
[ VOLUME ]:
Name      Type  Bytes  Recs
RECTANGLE  PROC   256    2
GREETING  PROC   256    2
```

Storing and Retrieving a Graphics Display

There may be times when you want to access a graphics display without having to run the program that originally generated the display. The HP-86 allows you to store the contents of the graphics display onto a disc and to retrieve the stored display.

To store the display, execute the `GSTORE` statement:

```
GSTORE "PICTURE"
```

The display switches to *graph* mode when you execute `GSTORE`. When the operation is completed (in approximately 15 seconds), press `(A/G)` to return the display to *alpha* mode. Then, use the `CAT` statement to display the updated file directory containing the graphics (`GRAF`) file.

```

C Volume J:
Name      Type  Bytes  Recs
RECTANGLE  PROC  256    2
GREETING   PROC  256    2
PICTURE    GRAF  256   47

```

Now that you've preserved your graphics "picture," you can clear the graphics display by executing:

```
GCCLEAR
```

The computer will switch to *graph* mode, and the display will be erased from top to bottom. When the graphics display has been `GCLEAR`d, use the `(A/G)` key to return to *alpha* mode.

To retrieve the contents of the `GRAF` file, execute a `GLOAD` statement:

```
GLOAD "PICTURE"
```

The display enters *graph* mode as the contents of the file are entered into the graphics display.

Retrieving Programs

A stored or prerecorded program is retrieved into computer memory by executing the `LOAD` command. With the demonstration disc in drive 0, execute:

```
LOAD "PIE-86"
```

to load the prerecorded program named `PIE-86` into the computer. When the drive light goes off, press `(RUN)`.

The program displays a key label for each of the languages in which data can be displayed. Press the appropriate key. The drive light goes on while the program loads a binary program and data from files on the demonstration disc. The program then draws and labels a pie chart illustrating the proportion of time devoted to various tasks during a 40-hour work week.

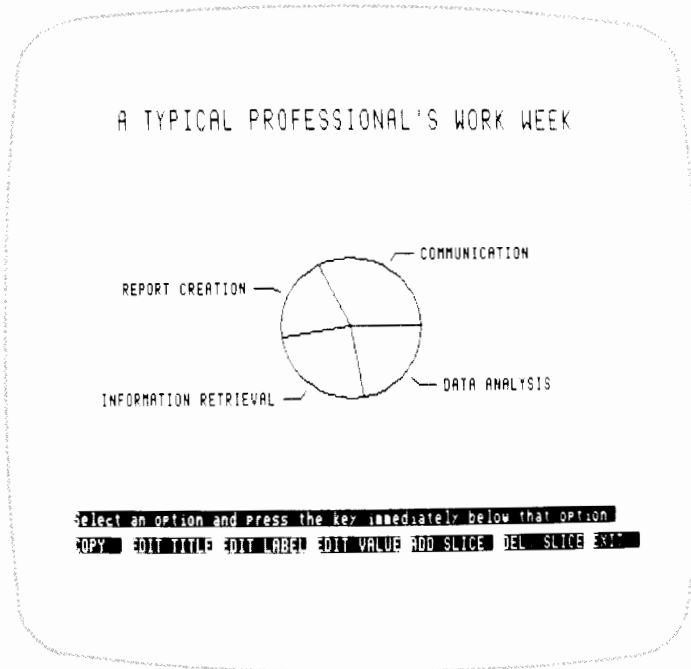

The inverse video boxes at the bottom of the screen are key labels for keys (k1) through (k7). The program allows you to edit the chart's title and labels. You can also change the relative size of the pie slices and increase or decrease the number of slices. If you enter any changes that alter the size of the slices (keys (k4), (k5), and (k6)), the program calculates the new value for the total area (currently 40 hours) and computes the proportional size of each slice.

Example: To change the chart's title, press (k2). Type the new title; it will be displayed beside the question mark.

```
New title? (40 characters maximum)
?CLEMENT'S WORK WEEK
```

Press (ENDLINE) to enter and draw the new title.

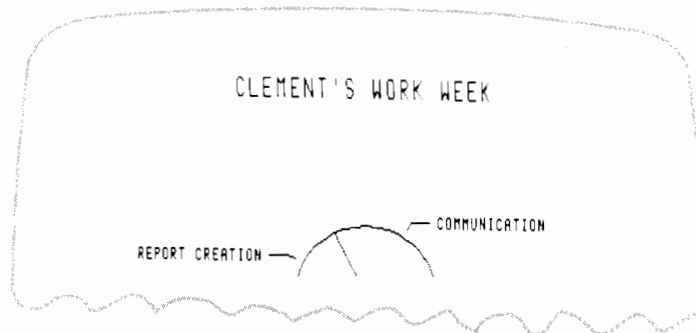

The pie chart must be edited further. Clement actually works a 42 hour week. Two of the hours currently included in the COMMUNICATION slice and an additional two hours on Thursday evening are spent reviewing literature produced by his department.

To subtract 2 hours from the COMMUNICATION slice, press (k4). The program numbers the 4 slices and requests the number of the slice to be changed:

```
Enter the number of the slice to be edited
?1
```

The program displays the current value of slice #1 and the total value. Enter the new value.

```
New value? COMMUNICATION Current value: 13
?11 Current total: 40
```

When the program has drawn the new pie chart, press (k5) to add a slice. Enter the new label and value.

```
New label? (21 characters maximum)
?READING/REVIEWING
New value? READING/REVIEWING Current total: 38
?4
```

The final pie chart should look like this:

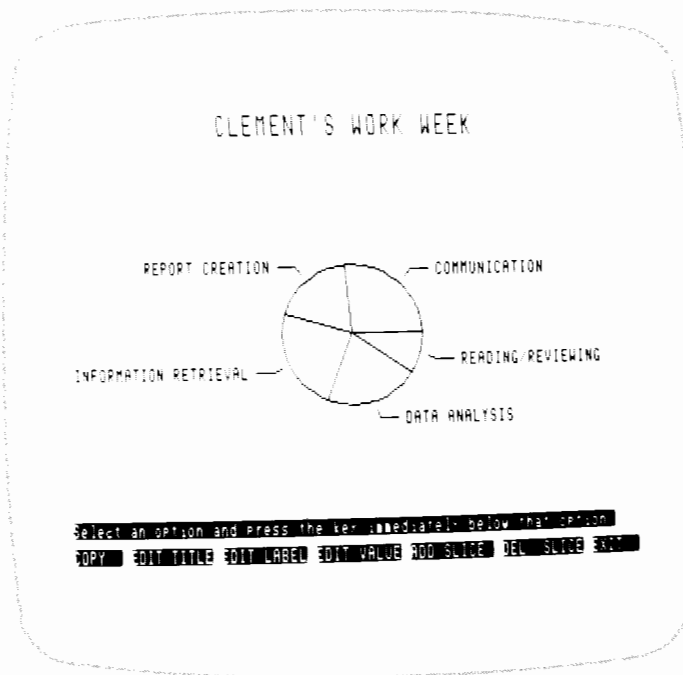

Press (k7) to halt the program and erase the display.

Creating Keyboard Overlays

The blank keyboard overlay packaged with the computer allows you to create your own key labels. Use a soft lead pencil to create an erasable overlay. For permanent labels, use a felt tip pen with water-insoluble ink or a grease pencil.

Packages of additional keyboard overlays can be purchased (HP part number 82956A).

Listing a Program

The **(LIST)** key allows you to obtain a listing of the program currently in program memory. When you press **(LIST)**, the first 15 (for `PAGESIZE 15`) or 23 (for `PAGESIZE 24`) lines of the program are displayed on the CRT. Repeatedly pressing **(LIST)** displays additional 15- or 23-line program segments. When the last statement has been listed, the computer displays the number of bytes of unused computer memory.

To obtain a printed listing of the entire program, press **(PLST)**.

Halting Program Execution

The **(PAUSE)** key is used to halt a running program at any time, returning control of the computer from the program to the keyboard user. When you press **(PAUSE)** while a program is running, the computer beeps and the power light stops blinking.

Pressing almost any other key during program execution halts the program and causes the computer to perform the key's indicated function.

To resume (continue) program execution from the point at which the program was halted, press **(CONT)**.

HP-86 Integrated Interfaces

Introduction

The HP-86 contains two integrated interfaces—the *HP-IB interface* and the *monitor interface*. The HP-IB interface allows the HP-86 to communicate with and control peripheral devices such as printers, disc drive units, and plotters. This interface is accessed through the HP-IB cable connector on the back panel of the HP-86. The monitor interface is accessed through the VIDEO jack on the back panel.

Plug-In ROMs

The computer is designed to perform a number of input and output operations involving disc drive units and peripheral printers. For some applications, however, you will need one of the following ROMs.

- HP-87 Plotter ROM (part number 00087-15002).
- HP-87 I/O ROM (part number 00087-15003).

The Plotter ROM allows the HP-86 to output graphics to a peripheral plotter. The I/O ROM is a general purpose ROM used to greatly enhance the input/output flexibility of your HP-86 computing system.

The ROMs are installed into a ROM drawer which is then installed into any of the four module ports on the back of the computer.

Peripheral Load

The HP-IB interface can support up to 14 peripheral devices. If your system exceeds these limitations, an additional HP 82937A HP-IB Interface Module can be installed into one of the computer's four module ports.

In order for the system to operate properly, at least half the devices connected to the interface must be switched to ON. (The computer counts as one device.)

Accessory Cables

WARNING

Do not attempt to install any of the accessory cables until you've read the installation instructions on pages 42 and 43. Failure to follow installation instructions could result in a shock hazard.

Accessory cables are used to connect peripheral devices to the HP-86. They are available in a variety of lengths:

Length	Model Number
0.5 meter	HP 10833D
1 meter	HP 10833A
2 meters	HP 10833B
4 meters	HP 10833C

To ensure proper operation of the interface, two rules regarding cable length must be observed:

1. The total length of cable permitted for all peripherals connected via the interface must be less than or equal to 2 meters times the number of devices. (The computer is counted as one device.) For example, if you intend to have a printer, disc drive unit, and plotter connected to the HP-IB, the total length of the cables must not exceed 8 meters.
2. Regardless of the number of peripheral devices, the total length of cable must not exceed 20 meters.

Connecting Peripherals

It is extremely important that you read through and understand the installation instructions before you start the installation process. Failure to follow proper installation procedures could result in a safety hazard or temporary unpredictable equipment performance.

SAFETY PRECAUTION

Manufacturers of peripherals do not all use the same grounding technique. Often, earth ground and logic ground of the peripheral and computer are at different voltage levels. In some instances, this is a deliberate effort to reduce ground return interference with digital signals.

When an accessory cable is attached to the computer, its ground is connected to earth ground and to logic ground. Thus, if the earth and logic ground levels of a peripheral are different, either by design or due to a defect, the potential for a hazardous shock exists unless installation procedures are strictly followed.

A peripheral is properly grounded if it uses a three-prong power plug and if it is plugged into an outlet with matching configuration. Use of a three-prong to two-prong adapter does not provide adequate grounding, since the grounding may be interrupted or nonexistent.

1. Set the power switches on the computer and all peripherals to the OFF position. However, make sure the computer power cord is plugged into a grounded (three-wire) ac outlet.

WARNING

Always turn off the computer and all peripheral devices to be connected or already connected to the computer before connecting the accessory cable to or disconnecting the cable from the computer cable receptacle. Failure to do this could result in a shock hazard.

2. Attach an accessory cable to the cable receptacle on the rear of the computer. The cable must be oriented such that the threads of the mounting fastener screws face in towards the computer. Tighten the screws by hand to ensure a firm connection.
3. Attach the other end of the accessory cable to the peripheral device and tighten the mounting fasteners. On some peripherals, the connectors will not be compatible. If this is the case, an HP 10834A Adapter is required.

Note: Accessory cables are supplied with mounting fasteners having metric threads. If your peripheral device requires National Coarse (American) threads, you will need to replace the mounting fasteners on the accessory cable. A metric conversion kit is available (part number 5060-0138) to supply the necessary fasteners. Refer to appendix A of the operating and programming manual for ordering information.

4. Additional peripherals are connected by attaching and fastening one end of an accessory cable to the peripheral and stacking the other end in piggy-back fashion onto a previously attached accessory cable. There are no restrictions on how many connectors can be stacked together. However, to avoid mechanical strain, it is recommended that no more than three connectors be stacked together on one device.
5. After all the peripherals are connected, set the power switch of each of the peripherals to be operational on the interface to the ON position. At least half the devices connected to the HP-IB interface must have their power switches turned to ON in order for the interface to operate properly. The HP-86 is counted as one device. For example, if there are three peripheral devices on the interface, two must have their power on.
6. Set the power switch on the HP-86 to ON.



Disconnecting Peripherals

To disconnect a peripheral device from the HP-IB interface:

1. Turn off the computer and all peripheral devices.
2. Disconnect the HP-IB cable from each peripheral device to be removed from the interface.
3. To disconnect all devices using the HP-IB interface, detach the cable connected to the computer HP-IB receptacle.

Addressing Peripheral Devices

The HP-86 is capable of sending data to and receiving data from a wide variety of peripheral devices. To ensure that it is communicating with an intended device, the computer must establish a unique location for each device.

The location, or *address*, of a device is described by three parameters:

- The interface *select code* identifies the interface used to connect the device to the computer. For interfaces which can support only one device at a time, the select code alone is sufficient to locate the device.
- When an interface can connect more than one device at a time, a combination of the select code and *device address*, called the *device selector*, locates a particular device.
- The *drive number* of a disc drive describes the drive in which a particular disc is located. The drive number is necessary because a disc drive at a particular address can have more than one drive.

The select code of the monitor interface is 1. Since only one monitor address can be present on this interface, the location of the monitor is defined by the select code alone.

Note: Multiple monitors can be connected using the monitor interface. However, when more than one monitor is attached, they share the same location and cannot be addressed individually.

The select code of the integrated HP-IB interface is 7 and cannot be changed by the user. Since more than one device can be connected using this interface, device addresses are necessary to ensure a unique location for each peripheral. Recommended settings for peripheral devices are shown on pages 45 through 46.

The HP-86 BASIC language has several DEVICE IS statements for establishing the location of peripherals:

```
CRT IS device selector
PRINTER IS device selector
PLOTTER IS device selector
MASS STORAGE IS mass storage unit specifier
```

The *device selector*, used to locate all peripherals except mass storage devices, has the form:

```
interface select code [device address ]
  one or two digits      two digits
  1 through 10          00 through 99
```

The brackets around *device address* indicate that it is used sometimes, but not always.

Examples:

The following statement directs output ordinarily displayed on the monitor to the printer connected to the integrated HP-IB interface:

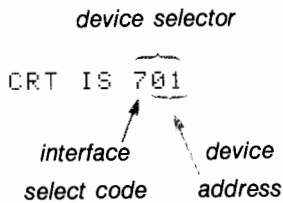

To direct display output once again to the monitor, execute the statement:

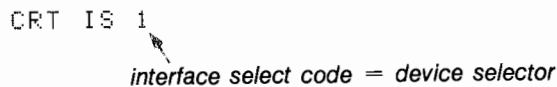

The *mass storage unit specifier (msus)*, used to locate disc drive devices, has the form:

```
" : [ interface select code device address drive number "
  one or two digits      one digit      one digit
  1 through 10          0 through 7      0 through 9
```

To establish drive 1 as the default mass storage location, execute the statement:

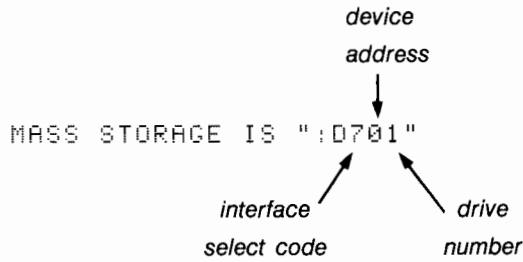

The *file specifier*, discussed in section 20 of the *HP-86/87 Operating and BASIC Programming Manual*, allows the computer to access files located elsewhere than at the default or declared system mass storage device.

HP-86 Talk/Listen Address

The HP-86 computer has its own device address on the HP-IB interface, called its *talk/listen address*. The talk/listen address is factory preset to 21 and cannot be changed by the user. Since this address should not be duplicated by any device connected to the computer, never set the address of a peripheral to 21.

Note: The I/O ROM uses the talk/listen address to specify the computer as either the *talker* (output device) or the *listener* (input device) during certain types of input/output operations.

Setting Peripheral Device Addresses

Each peripheral device connected to the computer via the HP-IB interface must have a unique two-digit device address. The device address is set by a switch usually located on the rear panel of the instrument. Refer to documentation accompanying the peripheral device for information on the device address switch.

This manual assumes that you have peripheral devices set to the addresses listed below. The accompanying illustrations show device address switches of several devices and the positions of the switch elements when the address is set as specified. If necessary, reset the switch to match the illustration. If your system includes devices other than the ones shown below, consult the documentation accompanying those devices for further instructions.

Disc drive unit—Set device address to 0.



Device address switch of HP 9121D/S Disc Memory Unit.

Printer—Set device address to 1.

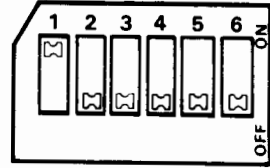
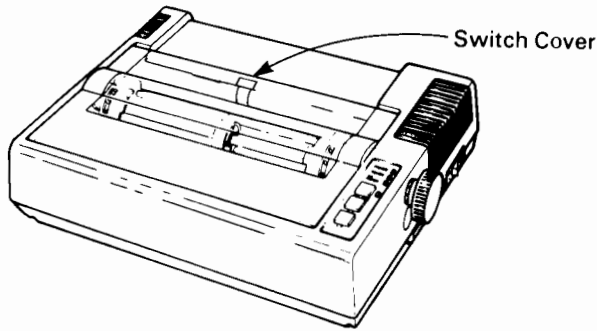

Device address switch of HP 82905B Printer.

Access to this switch is gained by removing the switch cover on the upper case of the printer.

Plotter—Set device address to 5.

The shaded portion of each switch is flush with the switch housing.

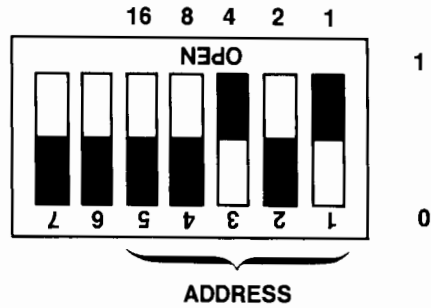

Device address switch of HP 7470A Plotter.

If you are connecting other peripherals to the HP-IB interface, set them to any unused device address except 21 (the computer's preset address).

HP-IB Control Registers

In many situations the HP-IB interface exchanges information between the computer and peripheral devices with a minimum of intervention from the programmer. However, the interface is extremely versatile, and it can be adapted somewhat to meet particular user needs by changing the contents of its control registers. One common use of this capability is changing the instructions sent by the computer to the peripheral printer at the end of a line (the *end-of-line sequence*).

The HP-IB interface has 12 *control* (write-only) registers, numbered 0 through 3 and 16 through 23. The registers are not numbered consecutively in order to provide numbering compatibility with other HP Series 80 interfaces. Additional information about the interface is available in the *HP-IB Interface Owner's Manual* (Reorder number 82937-90017).

Registers are accessible with the `SET I/O`, `CONTROL`, and `STATUS` statements. The `SET I/O` statement discussed in section 10 of the *HP-86/87 Operating and BASIC Programming Manual* provides the ability to write to the interface control registers without additional ROMs or plug-in modules. The `CONTROL` and `STATUS` statements are explained in the information packet shipped with the I/O ROM, which must be installed before either statement can be used.

Control Registers 0 Through 3

Registers 0 through 3 are involved in regulating the transfer of information through the interface. They should not be accessed unless you have an HP-87 I/O ROM and you are familiar with how those registers affect operation of the interface. A complete control register table is presented below, followed by explanations of the individual registers.

CAUTION

Do not write to control registers 0 through 3 unless you have an I/O ROM and you are completely familiar with the function of these registers. In particular, control registers 2 and 3 provide direct access to the HP-IB control and data lines. Access to these lines must be performed with care, and only by persons aware of HP-IB protocols. It is possible to cause a bus malfunction or device damage by improper use of these registers.

Register Number	Bit Number								Default Value	Register Function
	7	6	5	4	3	2	1	0		
CR0	X	X	X	X	Odd	Even	Always One	Always Zero	0	Parity Control
CR1	IFC	LA	CA	TA	SRQ	DCL or SDC	GET	SCG	0	Interrupt Mask
CR2	X	REN	SRQ	ATN	EOI	DAV	NDAC	NRFD	Not Applicable	HP-IB Control Lines
CR3	DIO8	DIO7	DIO6	DIO5	DIO4	DIO3	DIO2	DIO1	Not Applicable	HP-IB Data Lines

Register 0: Parity Control

This register controls the parity mode for input and output data: no parity is used for commands. The right-most, non-zero bit controls the parity selection, with an all-zero value (CR0 = 0) meaning no parity (default at power-on). For example, CONTROL 7, 0; 4 selects even parity. CONTROL 7, 0; 6 selects always one parity (even though even parity has been indicated by bit 2 being set, right-most bit set is bit 1 = always one).

Register 1: Interrupt Mask

A bit, when set, enables the corresponding interrupt condition to cause an end-of-line branch.

- Bit 0, when set, enables interrupt when a secondary command that was received is stored in SR6, the secondary command register (page 52). This is an event-initiated interrupt.
- Bit 1, when set, enables interrupt when a GET (Group Execute Trigger) is received while addressed to listen (LA). This is an event-initiated interrupt.
- Bit 2, when set, enables interrupt either when DCL (Device clear) is received, or when SDC (Selected Device Clear) is received while addressed to listen (LA). This is an event-initiated interrupt.
- Bit 3, when set, enables interrupt when SRQ (Service Request) is true.
- Bit 4, when set, enables interrupt when TA (talker active: addressed to talk) becomes true. If TA is already true, then a 0-to-1 transition of bit 4 of CR1 causes an interrupt. This is a state-initiated interrupt.

- Bit 5, when set, enables interrupt when CA (controller active) becomes true (by receiving control). If CA is already true, then a 0-to-1 transition of bit 5 of CR1 causes an interrupt. This is a state-initiated interrupt.
- Bit 6, when set, enables interrupt when LA (listen active: addressed-to-listen) becomes true. If LA is already true, then a 0-to-1 transition of bit 6 of CR1 causes an interrupt. This is a state-initiated interrupt.
- Bit 7, when set, enables interrupt when an IFC (Interface Clear) occurs. An externally caused IFC can cause an interrupt even when the interface is the system controller. This is an event-initiated interrupt.

The following diagrams illustrate the interface response to state-initiated, event-initiated, and SRQ interrupts. The interrupt-cause status registers (SR1) bits are set when an interrupt occurs and cleared when the status of SR1 is read.

Note: Status registers are covered on pages 50 through 52.

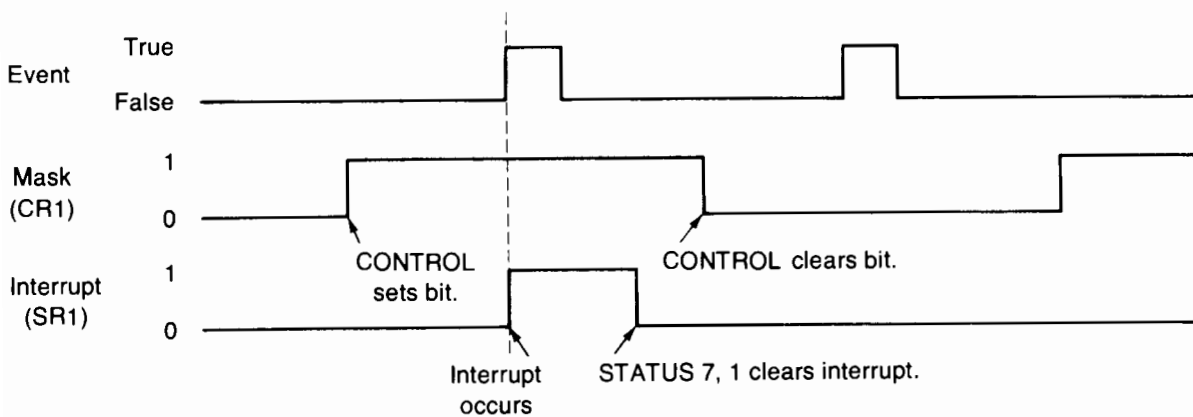
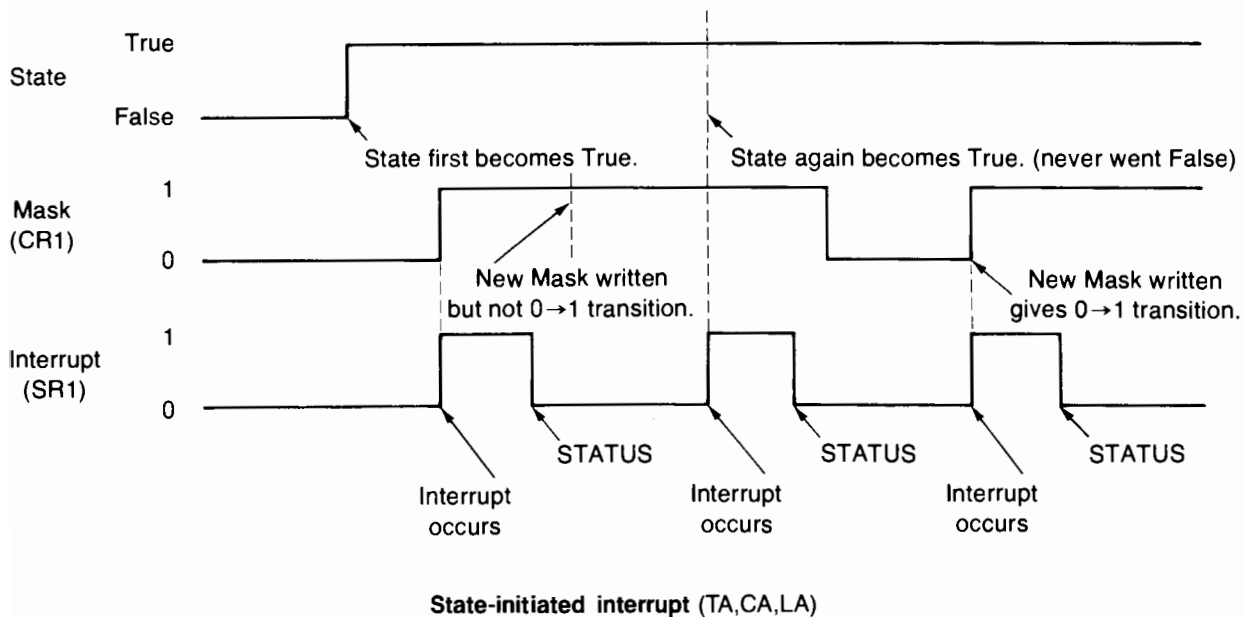

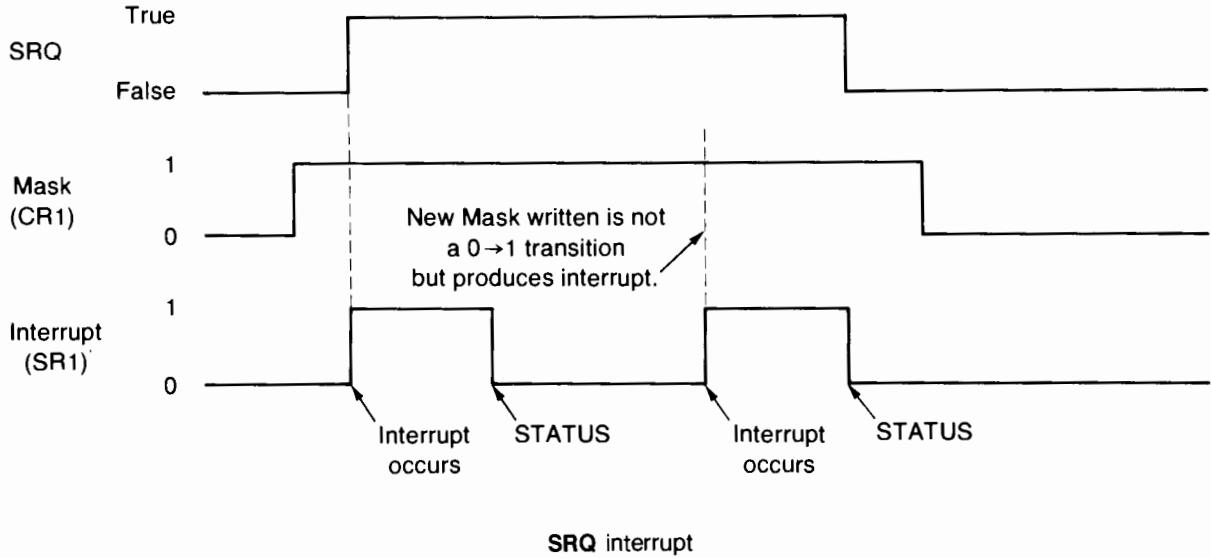

Register 2: HP-IB Control Lines

This register gives direct access to the eight HP-IB control lines. A bit, when set, causes the corresponding HP-IB control line to be set true for as long as the CR2 bit is set. The user is cautioned to be aware of bus protocols when using this register. For example, a non-controller may not set the ATN line true, and a non-system controller is not supposed to assert REN line.

Register 3: HP-IB Data Lines

This register gives direct access to the eight HP-IB data lines, DI01 through DI08. Setting a bit in this register causes the corresponding HP-IB data line to be set true. (The user should note; however, that HP-IB data lines are numbered 1 through 8 while the control register data lines are numbered 0 through 7.) The user should exercise caution when writing to CR3, the HP-IB data lines register. For example, by writing to CR3 while the interface is addressed to listen (LA state), a hardware conflict will occur in the interface that could cause erratic operation and damage to the interface.

Registers 16 Through 23: The End-of-Line Registers



Register 16

Bits 0 through 2 of register 16 contain the number of instructions in the EOL (end-of-line) sequence. Normally this is 2 (carriage return and line feed) but may be any integer from 0 through 7. Bits 3 through 6 are not used.

Bit 7 should be used only when the system includes an I/O ROM. When set, bit 7 causes the HP-IB control line EOI (*end-or-identify*) to be asserted with the last byte of a data transfer. If the EOL count is non-zero, EOI is asserted with the last character of the EOL sequence. If the EOL count is zero, EOI is asserted with the last character of the data list being output.

bit 7	bit 6	bit 5	bit 4	bit 3	bit 2	bit 1	bit 0
EOI Enable	X	X	X	X	Number of EOL Characters (default = 2)		

Registers 17 Through 23

Registers 17 through 23 contain the decimal code for each character sent as an EOL instruction. The default contents of registers 17 through 23 are:

Register Number	Contents	Meaning
17	13	Carriage return.
18	10	Line feed.
19 through 23	0	Null—no action.

Status Registers

These registers are read by executing the `STATUS` statement with the I/O ROM installed. For example, to return the value of Status Register 3 in variable `S3`, execute `STATUS 7, 3; S3`. A complete status register table is given, followed by explanations of the individual registers.

Status Register Number	Bit Number								Default Value	Register Function
	7	6	5	4	3	2	1	0		
SR0	0	0	0	0	0	0	0	1	1	Interface Identification
SR1	IFC	LA	CA	TA	SRQ	DCL or SDC	GET	SCG	0	Interrupt Cause
SR2	0	REN	SRQ	ATN	EOI	DAV	NDAC	NRFD	64	HP-IB Control Lines
SR3	DIO8	DIO7	DIO6	DIO5	DIO4	DIO3	DIO2	DIO1	Not Applicable	HP-IB Data Lines
SR4	0	0	SC	A4	A3	A2	A1	A0	53	HP-IB Address/ System Controller
SR5	SC	LA	CA	TA	SPE	Parity Error	REN	LLO	160	State Register
SR6	0	0	0	SC5	SC4	SC3	SC2	SC1	0	Secondary Commands

SR0: Interface Identification

Always returns a value of 1, meaning an HP-IB interface.

SR1: Interrupt Cause (See also HP-IB Control Registers discussion for interrupt timing diagrams.)

A bit, when set, indicates the interrupt condition that caused an end-of-line branch. SR1 is reset to 0 when it is read by a `STATUS` statement.

- Bit 0, when set, indicates that an SCG (secondary command) was received. The value of the secondary command received is available in SR6. This is an event type interrupt: the interrupt, if enabled, will occur when a secondary command is received.

- Bit 1, when set, indicates that a GET (group execute trigger) was received while addressed to listen (LA). This is an event type interrupt: if enabled, the interrupt will occur when trigger is received.
- Bit 2, when set, indicates that either (1) a DCL (device clear) was received or that (2) an SDC (selected device clear) was received while addressed to listen (LA). This is an event type interrupt: if enabled, the interrupt will occur when device clear is received.
- Bit 3, when set, indicates that an SRQ (service request) was received. The interrupt will occur as long as the SRQ line is true. In general, this means that your service routine must clear SRQ, which is usually accomplished by satisfying the requesting device's need for service.
- Bit 4, when set, indicates that either (1) the talker active (TA) bit of CR1 underwent a 0-to-1 transition while the interface was addressed to talk, or (2) the interface became addressed to talk while the talker active (TA) bit of CR1 was set. This is a state-enable interrupt.
- Bit 5, when set, indicates that either (1) the controller active (CA) bit of CR1 underwent a 0-to-1 transition while the interface was active controller, or (2) the interface received control while the controller active (CA) bit of CR1 was set. This is a state-enable interrupt.
- Bit 6, when set, indicates that either (1) the listener active (LA) bit of CR1 underwent a 0-to-1 transition while the interface was addressed to listen, or (2) the interface became addressed to listen while the listener active (LA) bit of CR1 was set. This is a state-enable interrupt.
- Bit 7, when set, indicates that an IFC (interface clear) has occurred on the bus. This is an event type interrupt: the interrupt, if enabled, will occur when interface clear is received.

SR2: HP-IB Control Lines

A bit, when set, indicates that the corresponding HP-IB control line is true.

SR3: HP-IB Data Lines

A bit, when set, indicates that the corresponding HP-IB data line is true.

SR4: HP-IB Address/System Controller Switches

- Bits 0 through 4 indicate the current setting of the HP-IB address switches of the interface. These are factory set to 21.
- Bit 5 indicates the setting of the system controller switch of the interface. A 1 indicates system controller.
- Bits 6 and 7 are always 0.

SR5: HP-IB State Register

This register indicates current HP-IB status of the interface.

- Bit 0, when set, indicates that the interface is in a local lockout state (LLO).
- Bit 1, when set, indicates that the interface is in a remote state (REN).
- Bit 2, when set, indicates that a parity error occurred on input while parity was enabled. It is cleared when R5 is read.
- Bit 3, when set, indicates that SPE (serial poll enable) has been received. It is cleared when SPD (serial poll disable) is received.
- Bit 4, when set, indicates that the interface is addressed to talk (TA or talker active).
- Bit 5, when set, indicates that the interface is active controller (CA or controller active).

- Bit 6, when set, indicates that the interface is addressed to listen (LA or listener active).
- Bit 7, when set, indicates that the interface is system controller (same as SR4 bit 5).

SR6: Secondary Command Register

- Bits 0 through 4 indicate the last secondary command received when the secondary command bit (Bit 0) of CR1 is set. The SR6 register contains any secondary command that follows the interface's talk or listen address.
- Bits 5 through 7 are always 0.

HP-IB Errors

The following errors can be generated by the integrated HP-IB interface or other plug-in interface modules. If you receive one of these errors, use the ERRSC function to determine the select code of the interface reporting the error.

The ERRSC statement is discussed on pages 156 through 157 of the *HP-86/87 Operating and BASIC Programming Manual*. If ERRSC returns the value 7, use the following table.

Error Number	Message	Error Condition
101	TRANSFER	Program was paused with an I/O TRANSFER still active.
110	I/O CARD	Interface failed a self-test, indicating a possible hardware problem.
111	I/O OPER	The I/O operation attempted is not valid with the HP-IB interface.
112		The plug-in ROM has failed a check-sum test, indicating a possible hardware problem, not likely the interface.
113		Not system controller. The statement executed requires that the computer be the system controller.*
114		Not active controller. The statement executed requires that the computer be the current active controller.
115		Not active talker. The statement executed requires that the computer be addressed to talk. A possible cause for this error is that a PRINT statement was executed after a statement specifying only the select code was executed. The peripheral address code must be specified with HP-IB devices to establish the current active talker and listener.
116		Not active listener. The statement executed requires that the computer be addressed to listen. A possible cause for this error is that the computer has not been addressed to listen (but has been previously addressed to talk with a PRINTER IS statement) when a PLOTTER IS statement that only specifies a select code is executed. The peripheral address code must be specified with HP-IB devices to specify the current active talker and listener.

* The HP-86 computer is factory preset as system controller; this status cannot be changed by the user.

Error Number	Message	Error Condition
117		Interface is active controller. The statement executed requires that the computer be non-controller.
123	NO ";"	Syntax error. A semicolon delimiter was expected in the statement.
124	ISC	No device currently set to the specified select code.
125	ADDR	Improper primary address specified. No device at that address.
126	BUFFER	Buffer error. IOBUFFER not declared for the variable specified, buffer is full at execution of an ENTER, or buffer is empty at execution of a TRANSFER or OUTPUT statement.
127	NUMBER	If encountered in an input operation, error indicates that the incoming character sequence does not constitute a number. If encountered in an output operation, the number has exceeded the range of the specified "e" format.
128	EARLY TERM	Buffer was emptied before COUNT or ENTER fields were satisfied.
129	VAR TYPE	The type variable in an ENTER list does not match the image specified for that variable.
130	NO TERM	No required terminator received from interface or buffer during an ENTER. Default requirement for a line-feed statement terminator is still in effect.

If ERRSC returns a non-zero number other than 7, refer to the documentation accompanying the interface assigned that select code.

The Monitor Interface

The monitor interface allows the HP-86 to direct display output to a peripheral monitor. The VIDEO output jack on the back of the computer provides for connecting a 75-Ω coaxial cable fitted with an RCA-type phono plug.

The monitor used with the HP-86 must be capable of handling as input the signal transmitted by the interface. When an incompatible monitor is used, one or more of the following conditions may occur:

Condition	Cause
Shrunken screen	Monitor display period is too long.
Expanded screen	Monitor display period is too short.
Image off-center	Monitor display period is out of alignment.
Moving screen	Synchronization period is different.
Smearing of data	Incompatible bandwidth.

The interface generates a composite video signal with the following specifications:

Video Output Signal	
Polarity	Negative synchronization
Level	1.2 Vp-p
Impedance	75 Ω
Scanning Frequency	
Horizontal	15.65 KHz (63.9 μ s)
Vertical	59.9 Hz (16.69 ms)
Active Video Period	
Horizontal	52.2 μ s
Vertical	15.34 ms
Video Output Frequency	12.30 MHz
Blanking Time	
Horizontal	11.7 μ s
Vertical	1.35 ms
Synchronization Pulse Width	
Horizontal	4.7 μ s
Vertical	.190 ms
Synchronization Pulse Delay	
Horizontal	1.5 μ s
Vertical	.24 ms

VIDEO Output Signal

The following diagrams describe the signal generated by the HP-86 monitor interface:

Horizontal Composite Waveform*

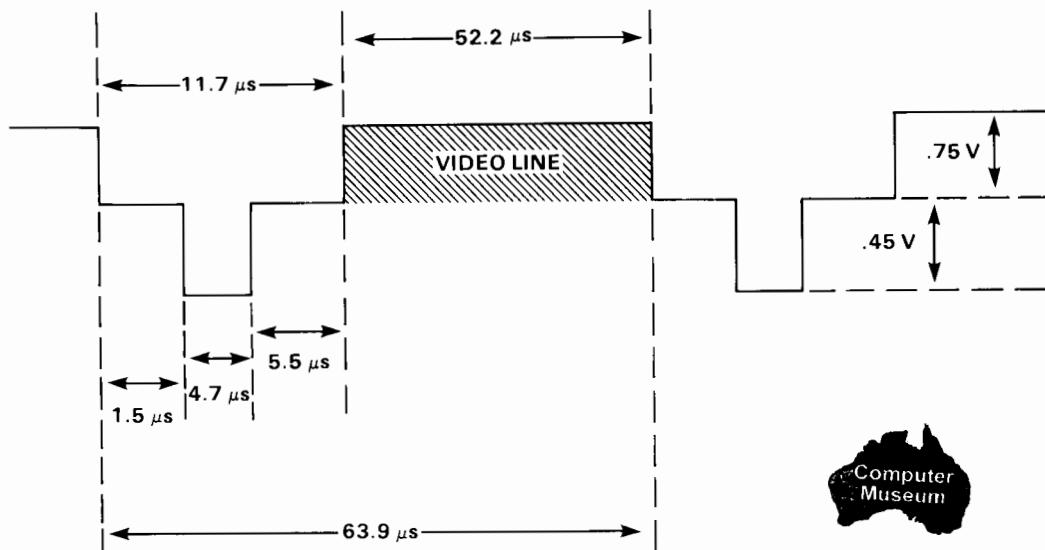

Vertical Composite Waveform*

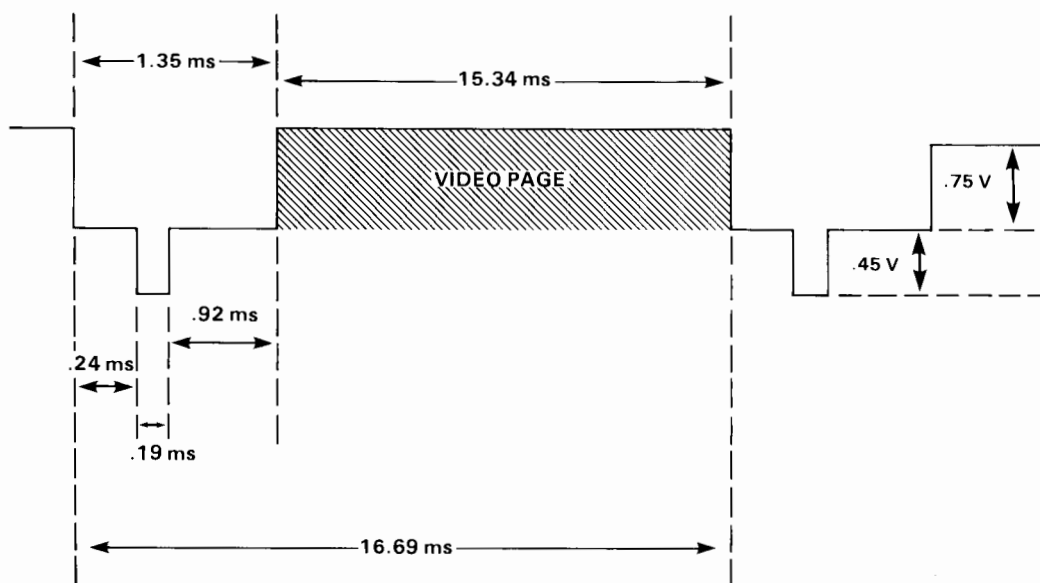

* Not drawn to scale.

Compatibility With Other HP Series 80 Products

As a member of the HP Series 80 family of computer products, your HP-86 has been designed to provide maximum compatibility with other HP Series 80 Personal Computers, peripherals, and software. However, you should be aware of the differences between the HP-86 and other Series 80 computers before running programs written using other models. If you use other Series 80 computers, you may also want information regarding the compatibility of certain optional plug-in modules.

Compatibility of Optional Plug-In Modules

All Series 80 plug-in modules fit one of the following compatibility classifications:

- Used with all Series 80 computers.
- Used with the HP-83 and HP-85.
- Used with the HP-86 and HP-87.

Product	Entire Series 80	HP-83/85 Only	HP-86/87 Only
HP Series 80 interfaces	X		
HP 82936A ROM Drawer	X		
HP 82928A System Monitor	X		
HP 82929A Programmable ROM Module	X		
HP 82950A Modem	X		
HP-83/85 ROMs		X	
HP 82903A 16K Memory Module		X	
HP 82908A 64K Memory Module			X
HP 82909A 128K Memory Module			X
HP-87 ROMs			X
HP 82900A CP/M® System			X

Software Compatibility

All HP-87 BASIC and binary programs can be run on the HP-86. Graphics programs written for the HP-87 CRT, however, will produce HP-86 plots of varying proportions, depending on the monitor used (refer to CRT Graphics on the HP-86/87, below).

Compatibility between HP-86/87 programs and HP-83/85 programs is discussed on pages 59 through 63.

CRT Graphics on the HP-86/87

Graphics operations on the HP-86 and HP-87 address a 400×240 (*graph* mode) or 544×240 (*graph-all* mode) matrix of dots. The actual size and shape of displayed graphics, however, depends on the spacing between dots in the x and y directions.

The HP-86/87 graphics statements assume the screen dimensions and dot spacings of the HP-87 integrated CRT when mapping graphics output onto the matrix of dots. The aspect ratio (that is, the relative x - and y -spacing of the dots) can be computed as follows:

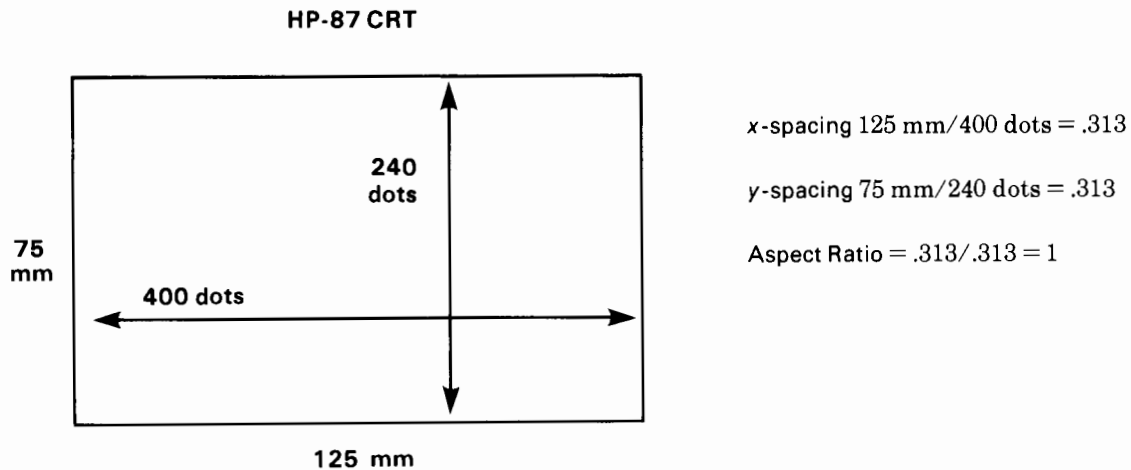

Compare these figures with *graph* mode on the 12-inch HP 82913A Monitor:

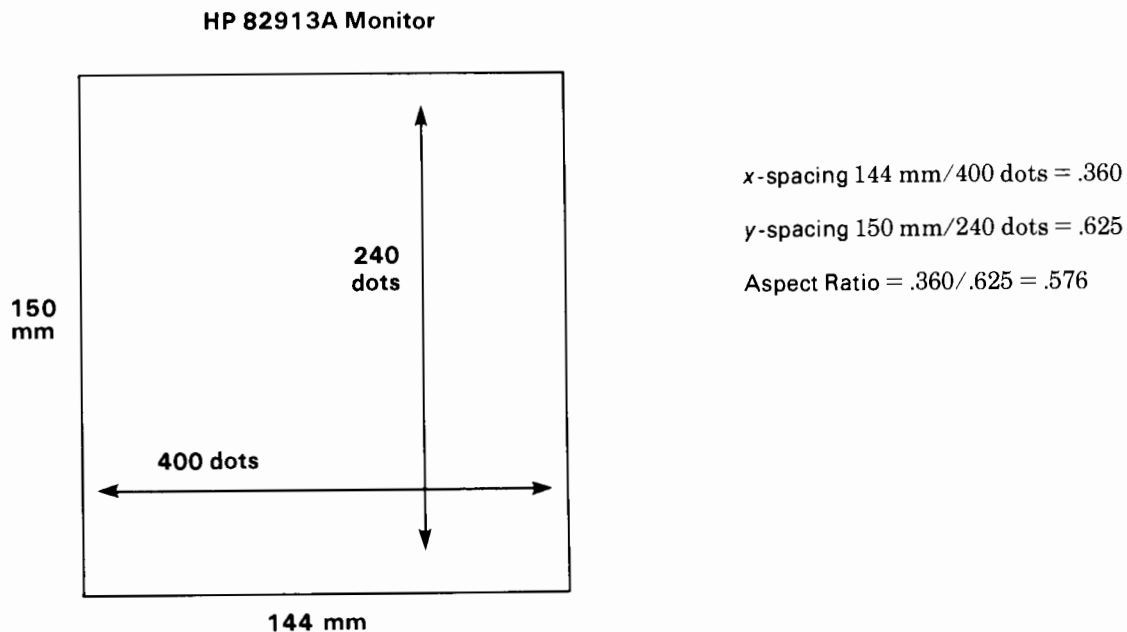

On the monitor, the dots are compressed horizontally and spread out vertically compared to the HP-87 CRT. Since output to both devices addresses the same dots, graphics statements that assume particular physical dimensions (LIMIT, MSIZE) or a certain aspect ratio (SHOW, CSIZE, LOIR, POIR) will produce output of different proportions on peripheral monitors.

The following table lists dimensions and aspect ratios of the HP-87 CRT and the two Hewlett-Packard monitors designed for use with the HP-86. For other monitors, execute a FRAME statement in *graph* mode to outline and measure the display boundaries.

Display Device	Graph Mode Horizontal Dimension	Graph Mode Vertical Dimension	Dot Aspect Ratio
HP-87 CRT	125 mm	75 mm	1.00
HP 82912A Monitor	103 mm	110 mm	.562
HP 82913A Monitor	144 mm	150 mm	.576

Specifying Limit Boundaries and Metric Scaling

On the HP-87, the `RATIO` function returns a value equal to the ratio of the graphics limits:

$$\text{RATIO} = \frac{\text{horizontal dimension}}{\text{vertical dimension}} = \frac{\text{number of dots in x direction}}{\text{number of dots in y direction}}$$

On the HP-86, the horizontal and vertical dimensions of the display depend on the monitor used. The `RATIO` function, therefore, returns only the ratio of addressable dots.

Examples: The following programs illustrate differences in CRT graphics caused by variations in dot spacings. Both programs produce identical output on a particular monitor.

Program A

```

10 PLOTTER IS 1
20 GCLEAR
30 FRAME
40 LIMIT 30,70,5,45
50 LINE TYPE 5
60 FRAME
70 END
    
```

Program B

```

10 PLOTTER IS 1
20 GCLEAR
30 FRAME
40 MSCALE 30,5
50 CLIP 0,40,0,40
60 LINE TYPE 5
70 FRAME
80 END
    
```

Output From Programs A and B on the HP-87 CRT

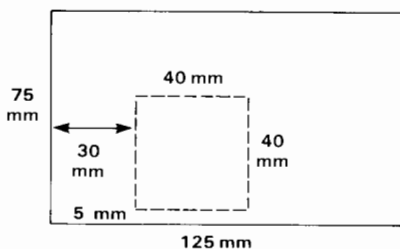

Output From Programs A and B on the HP 82913A Monitor

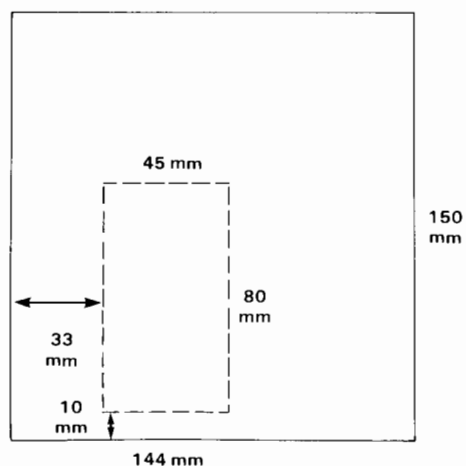

To specify graphics limits in millimeters for your monitor, compute new `LIMIT` parameters:

$$\text{LIMIT parameter} = \text{desired boundary (in mm)} \times \frac{\text{HP-87 screen dimension}}{\text{monitor screen dimension}}$$

For example, to establish 40 mm × 40 mm graphics limits on the HP 82913A Monitor, offset (30,5) mm from the lower left corner of the display, replace the `LIMIT` statement in program A with:

```
LIMIT 30*125/144, 70*125/144, 5*75/150, 45*75/150
```

To scale a monitor display metrically, measure the framed graphics limits as defined by the physical limits of the device or a `LIMIT` statement. Then execute a `SCALE` statement:

```
SCALE x min, x min+x', y min, y min+y'
```

where x' and y' are the dimensions, in millimeters, of the graphics limits.

For example, replacing the `MSCALE` statement in program B with:

```
SCALE -30, -30+144, -5, -5+150
```

produces a clipped 40 mm × 40 mm plotting area with a (30,5) mm offset.

Scaling Isotropic Units

The `SHOW` statement automatically scales isotropic (equal x and y) units for peripheral plotters and the HP-87 CRT. If the aspect ratio of your monitor's dot spacings does not equal 1, you must use the `SCALE` statement to provide isotropic units.

To scale the graphics display isotropically for a particular range of x , execute a `SCALE` statement with the following parameters:

$$\text{SCALE } x \text{ min}, x \text{ max}, y, y + \frac{(x \text{ max} - x \text{ min})}{\text{RATIO} \times \text{Aspect Ratio}}$$

where `RATIO` is the predefined function and `Aspect Ratio` is the computed aspect ratio of the dot spacings.

To scale the graphics display isotropically for a particular range of y , execute:

```
SCALE x, x + ((y max - y min) × RATIO × Aspect Ratio), y min, y max
```

Translating HP-83/85 Programs

When a BASIC program written for and stored using an HP-83/85 is loaded into an HP-86/87, the program is automatically translated into a form executable by the HP-86/87. The translated version cannot be loaded into an HP-83/85.

Note: HP-83/85 BASIC programs that use a binary program cannot be translated by the following procedure. Refer to the discussion of binary programs on page 61 for instructions on translating these programs.

To load an HP-83/85 program into the HP-86/87, execute:

```
LOAD "file specifier"
```

The computer automatically recognizes that the program originated on an HP-83/85 and begins translation, displaying the message:

```
PLEASE WAIT
```

The power light blinks during translation. Translation time depends on the length of the program, and may take up to several minutes. When translation is complete, the power light stops blinking; the computer beeps and displays:

```
DONE
```

You can now store the translated program under the same name to overwrite the HP-83/85 version or under a new file name to preserve both versions.

During translation, program statements not recognized by the HP-86/87 are converted into comment lines. The HP-85 CTAPE, ERASETAPE, REWIND, and COPY statements are not recognized, and will be listed as shown below:

```
240 ! COPY
```

If the unrecognized statement is part of a multistatement line, the entire line becomes a comment. For example, in the program line shown below, GCLEAR is not executable:

```
240 ! GCLEAR @ COPY
```

Programs written with the HP-83/85 Plotter/Printer ROM, the HP-83/85 Mass Storage ROM, or with no optional ROMs can be translated. However, if the program used other HP-83/85 ROMs (e.g., Matrix, I/O), then the corresponding HP-87 ROM must be installed in order to translate the program.

When an HP-83/85 program is chained into an HP-86/87, the program is translated and then automatically executed.

Translating HP-83/85 Programs That Use Binary Programs

The following procedure will translate an HP-83/85 BASIC program that uses a binary program:

1. LIST the HP-83/85 program on an HP-83/85 computer. Convert all lines containing binary statements to comment lines by inserting a comment delimiter, !, after the line number and entering the line.
2. STORE the edited program.
3. LOAD the edited program into the HP-86/87. The program will be translated.
4. LOADEBIN the appropriate HP-86/87 binary program into the HP-86/87.

Note: HP-86/87 BASIC programs and translated HP-83/85 programs return an error if they attempt to access an HP-83/85 binary program. You must obtain a copy of the appropriate HP-86/87 binary program.

5. LIST the program. On each line containing binary statements, delete the comment delimiter. Then, enter the edited line.
6. To avoid repeating the translation process, store the translated BASIC program.

Troubleshooting: Sources of Possible Errors

If a translated HP-83/85 program generates an unexpected error, the cause may be related to differences between the HP-83/85 and the HP-86/87 operating systems.

- Before running a translated program, list the program to check for untranslated statements converted to comments. This step is particularly important if the program includes multistatement lines.
- If the program returns a string overflow error while accessing a single-line, user-defined string function, check to see whether the string expression returned by the function exceeds the allowable maximum length of 18 characters. The HP-83/85 permits longer strings returned by single-line, user-defined string functions.
- The HP-86/87 character set differs from the HP-83/85 character set for certain decimal codes. The following table lists decimal codes to which different characters have been assigned.

Decimal Code	HP-83/85 Characters	HP-86/87 Characters
6	Γ	Σ
7	̄	Δ
8	Δ	+
15	⊥	π
17	Ω	Æ
18	⊗	œ
27	Æ	†
28	œ	
29	z	-
31	⊗	+
123	π	<
125	+	>
126	Σ	~
127	†	⊗

When a translated HP-83/85 program is listed on an HP-86/87, HP-83/85 characters with these decimal codes are displayed as corresponding HP-86/87 characters having the same decimal code.

- Control characters (characters with decimal codes 0 through 31) in program listings are suppressed by the HP-86/87 during PLISTing. The HP-83/85 computers do not suppress PLISTed control characters.
- The HP-86/87 stores all programs deallocated. The HP-83/85 stores all programs allocated unless they contain common variables (declared with a COM statement) or allocation errors.
- The HP-86/87 allocates uninitialized programs dynamically; in other words, during program execution. The RUN command and (RUN) key do not allocate program variables before execution begins. The HP-83/85 allocates programs statically; the RUN command and (RUN) key allocate all program variables before execution begins.

- Certain long HP-83/85 statements may return `ERROR 88: BAD STMT` when you attempt to enter them into an HP-86/87. If this happens, the statement must be broken into separate, shorter operations.
- The HP-86/87 performs certain graphics operations more rapidly than the HP-83/85. Translated graphics programs may require insertion of `WAIT` statements to slow the action on the screen.
- Because the HP-86/87 graphics display has different physical limits than the HP-83/85 CRT, translated programs that use the graphics display may require editing of boundary and scaling statements and `C SIZE` parameters.
- On the HP-86/87, `BPLOT`ting can begin at any dot position. The HP-83/85 requires `BPLOT`s to begin at dot positions that are multiples of 4.

Extended-Type Files

Extended files include all file types except `PROG`, `DATA`, `NULL`, and `BPGM`. All HP-83/85 extended files appear as type `****` in a directory listing obtained on an HP-86/87. Likewise, HP-86/87 extended files appear as type `****` in a directory listing obtained using an HP-83/85.

The HP-86/87 cannot access HP-83/85 extended files. For instance, graphics files `STORED` by an HP-83/85 cannot be retrieved into an HP-86/87.

Printer and Display Formats

If a translated HP-83/85 program is designed to print or display information formatted for 32 columns, you may choose to adapt the program to format the output for 80 columns. If you'd prefer, you can specify 32-column output by executing the appropriate `PRINTER IS` and/or `CRT IS` statements.

Examples:

```
PRINTER IS 701,32
CRT IS 1,32
```

Index

A

(A/G) key, 35
Accessing a disc, 30-31
Accessories, standard, 9
Accessory cables for HP-IB interface, 42
Addressing peripheral devices, 29-30, 43-45
Allocation of variables, 62
 During program execution, 62
 During program storage, 62

B

(BACK SPACE) key, 25
Basic Exchange newsletter, 6
BASIC keywords, 28

C

Cable length of accessory cables, 42
Calculator mode, 24
(CAPS LOCK) key, 24
CMT statement, 31
Catalog of disc, 31
(-CHAR) key, 27
Character set, 62
(CLEAR) key, 28
Clearance for operation, 12
Clearing the display, 28
Command, definition, 31
Compatibility of Series 80 BASIC programs, 57-63



Alpha display, definition, 34
Alpha mode, 35
Arithmetic hierarchy, 25
Aspect ratio of CRT dots, 58-59
Assigning values to variables, 28
AUTO command, 34
Automatic line numbering, 34
Autostart programs, 23

D

Default values for math errors, 26
Deleting characters, 27
Deleting lines, 28
Demonstration disc, 30-31
Device address, 43
Device selector, definition, 44
Dimensions of computer, 10
Directory of disc, 31
Disconnecting peripherals, 43

BASIC language programming, 31-35
Binary programs, 6, 61-62
Brightness of display, 15, 24
Composite video signal, 54
(CONT) key, 39
Continuing a program, 39
Control characters, 62
Control registers, 46-50
CRT address, 44
CRT IS statement, 44
CRT memory, 7
CSIZE statement, 58
Cursor, 15, 23
Cursor control keys, 27

Discs, 30-31, 33
Display, 14-15
 Brightness and contrast, 15
 Connecting, 14
Display editing, 27-28
Documentation, 6
Dot spacing of CRT, 58-59
Drive latch, 30-31
Drive light of disc, 31

E

Editing keys, 27
Editing the display, 27-28
Electrical specifications, 11-12
(END LINE) key, 24, 32
End-of-line sequence, 49-50
End-or-identify assertion, 49
Entering BASIC programs, 31-34
Entering data into programs, 32
Entering information into the computer, 24
EOI assertion, 49

Equal units scaling, 60
Erasing a disc, 33
Erasing program memory, 31
Erasing the alpha display, 28
Erasing the graphics display, 36
Error messages, 26
Errors, HP-IB, 52-53
ERRSC function, 52-53
Extended file type, 63

F

File name, 33
File specifier, 45
Format of print and display output, 63
Functions, 25

Fuse receptacle, 10
Fuses, 12-13
 Installation, 13
 Specifications, 12

G

GOCLEAR statement, 36
GLOAD statement, 36
GRAF files, 36
Graph mode, 34
Graphics compatibility with HP-87, 58
Graphics display, 33-36
 Clearing, 36
 Generating, 33-35

Retrieving, 36
Storing, 35-36
Viewing, 35
Graphics files, 36
Graphics output, 29
Grounding requirements, 12
GSTORE statement, 35

H

Halting program execution, 39
 Homing position of cursor, 23, 28
 Horizontal composite waveform of monitor interface, 55
 HP-IB cable connectors, 43
 HP-IB cable receptacle, 10, 21
 HP-IB cables, 42

HP-IB control registers, 46-50
 HP-IB errors, 52-53
 HP-IB interface, 41-53
 HP-IB status registers, 50-52
 HP-IB talk/listen address, 45

I

I/O ports, 15-16
 I/O ROM, 47
 (I/R) key, 27-28
 Impedance of monitor, 15, 21
 INITIALIZE statement, 33
 Initializing a disc, 33
 Insert mode, 27
 Inspection procedure, 9
 Installation procedures, 14-21
 Installing a monitor, 14-15
 Installing modules, 15-16

Installing peripherals, 19-21
 Installing ROMs, 17
 Installing the fuse, 13
 Integrated interfaces, 41-54
 Interface errors, 52-53
 Interface modules, 15-16, 57
 Compatibility with Series 80 products, 57
 Installing, 15-16
 Interface select code, 15, 44-45
 Isotropic scaling, 60

K

Keyboard overlays, 29, 38

(KEY LABEL) key, 29

L

Label direction, 58
 LDIR statement, 58
 LIMIT statement, 58-60
 (-LINE) key, 28
 Line frequency specifications, 11
 Line length of print output, 29-30

Line numbers, 24
 Lines of display, changing number of, 33
 Line voltage selector switch, 10, 13
 (LIST) key, 39
 Listing a program, 39
 LOAD command, 36

M

Mass storage address, 30, 44-45
 MASS STORAGE IS statement, 45
 Mass storage operations, 30-31
 Mass storage unit specifier, 44
 Mathematical errors, 27
 Memory, 6
 Memory modules, 57
 Metric conversion kit for HP-IB cables, 43
 Metric scaling, 60
 Module ports, 15
 Modules, 15-16

Compatibility with Series 80 computers, 57
 Installation, 15-16
 Removal, 16
 Monitor, connecting, 14, 21
 Monitor, impedance, 15, 21
 Monitor interface, 6, 53-54
 Monitors, multiple, 21
 MSCALE statement, 58-59
 Msus, 44
 Multiplication symbol *, 25

N

Naming files, 33
 Naming variables, 28
 NORMAL statement, 34

Numeric precision, 6
 Numeric variables, 28

O

ON-LINE printer switch, 29
 ON/OFF switch, 10, 14
 Operating environment, 10, 12

Operating temperature range, 10
 Overlays for keyboard, 29, 38
 Owner's documentation, 6

P

PAGESIZE statement, 33
 Parentheses, 25
 (PAUSE) key, 39
 Pausing a program, 39
 PDIR statement, 58
 Peripheral devices, 19-21, 29-30, 43-45
 Addresses, 29-30, 43-45
 Connecting, 19-21
 Peripheral load on HP-IB interface, 41
 Physical specifications, 10
 Plotter, addressing, 29
 PLOTTER IS statement, 44
 Plotter ROM, 29
 (PLST) key, 39
 Plug-in modules, see Modules
 Ports, 15
 Power cord receptacle, 10-11, 14
 Power cords, 11-12

Power light, blinking, 32, 39
 Power-on procedure, 14-15, 23-24
 Power requirements, 11
 Power switch, 10, 13, 23
 Precision of numeric variables, 6
 PRINT statement, 30
 Printer address, 29-30, 46
 PRINTER IS statement, 29-30, 44
 Programs, 31-35, 39
 Entering, 31-35
 Erasing, 31
 Inputting data, 32
 Line numbers, 24
 Listing, 39
 Pausing, 39
 Running, 32
 Program statements, 24

R

Radians mode, 25
 Radio frequency interference, 10
 RATIO function, 59-60
 Rear panel, 10
 Registers of HP-IB interface, 46-52
 Replace mode, 27
 (RESET) key, 24
 Reset operation, 24
 Retrieving graphics, 36

Retrieving programs, 36
 (ROLL) key, 27
 ROM check at power on, 24
 ROM drawer, 17
 ROMs, 17, 61
 Installing and removing, 17
 Required for translation, 61
 (RUN) key, 32
 Running a program, 32

S

Scientific notation, 25
 SCRATCH command, 31
 Select code of interfaces, 15, 44-45
 Self-test, 15, 23-24
 Serial number, 10
 SET I/O statement, 46
 Set-up instructions, 13-14
 (SHIFT) key, 24
 SHOW statement, 60
 Software compatibility, 57
 Specifications, 10-12
 Electrical, 11
 Fuses, 12

Grounding, 12
 Physical, 10
 Power, 11
 Topcase load, 12
 Specifications of monitor interface, 54
 Standard accessories, 9
 Status registers, 50-52
 Storage temperature range, 10
 STORE command, 33
 Storing a graphics display, 35-36
 Storing programs on disc, 32-33
 String variable names, 28
 Syntax errors, 26

T

Talk/listen address, 45
 Temperature specifications, 10
 Termination switch of monitor, 21
 Timing diagrams, HP-IB, 48-49

Topcase load, 12
 Translating HP-83/85 programs, 60-62
 Typing aids, 29

U

Unpacking, 9-10
 User-defined keys, 29

Users' Library, 6

V

Variables, 6, 28
 Assignments, 28
 Names, 28
 Types, 6, 28
 Vertical composite waveform of monitor interface, 55

Video cable, 14-15, 53
 VIDEO jack, 10, 15, 53
 VIDEO output signal, 55
 Voltage requirements, 11
 Voltage selector switch, 10, 13

W

Warning messages, 26
 Weight limit of topcase, 12

Workspace, 12





Personal Computer Division
1010 N.E. Circle Blvd., Corvallis, OR 97330, U.S.A.

Reorder Number
00086-90060

reorder # 583
Printed in U.S.A. 3/83

00086-90061