

BUSINESS GRAPHICS SOFTWARE BY COMPUTER SUPPORT CORPORATION

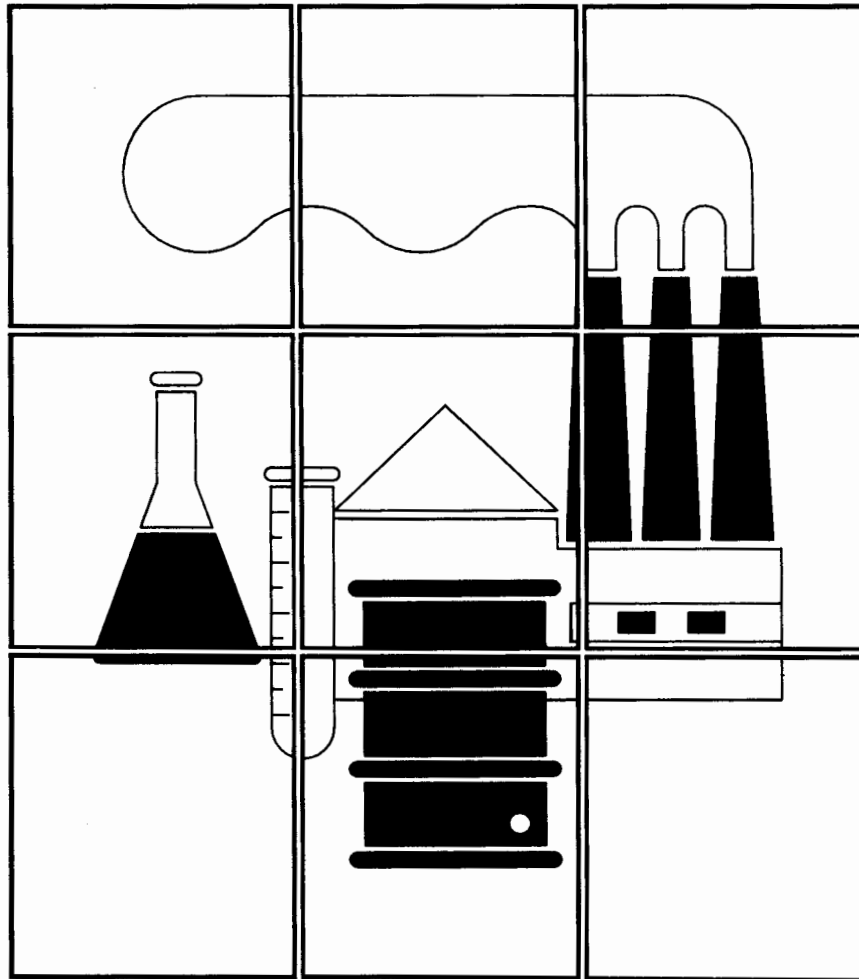

# diagraph<sup>tm</sup>



2215 Midway Road • Carrollton, Texas 75006 • (214) 661-8960

---

---

Program and documentation © 1986 by Computer Support Corporation.

This software product is copyrighted and all rights are reserved by Computer Support Corporation. Copying or duplicating this product except for archival purposes is prohibited without permission in writing from Computer Support Corporation.

This book is copyrighted and all rights are reserved by Computer Support Corporation. No part of this book may be reproduced or transmitted in any form or by any means, electronic or mechanical, including photocopying and recording, or by an information storage and retrieval system without permission in writing from Computer Support Corporation.

Diagraph is a registered trademark of Computer Support Corporation.

Computer Support Corporation  
Northview Centre  
2215 Midway Road  
Carrollton, Texas 75006  
(214) 661-8960  
Telex: 284831 CSCTX UR  
Printed in U.S.A.

**Printing History**

The printing history below identifies the edition of this document and any updates that are included.

- First Edition . . . . . April 1986

**HP Computer Museum**  
**[www.hpmuseum.net](http://www.hpmuseum.net)**

**For research and education purposes only.**

# Table of Contents

---

---

## Introduction

### Chapter 1: Graphic Aids

Accents .....	1-1
Arrows .....	1-3
Banners .....	1-7
Boxes .....	1-8
Page Borders .....	1-9
Splashes .....	1-10
Stars .....	1-11
Text Blocks .....	1-12
Word Balloons .....	1-14

### Chapter 2: Geometrics

Geometrics (Primitives) .....	2-1
Geometrics (2-D) .....	2-2
Geometrics (3-D Oblique) .....	2-4
Geometrics (3-D Perspective) .....	2-5

### Chapter 3: Signs and Icons

Signs - Notation .....	3-1
Signs - Health and Safety .....	3-3
Signs - Road .....	3-4
Icons .....	3-5
More Icons 1 .....	3-10
More Icons 2 .....	3-12
More Icons 3 .....	3-14
More Icons 4 .....	3-16
More Icons 5 .....	3-18
More Icons 6 .....	3-20

---

*Table of Contents, continued*

---

Chapter 4: Pictorials	
Pictorials . . . . .	4-1
Composition Aids . . . . .	4-6
Holidays and Seasons . . . . .	4-9
More Pictorials . . . . .	4-16
Space . . . . .	4-18
Agriculture . . . . .	4-24
Portrait Gallery . . . . .	4-26
Vehicles and Heavy Equipment . . . . .	4-28
Chapter 5: Applications	
Organization Charts . . . . .	5-1
Pie, Bar and Line Charts . . . . .	5-2
Data Processing Flowcharts . . . . .	5-4
Communication Flowcharts . . . . .	5-5
Office Layouts . . . . .	5-6
Networks . . . . .	5-7
Electronics and Logic . . . . .	5-11
EDP Equipment . . . . .	5-19
Pipe Fittings and Valves . . . . .	5-29
Pulp and Paper Process Flow . . . . .	5-38
Chemical and Petroleum Process Flow . . . . .	5-41
Chapter 6: U.S. Maps	
Requirements . . . . .	6-1
Introduction . . . . .	6-1
Map Building Techniques . . . . .	6-2
World Maps . . . . .	6-10
State Symbols . . . . .	6-11
Icons . . . . .	6-12
Low Resolution Symbols . . . . .	6-16
Medium Resolution Symbols . . . . .	6-24
High Resolution Symbols . . . . .	6-32
Sample Maps . . . . .	6-39
Appendix A: Symbol Index . . . . .	A-1

---

# Introduction

---

This symbol handbook depicts all symbols included with your purchase of Diagraph for the HP 150 as well as symbols currently available in optional libraries.

## Symbol Libraries

The following table indicates which symbols are recorded on the three Diagraph discs labeled Symbol Library #1, Symbol Library #2 and Pictorial Library #1. The symbols are grouped by type and application.

Symbol Library #1	Symbol Library #2	Pictorial Library #1
Graphic Aids <ul style="list-style-type: none"><li>• Accents</li><li>• Arrows</li><li>• Arrowheads</li><li>• Banners</li><li>• Boxes</li><li>• Page Borders</li><li>• Splashes</li><li>• Stars</li><li>• Text Blocks</li><li>• Word Balloons</li></ul>	Geometrics <ul style="list-style-type: none"><li>• Primitives</li><li>• 2D</li><li>• 3D — Oblique</li><li>• 3D — Perspective</li></ul> Signs <ul style="list-style-type: none"><li>• Notation</li><li>• Health &amp; Safety</li><li>• Road</li></ul> Icons <ul style="list-style-type: none"><li>• Organizational Charts</li><li>• Pie, Bar &amp; Line Charts</li><li>• Data Processing Flowcharts</li><li>• Communications Flowcharts</li><li>• Office Layout</li><li>• Networks</li></ul>	<ul style="list-style-type: none"><li>• People</li><li>• Places</li><li>• Things</li><li>• Maps</li><li>• Transportation</li><li>• Office Equipment</li><li>• Landscapes</li><li>• Composition Aids</li></ul>

An index of the symbols in alphabetical order appears in each section and at the back of the handbook. Many of the entries are cross-referenced so that you can find the symbol number by looking under any one of several different descriptions.

## Symbol Index

The pictorial symbols on the Pictorial Library #1 disc are complex line drawings. If you need a simple drawing that can be greatly reduced in size, use an icon instead of a pictorial symbol. The letter "P" following the symbol number indicates that the symbol is a pictorial.

---

## *Introduction, continued*

---

Symbols included with Diagraph do not have a library number in the Library (Lib.) column of the Symbol Index. Optional symbols have a library number which identifies the library containing the symbol.

### **Fonts**

The 13 fonts included with Diagraph are pictured at the end of this section. Font #1 corresponds to the hardware character set of the Hewlett-Packard plotters.

Fonts #4 through #13 are Hershey fonts which have been optimized for speed of drawing with proportional spacing. Because Hershey fonts are formed by a predetermined number of strokes per character, if you enlarge the characters beyond a certain size, the line segments will become apparent.

Font #1 is always present in memory when you are using Diagraph. Memory is also allocated for one additional typeface. If you specify more than one additional font, each time the font is called for it must be loaded from the appropriate disc. If the disc called for is not present on the system, a message at the top of the screen will advise you which disc should be inserted.

### **Optional Symbol Libraries**

In addition to the 1500 symbols included with Diagraph, several thousand other symbols are also available.

The optional symbols are organized into the following libraries: More Icons (1 through 6), Holidays & Seasons, More Pictorials, Electronics & Logic, EDP Equipment, Space, Agriculture, Pulp & Paper, Portrait Gallery, Chemical & Process Flow, Vehicles and Heavy Equipment and U.S. Maps.

---

## Introduction, continued

---

<b>Pictorial Library #2</b>	<b>Pictorial Library #3</b>	<b>Pictorial Library #4</b>
Holidays & Seasons More Pictorials	Space Vehicles & Heavy Equipment	Human Anatomy Portrait Gallery
<b>Pictorial Library #5</b>	<b>Symbol Library #3</b>	<b>Symbol Library #4</b>
Human Anatomy	Electronics & Logic More Icons 1 More Icons 2 More Icons 3 More Icons 4 More Icons 5 More Icons 6	Agriculture Chemical & Petroleum Process Flow Pipe Fittings & Valves Pulp & Paper Process Flow
<b>Symbol Library #5</b>	<b>Symbol Library #6</b>	<b>Symbol Library #7</b>
U.S. Maps (Metro Area, Icon and Medium Res. Symbols)	U.S. Maps (World, Drop Shadow, Low and High Res. Symbols)	Forms

This handbook depicts all the optional symbols that are currently available. If you can't find a symbol that is essential to your project or application, please let us know.

Computer Support can also digitize your company's logo. For an estimate of the one-time charge, send us a copy of the logo and specifications. For more information, write to:

Computer Support Corporation  
2215 Midway Road  
Carrollton, Texas 75006  
(214) 661-8960  
Telex: 284831 CSCTX UR

## Company Logos



**Installing Optional Libraries**

Enclosed are any Optional and/or Custom Diagraph symbol libraries you ordered. The symbol libraries are stored on one or more discs labeled "Optional Libraries".

If Diagraph is installed on a fixed disk-drive, proceed to step 2 of the Link Procedure described below.

If you are using a dual flexible disc drive, the disc labels enclosed should be used to identify the "Master" copies of the new libraries created during the Link Procedure. Depending on the number of libraries you ordered and the organization of the libraries in your data base, you may not need all the enclosed labels.

The Link Procedure updates the symbol index on each of the "master" discs and copies the new symbols onto the appropriate Symbol Library or Custom Library disc. Formatted and labeled discs are required for each Symbol or Custom Library that will be called for during the Link Procedure. Once the Link Procedure is complete these discs become your "master" copy of the new libraries.

Use the following Link Procedure to install optional or custom libraries.

1. If you are using a fixed (hard) disk drive, proceed to step 2. Otherwise, format a blank disc for each Diagraph label enclosed.
2. Insert the Optional Library disc in the disc drive. If more than one Optional Library disc is enclosed, start with any of the discs.
3. From P.A.M.,

**Press**

**Reread  
Discs**

---

## Introduction, continued

---

A program named LINKDLIB will be displayed as an entry in the selection menu. Select LINKDLIB and

Press 

4. Follow the instructions that appear on the screen.

A message will inform you when the process is complete.

If you are using Diagraph on a dual flexible disc drive, you should make "work" copies of the "master" discs for everyday use and store the "master" copies in a safe place.

If you specify a symbol from a library that is not installed on your system, a message will appear at the top of the screen:



Symbol nnnn not in the data base

If you ordered a Custom Symbol Library or Company Logo, the symbol number(s) will be on the sample plot enclosed with the library.

If you have any questions regarding these procedures, call us at (214) 661-8960 between 8:30 a.m. and 6:30 p.m. CST.

Several of the Optional Library symbols can be combined to form composite symbols. For example, combine symbols 4826 (tree trunk) and 4827 (foliage) as shown on the following page.

## Composite and Accent Symbols

---

Introduction, continued

---

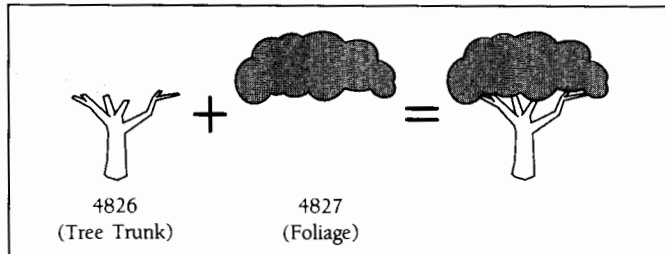

Composite symbols are listed in the Symbol Index and can be identified by the presence of multiple symbol numbers for a single illustration.

Accent symbols can be used to add different colors to an Outline symbol. For example, symbol 4895A (green holly) and symbol 4896A (red candles) are used to accent Outline symbol 4821, as shown below.

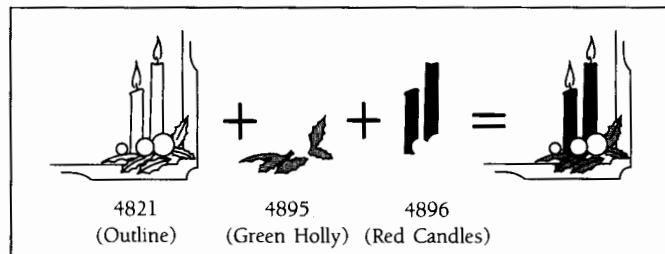

As the outline symbol must be drawn last, place the pen to be used to outline the symbols (generally black) in well #1 of the plotter. Depending on the number of pens your plotter has (2, 4, 6 or 8), assign a number one greater than the number of pens (i.e. 3, 5, 7 or 9). Once all of the other symbols and text have been plotted, a message will appear at the top of the screen asking you to change pens.

---

## Introduction, continued

---

To plot the Outline Symbols in the pen currently in well #1,

Press 

To suppress the outline of the Accent symbols, change the Linetype in the Symbol menu from "1" to "0"; change the shading pattern to "9" and select the pen number that reflects the accent color to be added to the Outline symbol.



A capital "A" follows the symbol number of all Accent symbols in the Symbol Index.

To overlay Composite and Accent symbols so that they are in the proper scale, relative to each other, begin by positioning and sizing a Composite or Outline symbol on the screen.

## Overlaying Symbols

Once the Outline or first Composite symbol is the proper size and in the desired location, from the Design Diagraph level,

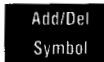
Press 

Press 

When the Symbol menu appears at the top of the screen, type the number of the Accent or second Composite symbol.

Press 

---

*Introduction, continued*

---

**Press** 

**Press** 

The second Composite or Accent symbol will appear on the screen the exact size of the Outline or first Composite symbol.

To add a third symbol,

**Press** 

When the Symbol menu appears at the top of the screen, type the number of the third symbol.

**Press** 

**Press** 

Repeat the procedure to overlay additional symbols.

Once the symbols are overlaid, if you need to alter or change a symbol,

**Press** 

to identify the number of the active symbol and then

---

*Introduction, continued*

---

**Press** 

To activate the next symbol, press the  
Next key and then

**Press** 

and so on.

---

*Notes*

---

# Linetypes

- 0 - NULL LINE
- 1 - SOLID LINE
- 2
- 3
- 4
- 5
- 6
- 7
- 8
- 9

# Tokens

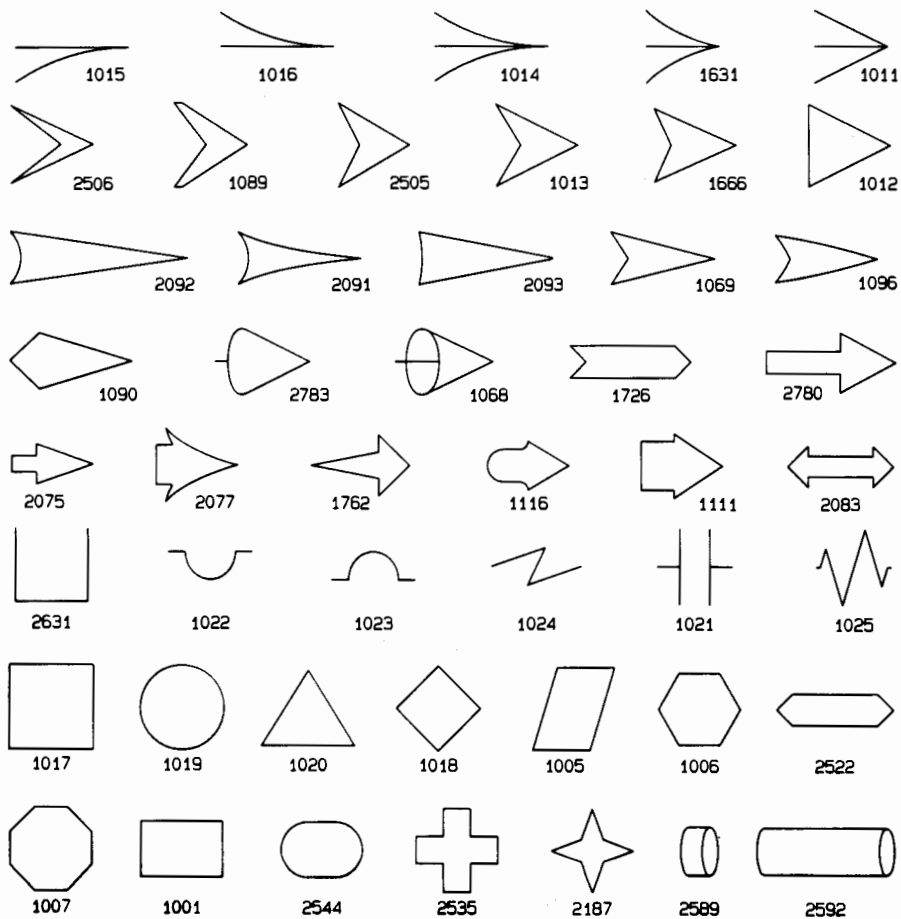



# Shading Patterns

## LOW DENSITY PATTERNS

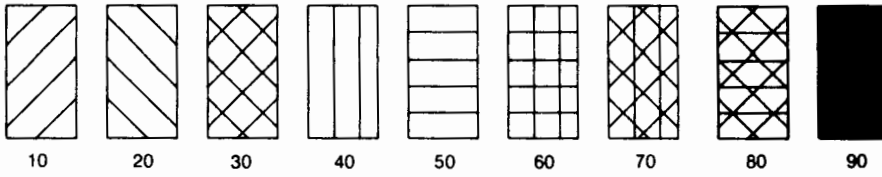

## MEDIUM DENSITY PATTERNS

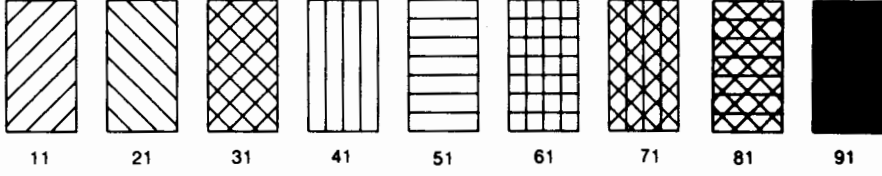

## HIGH DENSITY PATTERNS

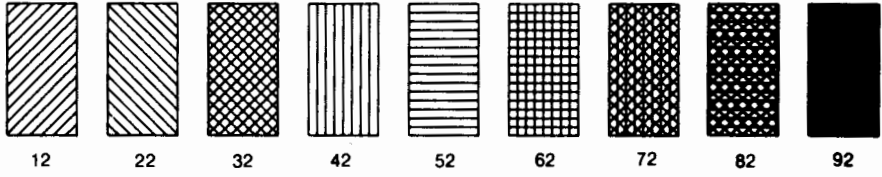

## LOW DENSITY PLAID PATTERNS

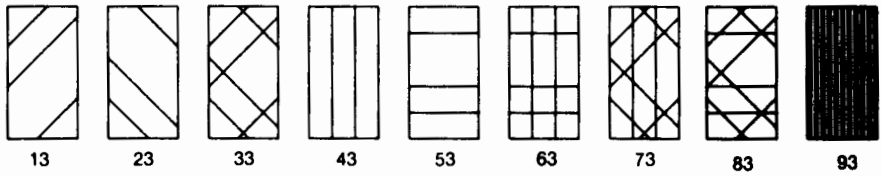

## MEDIUM DENSITY PLAID PATTERNS

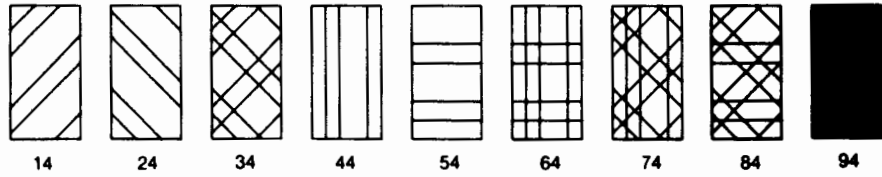

## HIGH DENSITY PLAID PATTERNS

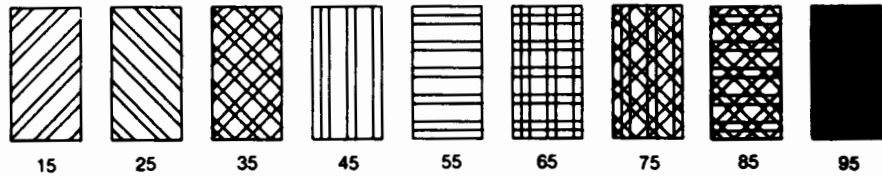

## Text Fonts

### FONT 1 - HARDWARE CHARACTER SET

This is the Hardware Character set  
: ; " ' , . 1 2 3 4 5 6 7 8 9 0  
? ! \$ / # % & < > \* [ ] - + = ( ) @ ^ ~ ` \_ { } | \

### FONT 2 - OUTLINE BLOCK

This is an example of Outline Block  
: ; " ' , . 1 2 3 4 5 6 7 8 9 0  
? ! \$ / # % & < > \* [ ] - + =

### FONT 3 - SOLID BLOCK

**This is an example of Solid Block**  
: ; " ' , . 1 2 3 4 5 6 7 8 9 0  
**? ! \$ / # % & < > \* [ ] - + =**

### FONT 4 - SIMPLEX ROMAN

This is an example of Simplex Roman  
: ; " ' , . 1 2 3 4 5 6 7 8 9 0  
? ! \$ / # % & < > \* [ ] - + = ( )

### FONT 5 - DUPLEX ROMAN

This is an example of Duplex Roman  
: ; " ' , . 1 2 3 4 5 6 7 8 9 0  
? ! \$ / # % & < > \* [ ] - + = ( )

### FONT 6 - COMPLEX ROMAN

This is an example of Complex Roman  
: ; " ' , . 1 2 3 4 5 6 7 8 9 0  
? ! \$ / # % & < > \* [ ] - + = ( ) @ { }

FONT 7 - TRIPLEX ROMAN

This is an example of Triplex Roman

: ; " ' , . 1 2 3 4 5 6 7 8 9 0  
? ! \$ / # % & ( ) \* [ ] - + = ( ) @ { }

FONT 8 - SIMPLEX GREEK

A B Δ E H Γ Φ I K Λ M N O Π Ξ P Σ T T Θ Ω X Ψ Z  
α β δ ε η γ φ ι κ λ μ ν ο π ξ ρ σ τ υ ϑ ω χ ψ ζ

FONT 9 - SIMPLEX SCRIPT

*This is an example of Simplex Script*

: ; " ' , . 1 2 3 4 5 6 7 8 9 0  
? ! \$ / # % & ( ) \* [ ] - + = ( )

FONT 10 - COMPLEX SCRIPT

*This is an example of Complex Script*

: ; " ' , . 1 2 3 4 5 6 7 8 9 0  
? ! \$ / # % & ( ) \* [ ] - + = ( )

FONT 11 - GOTHIC ENGLISH

**This is an example of Gothic English**

: ; " ' , . 1 2 3 4 5 6 7 8 9 0  
? ! \$ / & \* - + = ( )

FONT 12 - COMPLEX ITALIC

*This is an example of Complex Italic*

: ; " ' , . 1 2 3 4 5 6 7 8 9 0  
? ! \$ / # % & ( ) \* [ ] - + = ( )

FONT 13 - TRIPLEX ITALIC

*This is an example of Triplex Italic*

: ; " ' , . 1 2 3 4 5 6 7 8 9 0  
? ! \$ / # % & ( ) \* [ ] - + = ( )

# 1 Graphic Aids

## Symbol Index

Description	Number	Lib.	Page	Description	Number	Lib.	Page
Accents (Graphic Aids)			1-1	Whorl (Accent)	1932		1-2
Arrowheads			1-3	Word Balloons			1-14
Arrows			1-3	X-Mark	1765		1-1
3-D			1-6				
Multidirectional			1-6				
Balloons, Word			1-14				
Banners			1-7				
Bass Clef	1749		1-1				
Border							
Curled Edge	1547		1-13				
Parchment	1937		1-9				
Scroll	3381		1-9				
Borders, Page			1-9				
Boxes			1-8				
Check Mark	1296		1-1				
Club (Playing Card)	1904		1-1				
Compass Rose			1-3				
Cross Hairs			1-1				
Diamond (Playing Card)	1928		1-1				
Diamonds (Accents)			1-1				
Dingbats (Accents)			1-1				
Dollar Signs Text Block	1057		1-13				
Droplet	2598		1-1				
Eighth Note (Music)	1753		1-1				
Eighth Notes (Music)	1748		1-1				
Explosions			1-10				
Frames (Page Borders)			1-9				
Gibbons Moon	2730		1-2				
Half Moon	4086		1-2				
Half Note (Music)	1752		1-1				
Hand, Pointing	1121		1-6				
Heart (Playing Card)	1581		1-1				
Highlight (Whorl)	1932		1-2				
Light Beam	1799		1-2				
Lightning Bolt							
Curved	2053		1-2				
Straight	2052		1-2				
Message (Bulletin Board)	2663		1-13				
Moon							
First Quarter	4086		1-2				
Third Quarter	2730		1-2				
Musical Notes			1-1				
Note (Bulletin Board)	2663		1-13				
Notes, Music (Individual)			1-1				
Pad of Paper (Border)	4196		1-9				
Page Borders			1-9				
Paper Bent Corner	1547		1-13				
Parchment (Border)	1937		1-9				
Pinwheels			1-2				
Puddle	1549		1-10				
Quarter Note (Music)	1753		1-1				
Radiation	1598		1-1				
Registration Marks			1-1				
Scroll (Page Borders)	3381		1-9				
Signboard	3382		1-9				
Snowflake	1553		1-2				
Spade (Playing Card)	1934		1-1				
Sparkles			1-2				
Spilled Liquid	2743		1-10				
Splashes			1-10				
Stars			1-11				
Stone Tablets	2736		1-13				
Sunrise	2720		1-2				
Teardrop	2598		1-1				
Text Blocks			1-12				
Bulletin Board Note	2663		1-13				
Dollar Sign	1057		1-13				
Paper (Curled Edge)	1547		1-13				
Quotation Marks	2116		1-13				
Stone Tablets	2736		1-13				
Treble Clef	1750		1-1				
Water Droplet	2598		1-1				



---

*Notes*

---

Graphic Aids - Accents

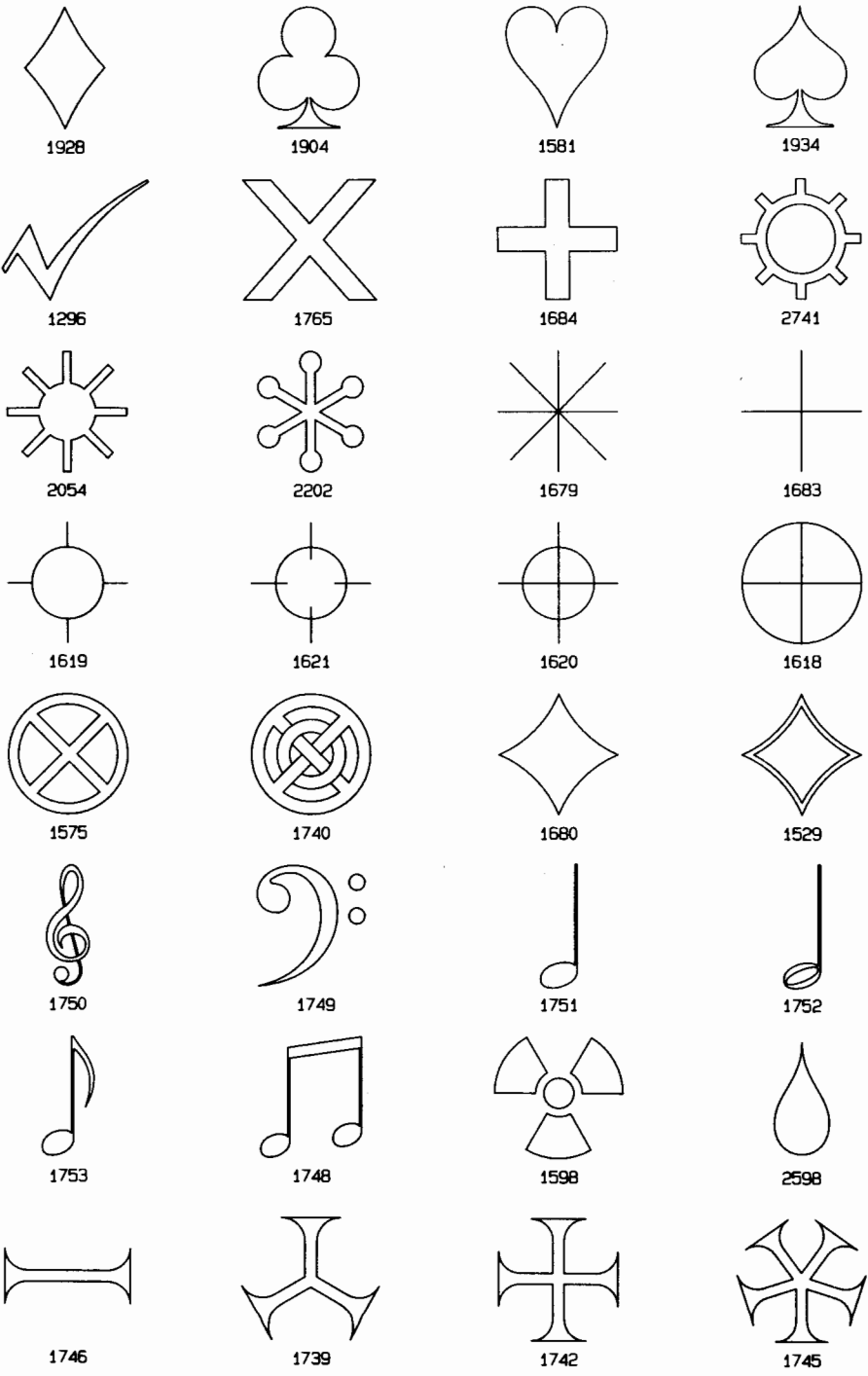

# Graphic Aids - Accents

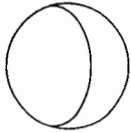

2730



4086



2053



2052



1733



1737



1736



1734



1735

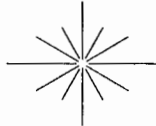

1784

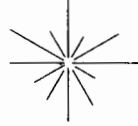

1785

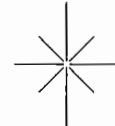

1786



1798



2719



2729



2720

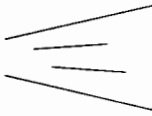

1799



2782

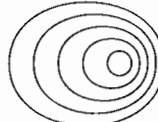

1936

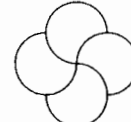

1511

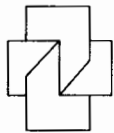

1648



1531

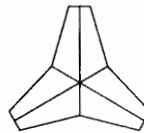

1738

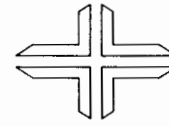

1732



1553

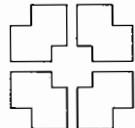

1193

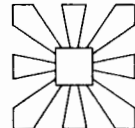

1516

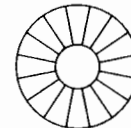

1525



1932



1582

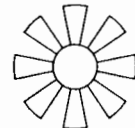

1523

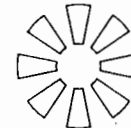

1522

# Graphic Aids - Arrows

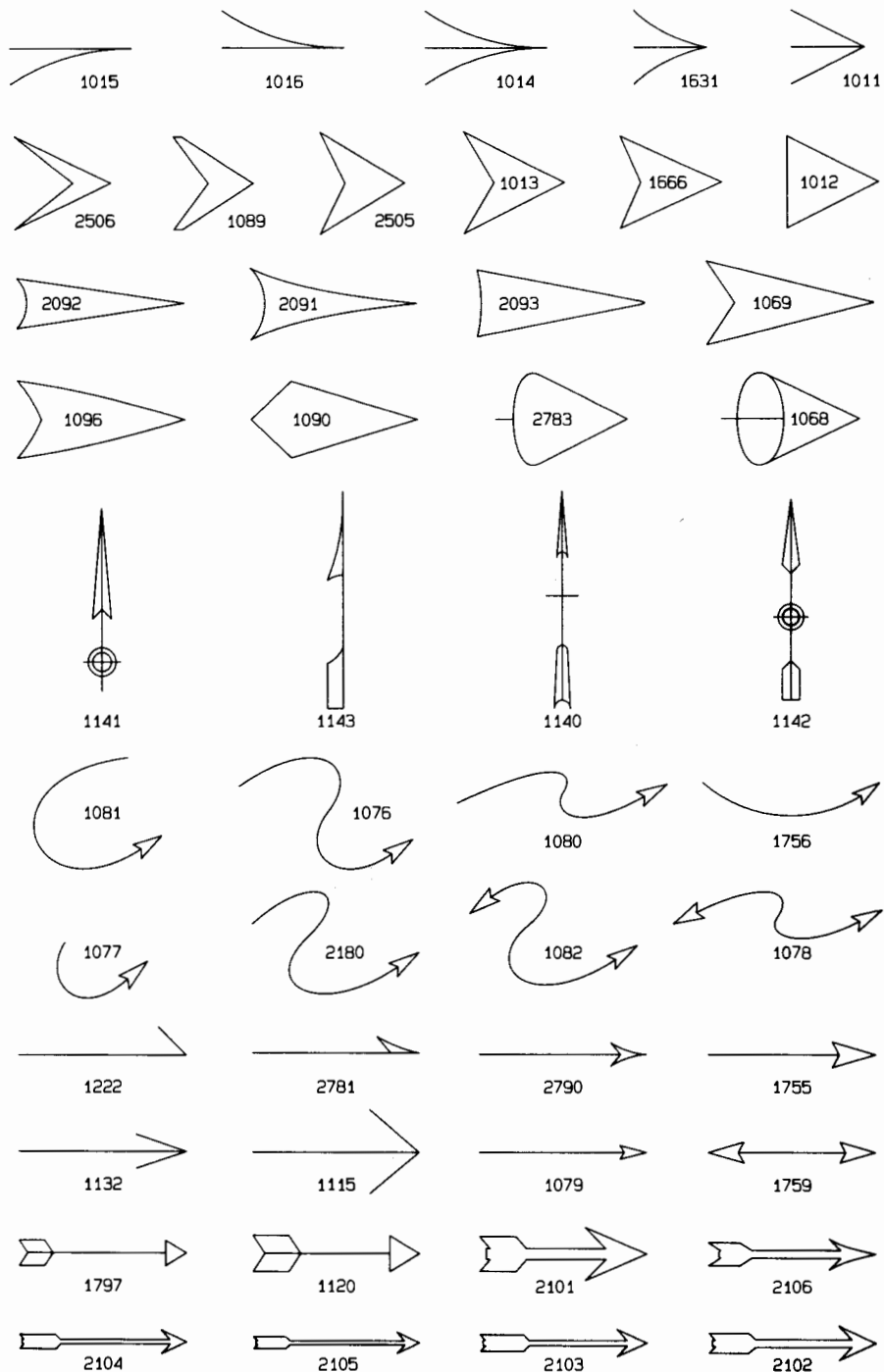



# Graphic Aids - Arrows

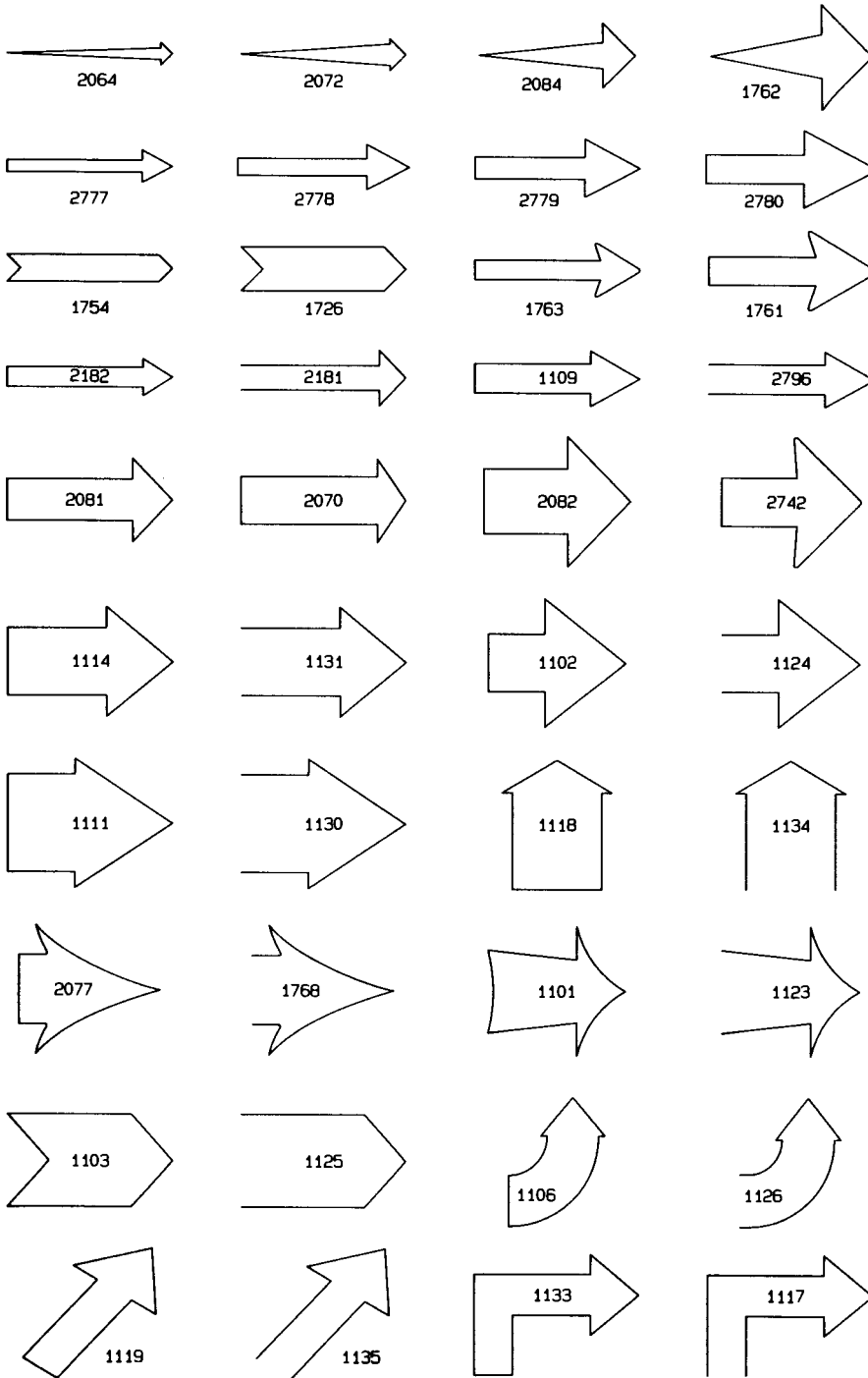

# Graphic Aids - Arrows



1783



1782

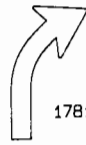

1781



1094

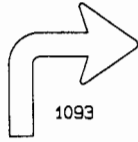

1093

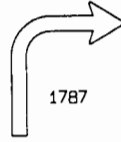

1787

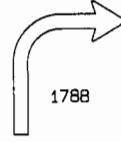

1788

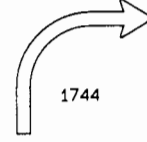

1744

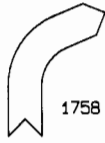

1758

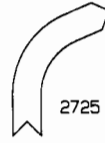

2725

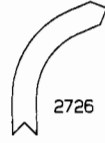

2726



2727

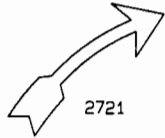

2721

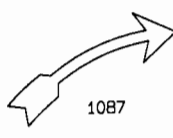

1087

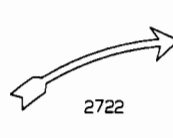

2722

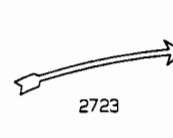

2723

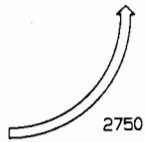

2750



2067



2079

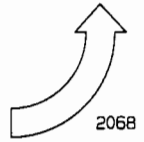

2068



2074

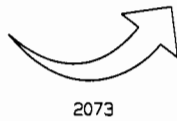

2073



2724

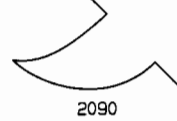

2090

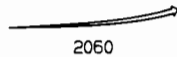

2060

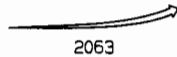

2063

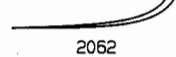

2062

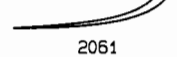

2061

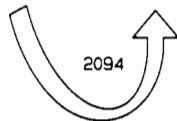

2094



1122

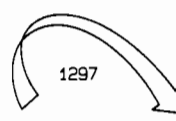

1297

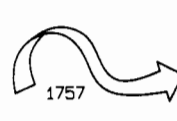

1757



2794



1766



2793

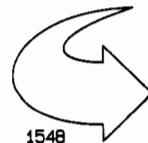

1548

# Graphic Aids - Arrows

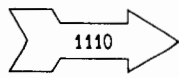

1110

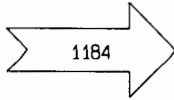

1184

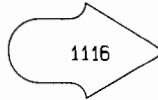

1116

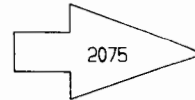

2075

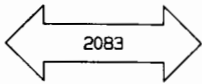

2083

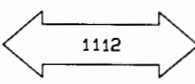

1112

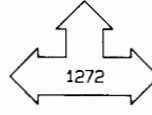

1272

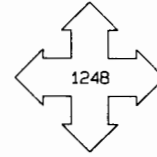

1248



2156

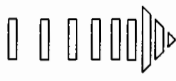

2155

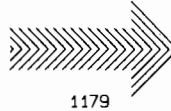

1179

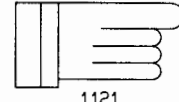

1121

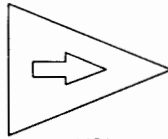

1181

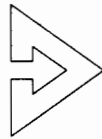

1175

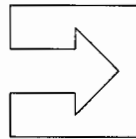

1180

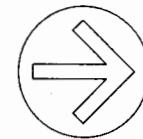

1144



1727



1770



1769



1771



2154



2157

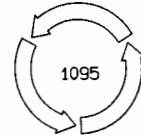

1095



2152

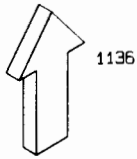

1136

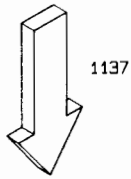

1137

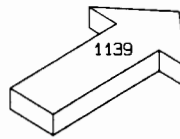

1139

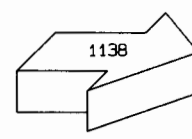

1138

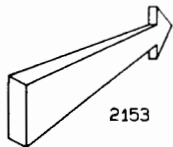

2153

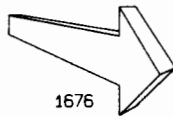

1676

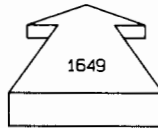

1649

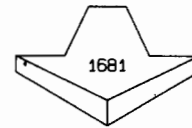

1681

# Graphic Aids - Banners



2139



2137



2140



2145



2141

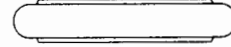

1794

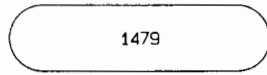

1479

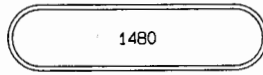

1480

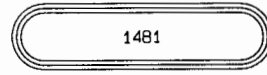

1481

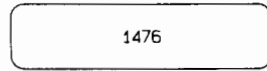

1476

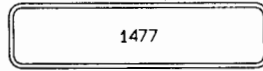

1477

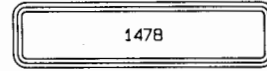

1478

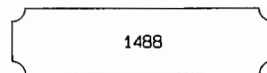

1488

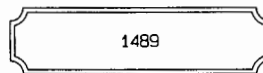

1489

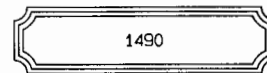

1490

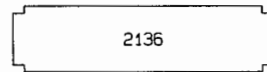

2136

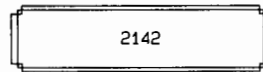

2142

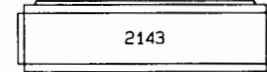

2143

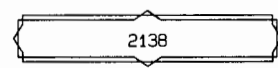

2138

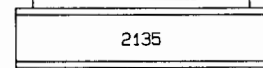

2135

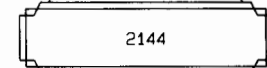

2144

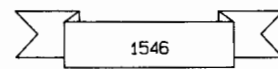

1546

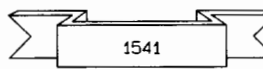

1541

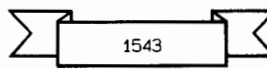

1543

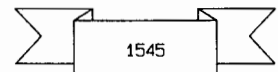

1545

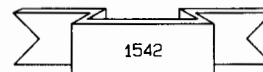

1542

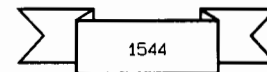

1544

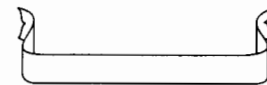

1540

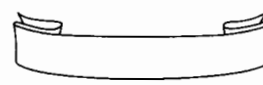

1574

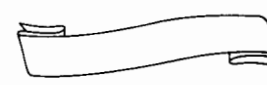

2126

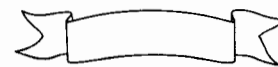

1599

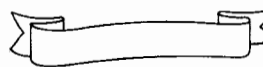

1601

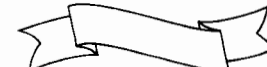

1573

# Graphic Aids - Boxes

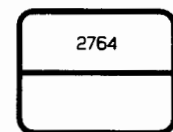
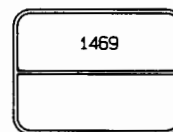
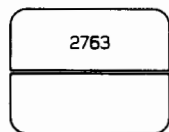
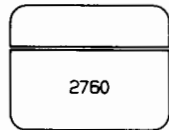
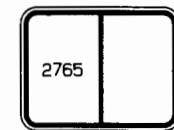
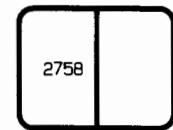
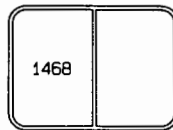
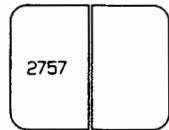
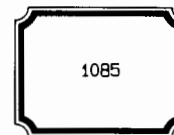
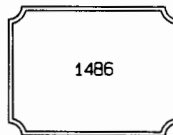
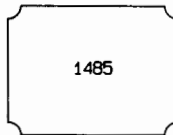
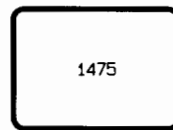
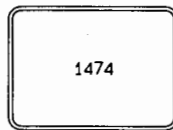
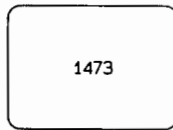
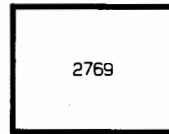
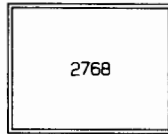
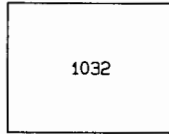
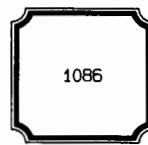
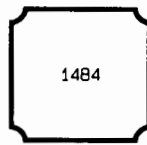
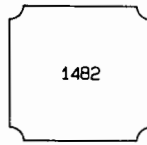

# Graphic Aids - Page Borders

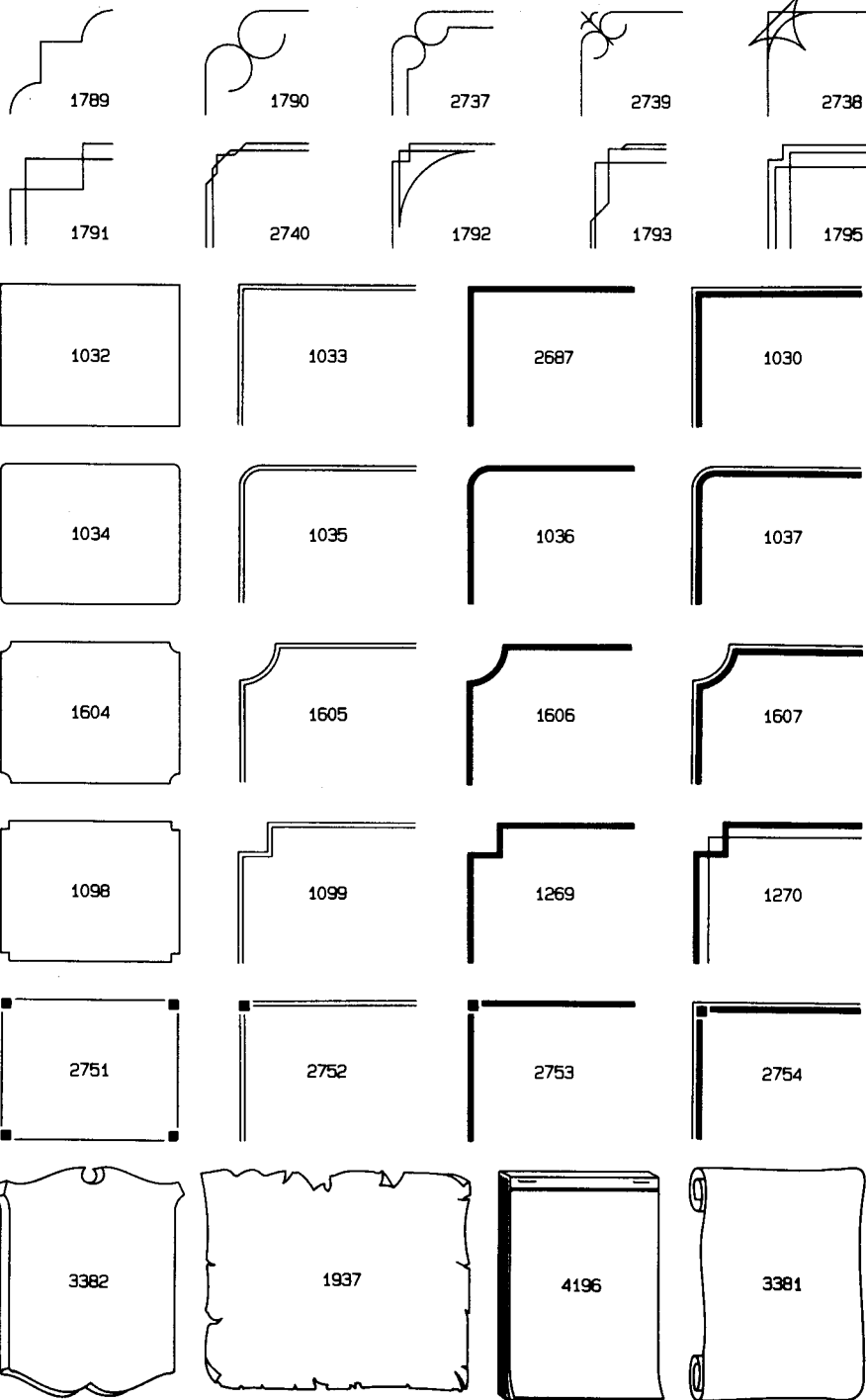

# Graphic Aids - Splashes

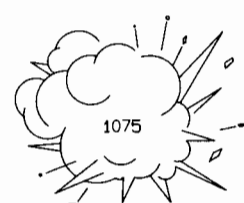
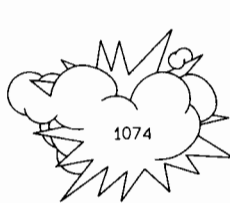
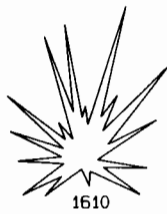
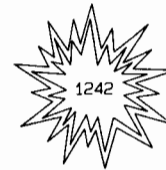
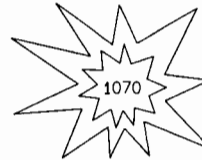
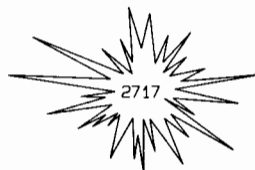
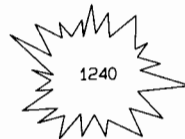
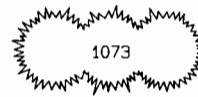
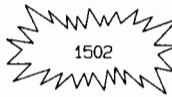
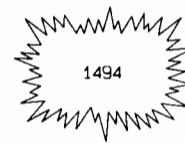
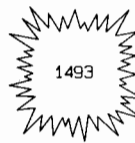
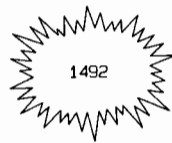
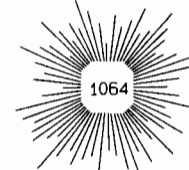
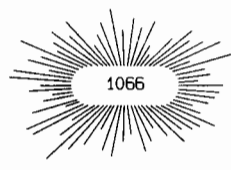
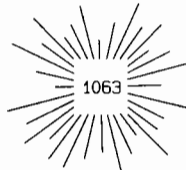
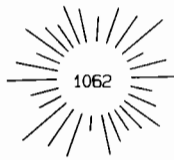
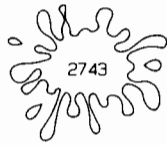
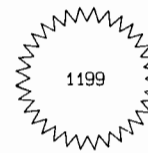
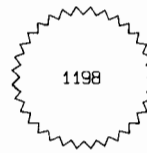
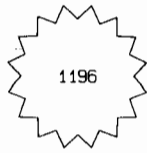

# Graphic Aids - Stars

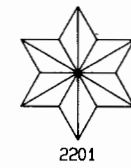
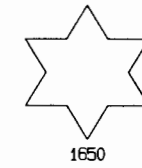
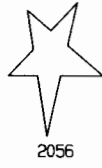
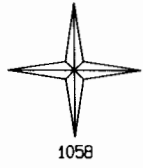
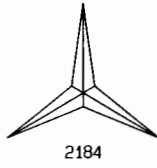



# Graphic Aids - Text Blocks

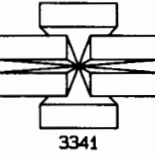
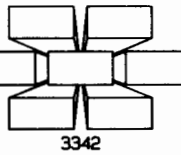
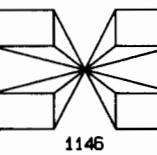
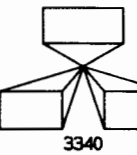
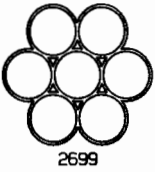
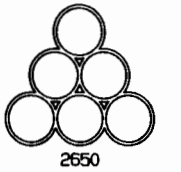
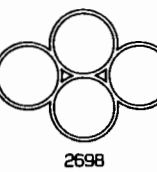
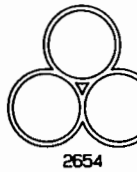
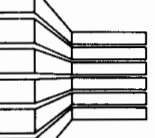
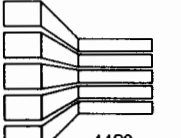
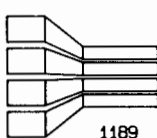
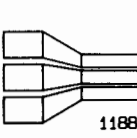
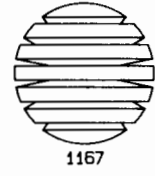
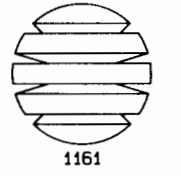
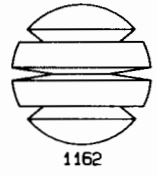
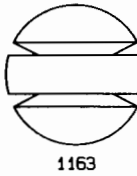
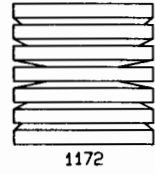
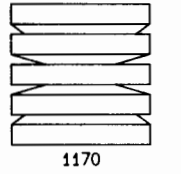
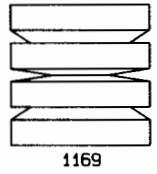
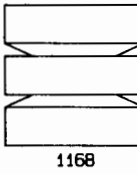
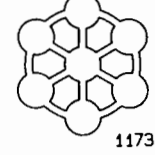
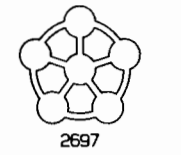
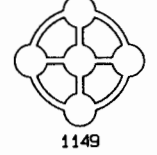
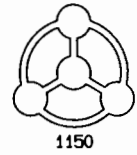
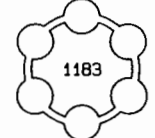
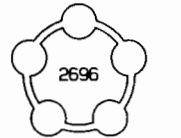
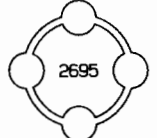
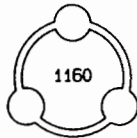
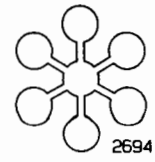
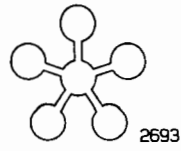
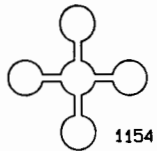
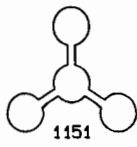

# Graphic Aids - Text Blocks

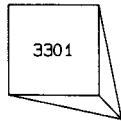

3301

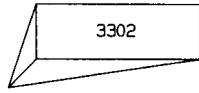

3302



3303

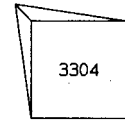

3304

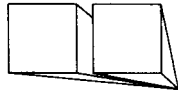

3336

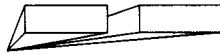

3337

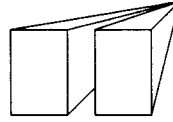

3338

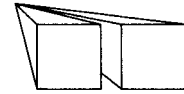

3339

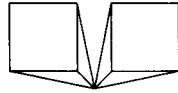

3307

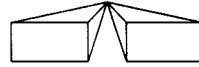

3308

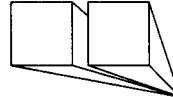

3305

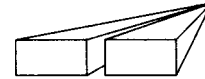

3306



2656

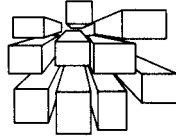

1148

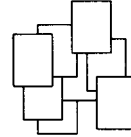

1147



2661

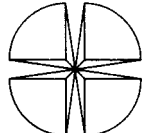

1166

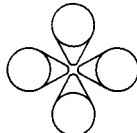

2657

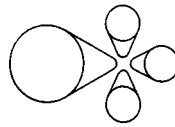

2647

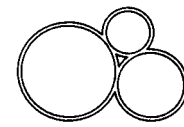

2648

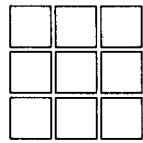

1268

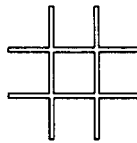

2659

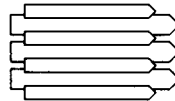

1503

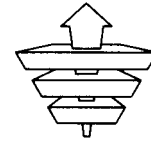

2660

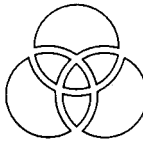

1504

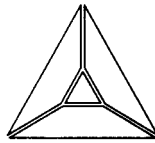

1640

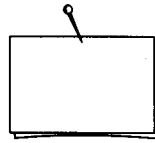

2663

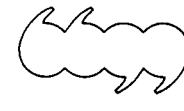

2116

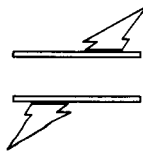

2658

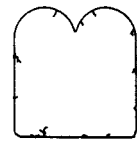

2736



1057



1547

# Graphic Aids - Word Balloons

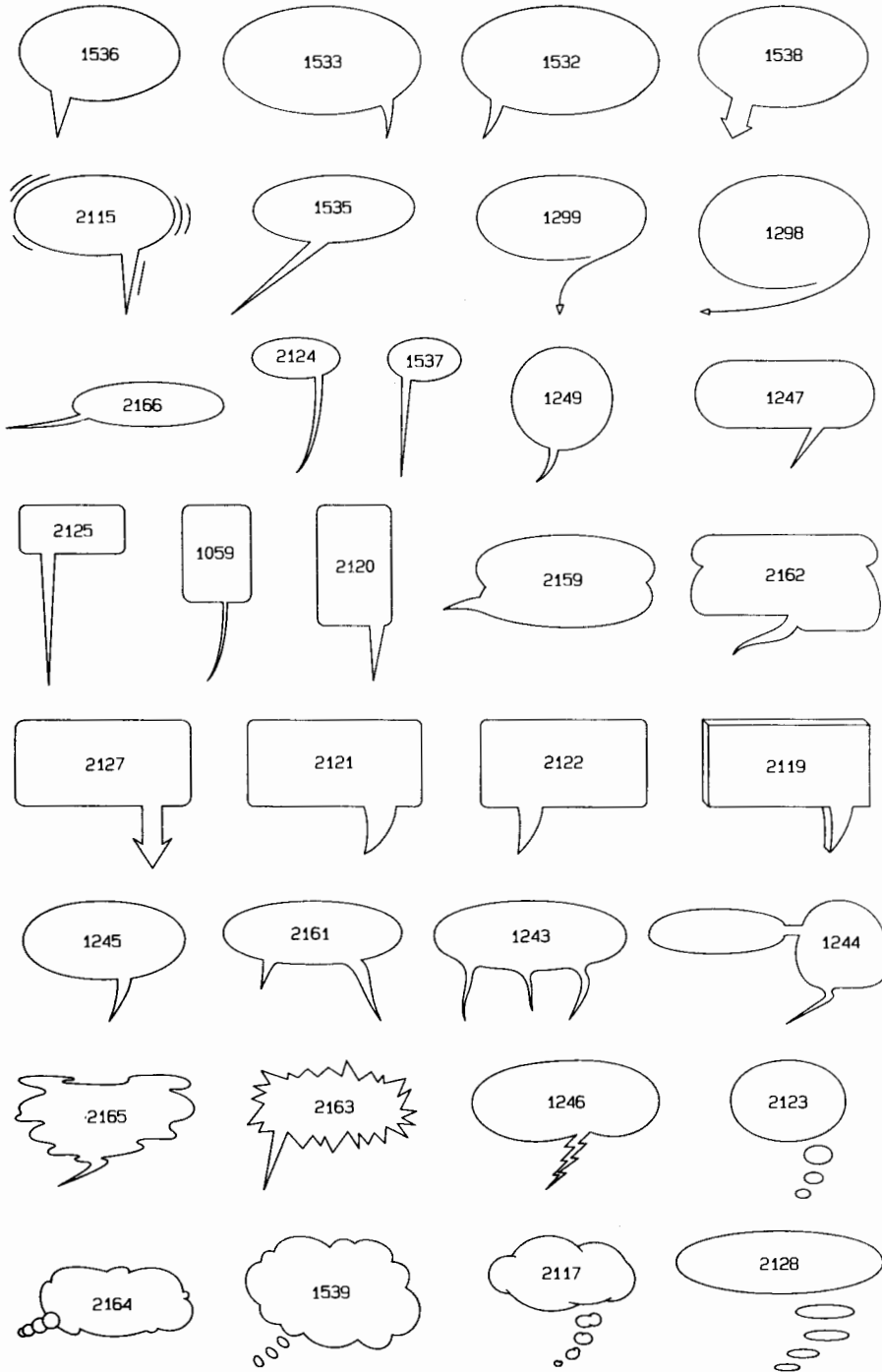

# 2 Geometrics

## Symbol Index

Description	Number	Lib.	Page	Description	Number	Lib.	Page
Angle				Septagon	2523		2-2
Acute	2617		2-1	Sine/Cosine Curve	3330		2-2
Right	2620		2-1	Tetrahedrons			2-8
Angles			2-1	Tools Protractor	2664		2-1
Arc (90 degrees)	2624		2-1	Trapezoids			2-2
Arches			2-3	Triangle			
Arcs			2-1	Equilateral	2501		2-2
Bell Curve	3323		2-1	Isosceles	2502		2-2
Circle	1002		2-3	Obtuse	2504		2-2
Circles, Partial			2-1	Right	2503		2-2
Cones			2-7				
Convex Lens	2551		2-3				
Cosine/Sine Curve	3330		2-1				
Cross							
Narrow	1684		2-3				
Wide	2535		2-3				
Crosses, 3-D			2-7				
Cubes							
Oblique			2-4				
Perspective			2-5				
Stacked			2-8				
Curves			2-1				
Cylinders							
3-D Oblique			2-4				
3-D Perspective			2-7				
Decagon	2529		2-2				
Dumbbell	2553		2-3				
Ellipses			2-3				
Exponential Curve	3324		2-1				
Exponential, Inverse	3325		2-1				
Frames, 3-D			2-8				
Functions							
Bell	3323		2-1				
Cubic	3326		2-1				
Exponential	3324		2-1				
Hyperbolic	3329		2-1				
Inverse Exponential	3325		2-1				
Parabolic	3328		2-1				
Quartic	3327		2-1				
Sine/Cosine	3330		2-1				
Tangent	2644		2-1				
Gaussian Curve	3323		2-1				
Geometrics			2-1				
Hexagons			2-2				
Lens, Convex	2551		2-3				
Line, Single	2487		2-1				
Lines							
Parallel	2488		2-1				
Perpendicular			2-1				
Lozenges			2-3				
Oblique, 3-D Geometrics			2-4				
Octagons			2-2				
Octahedrons			2-8				
Ovals			2-3				
Parabola	3328		2-1				
Parallelograms			2-2				
Pentagon							
Equilateral	2519		2-2				
Irregular	2520		2-2				
Perpendicular Lines			2-1				
Perspective, 3-D Geometrics			2-7				
Polyhedron, 20-Sided	2447		2-8				
Polyhedrons			2-8				
Primitives			2-1				
Prisms							
3-D			2-6				
Oblique			2-4				
Protractor	2664		2-1				
Pyramids			2-4				
Quadrilaterals			2-2				
Rhombus	1004		2-2				
Right Angle	2620		2-1				



---

*Notes*

---

# Geometrics - Primitives

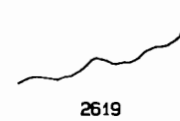
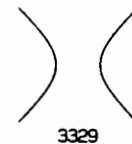
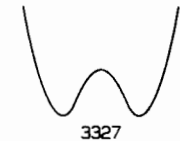
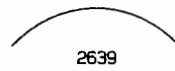
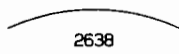
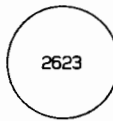
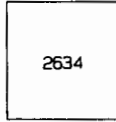
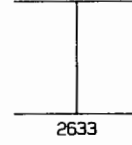
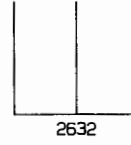
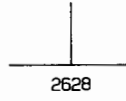
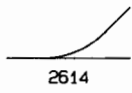
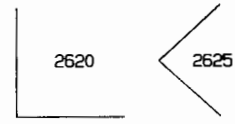
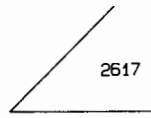
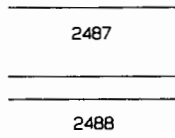

# Geometrics - 2D

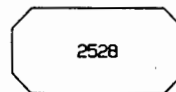
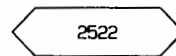
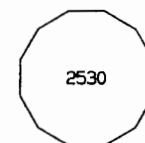
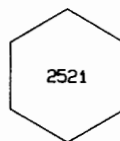
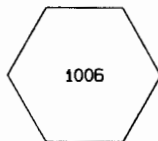
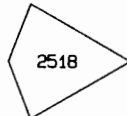
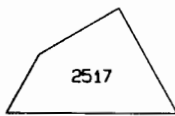
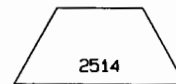
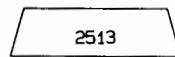
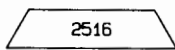
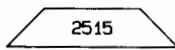
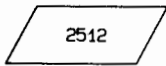
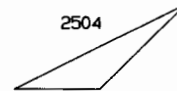
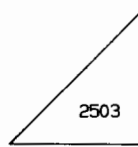
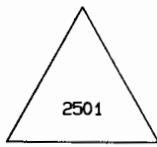
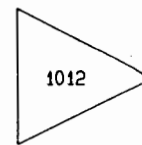
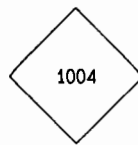
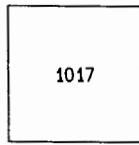
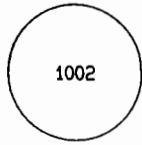

# Geometrics - 2D

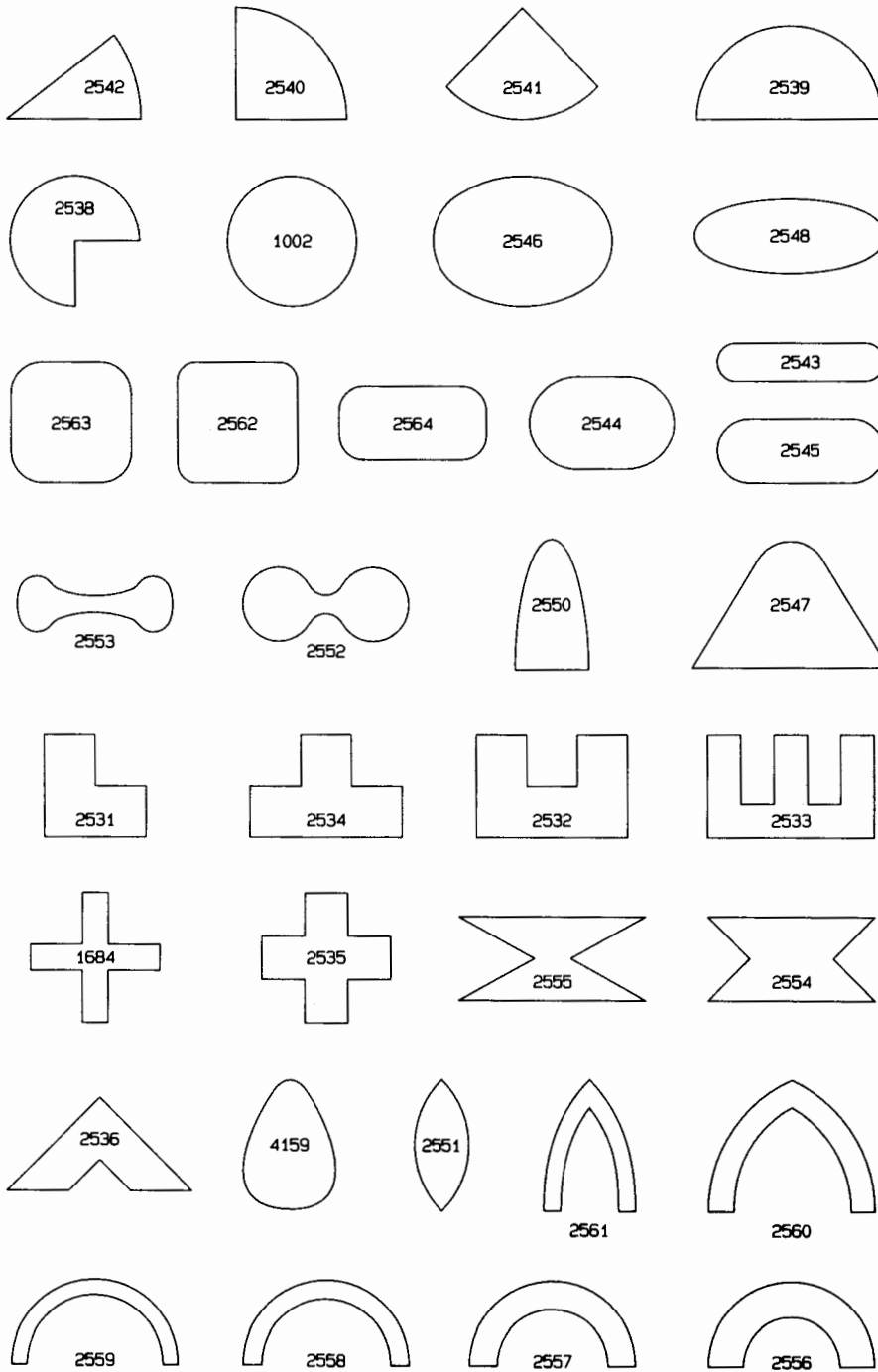



# Geometrics - 3D Oblique

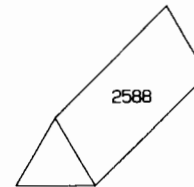
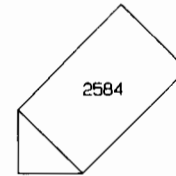
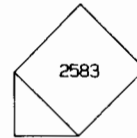
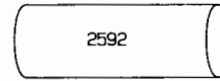
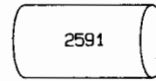
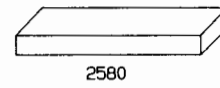
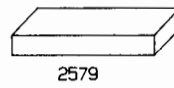
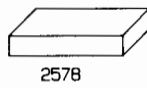
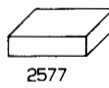
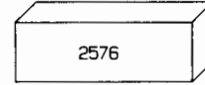
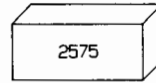
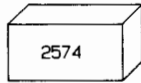
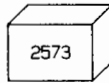
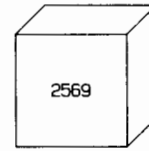
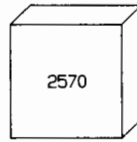
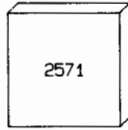
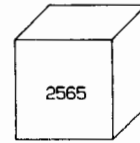
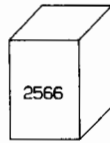
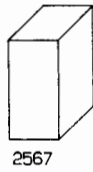

# Geometrics - 3D Perspective

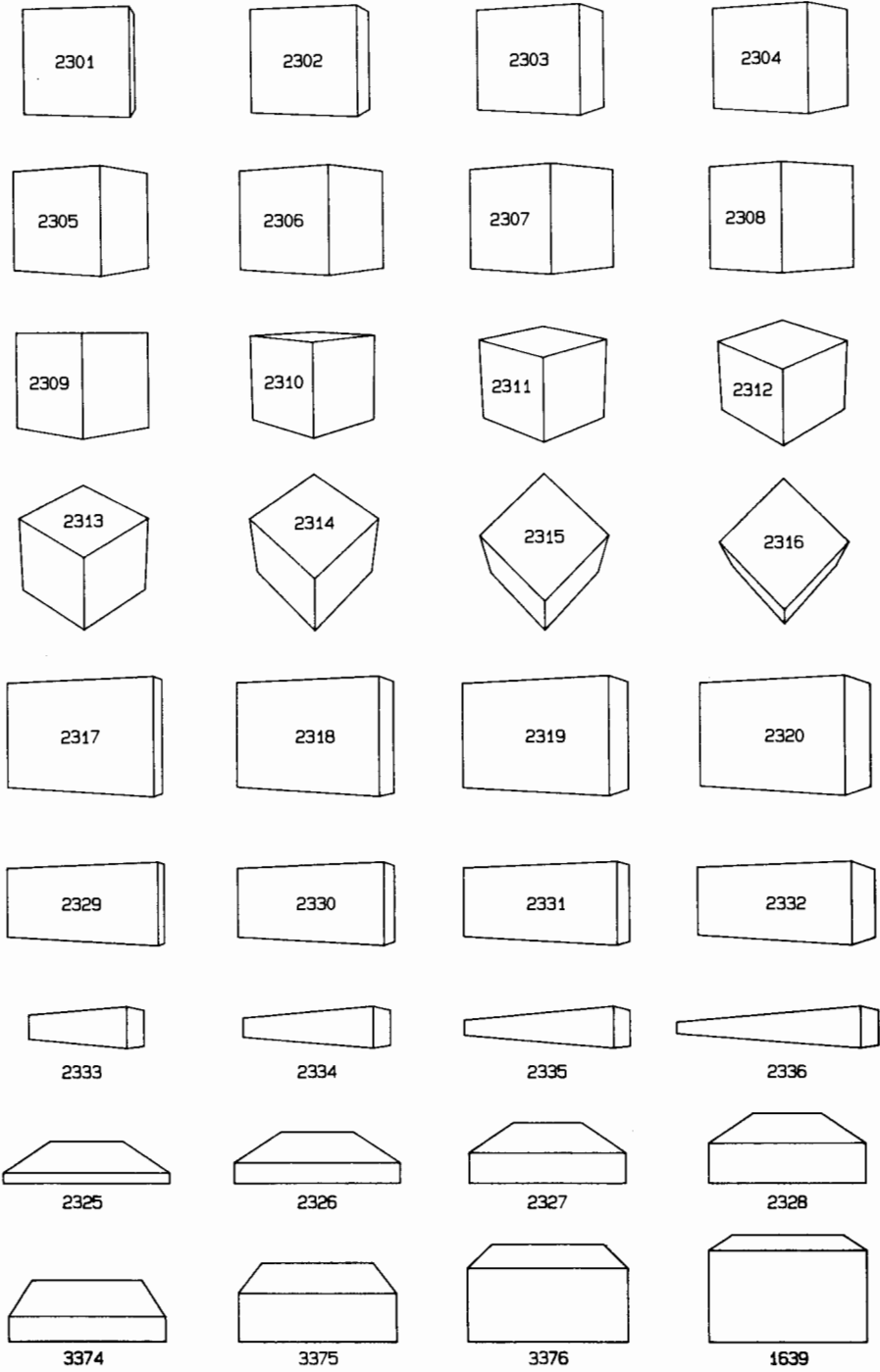

# Geometrics - 3D Perspective

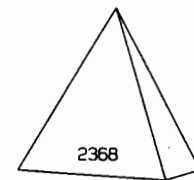
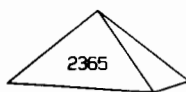
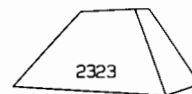
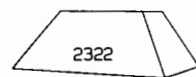
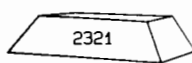
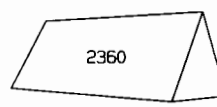
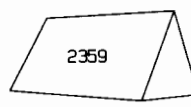
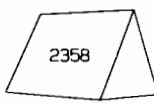
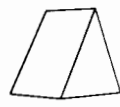
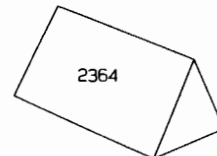
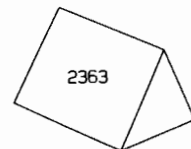
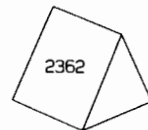
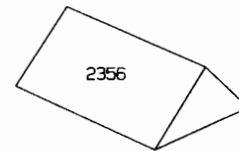
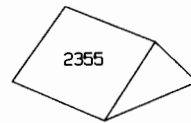
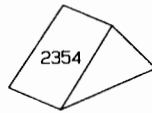
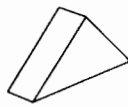
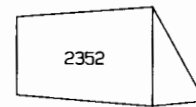
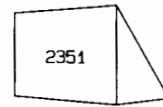
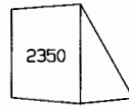
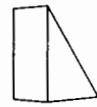
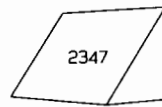
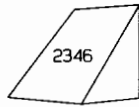
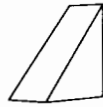
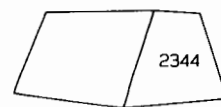
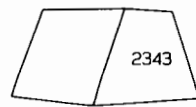
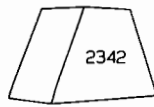
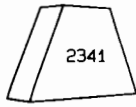

# Geometrics - 3D Perspective

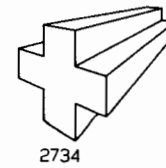
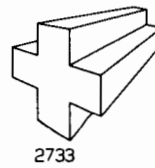
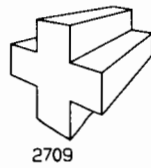
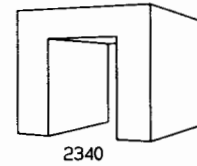
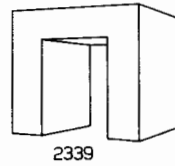
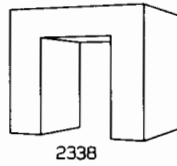
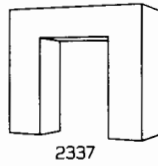
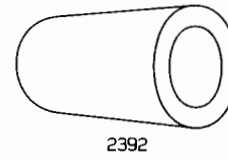
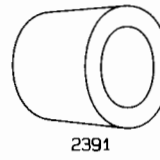
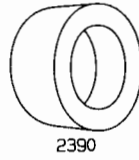
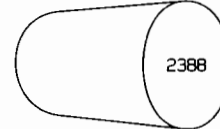
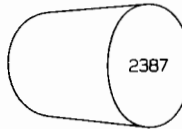
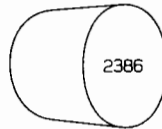
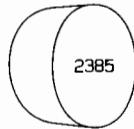
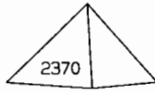

# Geometrics - 3D Perspective

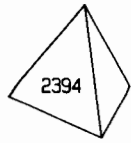

2394

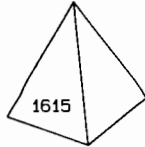

1615

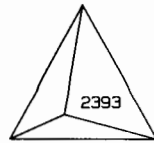

2393

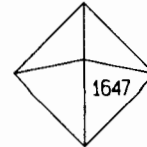

1647



2395



2397



2398

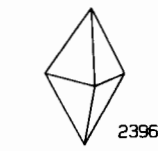

2396

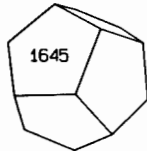

1645



2399

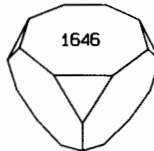

1646

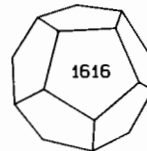

1616



1642



1644



2447



1643

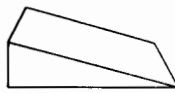

3377

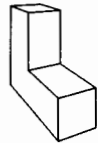

2701

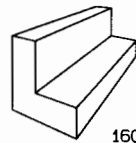

1609

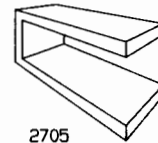

2705

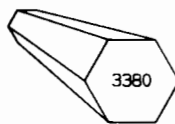

3380

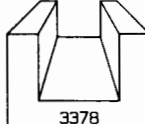

3378

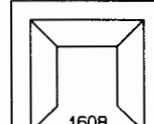

1608



3379

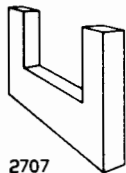

2707

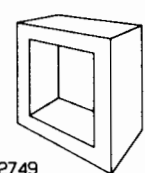

2749

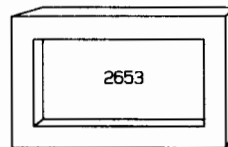

2653

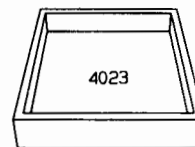

4023

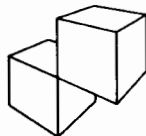

2748

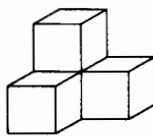

1186

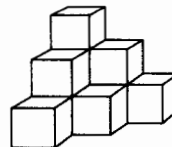

1187

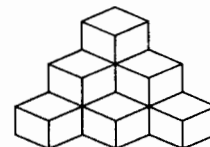

1933

# 3 Signs and Icons



## Symbol Index

Description	Number	Lib.	Page	Description	Number	Lib.	Page
Account Current (%)	2032		3-1	CRT Personal Computer	1970		3-9
Airplanes				Caduceus	4052		3-7
Commercial Jet	2018		3-6	Camera, Movie	2265		3-6
Fighter	2017		3-6	Capitol Building	4215		3-5
Swept-Wing Bomber	2015		3-6	Care Of (%)	2031		3-1
Trainer, Jet	2016		3-6	Cargo Ship	1947		3-6
Airport Sign	4067		3-3	Cat	2423		3-7
Ampersand (&)	2669		3-1	Cent Sign (¢)	2027		3-1
Angle (Notation)	1708		3-2	Chair, Secretary's	2276		3-9
Animals				Chemical			
Cat	2423		3-1	Glassware	4014		3-6
Chicken	4071		3-7	Plant	2412		3-5
Cow	4070		3-7	Plant	4316P		3-5
Deer (Stag)	4082		3-7	Chicken	4071		3-7
Dog, Puppy	2278		3-7	Child			
Dog, Terrier	2272		3-7	Boy	2262		3-7
Donkey	4058		3-7	Girl	2283		3-7
Elephant	4057		3-7	Church	2402		3-5
Hen	4071		3-7	City Skyline	4123		3-5
Mule	4058		3-7	Clock			
Approximately Equals (≈)	1701		3-2	Alarm	2289		3-9
Asterisk (*)	2029		3-1	Round	2273		3-9
Asterisk (8 points)	2107		3-1	Square	4042		3-9
At (@)	2033		3-2	Clothing	2430		3-7
Atomic Power	4007		3-6	Clover Leaf	1948		3-8
Atomic Power Plant	4047		3-5	Commas			3-1
Automobiles, Simple	1965		3-6	Computer			
Ax	4457		3-8	Paper	1495		3-9
Balance Scale				Terminal	1971		3-9
Equal	4005		3-7	Congruent (≅)	1701		3-2
Unequal	4006		3-7	Copyright (©)	2744		3-2
Barrel	4019		3-5	Courthouse	2405		3-5
Barrier (Road Signs)	4060		3-4	Cow	4070		3-7
Bars, Jail	4002		3-7	Cup, Trophy	4027		3-7
Bed	2046		3-8	Dagger (Notation)			
Beer Mug	4179		3-8	Double (‡)	2037		3-2
Bicycle	2271		3-6	Single (†)	2038		3-1
Blast Furnaces	4048		3-5	Dash (-)	1706		3-2
Border (Stamp)	1496		3-9	Deer	4082		3-7
Bow and Arrow	2294		3-8	Desks, Six-Drawer	2706		3-9
Boy	2262		3-7	Destroyer (Ship)	2014		3-6
Brace ({} )	2133		3-2	Diskette			
Bracket ([])	2132		3-2	Drive	1972		3-9
Bracket/Paranthesis ({} )	2131		3-2	3½ Inch	4439		3-9
Bridge				5¼ Inch	1974		3-9
Simple	2410		3-5	Division (÷)	1703		3-2
Trestle	2403		3-5	Documents	1982		3-9
Broadax	2437		3-8	Dog			
Building				Puppy	2278		3-7
Barn	4046		3-5	Terrier	2272		3-7
Capitol	4215		3-5	Dollar Signs			
Church	2402		3-5	One Bar	2025		3-1
Courthouse	2405		3-5	Two Bars	2026		3-1
Factory, Heavy Industry	2411		3-5	Dolly (Hand Truck)	2047		3-8
Factory, Light Industry	2408		3-5	Donkey	4058		3-7
Factory, w/Smoke	4016		3-5	Door	2049		3-8
Grain Elevator	2435		3-5	Double Dagger (‡)	2037		3-1
House	2298		3-5	Drum (55 Gallon)	4019		3-5
Lighthouse	2442		3-5	Eight Ball	3359		3-7
Mine Head	2436		3-5	Electric Socket	2264		3-8
Nuclear Power Plant	4047		3-5	Elephant	4057		3-7
Office, One Story	4011		3-5	Engine			
Rowhouse	4010		3-5	Modern	1967		3-6
Schoolhouse	2040		3-5	Steam	4098		3-6
Skyscraper	4050		3-5	Envelope			
Windmill	4051		3-5	Back	2295		3-9
Buildings				Front	2297		3-9
City Skyline	4123		3-5	Equals (=)	2673		3-2
Refinery	2434		3-5	3-D	1718		3-2
Buoy w/Light	4138		3-5	Erlenmeyer Flask	4201		3-6
Bus	2441		3-6	Exclamation Point			
Buzz Saw	4171		3-6	3-D	1720		3-2

## Signs and Icons, continued

Description	Number	Lib.	Page	Description	Number	Lib.	Page
Block	1506	..	3-1	Microphone	2299	..	3-6
Round	2130	..	3-1	Microscope	2043	..	3-6
Executioner's Ax	2437	..	3-8	Mine Head	2436	..	3-5
Extinguisher, Fire	2413	..	3-8	Miner's Helmet	2424	..	3-7
Faces				Minus (-)	1706	..	3-2
Cartoon Form	4118	..	3-7	Missiles	4053	..	3-6
Profile	1969	..	3-7	Modem	1973	..	3-9
Family	2433	..	3-7	Money, International	4451	..	3-8
Farm	4046	..	3-5	Movie Camera	2265	..	3-6
Female Symbol	1709	..	3-2	Mule	4058	..	3-7
File Cabinet	2274	..	3-9	Multiplication (x)	1704	..	3-2
Fire	2449	..	3-8	Music	4015	..	3-8
Fire Extinguisher	2413	..	3-8	Not Equal	2674	..	3-2
Flag	1944	..	3-8	Notation		..	3-1
Waving	1946	..	3-8	Notes, Music	4015	..	3-8
Flame	2249	..	3-8	Nuclear Power Plant	4047	..	3-5
Food Service Sign	4088	..	3-3	Number Sign (#)	2028	..	3-1
Forms			3-9	3-D	4040	..	3-2
Four Leaf Clover	1948	..	3-8	Office Building			
Frames, Sign			3-3	One Story	4011	..	3-5
Gas Plant	4049	..	3-5	Skyscraper	4050	..	3-5
Gasoline Pump	2263	..	3-5	Oil			
Gavel	2042	..	3-7	Derrick	4366	..	3-5
Gears	4061	..	3-6	Pump	1966	..	3-5
Girl	2283	..	3-7	Refinery	2434	..	3-5
Globe				Rig	4366	..	3-5
w/Grid	4036	..	3-9	Ounce (oz)	2792	..	3-1
w/Meridian Lines	4037	..	3-9	Pad and Pencil	2296	..	3-9
Grain Elevator	2435	..	3-5	Paint Brush and Can	2419	..	3-8
Gun				Pamphlet	1526	..	3-9
Pistol	2285	..	3-8	Paper			
Rifle	2712	..	3-8	Computer	1495	..	3-9
Hand Truck (Dolly)	2047	..	3-8	Folded	4345	..	3-9
Hard Hat	2290	..	3-7	Pad w/Pencil	2296	..	3-9
Hat				Pages Lifted	1979	..	3-9
Miner's Helmet	2424	..	3-7	Torn	4374	..	3-9
Top	4237	..	3-7	Paragraph (§)	2791	..	3-2
Head (Profile)	1969	..	3-7	Parenthesis ( )	2129	..	3-2
Heads, Cartoon	4118	..	3-7	Parenthesis/Bracket ({})	2131	..	3-2
Heart	1580	..	3-7	Pennant			
Helicopter	2280	..	3-6	One Point	1945	..	3-8
Hen	4071	..	3-7	Swallowtail	2438	..	3-8
House	2298	..	3-5	People			3-7
Hyphen (-)	1706	..	3-2	Boy	2262	..	3-7
I-Beam Cross Section	2420	..	3-6	Family	2433	..	3-7
Icons			3-5	Girl	2283	..	3-7
In/Out Basket	3383	..	3-9	Judge	4029	..	3-7
Infinity (Notation)	1780	..	3-2	Man	2282	..	3-7
Integral (∫)	1714	..	3-2	Person (Symbolic)	1959	..	3-7
Jail	4002	..	3-7	Woman	2284	..	3-7
Judge	4029	..	3-7	Woman	2439	..	3-7
Keyhole	4073	..	3-7	Per Thousand (Notation)	2035	..	3-1
Ladle, Steel Mill	2407	..	3-6	Percent (%)	2034	..	3-1
Lamp	2292	..	3-8	Person	1959	..	3-7
Leaf, Maple	1949	..	3-8	Phone	2275	..	3-9
Less Than (<)	1702	..	3-2	Pi (π)	1712	..	3-2
Less Than or Equal To (≤)	1707	..	3-2	Pick and Shovel	2417	..	3-6
Lighthouse	4138	..	3-5	Pistol	2285	..	3-8
Lock, Keyhole	2442	..	3-5	Plane, Wood	2416	..	3-6
Locomotive	4073	..	3-7	Planet w/Rings	1741	..	3-6
Modern	1967	..	3-6	Plus (+)	1705	..	3-2
Steam	4098	..	3-6	3-D	1719	..	3-2
Loving Cup (Trophy)	4027	..	3-7	Plus or Minus (±)	1715	..	3-2
Magnet	1578	..	3-7	Pound			
Magnifying Glass	4368	..	3-8	(#)	2028	..	3-1
Male Symbol	1710	..	3-2	3-D	4040	..	3-2
Man	2282	..	3-7	(lb.)	2036	..	3-1
(Symbolic)	1953	..	3-7	Sterling (Notation)	2039	..	3-1
Maple Leaf	1949	..	3-8	Power Plant, Nuclear	4047	..	3-5
Medal	4004	..	3-7	Prescription (℞)	1716	..	3-2
Medical Logo (Caduceus)	4052	..	3-7	Printer			
				3-D	1978	..	3-9

## Signs and Icons, continued

Description	Number	Lib.	Page	Description	Number	Lib.	Page
Simple	1977		3-9	No Right Turn	1911		3-4
Profile, Human Head	1969		3-7	No Smoking	4055		3-3
Pump				No Trucks	1910		3-4
Gasoline	2263		3-5	No U-Turn	1908		3-4
Oil Well	1966		3-5	One Way	1929		3-4
Question Mark	1505		3-1	Parking Permitted	2112		3-4
3-D	2731		3-2	Pedestrian Crossing	1995		3-4
Tapered	1583		3-1	Picnic Area	4096		3-3
Quotation Marks			3-1	Prohibited (Generic)	1801		3-3
Radio				Radiation	4074		3-3
Tower	2406		3-5	Railroad	1939		3-4
Modern	2288		3-6	Railroad Crossing	4136		3-4
Old-Fashioned	2048		3-8	Restaurant	4088		3-3
Railroad				1999			3-3
Car	1968		3-6	Riverbank	1902		3-4
Engine, Modern	1967		3-6	Road Curves	1994		3-4
Engine, Steam	4098		3-6	Road Narrows	1730		3-4
Reactor	4047		3-5	Road Splits	1956		3-4
Refinery	2434		3-5	Road Turns	1729		3-4
Refrigerator	2293		3-8	S-Curve	4135		3-3
Registered Trademark (®)	2745		3-2	School Crossing	1955		3-4
Rifle	2112		3-8	Secondary Road	4175		3-4
Rockets	4053		3-6	Slippery When Wet	1912		3-4
Rowhouse	4010		3-5	Stop	4068		3-3
Sailboat	2045		3-6	Taxi	3392		3-3
Satellite	4054		3-6	Telephone	1907		3-4
Saturn	1741		3-6	Three-Way	4084		3-3
Scale				Train Stop	1630		3-3
Balanced	4005		3-7	U.S. Highway	4087		3-3
Unbalanced	4006		3-7	Wear Goggles	1903		3-4
Schoolhouse	2040		3-5	Winding Road	1730		3-4
Scroll	2113		3-9	Y-Intersection	1906		3-4
Section Mark (§)	1717		3-1	Yield	2291		3-8
Shamrock	1948		3-8	Sink	4056P		3-8
Ship				Skull and Crossbones	4050		3-5
Cargo	1947		3-6	Skyscraper	2264		3-8
Destroyer	2014		3-6	Socket, Electrical	1711		3-2
Shovel and Pick	2417		3-6	Square Root (√)	4082		3-7
Sigma (Σ)	1713		3-2	Stag (Deer)	1496		3-8
Sign Borders			3-3	Stamp, Postage	2429		3-8
Signal Light	1926		3-4	Stapler	4098		3-6
w/Arrow	1925		3-4	Steam Engine	2407		3-6
Signs				Steel Mill Ladle	2039		3-1
Airport	4067		3-3	Sterling, Pound (Sign)	2287		3-8
Baggage	4001		3-3	Stool	2404		3-5
Bar	4064		3-3	Streetlamp	2013		3-6
Barrier	4060		3-4	Submarine	1731		3-6
Bus Stop	4134		3-3	Sun	2418		3-6
Construction	4083		3-3	Surveyor's Transit	4072		3-9
Danger!	1996		3-3	Table	2401		3-8
Directional	4176		3-4	Tape Dispenser	2428		3-9
Do Not Enter	1930		3-4	Telephone	2275		3-9
Electrical Danger	1629		3-3	Television	4072		3-9
Elevator	4062		3-3	Tent	4137		3-5
Explosives	4085		3-3	Tepee	2277		3-5
Falling Rocks	1975		3-3	Terminals CRT	1971		3-9
Fire Hazard	4075		3-3	Test Tube	4020		3-6
First Aid	4066		3-3	Tools			
Flammable	4075		3-3	Ax	2437		3-8
Food Service	4088		3-3	Buzz Saw	4171		3-6
Handicapped	1597		3-3	Magnet	1578		3-7
Information	4065		3-3	Paint Brush and Can	2419		3-8
Intersection	1957		3-4	Pick and Shovel	2417		3-6
Interstate Highway	1997		3-3	Plane, Wood	2416		3-6
Keep Right	4092		3-4	Surveyor's Transit	2418		3-6
Left Turn	4094		3-4	Top Hat	4237		3-7
Left Turn or Straight	4093		3-4	Tractor w/Driver	4099		3-6
Median Ahead	1998		3-4	Transistor Radio	2288		3-6
Merging Traffic	4177		3-4	Transit	2418		3-6
No Bridge	1999		3-3	Transmission Tower	2440		3-5
No Left Turn	1909		3-4	Transmitter Tower, Radio	2406		3-5
No Parking	2111		3-4	Trash			



---

*Signs and Icons, continued*

---

Description	Number	Lib.	Page
Basket (Door/Lid) .....	2044	..	3-8
Can .....	2281	..	3-8
Tree .....	2270	..	3-8
Tree, Evergreen .....	2266	..	3-8
Trestle Bridge .....	2403	..	3-5
Trophy Cup .....	4027	..	3-7
Vial .....	4020	..	3-6
Water Tower .....	2409	..	3-5
Windmill .....	4051	..	3-5
Woman .....	2284	..	3-7
Woman .....	2439	..	3-7
Wood Plane .....	2416	..	3-6
World			
w/Grid .....	4036	..	3-9
w/Meridians .....	4037	..	3-9
Yen Sign .....	2735	..	3-1

## Optional Library #1, More Icons 1

Description	Number	Lib.	Page	Description	Number	Lib.	Page
Air Brush	3502	1	3-11	Pots and Pans	4561	1	3-10
Anvil	4293	1	3-11	Pottery	4569	1	3-10
Automobile Battery	4538	1	3-11	Production Line Rollers	4540	1	3-10
Automobile on Hydraulic Lift	4184	1	3-11	Propane Torch	4256	1	3-11
Automobile Parts	4254	1	3-11	Quill and Ink Well	4531	1	3-10
Automobile Repair	4184	1	3-11	Razor, Double-Edge	4265	1	3-10
Baggage Check	4188	1	3-10	Roll of Paper	4562	1	3-11
Barrel, Wooden	4549	1	3-11	Rose	4558	1	3-10
Battery (Automotive)	4538	1	3-11	Scrub Brush and Bucket	4649	1	3-10
Bench Vise	4539	1	3-10	Sheet Metal, Corrugated	4541	1	3-11
Bolt of Cloth	4651	1	3-10	Shovel w/Dirt	4557	1	3-11
Box (Open Top)	4545	1	3-11	Sprayer (Air Brush)	3502	1	3-11
Bucket and Scrub Brush	4649	1	3-10	Spring			
Calipers	4295	1	3-10	Compressed	4566	1	3-10
Camera	4498	1	3-10	Expanded	4567	1	3-10
Camera, Movie/TV	4405	1	3-10	Switch, High Amp (Open)	4543	1	3-11
Can, Tin (Open Lid)	4525	1	3-11	Table, Work	4257	1	3-10
Cardboard Box (Open Top)	4545	1	3-11	Tin Can (Open Lid)	4525	1	3-11
Cart	2426	1	3-10	Tire	4275	1	3-11
Cash Register	4178	1	3-10	Tools			
Ceramics	4569	1	3-10	Air Brush	3502	1	3-11
Chain and Sprockets	4524	1	3-10	Anvil	4293	1	3-11
Cheese Block	4574	1	3-10	Bench Vise	4539	1	3-10
Cinder Block	4572	1	3-10	Calipers	4295	1	3-10
Clay Pipe	4544	1	3-11	Compass and 45° Triangle	4435	1	3-10
Commercial Airliner	4520	1	3-11	Crescent Wrench	4499	1	3-10
Compass and 45° Triangle	4435	1	3-10	Grease Gun	4535	1	3-11
Compressed-Gas Cylinder	4533	1	3-11	Hydraulic Jack	4528	1	3-10
Containers (Plastic Jugs)	4871	1	3-10	Micrometer	4529	1	3-10
Corrugated Sheet Metal	4541	1	3-11	Propane Torch	4256	1	3-11
Crescent Wrench	4499	1	3-10	Shovel w/Dirt	4557	1	3-11
Culvert	4559	1	3-11	Truck, 3-Axle	4421	1	3-11
Drum, 55-Gallon	3530	1	3-11	United States Flag (Stylized)	3507	1	3-10
Electric Plug (Male)	4537	1	3-10	Valve (Pipeline)	4497	1	3-11
Electronic Components	4552	1	3-11	Vise, Bench	4539	1	3-10
Eyeglasses	4675	1	3-10	Wagon	2427	1	3-10
Film Strip	4406	1	3-10	Wagon, Toy	2268	1	3-10
Fire Hydrant	4410	1	3-10	Washing Machine	4258	1	3-11
Flag, United States (Stylized)	3507	1	3-10	Whiskey Barrel	4549	1	3-11
Flame and Nozzle	4516	1	3-11	Wine Bottle	4573	1	3-10
Fork Lift	4534	1	3-11	Wire Spring			
French Horn	4521	1	3-10	Compressed	4566	1	3-10
Gasoline Can	4266	1	3-11	Expanded	4567	1	3-10
Gear	4496	1	3-11	Wooden Barrel	4549	1	3-11
Globe	4298	1	3-10	Work Table (Square)	4257	1	3-10
Grease Gun	4535	1	3-11	Wrench, Crescent	4499	1	3-10
High Amp Switch (Open)	4543	1	3-11				
Hot Dog	4570	1	3-10				
Hurricane Lamp	4518	1	3-11				
Hydraulic Jack	4528	1	3-10				
I-Beam and Pulley	4532	1	3-11				
Ice Cream Cone	4571	1	3-10				
Kerosene Lamp	4518	1	3-11				
Light Bulbs	4565	1	3-11				
Lumber	4672	1	3-11				
Micrometer	4529	1	3-10				
Milk Can	4564	1	3-10				
Milling Machine	2415	1	3-11				
Mine Ore Car	4264	1	3-11				
Mortar and Pestle	4495	1	3-10				
Motor, Electric	4255	1	3-11				
Natural Gas (Nozzle w/Flame)	4516	1	3-11				
Paper, Roll of	4562	1	3-11				
Pinch Rollers	4674	1	3-11				
Pipe							
Corrugated	4559	1	3-11				
T-joint	4536	1	3-11				
Pipeline Valve	4497	1	3-11				
Pipes (Three Stacked)	4544	1	3-11				
Plastic Containers	4871	1	3-10				
Plate Glass	3504	1	3-11				
Plywood	4673	1	3-11				

## Optional Library #8, More Icons 2

Description	Number	Lib.	Page	Description	Number	Lib.	Page
Airplanes				Reel of Tape	2914	8	3-12
Airplane Crash	3099	8	3-13	Rubber Stamp	2917	8	3-12
Jet Fighter	2946	8	3-13	Ruins	3103	8	3-13
Jet Fighter w/Explosion	2947	8	3-13	Sewage Pipe	2969	8	3-13
Alarm Bell	4408	8	3-13	Sheriff's Badge	2932	8	3-13
Antenna, Television	2923	8	3-12	Ship	2948	8	3-13
Auger	4526	8	3-12	Sinking	2949	8	3-13
Baby Bottle	4185	8	3-12	Shoeprint	2931	8	3-13
Badge, Sheriff's	2932	8	3-13	Shoes	1031	8	3-12
Bandage	2919	8	3-12	Sign (Food Available)	2267	8	3-12
Barbed Wire	4523	8	3-12	Star in a Circle	2932	8	3-13
Barrel	2930	8	3-13	Street Lamp	2920	8	3-13
Bathtub	4411	8	3-13	Syringe	2921	8	3-12
Block and Tackle	4297	8	3-12	Tank	2910	8	3-13
Bomb	3074	8	3-13	w/Explosion	2911	8	3-13
Bowling	2977	8	3-13	Tankcar	2944	8	3-12
Boxcar	2943	8	3-12	Telephone Pole	2933	8	3-13
Building				Television	2940	8	3-12
Factory w/Explosion	2938	8	3-13	Television Antenna	2923	8	3-12
Oil Derrick	2936	8	3-12	Thermometer	4494	8	3-13
Radio Tower w/Explosion	2939	8	3-13	Tools			
Buildings				Auger	4526	8	3-12
Cityscape	2414	8	3-12	Block and Tackle	4297	8	3-12
Ruins	3103	8	3-13	Drill Press	2605	8	3-12
Caboose	3673	8	3-12	Oil Can	4299	8	3-13
Calendar Pad (Daily)	2906	8	3-12	Toothpaste Tube	2925	8	3-13
Cannon	3056	8	3-13	Transformer	3260	8	3-13
Car, Wrecked	3669	8	3-13	Turntable	4186	8	3-12
Cigarette Pack	3790	8	3-12	Umbrella	2926	8	3-12
Cityscape	2414	8	3-12	Umbrella	2050	8	3-12
Clipboard	1950	8	3-12	Wagon Wheel	4568	8	3-13
Coffee Cup	4183	8	3-12	Water Can	2975	8	3-13
Coffee Mug	2286	8	3-12	Western Wear			
Cowboy Boot	2976	8	3-13				
Derrick, Oil	2936	8	3-12				
Disc Platters	2801	8	3-12				
Dress	2997	8	3-12				
Drill Press	2805	8	3-12				
Drum, 55-Gallon	2930	8	3-13				
Electric Plug	2974	8	3-13				
Factory w/Explosion	2938	8	3-13				
File Folders	2915	8	3-12				
Fire Hose	4563	8	3-13				
Flatcar	2945	8	3-12				
Footprint (Shoe On)	2931	8	3-13				
Gas Lamp	2912	8	3-13				
Glass w/Straw	4181	8	3-12				
Glove	2929	8	3-13				
Hat	2922	8	3-12				
Hat, Western Style	3973	8	3-12				
Hopper Car	3674	8	3-12				
Insulated Wire/Cable	3181	8	3-13				
Jacket	2909	8	3-12				
Jet Fighter	2946	8	3-13				
w/Explosion	2947	8	3-13				
Lamp, Gas	2912	8	3-13				
Locomotive	2941	8	3-12				
w/Explosion	2942	8	3-13				
Mail	2916	8	3-12				
Medical Tape	2918	8	3-12				
Medicine Bottle and Capsules	2913	8	3-12				
Missile (On Launch Pad)	3660	8	3-13				
Mug, Coffee	2286	8	3-12				
Nut and Bolt	2928	8	3-13				
Offshore Oil Platform	2959	8	3-13				
Oil Can	4299	8	3-13				
Oil Derrick	2936	8	3-12				
Pin Insulator	3186	8	3-13				
Pipeline End (Liquid Pouring Out)	2969	8	3-13				
Push-cart	2924	8	3-13				
Puzzle Pieces	4555	8	3-12				
Radio Tower w/Explosion	2939	8	3-13				

## Optional Library #9, More Icons 3

Description	Number	Lib.	Page	Description	Number	Lib.	Page
Alarm Siren	3256	9	3-15	Royal Guard (Side of Head)	3671	9	3-15
Animals				Scissors	3005	9	3-14
Camel	3021	9	3-15	Screwdriver w/Screw	3291	9	3-15
Crow	3084	9	3-15	Scroll	3652	9	3-15
Dove w/Olive Branch	3076	9	3-15	Ship			
Fish	3028	9	3-15	Front View	3003	9	3-14
Mouse	3020	9	3-15	Helm/Wheel	2980	9	3-14
Rabbit	3019	9	3-15	Shock of Wheat	2957	9	3-14
Antenna, Dish	3259	9	3-14	Shopping Cart	2968	9	3-14
Award/Document	2954	9	3-14	Siren, Alarm	3256	9	3-15
Ball Bearings	3155	9	3-15	Six Pack	3081	9	3-15
Blue Ribbon	3018	9	3-15	Snow Cloud	3104	9	3-15
Bomb	2951	9	3-14	Sphere, Shiny	2967	9	3-14
Book, Open	2953	9	3-14	Sports (3 Balls)	3089	9	3-15
Bottle, Plastic (Gallon)	3151	9	3-14	Stock Market Ticker	3012	9	3-14
Box	3035	9	3-14	Sun			
Broom	3257	9	3-15	Average	2989	9	3-15
Bucket	2952	9	3-14	Heat Wave	3101	9	3-15
Bushel Basket	2955	9	3-14	w/Cloud	2983	9	3-15
Camel	3021	9	3-15	w/Two Clouds	2984	9	3-15
Camera, Video (Hand-Held)	3013	9	3-15	T-Square	3036	9	3-14
Carpentry (Framing)	3038	9	3-14	Telephone Handset	3004	9	3-14
Carpet Roll	3037	9	3-14	Thermometer	3032	9	3-14
Caster	3029	9	3-14	Thunder Cloud	2987	9	3-15
Ceiling Lamp	3183	9	3-15	Toilet	4294	9	3-14
Chemical Bottle, Glass	3043	9	3-14	Tools			
Civil Defense Siren	3256	9	3-15	Claw Hammer	3156	9	3-15
Claw Hammer	3156	9	3-15	Paint Roller	3039	9	3-14
Clouds				Screwdriver (w/Screw)	3291	9	3-15
Cloud	2985	9	3-15	T-Square	3036	9	3-14
Rain Cloud	2988	9	3-15	Tornado	3970	9	3-15
Snow Cloud	3104	9	3-15	Tornado Cloud	2986	9	3-15
Thunder Cloud	2987	9	3-15	Tower, Communications	3127	9	3-14
Tornado Cloud	2986	9	3-15	Toys	3266	9	3-14
Cloudy, Partly	2984	9	3-15	Tree Stump	3034	9	3-14
Communication Tower	3127	9	3-14	Tube, Light	3187	9	3-15
Council/Board	3096	9	3-15	Twister (Tasmanian Devil)	3970	9	3-15
Crate	3160	9	3-15	Vacuum Cleaner	3092	9	3-15
Crow	3084	9	3-15	Video Camera (Hand-Held)	3013	9	3-15
Diamond Ring	3041	9	3-14	Water Droplet	2927	9	3-15
Dock Crane	3006	9	3-14	Wheat, Shock of	2957	9	3-14
Document/Award	2954	9	3-14	Wind Blowing Trees	3105	9	3-15
Dolly				Wine Glass	3042	9	3-14
2 Wheel w/Boxes	3031	9	3-14				
4 Wheel	3030	9	3-14				
Dove w/Olive Branch	3076	9	3-15				
Fish	3028	9	3-15				
Flowers in Vase	3166	9	3-15				
Gallon Jug	3151	9	3-14				
Gravestone	3169	9	3-15				
Guitar, 3-String	3022	9	3-15				
Hand Truck w/Boxes	3031	9	3-14				
Headphones	3286	9	3-15				
Hour Glass	2981	9	3-14				
Light Bulb	3051	9	3-15				
Light Tube	3187	9	3-15				
Mailbox	2970	9	3-14				
Money Bag	2962	9	3-14				
Mop and Bucket	3287	9	3-15				
Mouse	3020	9	3-15				
Movie Projector	3040	9	3-14				
Paint Roller	3039	9	3-14				
Paper Money (Generic)	2956	9	3-14				
Paper, Reams of	3152	9	3-14				
People							
Committee/Board	3096	9	3-15				
Royal Guard	3671	9	3-15				
Photographic Enlarger	3088	9	3-15				
Platform Truck	3030	9	3-14				
Price Tag	3668	9	3-14				
Rabbit	3019	9	3-15				
Rain Cloud	2988	9	3-15				

## Optional Library #10, More Icons 4

Description	Number	Lib.	Page	Description	Number	Lib.	Page
Airplanes				Bust of Lincoln	3067	10	3-17
Bomber/Twin Prop	3695	10	3-17	Doctor	3077	10	3-16
Four Engine Jet	2991	10	3-17	Man Drinking at Table	3025	10	3-16
Four Engine Prop	2990	10	3-17	Man Working at Desk	3001	10	3-16
Single Engine Prop	3015	10	3-17	Man at Podium	3097	10	3-17
Small Engine Prop	2971	10	3-17	Men Drinking at Table	3024	10	3-16
Straight Wing Jet w/Tip Tanks	2973	10	3-17	Men Shaking Hands	3023	10	3-16
Swept-wing Jet	3109	10	3-17	Murder Victim/Outline	3654	10	3-16
Twin (Rear) Engine Jet	3696	10	3-17	Policeman	3079	10	3-16
Twin Boom/Twin Prop	3110	10	3-17	Professor	3075	10	3-16
Twin Engine Prop	2972	10	3-17	Soldier	3069	10	3-16
Animals				Student/Man at Desk	3071	10	3-16
Bear	3011	10	3-16	Woman Working at Desk	3002	10	3-16
Giraffe	3010	10	3-16	Woman w/Shopping Cart	3026	10	3-16
Ostrich w/Head in Sand	2996	10	3-16	Policeman	3079	10	3-16
Sailfish	3957	10	3-16	Professor	3075	10	3-16
Sheep (One)	3137	10	3-16	Profile/Bust of Lincoln	3067	10	3-17
Badge, Police	3262	10	3-16	Purse	2999	10	3-16
Bank Safe	3058	10	3-17	Record Album	3146	10	3-17
Bear	3011	10	3-16	Retort, Glass	3098	10	3-16
Bicycle	2269	10	3-17	Robot Arm	3070	10	3-17
Bottle w/Potion Inside	3131	10	3-16	Safe	3058	10	3-17
Bridge, Suspension	3083	10	3-16	Sailfish	3957	10	3-16
Building				Scales of Justice	3107	10	3-16
Castle	2995	10	3-17	Schooner	3082	10	3-16
House, Split Level	3136	10	3-16	Sheep (One)	3137	10	3-16
Businessman	3111	10	3-16	Shirt	3095	10	3-17
Cards, Hand of	3670	10	3-16	Sledge Hammer	3047	10	3-17
Cassette Tape	3027	10	3-17	Soldier	3069	10	3-16
Castle	2995	10	3-17	Spool of Thread	3053	10	3-17
Convenience Store	2966	10	3-17	Tank, Horizontal Storage	3068	10	3-17
Dice, Pair of (Lucky Seven)	3072	10	3-16	Tax Man (Uncle Sam's Hand)	3115	10	3-17
Diploma	3128	10	3-16	Thumbs Up	3184	10	3-17
Discs, 3/2 Inch	2994	10	3-17	Tire Tread	3182	10	3-16
Doctor	3077	10	3-16	Tooth	3073	10	3-17
Drumstick	3299	10	3-16	Uncle Sam's Hand (Palm Up)	3115	10	3-17
Eye	3057	10	3-17	Video Game	3059	10	3-17
Felt Tip Pen	3185	10	3-17				
First Aid Kit	3274	10	3-16				
Flask, Chemical	3791	10	3-16				
Football Helmet	3060	10	3-17				
Genie's Lamp	3132	10	3-16				
Giraffe	3010	10	3-16				
Hammer, Sledge	3047	10	3-17				
Hand							
Halt!	3046	10	3-17				
OK Sign	3048	10	3-17				
Peace/Victory	3009	10	3-17				
Thumbs Up	3184	10	3-17				
Uncle Sam's w/Palm Up	3115	10	3-17				
Hands							
Reaching Toward Each Other	3165	10	3-17				
Shaking	4996	10	3-16				
House, Split Level	3136	10	3-16				
Jeans	3055	10	3-17				
Lamp, Aladdin's	3132	10	3-16				
Lipstick	3153	10	3-16				
Mail Deposit Box	3061	10	3-17				
Mining	3188	10	3-17				
Molar	3073	10	3-17				
Money, Stack of	3054	10	3-16				
Nickle	3118	10	3-16				
Ostrich w/Head in Sand	2996	10	3-16				
Paint Brush, Artist's	3066	10	3-17				
Paper							
Continuous Form	3080	10	3-16				
Diploma	3128	10	3-16				
Parachute	3179	10	3-17				
Peace/Victory Sign	3009	10	3-17				
Pennant w/Hand	3962	10	3-16				
People							
Businessman	3111	10	3-16				

## Optional Library #16, More Icons 5

Description	Number	Lib.	Page	Description	Number	Lib.	Page
<b>Animals</b>				<b>Railcar</b>			
Bird of Prey	3126	16	3-19	Double Wheel and Assembly	3176	16	3-19
Boll Weevil	3045	16	3-18	Single Wheel and Assembly	3175	16	3-19
Bull	3159	16	3-19	Railroad Tracks (Symbolic)	3189	16	3-18
Butterfly	3119	16	3-18	Rhinoceros	3663	16	3-19
Cat	3272	16	3-19	Rook (Chess Piece)	3121	16	3-18
Cockroach	3017	16	3-18	Ruler, 12 Inch	3102	16	3-18
Fly	3650	16	3-18	Saw	3049	16	3-18
Insect	3017	16	3-18	<b>Signs</b>			
Pig	3140	16	3-19	Highway (Symbolic)	3190	16	3-18
Rhinoceros	3663	16	3-19	Pipeline (Symbolic)	3664	16	3-18
Snake	3935	16	3-19	Railroad Tracks (Symbolic)	3189	16	3-18
Spider	3134	16	3-18	In Ground w/Post	3094	16	3-18
Ballot Box	3273	16	3-18	Silo, Grain	3130	16	3-18
Barricade	3194	16	3-19	Slide, Photographic	3091	16	3-18
Battery (D Cell)	3133	16	3-18	Snake	3935	16	3-19
Bird of Prey	3126	16	3-19	<b>Soft Drink</b>			
Bishop (Chess Piece)	3123	16	3-18	Bottle (16 oz)	3296	16	3-19
Blueprint	3090	16	3-18	Bottle (2 liter)	3298	16	3-19
Boll Weevil	3045	16	3-18	Transfer Tank	3297	16	3-19
Box (Taped)	3658	16	3-19	Speaker, 3-Way	3064	16	3-19
Brain (Profile)	3294	16	3-19	Spider	3134	16	3-18
Briefcase	3129	16	3-18	Statue of Liberty	3086	16	3-18
<b>Building</b>				Stereo Receiver	3065	16	3-19
Grain Silo	3130	16	3-18	Table (w/Open Side)	3050	16	3-18
House under Construction	3661	16	3-19	Television Screen	3008	16	3-18
Bull	3159	16	3-19	Ticket	2993	16	3-18
Butterfly	3119	16	3-18	Ticket, Torn	2992	16	3-18
Cactus	3167	16	3-18	Tissue, Bathroom	3289	16	3-19
Calendar	3117	16	3-18	<b>Tools</b>			
Camper	3285	16	3-19	Hunting Knife	3195	16	3-19
Can, Aluminum	3016	16	3-18	Ruler, 12 Inch	3102	16	3-18
Canned Food	3261	16	3-19	Saw	3049	16	3-18
Cat	3272	16	3-19	Tragedy Mask	3171	16	3-18
Checked Flag	3114	16	3-18	Tramway, Aerial	3292	16	3-19
Chess Pieces				Tree	3196	16	3-18
Clothesline	3288	16	3-19	<b>Truck Wheels and Rear Assembly</b>			
Cockroach	3017	16	3-18	Single Axle	3177	16	3-19
Cold Drink	3263	16	3-19	Dual Axle	3178	16	3-19
Comedy Mask	3172	16	3-18	Volcano	3197	16	3-19
Corn	3085	16	3-18	Welding	3284	16	3-19
Crate, Cargo	3280	16	3-19	Wheel and Bracket	3174	16	3-19
Dropper Bottle	3283	16	3-19	Work Gloves	3276	16	3-19
Drum	3116	16	3-18				
Flag, Checkered	3114	16	3-18				
Fly	3650	16	3-18				
Forest (Burned)	3653	16	3-19				
Gas Mask	3282	16	3-19				
Glass of Cold Liquid	3263	16	3-19				
Glass, Broken	3293	16	3-19				
Gloves, Work	3276	16	3-19				
Grain, Corn	3085	16	3-18				
Grain Silo	3130	16	3-18				
Groceries, Sack of	3173	16	3-19				
Highway (Symbolic)	3190	16	3-18				
Hospital Patient	3290	16	3-19				
House under Construction	3661	16	3-19				
Insect	3017	16	3-18				
King (Chess Piece)	3125	16	3-18				
Knife, Hunting	3195	16	3-19				
Knight (Chess Piece)	3122	16	3-18				
Mesas	3278	16	3-19				
Microphone	3281	16	3-19				
Milk Carton	3277	16	3-19				
Newspaper	3106	16	3-18				
Palm Tree	2982	16	3-18				
Pawn (Chess Piece)	3120	16	3-18				
Photographic Slide	3091	16	3-18				
Pig	3140	16	3-19				
Pipeline (Symbolic)	3664	16	3-18				
Plant	3139	16	3-18				
Queen (Chess Piece)	3124	16	3-18				

## Optional Library #17, More Icons 6

Description	Number	Lib.	Page	Description	Number	Lib.	Page
Abacus	3925	17	3-21	Photo w/Corner Mountings	3965	17	3-21
Anchor	3052	17	3-20	Popsicle	3686	17	3-20
Animals				Pueblo	3680	17	3-20
Blue Whale	3954	17	3-21	Quarry	3943	17	3-21
Eagle (Emblematic)	3651	17	3-20	Razor	3655	17	3-20
Flamingo	3795	17	3-21	Razor Blade, Single Edge	3268	17	3-20
Horse in Motion	3972	17	3-21	Rolodex Card	3265	17	3-20
Parrot	3796	17	3-21	Rooster Weather Vane	3193	17	3-20
Unicorn	3931	17	3-21	Saxophone	3949	17	3-21
Baby Carriage	3936	17	3-21	Scale (Hanging Produce Type)	3929	17	3-21
Bale of Cotton	3270	17	3-20	Screen w/People Watching	3108	17	3-20
Beach Umbrella	3960	17	3-21	Security Gate	3269	17	3-20
Blender	3692	17	3-21	Shovel in Ground	3928	17	3-21
Blue Whale	3954	17	3-21	Shrimp Trawler	3681	17	3-20
Bugle	3688	17	3-20	Sign (Universal Man)	3158	17	3-20
Butcher Knife and Meat	3271	17	3-20	Soldier (Royal Guard at Attention)	3944	17	3-21
Calligraphy Pen	3932	17	3-21	Sombrero	3679	17	3-20
Cards, Computer Punch	2960	17	3-20	Spray Bottle	3793	17	3-21
Cathedral/Mission	3958	17	3-21	Stopwatch	3953	17	3-21
Celebration/Horn	3945	17	3-21	Stroller, Baby	3936	17	3-21
Certificate	3691	17	3-21	Tea Bag	3934	17	3-21
Cigar	3933	17	3-21	Telescope (Refractor)	3941	17	3-21
Computer Punch Cards	2960	17	3-20	Tennis Racket and Ball	3677	17	3-20
Cotton, Bale of	3270	17	3-20	Theatre and Audience	3108	17	3-20
Crown	3144	17	3-20	Tools			
Desk Mat	3965	17	3-21	Monkey Wrench	3667	17	3-20
Document	3164	17	3-20	Nail Gun	3666	17	3-20
Dollar Sign Split Down the Middle	3975	17	3-21	Shovel in Ground	3928	17	3-21
Eagle (Emblematic)	3651	17	3-20	Torch	3143	17	3-20
Earth Remover Digging	3938	17	3-21	Towels on Rack	3264	17	3-20
Easel w/Canvas	3948	17	3-21	Tractor (Covered Cab)	3675	17	3-21
Eiffel Tower	3672	17	3-20	Trawler (Shrimper)	3681	17	3-20
Film (35mm Roll)	3951	17	3-21	Umbrella, Beach	3960	17	3-21
Flamingo	3795	17	3-21	Unicorn	3931	17	3-21
Footprint	3007	17	3-20	Victrola (Top View)	3939	17	3-21
Gas/Oil Well w/Underground Pocket	3942	17	3-21	Violin	3676	17	3-20
Gasoline, Pumping	3690	17	3-21	Water	2958	17	3-20
Gate, Security	3269	17	3-20	Water Geyser	3279	17	3-20
Golf Ball and Flag	3930	17	3-21	Waves	2937	17	3-20
Hook (Industrial)	3978	17	3-20	Weather Vane, Rooster	3193	17	3-20
Horn/Celebration	3945	17	3-21	Whale, Blue	3954	17	3-21
Horse in Motion	3972	17	3-21	Windmill	3799	17	3-21
Indian w/Headdress	3170	17	3-20	Wrench, Monkey	3667	17	3-20
Kite	3959	17	3-21				
Ladder	3062	17	3-20				
Luggage w/Travel Stickers	3687	17	3-20				
Lungs	3977	17	3-21				
Mask	3147	17	3-20				
Match	2934	17	3-20				
Burning	2935	17	3-20				
Mining w/Tunnels	3937	17	3-21				
Mining, Strip	3938	17	3-21				
Mission (Church Building)	3958	17	3-21				
Monkey Wrench	3667	17	3-20				
Monopoly Board	3940	17	3-21				
Mountains	3145	17	3-20				
Nail Gun, Pneumatic	3666	17	3-20				
Oil/Gas Well w/Underground Pocket	3942	17	3-21				
Paint Bucket	3927	17	3-21				
Paper							
Certificate	3691	17	3-21				
Document	3164	17	3-20				
Strewn About	3657	17	3-20				
Unfolded w/Dart	3961	17	3-21				
w/Corner Curved Up	2715	17	3-20				
w/Corner Mountings	3965	17	3-21				
Parrot	3796	17	3-21				
Pen, Calligraphy	3932	17	3-21				
People							
Audience Watching Screen	3108	17	3-20				
Indian w/Headdress	3170	17	3-20				
Royal Guard at Attention	3944	17	3-21				

# Signs - Notation

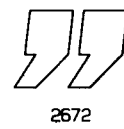
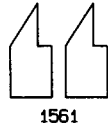
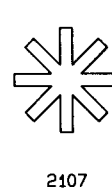
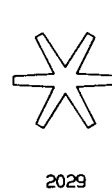
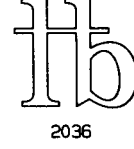
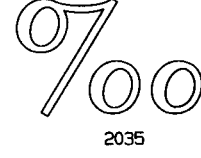
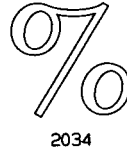
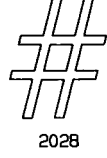
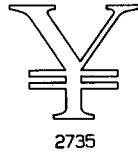
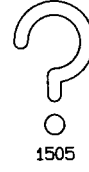



## Signs - Notation



1704

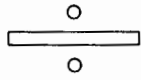

1703



1701

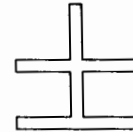

1715

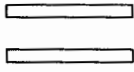

2673

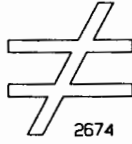

2674

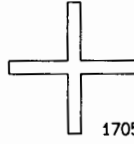

1705



1706

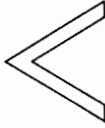

1702



1707

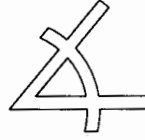

1708

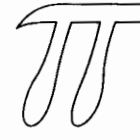

1712

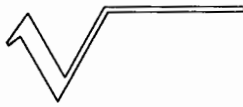

1711



1713



1714



1780



2129

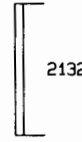

2132

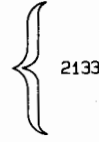

2133

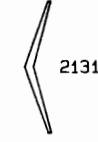

2131



1709



1710



1716



2033



2744



2745



2791

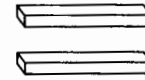

1718

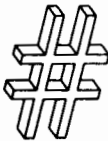

4040



2731



1720

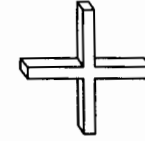

1719

# Signs - Health and Safety

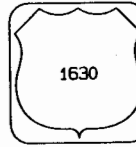
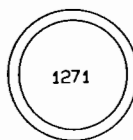
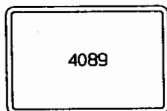
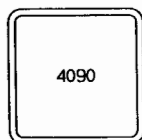

4083

1996

1999

1975

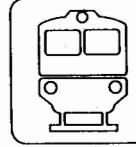
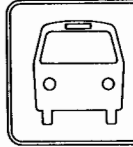
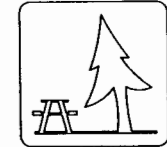

4135

4096

4134

4084

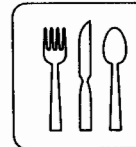
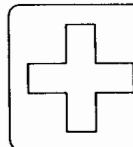
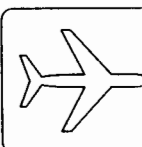

4067

4068

4066

4088

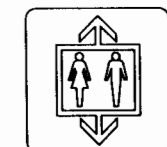

1597

4062

4001

4064



4065

4055

4087

3392



4074

4075

1629

4085

# Signs - Road

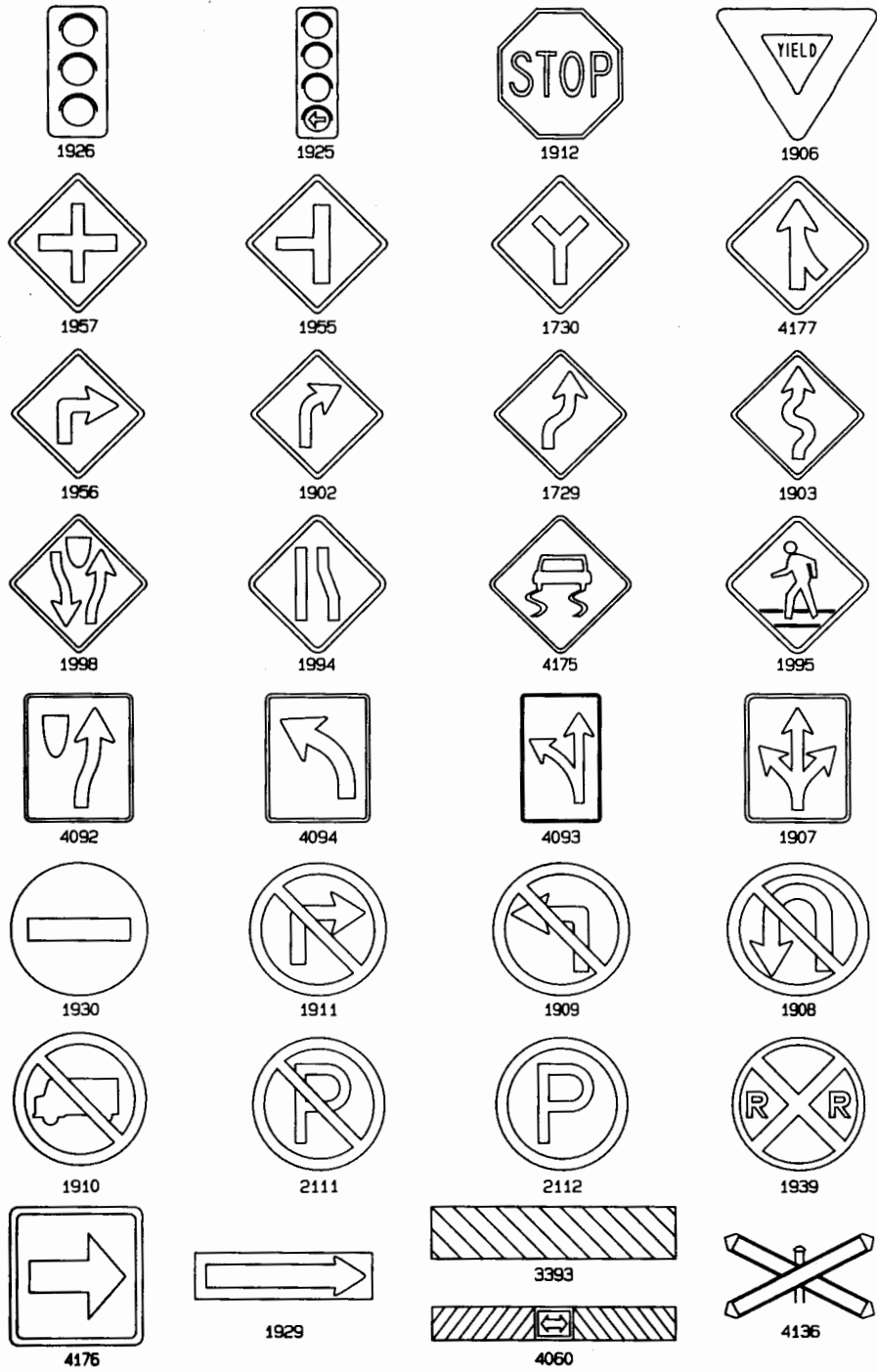

# Icons

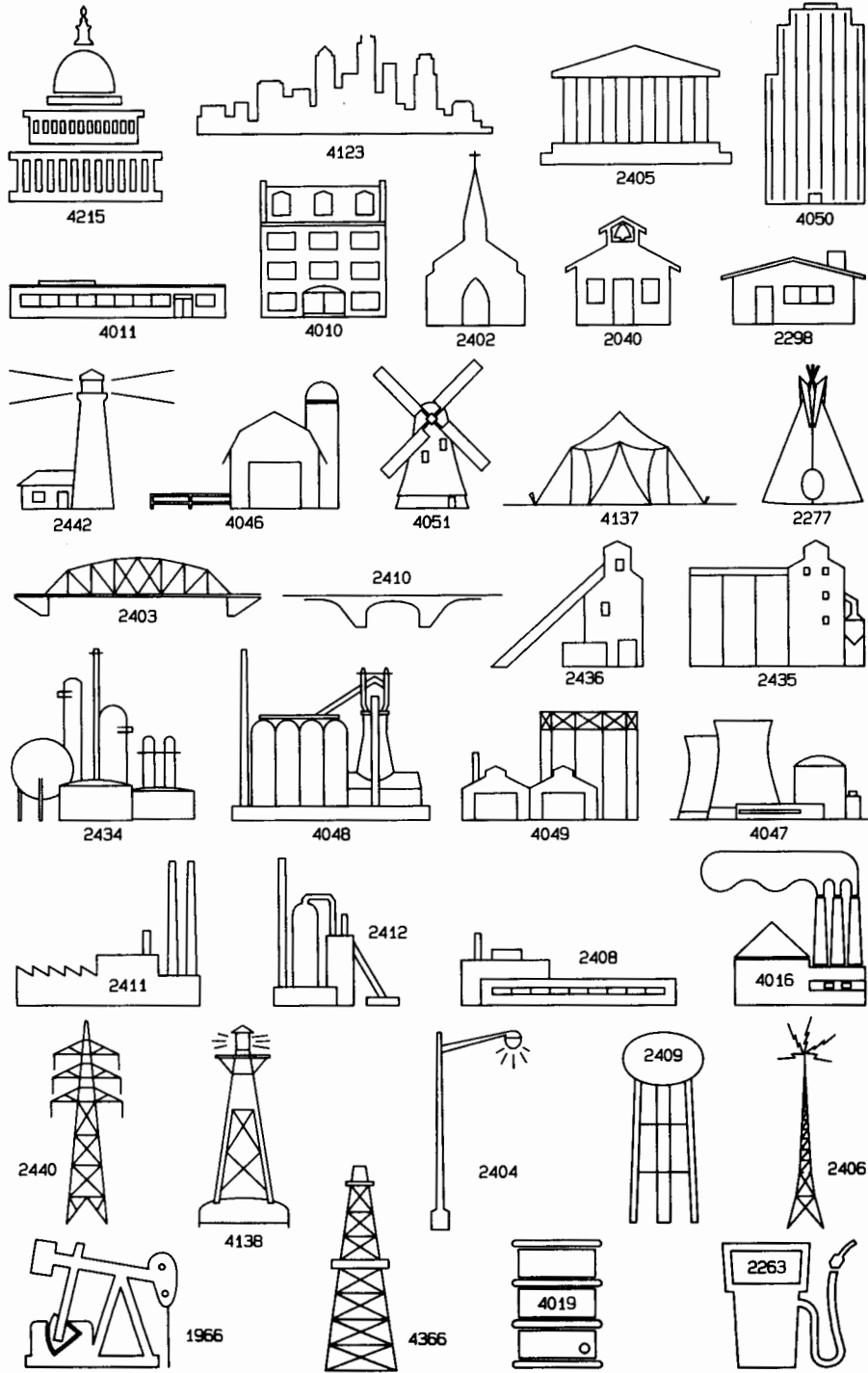

# Icons

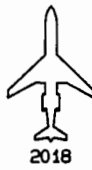
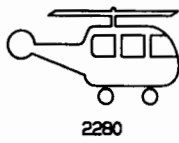
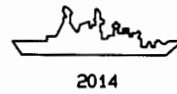
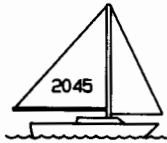
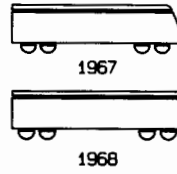
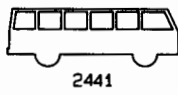
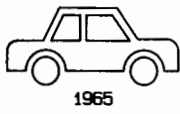
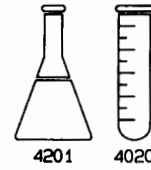
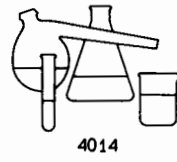
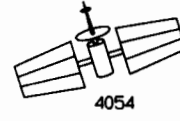
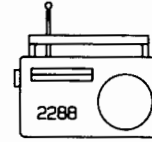
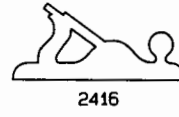
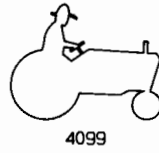
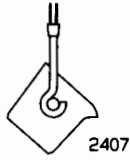
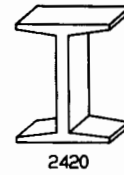
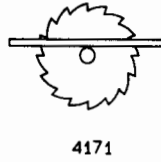
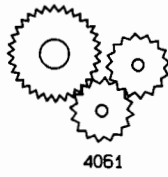

# Icons

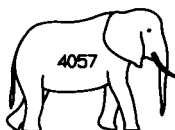
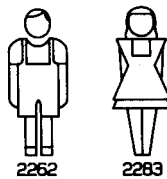
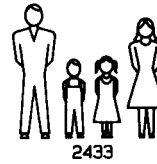
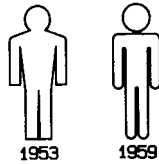
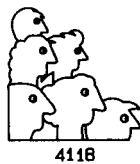
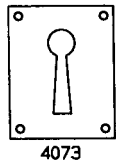
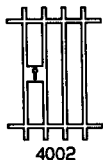
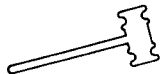
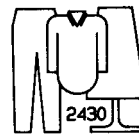
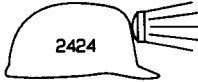

# Icons

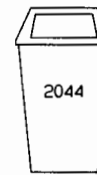
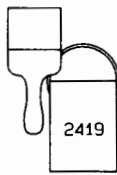
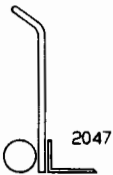
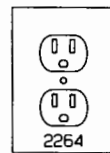
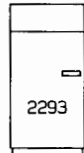
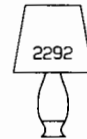
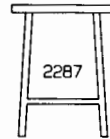
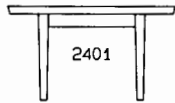
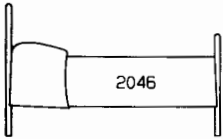
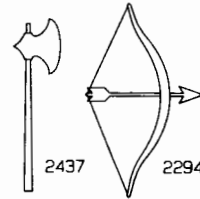
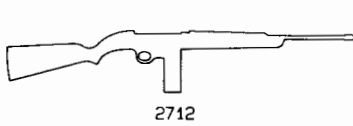
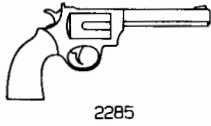
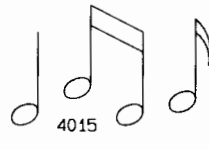
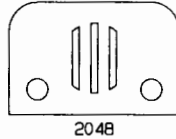
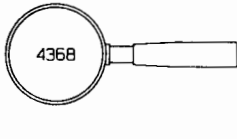
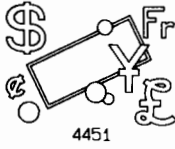
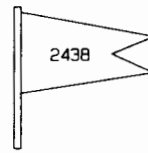
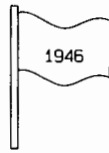
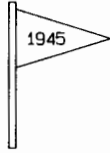
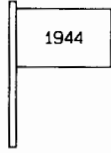
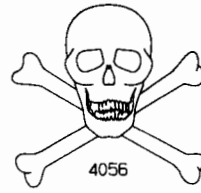
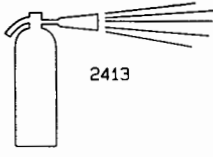
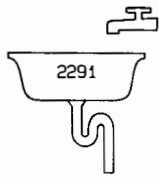

# Icons

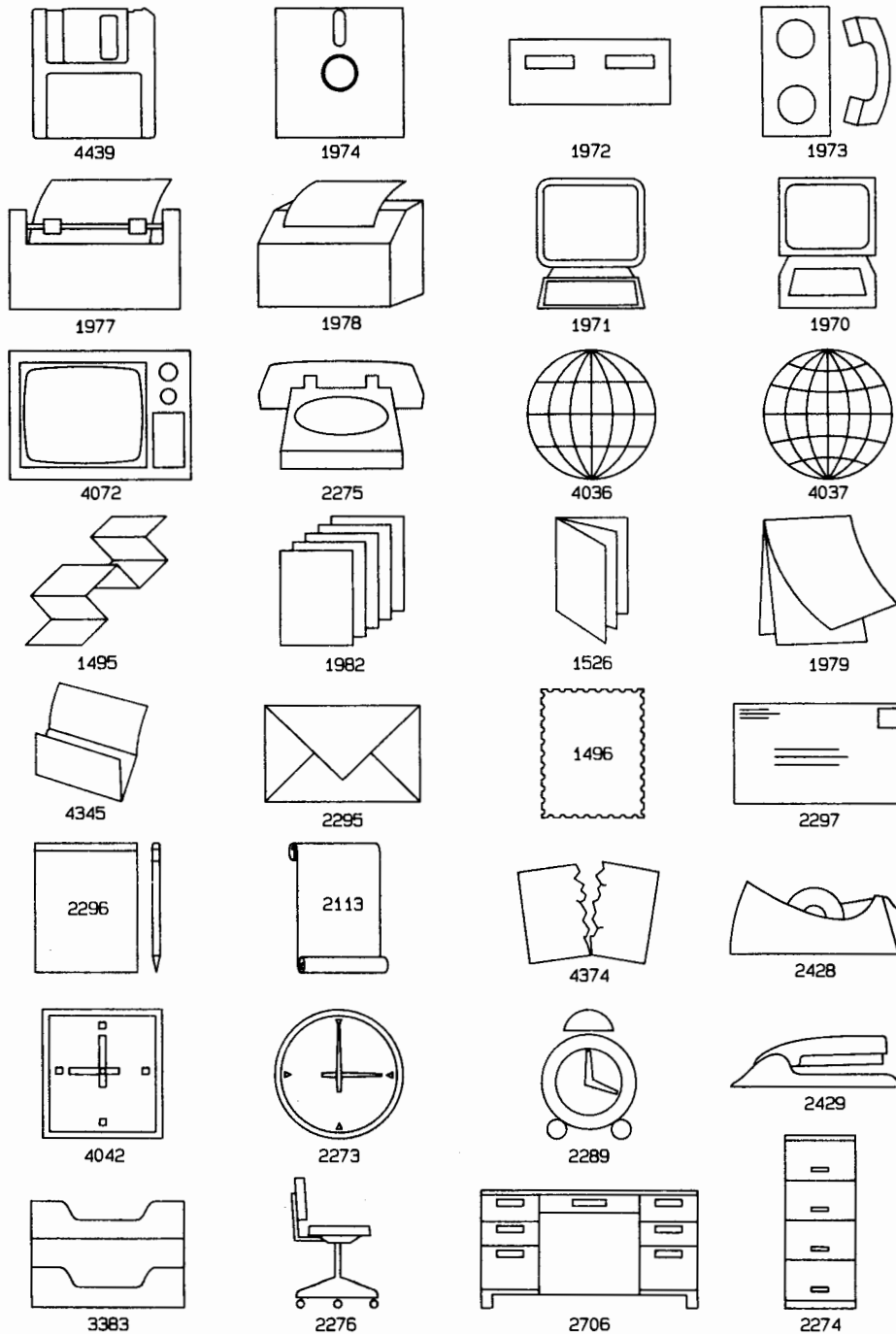



# More Icons 1

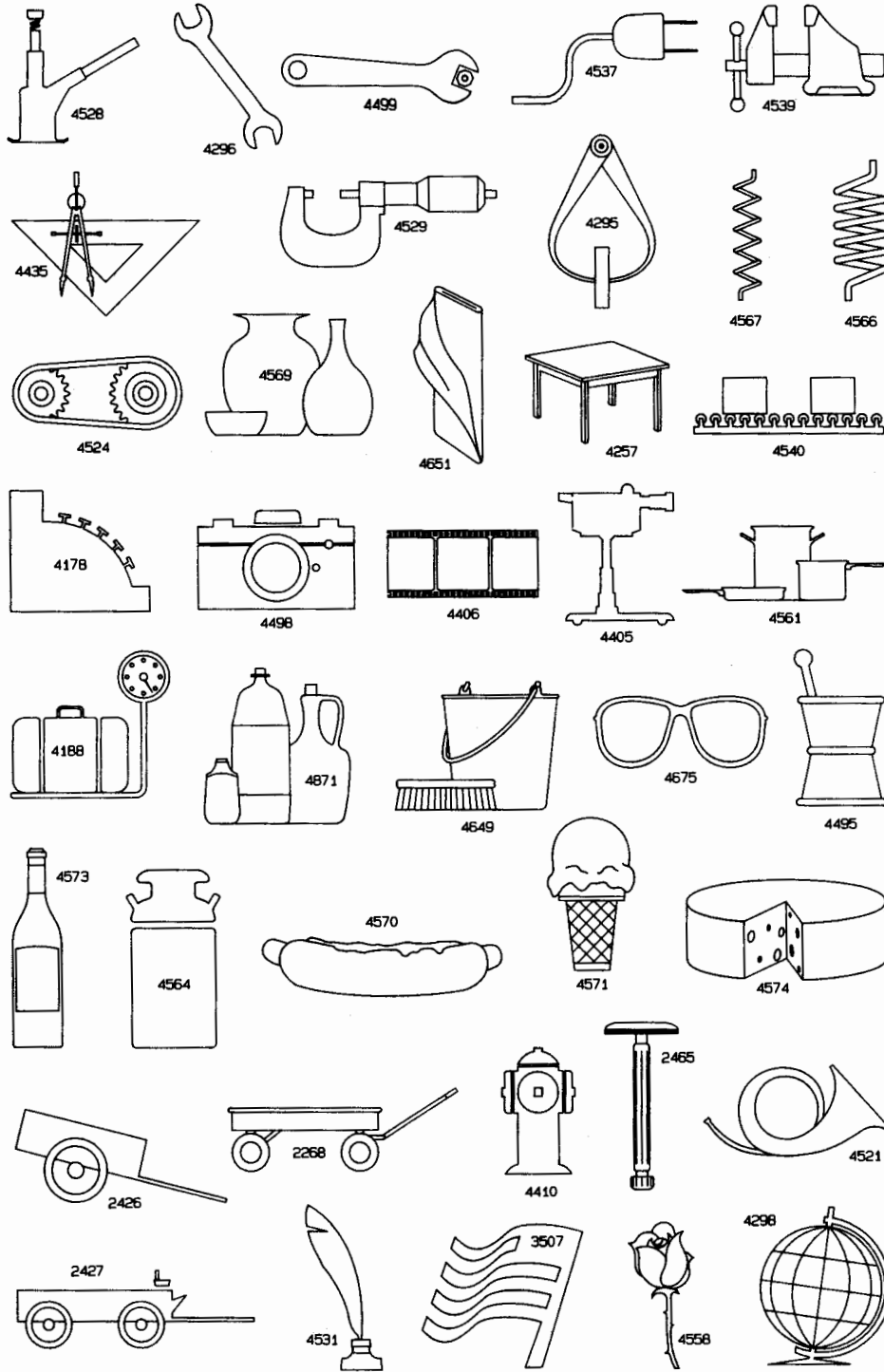

# More Icons 1

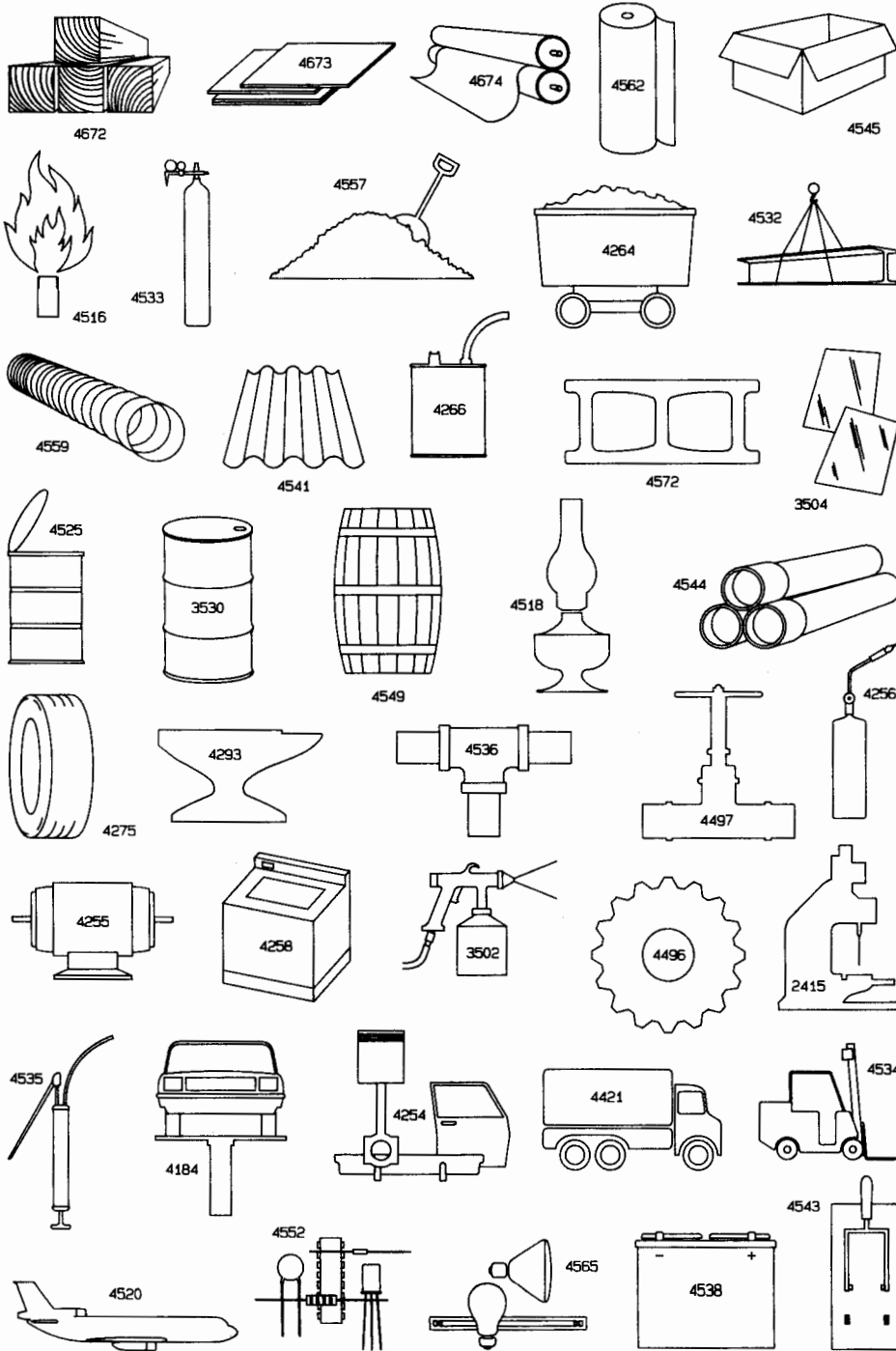

## More Icons 2

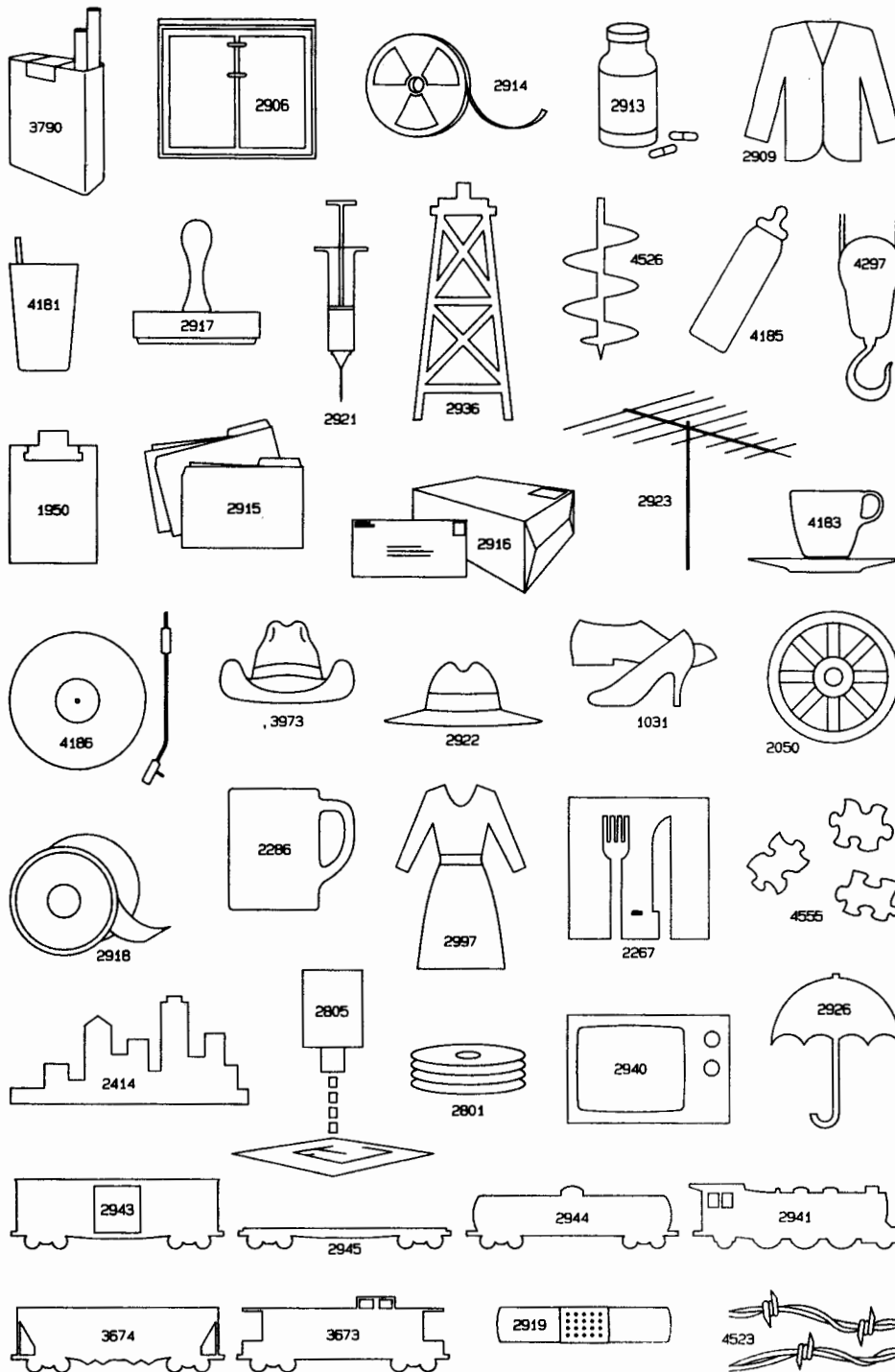

## More Icons 2

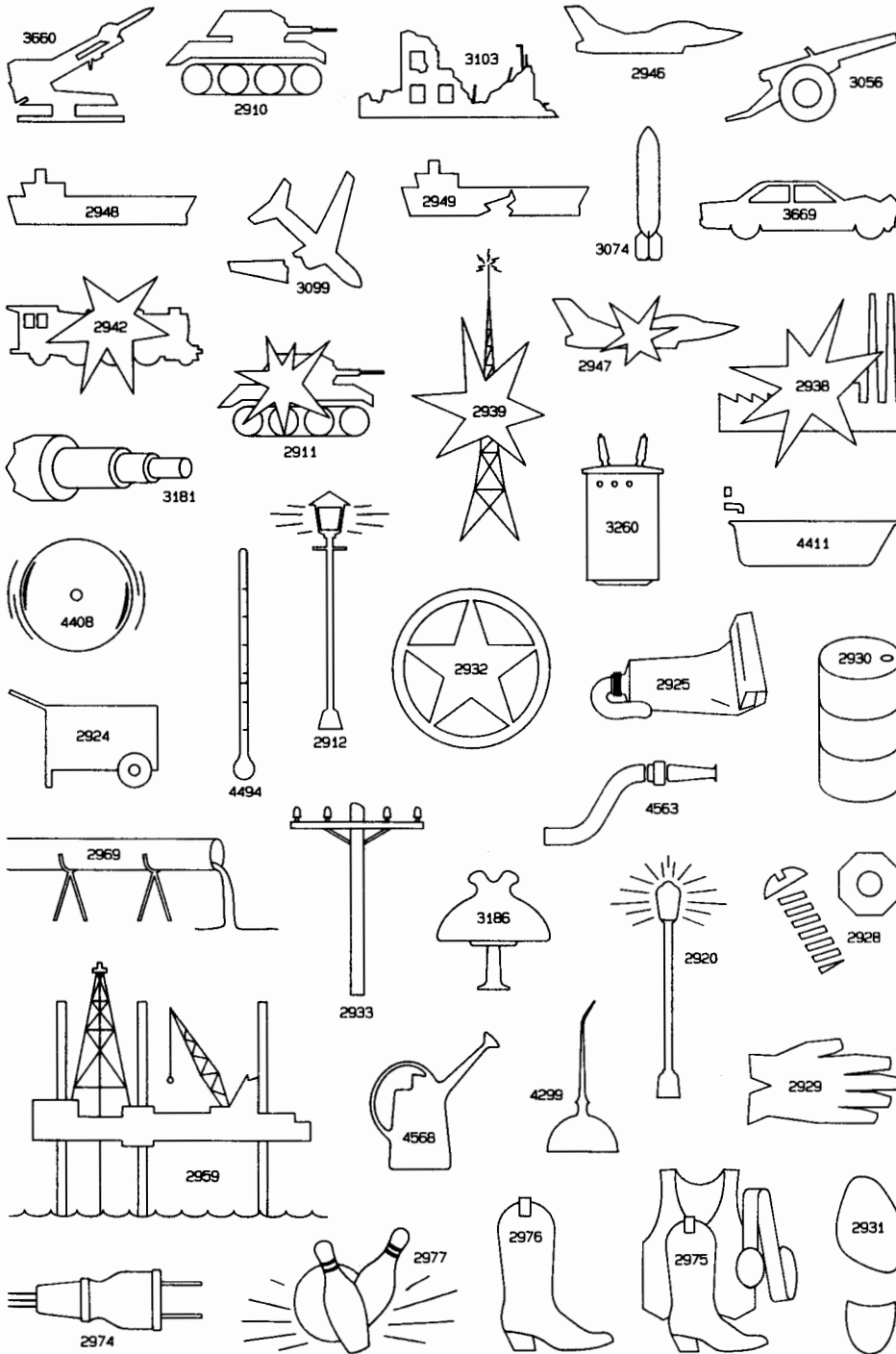

# More Icons 3

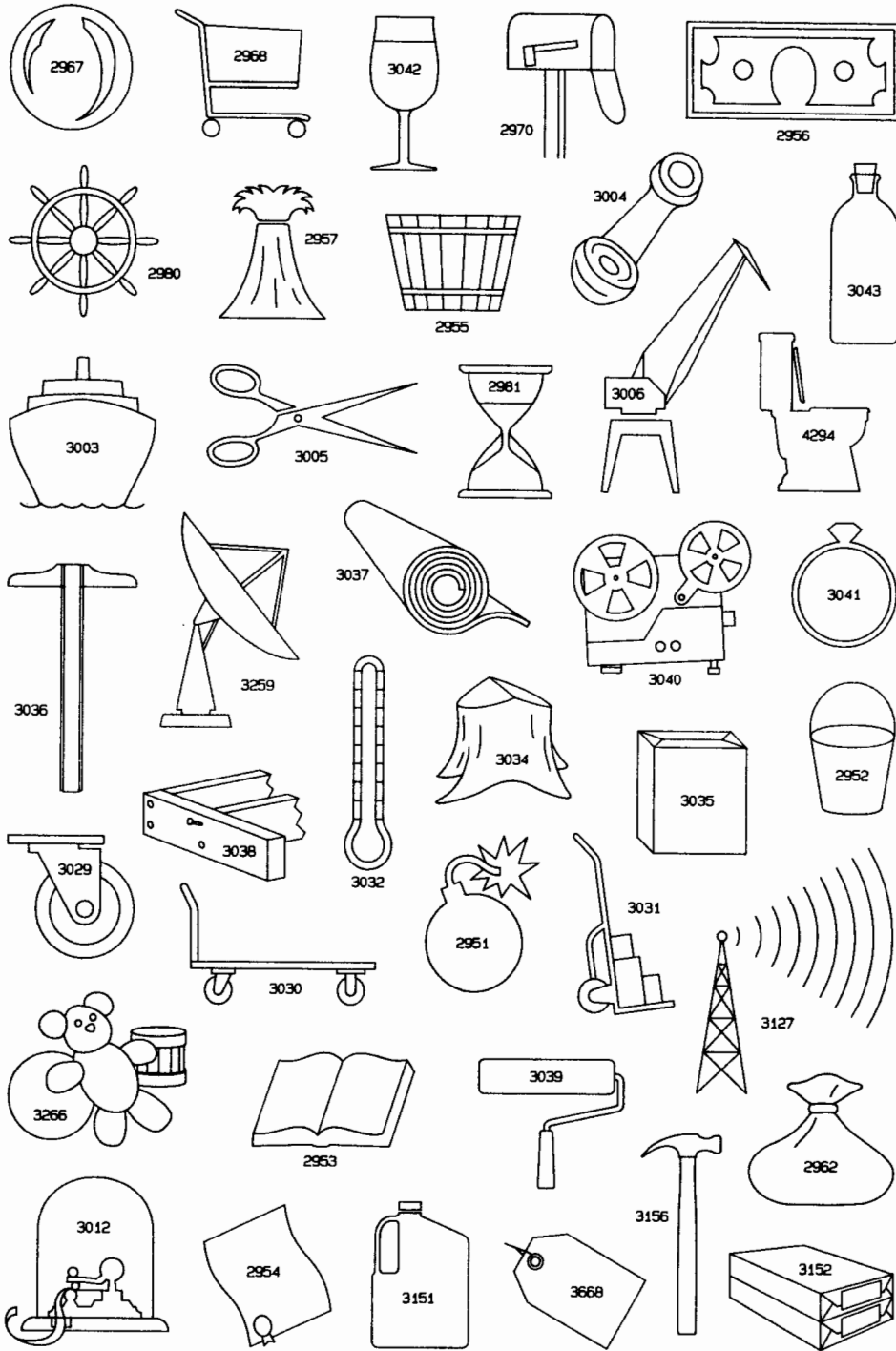

# More Icons 3

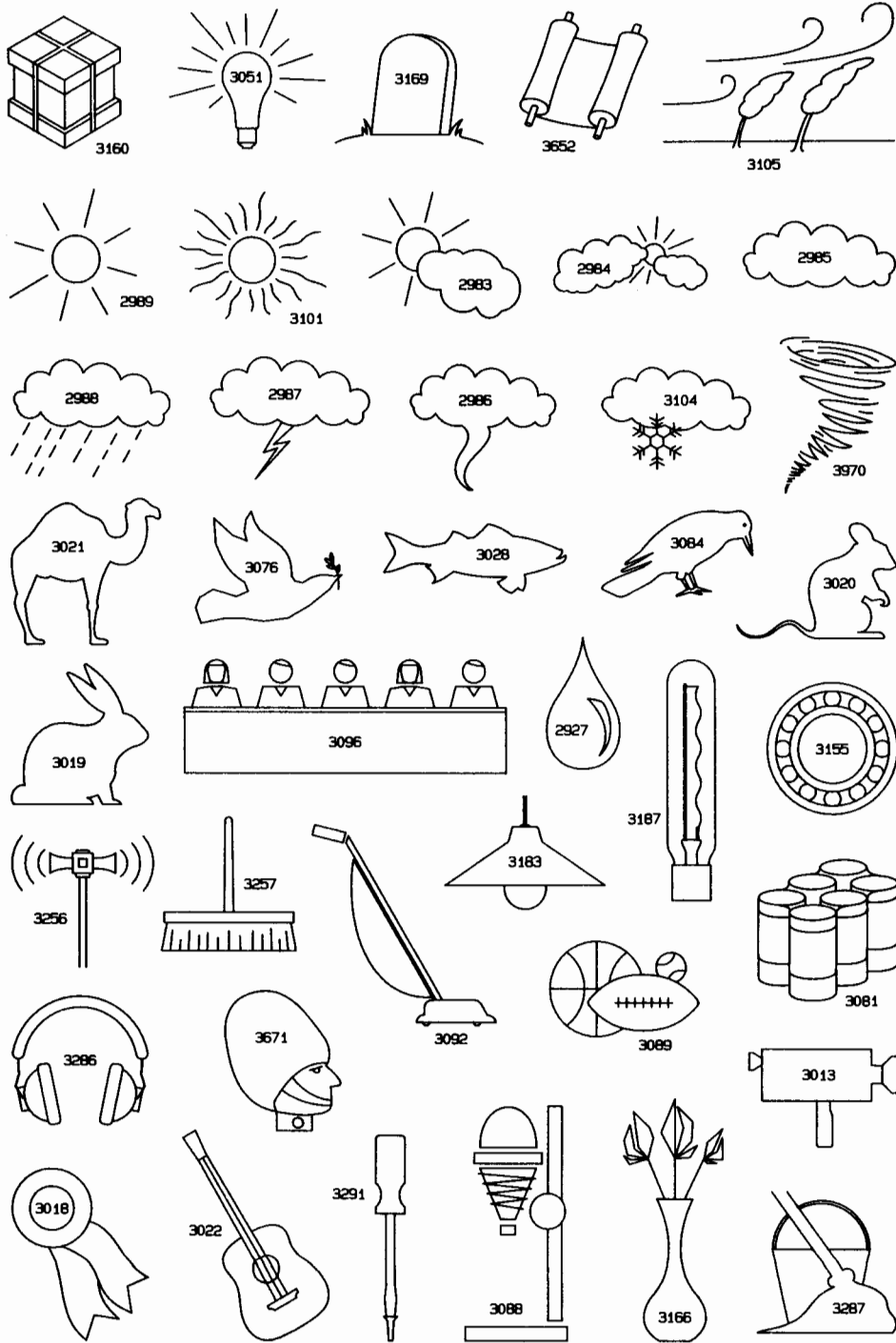

# More Icons 4



# More Icons 4

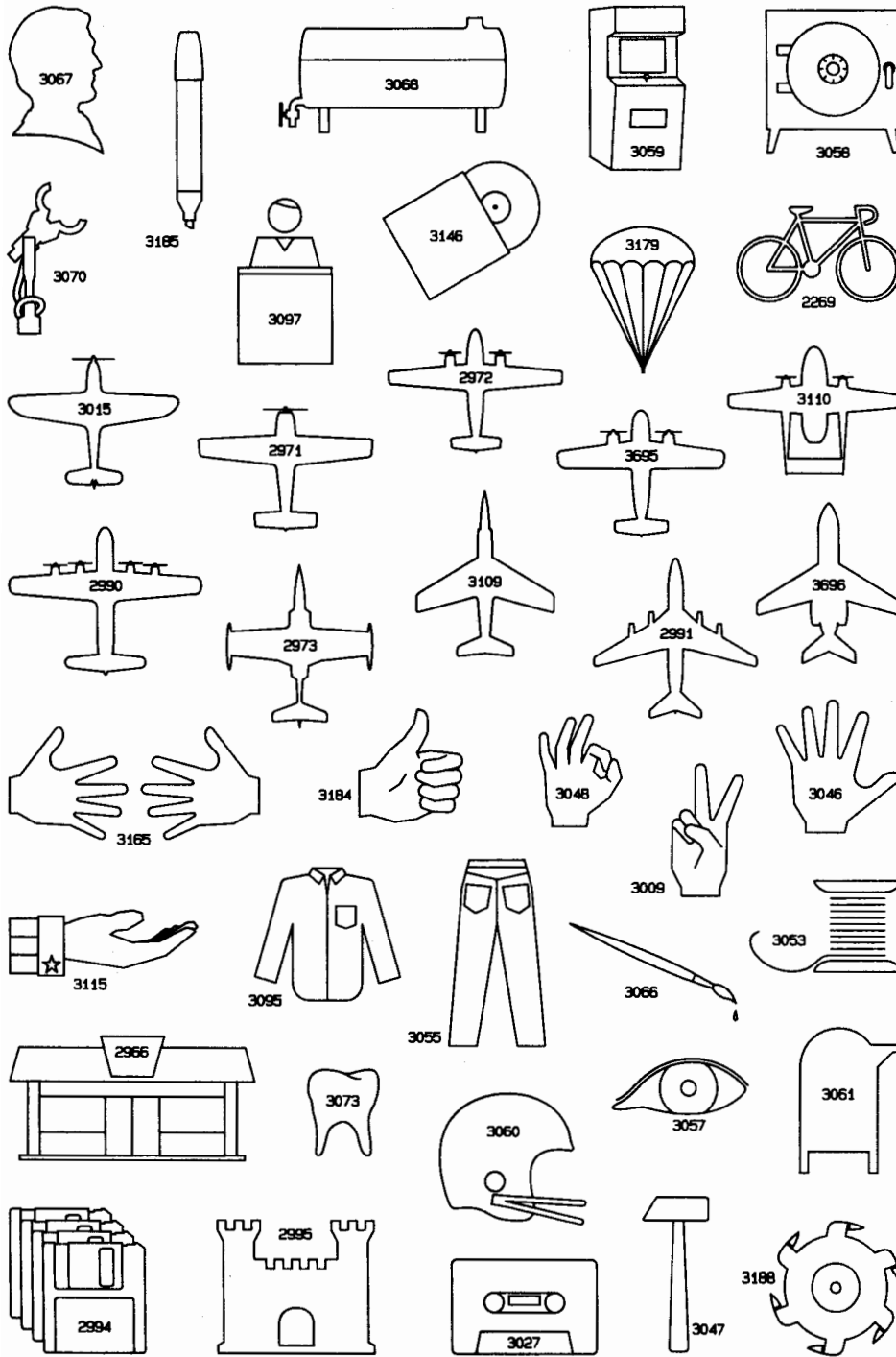



# More Icons 5

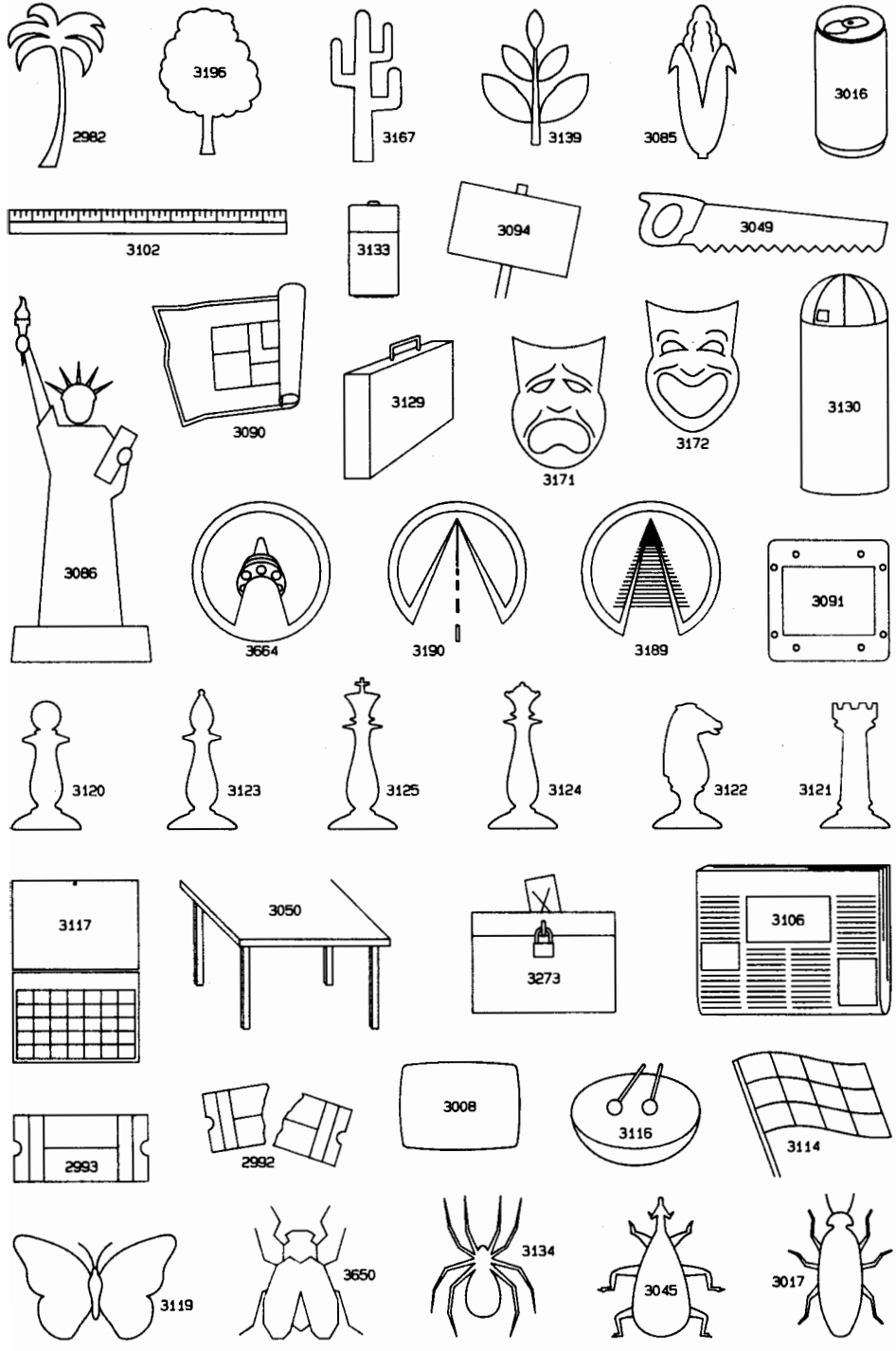

# More Icons 5

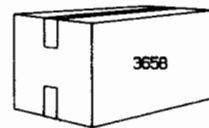
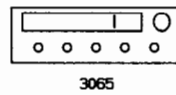
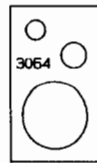
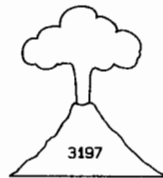
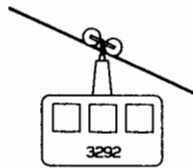
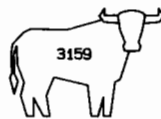
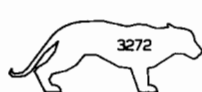
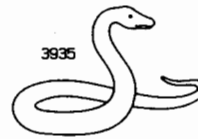
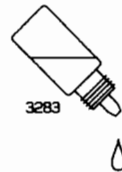
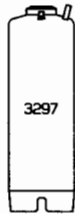
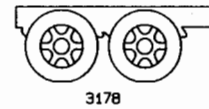
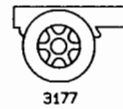
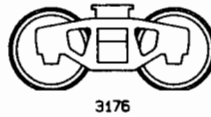
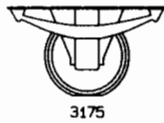
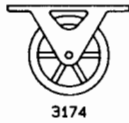
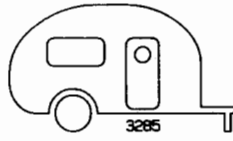
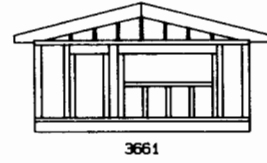
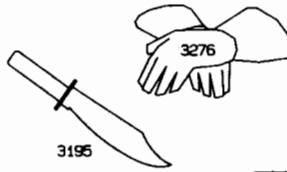
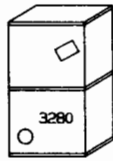

# More Icons 6

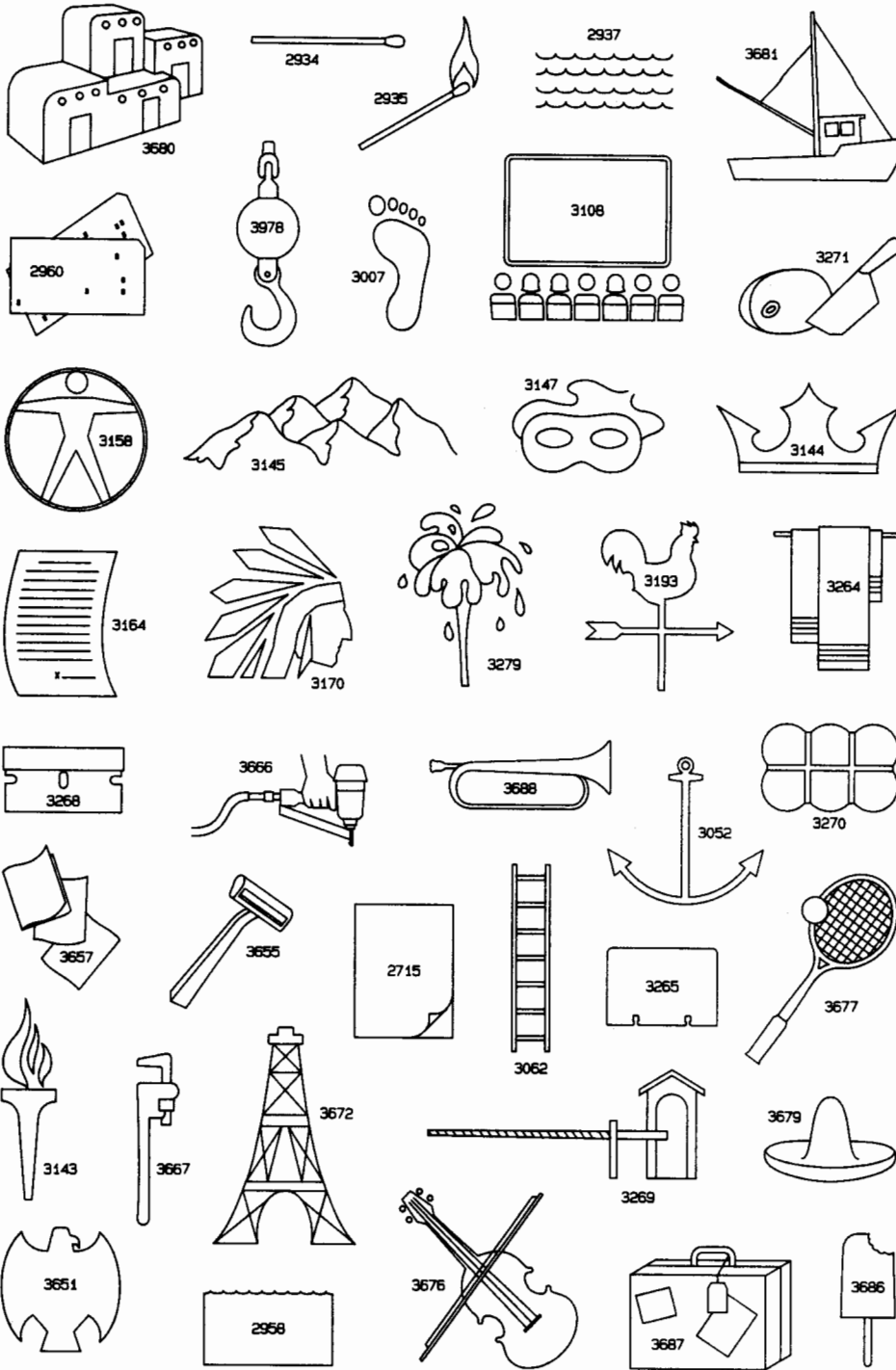

# More Icons 6

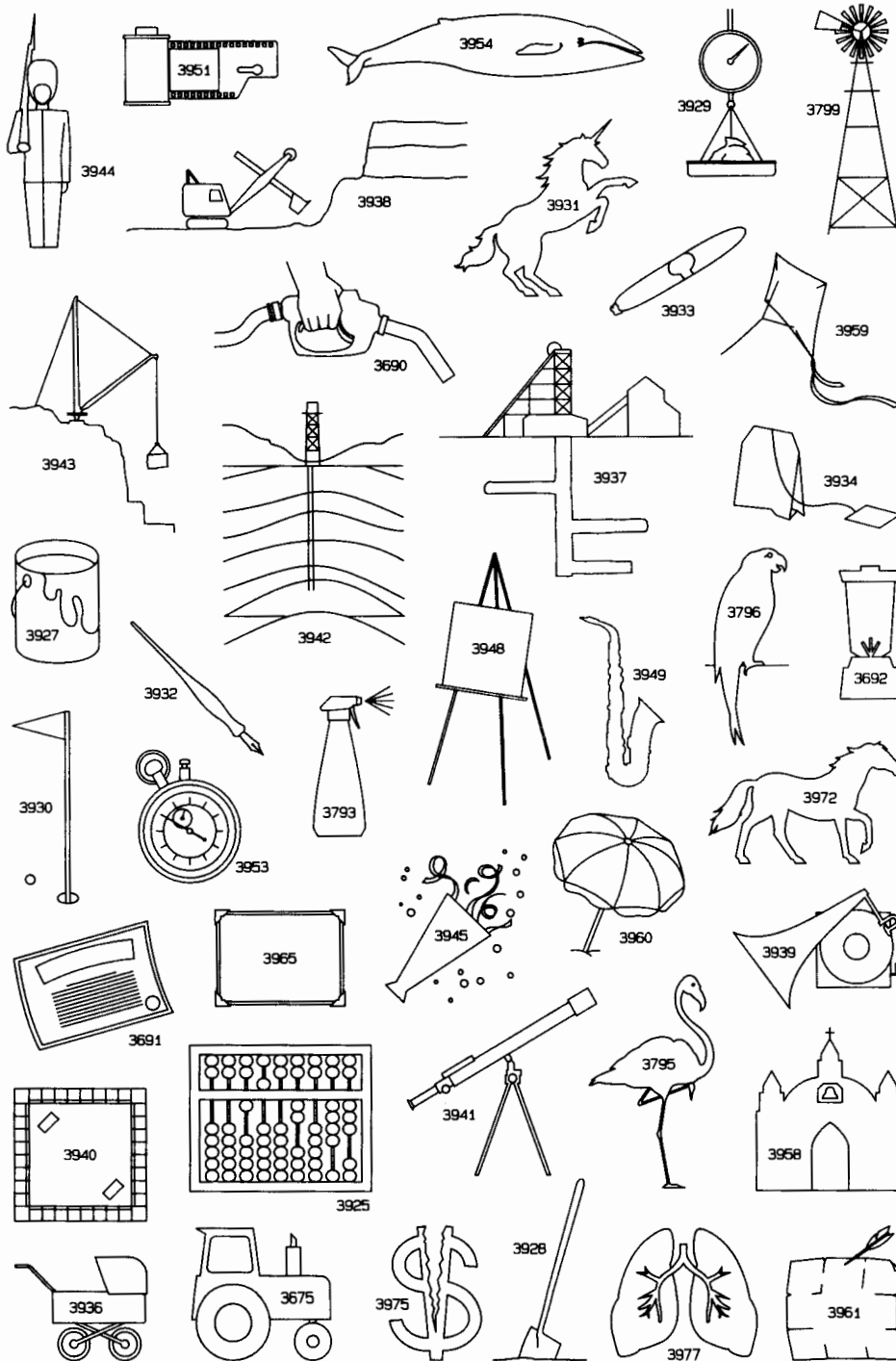



# 4 Pictorials



## Symbol Index

Description	Number	Lib.	Page	Description	Number	Lib.	Page
Airplanes				Clipboard (Movie)	4441P		4-3
Biplane w/Banner	4330P		4-4	Clipboard	4440P		4-5
Commercial Jet	4106P		4-4	Clouds			
Fighter, 3/4 View	4153P		4-4	Cumulus	4140P		4-6
Fighter, Side View	4418P		4-4	Funnel (Tornado)	4143P		4-6
Anchor	4329P		4-1	Stratocumulus	4138P		4-6
Animals				Thunderhead	4141P		4-6
Ape (Baboon)	4450P		4-3	w/Lightning	4142P		4-6
Bear, Teddy	4235P		4-3	Compact Car	4387P		4-4
Butterfly	4211P		4-3	Composition Aids			4-6
Caterpillar	4117P		4-3	Crane, Tower	4367P		4-4
Chick in Egg	4320P		4-3	Crucible	4224P		4-5
Dragon	4116P		4-3	Crystal Ball	4394P		4-2
Dragon/Serpent	4369P		4-3	and Hat	4217P		4-2
Fish	4111P		4-5	Cubes			
Pig	4328P		4-3	Four Jumbled	4045P		4-1
Snail	4442P		4-3	Tumbling	4360P		4-1
Ape (Baboon)	4450P		4-3	w/Arrow	4012P		4-1
Automobiles				Cutlass	4340P		4-2
2-Door	4122P		4-4	Cylinder, Graduated	4229P		4-5
4-Door	4342P		4-4	Daggers	4359P		4-2
Compact	4387P		4-4	Dead-End Overpass	4431P		4-4
Sports Car	4388P		4-4	Desert/Mesas (Horizon)	3344P		4-6
Baboon	4450P		4-3	Desks, Five-Drawer	4427P		4-5
Balloon, Hot Air	4347P		4-4	Diagraph Logo	9002P		4-1
Bars, Gold	4043P		4-1	Diamond (Jewel)	4069P		4-1
Beaker	4385P		4-5	Dish Antenna	4433P		4-4
Bear, Teddy	4235P		4-3	Dollar Signs			
Bell, Ring, The				3-D, 3/4 View	4119P		4-1
Front View	4333P		4-1	3-D, End View	4381P		4-1
Top View	4335P		4-1	3-D, Front View	4115P		4-1
Biplane w/Banner	4330P		4-4	Door			
Book	4357P		4-5	Open, w/View	4341P		4-8
Box, Open	4038P		4-1	to Cellar	4158P		4-8
Boxes				Dragon	4116P		4-3
w/Arrow	4012P		4-1	Dragon/Serpent	4369P		4-3
Four (Jumbled)	4045P		4-1	Egg w/Baby Chick	4320P		4-3
Tumbling	4360P		4-1	Erlenmeyer Flask	4230P		4-5
Boxing Gloves	4365P		4-1	Explosion	1723P		4-2
Bridge w/Islands	4376P		4-8	Explosion			
Broadsword	4346P		4-2	Fragments	4127P		4-2
Broken Glass				Hole	4128P		4-2
Hole	4128P		4-2	Faces			
Pieces	4127P		4-2	Profile	4384P		4-3
Buildings				Profile w/Globe	4370P		4-3
City Skyline (Horizon)	3347P		4-7	Smiling Man	4146P		4-3
Light Industry (Horizon)	3345P		4-7	Woman	4402P		4-3
Refinery Skyline (Horizon)	4078P		4-7	Farm Scene	4080P		4-7
Suburbia (Horizon)	4079P		4-7	Faucet	4383P		4-2
Bunsen Burner	4225P		4-5	File Cabinet	4423P		4-5
Bus	4301P		4-4	Open	4352P		4-5
Butterfly	4211P		4-3	Fish	4111P		4-5
Cacti	3355P		4-7	Flag	4397P		4-2
Cactus	3354P		4-7	Flashlight w/Spot	2708P		4-2
Cactus, Prickly	3351P		4-7	Flask			
Candle	4424P		4-2	Erlenmeyer	4230P		4-5
Candle w/Holder	4144P		4-2	Florence	4221P		4-5
Carton (Open)	4038P		4-1	Volumetric	4231P		4-5
Caterpillar	4117P		4-3	Flasks			
Chair				Foil (Fencing)	4336P		4-2
Secretary's	4437P		4-5	Foothills	3346P		4-6
Swivel	4422P		4-5	Funnel	4227P		4-5
Champagne Glass	4343P		4-5	Funnel Cloud (Tornado)	4143P		4-6
Channel-Lock Pliers	4322P		4-2	Gas Generating Jar	4234P		4-5
Check Mark				Glass, Martini	4343P		4-5
in 3rd Box	2041P		4-1	Globe			
in Grid	4353P		4-1	w/Head	4370P		4-3
in Square	4379P		4-1	w/Skyline	4364P		4-5
Chick in Egg	4320P		4-3	Gloves, Boxing	4365P		4-1
City Skyline				Gold Bars	4043P		4-1
Horizon	3347P		4-7	Golf Ball (on Tee)	4363P		4-1
w/Globe	4364P		4-5	Graduated Cylinder	4229P		4-5

*Pictorials, continued*

Description	Number	Lib.	Page	Description	Number	Lib.	Page
Gramophone	4428		4-1	Palm Tree	3366P		4-7
Grids (Composition Aids)			4-8	Pencil	4039P		4-5
Half Moon	4170P		4-7	Pennant	4398P		4-2
Hand				People			
Pointing Palm Down	4132P		4-3	Man Pulling Rope	4145P		4-3
Pointing Palm Out	4131P		4-3	Man Running	4446P		4-3
Hands, Shaking	4130P		4-3	Man Smiling	4146P		4-3
Harbor Scene	4455P		4-7	Man w/Magnifying Glass	4165P		4-3
Hat, Uncle Sam's	4332P		4-2	Strong Man	4204P		4-3
Head				Weightlifter	4204P		4-3
Profile w/Globe	4370P		4-3	Woman	4402P		4-3
Profile	4384P		4-3	Phone	4444P		4-5
Smiling Man	4146P		4-3	Phonograph	4428P		4-1
Woman	4402P		4-3	Pictorials			
Heavy Industry	4077P		4-7	Pig	4328P		4-3
Highway	3343P		4-8	Pliers, Channel Lock	4322P		4-2
Highway Overpass, Unfinished	4431P		4-4	Prairie	4152P		4-6
Hills	4153P		4-6	Pressure Valve	4105P		4-2
Hills/Mountains (Horizon)	3346P		4-6	Profile			
Hilly Road	4236P		4-8	w/Globe	4370P		4-3
Hole, Broken Glass	4128P		4-2	Human Head	4384P		4-3
Hot Air Balloon	4347P		4-4	Pyramids	4375P		4-6
Humpty Dumpty	4311P		4-3	Railroad Tracks	4339P		4-8
Ingots	4043P		4-1	Rainbow w/Pot of Gold	2702P		4-1
Jar, Gas Generating	4234P		4-5	Record Player	4428P		4-1
Jewel (Diamond)	4069P		4-1	Refinery (Horizon)	4078P		4-7
Key				Retort	4390P		4-5
Common	4407P		4-2	Ribbon (1st Place)	4371P		4-1
Old-Fashioned	4210P		4-2	Ring-The-Bell			
Skeleton	4361P		4-2	Front View	4333P		4-1
Keys On Ring	4314P		4-2	Top View	4335P		4-1
Landscapes			4-6	Road			
Leaf				Intersections			4-8
Maple	4041P		4-1	Roller	4110P		4-4
Oak	4356P		4-1	w/Hills	4154P		4-8
Light Bulb	4425P		4-2	w/Hills	4236P		4-8
Lightning Storm	4142P		4-6	w/Signs	4302P		4-8
Lock (Padlock)	4109P		4-2	Curved	4459P		4-8
Magnifying Glass	4351P		4-2	Mountainside	4081P		4-8
Man				Straight	3343P		4-8
Pulling Rope	4145P		4-3	Rocky Slopes	4151P		4-6
Running	4446P		4-3	Ruler	4024P		4-5
Smiling	4146P		4-3	Running Figure	4446P		4-3
Weightlifter	4204P		4-3	Rural Scene	4080P		4-7
w/Magnifying Glass	4165P		4-3	Safe (Vault)	4213P		4-5
Map				Satellite Dish Antenna	4433P		4-4
State Lines for USA	4395P		4-5	Scissors			
Time Zones for USA	4126P		4-5	Closed	4321P		4-2
USA 3-D	4350P		4-5	Open	4382P		4-2
USA Outline	4103P		4-5	Shaking Hands	4130P		4-3
USA w/States	4349P		4-5	Ship	4355P		4-4
Maple Leaf	4041P		4-1	Shipyard (Horizon)	4455P		4-7
Martini Glass	4343P		4-5	Short Sword	4359P		4-2
Maze	4445P		4-1	Shrubs			4-7
Moon	4170P		4-7	Signpost			
Mountain				3 Arrows	4412P		4-8
Curve	4081P		4-8	4 Arrows	4432P		4-8
Peaks	4155P		4-6	Signs			
Scene	3348P		4-6	Many/Confusing	4310P		4-4
Mountains/Hills (Horizon)	3346P		4-6	on Roadside	4302P		4-8
Number One, 3-D	4228P		4-1	Skeleton Key	4361		4-2
Oak Leaf	4356P		4-1	Snail	4442P		4-3
Oil				Sow (Pig)	4328P		4-3
Can (Pour)	4358P		4-5	Spark Plug	4354P		4-2
Can (Squirt)	4338P		4-5	Sports Car	4388P		4-4
Refinery	4078P		4-7	Spyglass	4377P		4-2
Rig	4372P		4-4	Stairs (Perspective)	4429P		4-8
One, 3-D	4228P		4-1	Stars (Night Sky)	3360P		4-6
Open Box	4038P		4-1	State Lines (for USA Map)	4395P		4-5
Overpass, Unfinished	4431P		4-4	States (USA Map)	4349P		4-5
Padlock	4109P		4-2	Steamroller	4110P		4-4
Palette	4389P		4-1	Strong Man	4204P		4-3

## Pictorials, continued

Description	Number	Lib.	Page
Suburbs (Horizon)	4079P		4-7
Sun	3353P		4-7
Sword			
Broadsword	4346P		4-2
Cutlass	4340P		4-2
Foil	4336P		4-2
Short	4359P		4-2
Tag (Package)	4114P		4-5
Teddy Bear	4235P		4-3
Telephone	4444P		4-5
Telephone Poles			4-8
Telescope	4377P		4-2
Test Tube	4121P		4-5
Tight Rope w/Humpty Dumpty	4311P		4-3
Time Zones (for USA Map)	4126P		4-5
Tools			
Flashlight w/Spot	2708P		4-2
Pliers, Channel Lock	4322P		4-2
Ruler	4024P		4-5
Top Hat (Uncle Sam's)	4332P		4-2
Tornado	4143P		4-6
Tower Crane	4367P		4-4
Tracks, Railroad	4339P		4-8
Trees			4-7
Tripod	4393P		4-5
Truck, 18-Wheeler	4108P		4-4
Tumbling Boxes	4360P		4-1
USA Map			
3-D	4350P		4-5
Outline	4103P		4-5
State Lines	4395P		4-5
States	4349P		4-5
Time Zones	4126P		4-5
Umbrella	4203P		4-2
Vault Safe	4213P		4-5
Vial	4121P		4-5
Volumetric Flask	4231P		4-5
Water/Ocean	3365P		4-6
Wizard's Hat w/Crystal Ball	4217P		4-2
Woman (Face)	4402P		4-3
X-Mark on Grid	4223P		4-1



## Optional Library #2, Holidays & Seasons

Description	Number	Lib.	Page	Description	Number	Lib.	Page
Abraham Lincoln	4831P	2	4-11	Ghost, Flying	4764P	2	4-12
April Flower	4762P	2	4-9	Graveyard	4769P	2	4-13
Arm and Hammer	4810P	2	4-12	Grim Reaper	4773P	2	4-13
Autumn				Ground Hog	4812P	2	4-9
Crop Harvest	4813P	2	4-10	Halloween Bats w/Moon Composite			
Education Owl	4757P	2	4-10	Outline and Bats Shading	4765P	2	4-12
Football	4801P	2	4-10	Moon Shading	4921A	2	4-12
Migrating Geese	4809P	2	4-10	Halloween Bat Corner	4834P	2	4-13
Raking Leaves	4795P	2	4-10	Halloween Cat	4768P	2	4-13
Autumn Tree Composite				w/Shading	4868P	2	4-13
Tree	4828P	2	4-10	Halloween Owl	4777P	2	4-13
Falling Leaves	4829P	2	4-10	Halloween Skull Corner	4835P	2	4-13
Cabin, Log	4824P	2	4-11	Holly Border Composite			
Candy Cane	4770P	2	4-14	Berries	4838P	2	4-14
Candy Cane	4953P	2	4-14	Corner Leaves	4839P	2	4-14
Chimney and Smoke Composite				Side Leaves	4840P	2	4-14
Outline and Smoke Shading	4901P	2	4-15	Side Leaves	4841P	2	4-14
Brick Shading	4902A	2	4-15	Holly Leaves and Berries Composite			
Christmas Bell Border Composite				Outline	4955P	2	4-14
Outline	4814P	2	4-15	Berries Shading	4781A	2	4-14
Holly Leaves Shading	4893A	2	4-15	Leaves Shading	4782A	2	4-14
Bells Shading	4894A	2	4-15	Holly Leaves and Berries Composite			
Christmas Candle Border Composite				Outline	4956P	2	4-15
Outline and Berry Shading	4821P	2	4-15	Leaves Shading	4903A	2	4-15
Holly Leaves Shading	4895A	2	4-15	Berries Shading	4904A	2	4-15
Candles Shading	4896A	2	4-15	Jack O'Lantern	4767P	2	4-12
Christmas Ornament	4771P	2	4-14	Jack O'Lantern Composite			
Christmas Presents	4788P	2	4-14	Outline and Face Shading	4864P	2	4-12
Christmas Stocking	4784P	2	4-15	Pumpkin Shading	4766A	2	4-12
Christmas Tree	4780P	2	4-14	Stem Shading	4865A	2	4-12
Christmas Tree, 5-Part Composite				Leaves, Man Raking	4795P	2	4-10
Christmas Tree	4842P	2	4-15	Leprechaun	4804P	2	4-11
Trunk	4832P	2	4-15	Liberty Bell	4822P	2	4-12
Ornaments 1	4833P	2	4-15	Lightning	4815P	2	4-9
Ornaments 2	4853P	2	4-15	Log Cabin	4824P	2	4-11
Ornaments 3	4854P	2	4-15	Martin Luther King, Jr.	4928P	2	4-11
Christmas Tree, 8-Part Composite				Memorial Day	4714P	2	4-12
Christmas Tree w/Stand	4855P	2	4-14	Menorah	4790P	2	4-15
Trunk	4856P	2	4-14	"Merry Christmas" Composite			
Tinsel	4857P	2	4-14	"Merry" Outline	4796P	2	4-14
Star and Ornaments 1	4858P	2	4-14	"Christmas" Outline	4797P	2	4-14
Ornaments 2	4859P	2	4-14	"Me" Shading	4889A	2	4-14
Ornaments 3	4860P	2	4-14	"rry" Shading	4890A	2	4-14
Ornaments 4	4861P	2	4-14	"Chris" Shading	4891A	2	4-14
Ornaments 5	4862P	2	4-14	"tmas" Shading	4892A	2	4-14
Cornucopia	4805P	2	4-13	Migrating Geese	4809P	2	4-10
Cottage w/Snow	4811P	2	4-10	Moon	4708P	2	4-11
Crop Harvest	4813P	2	4-10	Nativity Scene	4785P	2	4-14
Cupid	4720P	2	4-11	New Year's Reveller	4806P	2	4-15
Easter Bunny	4709P	2	4-11	New Year's Toast	4819P	2	4-15
Easter Chick	4787P	2	4-11	North Wind and Leaves Composite			
Easter Duckling	4710P	2	4-11	North Wind	4779P	2	4-10
Easter Eggs Composite				Leaves	4863P	2	4-10
Outline	4942P	2	4-11	Pilgrim Hat	4820P	2	4-13
Decoration 1 Shading	4943A	2	4-11	Poolside Accessories	4794P	2	4-9
Decoration 2 Shading	4944A	2	4-11	Raking Leaves	4795P	2	4-10
Decoration 3 Shading	4945A	2	4-11	Reindeer	4845P	2	4-15
Education Owl	4757P	2	4-10	Reindeer	4847P	2	4-15
Fife and Drum Corps Composite				Santa Claus	4783P	2	4-14
Boy Playing Drum	4721P	2	4-12	and Sleigh	4844P	2	4-15
Man Holding Flag	4722P	2	4-12	"Season's Greetings" Composite			
Man Playing Flute	4723P	2	4-12	"Season's" Outline	4912P	2	4-15
Firecracker, Exploding	4717P	2	4-12	"Greetings" Outline	4913P	2	4-15
w/Fuse	4823P	2	4-12	"Se" Shading	4914A	2	4-15
Fireworks	4719P	2	4-12	"aso" Shading	4915A	2	4-15
Flag (13 Colonies)	4718P	2	4-12	"n's" Shading	4916A	2	4-15
Football	4801P	2	4-10	"Gr" Shading	4917A	2	4-15
Geese, Migrating	4809P	2	4-10	"eet" Shading	4918A	2	4-15
George Washington	4816P	2	4-11	"in" Shading	4919A	2	4-15
George Washington w/Cherry Tree Composite				"gs" Shading	4920A	2	4-15
Washington w/Ax	4802P	2	4-11	Shamrock	4715P	2	4-11
Cherry Tree	4803P	2	4-11	Skier, Inept	4786P	2	4-15

**Optional Library #2, Holidays & Seasons, continued**

Description	Number	Lib.	Page
Snowflake	4817P	2	4-10
Snowflake	4818P	2	4-10
Snowman	4774P	2	4-10
Spring			
Bird w/Worm	4744P	2	4-9
Flower	4762P	2	4-9
Gardening Tools	4756P	2	4-9
Mushroom	4716P	2	4-9
Nest	4758P	2	4-9
Tree	4825P	2	4-9
Spring Shower Composite			
Dark Cloud	4753P	2	4-9
Sun	4792P	2	4-9
Rain	4793P	2	4-9
Star, Smiling	4752P	2	4-12
Star of Bethlehem	4934P	2	4-9
Summer			
Dog	4755P	2	4-9
Poolside Accessories	4794P	2	4-9
Sailboats	4846P	2	4-9
Sun	4478P	2	4-9
Swimming Pool Cartoon	4789P	2	4-9
Summer Tree Composite			
Trunk	4826P	2	4-9
Canopy	4827P	2	4-9
Sun, Mean	4754P	2	4-9
Sun, Summer	4478P	2	4-9
Swimming Pool Cartoon	4789P	2	4-9
Thanksgiving Harvest Corner	4836P	2	4-13
Thanksgiving Indian	4807P	2	4-13
Thanksgiving Pilgrim	4808P	2	4-13
Thanksgiving Turkey Corner	4837P	2	4-13
Trudging through Snow	4772P	2	4-10
Turkey	4778P	2	4-13
Twinkle	4939P	2	4-14
Valentine Boy	4775P	2	4-11
Valentine Girl	4776P	2	4-11
Valentine Hearts w/Arrow	4712P	2	4-11
Vote!	4791P	2	4-13
Winter			
Cottage	4811P	2	4-10
Skier, Inept	4786P	2	4-15
Snowflake	4817P	2	4-10
Snowflake	4818P	2	4-10
Snowman	4774P	2	4-10
Tree	4830P	2	4-10
Trudging through Snow	4772P	2	4-10
Witch w/Moon			
Outline and Witch Shading	4866P	2	4-13
Moon Shading	4867A	2	4-13
Witch w/Moon (Detailed Features)			
Outline and Witch Shading	4763P	2	4-12
Moon Shading	4870A	2	4-12

## Optional Library #3, More Pictorials

Description	Number	Lib.	Page	Description	Number	Lib.	Page
<b>Animals</b>				<b>Time Flies</b>	4244P	3	4-17
Duckling (Swimming)	4471P	3	4-16	<b>Wait a Moment</b>	4246P	3	4-17
Fish Chasing Fish Chasing Fish	3517P	3	4-17	<b>Waiting in Line</b>	4474P	3	4-16
Mechanical Dog	4291P	3	4-16	<b>Washed Up (Man in Washing Machine)</b>	4477P	3	4-16
Penguin w/Suit	4464P	3	4-17	<b>Yelling Mouth</b>	4245P	3	4-17
Rooster	4469P	3	4-16				
Stork w/Hat	4470P	3	4-16				
<b>Astronomer</b>	4475P	3	4-17				
<b>Cowboy (Pointing at You)</b>	4124P	3	4-17				
<b>Crowd (Facing Away)</b>	3703P	3	4-16				
<b>Daydreamer</b>	4247P	3	4-17				
<b>Dog, Mechanical</b>	4291P	3	4-16				
<b>Duckling (Swimming)</b>	4471P	3	4-16				
<b>Fish Chasing Fish Chasing Fish</b>	3517P	3	4-17				
<b>Foot</b>							
in Mouth	4472P	3	4-17				
in the Door	4243P	3	4-17				
<b>Goodbye, Man Waving</b>	4476P	3	4-17				
<b>Hand Holding World</b>	4467P	3	4-16				
<b>Hand-to-Person Confrontation</b>	3516P	3	4-17				
<b>Hear No Evil, See No Evil etc.</b>	4466P	3	4-16				
<b>Indian Scout</b>	3701P	3	4-17				
<b>It's a Small World</b>	4467P	3	4-16				
<b>Line of People Waiting</b>	4474P	3	4-16				
<b>Man</b>							
Cracking Whip	3515P	3	4-17				
Daydreaming	4247P	3	4-17				
Looking Around Corner	3702P	3	4-16				
On Strike/Protesting	4473P	3	4-16				
Reading (Standing)	3708P	3	4-17				
Reading in Easy Chair	4468P	3	4-16				
Running	4246P	3	4-17				
Taking Charge	4463P	3	4-16				
Waving (Facing Away)	4476P	3	4-17				
in Washing Machine	4477P	3	4-16				
w/Foot in Mouth	4472P	3	4-17				
Chastising	4465P	3	4-16				
Indifferent/Unconcerned	4954P	3	4-16				
<b>Money Talks</b>	4848P	3	4-16				
<b>Mouth (Open Wide)</b>	4245P	3	4-17				
<b>Penguin w/Suit</b>	4464P	3	4-17				
<b>People</b>							
Astronomer	4475P	3	4-17				
Cowboy (Pointing at You)	4124P	3	4-17				
Crowd (Facing Away)	3703P	3	4-16				
Daydreamer	4247P	3	4-17				
Hand-to-Person Confrontation	3516P	3	4-17				
Hear No Evil, See No Evil etc.	4466P	3	4-16				
Indian Scout	3701P	3	4-17				
Line of People Waiting	4474P	3	4-16				
Man Cracking Whip	3515P	3	4-17				
Man Daydreaming	4247P	3	4-17				
Man Looking Around Corner	3702P	3	4-16				
Man On Strike/Protesting	4473P	3	4-16				
Man Reading (Standing)	3708P	3	4-17				
Man Reading in Easy Chair	4468P	3	4-16				
Man Running	4246P	3	4-17				
Man Taking Charge	4463P	3	4-16				
Man Waving (Facing Away)	4476P	3	4-17				
Man Waving Goodbye	4476P	3	4-17				
Man in Washing Machine	4477P	3	4-16				
Man w/Foot in Mouth	4472P	3	4-17				
Man, Chastising	4465P	3	4-16				
Man, Indifferent/Unconcerned	4954P	3	4-16				
Sergeant (Angry/Pointing)	4241P	3	4-17				
Soldier, Cowering	4242P	3	4-17				
Wait a Moment	4246P	3	4-17				
Waiting in Line	4474P	3	4-16				
<b>Rooster</b>	4469P	3	4-16				
<b>Sergeant (Angry/Pointing)</b>	4241P	3	4-17				
<b>Soldier, Cowering</b>	4242P	3	4-17				
<b>Stork w/Hat</b>	4470P	3	4-16				

## Optional Library #7, Space

Description	Number	Lib.	Page	Description	Number	Lib.	Page
Alien World				Redstone Rocket	4938P	7	4-19
City	3772P	7	4-22	Rockets/Capsules			
Fauna (6 Legs)	4966P	7	4-23	Apollo Capsule	4931P	7	4-19
Fauna (Flying)	4959P	7	4-23	Atlas Centaur	4850P	7	4-19
Fauna (Flying)	4961P	7	4-23	Mercury Capsule	4929P	7	4-19
Fauna (Intelligent Blob)	4977P	7	4-23	Redstone	4938P	7	4-19
Flora 1	4968P	7	4-23	Rocket	4974P	7	4-20
Flora 2	4969P	7	4-23	Rocket w/Flames	3749P	7	4-22
Flora 3	4970P	7	4-23	Rocket, 1-Stage	3764P	7	4-19
Flora 4	4971P	7	4-23	Rocket, 3-Stage	3759P	7	4-19
Humanoid, Friendly	3757P	7	4-23	Saturn 1B	4932P	7	4-18
Humanoid, Pointing	3756P	7	4-23	Saturn V	4849P	7	4-19
Planet w/Asteroid Belt	4874P	7	4-23	Saturn V w/Apollo Cap.	4946P	7	4-19
Settlement	3752P	7	4-21	Saturn V w/Skylab	4935P	7	4-20
Vehicle/Transporter	4975P	7	4-23	Rocks/Boulders	4985P	7	4-23
Apollo				Russian Space Shuttle	4958P	7	4-22
Capsule	4931P	7	4-19	w/Gear Down	4926P	7	4-22
Lunar Module	3546P	7	4-19	Satellites			
Asteroid	4982P	7	4-20	Communications	3779P	7	4-18
Asteroids	4973P	7	4-20	Communications w/Dishes	4880P	7	4-18
Astronaut				Cylindrical Body	3786P	7	4-19
Explorer 1	3767P	7	4-22	Generic/Futuristic	4909P	7	4-19
Explorer 2	3768P	7	4-22	IUE	4897P	7	4-19
Explorer 3	3769P	7	4-22	Landstat	4883P	7	4-19
w/Maneuvering Unit	4962P	7	4-18	Multimission	4980P	7	4-20
w/Maneuvering Unit (Front)	4878P	7	4-18	Open	4888P	7	4-19
w/Maneuvering Unit (Side)	3758P	7	4-18	Round Body	3754P	7	4-19
w/Umbilical Cord	4879P	7	4-18	Scientific	4881P	7	4-20
Atlas Centaur	4850P	7	4-19	Skylab	3587P	7	4-19
City, Futuristic	3772P	7	4-22	Space Telescope	4884P	7	4-19
Comet	4983P	7	4-20	Telstar	4887P	7	4-19
Dish Antenna/Tracking Station	4799P	7	4-19	Vela 6	4899P	7	4-19
Dish Antenna/Tracking Station	4965P	7	4-20	Weather	3781P	7	4-18
Earth	3773P	7	4-20	w/Panels	3761P	7	4-19
Explosion w/Fragments	4981P	7	4-23	Saturn	4908P	7	4-20
Galaxy	4907P	7	4-20	Saturn	4987P	7	4-21
Jupiter	4911P	7	4-20	Saturn Rocket			
w/Space Probe in Orbit	3751P	7	4-21	1B	4932P	7	4-18
Lunar				V	4849P	7	4-19
Module	3546P	7	4-19	V w/Apollo Capsule	4946P	7	4-19
Roving Vehicle	4933P	7	4-19	V w/Skylab	4935P	7	4-20
Mars	4906P	7	4-21	Skylab	3587P	7	4-19
w/Orbiting Spacecraft	4963P	7	4-21	Solar System	3782P	7	4-20
Mercury Capsule	4929P	7	4-19	Space City	3772P	7	4-22
Mercury Landscape	3763P	7	4-21	Space Shuttle			
Meteor	4967P	7	4-20	Bay Doors Open	3778P	7	4-18
Moon	4910P	7	4-20	In Flight (Front View)	3788P	7	4-18
Moon Rocks	4985P	7	4-23	In Flight (Front View)	3789P	7	4-18
Moons in Orbit	4989P	7	4-21	In Flight (Side View)	4882P	7	4-18
Neptune	4960P	7	4-21	In Flight (Side View)	4978P	7	4-18
Observatory	4922P	7	4-19	Landing (Side View)	3787P	7	4-18
Payload Assist Module	4979P	7	4-20	Landing (Side View)	4876P	7	4-18
Planetary Probe	4976P	7	4-22	Landing (Underneath View)	3780P	7	4-18
Planets/Moons				Launch Scene	4941P	7	4-18
Earth	3773P	7	4-20	Re-entering Atmosphere	4852P	7	4-18
Jupiter	4911P	7	4-20	Russian	4958P	7	4-22
Jupiter w/Space Probe	3751P	7	4-21	Russian w/Gear Down	4926P	7	4-22
Mars	4906P	7	4-21	w/Launch Rocket (Side View)	4798P	7	4-18
Mars w/Orbiting Spacecraft	4963P	7	4-21	w/Launch Rocket (Top View)	3765P	7	4-18
Mercury Landscape	3763P	7	4-21	w/Launch Rocket (Top View)	4851P	7	4-18
Moon	4910P	7	4-20	Space Station (Detailed)	3750P	7	4-22
Moons in Orbit	4989P	7	4-21	Space Station (Simple)	3783P	7	4-21
Neptune	4960P	7	4-21	Spacecraft, Futuristic			
Planet Rising over Rocks	4972P	7	4-21	Battleship	4927P	7	4-22
Pluto	4988P	7	4-21	Cruiser 1 (Top View)	3771P	7	4-22
Pluto Landscape	3760P	7	4-21	Cruiser 2 (Side View)	3784P	7	4-22
Saturn	4908P	7	4-20	Cruiser 2 (Side View)	4923P	7	4-22
Saturn	4987P	7	4-21	Cruiser 2 (Top View)	3766P	7	4-22
Uranus Landscape	3762P	7	4-21	Fighter 1	3770P	7	4-22
Venus	4869P	7	4-20	Fighter 1 (Disabled)	4964P	7	4-22
Pluto	4988P	7	4-21	Fighter 2	3785P	7	4-22
Pluto Landscape	3760P	7	4-21	Fighter 2	4924P	7	4-22

---

Optional Library #7, Space, continued

---

Description	Number	Lib.	Page
Freighter .....	3753P	7	4-22
Interceptor .....	4925P	7	4-22
Interceptor .....	4957P	7	4-22
Spacecraft, Other			
Lunar Module .....	3546P	7	4-19
Lunar Roving Vehicle .....	4933P	7	4-19
Payload Assist Module .....	4979P	7	4-20
Planetary/Space Probe .....	4976P	7	4-22
Star Cluster .....	4905P	7	4-20
Tracking Station/Dish Antenna .....	4799P	7	4-19
Tracking Station/Dish Antenna .....	4965P	7	4-20
Uranus Landscape .....	3762P	7	4-21
Venus .....	4869P	7	4-20

## Optional Library #11, Agriculture

Description	Number	Lib.	Page	Description	Number	Lib.	Page
Apple	2852P	11	4-24	Radishes	2862P	11	4-24
Apricots	2859P	11	4-24	Rice	4503P	11	4-25
Artichoke	2866P	11	4-24	Rye	4506P	11	4-25
Asparagus	2861P	11	4-24	Squash	2872P	11	4-24
Avocado	2868P	11	4-24	Strawberries	2854P	11	4-24
Banana	2853P	11	4-24	Sugar Cane	4507P	11	4-25
Barley	4505P	11	4-25	Sweet Potatoes	2863P	11	4-24
Beans	2879P	11	4-24	Tobacco Leaf	4512P	11	4-24
Beet	2880P	11	4-24	Tomato	4551P	11	4-24
Bell Pepper	2878P	11	4-24	Tractor	2884P	11	4-25
Bread Loaf	4575P	11	4-25	Tractor			
Buildings Farm Scene	2883P	11	4-25	and Bailer	2893P	11	4-25
Cantaloupe	2865P	11	4-24	and Chemical Spreader	2885P	11	4-25
Cantaloupe	4554P	11	4-24	and Cultivator	2890P	11	4-25
Carrot	4513P	11	4-24	and Cutter Bar	2898P	11	4-25
Celery	2856P	11	4-24	and Disc Harrow	2887P	11	4-25
Cherries	2867P	11	4-24	and Fertilizer Spreader	2891P	11	4-25
Chili Pepper	4560P	11	4-25	and Hay Rake	2892P	11	4-25
Coconut	4519P	11	4-24	and Plow	2886P	11	4-25
Coffee Bean	4511P	11	4-25	and Seed Drill	2889P	11	4-25
Combine Harvester	2895P	11	4-25	and Spring Tooth Harrow	2888P	11	4-25
Corn	4501P	11	4-24	w/Cab and Large Tires	2896P	11	4-25
Cotton	5045P	11	4-25	Turnip	4509P	11	4-24
Cotton Picker Combine	2894P	11	4-25	Vegetables			
Cucumber	2851P	11	4-24	Artichoke	2866P	11	4-24
Eggplant	2871P	11	4-24	Asparagus	2861P	11	4-24
Farm Buildings Scene	2883P	11	4-25	Avocado	2868P	11	4-24
Fruit				Beans	2879P	11	4-24
Apple	2852P	11	4-24	Beet	2880P	11	4-24
Apricots	2859P	11	4-24	Bell Pepper	2878P	11	4-24
Banana	2853P	11	4-24	Carrot	4513P	11	4-24
Cantaloupe	2865P	11	4-24	Celery	2856P	11	4-24
Cantaloupe	4554P	11	4-24	Corn	4501P	11	4-24
Cherries	2867P	11	4-24	Cucumber	2851P	11	4-24
Grapefruit	2875P	11	4-24	Eggplant	2871P	11	4-24
Grapes	4550P	11	4-24	Garlic	2857P	11	4-25
Lemon	2869P	11	4-24	Green Beans	2860P	11	4-24
Orange	2855P	11	4-24	Jalapeno	2877P	11	4-25
Peach	4508P	11	4-24	Lettuce	2858P	11	4-24
Pear	2421P	11	4-24	Mushrooms	4584P	11	4-24
Pineapple	2899P	11	4-24	Onion	2876P	11	4-24
Strawberries	2854P	11	4-24	Peas in a Pod (One Pod)	4324P	11	4-24
Tomato	4551P	11	4-24	Peas in a Pod (Three Pods)	4515P	11	4-24
Watermelon	4990P	11	4-24	Potato	4522P	11	4-24
Garlic	2857P	11	4-25	Radishes	2862P	11	4-24
Grain				Squash	2872P	11	4-24
Barley	4505P	11	4-25	Sweet Potatoes	2863P	11	4-24
Corn	4501P	11	4-24	Turnip	4509P	11	4-24
Oats	4504P	11	4-25	Watermelon	4990P	11	4-24
Rice	4503P	11	4-25	Wheat	4502P	11	4-25
Rye	4506P	11	4-25	Wind Rower	2897P	11	4-25
Wheat	4502P	11	4-25				
Grapefruit	2875P	11	4-24				
Grapes	4550P	11	4-24				
Green Beans	2860P	11	4-24				
Ham	2882P	11	4-25				
Hay Bales	2873P	11	4-25				
Jalapeno	2877P	11	4-25				
Lemon	2869P	11	4-24				
Lettuce	2858P	11	4-24				
Mushrooms	4584P	11	4-24				
Oats	4504P	11	4-25				
Olives	2874P	11	4-25				
Onion	2876P	11	4-24				
Orange	2855P	11	4-24				
Peach	4508P	11	4-24				
Peanut	4510P	11	4-25				
Pear	2421P	11	4-24				
Peas in a Pod (One Pod)	4324P	11	4-24				
Peas in a Pod (Three Pods)	4515P	11	4-24				
Pineapple	2899P	11	4-24				
Potato	4522P	11	4-24				

---

## Optional Library #13, Portrait Gallery

---

Description	Number	Lib.	Page
Men's Heads and Faces .....	13		4-26
Women's Heads and Faces .....	13		4-27

## Optional Library #15, Vehicles & Heavy Equipment

Description	Number	Lib.	Page	Description	Number	Lib.	Page
<b>Automobiles</b>				<b>Oil Tanker Truck</b>	3534P	15	4-28
Compact Sports Car	5011P	15	4-28	Pick-Up Truck	3525P	15	4-28
Convertible, Large	5029P	15	4-28	Pick-Up Truck	5035P	15	4-28
Mid-Sized Four-Door	5021P	15	4-28	Pick-Up Truck w/Portable Generator	3532P	15	4-28
Mid-Sized Two-Door	5017P	15	4-28	Police Cruiser	5033P	15	4-28
Police Cruiser	5033P	15	4-28	Portable Generator	3526P	15	4-28
Station Wagon	5013P	15	4-28	Power Shovel	3966P	15	4-28
Station Wagon	5023P	15	4-28	Road Grader	4582P	15	4-28
Stretched Limousine	5027P	15	4-28	Road Grader	3542P	15	4-28
Sub-Compact	5001P	15	4-28	Scissor Lift	3967P	15	4-28
Taxi	5031P	15	4-28	Semi-Truck	3511P	15	4-28
Two-Door Coupe	5005P	15	4-28	Sheeps Foot Dozer	4885P	15	4-28
Two-Door Coupe	5007P	15	4-28	Sheeps Foot Dozer Wheel	4886P	15	4-28
<b>Back Hoe</b>	4578P	15	4-28	Snorkle Lift	3969P	15	4-28
<b>Bulldozer</b>	3968P	15	4-28	Station Wagon	5013P	15	4-28
<b>Bulldozer</b>	4580P	15	4-28	Station Wagon	5023P	15	4-28
<b>Bulldozer</b>	4581P	15	4-28	Steam Roller	3524P	15	4-28
<b>Cement Truck</b>	3523P	15	4-28	Steam Roller	4583P	15	4-28
Compact Sports Car	5011P	15	4-28	Sub-Compact Car	5001P	15	4-28
Convertible, Large	5029P	15	4-28	Tank Truck	3538P	15	4-28
Crane Truck	3536P	15	4-28	Taxi	5031P	15	4-28
Crawler Tractor	3541P	15	4-28	Tractor	4579P	15	4-28
w/Scraper Trailer	3540P	15	4-28	Trailer, Large	3533P	15	4-28
Delivery Van	5041P	15	4-28	Truck Crane	3955P	15	4-28
Ditch Digger	3501P	15	4-28	<b>Trucks</b>			
Dump Truck	3508P	15	4-28	Cement Truck	3523P	15	4-28
Dump Truck	3509P	15	4-28	Crane Truck	3536P	15	4-28
Dump Truck, Large	3510P	15	4-28	Delivery Van	5041P	15	4-28
Earth Mover/Scraper	3529P	15	4-28	Dump Truck	3508P	15	4-28
Earth Scraper	3539P	15	4-28	Dump Truck	3509P	15	4-28
Excavator	3537P	15	4-28	Dump Truck (Large)	3510P	15	4-28
Fire Truck	5044P	15	4-28	Fire Truck	5044P	15	4-28
Flat-Bed Trailer	3535P	15	4-28	Flat-Bed Trailer	3535P	15	4-28
Flat-Bed Truck	3521P	15	4-28	Flat-Bed Truck	3521P	15	4-28
Fork Lift	3531P	15	4-28	Garbage Truck	5043P	15	4-28
Front-End Loader	4576P	15	4-28	Grain Truck	3520P	15	4-28
Front-End Loader, Small	4577P	15	4-28	Moving Truck	3522P	15	4-28
Garbage Truck	5043P	15	4-28	Moving Van	3528P	15	4-28
Grain Truck	3520P	15	4-28	Oil Tanker Truck	3534P	15	4-28
<b>Heavy Equipment</b>				Pick-Up Truck	3525P	15	4-28
Back Hoe	4578P	15	4-28	Pick-Up Truck	5035P	15	4-28
Bulldozer	3968P	15	4-28	Pick-Up Truck w/Port. Generator	3532P	15	4-28
Bulldozer	4580P	15	4-28	Semi-Truck	3511P	15	4-28
Bulldozer	4581P	15	4-28	Tank Truck	3538P	15	4-28
Crawler Tractor	3541P	15	4-28	Trailer, Large	3533P	15	4-28
Crawler Tractor w/Scraper Trailer	3540P	15	4-28	Truck Crane	3955P	15	4-28
Ditch Digger	3501P	15	4-28	Utilities Truck	3527P	15	4-28
Earth Mover/Scraper	3529P	15	4-28	Van	5037P	15	4-28
Earth Scraper	3539P	15	4-28	Wrecker	5039P	15	4-28
Excavator	3537P	15	4-28	Two-Door Coupe	5005P	15	4-28
Fork Lift	3531P	15	4-28	Two-Door Coupe	5007P	15	4-28
Front-End Loader	4576P	15	4-28	Utilities Truck	3527P	15	4-28
Front-End Loader, Small	4577P	15	4-28	Van	5037P	15	4-28
Portable Generator	3526P	15	4-28	Wrecker	5039P	15	4-28
Power Shovel	3966P	15	4-28				
Road Grader	4582P	15	4-28				
Road Grader	3542P	15	4-28				
Scissor Lift	3967P	15	4-28				
Sheeps Foot Dozer	4885P	15	4-28				
Sheeps Foot Dozer Wheel	4886P	15	4-28				
Snorkle Lift	3969P	15	4-28				
Steam Roller	3524P	15	4-28				
Steam Roller	4583P	15	4-28				
Tractor	4579P	15	4-28				
Truck Crane	3955P	15	4-28				
Limousine, Stretched	5027P	15	4-28				
<b>Mid-Sized Car</b>							
Four-Door	5021P	15	4-28				
Two-Door	5017P	15	4-28				
<b>Moving</b>							
Truck	3522P	15	4-28				
Van	3528P	15	4-28				



---

*Notes*

---

# Pictorials

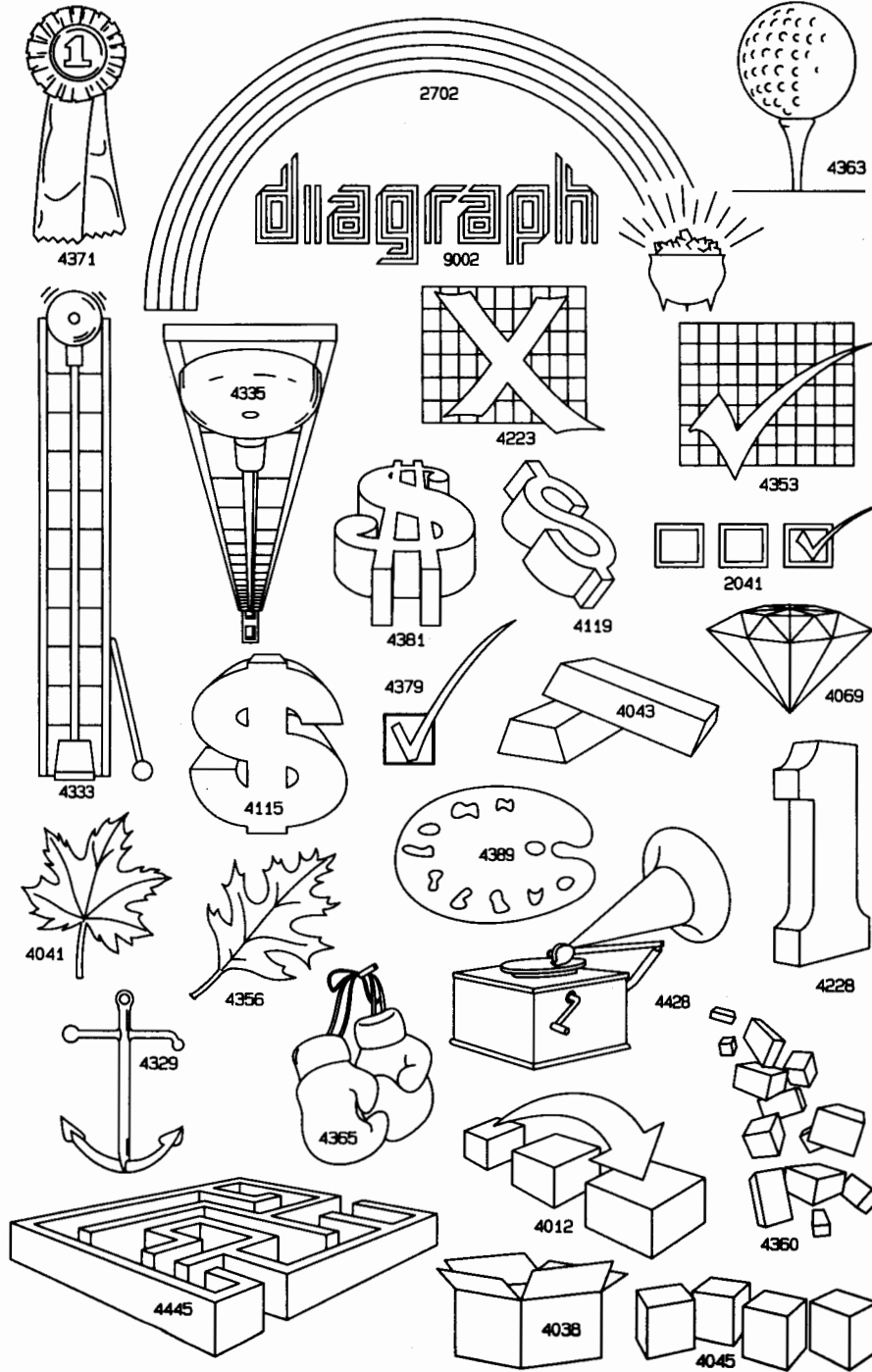

# Pictorials

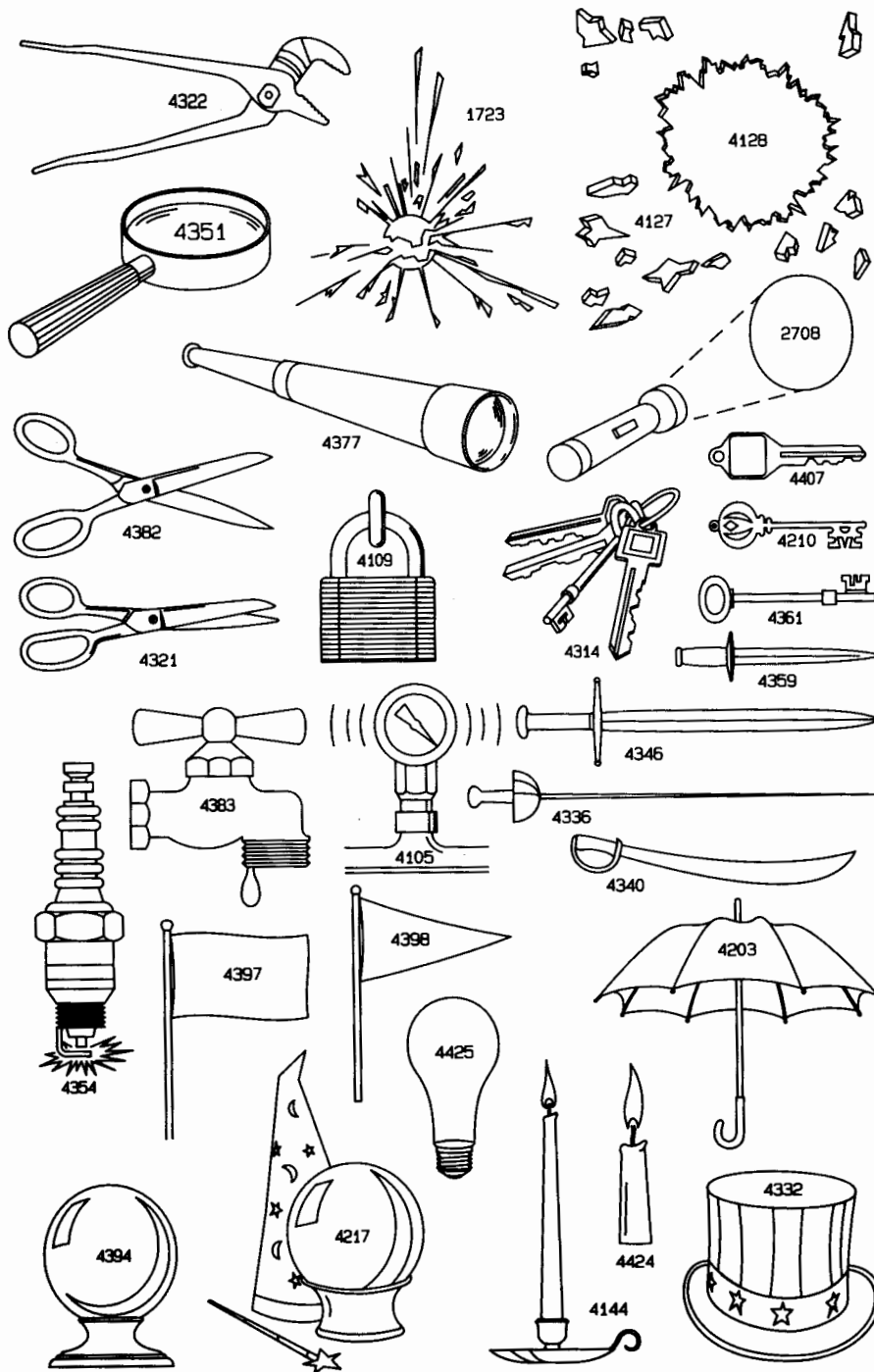

# Pictorials

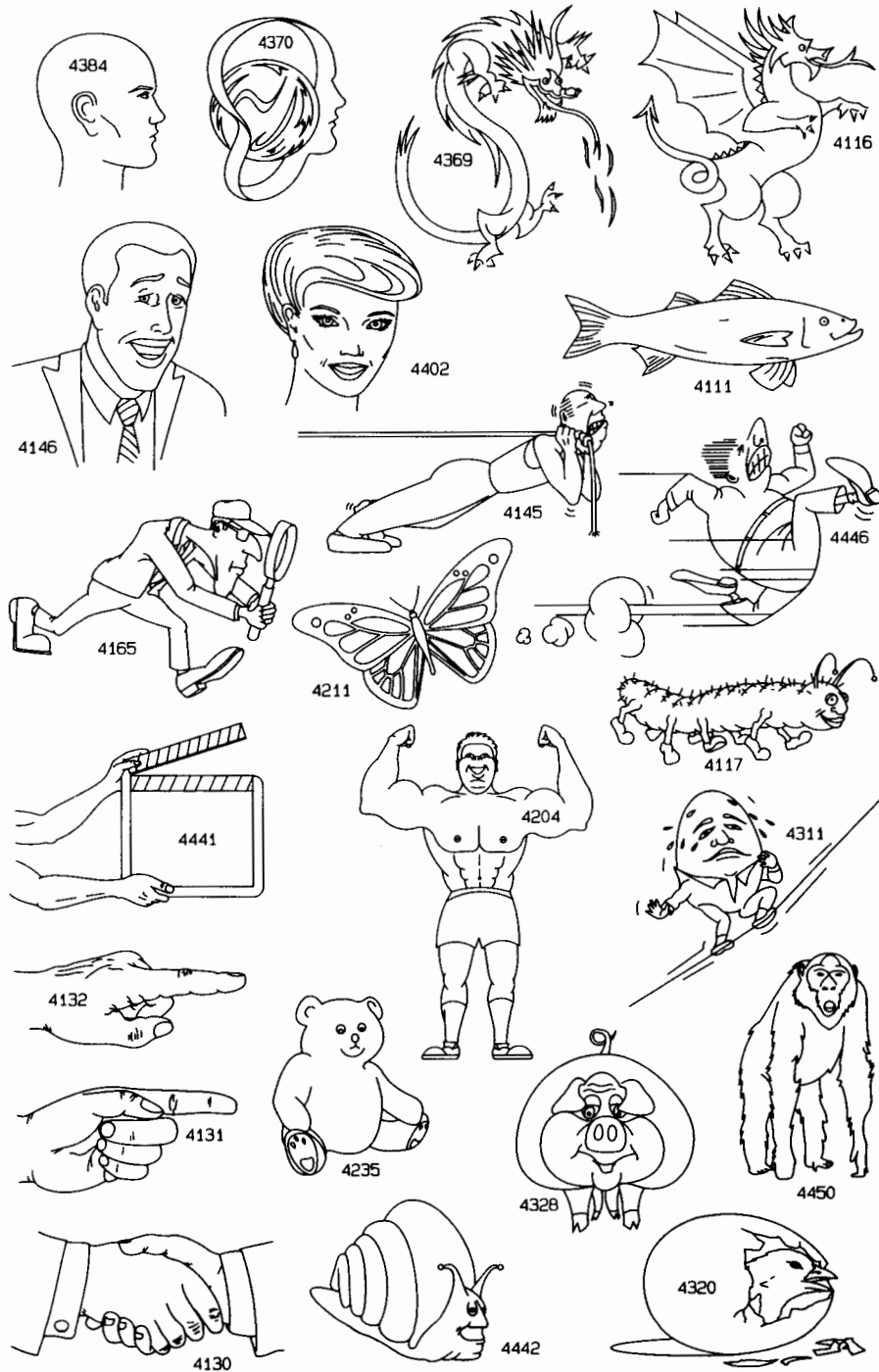

# Pictorials

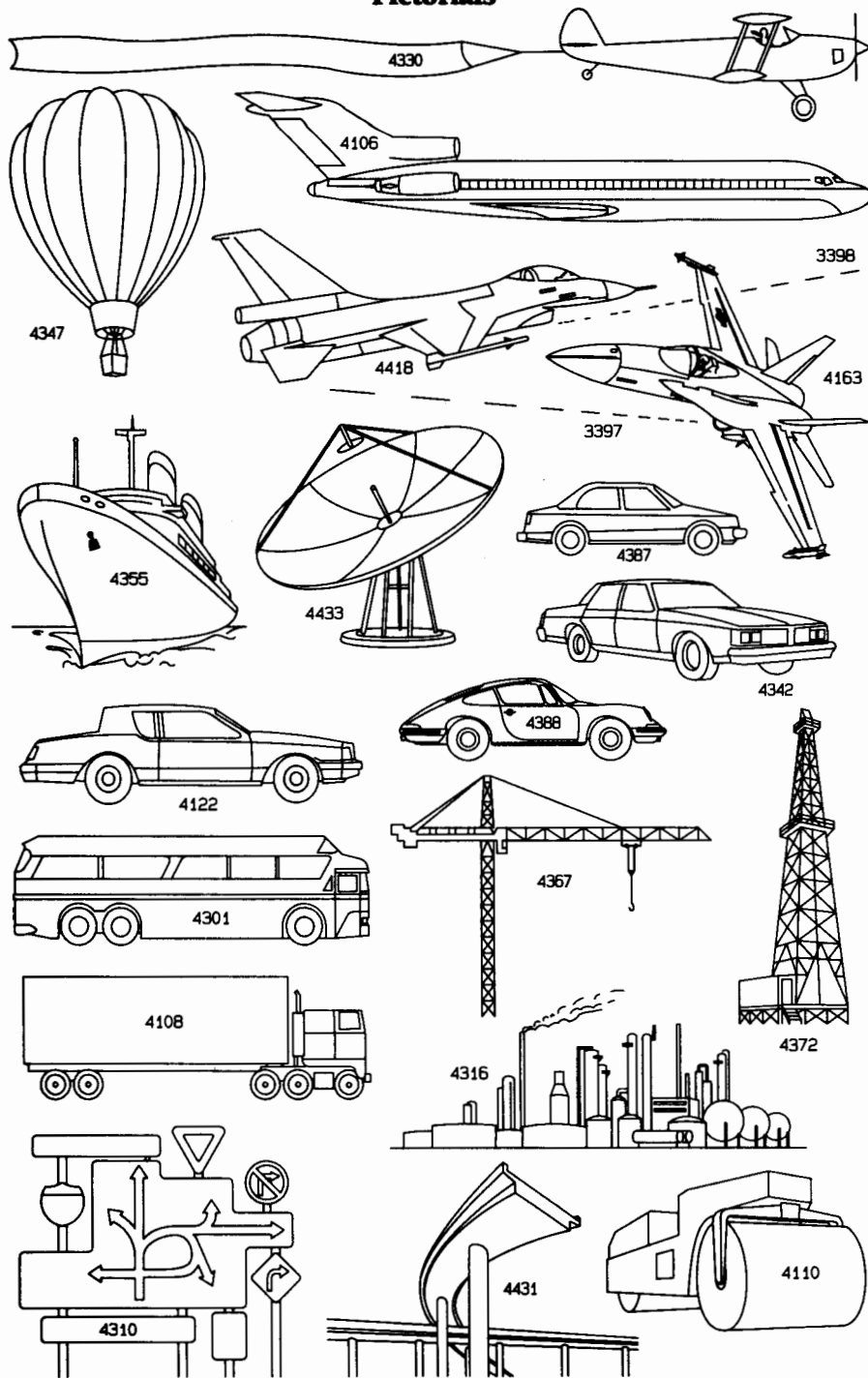

# Pictorials

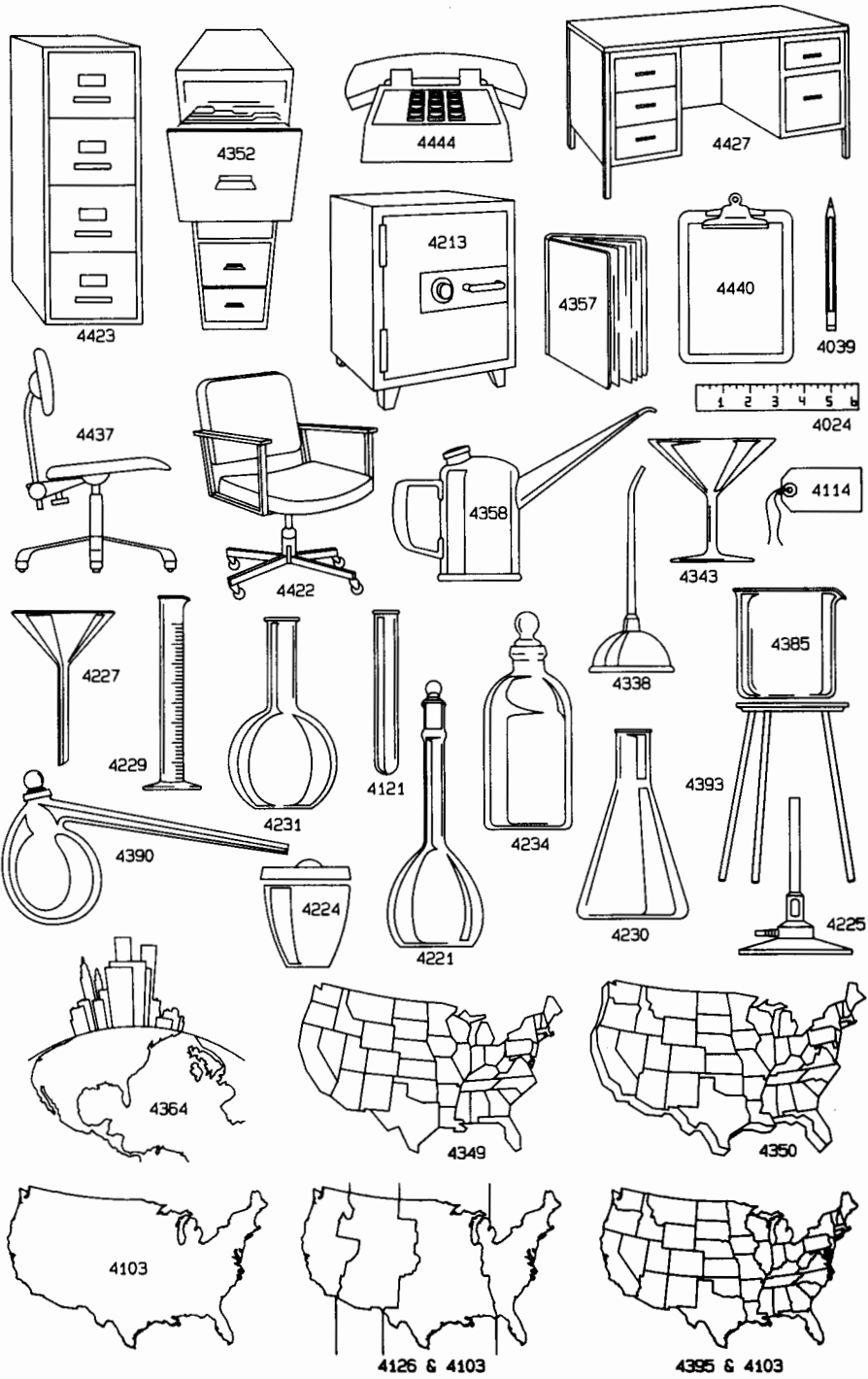

# Pictorials - Composition Aids

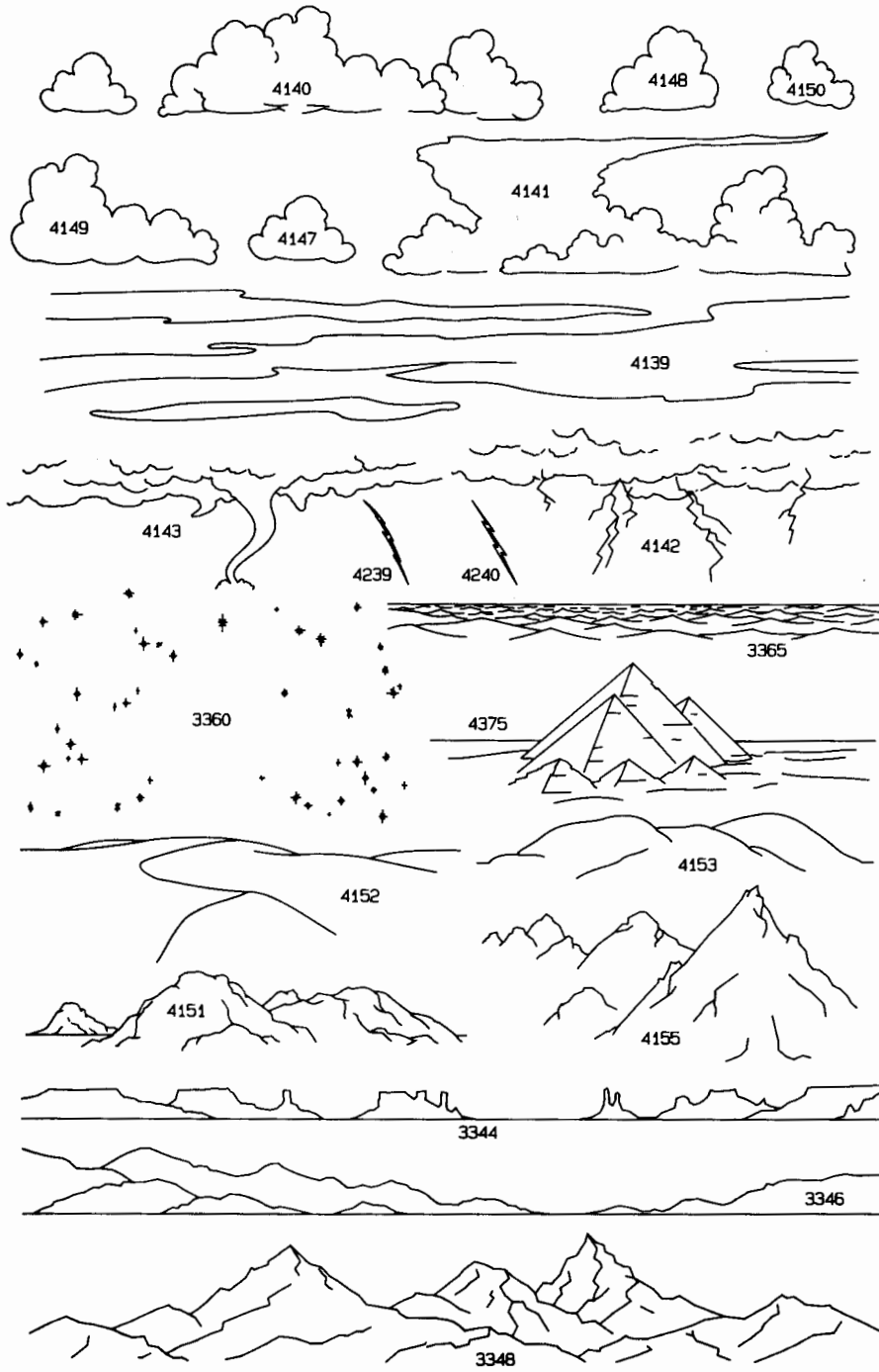

Pictorials - Composition Aids

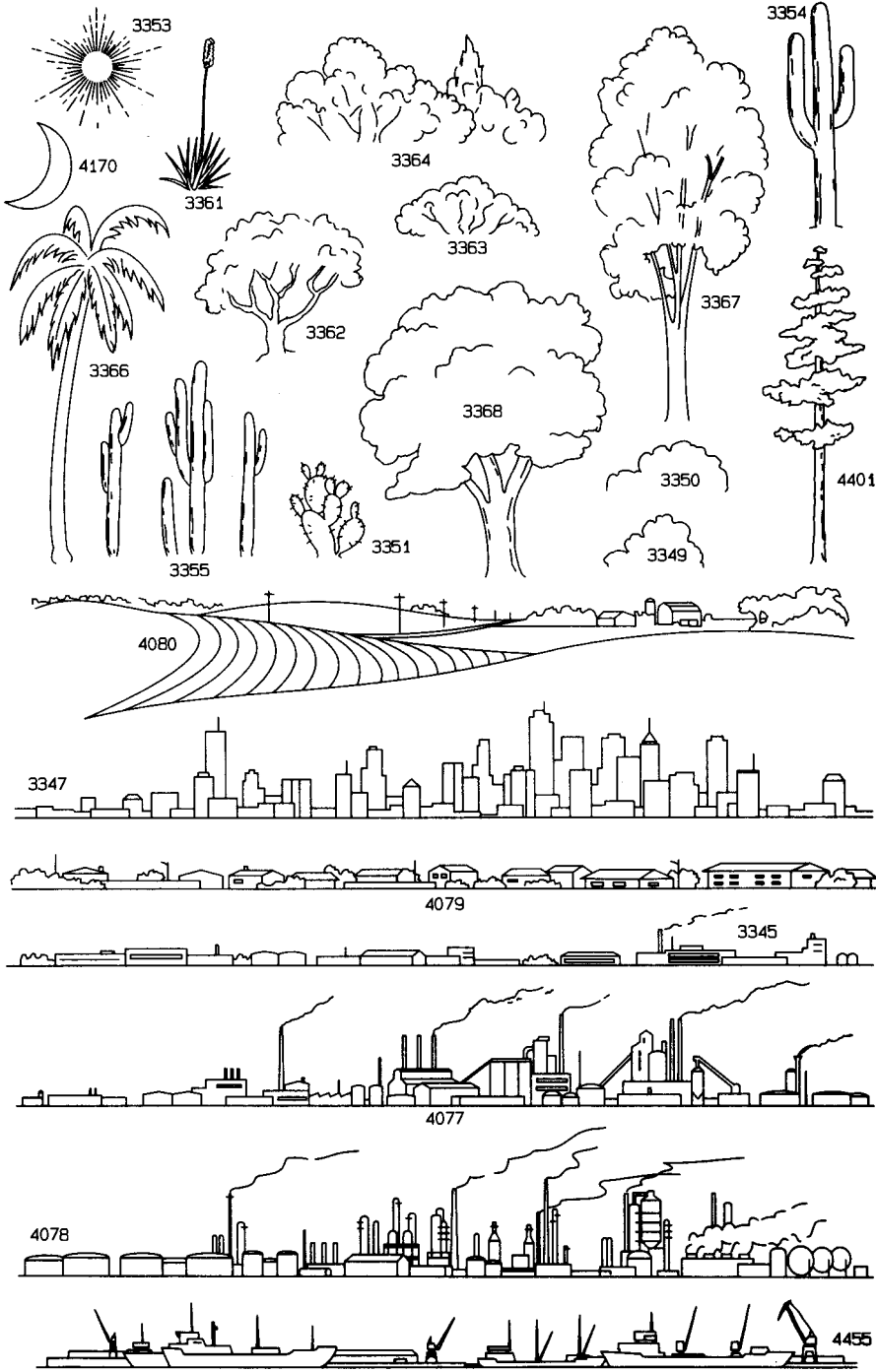



# Pictorials - Composition Aids

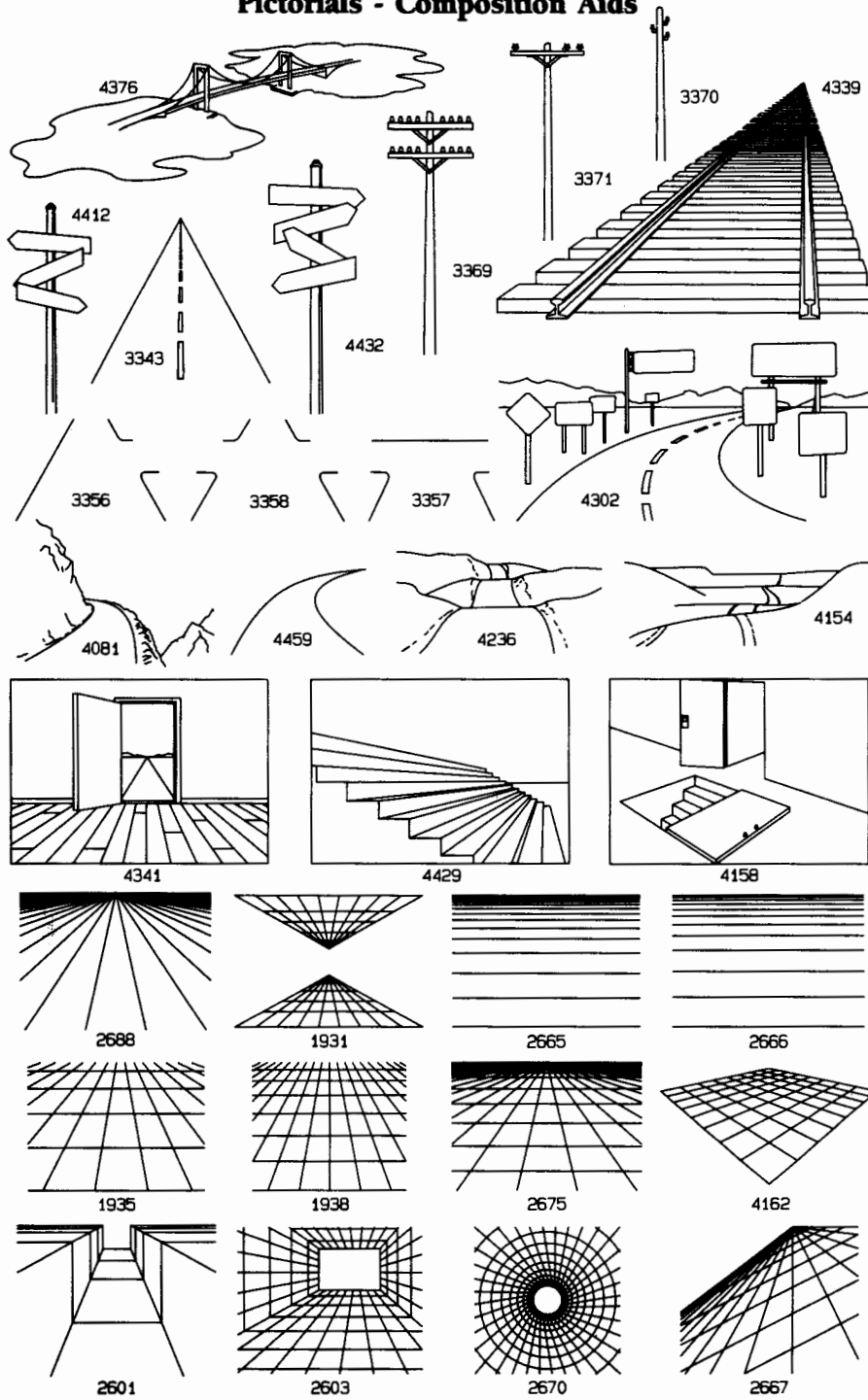

# Holidays and Seasons



# Holidays and Seasons



# Holidays and Seasons

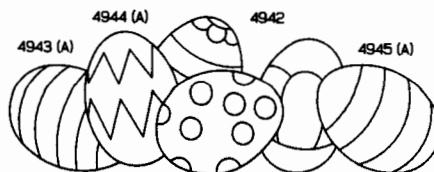
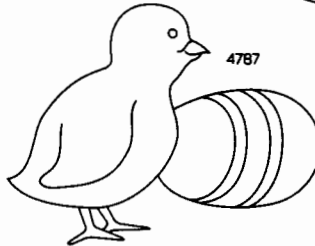
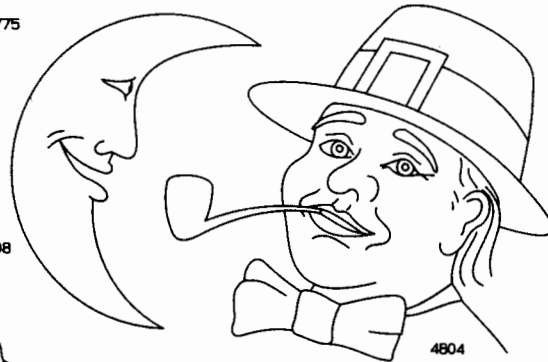
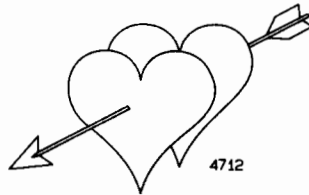
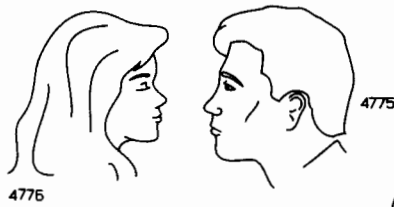
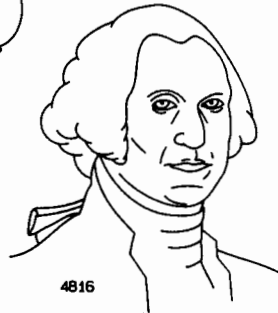
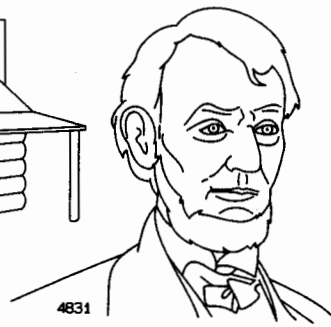
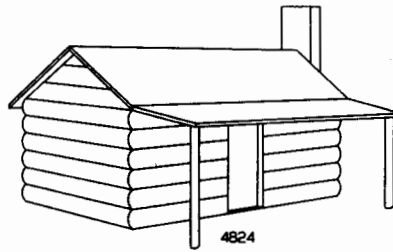

# Holidays and Seasons



# Holidays and Seasons



# Holidays and Seasons

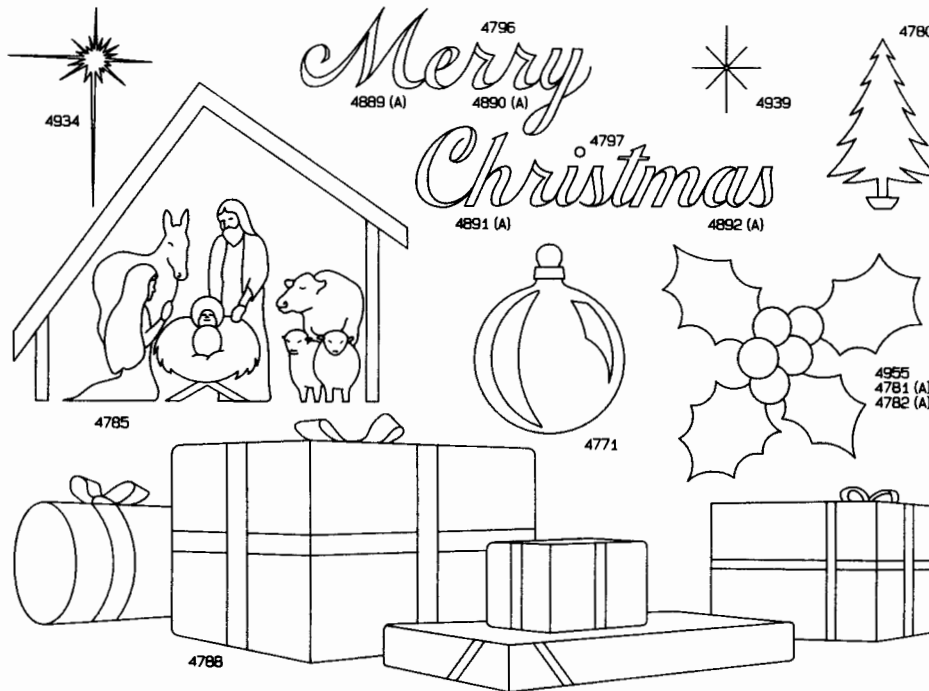
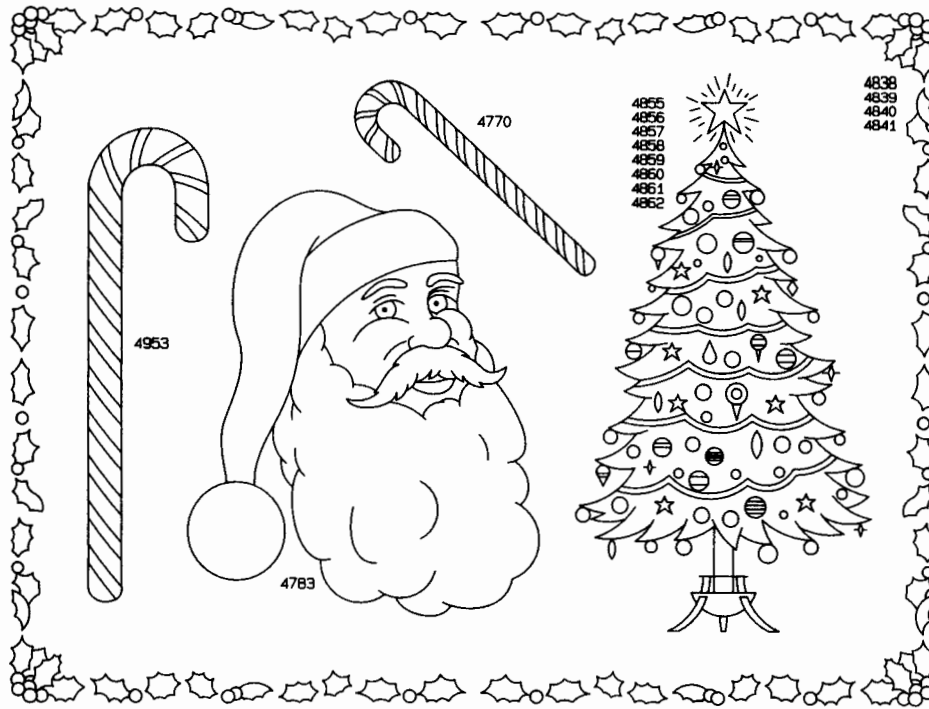

# Holidays and Seasons

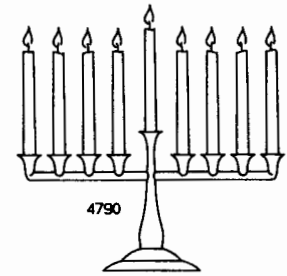
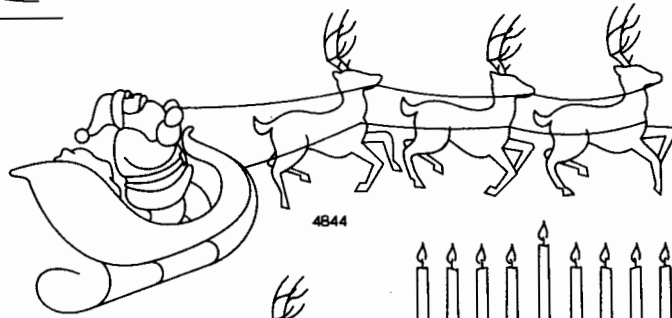
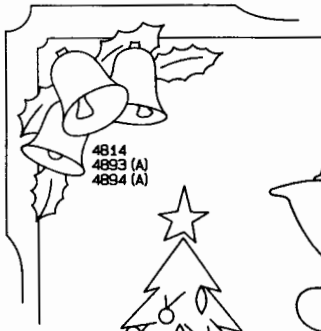

4912  
*Season's*  
4914 (A) 4915 (A) 4916 (A)

4913  
*Greetings*  
4917 (A) 4918 (A) 4919 (A) 4920 (A)

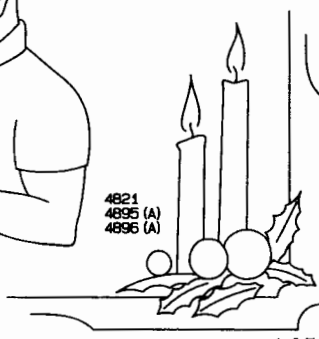
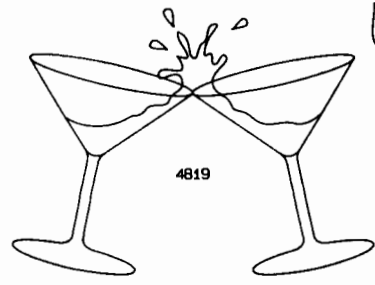
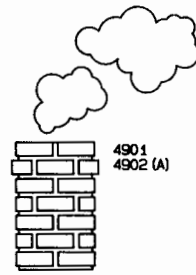



More Pictorials



More Pictorials



# Space

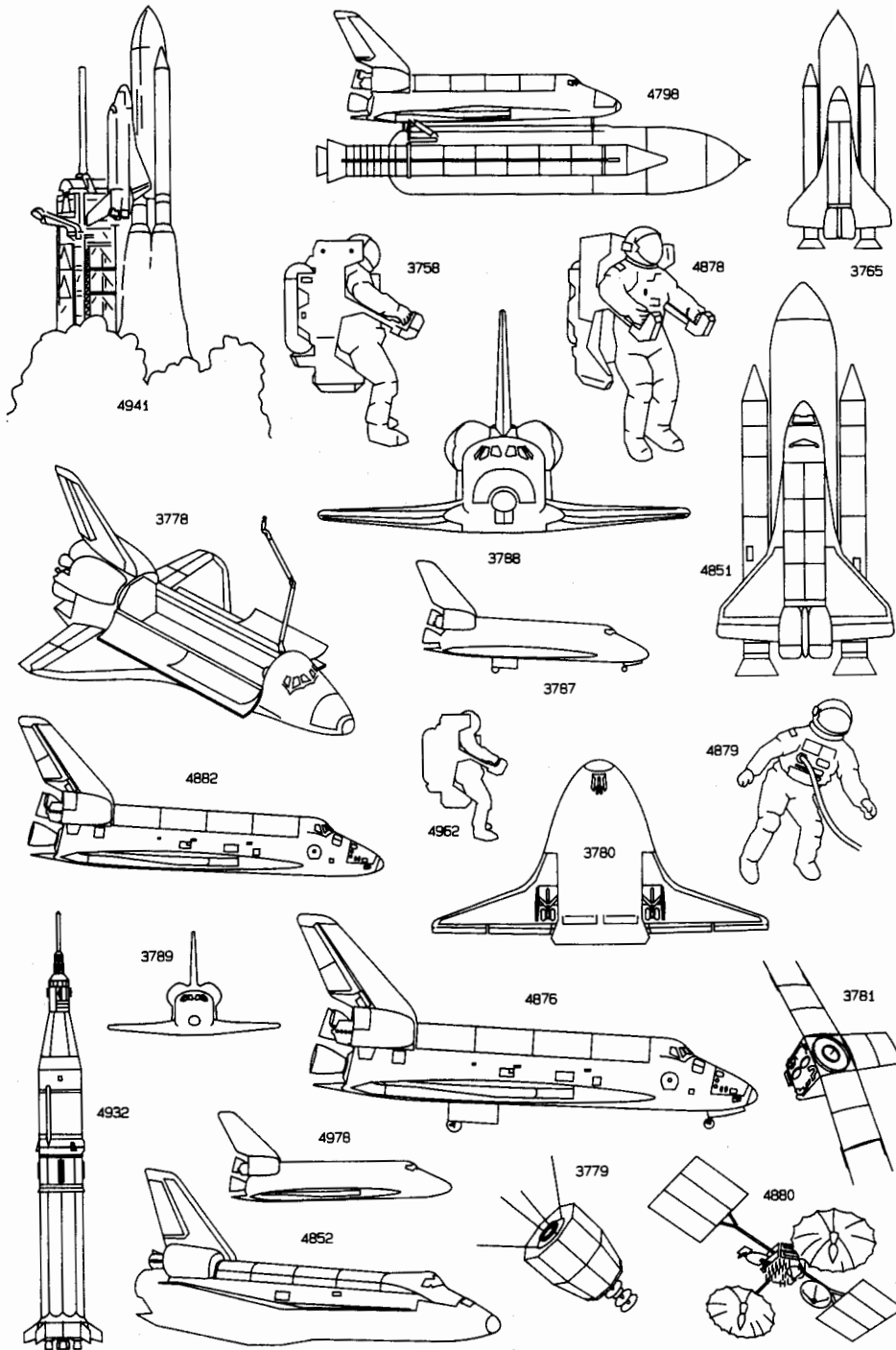

# Space

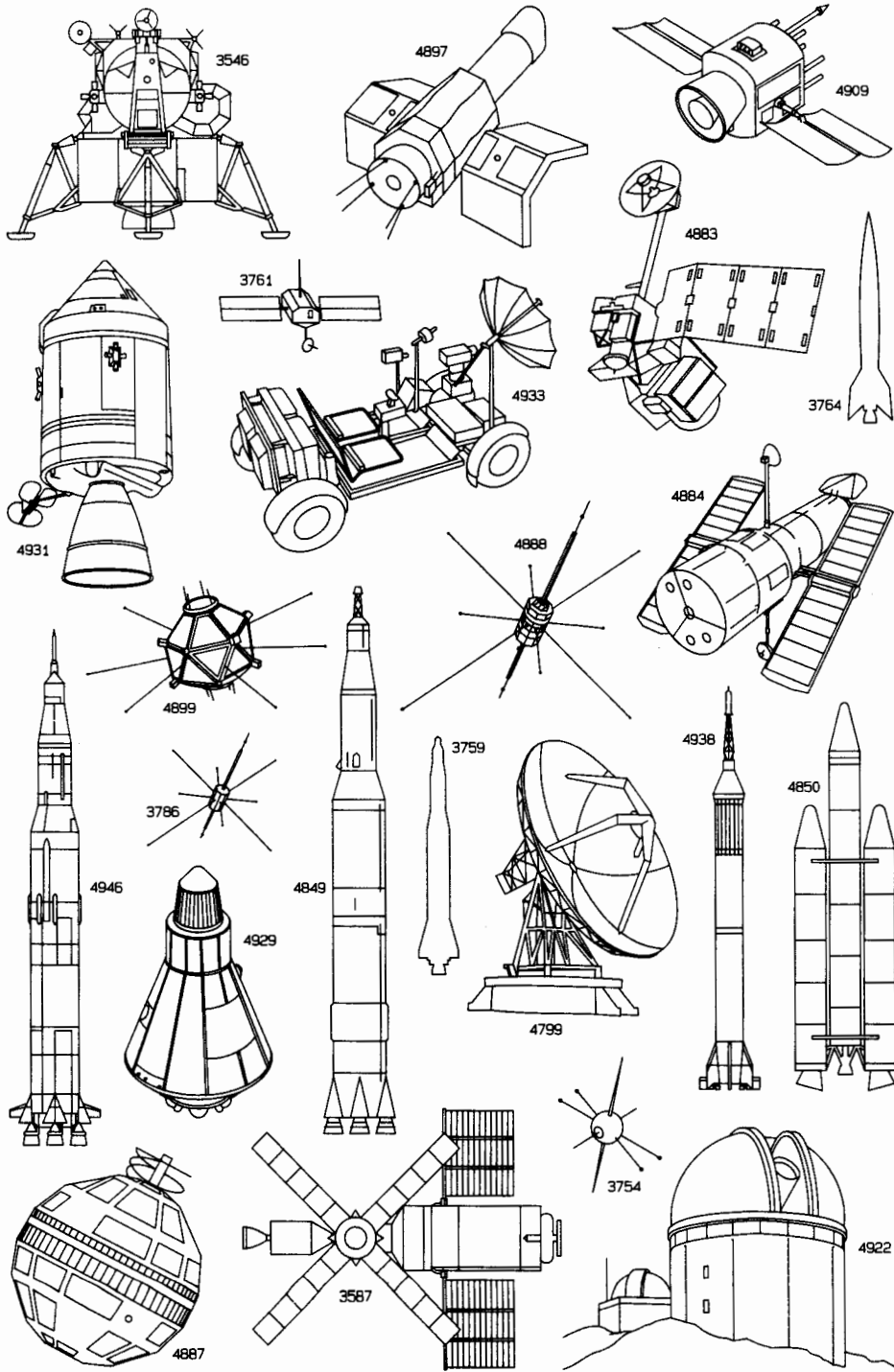

# Space

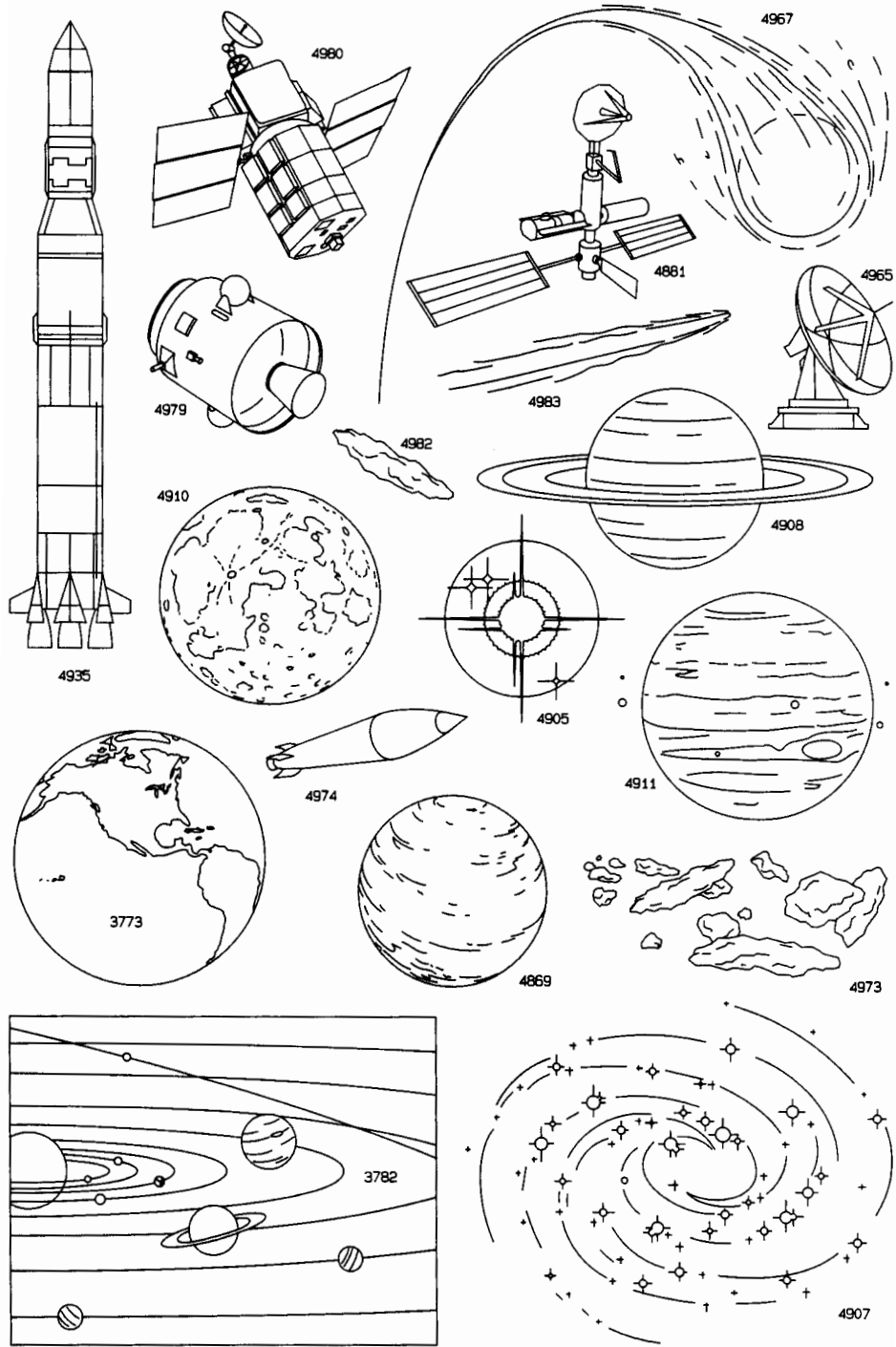

# Space

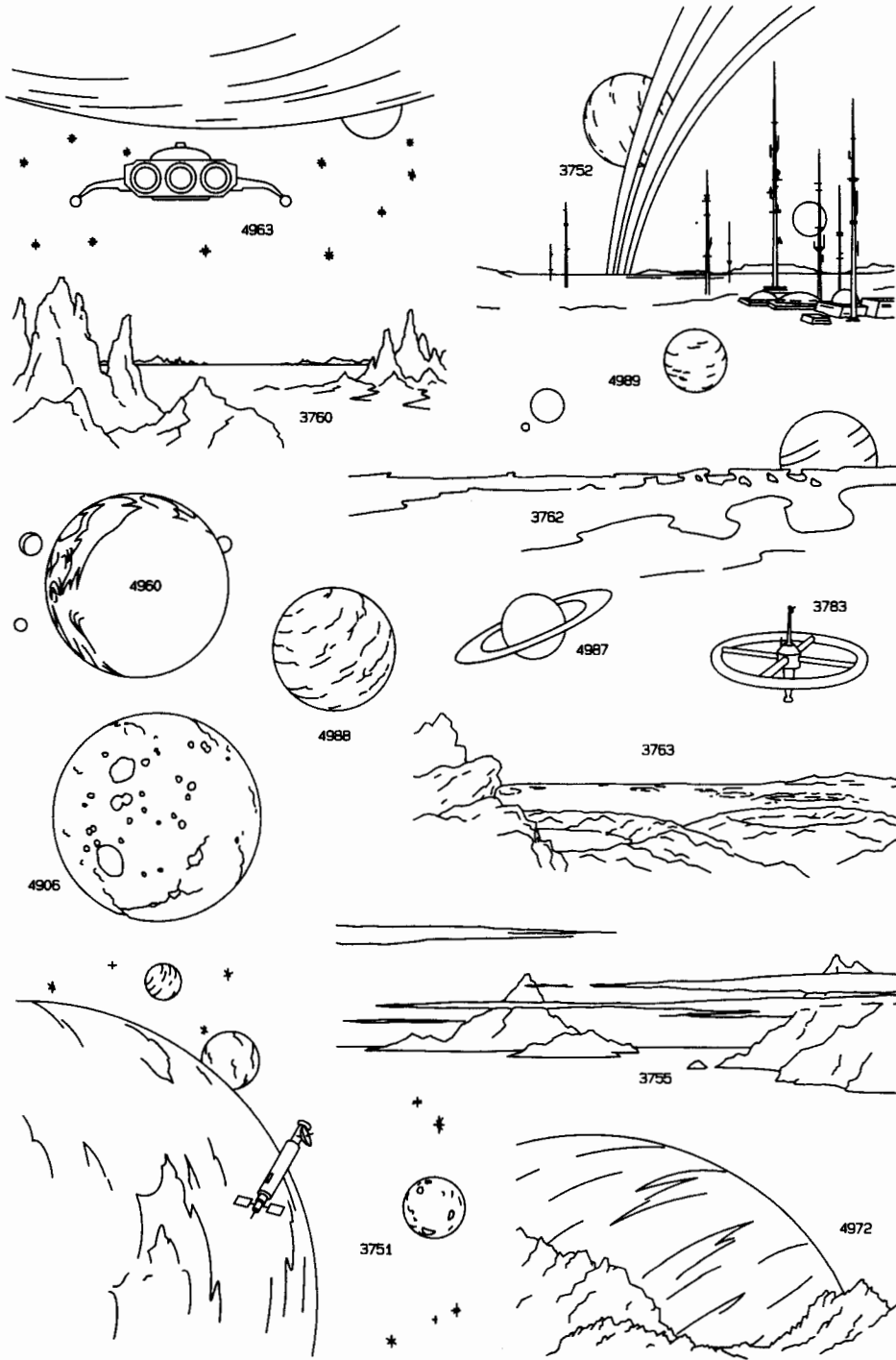

# Space

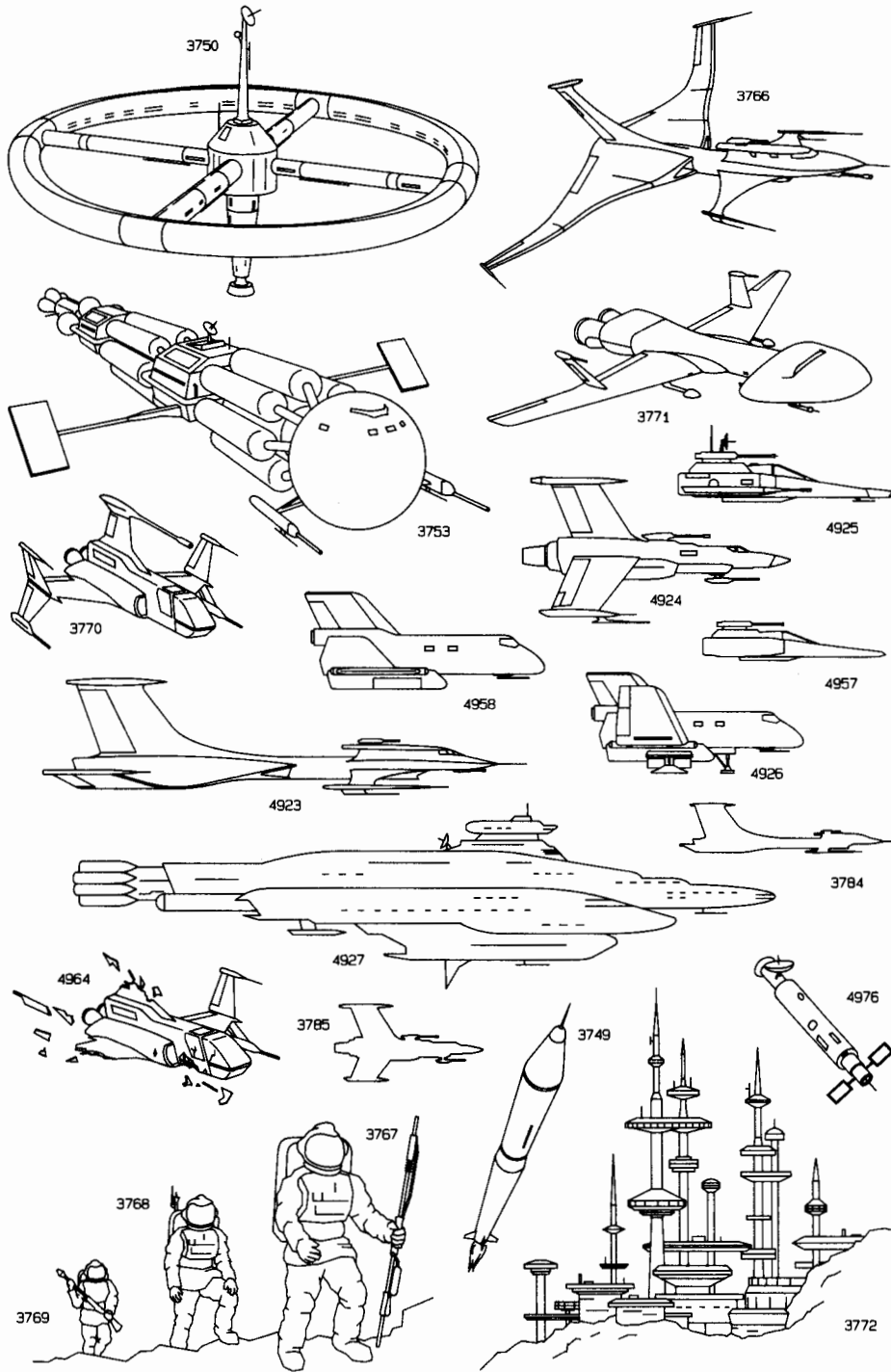

# Space

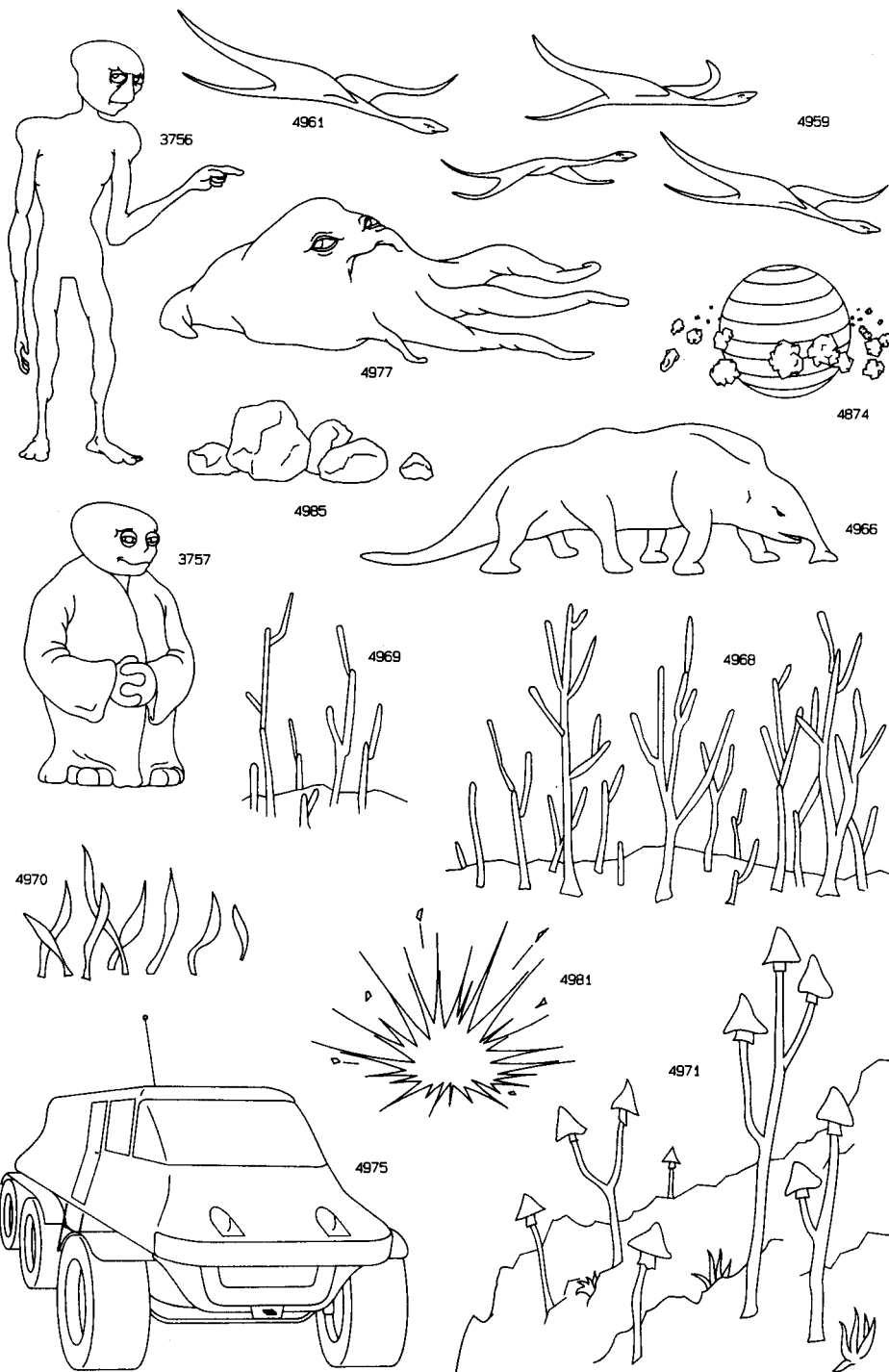



# Agriculture

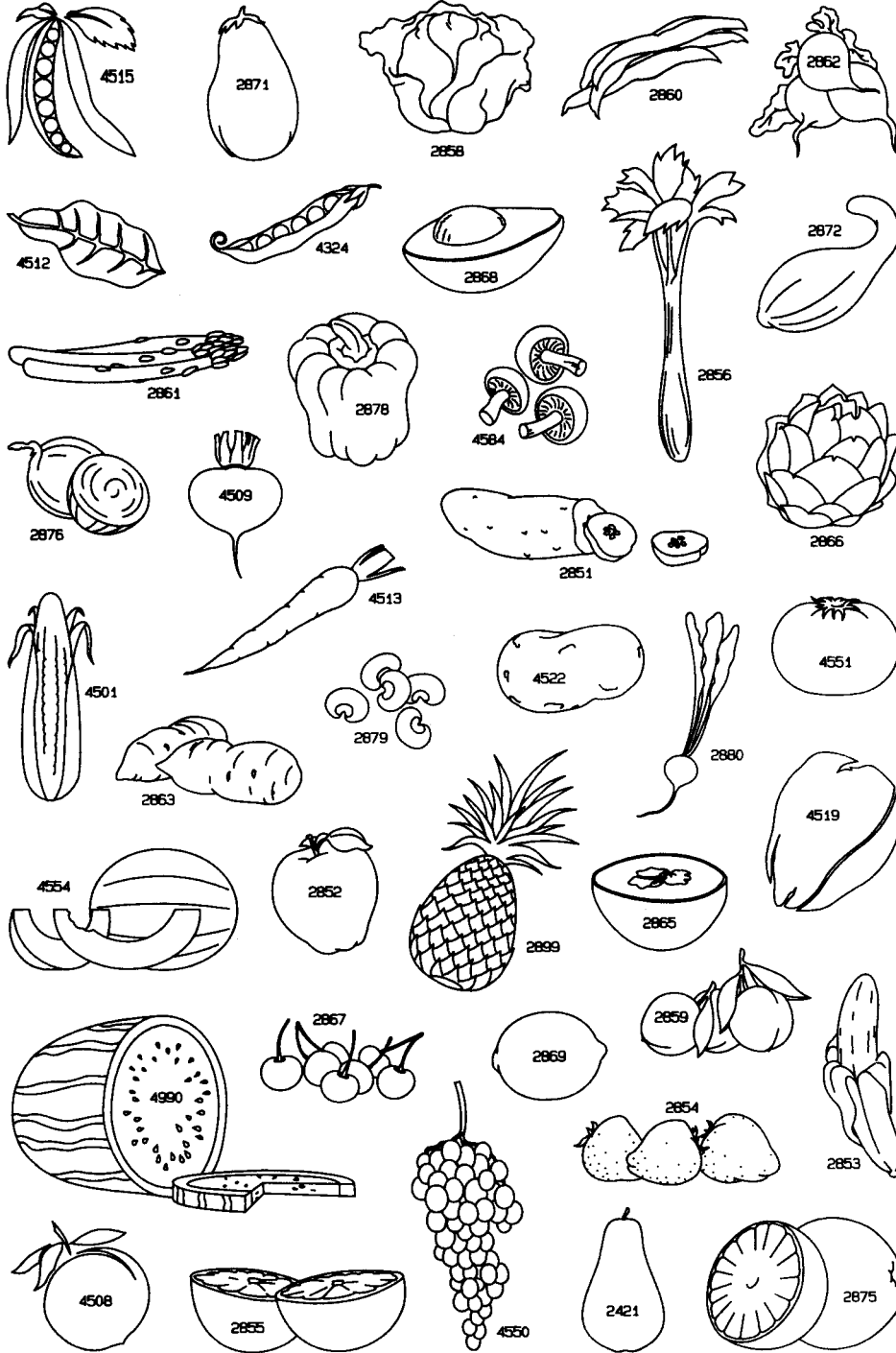

# Agriculture

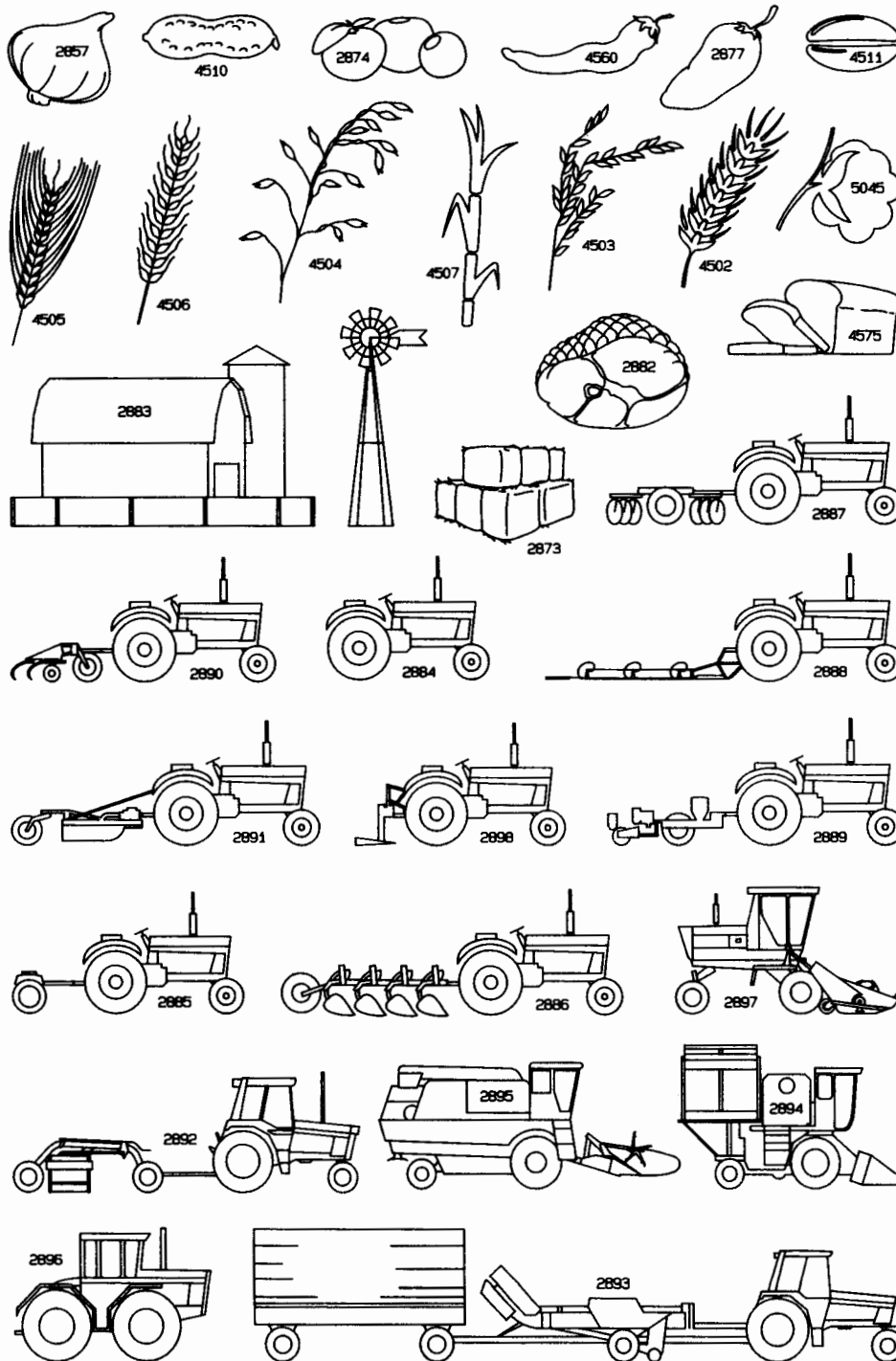

# Portrait Gallery

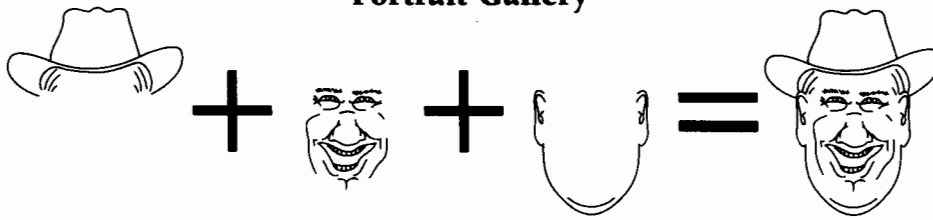

3601



3602



3603



3604



3505



3606



3607



3608



3609



3610



3611



3612



3613



3614



3615



3616



3617



3618



5206



5215

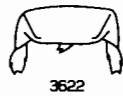

3622



3632



3620



3623



3624



3625



3626



3628



3631



3633



3621



3630



3629



3627



3619

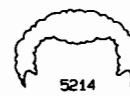

5214



5208



5209



5210



5211



5212



5213



3634



3635



3636

# Portrait Gallery

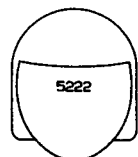
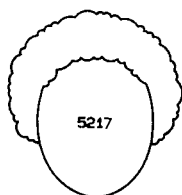
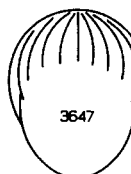
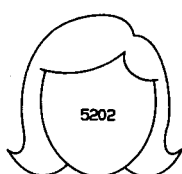
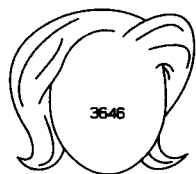
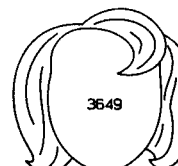
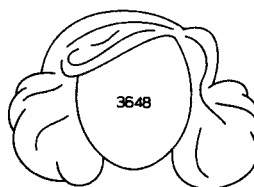
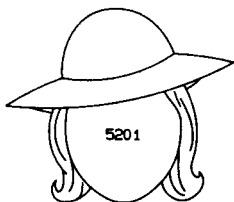
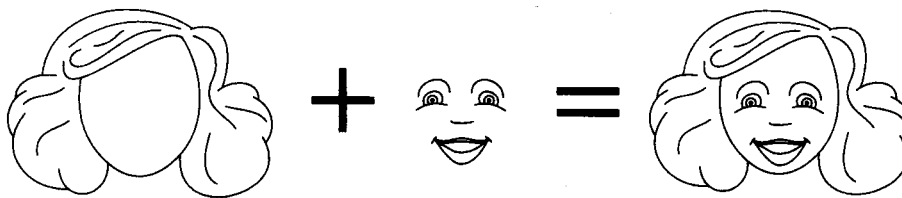

# Vehicles and Heavy Equipment

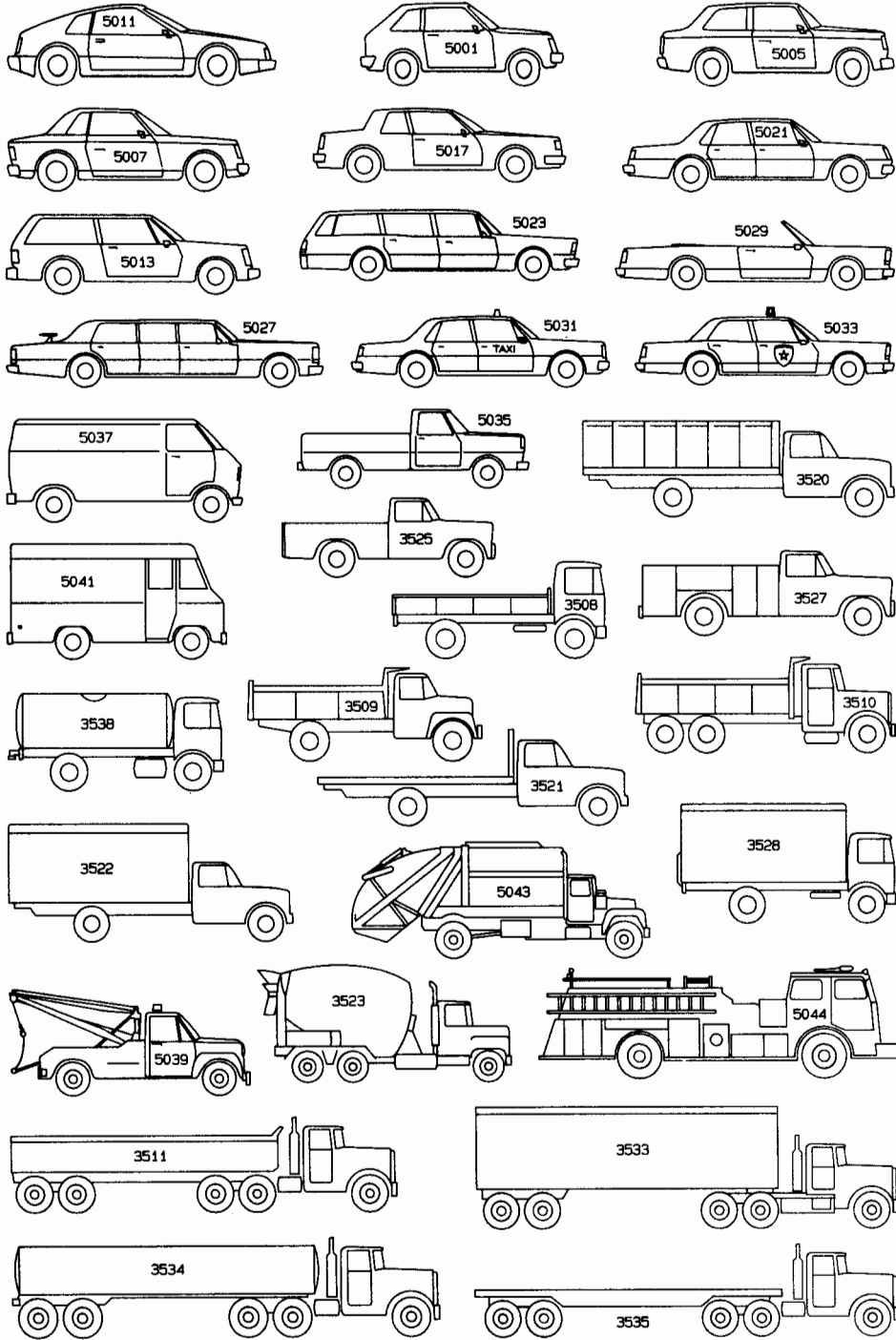

# Vehicles and Heavy Equipment

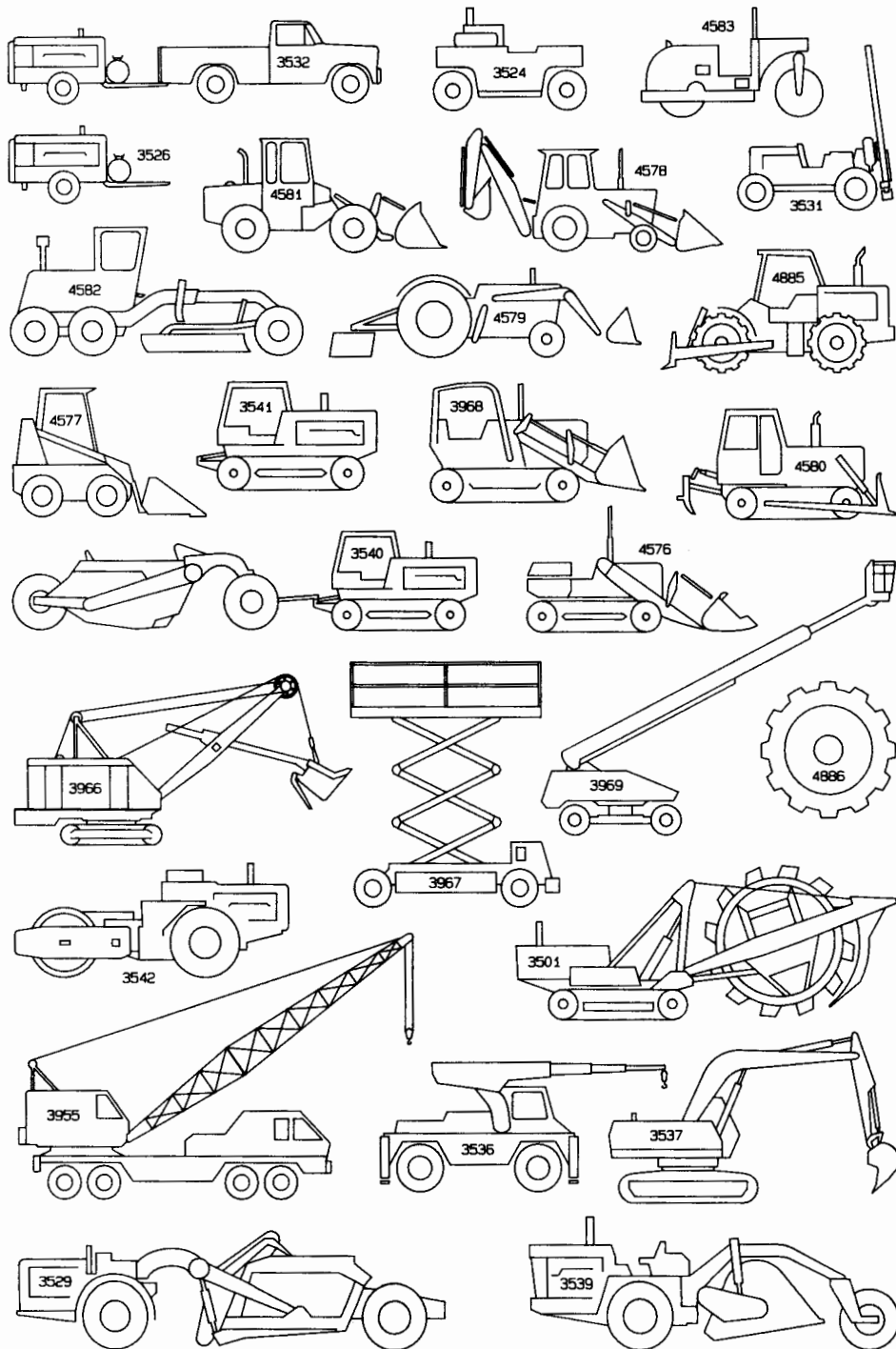



# 5 Applications



## Symbol Index

Description	Number	Lib.	Page	Description	Number	Lib.	Page
Acoustic Coupler.....	1674	..	5-5	Input, Manual (Flowchart).....	1921	..	5-4
Armchair (Layout).....	1295	..	5-6	Input/Output (Flowchart).....	1915	..	5-4
Auxiliary Operation (Flowchart).....	1017	..	5-4	Interrupt, Terminal (Flowchart).....	1656	..	5-4
Axes (X and Y).....	.....	..	5-2	Inverse Multiplexer (Flowchart).....	2019	..	5-5
Bar Charts.....	.....	..	5-3	Keying (Flowchart).....	1653	..	5-4
Bell Curve w/Axes.....	1251	..	5-3	Layout, Office.....	.....	..	5-6
Brace				Line Charts.....	.....	..	5-3
Long.....	3331	..	5-1	Line Concentrator (Flowchart).....	1667	..	5-5
Short.....	1265	..	5-1	Line Sharing (Flowchart).....	1669	..	5-5
CRT				Links, Communication (Flowchart).....	.....	..	5-5
Communications (Flowchart).....	2023	..	5-5	Logarithmic			
Display (Flowchart).....	1654	..	5-4	Curve w/Axes.....	1257	..	5-3
Screen.....	1097	..	5-4	Grids.....	.....	..	5-2
w/F-Keys Enlarged.....	1263	..	5-4	Magnetic Tape (Flowchart).....	1662	..	5-4
w/Function Keys.....	1264	..	5-4	Manual Input (Flowchart).....	1921	..	5-4
Cartesian Coordinate Axes.....	.....	..	5-2	Manual Operation (Flowchart).....	1916	..	5-4
Chair				Merge (Flowchart).....	1918	..	5-4
Conference (Layout).....	1692	..	5-6	Modem			
Executive Swivel (Layout).....	1292	..	5-6	Flowchart.....	1665	..	5-5
Secretary's (Layout).....	1552	..	5-6	Multiport (Flowchart).....	1670	..	5-5
Side Chair (Layout).....	1293	..	5-6	Multiplexer			
Charts				Flowchart.....	1671	..	5-5
Organizational.....	.....	..	5-1	Inverse (Flowchart).....	2019	..	5-5
Pie, Bar and Line.....	.....	..	5-2	Multiport Modem (Flowchart).....	1670	..	5-5
Communication				Networks.....	.....	..	5-7
Links.....	.....	..	5-5	Node (Flowchart).....	1980	..	5-5
Flowcharts.....	.....	..	5-5	Off-Page Connector (Flowchart).....	1924	..	5-4
Comparison (Flowchart).....	1004	..	5-4	Office Layout.....	.....	..	5-6
Conference Chair (Layout).....	1692	..	5-6	On-Line Storage (Flowchart).....	1658	..	5-4
Conference Table (Layout).....	1940	..	5-6	On-Page Connector (Flowchart).....	1980	..	5-4
Table w/6 Chairs.....	1698	..	5-6	Organizational Charts.....	.....	..	5-1
Table w/8 Chairs.....	2051	..	5-6	Output (Flowchart).....	1915	..	5-4
Connector				PBX (Flowchart).....	1677	..	5-5
Off-Page (Flowchart).....	1924	..	5-4	Packet (Flowchart).....	1001	..	5-5
On-Page (Flowchart).....	1980	..	5-4	Parabola w/Axes.....	1258	..	5-3
Coupler, Acoustic (Flowchart).....	1674	..	5-5	Pie Charts.....	.....	..	5-3
Data Access Arrangement.....	1672	..	5-5	Polar Coordinate Axes.....	.....	..	5-2
Flowcharts.....	.....	..	5-5	Polled Terminal (Flowchart).....	1675	..	5-2
Data Processing.....	.....	..	5-4	Preparation (Flowchart).....	1917	..	5-4
Decision (Flowchart).....	1920	..	5-4	Printout (Flowchart).....	1655	..	5-4
Desks				Process.....	1669	..	5-4
Ensemble (Layout).....	1294	..	5-6	Punched Card (Flowchart).....	1652	..	5-4
Secretary's (Layout).....	1290	..	5-6	Punched Tape (Flowchart).....	1657	..	5-4
Secretary's w/Chair (Layout).....	1291	..	5-6	Reference Point (Flowchart).....	1116	..	5-4
Direction Arrow (Flowchart).....	1666	..	5-5	Remote Batch Terminal.....	1678	..	5-5
Disc Storage (Flowchart).....	1914	..	5-4	Rotary (Flowchart).....	2024	..	5-5
Display.....	1654	..	5-4	Round Table w/Chairs (Layout).....	1693	..	5-6
EDP				Satellite (Flowchart).....	2022	..	5-5
Flowcharts.....	.....	..	5-4	Screen			
Printout (Flowchart).....	1655	..	5-4	w/Function Keys.....	1264	..	5-4
Earth Station (Flowchart).....	1145	..	5-5	w/Function Keys Enlarged.....	1263	..	5-4
Exponential				Screen, CRT.....	1097	..	5-4
w/Axes.....	1255	..	5-3	Sofa			
Inverse w/Axes.....	1256	..	5-3	2 Cushion (Layout).....	1289	..	5-6
Extract (Flowchart).....	1003	..	5-4	3 Cushion (Layout).....	1551	..	5-6
Flowcharts, DP.....	.....	..	5-4	Sort (Flowchart).....	1919	..	5-4
Function Keys				Storage			
on Screen.....	1264	..	5-4	Disc (Flowchart).....	1914	..	5-4
10.....	2678	..	5-4	On-Line (Flowchart).....	1658	..	5-4
8.....	2677	..	5-4	Tables, Office (Layout).....	.....	..	5-6
Enlarged.....	1263	..	5-4	Tape			
Functions				Magnetic (Flowchart).....	1662	..	5-4
w/Axes Bell.....	1251	..	5-3	Punched (Flowchart).....	1657	..	5-4
w/Axes Cubic.....	1253	..	5-3	Transmittal (Flowchart).....	1923	..	5-4
w/Axes Cubic, Inflection.....	1252	..	5-3	Telephone (Flowchart).....	2021	..	5-5
w/Axes Exponential.....	1255	..	5-3	Teleprinter (Flowchart).....	2020	..	5-5
w/Axes Inverse Exponential.....	1256	..	5-3	Terminal Interrupt (Flowchart).....	1656	..	5-4
w/Axes Logarithmic.....	1257	..	5-3	Terminals			
w/Axes Parabolic.....	1258	..	5-3	Display (Flowchart).....	2023	..	5-5
Gaussian Curve w/Axes.....	1251	..	5-3	Polled (Flowchart).....	1675	..	5-5
Grids (Circular).....	.....	..	5-2	Remote Batch (Flowchart).....	1678	..	5-5
				Test Equipment (Flowchart).....	1656	..	5-5



---

*Applications, continued*

---

Description	Number	Lib.	Page
Transmittal Tape (Flowchart) .....	1923	..	5-4
Video Screen .....	1097	..	5-4
Work Stations (Layout) .....	.....	..	5-6
X-Axes			
12 Months .....	4192	..	5-2
24 Months .....	4193	..	5-2
53 Weeks .....	4194	..	5-2

## Optional Library #4, Electronics & Logic

Description	Number	Lib.	Page	Description	Number	Lib.	Page
Acoustics				Diode, Zener (1 Dir Brkdw)	1383	4	5-13
Bell	3563	4	5-6	Diode, Zener (2 Dir Brkdw)	1382	4	5-13
Buzzer	1347	4	5-16	Rectifier, Bridge-Type (Full Wave)	1310	4	5-16
Earphones/Headset	1346	4	5-16	Thyristor, DIAC	1385	4	5-13
Jack	1336	4	5-16	Thyristor, TRIAC	1386	4	5-13
Microphone	1351	4	5-16	Direction of Flow			
Pick-Up Head	3553	4	5-16	One Way	3727	4	5-11
Rectifier, Bridge-Type (Full Wave)	1310	4	5-16	Either Way	3728	4	5-11
Speaker	1340	4	5-16	Both Ways	3729	4	5-11
Telephone	3564	4	5-16	Directional Coupler	3721	4	5-17
Amplifier	2807	4	5-16	Discontinuity, One Port	3558	4	5-17
Amplifier, Operational	1326	4	5-16	Discontinuity, Two Port	3559	4	5-17
Antennas				Earphones/Headset	1346	4	5-16
Antenna	1338	4	5-12	Electron Tubes			
Antenna, Dipole	1345	4	5-12	Cathode Ray Tube	2151	4	5-16
Antenna, Loop	1349	4	5-12	Electron Tube, Cold Cathode	2146	4	5-15
Armature, Rotating	3569	4	5-15	Electron Tube, Diode	2844	4	5-16
Armature, Rotating	3570	4	5-15	Electron Tube, Mercury Pool	2844	4	5-16
Balun	3730	4	5-17	Electron Tube, Pentode	2150	4	5-16
Battery	1333	4	5-12	Electron Tube, Photo Diode	2147	4	5-16
Bell	3563	4	5-16	Electron Tube, Thyatron	2827	4	5-16
Bimetallic Strip	1350	4	5-11	Electron Tube, Triode	2828	4	5-16
Buffer	1325	4	5-18	Electron Tube, Twin Triode	2826	4	5-16
Bus Driver w/Navel	1990	4	5-18	Traveling Wave Tube, Forward	3594	4	5-16
Buzzer	1347	4	5-16	Traveling Wave Tube, Backward	3595	4	5-16
Cables				E-Plane Coupling Symbols			
2 Conductor w/Ground Shield	1372	4	5-11	Ferrite Bead Ring	3740	4	5-17
Shielded	1337	4	5-11	Flip-Flop	2839	4	5-18
Capacitors (see also Resistors)				Flip-Flop	2840	4	5-18
Cathode Ray Tube	2151	4	5-16	Flow Actuated Switches			
Circuit Breaker	2823	4	5-13	Fuse	1988	4	5-13
Circuits, Integretors (see also Relays)				Gates			
Circuits, Integretors (see Logic & Integrated Circuits)				AND	1317	4	5-18
Closed Contact Switch	2816	4	5-12	AND Inverted Input	1321	4	5-18
Connectors, Terminals & Junctions				AND 1 Inverted Input	1360	4	5-18
Connector, Female	1364	4	5-11	AND 3 Input/2 Inverted Inputs	3733	4	5-18
Connector, Male	1367	4	5-11	AND 4 Input/3 Inverted Inputs	3734	4	5-18
Connectors, Engaged	1365	4	5-11	NAND	1320	4	5-18
Ground, Chassis	1330	4	5-11	NOR	1322	4	5-18
Ground, Earth	1329	4	5-11	OR	1318	4	5-18
Junction	3552	4	5-11	OR Inverted Inputs	1319	4	5-18
Junction	3551	4	5-11	OR 1 Inverted Input	1361	4	5-18
Terminal	3704	4	5-11	OR 3 Inverted Inputs	3735	4	5-18
Terminals	3705	4	5-11	OR 4 Input/2 Inverted Inputs	3736	4	5-18
Contact (Normally Closed)	2832	4	5-13	XOR	1323	4	5-18
Contact (Normally Open)	2831	4	5-13	Generators			
Couplings				AC	3581	4	5-15
Crystal, Piezoelectric	1339	4	5-11	DC	3580	4	5-15
Current Source	1334	4	5-12	Regulating	3567	4	5-15
Current Source, Constant	1352	4	5-12	Regulating	3568	4	5-15
Darlington Transistors				Ground			
NPN	2176	4	5-14	Chassis	1330	4	5-11
PNP	2175	4	5-14	Earth	1329	4	5-11
Data Line	1344	4	5-18	Hybrid	3724	4	5-17
Data Lines	1345	4	5-18	IGFET Transistors			
DIP Header	2842	4	5-18	N Chnl	1395	4	5-14
Diodes				N Chnl, D Mode, 3 Trml	1393	4	5-14
Diode	1377	4	5-13	N Chnl, D Mode, 4 Trml	1275	4	5-14
Diode	1309	4	5-13	N Chnl, E Mode	3746	4	5-14
Diode, Field-Effect	1376	4	5-13	N Chnl, E Mode, 4 Trml	1397	4	5-14
Diode (LED)	1373	4	5-14	P Chnl	1396	4	5-14
Diode, SAS	2177	4	5-13	P Chnl, D Mode, 3 Trml	1394	4	5-14
Diode, SBS	2174	4	5-13	P Chnl, D Mode, 4 Trml	1276	4	5-14
Diode, SCR	1381	4	5-13	P Chnl, E Mode	3747	4	5-14
Diode, Shockley	1380	4	5-13	P Chnl, E Mode, 4 Trml	1398	4	5-14
Diode, Shottky	1378	4	5-13	Illuminating Devices			
Diode, Step Recovery	1379	4	5-13	Diode (LED)	1373	4	5-14
Diode, SUS	2173	4	5-13	Electron Tube, Cold Cathode	2146	4	5-15
Diode, Tunnel Rectifier	1375	4	5-13	Lamp	2824	4	5-15
Diode, Tunnel Rectifier (Backward)	1374	4	5-13	Lamp	1335	4	5-15
Diode, Varactor	1384	4	5-13	Lamp, Fluorescent	2167	4	5-15
Diode, Zener (1 Dir Brkdw)	1311	4	5-13	Lamp, Incandescent	3726	4	5-15

## Optional Library #4, Electronics & Logic, continued

Description	Number	Lib.	Page	Description	Number	Lib.	Page
Lamp, Neon AC	2169	4	5-15	Integrated Circuit Sizing Box (16x16 Nodes)	2833	4	5-18
Lamp, Neon DC	2168	4	5-15	Inverter	1324	4	5-18
Inductors (see also Resistors)		4	5-11	Inverter	2808	4	5-18
Integrated Circuit Packaging (see also Logic)				Pin Out Integrated Circuit, Build-Up Segment	2843	4	5-18
4-Pin	1562	4	5-18	Timing Diagram 1	2835	4	5-18
8-Pin	1563	4	5-18	Timing Diagram 2	2836	4	5-18
12-Pin	1564	4	5-18	Timing Diagram 3	2837	4	5-18
14-Pin	1565	4	5-18	Timing Diagram 4	2838	4	5-18
16-Pin	1566	4	5-18	Tristate Buffer	2806	4	5-18
18-Pin	1567	4	5-18	Magnet	3557	4	5-11
20-Pin	1568	4	5-18	Make-Before-Break Switch (2 Pole)	3591	4	5-12
24-Pin	1569	4	5-18	Make-Before-Break Switch (3 Pole)	3592	4	5-12
28-Pin	1570	4	5-18	Microphone	1351	4	5-16
40-Pin	1571	4	5-18	Mode Suppressor	3722	4	5-17
48-Pin	1572	4	5-18	Mode Transducer, Transition	3723	4	5-17
Sizing Box (15x17 Nodes)	2834	4	5-18	MOSFET Transistors			
Sizing Box (16x16 Nodes)	2833	4	5-18	N Chnl, D Mode, 5 Trml	1984	4	5-14
Inverters		4	5-18	N Chnl, E Mode, 5 Trml	1986	4	5-14
Jack	1336	4	5-16	P Chnl, D Mode, 5 Trml	1985	4	5-14
JFET Transistors				P Chnl, E Mode, 5 Trml	1987	4	5-14
N Chnl	1314	4	5-14	Motors			
N Chnl	1391	4	5-14	AC	3579	4	5-15
P Chnl	1315	4	5-14	DC	3578	4	5-15
P Chnl	1392	4	5-14	Networks			
Junctions		4	5-11	LC	2178	4	5-11
Lamps				RL	2809	4	5-11
Lamp	2824	4	5-15	RC	2179	4	5-11
Lamp	1335	4	5-15	Open Contact Switch	1341	4	5-12
Lamp, Fluorescent	2167	4	5-15	Optoisolators			
Lamp, Incandescent	3726	4	5-15	w/Photodiode Output	1387	4	5-14
Lamp, Neon AC	2169	4	5-15	w/Phototransistor Output	1388	4	5-14
Lamp, Neon DC	2168	4	5-15	Photoresistor	1331	4	5-14
Limit Switches				Photo Semiconductor Devices			
Normally Closed	2829	4	5-12	Diode (LED)	1373	4	5-14
Normally Open	2830	4	5-12	Optoisolator w/Photodiode Output	1387	4	5-14
Liquid Actuated Switches (see also Switches)		4	5-12	Optoisolator w/Phototransistor Output	1388	4	5-14
Load	2818	4	5-11	Photoresistor	1331	4	5-14
Logic & Integrated Circuits				Phototransistor NPN (No Base Connection)	1389	4	5-14
Buffer	1325	4	5-18	Phototransistor NPN (w/Base Connection)	1390	4	5-14
Bus Driver w/Navel	1990	4	5-18	Photovoltaic Cell	1332	4	5-14
Data Line	1344	4	5-18	Phototransistors			
Data Lines	1345	4	5-18	NPN (No Base Connection)	1389	4	5-14
DIP Header	2842	4	5-18	NPN (w/Base Connection)	1390	4	5-14
Flip-Flop	2839	4	5-18	Photovoltaic Cell	1332	4	5-14
Flip-Flop	2840	4	5-18	Pick-Up Head	3553	4	5-16
Gate, AND	1317	4	5-18	Pin Out Integrated Circuit, Build-Up Segment	2843	4	5-18
Gate, AND Inverted Input	1321	4	5-18	Potentiometer	1366	4	5-11
Gate, AND 1 Inverted Input	1360	4	5-18	Rectifier, Bridge-Type (Full Wave)	1310	4	5-16
Gate, AND 3 Input/2 Inverted Inputs	3733	4	5-18	Regulating Generator	3567	4	5-15
Gate, AND 4 Input/3 Inverted Inputs	3734	4	5-18	Regulating Generator	3568	4	5-15
Gate, NAND	1320	4	5-18	Relay Coil	1354	4	5-11
Gate, NOR	1322	4	5-18	Relays, Selectors & Circuit Protectors			
Gate, OR	1318	4	5-18	Circuit Breaker	2823	4	5-13
Gate, OR Inverted Inputs	1319	4	5-18	Contact (Normally Closed)	2832	4	5-13
Gate, OR 1 Inverted Input	1361	4	5-18	Contact (Normally Open)	2831	4	5-13
Gate, OR 3 Input/2 Inverted Inputs	3735	4	5-18	Fuse	1988	4	5-13
Gate, OR 4 Input/3 Inverted Inputs	3736	4	5-18	Relay	2817	4	5-13
Gate, XOR	1323	4	5-18	Relay Contact, Closed	1355	4	5-13
Integrated Circuit, 4-Pin	1562	4	5-18	Relay Contact, SPDT	1091	4	5-13
Integrated Circuit, 8-Pin	1563	4	5-18	Relay Contact, SPDT (Break, Make)	1370	4	5-13
Integrated Circuit, 12-Pin	1564	4	5-18	Relay Contact, SPDT (Make, Break)	1371	4	5-13
Integrated Circuit, 14-Pin	1565	4	5-18	Relay Contact, SPST (Normally Closed)	1368	4	5-13
Integrated Circuit, 16-Pin	1566	4	5-18	Relay Contact, SPST (Normally Open)	1369	4	5-13
Integrated Circuit, 18-Pin	1567	4	5-18	Selector Switch, 3-Point	3588	4	5-13
Integrated Circuit, 20-Pin	1568	4	5-18	Selector Switch, 4-Point	3589	4	5-13
Integrated Circuit, 24-Pin	1569	4	5-18	Selector Switch, 5-Point	3590	4	5-13
Integrated Circuit, 28-Pin	1570	4	5-18	Selector Switch, 22-Point	3593	4	5-13
Integrated Circuit, 40-Pin	1571	4	5-18				
Integrated Circuit, 48-Pin	1572	4	5-18				
Integrated Circuit Sizing Box (15x17 Nodes)	2834	4	5-18				

## Optional Library #4, Electronics & Logic, continued

Description	Number	Lib.	Page	Description	Number	Lib.	Page
<b>Resistors, Capacitors &amp; Inductors</b>							
Capacitor	1303	4	5-11	Selector Switch, 5-Point	3590	4	5-13
Capacitor	3706	4	5-11	Selector Switch, 22-Point	3593	4	5-13
Capacitor, Electrolytic	1304	4	5-11	Temperature Actuated		4	5-12
Capacitor, Variable	3707	4	5-11	Thermostat	2172	4	5-12
Crystal, Piezoelectric	1339	4	5-11	Time-Delay Closing (Open)	2811	4	5-12
Inductor, Air-Core	1305	4	5-11	Time-Delay Closing (Closed)	2813	4	5-12
Inductor, Iron-Core	2171	4	5-11	Time-Delay Opening (Closed)	2812	4	5-12
Inductor, Variable	1306	4	5-11	Transfer Switch	3555	4	5-12
Load	2818	4	5-11	Transfer Switch	3556	4	5-12
Magnet	3557	4	5-11	Telephone	3564	4	5-16
Network, LC	2178	4	5-11	Temperature Actuated Switches (see also Switches)		4	5-12
Network, RL	2809	4	5-11	Terminal	3704	4	5-11
Network, RC	2179	4	5-11	Terminals	3705	4	5-11
Photoresistor	1331	4	5-14	Thermistor	1353	4	5-11
Potentiometer	1366	4	5-11	Thermostat	2172	4	5-12
Relay Coil	1354	4	5-11	Thyristors			
Resistor	1301	4	5-11	DIAC	1385	4	5-13
Resistor	3547	4	5-11	TRIAC	1386	4	5-13
Resistor, Adjustable	3549	4	5-11	Time-Delay Switches (see also Switches)		4	5-12
Resistor, Variable	1302	4	5-11	Timing Diagrams		4	5-18
Resistor, Variable	3548	4	5-11	Transfer Switches (see also Switches)		4	5-12
Thermistor	1353	4	5-11	<b>Transformers</b>			
Transformer, Air-Core	1308	4	5-11	Air-Core	1308	4	5-11
Transformer, Delta	3731	4	5-16	Delta	3731	4	5-16
Transformer, Iron-Core	1307	4	5-11	Iron-Core	1307	4	5-11
Transformer, Wye	3732	4	5-16	Wye	3732	4	5-16
Resonator, Tuned Cavity	3596	4	5-17	<b>Transistors</b>			
Rotary Joint	3725	4	5-17	Darlington NPN	2176	4	5-14
Rotating Armature	3569	4	5-15	Darlington PNP	2175	4	5-14
Rotating Armature	3570	4	5-15	IGFET (N Chnl)	1395	4	5-14
<b>Rotating Machinery</b>				IGFET (N Chnl, D Mode, 3 Trml)	1393	4	5-14
1 Phase	3571	4	5-15	IGFET (N Chnl, D Mode, 4 Trml)	1275	4	5-14
2 Phase	3572	4	5-15	IGFET (N Chnl, E Mode)	3746	4	5-14
3 Phase Delta	3575	4	5-15	IGFET (N Chnl, E Mode, 4 Trml)	1397	4	5-14
3 Phase Regulator	3565	4	5-15	IGFET (P Chnl)	1396	4	5-14
3 Phase Regulator	3566	4	5-15	IGFET (P Chnl, D Mode, 3 Trml)	1394	4	5-14
3 Phase Wye	3573	4	5-15	IGFET (P Chnl, D Mode, 4 Trml)	1276	4	5-14
3 Phase Wye, Grounded	3574	4	5-15	IGFET (P Chnl, E Mode)	3747	4	5-14
6 Phase Diametric	3576	4	5-15	IGFET (P Chnl, E Mode, 4 Trml)	1398	4	5-14
6 Phase Double Delta	3577	4	5-15	JFET (N Chnl)	1314	4	5-14
Generator, AC	3581	4	5-15	JFET (N Chnl)	1391	4	5-14
Generator, DC	3580	4	5-15	JFET (P Chnl)	1315	4	5-14
Motor, AC	3579	4	5-15	JFET (P Chnl)	1392	4	5-14
Motor, DC	3578	4	5-15	MOSFET (N Chnl, D Mode, 5 Trml)	1984	4	5-14
Regulating Generator	3567	4	5-15	MOSFET (N Chnl, E Mode, 5 Trml)	1986	4	5-14
Regulating Generator	3568	4	5-15	MOSFET (P Chnl, D Mode, 5 Trml)	1985	4	5-14
Rotating Armature	3569	4	5-15	MOSFET (P Chnl, E Mode, 5 Trml)	1987	4	5-14
Rotating Armature	3570	4	5-15	NPN	1312	4	5-14
Winding Build-Up Symbols		4	5-15	Phototransistor NPN (No Base Connection)	1389	4	5-14
<b>Selector Switches</b>				Phototransistor NPN (w/Base Connection)	1390	4	5-14
3-Point	3588	4	5-13	PNP	1313	4	5-14
4-Point	3589	4	5-13	Programmable Unijunction	1362	4	5-14
5-Point	3590	4	5-13	Unijunction	1316	4	5-14
22-Point	3593	4	5-13	<b>Traveling Wave Tubes</b>			
SHF Components (see also VHF)		4	5-17	Forward	3594	4	5-16
<b>Signal Sources</b>				Backward	3595	4	5-16
Sine Wave (AC)	1328	4	5-12	Tristate Buffer	2806	4	5-18
Square Wave (Pulse)	1327	4	5-12	<b>Tuners</b>			
Speaker	1340	4	5-16	E-H	3562	4	5-17
<b>Switches</b>				Multistub	3561	4	5-17
Bimetallic Strip	1350	4	5-11	Slide Screw	3560	4	5-17
Closed Contact	2816	4	5-12	<b>UHF Components (see also VHF)</b>		4	5-17
Flow Actuated		4	5-12	<b>VHF, UHF &amp; SHF Circuit Components</b>			
Limit (Normally Closed)	2829	4	5-12	Balun	3730	4	5-17
Limit (Normally Open)	2830	4	5-12	Couplings		4	5-17
Liquid Actuated		4	5-12	Directional Coupler	3721	4	5-17
Make-Before-Break (2 Pole)	3591	4	5-12	Discontinuity, One Port	3558	4	5-17
Make-Before-Break (3 Pole)	3592	4	5-12	Discontinuity, Two Port	3559	4	5-17
Open Contact	1341	4	5-12	E-Plane Coupling Symbols		4	5-17
Selector Switch, 3-Point	3588	4	5-13				
Selector Switch, 4-Point	3589	4	5-13				

---

**Optional Library #4, Electronics & Logic, continued**

---

Description	Number	Lib.	Page
Ferrite Bead Ring .....	3740	4	5-17
Hybrid .....	3724	4	5-17
Mode Suppressor .....	3722	4	5-17
Mode Transducer, Transition .....	3723	4	5-17
Resonator, Tuned Cavity .....	3596	4	5-17
Rotary Joint .....	3725	4	5-17
Tuner, E-H .....	3562	4	5-17
Tuner, Multistub .....	3561	4	5-17
Tuner, Slide Screw .....	3560	4	5-17
Voltage Source, DC .....	1363	4	5-12
Winding Build-Up Symbols .....	.....	4	5-15

## Optional Library #5, EDP Equipment

Description	Number Lib. Page
Acoustic Couplers	
General Symbol	5 5-27
HP 82168A	5 5-27
Bar Code Reader (HP 92911A)	5 5-27
Calculators	
HP 75	5 5-19
HP C	5 5-19
HP 41CX	5 5-19
Computer Forms	5 5-27
Computer Systems	
HP 1000 Model 6	5 5-21
HP 1000 Micro/1000	5 5-21
HP 3000/37	5 5-22
HP 3000/37 Cabinet	5 5-22
HP 3000/40	5 5-22
HP 3000/64	5 5-22
Computer Terminal (HP 2623A)	5 5-19
Computers, Desktop	
HP 9000/216 Personal Computer	5 5-20
HP 9000/217 Technical Computer	5 5-20
HP 9000/236 Technical Computer	5 5-20
HP 9000/500 Technical Computer	5 5-21
Computers, Personal	
Apple Macintosh	5 5-28
HP 110 Portable Computer	5 5-19
HP 150	5 5-19
HP 150 without Keyboard	5 5-19
HP 150 Keyboard only	5 5-19
IBM PC	5 5-28
IBM XT	5 5-28
IBM AT	5 5-28
Data Acquisition (HP 3421A)	5 5-27
Digital Multimeter (HP 3468A)	5 5-27
Discs	
5¼ Inch (HP 92190A)	5 5-23
3½ Inch (HP 92191A)	5 5-23
Drives, Disc and Tape	
HP 7914 Disc Drive	5 5-21
HP 7933 Disc Drive	5 5-22
HP 7978 Tape Drive	5 5-22
HP 9114 3½ Inch Disc Drive	5 5-23
HP 9121 3½ Inch Disc Drive	5 5-23
HP 9133 Winchester Drive	5 5-23
HP 9134 Winchester Drive	5 5-23
HP 82901M 5¼ Inch Disc Drive	5 5-23
Graphics Tablet (HP 9111A)	5 5-25
Input Documents	5 5-27
Modem	5 5-27
Plotters	
HP 7470A	5 5-24
HP 7475A	5 5-24
HP 7550A	5 5-25
HP 7580	5 5-25
Printers	
General Symbol	5 5-27
HP 2225A ThinkJet	5 5-26
HP 2602A Printer	5 5-26
HP 2671A Printer	5 5-26
HP 2680A Laser Printer	5 5-27
HP 2686A LaserJet	5 5-26
HP 2933A Printer	5 5-26
HP 82905 Printer	5 5-26
Switch (HP 92178S)	5 5-27
Telephone	5 5-27
TV Monitor	5 5-27
Video Interface (HP 82163)	5 5-27

## Optional Library #6, Pipe Fittings & Valves

Description	Number	Lib.	Page	Description	Number	Lib.	Page
Adjustable Choke Valve (Screwed)	8597	6	5-34	Piston Operated, Flanged	8608	6	5-34
Adjustable Choke Valve (Flanged)	8598	6	5-34	Piston Operated, Screwed	8607	6	5-34
Angle Valve, Check				w/Handwheel, Flanged	8626	6	5-35
Bell and Spigot	8513	6	5-32	w/Handwheel, Screwed	8625	6	5-35
Flanged	8511	6	5-32	Cross Valve, Straight Size			
Screwed	8512	6	5-32	Bell and Spigot	8409	6	5-29
Soldered	8515	6	5-32	Flanged	8407	6	5-29
Welded	8514	6	5-32	Screwed	8408	6	5-29
Angle Valve, Gate (Elevation)				Soldered	8411	6	5-29
Flanged	8516	6	5-32	Welded	8410	6	5-29
Screwed	8517	6	5-32	Crossover Valve (Bell and Spigot)	8413	6	5-29
Welded	8518	6	5-32	Crossover Valve (Screwed)	8412	6	5-29
Angle Valve, Gate (Plan)				Diaphragm Seal (Flanged)	8656	6	5-36
Flanged	8519	6	5-32	Diaphragm Seal (Screwed)	8655	6	5-36
Screwed	8520	6	5-32	Diaphragm Valve (Flanged)	8543	6	5-33
Welded	8521	6	5-32	Diaphragm Valve (Screwed)	8544	6	5-33
Angle Valve, Globe (Elevation)				Drain Valve on Main Body (Flanged)	8612	6	5-34
Flanged	8522	6	5-32	Drain Valve on Main Body (Screwed)	8611	6	5-34
Screwed	8523	6	5-32	Elbow, Base			
Soldered	8525	6	5-32	Bell and Spigot	8436	6	5-30
Welded	8524	6	5-32	Flanged	8434	6	5-30
Angle Valve, Globe (Plan)				Screwed	8435	6	5-30
Flanged	8526	6	5-32	Elbow, Double Branch (Flanged)	8437	6	5-30
Screwed	8527	6	5-32	Elbow, Double Branch (Screwed)	8438	6	5-30
Soldered	8529	6	5-32	Elbow, 45-Degree			
Welded	8528	6	5-32	Bell and Spigot	8416	6	5-29
Atmospheric Vent	8684	6	5-37	Flanged	8414	6	5-29
Automatic Valve				Screwed	8415	6	5-29
Bypass	8530	6	5-32	Soldered	8418	6	5-29
Governor Operated	8531	6	5-32	Welded	8417	6	5-29
Reducing	8532	6	5-32	Elbow, Long Radius			
Ball Valve (Flanged)	8584	6	5-37	Flanged	8439	6	5-30
Ball Valve (Screwed)	8583	6	5-37	Screwed	8440	6	5-30
Bleed Ring (Flanged)	8646	6	5-36	Elbow, 90-Degree			
Bleed Ring (Screwed)	8645	6	5-36	Flanged	8419	6	5-29
Breather	8660	6	5-37	Screwed	8420	6	5-29
Bushing				Bell and Spigot	8421	6	5-29
Bell and Spigot	8402	6	5-29	Welded	8422	6	5-29
Screwed	8401	6	5-29	Soldered	8423	6	5-29
Soldered	8404	6	5-29	Elbow, Side Outlet (Outlet Down)			
Welded	8403	6	5-29	Bell and Spigot	8443	6	5-30
Butterfly Valve (Flanged)	8590	6	5-34	Flanged	8441	6	5-30
Butterfly Valve (Screwed)	8589	6	5-34	Screwed	8442	6	5-30
Cap (Bell and Spigot)	8406	6	5-29	Elbow, Side Outlet (Outlet Up)			
Cap (Screwed)	8405	6	5-29	Bell and Spigot	8446	6	5-30
Check Valve				Flanged	8444	6	5-30
Flanged	8588	6	5-34	Screwed	8445	6	5-30
Flanged	8663	6	5-34	Elbow, Street	8447	6	5-30
Screwed	8587	6	5-34	Elbow, Turned Down			
Screwed	8662	6	5-34	Bell and Spigot	8426	6	5-29
Check Valve (Straight Way)				Flanged	8424	6	5-29
Bell and Spigot	8535	6	5-32	Screwed	8425	6	5-29
Flanged	8533	6	5-32	Soldered	8428	6	5-29
Screwed	8534	6	5-32	Welded	8427	6	5-29
Soldered	8537	6	5-32	Elbow, Turned Up			
Welded	8536	6	5-32	Bell and Spigot	8431	6	5-29
Closed Drain	8634	6	5-37	Flanged	8429	6	5-29
Cock				Screwed	8430	6	5-29
Bell and Spigot	8540	6	5-33	Soldered	8433	6	5-29
Flanged	8538	6	5-33	Welded	8432	6	5-29
Screwed	8539	6	5-33	Equalizing Valve on Main Body (Flanged)	8614	6	5-35
Soldered	8542	6	5-33	Equalizing Valve on Main Body (Screwed)	8613	6	5-35
Welded	8541	6	5-33	Expansion Joint	8652	6	5-36
Control Valve				Flame or Stack Arrestor	8658	6	5-37
Diaphragm, Flanged	8604	6	5-34	Flexible Hose w/Hose Connection	8651	6	5-36
Diaphragm, Screwed	8603	6	5-34	Float Operated Valve (Flanged)	8687	6	5-35
Hand Operated, Flanged	8610	6	5-34	Float Operated Valve (Screwed)	8686	6	5-35
Hand Operated, Screwed	8609	6	5-34	Float Valve			
Misc. Operated	8621	6	5-35	Flanged	8545	6	5-33
Misc. Operated	8622	6	5-35	Screwed	8546	6	5-33
Motor Operated, Flanged	8606	6	5-34	Soldered	8548	6	5-33
Motor Operated, Screwed	8605	6	5-34	Welded	8547	6	5-33

## Optional Library #6, Pipe Fittings & Valves, continued

Description	Number	Lib.	Page	Description	Number	Lib.	Page
Four-Way Valve (Flanged)	8602	6	5-34	Screwed	8591	6	5-35
Four-Way Valve (Screwed)	8601	6	5-34	Screwed	8664	6	5-35
Gate Valve				Open Drain	8632	6	5-37
Bell and Spigot	8551	6	5-33	Open Drain w/Liquid Seal	8633	6	5-37
Flanged	8549	6	5-33	Orifice Flange	8461	6	5-29
Screwed	8550	6	5-33	Pinch Valve (Flanged)	8689	6	5-35
Soldered	8553	6	5-33	Pinch Valve (Screwed)	8688	6	5-35
Welded	8552	6	5-33	Plug, Bull (Bell and Spigot)	8464	6	5-30
Gate Valve, Motor Operated				Plug, Bull (Flanged)	8463	6	5-30
Flanged	8554	6	5-33	Plug, Pipe (Bell and Spigot)	8466	6	5-30
Screwed	8555	6	5-33	Plug, Pipe (Screwed)	8465	6	5-30
Welded	8556	6	5-33	Plug Cock Valve (Flanged)	8675	6	5-35
Globe Valve				Plug Cock Valve (Screwed)	8674	6	5-35
Bell and Spigot	8559	6	5-33	Plug Valve (Flanged)	8586	6	5-34
Flanged	8557	6	5-33	Plug Valve (Screwed)	8585	6	5-34
Screwed	8558	6	5-33	Plugged Connection	8630	6	5-37
Soldered	8561	6	5-33	Pressure Regulator, Self-Cont. (Flanged)	8620	6	5-35
Welded	8560	6	5-33	Pressure Regulator, Self-Cont. (Screwed)	8619	6	5-35
Globe Valve, Motor Operated				Pressure Regulator w/Pres. Tap (Flanged)	8624	6	5-35
Flanged	8562	6	5-34	Pressure Regulator w/Pres. Tap (Screwed)	8623	6	5-35
Screwed	8563	6	5-34	Pressure Safety Valve			
Welded	8564	6	5-34	Flanged	8596	6	5-34
Hose Valve				Pilot Operated, Flanged	8628	6	5-35
Angle (Flanged)	8565	6	5-33	Pilot Operated, Screwed	8627	6	5-35
Angle (Screwed)	8566	6	5-33	Screwed	8595	6	5-34
Gate (Flanged)	8567	6	5-33	Pulsation Dampener (Flanged)	8650	6	5-36
Gate (Screwed)	8568	6	5-33	Pulsation Dampener (Screwed)	8649	6	5-36
Globe (Flanged)	8569	6	5-33	Quick Break Connection (Flanged)	8648	6	5-37
Globe (Screwed)	8570	6	5-33	Quick Break Connection (Screwed)	8647	6	5-37
Integral Regulating Valve (Flanged)	8669	6	5-35	Quick Opening Valve			
Integral Regulating Valve (Screwed)	8668	6	5-35	Flanged	8574	6	5-34
Joint, Connecting Pipe				Flanged	8695	6	5-36
Bell and Spigot	8450	6	5-30	Screwed	8575	6	5-34
Flanged	8448	6	5-30	Screwed	8694	6	5-36
Screwed	8449	6	5-30	Soldered	8577	6	5-34
Soldered	8452	6	5-30	Welded	8576	6	5-34
Welded	8451	6	5-30	Reducer, Concentric			
Joint, Expansion				Bell and Spigot	8469	6	5-31
Bell and Spigot	8455	6	5-30	Flanged	8467	6	5-31
Flanged	8453	6	5-30	Screwed	8468	6	5-31
Screwed	8454	6	5-30	Soldered	8471	6	5-31
Soldered	8457	6	5-30	Welded	8470	6	5-31
Welded	8456	6	5-30	Reducer, Eccentric			
Lateral Valve				Bell and Spigot	8474	6	5-31
Bell and Spigot	8460	6	5-30	Flanged	8472	6	5-31
Flanged	8458	6	5-30	Screwed	8473	6	5-31
Screwed	8459	6	5-30	Soldered	8476	6	5-31
Line Blind				Welded	8475	6	5-31
Closed	8678	6	5-36	Reducing Flange	8462	6	5-29
Closed	8679	6	5-36	Relief Valve (Flanged)	8671	6	5-36
Open	8676	6	5-36	Relief Valve (Screwed)	8670	6	5-36
Open	8677	6	5-36	Rupture Disc Valve			
Line Size Change	8631	6	5-37	Flanged	8654	6	5-35
Line Type Symbols				Flanged	8673	6	5-35
Air Line	8696	6	5-37	Screwed	8653	6	5-35
Branch and Head	8707	6	5-37	Screwed	8672	6	5-35
Capillary Tubing	8698	6	5-37	Safety Valve			
Feedwater Pump Discharge	8703	6	5-37	Bell and Spigot	8580	6	5-33
High Pressure Return	8704	6	5-37	Flanged	8578	6	5-33
Medium Pressure Return	8705	6	5-37	Screwed	8579	6	5-33
Medium Pressure Steam	8706	6	5-37	Soldered	8582	6	5-33
Vacuum Pump Discharge	8702	6	5-37	Welded	8581	6	5-33
Lockshield Valve				Sleeve			
Flanged	8571	6	5-32	Bell and Spigot	8479	6	5-31
Screwed	8572	6	5-32	Flanged	8477	6	5-31
Welded	8573	6	5-32	Screwed	8478	6	5-31
Manually Operated Valve (Flanged)	8667	6	5-35	Soldered	8481	6	5-31
Manually Operated Valve (Screwed)	8666	6	5-35	Welded	8480	6	5-31
Mechanical Specialty Item	8657	6	5-36	Solenoid Operated Valve (Flanged)	8618	6	5-35
Needle Valve				Solenoid Operated Valve (Screwed)	8617	6	5-35
Flanged	8592	6	5-35	Spacer Ring (Flanged)	8644	6	5-36
Flanged	8665	6	5-35	Spacer Ring (Screwed)	8643	6	5-36



**Optional Library #6, Pipe Fittings & Valves, continued**

Description	Number Lib. Page	Description	Number Lib. Page
Spectacle Blind Valve (Flanged)	8642 6 5-36	Y-Valve (Screwed)	8690 6 5-36
Spectacle Blind Valve (Screwed)	8641 6 5-36		
Steam Trap	8661 6 5-35		
Stopcheck Valve (Flanged)	8594 6 5-34		
Stopcheck Valve (Screwed)	8593 6 5-34		
Strainer			
Basket (Flanged)	8638 6 5-36		
Basket (Screwed)	8637 6 5-36		
General Symbol (Screwed)	8680 6 5-36		
General Symbol (Flanged)	8681 6 5-36		
Temporary Start-Up (Flanged)	8636 6 5-36		
Temporary Start-Up (Screwed)	8635 6 5-36		
Y-Type (Flanged)	8640 6 5-36		
Y-Type (Flanged)	8683 6 5-36		
Y-Type (Screwed)	8639 6 5-36		
Y-Type (Screwed)	8682 6 5-36		
Tee, Double Sweep (Flanged)	8497 6 5-31		
Tee, Double Sweep (Screwed)	8498 6 5-31		
Tee, Outlet Down			
Bell and Spigot	8494 6 5-31		
Flanged	8492 6 5-31		
Screwed	8493 6 5-31		
Soldered	8496 6 5-31		
Welded	8495 6 5-31		
Tee, Outlet Up			
Bell and Spigot	8489 6 5-31		
Flanged	8487 6 5-31		
Screwed	8488 6 5-31		
Soldered	8491 6 5-31		
Welded	8490 6 5-31		
Tee, Side Outlet (Outlet Down)			
Bell and Spigot	8503 6 5-32		
Flanged	8501 6 5-31		
Screwed	8502 6 5-32		
Tee, Side Outlet (Outlet Up)			
Bell and Spigot	8506 6 5-32		
Flanged	8504 6 5-32		
Screwed	8505 6 5-32		
Tee, Single Sweep (Flanged)	8499 6 5-31		
Tee, Single Sweep (Screwed)	8500 6 5-31		
Tee, Straight Size			
Bell and Spigot	8484 6 5-31		
Flanged	8482 6 5-31		
Screwed	8483 6 5-31		
Soldered	8486 6 5-31		
Welded	8485 6 5-31		
Thief Hatch	8659 6 5-37		
Three-Way Spring Return Valve (Flanged)	8616 6 5-35		
Three-Way Spring Return Valve (Screwed)	8615 6 5-35		
Three-Way Valve (Flanged)	8600 6 5-34		
Three-Way Valve (Screwed)	8599 6 5-34		
Tokens			
Bell and Spigot	8450 6 5-37		
Buttweld	8699 6 5-37		
Compression	8700 6 5-37		
Flanged	8448 6 5-37		
Line Break	8697 6 5-37		
Screwed	8449 6 5-37		
Socketweld	8629 6 5-37		
Soldered	8452 6 5-37		
Swivel	8701 6 5-37		
Welded	8451 6 5-37		
Union			
Flanged	8507 6 5-30		
Screwed	8508 6 5-30		
Soldered	8510 6 5-30		
Welded	8509 6 5-30		
V-Port Valve (Flanged)	8693 6 5-36		
V-Port Valve (Screwed)	8692 6 5-36		
Vent, Atmospheric	8684 6 5-37		
Vent, Specialty	8685 6 5-37		
Y-Valve (Flanged)	8691 6 5-36		

## Optional Library #12, Pulp & Paper Process Flow

Description	Number	Lib.	Page	Description	Number	Lib.	Page
Agitator	3828	12	5-38	Dryer Section	3888	12	5-39
Batch Digester	3893	12	5-40	Foil (2 Blades)	3808	12	5-39
Bell Bond Unit	3838	12	5-39	Foil (3 Blades)	3807	12	5-39
Blind Flange	3880	12	5-39	Foil (4 Blades)	3802	12	5-39
Blow Tank	3856	12	5-40	Foil (5 Blades)	3804	12	5-39
Blower	3890	12	5-38	Forming Board (3 Blades)	3805	12	5-39
Boiler	3877	12	5-40	Forming Board (4 Blades)	3806	12	5-39
Causticizer	3861	12	5-40	Fourdrinier	3825	12	5-39
Check Valve	8534	12	5-39	Fourdrinier	3860	12	5-39
Chlorine Dioxide Tower	3826	12	5-40	Headbox	3801	12	5-39
Clarifier	3892	12	5-40	Headbox	3883	12	5-39
Cleaner	3833	12	5-38	Headbox, Primary	3895	12	5-39
Cleaner	3835	12	5-38	Headbox, Secondary	3863	12	5-39
Cleaner	3866	12	5-38	Orthoflow (7 Blades)	3811	12	5-39
Condensate Pump and Separator	3824	12	5-38	Orthoflow (9 Blades)	3809	12	5-39
Continuous Digester	3853	12	5-40	Orthoflow (11 Blades)	3810	12	5-39
Control Valve	8603	12	5-39	Pulper	3864	12	5-39
Control Valve Body	8550	12	5-39	Single Nip Press	3823	12	5-39
Conveyor	3881	12	5-39	Steam Box	3813	12	5-39
Cyclone	3897	12	5-38	Stockchest	3867	12	5-39
Deaerator	3882	12	5-40	Transfer Press	3831	12	5-39
Deculator	3817	12	5-38	Twinver Press Section	3887	12	5-39
Diffuser Wash	3854	12	5-38	Wet Box	3803	12	5-39
Disc Screen	3879	12	5-38	Wire Pit	3837	12	5-39
Dregs Washer	3871	12	5-40	Pil or Motor Valve	8621	12	5-39
Drum Debarker	3846	12	5-40	Pil Valve	3845	12	5-39
Drum Washers	3819	12	5-38	Pipe Cap	3869	12	5-39
Dryer Section	3888	12	5-39	Pressure Filter	3815	12	5-38
Evaporator	3847	12	5-40	Pressure Safety Valve	8595	12	5-39
F Bub (1 Tap)	3848	12	5-39	Pressure Screen	3865	12	5-38
Filtrate Tank	3857	12	5-38	Processing Equipment			
Flash Tank	3841	12	5-38	Batch Digester	3893	12	5-40
Foil (2 Blades)	3808	12	5-39	Blow Tank	3856	12	5-40
Foil (3 Blades)	3807	12	5-39	Causticizer	3861	12	5-40
Foil (4 Blades)	3802	12	5-39	Chlorine Dioxide Tower	3826	12	5-40
Foil (5 Blades)	3804	12	5-39	Clarifier	3892	12	5-40
Forming Board (3 Blades)	3805	12	5-39	Continuous Digester	3853	12	5-40
Forming Board (4 Blades)	3806	12	5-39	Dregs Washer	3871	12	5-40
Fourdrinier	3825	12	5-39	Drum Debarker	3846	12	5-40
Fourdrinier	3860	12	5-39	Lime Kiln	3896	12	5-40
Funnel	8632	12	5-39	Lime Mud Mixing Tank	3862	12	5-40
Headbox	3801	12	5-39	Lime Mud Washer	3873	12	5-40
Headbox	3883	12	5-39	Slaker	3812	12	5-40
Headbox, Primary	3895	12	5-39	Slaker	3875	12	5-40
Headbox, Secondary	3863	12	5-39	Steaming Vessel	3858	12	5-40
Heat Exchangers				White Liquor Clarifier	3874	12	5-40
Boiler	3877	12	5-40	White Liquor Storage Tank	3872	12	5-40
Deaerator	3882	12	5-40	Pulper	3864	12	5-39
Evaporator	3847	12	5-40	Pumps			
Heat Exchanger	3855	12	5-40	Agitator	3828	12	5-38
Heat Exchanger	3878	12	5-40	Blower	3890	12	5-38
Heat Exchanger	3891	12	5-40	Condensate Pump and Separator	3824	12	5-38
Heater/Cooler	3816	12	5-40	Flash Tank	3841	12	5-38
High Pressure Heater	3820	12	5-40	Pump	3889	12	5-38
Steam Header	3814	12	5-40	Pump w/Suction Discharge	3836	12	5-38
Heater/Cooler	3816	12	5-40	Refiner and Pump	3886	12	5-38
High Density Tank	3859	12	5-38	Steam Ejector	3894	12	5-38
High Density Tower	3839	12	5-38	Venturi Nozzle	3834	12	5-38
High Pressure Heater	3820	12	5-40	Rectangle Vessel	3822	12	5-38
Knotter	3850	12	5-38	Refiner and Pump	3886	12	5-38
Lime Kiln	3896	12	5-40	Root Valve	3852	12	5-39
Lime Mud Filter	3876	12	5-38	Saveall	3832	12	5-38
Lime Mud Mixing Tank	3862	12	5-40	Saveall, Disc	3821	12	5-38
Lime Mud Washer	3873	12	5-40	Separators			
Motor Valve	8621	12	5-39	Cleaner	3833	12	5-38
Orifice	3842	12	5-39	Cleaner	3835	12	5-38
Orthoflow (7 Blades)	3811	12	5-39	Cleaner	3866	12	5-38
Orthoflow (9 Blades)	3809	12	5-39	Cyclone	3897	12	5-38
Orthoflow (11 Blades)	3810	12	5-39	Deculator	3817	12	5-38
Paper Machine Equipment				Diffuser Wash	3854	12	5-38
Bell Bond Unit	3838	12	5-39	Disc Screen	3879	12	5-38
Conveyor	3881	12	5-39	Knotter	3850	12	5-38

**Optional Library #12, Pulp & Paper Process Flow, continued**

Description	Number	Lib.	Page
Lime Mud Filter	3876	12	5-38
Pressure Filter	3815	12	5-38
Pressure Screen	3865	12	5-38
Saveall	3832	12	5-38
Saveall, Disc.	3821	12	5-38
Thickener	3868	12	5-38
Vibrating Screen	3884	12	5-38
Washers	3818	12	5-38
Washers, Drum	3819	12	5-38
Single Nip Press	3823	12	5-39
Slaker	3812	12	5-40
Slaker	3875	12	5-40
Steam Box	3813	12	5-39
Steam Ejector	3894	12	5-38
Steam Header	3814	12	5-40
Steaming Vessel	3858	12	5-40
Stock Tank	3844	12	5-38
Stockchest	3867	12	5-39
Tanks and Vessels			
Blow Tank	3856	12	5-40
Filtrate Tank	3857	12	5-38
Flash Tank	3841	12	5-38
High Density Tank	3859	12	5-38
High Density Tower	3839	12	5-38
Lime Mud Mixing Tank	3862	12	5-40
Rectangle Vessel	3822	12	5-38
Stock Tank	3844	12	5-38
Tank	3885	12	5-38
White Liquor Storage Tank	3872	12	5-40
Thickener	3868	12	5-38
Three-Way Valve	3851	12	5-39
Transfer Press	3831	12	5-39
Twinver Press Section	3887	12	5-39
Valves			
Blind Flange	3880	12	5-39
Check Valve	8534	12	5-39
Control Valve	8603	12	5-39
Control Valve Body	8550	12	5-39
F Bub (1 Tap)	3848	12	5-39
Funnel	8632	12	5-39
Orifice	3842	12	5-39
Pil or Motor Valve	8621	12	5-39
Pil Valve	3845	12	5-39
Pipe Cap	3869	12	5-39
Pressure Safety Valve	8595	12	5-39
Root Valve	3852	12	5-39
Three-Way Valve	3851	12	5-39
Venturi Nozzle	3834	12	5-38
Vibrating Screen	3884	12	5-38
Washers	3818	12	5-38
Washers, Drum	3819	12	5-38
Wet Box	3803	12	5-39
White Liquor Clarifier	3874	12	5-40
White Liquor Storage Tank	3872	12	5-40
Wire Pit	3837	12	5-39





## Optional Library #14, Chemical & Petroleum Process Flow

Description	Number	Lib.	Page	Description	Number	Lib.	Page
<b>Columns, Tanks and Vessels</b>				<b>Air-Cooled Exchanger</b>	8272	14	5-46
Bubble-Cap Plate Column	8281	14	5-43	Auxiliary Heater	8255	14	5-46
Disk and Donut Column	8364	14	5-43	Barometric Condenser	8270	14	5-46
Flash Tank	3841	14	5-43	Cascade Cooler	8274	14	5-46
Gas Cooling Tower (Spray Type)	8282	14	5-43	Cooler	8262	14	5-46
Gas Holder	8310	14	5-43	Double Pipe	8273	14	5-46
Horizontal Tank	3822	14	5-43	Down-Draft Cooler (3-Pass)	8259	14	5-46
Horizontal Tank	8308	14	5-43	Economizer	8258	14	5-46
Internal Coil	8314	14	5-43	Electric Heater	8390	14	5-46
Jacketed Kettle	8312	14	5-43	Fired Heater	8252	14	5-46
Jacketed Kettle	8382	14	5-43	Fired Heater	8253	14	5-46
Jacketed Vessel	8360	14	5-43	Glycol Reboiler w/Packed Still Col.	8352	14	5-46
Kettle Reboiler	8359	14	5-43	Heater	8263	14	5-46
Packed Column	8278	14	5-43	Kettle-Type Reboiler	8271	14	5-46
Packed Column	8361	14	5-43	Open Steam to Tower	8254	14	5-46
Packed Column	8386	14	5-43	Salt Bath Heater	8353	14	5-46
Perforated Plate Column	8280	14	5-43	Shell and Tube Type	8264	14	5-46
Plate Column	8362	14	5-43	Shell and Tube Type	8265	14	5-46
Pump Tank	8313	14	5-43	Shell and Tube Type	8267	14	5-46
Reactor, Catalytic	8315	14	5-43	Shell and Tube Type	8268	14	5-46
Reactor, Nuclear	8316	14	5-43	Spiral Type	8266	14	5-46
Sectioned Column	8363	14	5-43	Two-Pass Tube Side	8269	14	5-46
Sphere	8311	14	5-43	Waffle Coolers	8277	14	5-46
Spray Column	8279	14	5-43	Waste Heat Boiler (2 Drum)	8256	14	5-46
Swage Column	8356	14	5-43	Waste Heat Boiler (3 Drum)	8257	14	5-46
Trayed Column	8350	14	5-43	Waste Heat Boiler Fire Tube	8260	14	5-46
Vertical Pressure Vessel	8354	14	5-43	Waste Heat Boiler Fire Tube	8261	14	5-46
Vertical Tank	8309	14	5-43	Water Cooling Rack	8276	14	5-46
				Z and NR Type Cooler	8275	14	5-46
<b>Drivers</b>				<b>Instrument Lines</b>			
Dual-Drive Engine	8321	14	5-46	Air Line	8696	14	5-43
Motor	8319	14	5-46	Capillary Tubing	8698	14	5-43
Single-Drive Engine	8320	14	5-46	Insulated Line w/Thickness and Size	8330	14	5-43
Steam Piston	8323	14	5-46	Line Break	8697	14	5-43
Turbine	8322	14	5-46	Line Continuation	8332	14	5-43
				Tie-In to Existing Line	8331	14	5-43
<b>Drying Equipment</b>				<b>Instruments</b>			
Batch Trays	8365	14	5-45	Flow Straightening Vanes	8339	14	5-41
Desiccant	8367	14	5-45	Local Panel Mounted	8337	14	5-41
Double-Drum Dryer	8246	14	5-45	Orifice Plate w/Flange Pres. Taps	8334	14	5-41
Indirectly Heated Dryer	8249	14	5-45	Orifice Plate w/Pipe Taps	8335	14	5-41
Rotary Dryer	8248	14	5-45	Orifice Plate in Quick Chg. Fitting	8336	14	5-41
Rotary Dryer	8369	14	5-45	Shut Down Relay System	8340	14	5-41
Rotary Film Dryer	8327	14	5-45	Temperature Indicator	8396	14	5-41
Single-Drum Dryer	8245	14	5-45	Thermowell	8395	14	5-41
Spray Dryer	8247	14	5-45	Turbine or Propeller	8394	14	5-41
Spray Dryer	8366	14	5-45	Venturi Tube	8338	14	5-41
Tunnel Dryer	8250	14	5-45	<b>Mixing and Separating Equipment</b>			
Tunnel Dryer	8368	14	5-45	Air Classifier	8210	14	5-41
Vibrating Screen Dryer	8251	14	5-45	Bag Collector	8212	14	5-41
<b>Feeders and Conveyors</b>				Centrifugal Compressor/Expander	8357	14	5-41
Air Lift	8317	14	5-42	Centrifuge	8383	14	5-41
Belt Conveyor	8240	14	5-42	Cyclone	8384	14	5-41
Belt Feeder	8232	14	5-42	Cyclone Collector	8211	14	5-41
Bin Check Valve	8230	14	5-42	Electrical Precipitator	8318	14	5-41
Bucket Carrier	8241	14	5-42	Filter Press	8385	14	5-41
Bucket Elevator	8234	14	5-42	Fuel Gas Filter Separator	8355	14	5-41
Disc Feeder	8231	14	5-42	Jet Mixer	8328	14	5-41
Feeder and Hopper	8373	14	5-42	Liquid-Liquid Centrifuge	8221	14	5-41
Flight Conveyor	8239	14	5-42	Paddle Agitator	8214	14	5-41
Flight Conveyor	8370	14	5-42	Paddle Agitator	8215	14	5-41
Mass-Type Elevator	8235	14	5-42	Ribbon Blender	8216	14	5-41
Pressure-Type Pneumatic Conveyor	8243	14	5-42	Rotax	8209	14	5-41
Roller Conveyor	8242	14	5-42	Screen	8208	14	5-41
Roller Conveyor	8372	14	5-42	Screen Type Centrifuge	8219	14	5-41
Rotary Feeder	8374	14	5-42	Single Stage Expander	8351	14	5-41
Rotary Star Valve	8229	14	5-42	Solid Bowl Centrifuge	8218	14	5-41
Screw Conveyor	8237	14	5-42	Ter Meer Centrifuge	8220	14	5-41
Screw Conveyor	8371	14	5-42	Turbine or Propeller Agitator	8213	14	5-41
Skip Hoist Elevator	8236	14	5-42	Two-Stage Compressor	8358	14	5-41
Slide Gate	8233	14	5-42	Vertical Basket Centrifuge	8217	14	5-41
Vacuum-Type Pneumatic Conveyor	8244	14	5-42	<b>Process Quantities</b>			
Vibrating Conveyor	8238	14	5-42				

**Optional Library #14, Chemical & Petroleum Process Flow, continued**

Description	Number	Lib.	Page	Description	Number	Lib.	Page
Duty (MMBTU/HR)	8333	14	5-43	Valves and Fittings			
Pressure (Primary)	8342	14	5-43	Adjustable Choke Valve	8597	14	5-47
Pressure (Secondary)	8343	14	5-43	Angle Valve	8517	14	5-47
Rate - BBL/Time (BPD)	8347	14	5-43	Atmospheric Vent	8684	14	5-48
Rate - Gas Vol/Time (SCFD)	8345	14	5-43	Ball Valve	8583	14	5-47
Rate - Liquid Vol/Time (GPH)	8346	14	5-43	Bleed Ring	8645	14	5-48
Rate - Mass/Time (LBS HR)	8348	14	5-43	Breather	8660	14	5-48
Rated H.P.	8349	14	5-43	Butterfly Valve	8589	14	5-47
Specific Gravity	8344	14	5-43	Check Valve	8534	14	5-47
Temperature	8341	14	5-43	Check Valve	8587	14	5-47
Processing Equipment				Check Valve	8662	14	5-47
Autoclave	8381	14	5-45	Closed Drain	8634	14	5-48
Blowing Egg	8324	14	5-45	Connection Flange	8448	14	5-48
Pig Launcher or Receiver	8391	14	5-45	Connection Plugged	8630	14	5-48
Settler	8326	14	5-45	Connection Quick Break	8647	14	5-48
Thickener	8329	14	5-45	Connection Socketweld	8629	14	5-48
Pumps				Control Valve (Miscellaneous Oper.)	8621	14	5-47
Blower	3890	14	5-44	Control Valve w/Handwheel	8625	14	5-47
Centrifugal Blower	8283	14	5-44	Diaphragm Control	8603	14	5-47
Centrifugal Blower	8284	14	5-44	Diaphragm Seal	8655	14	5-48
Centrifugal Pump	8295	14	5-44	Drain Valve on Main Valve Body	8611	14	5-47
Diaphragm Pump	8302	14	5-44	Equalizing Valve on Main Valve Body	8613	14	5-47
Diaphragm Pump, Oliver O.D.S.	8306	14	5-44	Expansion Joint	8652	14	5-48
Diaphragm Pump Pulsa Feeder	8298	14	5-44	Flame or Stack Arrestor	8658	14	5-48
Duplex Reciprocating Pump	8301	14	5-44	Flexible Hose w/Hose Connection	8651	14	5-48
Gear Pump	8296	14	5-44	Float Operated Valve	8686	14	5-48
Horizontal Centrifugal Pump	8387	14	5-44	Four-Way Valve	8601	14	5-47
Lobe-Type G.C. Blower	8285	14	5-44	Gate Valve	8550	14	5-47
Lobe-Type G.C. Blower	8286	14	5-44	Globe Valve	8558	14	5-47
Motor-Driven Reciprocating Pump	8304	14	5-44	Hand Operated Valve	8609	14	5-47
Motor-Driven Reciprocating Pump	8305	14	5-44	Integral Regulating Valve	8668	14	5-47
Proportioning Pump	8376	14	5-44	Line Blind (Closed)	8678	14	5-48
Pump	3886	14	5-44	Line Blind (Open)	8676	14	5-48
Pump	3889	14	5-44	Line Size Change	8631	14	5-48
Reciprocating Compressor	8289	14	5-44	Manually Operated Valve	8666	14	5-47
Reciprocating Compressor	8291	14	5-44	Mechanical Specialty Item	8657	14	5-48
Reciprocating Compressor	8292	14	5-44	Motor Operated Valve	8605	14	5-47
Reciprocating Compressor	8392	14	5-44	Needle Valve	8591	14	5-47
Reciprocating Compressor (3 Stage)	8290	14	5-44	Needle Valve	8664	14	5-47
Reciprocating Positive Disp Pump	8388	14	5-44	Open Drain	8632	14	5-48
Rotary Blower	8287	14	5-44	Open Drain w/Liquid Seal	8633	14	5-48
Rotary Pump	8297	14	5-44	Orifice Flange	8461	14	5-48
Rotary Pump	8375	14	5-44	Pinch Valve	8688	14	5-48
Simplex Motor-Driven Pump	8300	14	5-44	Piston Operated Valve	8607	14	5-47
Steam-Driven Compressor	8293	14	5-44	Plug	8585	14	5-47
Steam-Driven Reciprocating Pump	8303	14	5-44	Plug Cock Valve	8674	14	5-47
Sump Pump	8389	14	5-44	Pressure Regulator	8619	14	5-47
Turbine-Driven Centrifugal Comp.	8294	14	5-44	Pressure Safety Valve	8595	14	5-47
Turbine-Driven Pump	8307	14	5-44	Pressure Safety Valve (Pilot Oper.)	8627	14	5-47
Venturi Nozzle	3834	14	5-44	Pulsation Dampener	8649	14	5-48
Vertical Inline Pump	8393	14	5-44	Quick Opening Valve	8694	14	5-48
Vertical Submerged Pump	8299	14	5-44	Regulator w/External Tap	8623	14	5-47
Size Reduction Equipment				Relief Valve	8670	14	5-47
Ball Mill	8203	14	5-45	Rupture Disc Valve	8653	14	5-47
Ball Mill	8377	14	5-45	Rupture Disc Valve	8672	14	5-47
Double Roll Crusher	8204	14	5-45	Solenoid Operated Valve	8617	14	5-47
Grinder	8378	14	5-45	Spacer Ring	8643	14	5-48
Hammer Mill	8201	14	5-45	Special Vent	8685	14	5-48
Jaw Crusher	8206	14	5-45	Spectacle Blind Valve	8641	14	5-48
Mikro Mill	8202	14	5-45	Steam Trap	8661	14	5-48
Reductionizer	8207	14	5-45	Stopcheck Valve	8593	14	5-47
Roller Crusher	8379	14	5-45	Strainer	8680	14	5-48
Screener	8380	14	5-45	Strainer, Basket	8637	14	5-48
Single Roll Crusher	8205	14	5-45	Strainer, Temporary Start-Up	8635	14	5-48
Transportation Equipment				Strainer, Y-Type	8639	14	5-48
Box Car	8222	14	5-42	Strainer, Y-Type	8682	14	5-48
Covered Hopper	8225	14	5-42	Thief Hatch	8659	14	5-48
Lift Truck	8228	14	5-42	Three-Way Spring Return Valve	8615	14	5-47
Low Gondola	8223	14	5-42	Three-Way Valve	8599	14	5-47
Open Hopper	8224	14	5-42	V-Port Valve	8692	14	5-48
Tank Car	8226	14	5-42	Y-Valve	8690	14	5-48
Tank Truck	8227	14	5-42				

# Applications - Organizational Charts

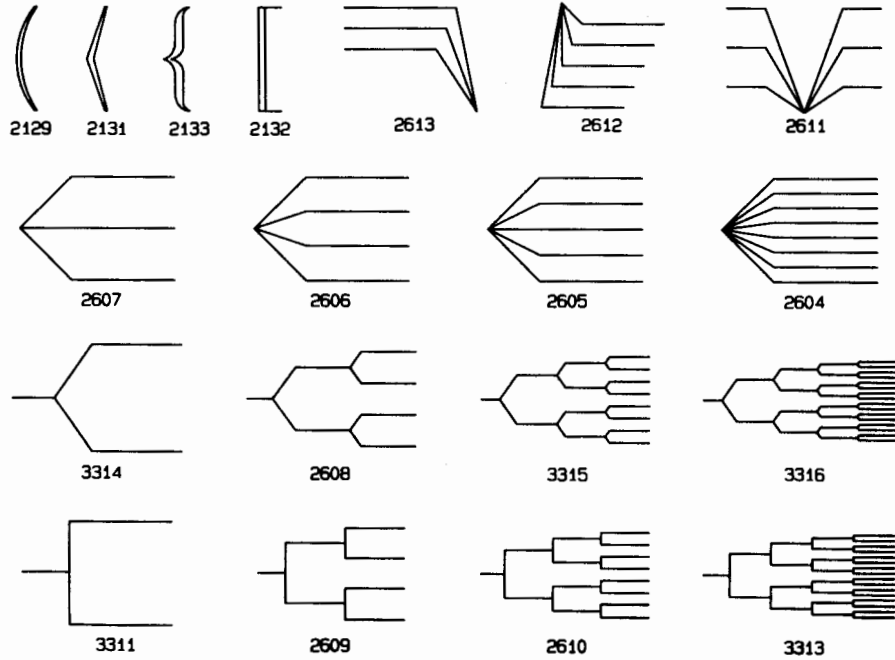
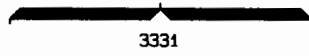
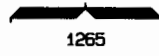
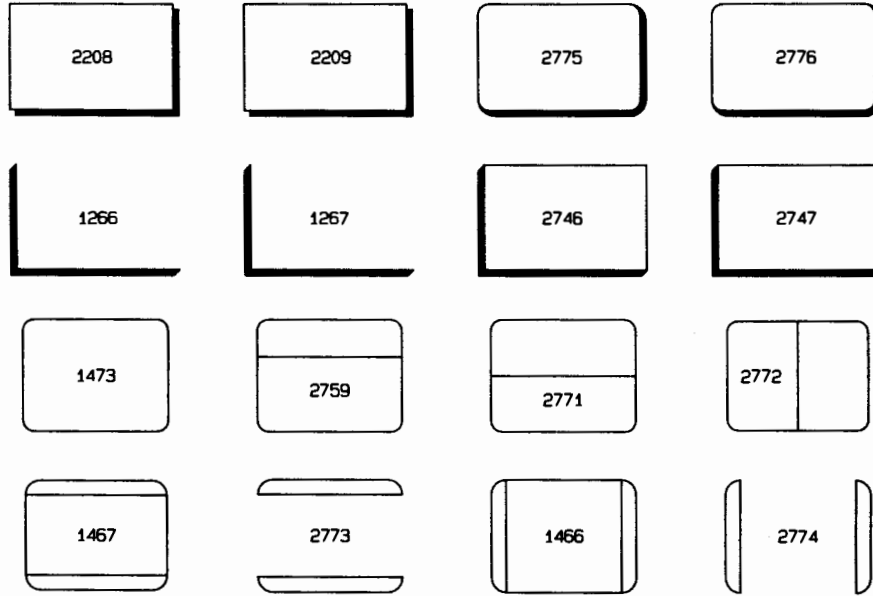

# Applications - Pie, Bar & Line Charts

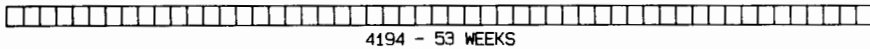
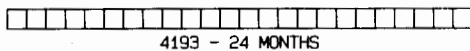
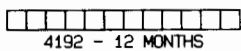
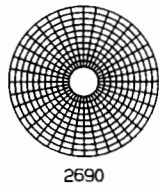
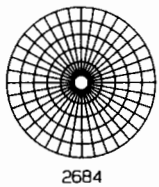
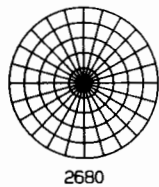
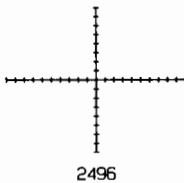
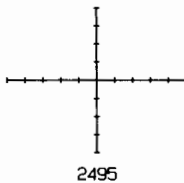
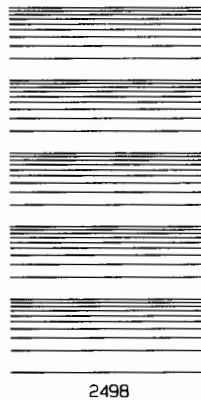
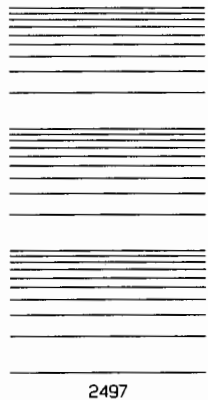
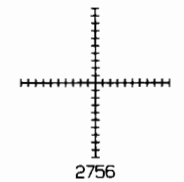
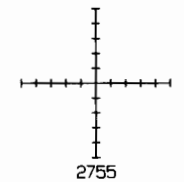
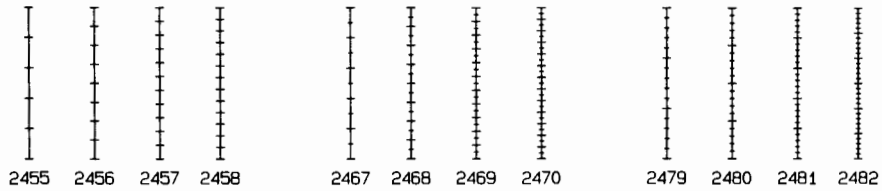
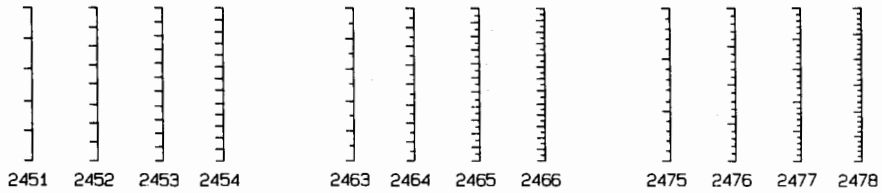

# Applications - Pie, Bar & Line Charts

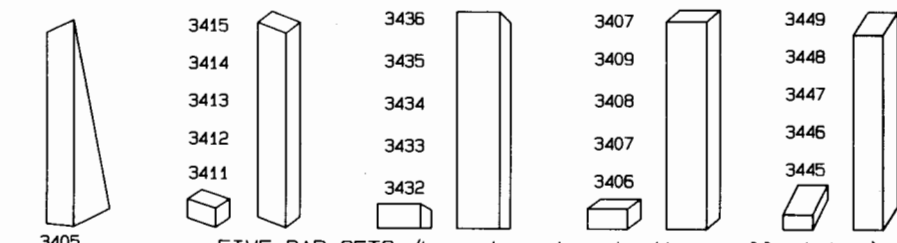
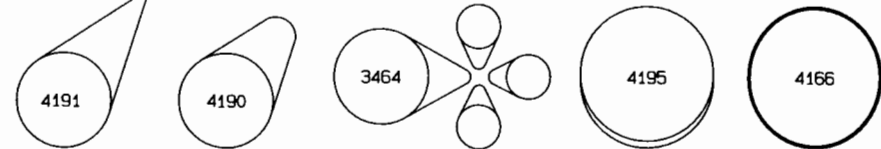
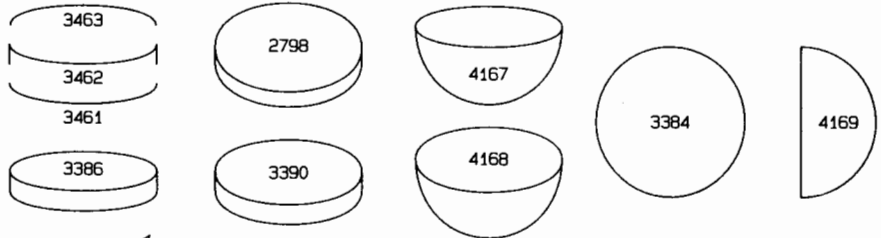
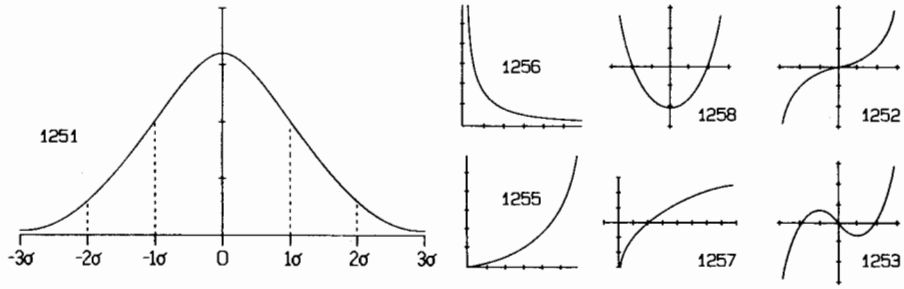

FIVE-BAR SETS (Lowest number is the smallest bar)

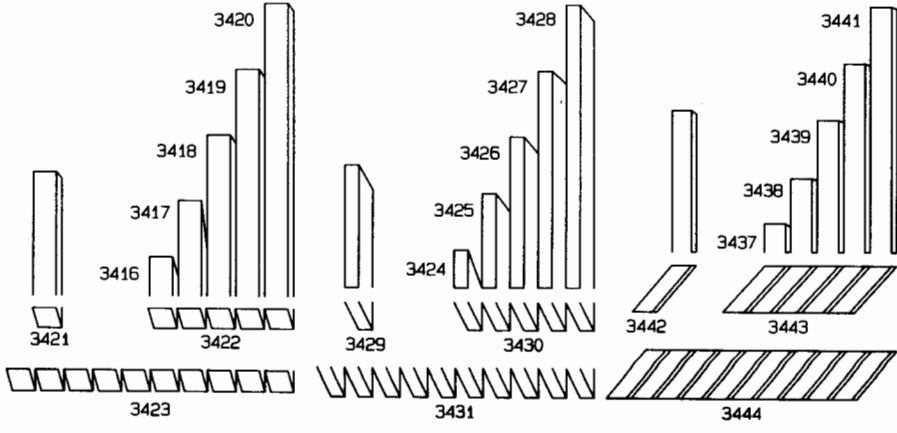



# Applications - Data Processing Flowcharts

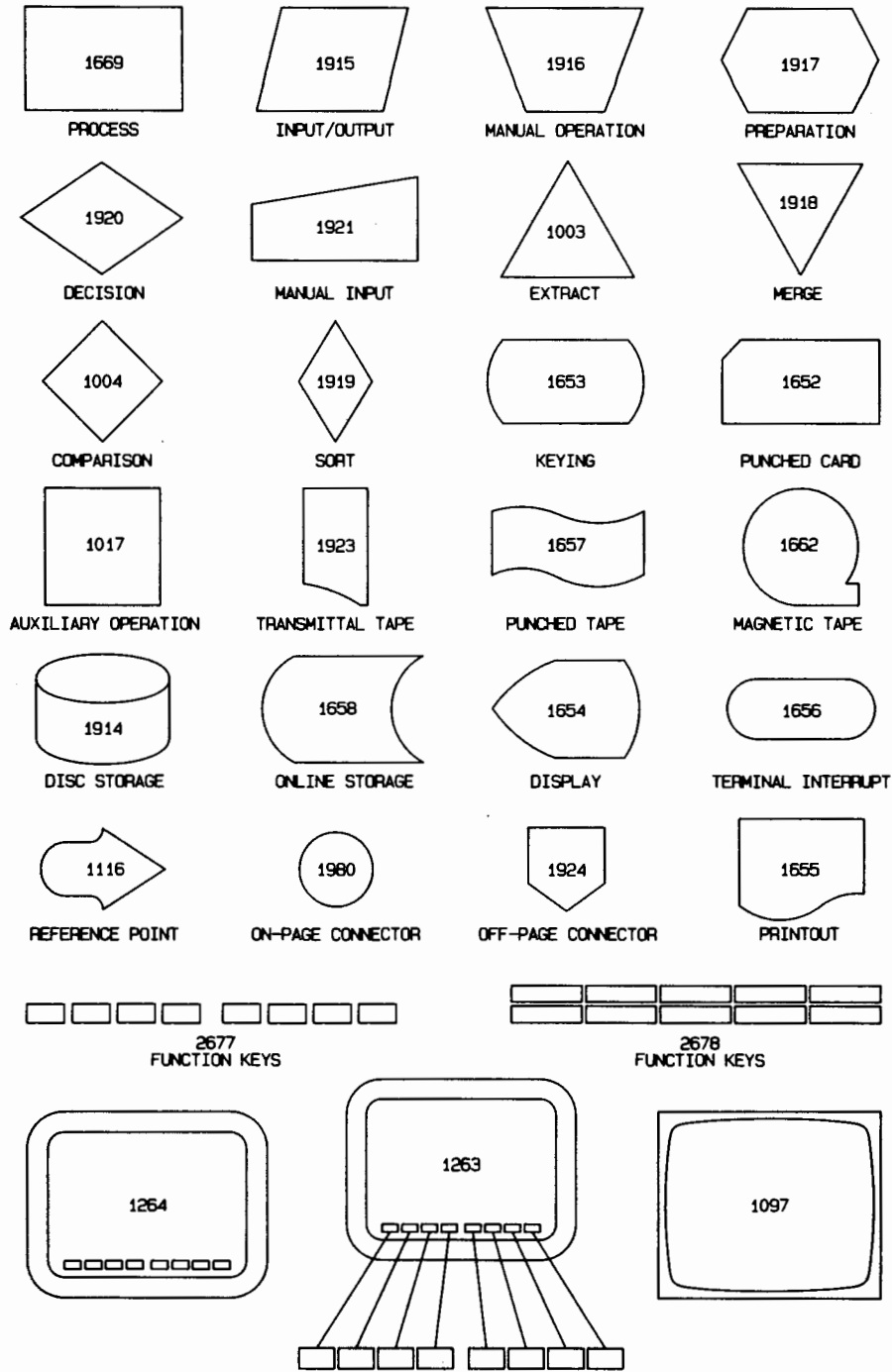

# Applications - Communications Flowcharts

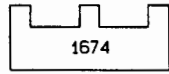

1674  
ACOUSTIC COUPLER

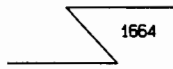

1664  
COMMUNICATION LINK



1024  
COMMUNICATION LINK



1633  
COMMUNICATION LINK



1672  
DATA ACCESS ARRANGMT.

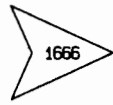

1666  
DIRECTION ARROW

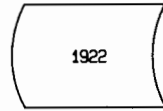

1922  
DISK STORAGE

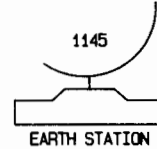

1145  
EARTH STATION

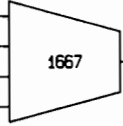

1667  
LINE CONCENTRATOR

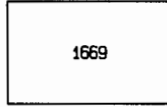

1669  
LINE SHARING

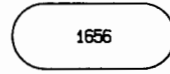

1656  
TEST EQUIPMENT

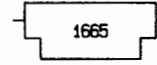

1665  
MODEM

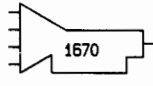

1670  
MULTIPOINT MODEM

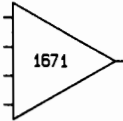

1671  
MULTIPLEXER

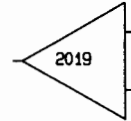

2019  
INVERSE MULTIPLEXER

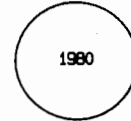

1980  
NODE

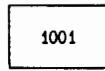

1001  
PACKET

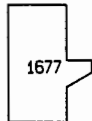

1677  
PBX

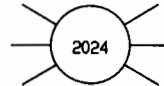

2024  
ROTARY

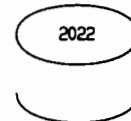

2022  
SATELLITE

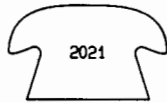

2021  
TELEPHONE



2023  
CRT DISPLAY TRML.

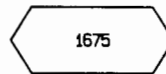

1675  
POLLED TERMINAL

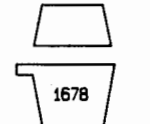

1678  
REMOTE BATCH TRML.



2020  
TELEPRINTER TRML.

# Applications - Office Layout

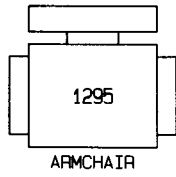

ARMCHAIR



CONFERENCE CHAIR

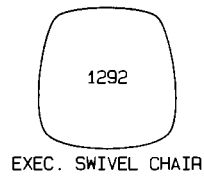

EXEC. SWIVEL CHAIR

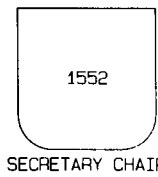

SECRETARY CHAIR

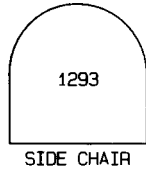

SIDE CHAIR

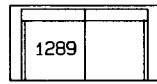

COUCH

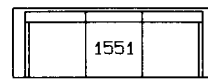

COUCH

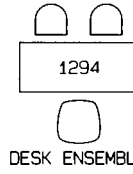

DESK ENSEMBLE

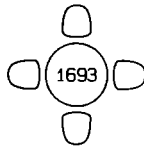

ROUND TABLE

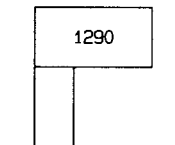

SECRETARY'S DESK

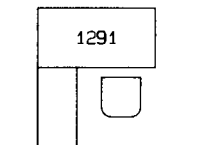

SECRETARY'S DESK

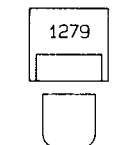

WORK STATION

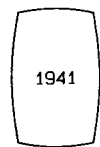

CONFERENCE TABLE

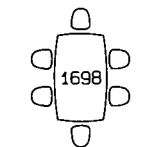

CONFERENCE TABLE

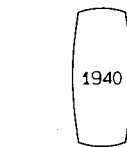

CONFERENCE TABLE

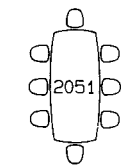

CONFERENCE TABLE

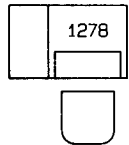

WORK STATION

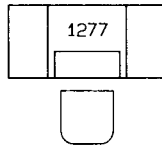

WORK STATION

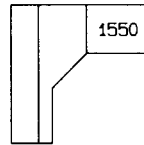

WORK STATION

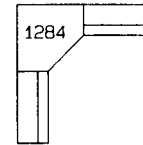

WORK STATION

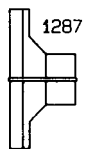

DUAL WORK STATION

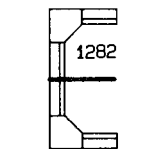

DUAL WORK STATION

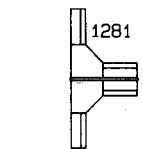

DUAL WORK STATION

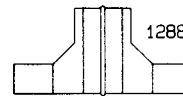

DUAL WORK STATION

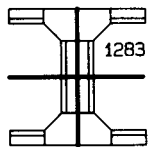

QUAD WORK STATION

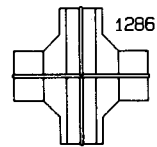

QUAD WORK STATION

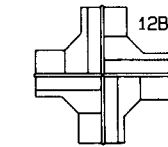

QUAD WORK STATION

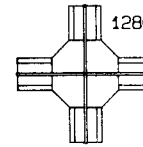

QUAD WORK STATION

# Applications - Networks



1851



1846



1860



1865



1850

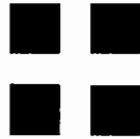

1807



1826



1836

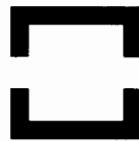

1849



1844



1858



1863



1845



1853

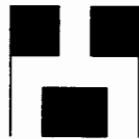

1827



1837



1848



1843



1857



1862



1859



1852



1828



1838



1847



1842



1856



1861



1864



2257



3470



3472

# Applications - Networks



1854



1855



1867



1866



1829



1830



1831



3471



1821



1822



3468



1823

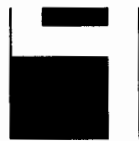

1818



1819



3486



1820



1812



2260

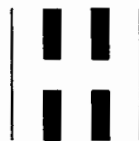

1814



2261



1873



1890



1872



1868



1835



1833



1834

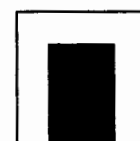

1832



3473



3474



1871



1870

# Applications - Networks

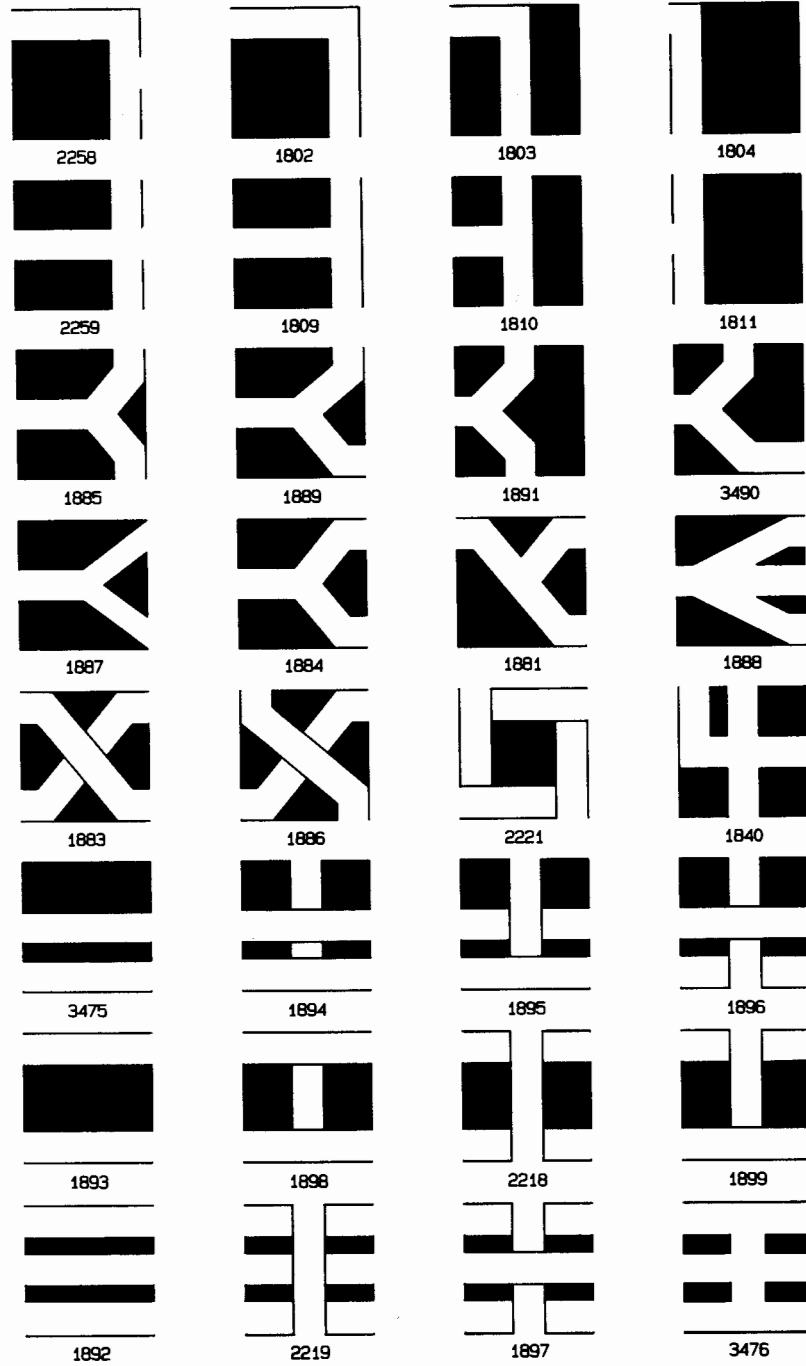

# Applications - Networks

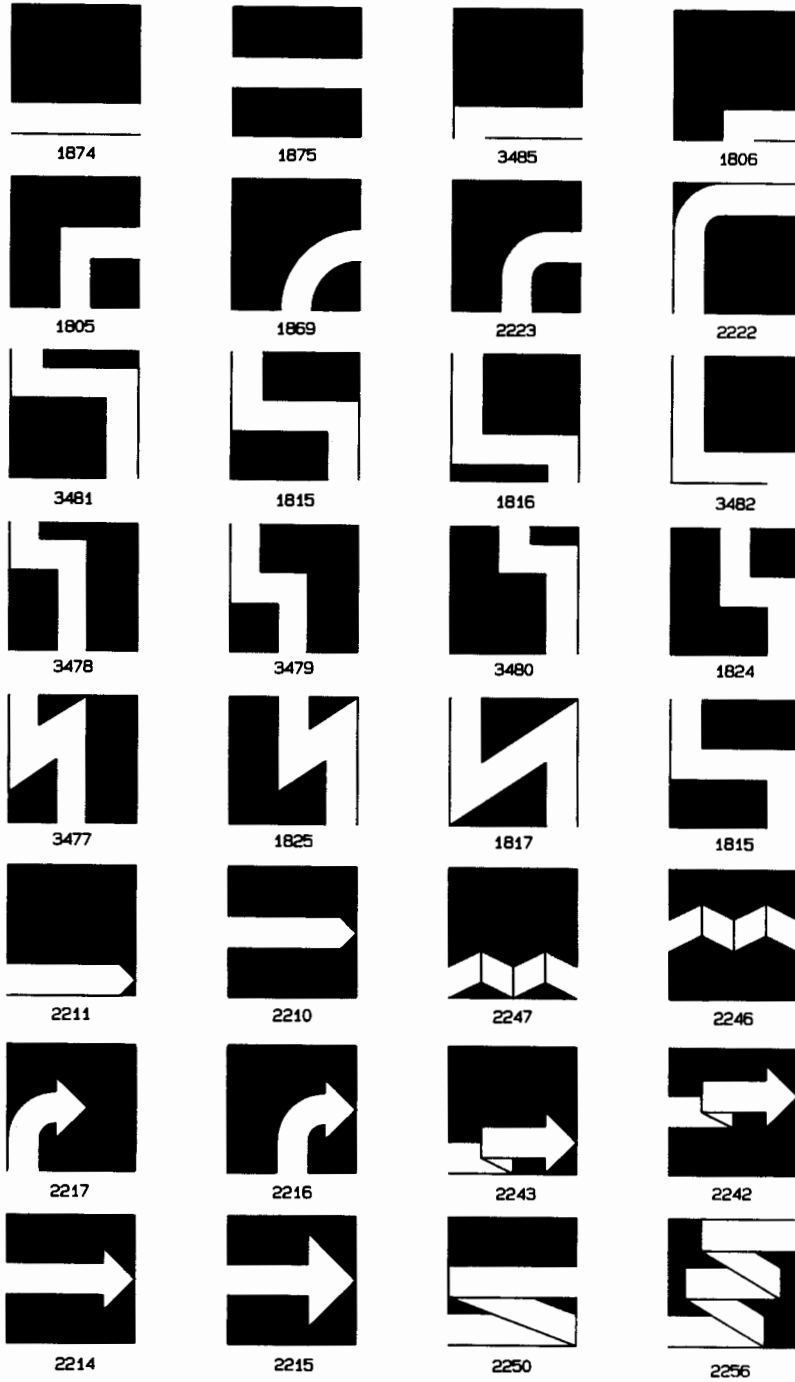

# Electronics and Logic

## CONNECTORS, TERMINALS & JUNCTIONS

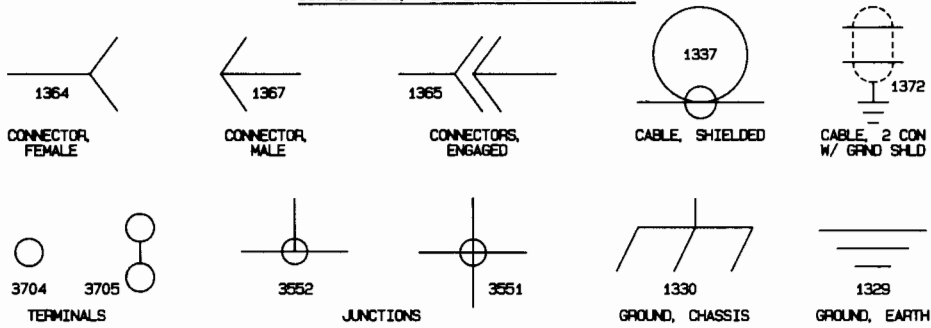

## RESISTORS, CAPACITORS, INDUCTORS & OTHERS

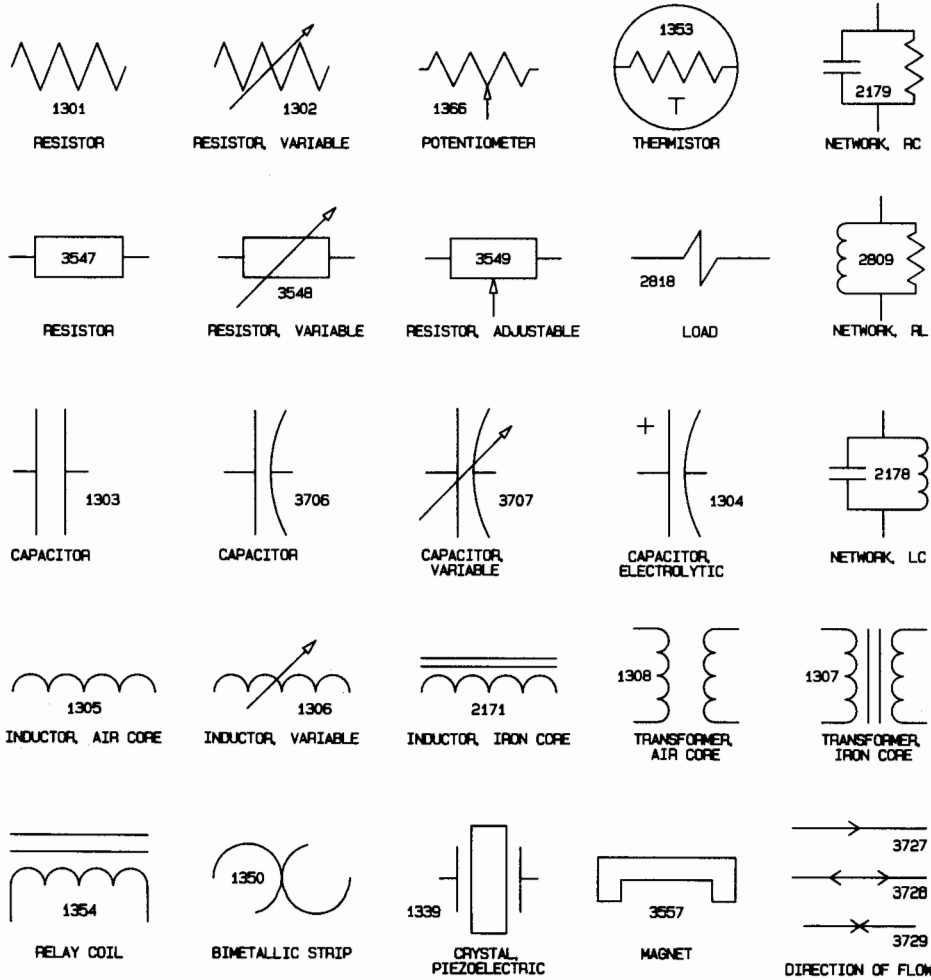



# Electronics and Logic

## RESISTORS, CAPACITORS, INDUCTORS & OTHERS (CONTINUED)

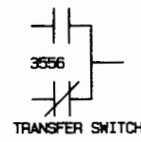
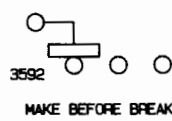
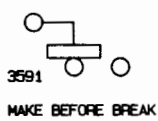
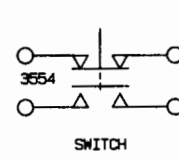
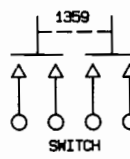
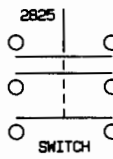
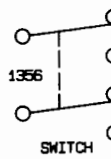
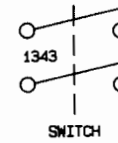
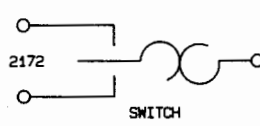
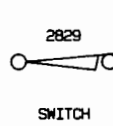
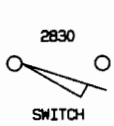
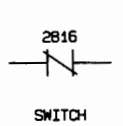
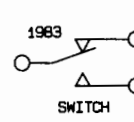
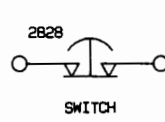
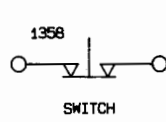
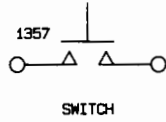
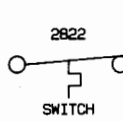
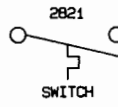
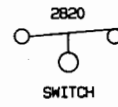
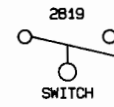
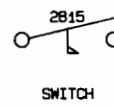
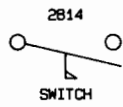
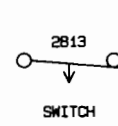
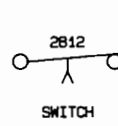
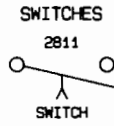
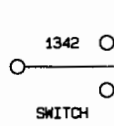
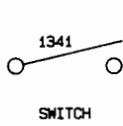
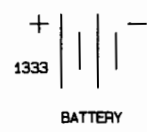
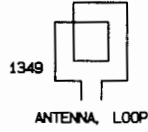
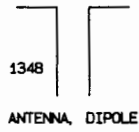
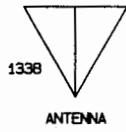
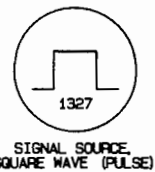
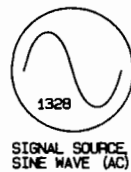
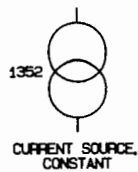
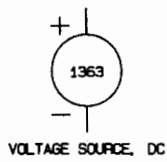

# Electronics and Logic

## RELAYS, SELECTORS & CIRCUIT PROTECTORS

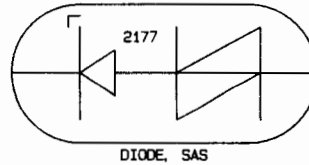
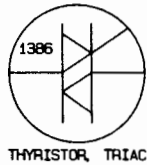
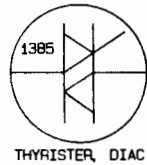
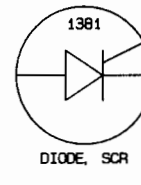
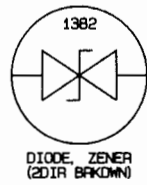
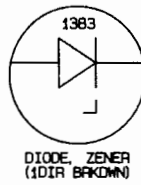
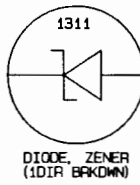
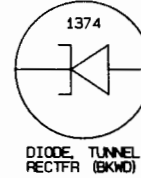
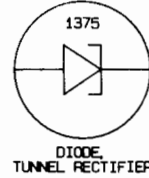
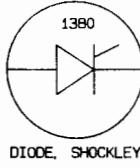
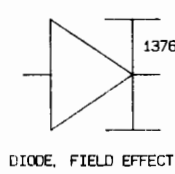
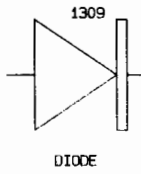
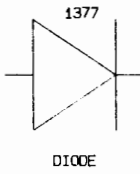
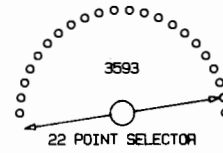
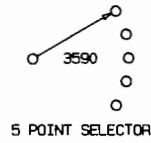
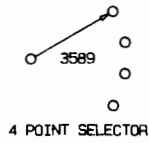
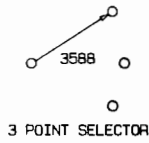
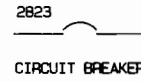
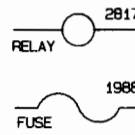
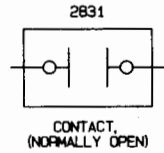
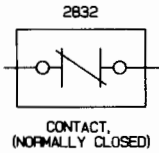
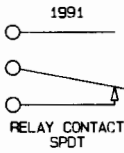
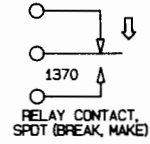
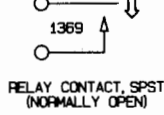
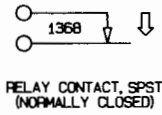
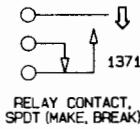

## DIODES & THYRISTORS

# Electronics and Logic

## TRANSISTORS

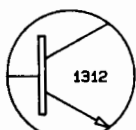

TRANSISTOR, NPN

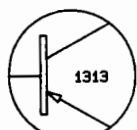

TRANSISTOR, PNP

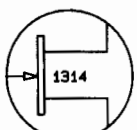

TRANSISTOR, JFET  
(N CHANNEL)

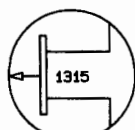

TRANSISTOR, JFET  
(P CHANNEL)

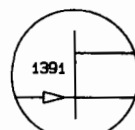

TRANSISTOR, JFET  
(N CHANNEL)

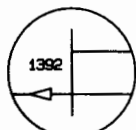

TRANSISTOR, JFET  
(P CHANNEL)

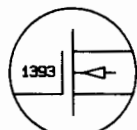

TRANSISTOR, IGFET  
(N CHNL, D MODE)

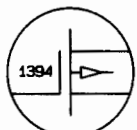

TRANSISTOR, IGFET  
(P CHNL, D MODE)

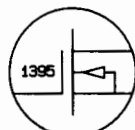

TRANSISTOR, IGFET  
(N CHNL, D MODE)

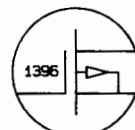

TRANSISTOR, IGFET  
(P CHNL, D MODE)

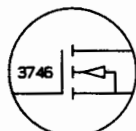

TRANSISTOR, IGFET  
(N CHNL, E MODE)

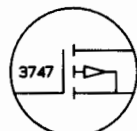

TRANSISTOR, IGFET  
(P CHNL, E MODE)

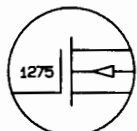

TRANSISTOR, IGFET  
(N CHNL, D MODE)

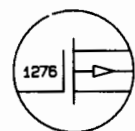

TRANSISTOR, IGFET  
(P CHNL, D MODE)

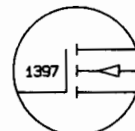

TRANSISTOR, IGFET  
(N CHNL, E MODE)

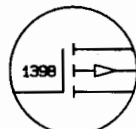

TRANSISTOR, IGFET  
(P CHNL, E MODE)

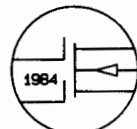

MOSFET, 5 TRL  
(N CHNL, D MODE)

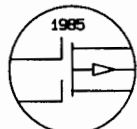

MOSFET, 5 TRL  
(P CHNL, D MODE)

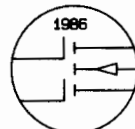

MOSFET, 5 TRL  
(N CHNL, E MODE)

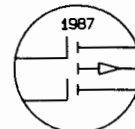

MOSFET, 5 TRL  
(P CHNL, E MODE)

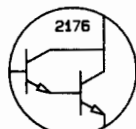

TRANSISTOR,  
DARLINGTON NPN

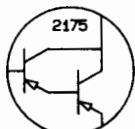

TRANSISTOR,  
DARLINGTON PNP

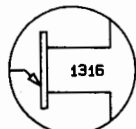

TRANSISTOR,  
UNIUNCTION

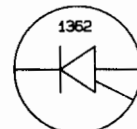

TRANSISTOR,  
PRGRMELE UNIUNCTION

## PHOTO SEMICONDUCTOR DEVICES

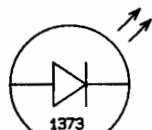

DIODE, (LED)  
LIGHT EMITTING

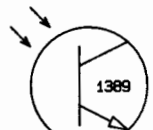

PHOTOTRANSISTOR,  
NPN (NO BASE CNCTN)

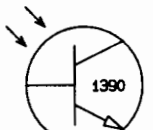

PHOTOTRANSISTOR,  
NPN (W/BASE CNCTN)



PHOTORESISTOR

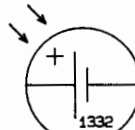

PHOTOVOLTAIC CELL

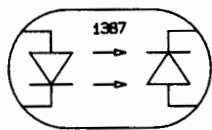

OPTOISOLATOR  
w/ PHOTODIODE OUT

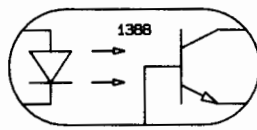

OPTOISOLATOR  
w/ PHOTOTRANSISTOR OUT

# Electronics and Logic

## ILLUMINATING DEVICES

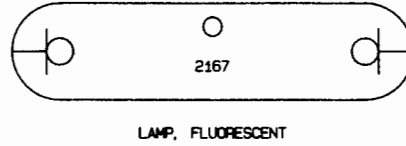
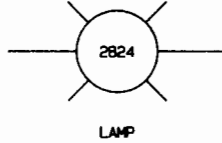
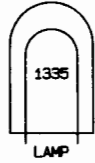
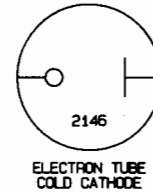
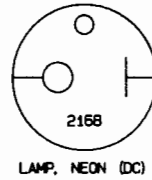
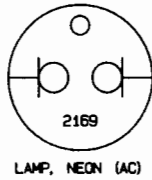
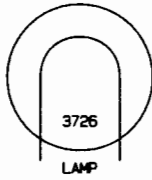

## WINDING BUILD-UP SYMBOLS



## ROTATING MACHINERY

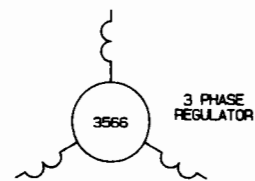
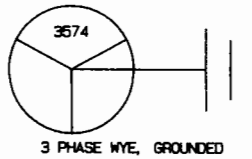
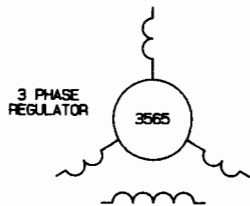
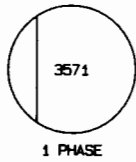
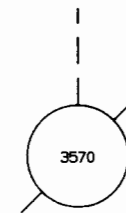
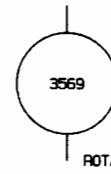
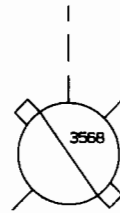
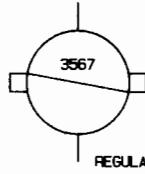

# Electronics and Logic

## ELECTRON TUBES

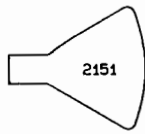

CATHODE RAY TUBE

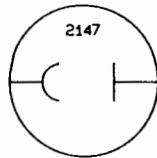

ELECTRON TUBE, PHOTO DIODE

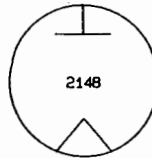

ELECTRON TUBE, DIODE

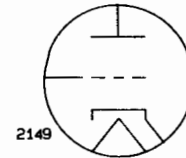

ELECTRON TUBE, TRIODE

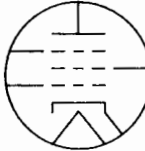

ELECTRON TUBE, PENTODE

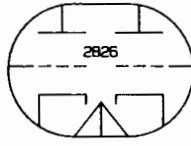

ELECTRON TUBE, CATHODE TWIN TRIODE

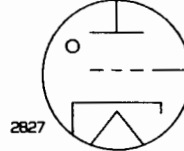

ELECTRON TUBE, THYRATRON

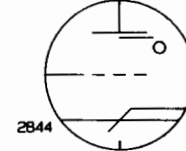

ELECTRON TUBE, MERCURY POOL

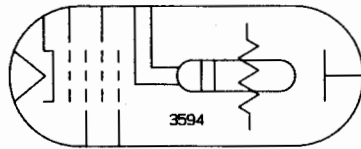

TRAVELING WAVE TUBE

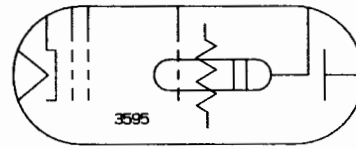

TRAVELING WAVE TUBE BACKWARD

## ACOUSTIC, COMPOSITE & MISCELLANEOUS SYMBOLS



SPEAKER

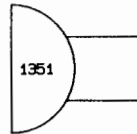

MICROPHONE

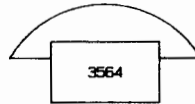

TELEPHONE

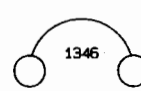

EARPHONES/HEADSET

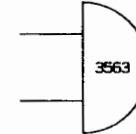

BELL

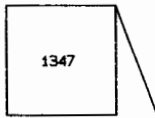

BUZZER



PICK-UP HEAD



JACK

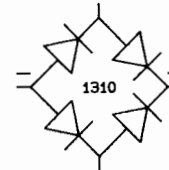

RECTIFIER, BRIDGE



TRANSFORMER, DELTA



TRANSFORMER, WYE

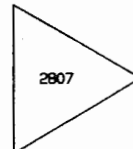

AMPLIFIER

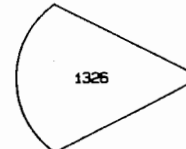

AMPLIFIER, OPERATIONAL

# Electronics and Logic

## SYMBOLS COMMONLY USED IN UHF, VHF & SHF CIRCUITS

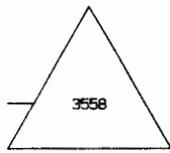

DISCONTINUITY,  
ONE PORT



DISCONTINUITY,  
TWO PORT

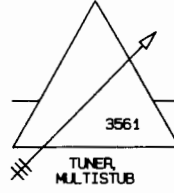

TUNER,  
MULTISTUB

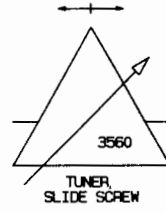

TUNER,  
SLIDE SCREW

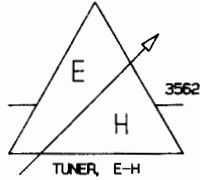

TUNER, E-H

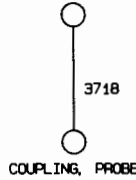

COUPLING, PROBE

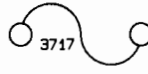

COUPLING,  
LOOP

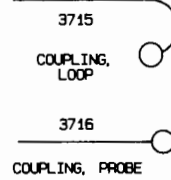

COUPLING,  
LOOP

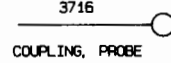

COUPLING, PROBE



COUPLING, APERTURE  
(ONE PATH END)



COUPLING, APERTURE  
(TWO PATH ENDS)

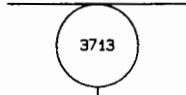

COUPLING,  
APERTURE  
(THREE  
PATH  
ENDS)

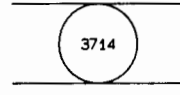

COUPLING, APERTURE  
(FOUR PATH ENDS)

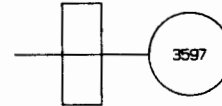

COUPLING, APERTURE  
(TO WAVEGUIDE)

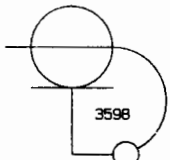

COUPLING, LOOP  
(TO COAXIAL)

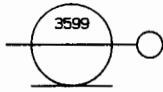

COUPLING,  
PROBE  
(TO COAXIAL)

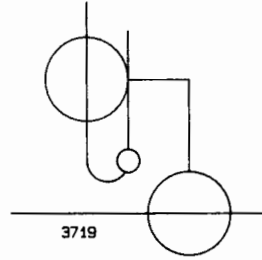

COUPLING, LOOP  
(COAXIAL TO WAVEGUIDE)

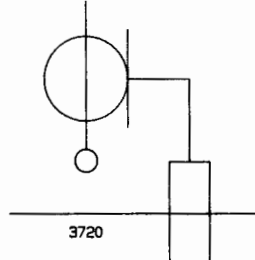

COUPLING, PROBE  
(COAXIAL TO WAVEGUIDE)

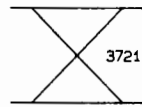

DIRECTIONAL  
COUPLER



MODE SUPPRESSOR

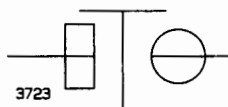

MODE TRANSDUCER,  
TRANSITION

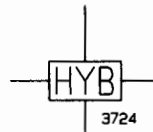

HYBRID

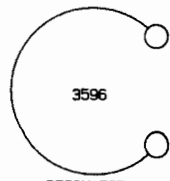

RESONATOR,  
TUNED CAVITY



ROTARY JOINT

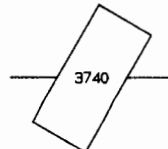

FERRITE BEAD RING



BALUN

# Electronics and Logic

## LOGIC & INTEGRATED CIRCUITS

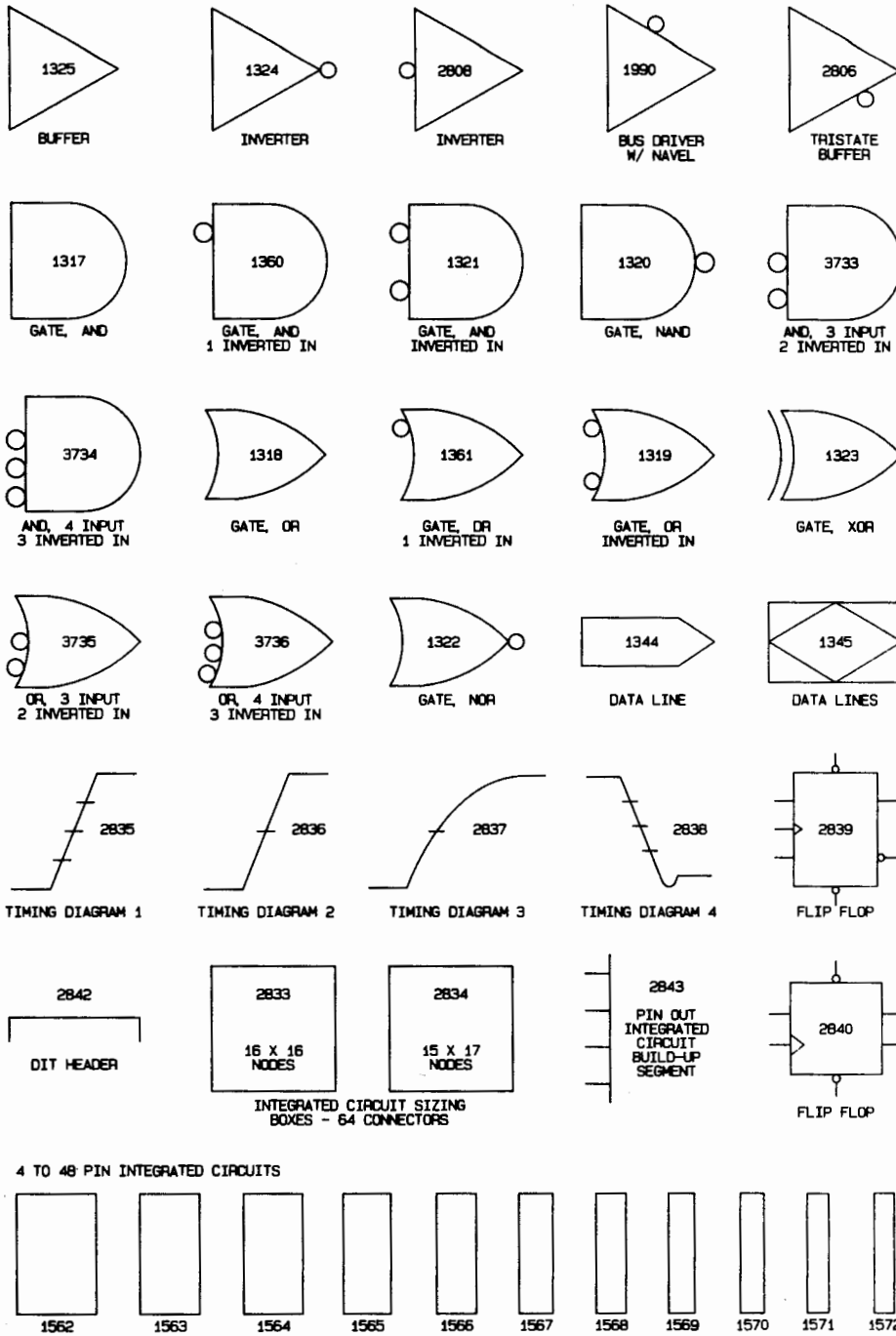

# EDP Equipment

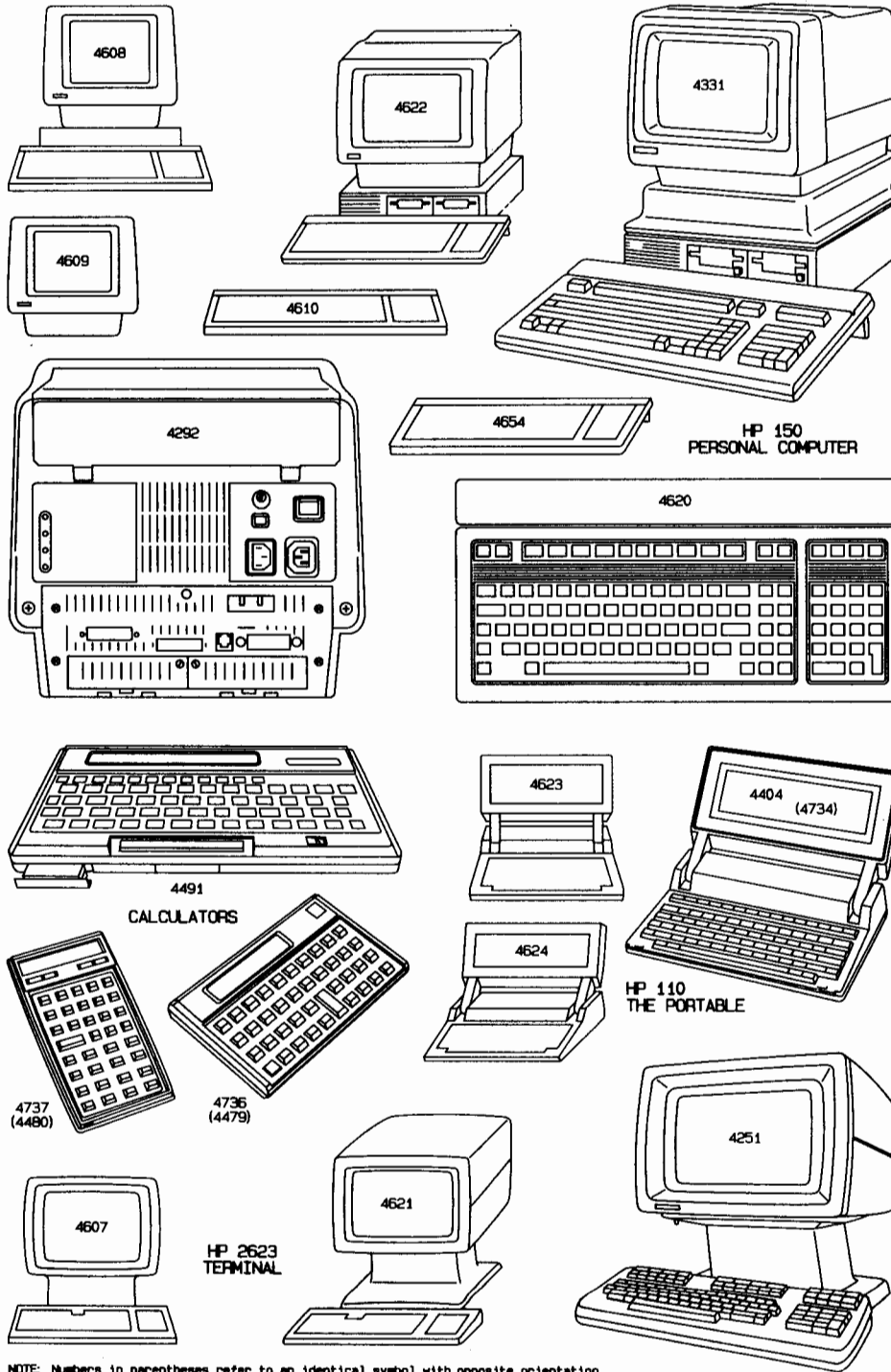

NOTE: Numbers in parentheses refer to an identical symbol with opposite orientation.



# EDP Equipment

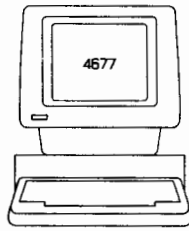

HP 9000  
MODEL 216

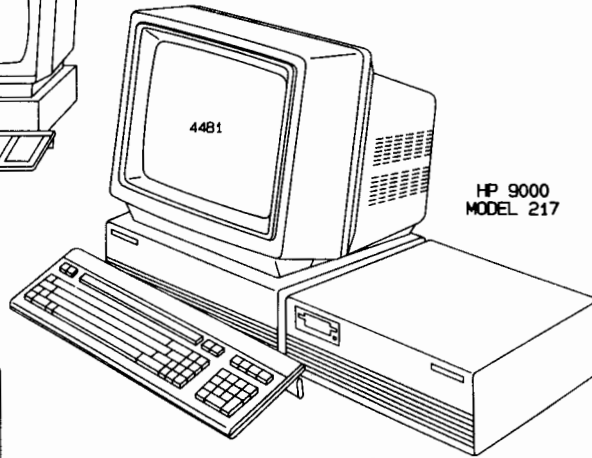
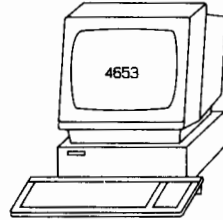
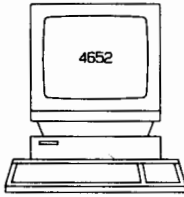
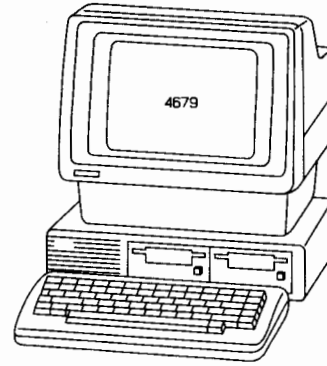
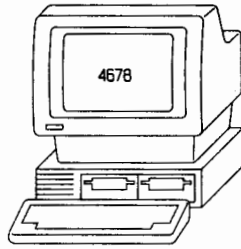

HP 9000  
MODEL 217

## DESKTOP COMPUTERS

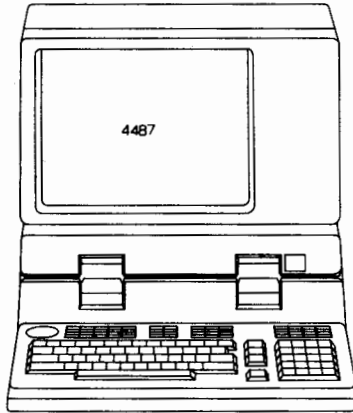

HP 9000  
MODEL 236

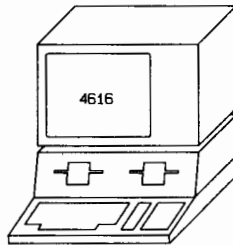
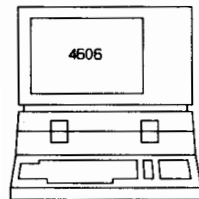
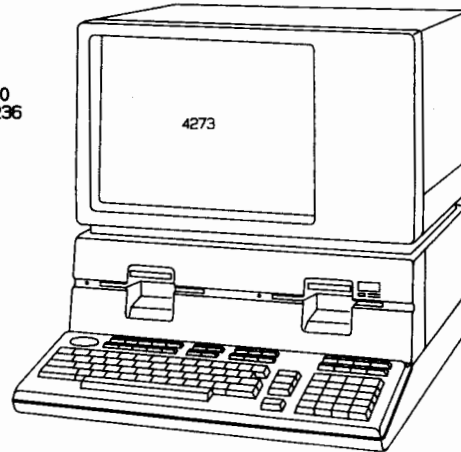

# EDP Equipment

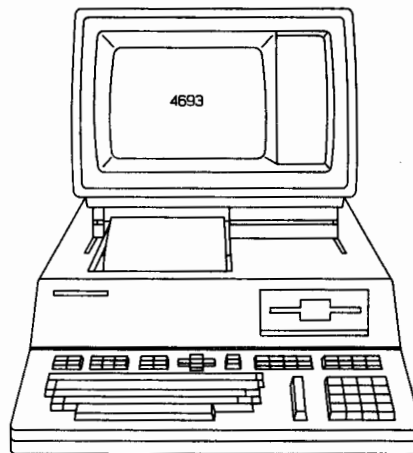
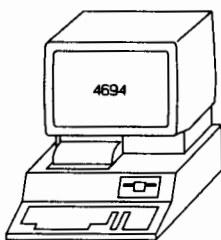

HP 9000  
MODEL 500

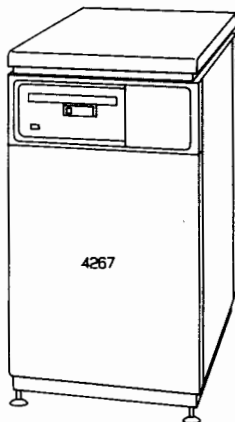
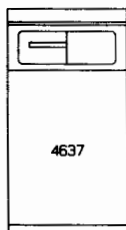

HP 7914  
DISC UNIT

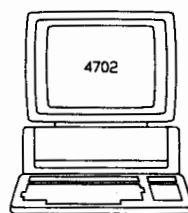
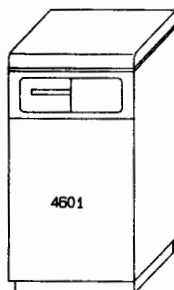

HP 1000  
W/HP 2623

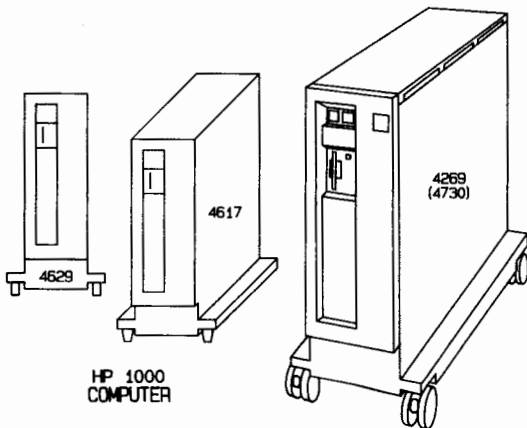
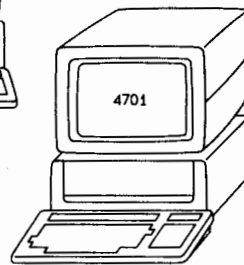

HP 1000  
COMPUTER

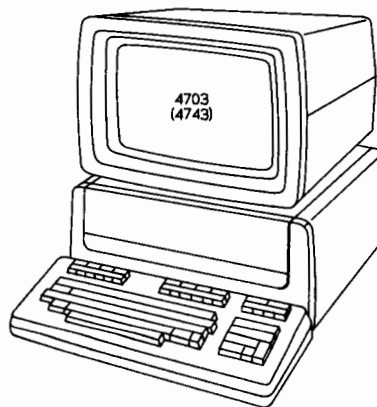

NOTE: Numbers in parentheses refer to an identical symbol with opposite orientation.

Rev: 4/86

© 1986, Computer Support Corporation

# EDP Equipment

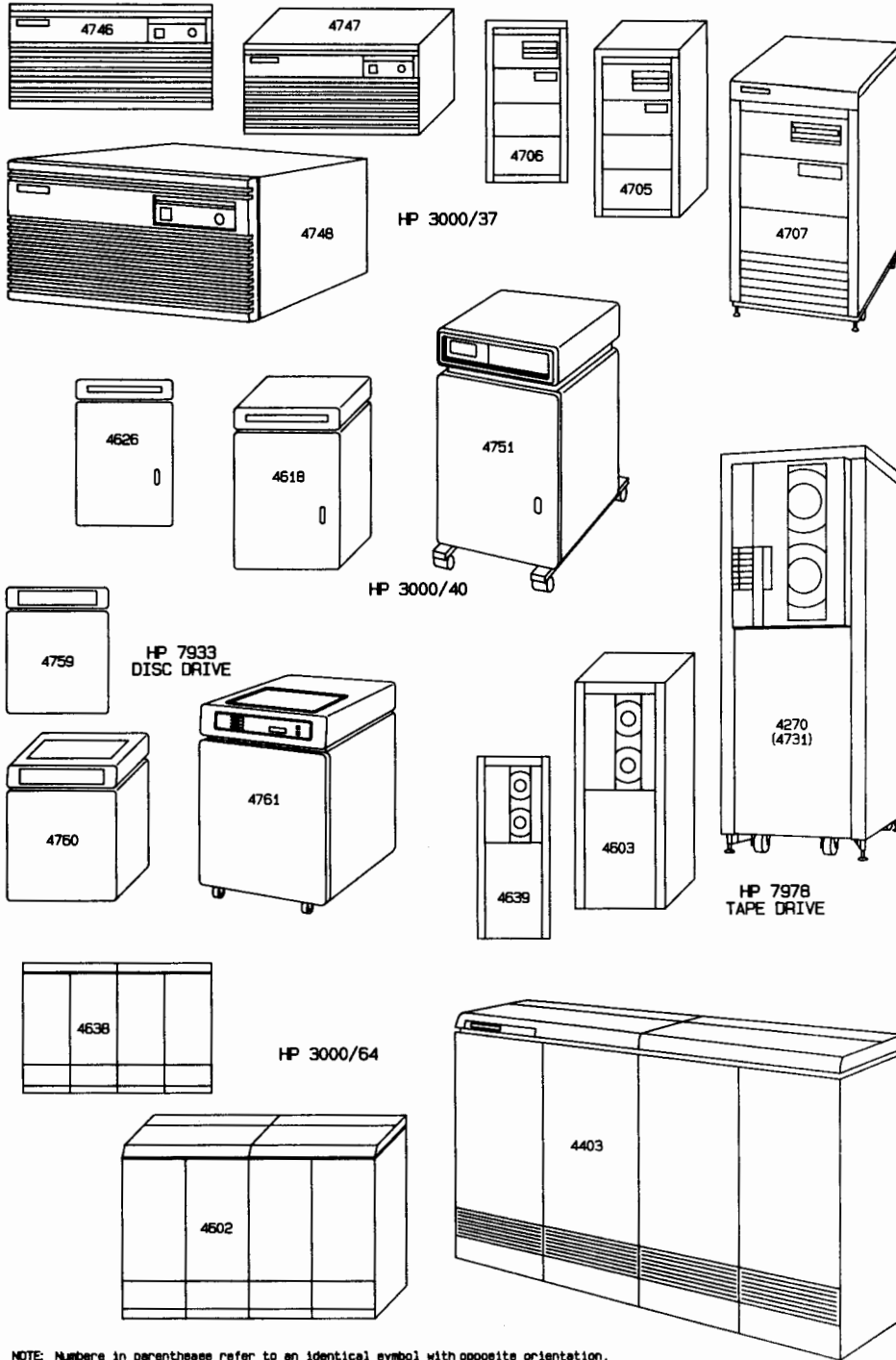

NOTE: Numbers in parentheses refer to an identical symbol with opposite orientation.

# EDP Equipment

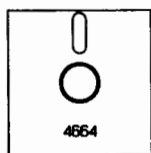

5 1/4"

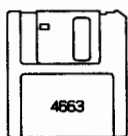

3 1/2"

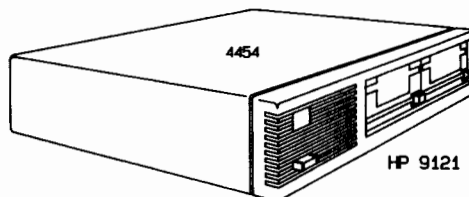

## DISCS & DISC DRIVES

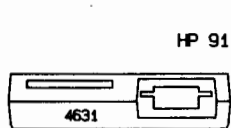

HP 9114

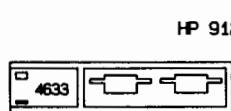
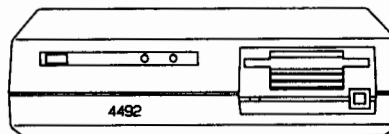
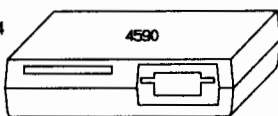

HP 9121

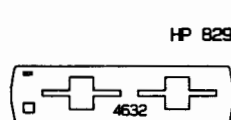
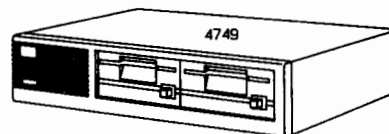
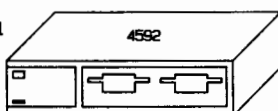

HP 82901

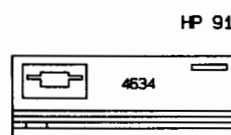
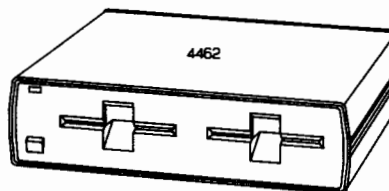
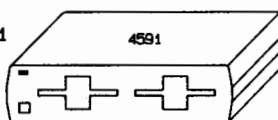

HP 9133

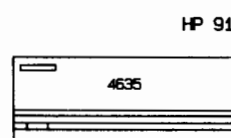
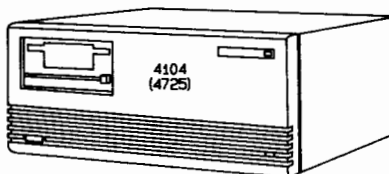
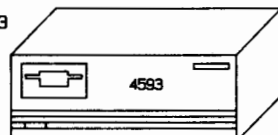

HP 9134

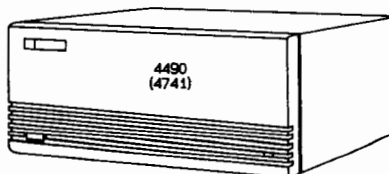
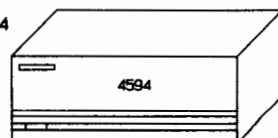

NOTE: Numbers in parentheses refer to an identical symbol with opposite orientation.

Rev: 4/86

© 1986, Computer Support Corporation

# EDP Equipment

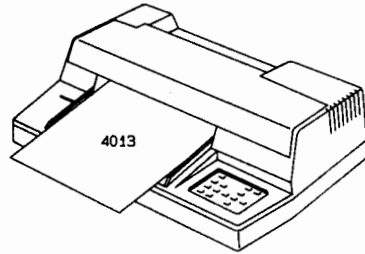
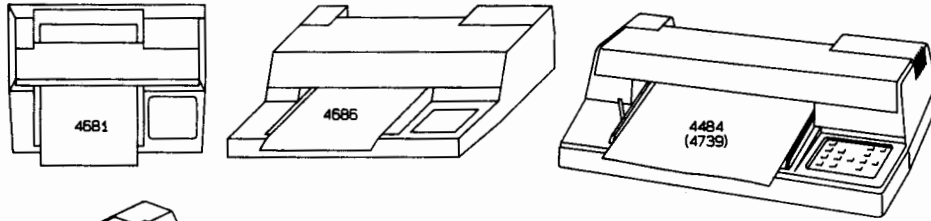
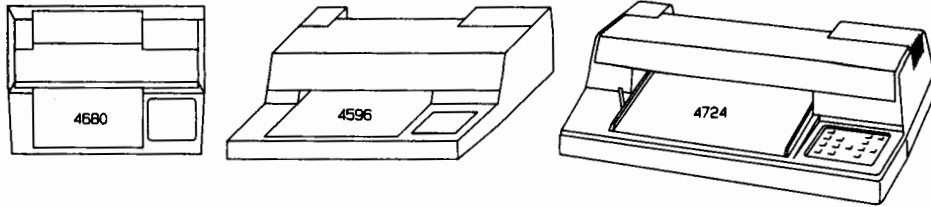

HP 7470

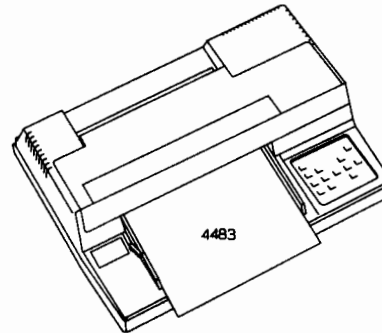

PLOTTERS

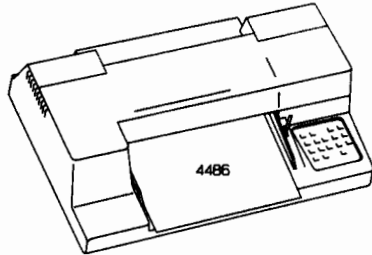

HP 7475

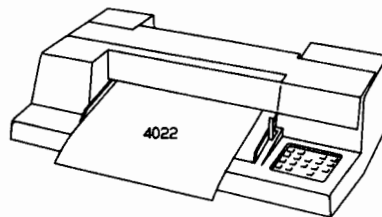
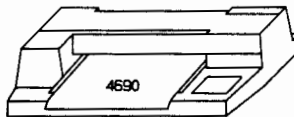
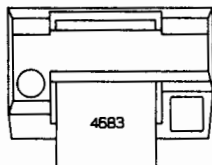
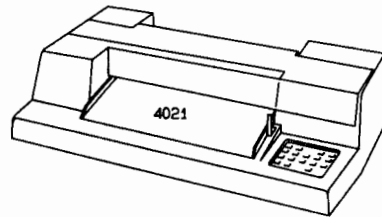
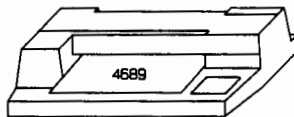
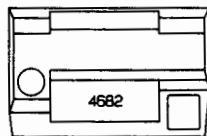

NOTE: Numbers in parentheses refer to an identical symbol with opposite orientation.

# EDP Equipment

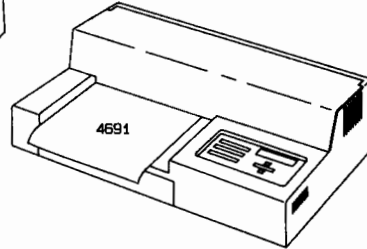
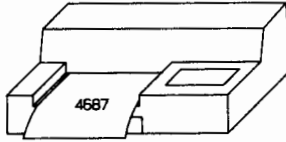
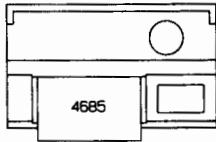
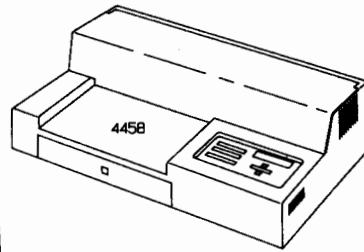
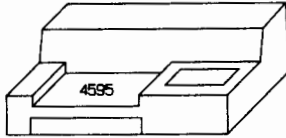
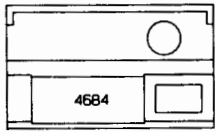

HP 7550

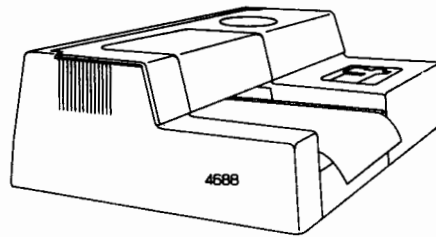
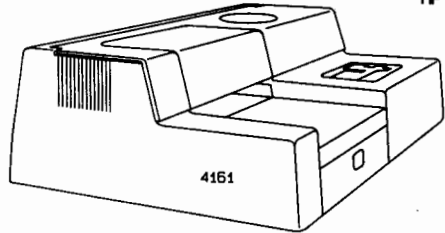

## PLOTTERS

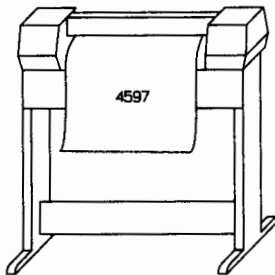
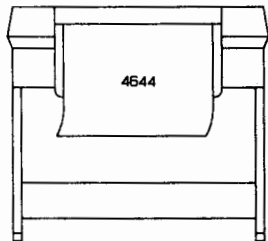

HP 7580

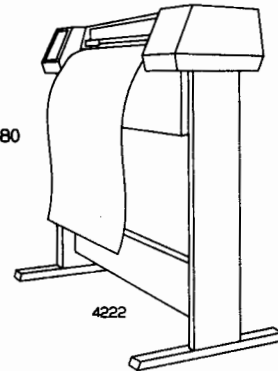

## GRAPHICS TABLET

HP 9111A

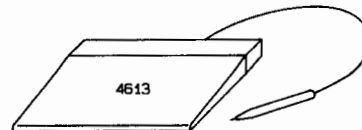
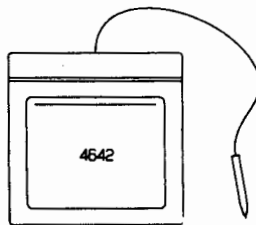

# EDP Equipment

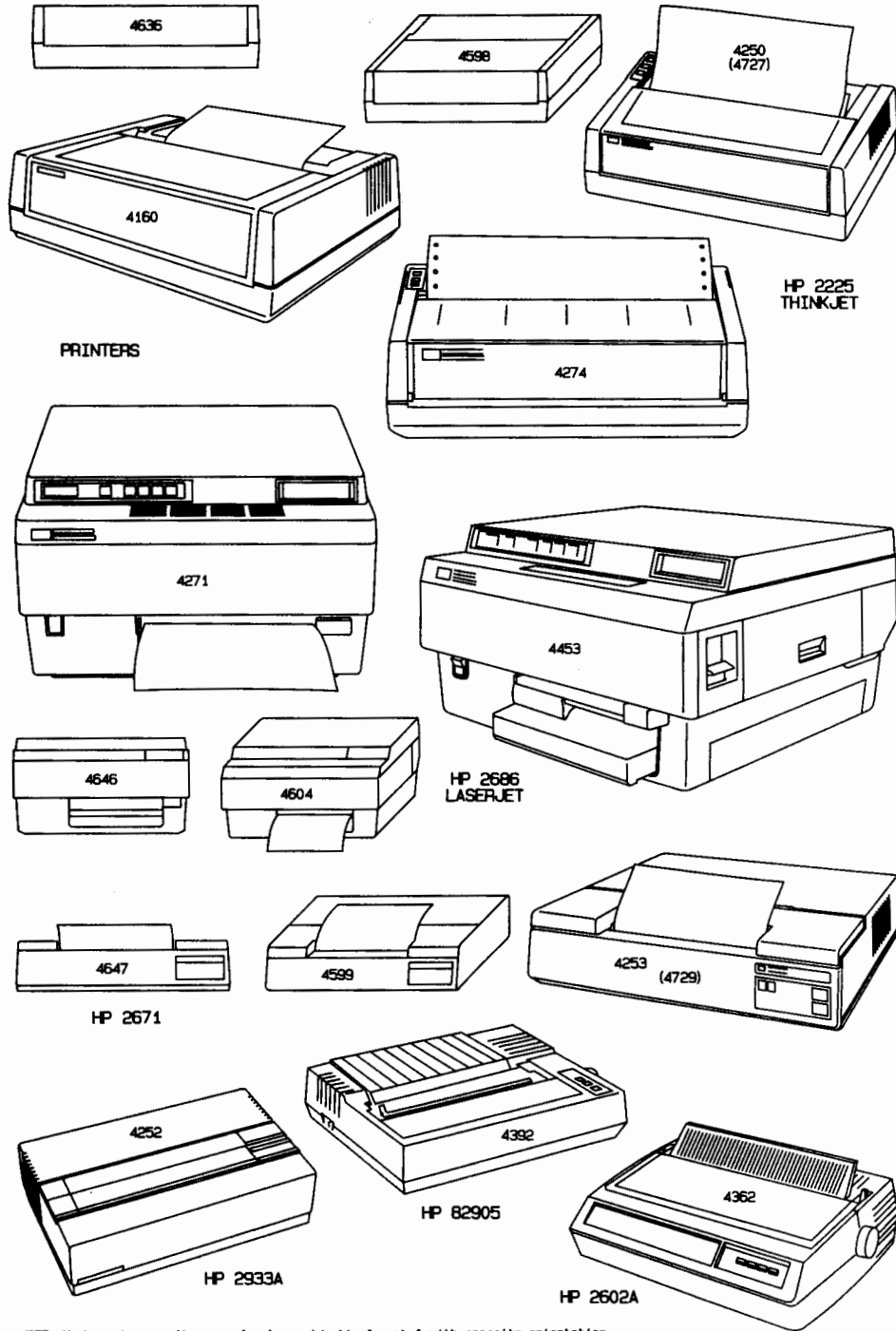

NOTE: Numbers in parentheses refer to an identical symbol with opposite orientation.

# EDP Equipment



HP 82168A  
ACOUSTIC COUPLER

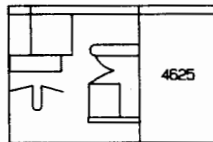
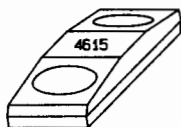

HP 2680A  
LASER PRINTER

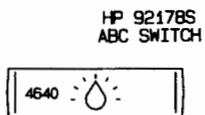
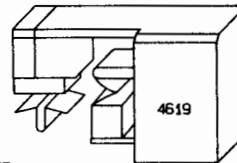

HP 92178S  
ABC SWITCH

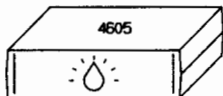

HP 3468A  
DIGITAL MULTIMETER

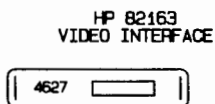
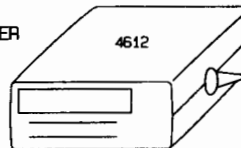
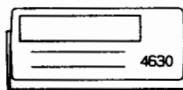

HP 82163  
VIDEO INTERFACE

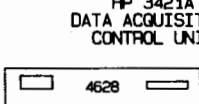
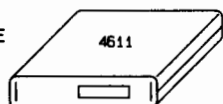

HP 3421A  
DATA ACQUISITION  
CONTROL UNIT

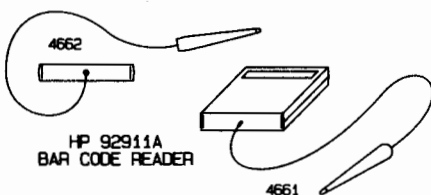
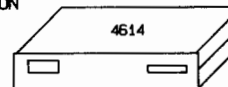

HP 92911A  
BAR CODE READER

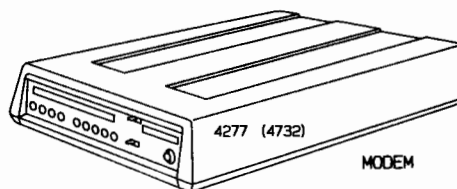

MODEM

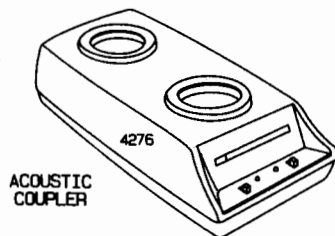

ACOUSTIC  
COUPLER

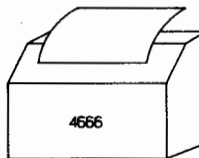

PRINTER

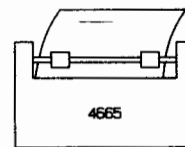

PRINTER

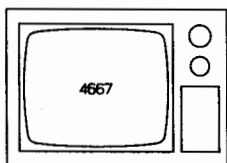

TV MONITOR



INPUT DOCUMENTS

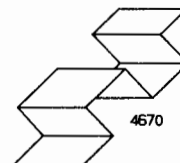

COMPUTER FORMS

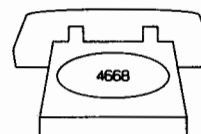

TELEPHONE

NOTE: Numbers in parentheses refer to an identical symbol with opposite orientation.



# EDP Equipment

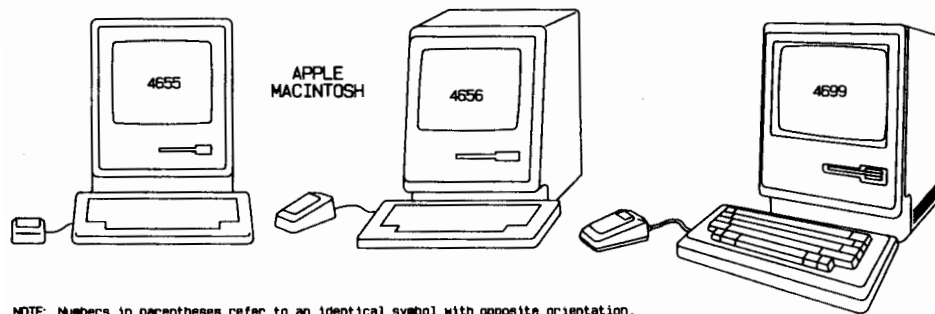
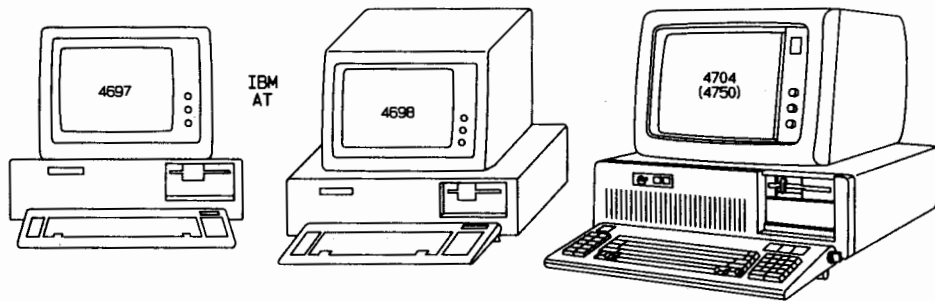
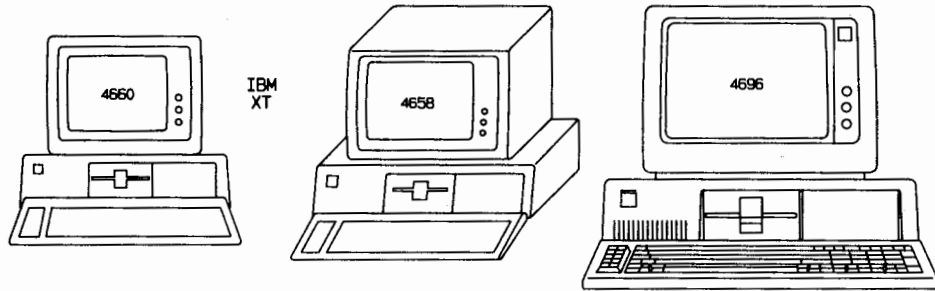
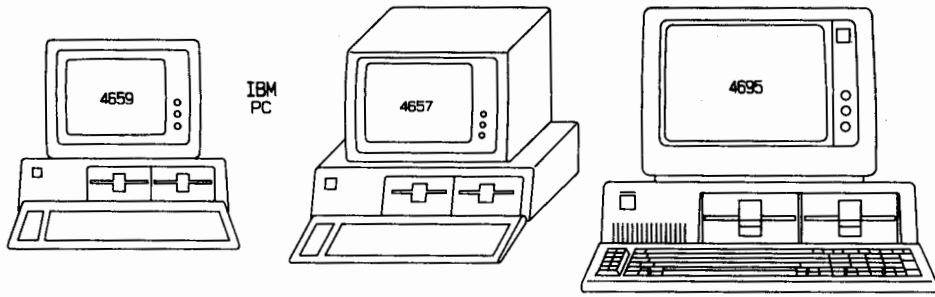

NOTE: Numbers in parentheses refer to an identical symbol with opposite orientation.

# Pipe Fittings and Valves

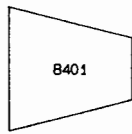

B401  
BUSHING



B402  
BUSHING

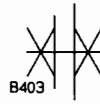

B403  
BUSHING



B404  
BUSHING

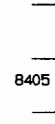

B405  
CAP



B406  
CAP



B412  
CROSSOVER



B413  
CROSSOVER

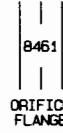

B461  
ORIFICE  
FLANGE

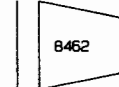

B462  
REDUCING  
FLANGE



B407  
CROSS

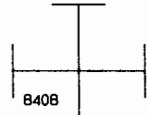

B408  
CROSS

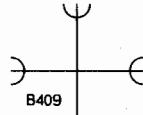

B409  
CROSS

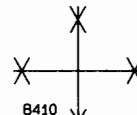

B410  
CROSS

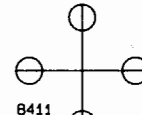

B411  
CROSS

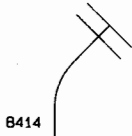

B414  
ELBOW  
45-DEGREE

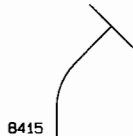

B415  
ELBOW  
45-DEGREE

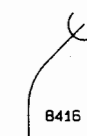

B416  
ELBOW  
45-DEGREE



B417  
ELBOW  
45-DEGREE



B418  
ELBOW  
45-DEGREE

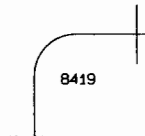

B419  
ELBOW  
90-DEGREE

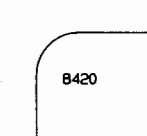

B420  
ELBOW  
90-DEGREE

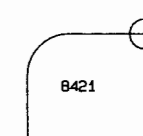

B421  
ELBOW  
90-DEGREE

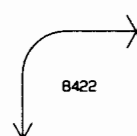

B422  
ELBOW  
90-DEGREE

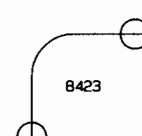

B423  
ELBOW  
90-DEGREE

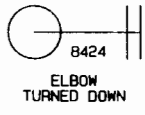

B424  
ELBOW  
TURNED DOWN

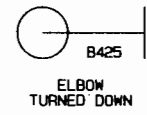

B425  
ELBOW  
TURNED DOWN

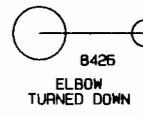

B426  
ELBOW  
TURNED DOWN

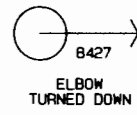

B427  
ELBOW  
TURNED DOWN

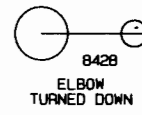

B428  
ELBOW  
TURNED DOWN

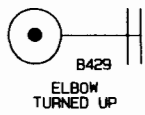

B429  
ELBOW  
TURNED UP

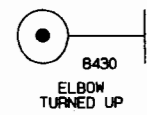

B430  
ELBOW  
TURNED UP

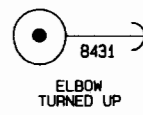

B431  
ELBOW  
TURNED UP

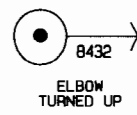

B432  
ELBOW  
TURNED UP

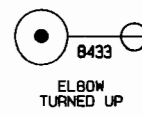

B433  
ELBOW  
TURNED UP

# Pipe Fittings and Valves

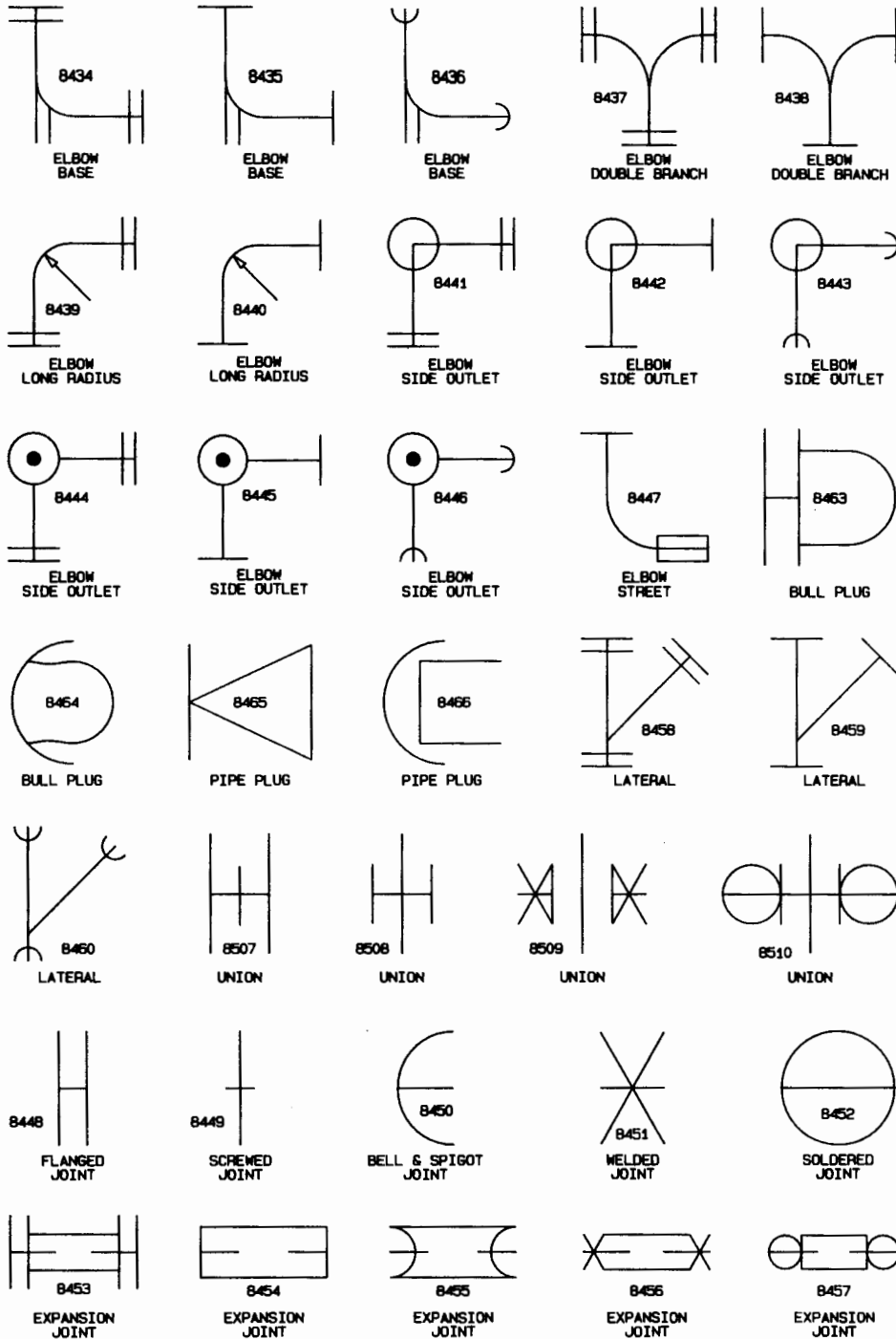

# Pipe Fittings and Valves

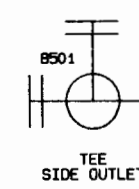
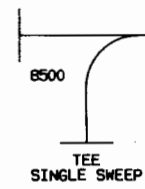
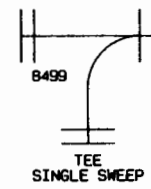
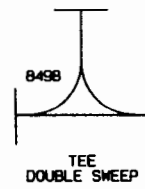
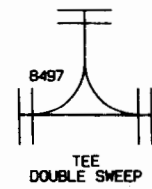
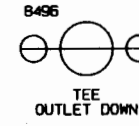
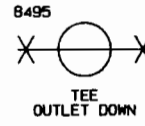
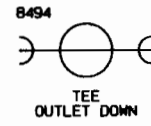
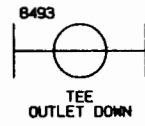
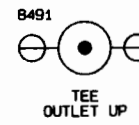
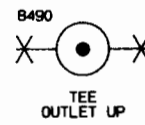
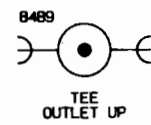
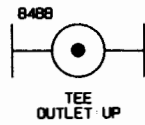
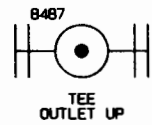
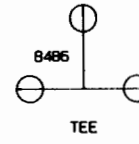
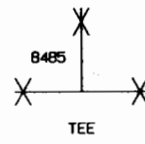
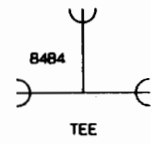
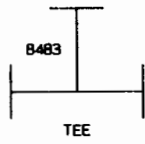
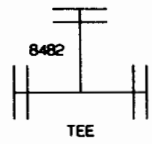
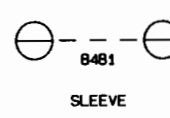
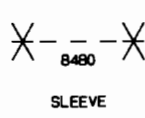
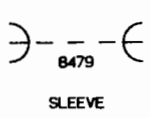
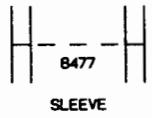
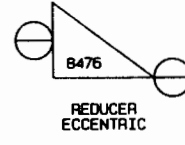
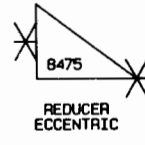
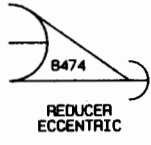
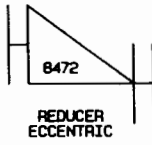
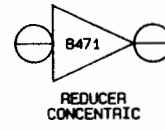
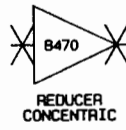
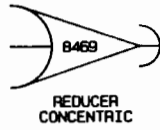
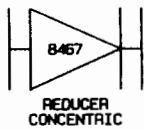

# Pipe Fittings and Valves

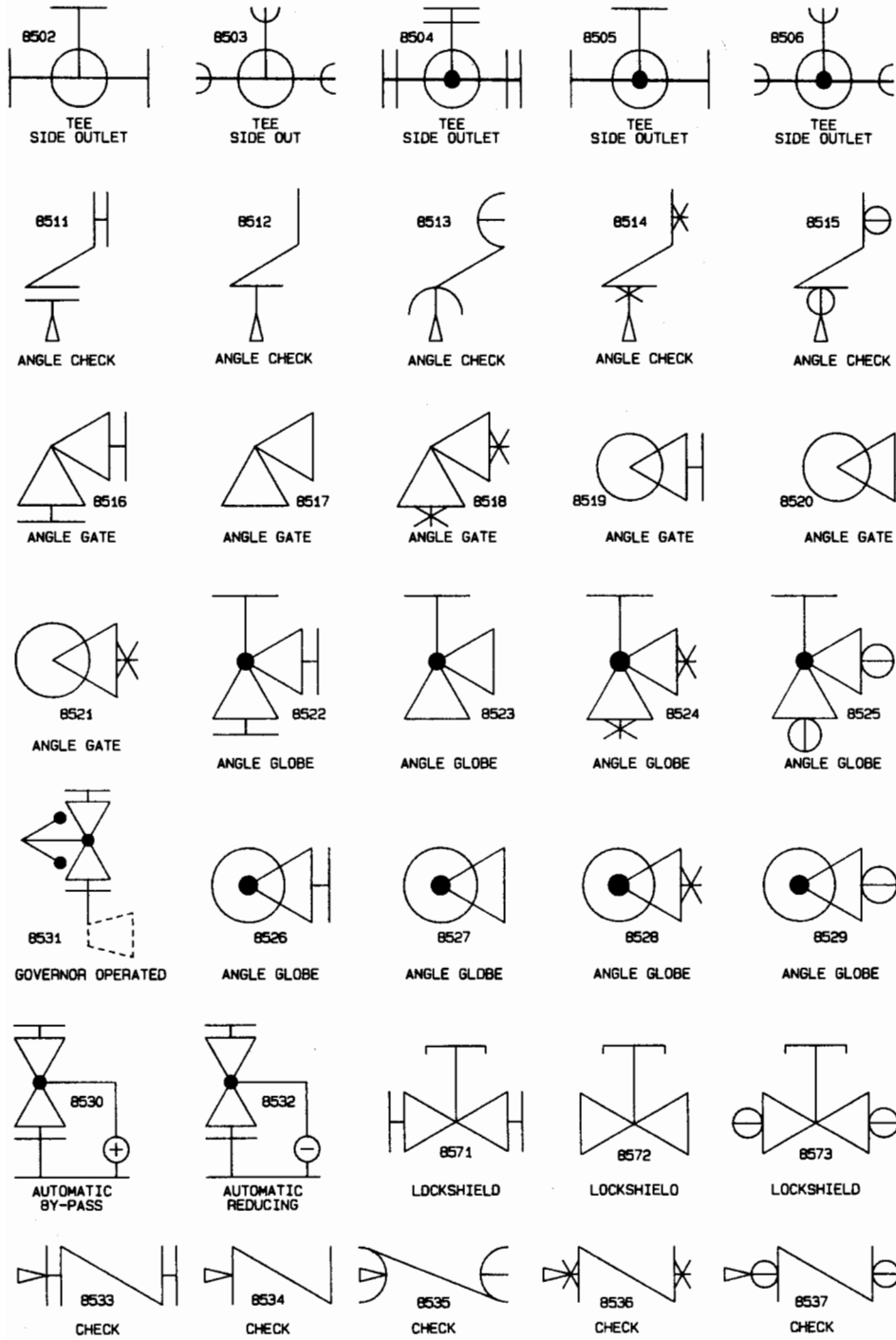

# Pipe Fittings and Valves

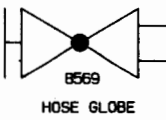
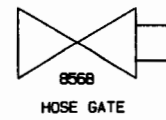
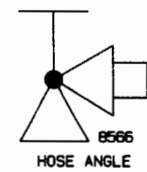
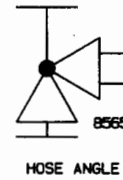
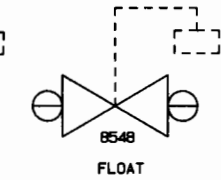
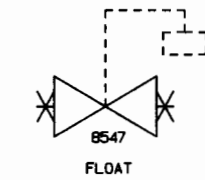
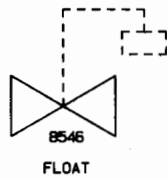
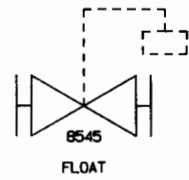
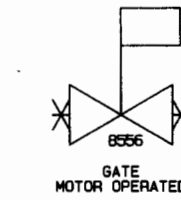
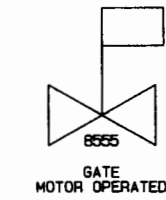
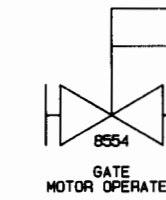
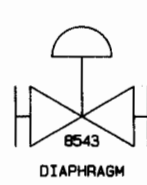
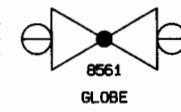
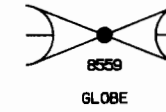
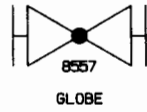
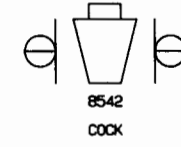
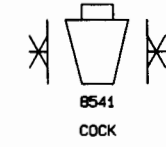
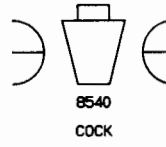
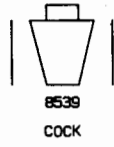
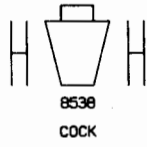
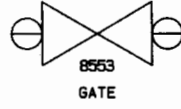
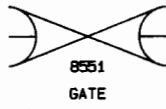
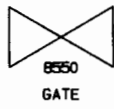
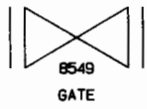

# Pipe Fittings and Valves

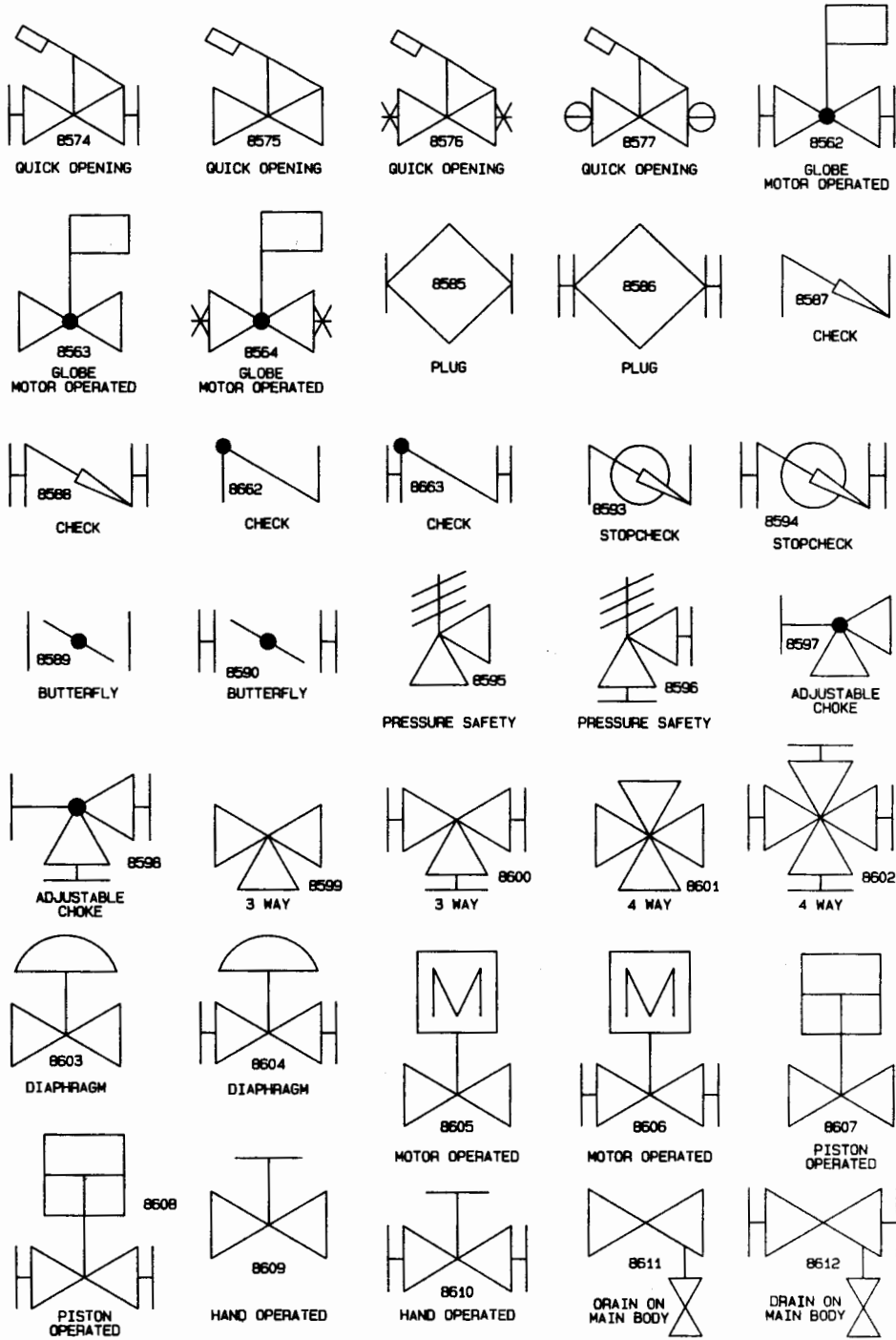

# Pipe Fittings and Valves

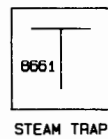
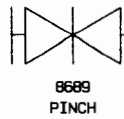
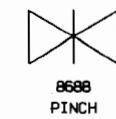
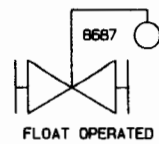
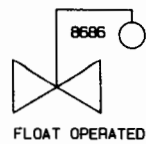
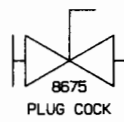
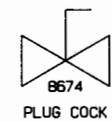
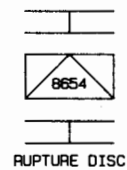
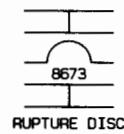
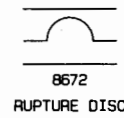
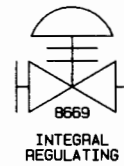
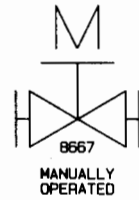
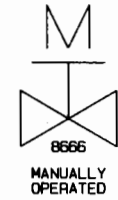
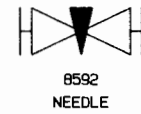
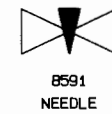
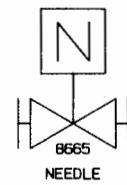
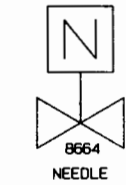
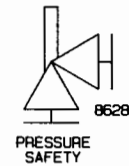
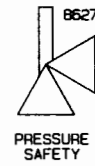
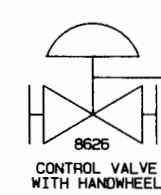
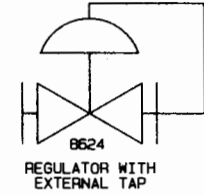
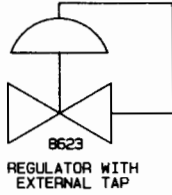
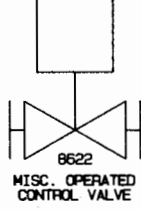
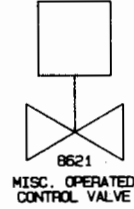
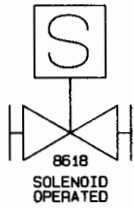
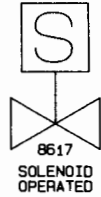
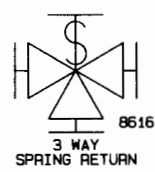
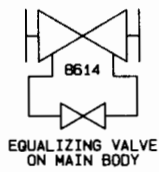
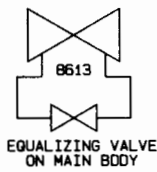



# Pipe Fittings and Valves

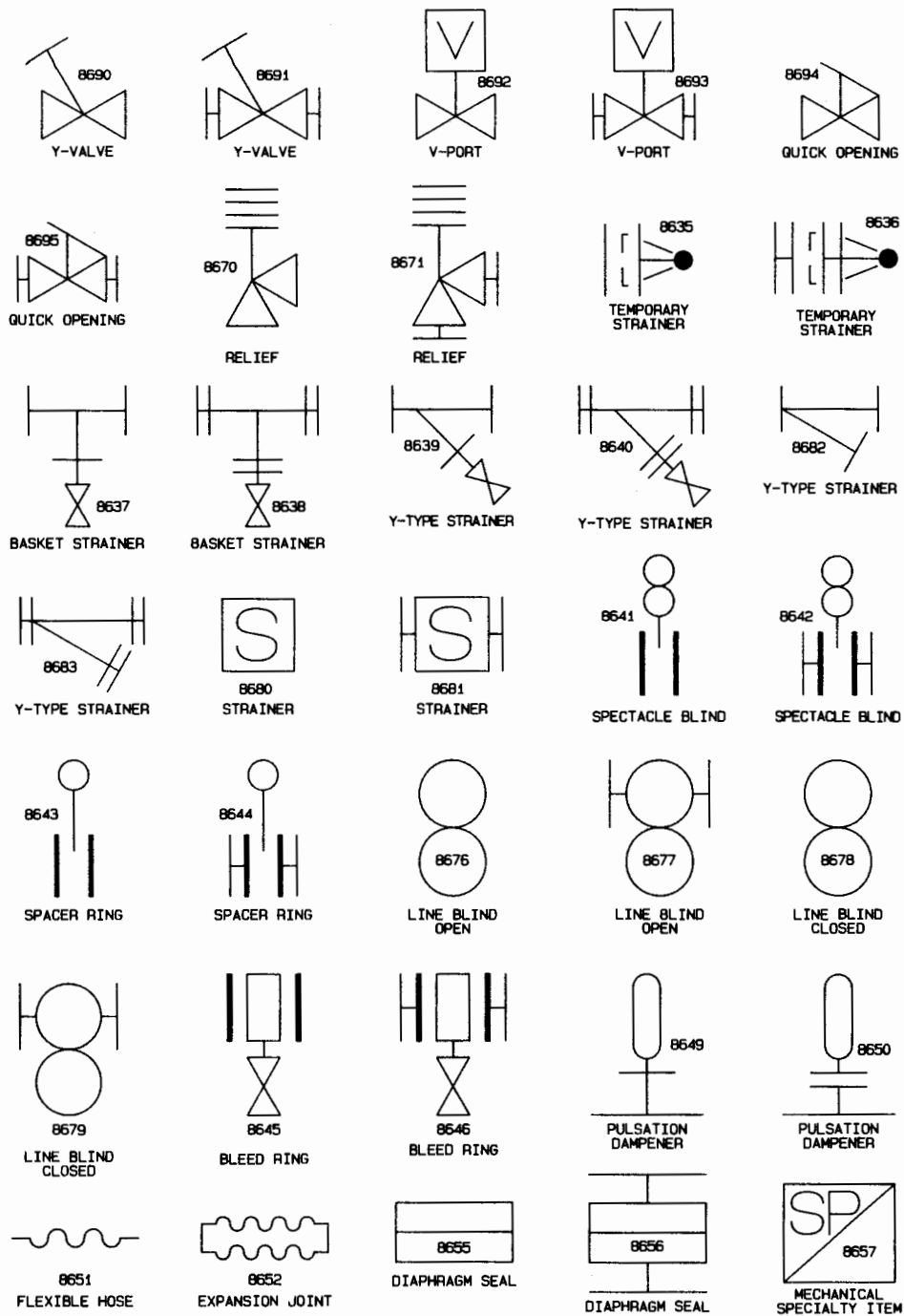

# Pipe Fittings and Valves

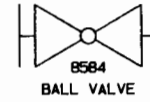
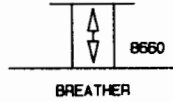
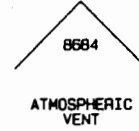
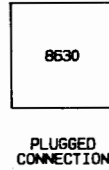
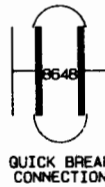
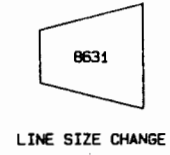
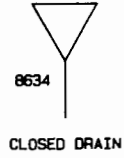
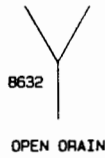

## TOKENS

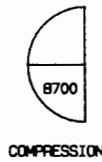
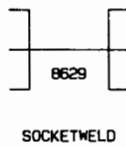
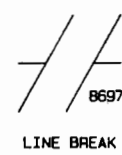
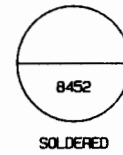
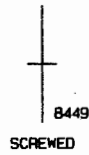
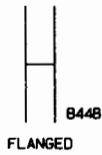

## LINE TYPES

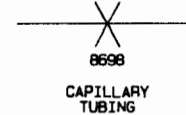
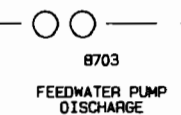
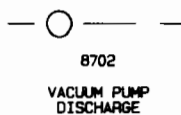
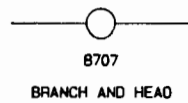
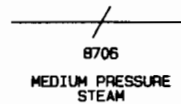

# Pulp and Paper Process Flow

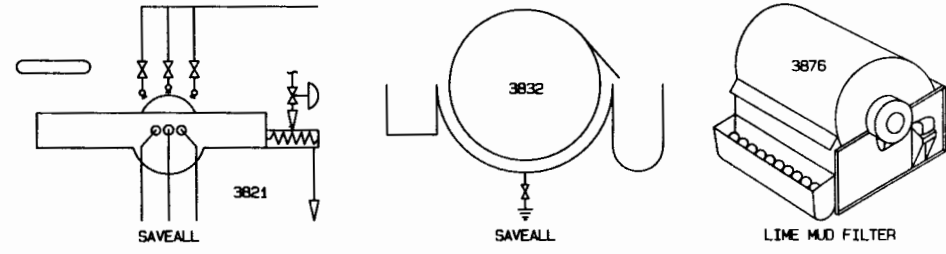
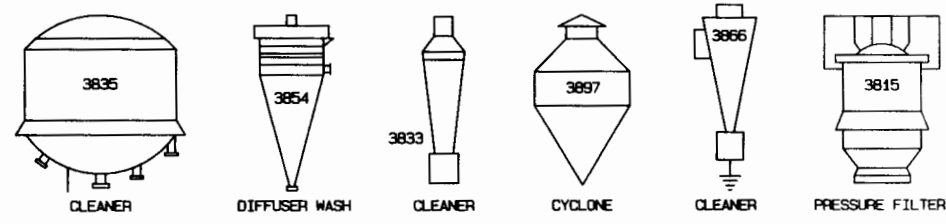
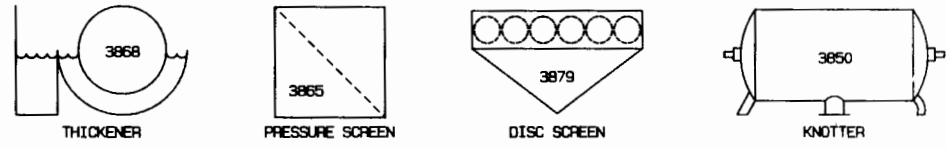
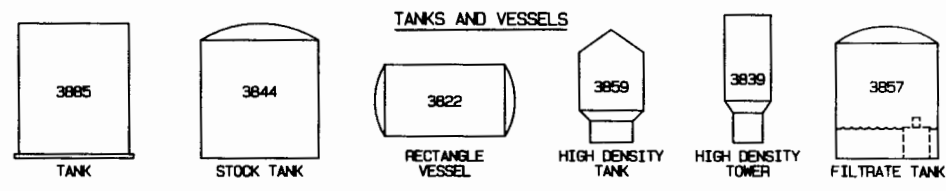
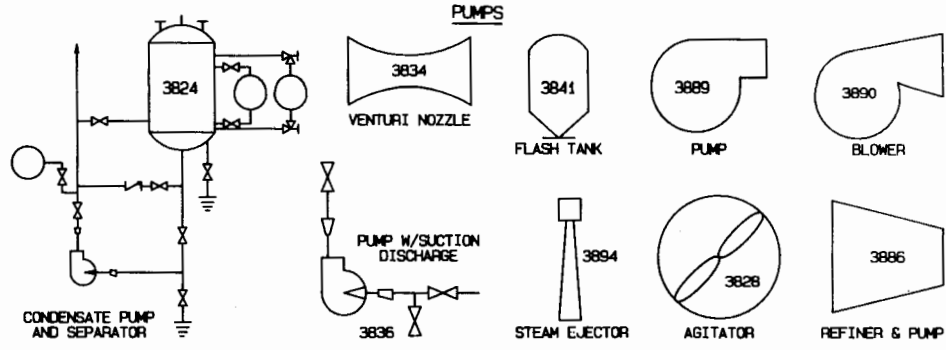

# Pulp and Paper Process Flow

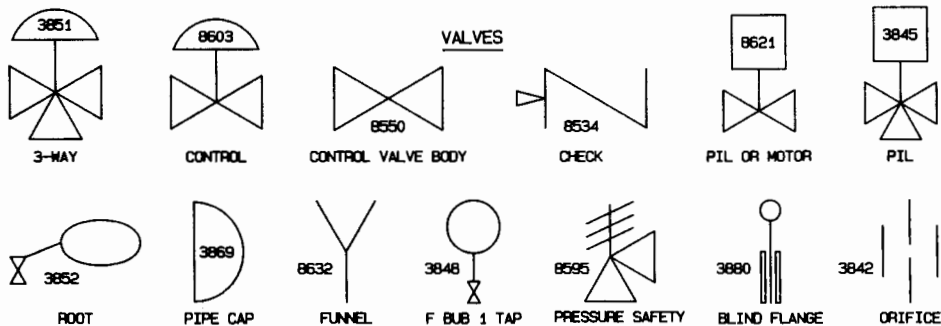

## PAPER MACHINE EQUIPMENT

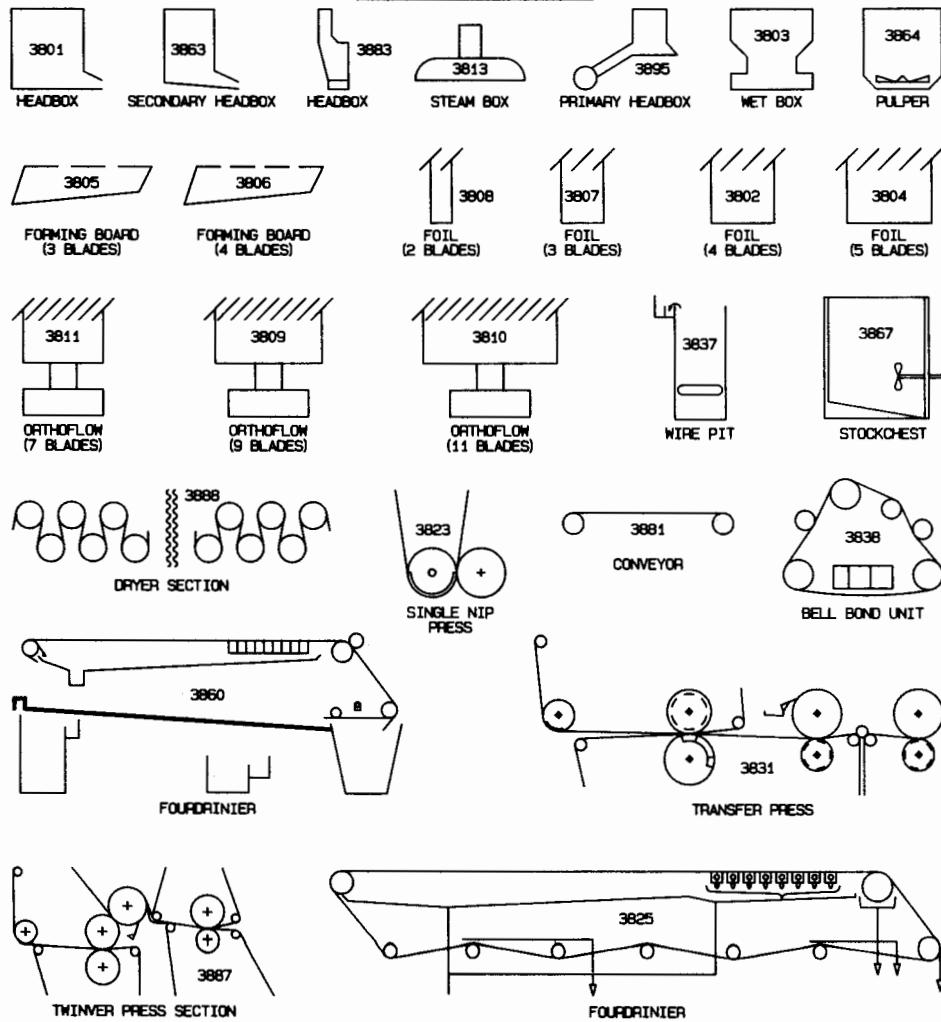

# Pulp and Paper Process Flow

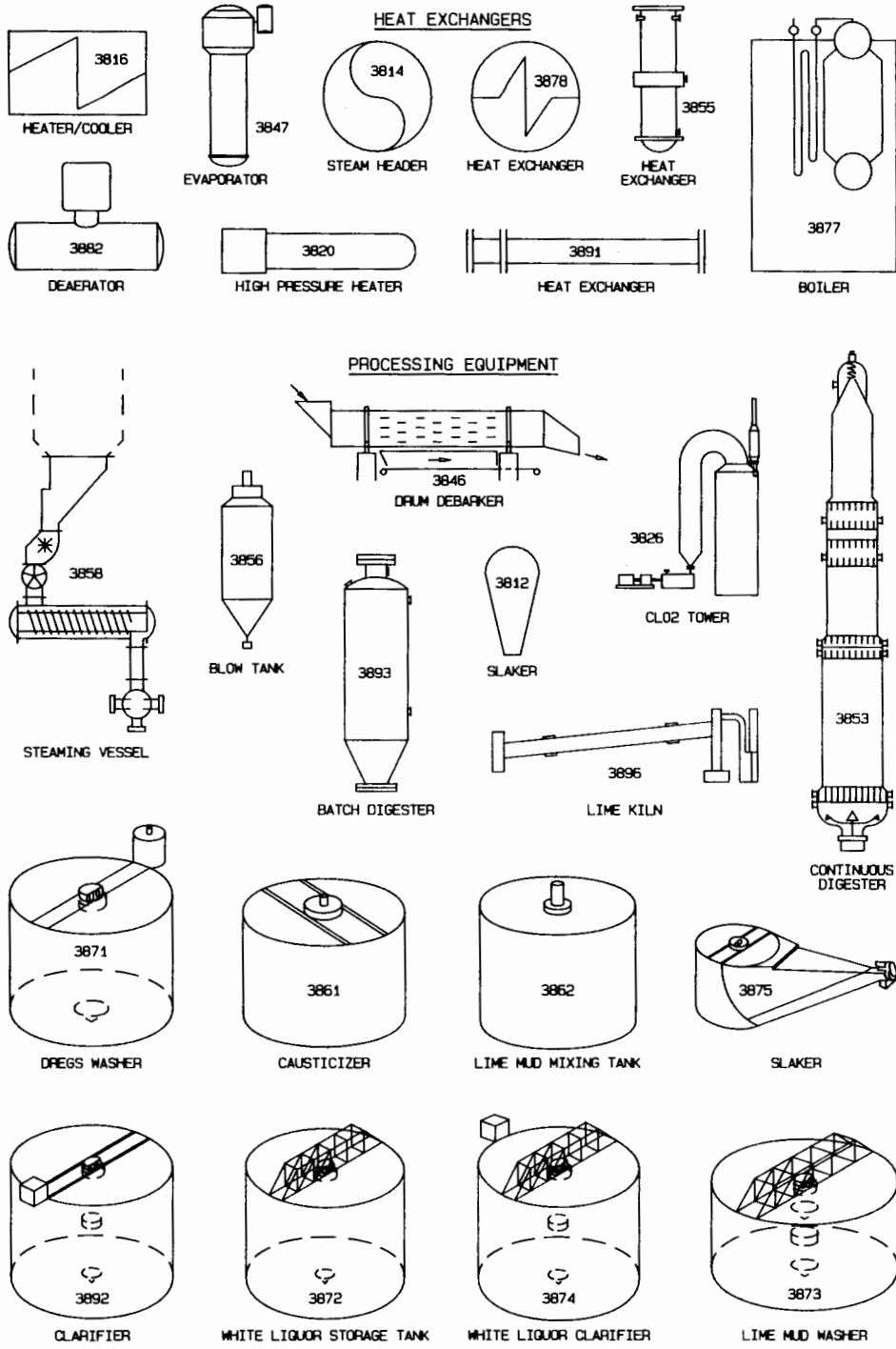

# Chemical and Petroleum Process Flow

## MIXING & SEPARATING EQUIPMENT

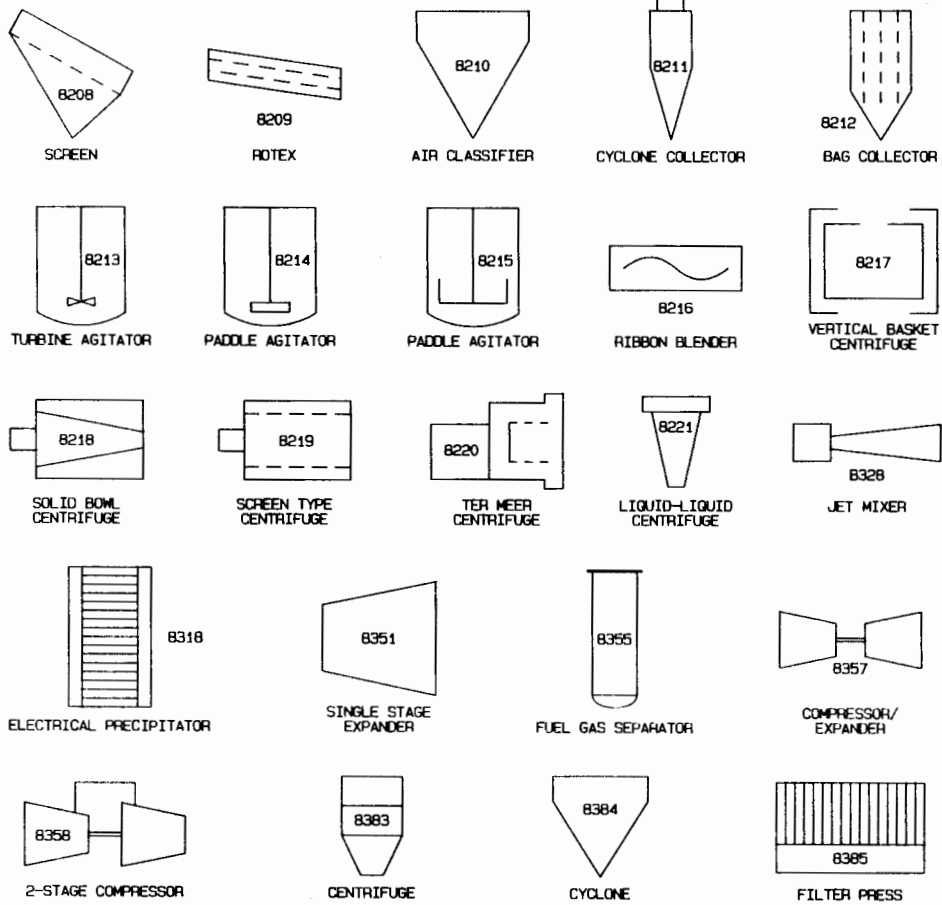

## INSTRUMENTS

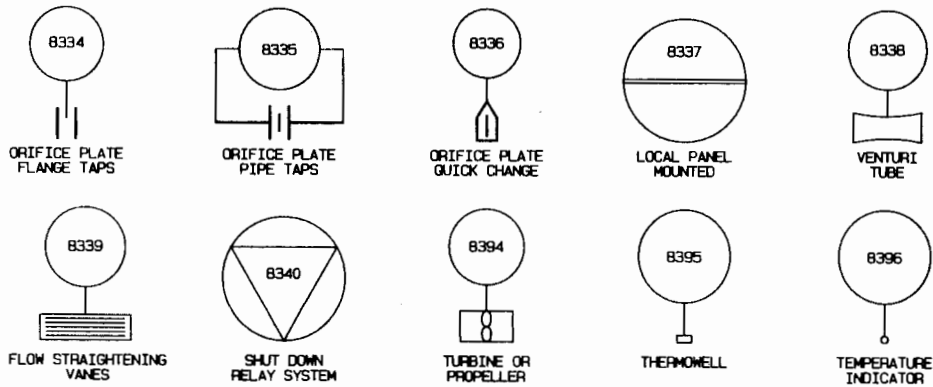

# Chemical and Petroleum Process Flow

## TRANSPORTATION

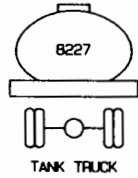
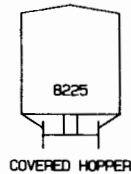
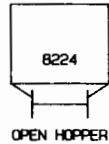
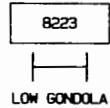

## FEEDERS & CONVEYORS

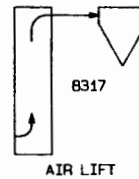
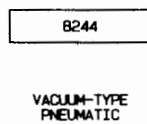
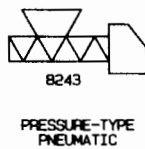
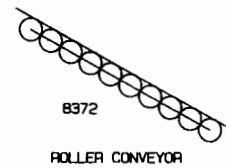
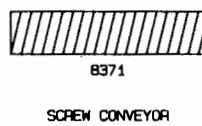
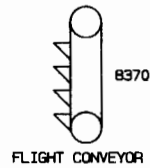
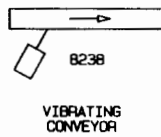
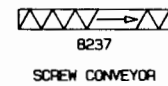
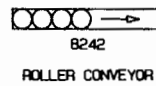
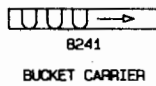
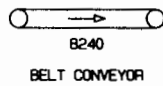
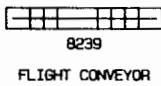
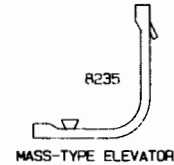
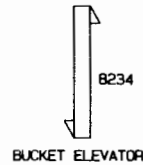
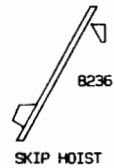
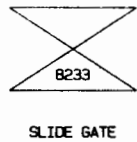
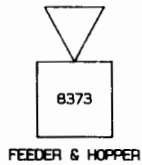
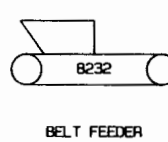
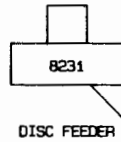
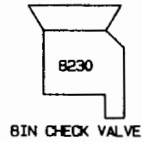

# Chemical and Petroleum Process Flow

## COLUMNS, TANKS & VESSELS

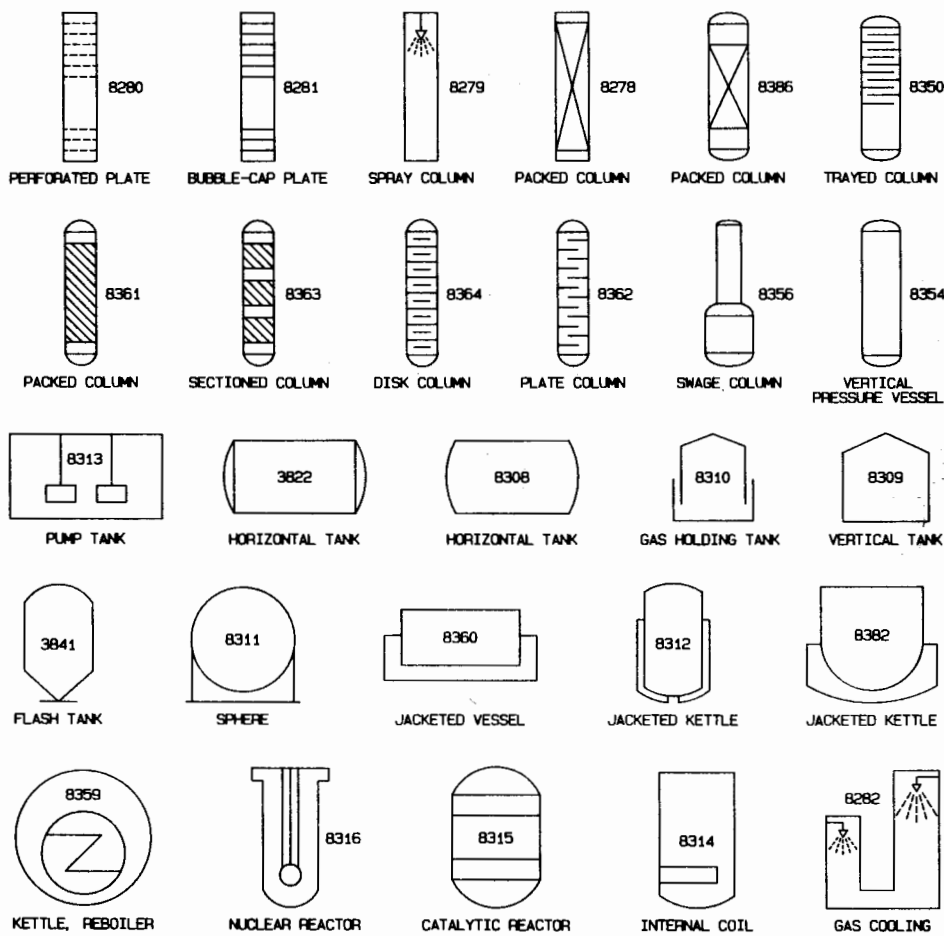

## INSTRUMENT LINES

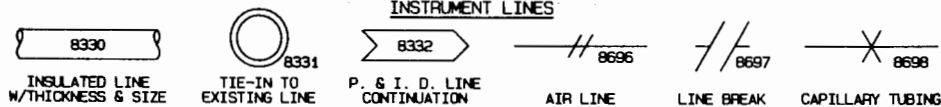

## PROCESS QUANTITIES

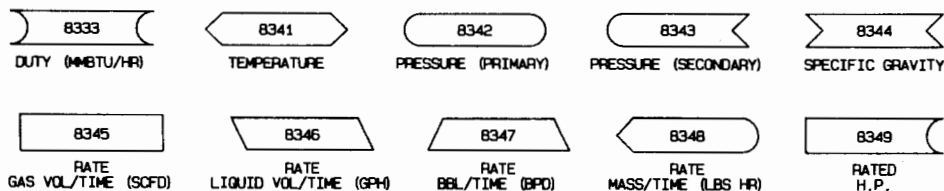



# Chemical and Petroleum Process Flow

## PUMPS

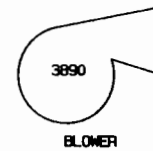
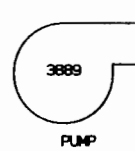
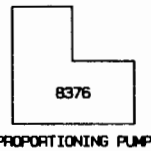
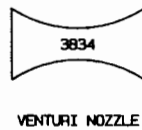
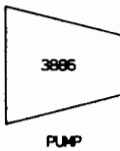
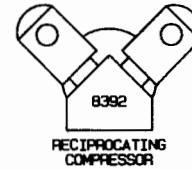
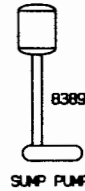
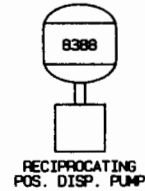
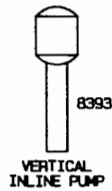
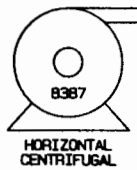
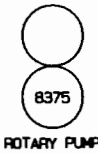
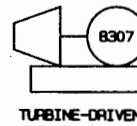
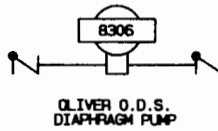
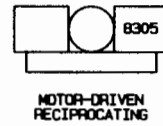
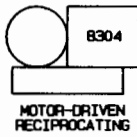
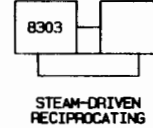
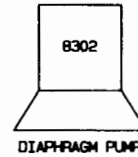
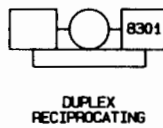
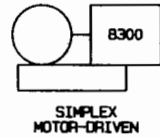
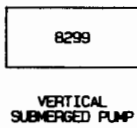
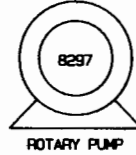
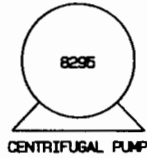
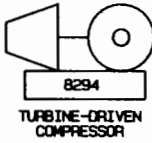
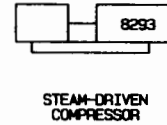
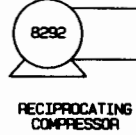
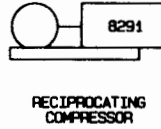
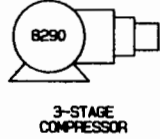
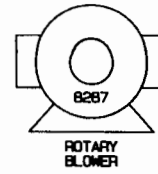
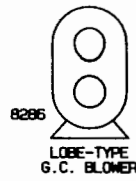
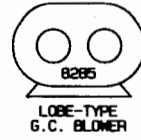
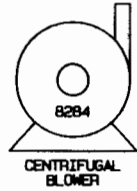
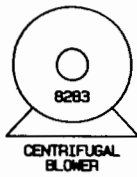

# Chemical and Petroleum Process Flow

## SIZE REDUCTION EQUIPMENT

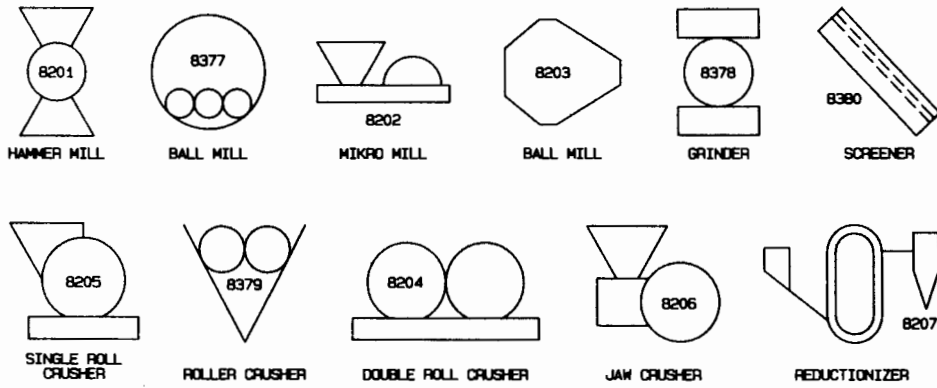

## DRYING EQUIPMENT

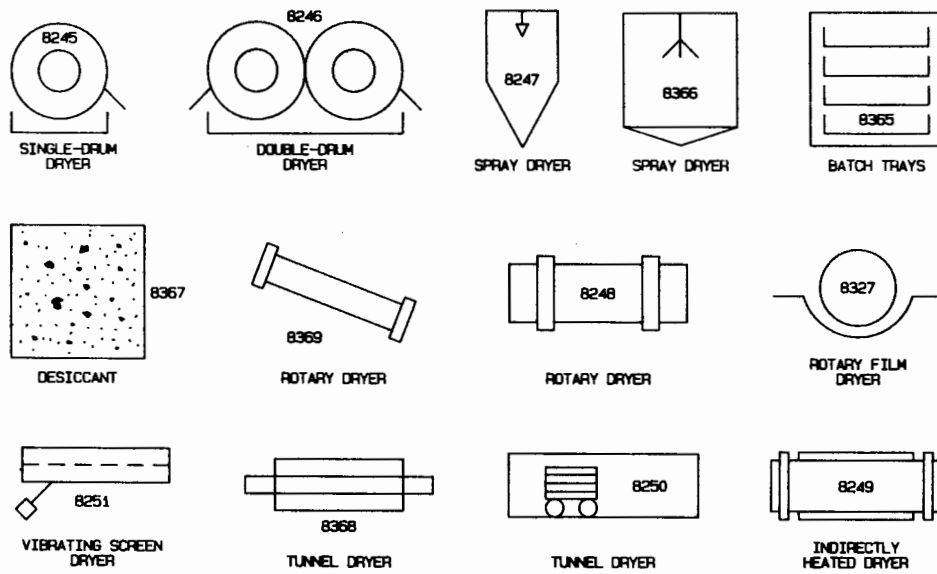

## PROCESSING EQUIPMENT

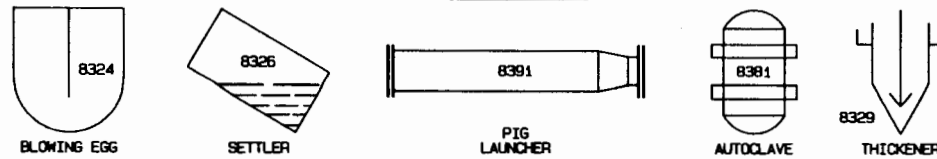

# Chemical and Petroleum Process Flow

## HEAT EXCHANGERS

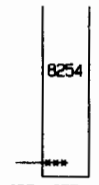

8254  
OPEN STEAM TO TOWER

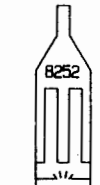

8252  
FIRED HEATER



8253  
FIRED HEATER

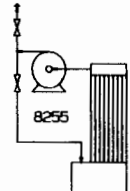

8255  
AUXILIARY HEATER

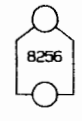

8256  
2-DRUM WASTE HEAT BOILER

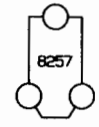

8257  
3-DRUM WASTE HEAT BOILER

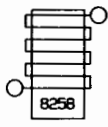

8258  
ECONOMIZER

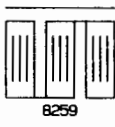

8259  
DOWN-DRAFT COOLER

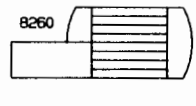

8260  
WASTE HEAT BOILER

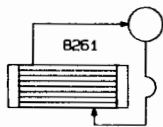

8261  
WASTE HEAT BOILER

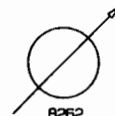

8262  
COOLER

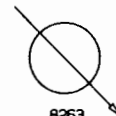

8263  
HEATER



8264  
SHELL AND TUBE TYPE



8265  
SHELL AND TUBE TYPE



8266  
SPIRAL TYPE

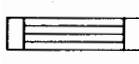

8267  
SHELL AND TUBE TYPE



8268  
SHELL AND TUBE TYPE



8269  
TWO-PASS TUBE SIDE

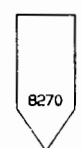

8270  
BAROMETRIC CONDENSER

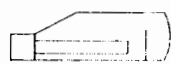

8271  
KETTLE-TYPE REBOILER

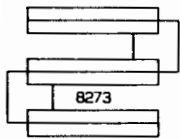

8273  
DOUBLE PIPE



8272  
AIR-COOLED EXCHANGER

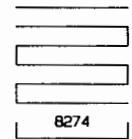

8274  
CASCADE COOLER

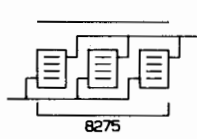

8275  
Z & NR TYPE COOLER

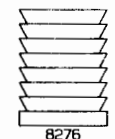

8276  
WATER COOLING RACK

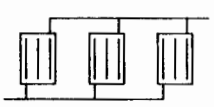

8277  
WAFFLE COOLERS

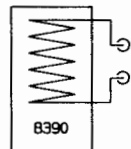

8390  
ELECTRIC HEATER

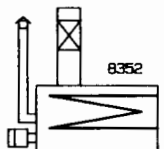

8352  
GLYCOL REBOILER

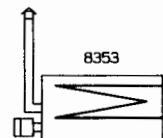

8353  
SALT BATH HEATER

## DRIVERS

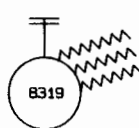

8319  
MOTOR

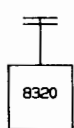

8320  
SINGLE-DRIVE ENGINE



8321  
DUAL-DRIVE ENGINE

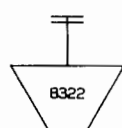

8322  
TURBINE



8323  
STEAM PISTON

# Chemical and Petroleum Process Flow

## VALVES & FITTINGS

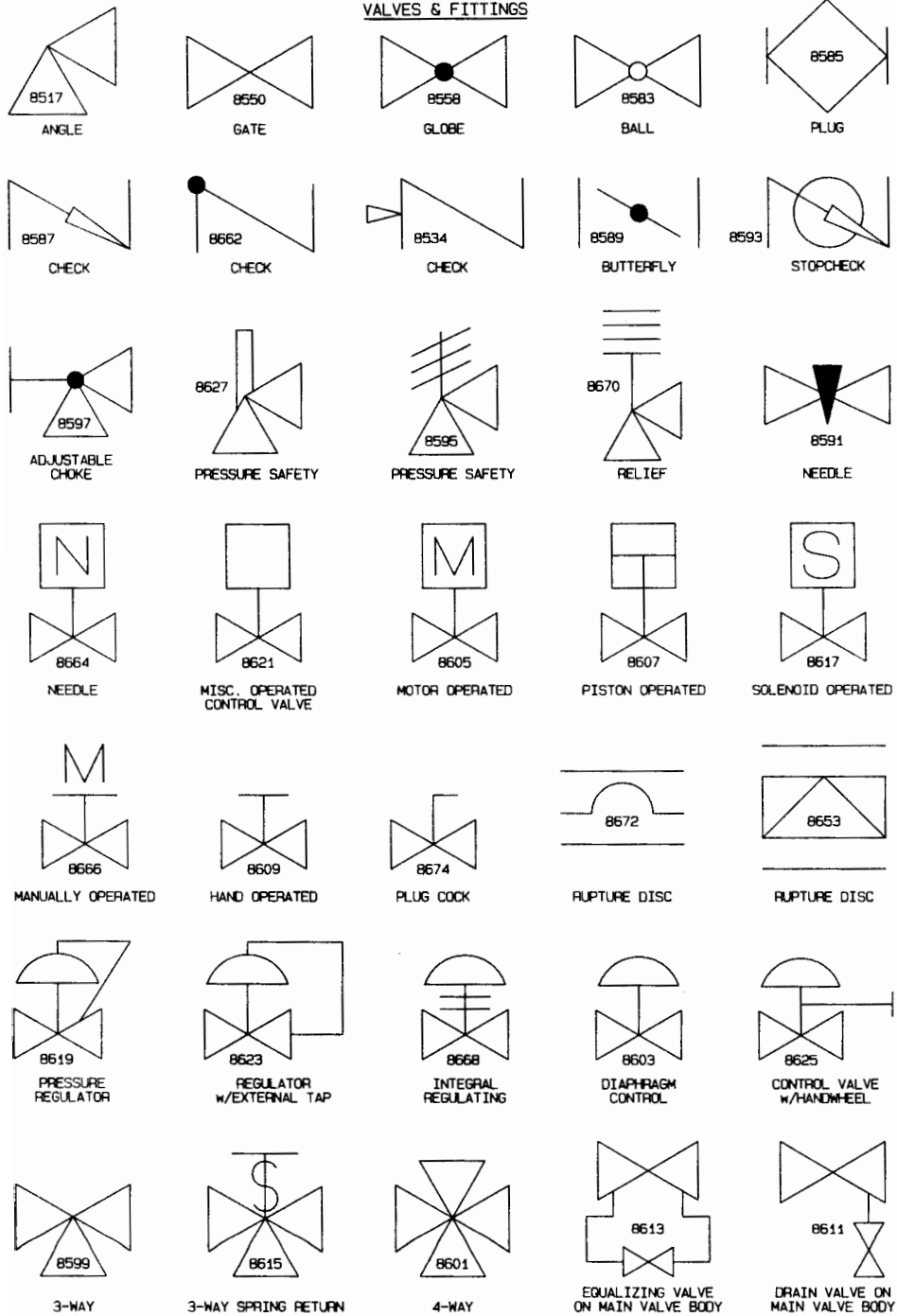

# Chemical and Petroleum Process Flow

## VALVES & FITTINGS

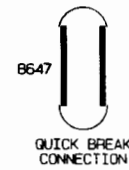
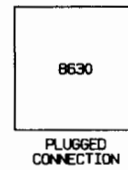
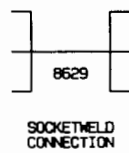
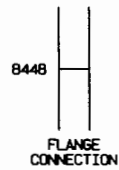
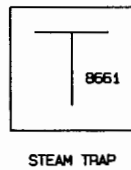
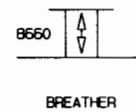
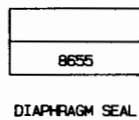
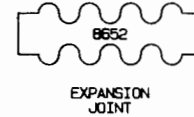
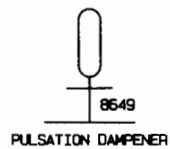
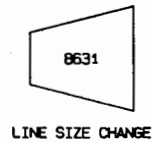
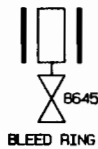
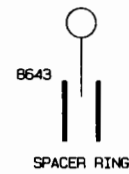
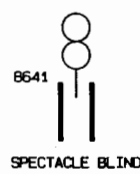
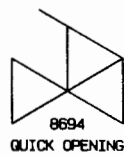
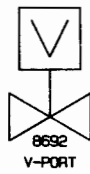
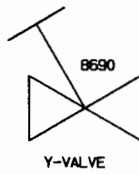
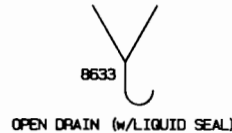
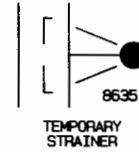
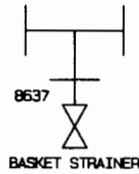
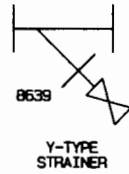
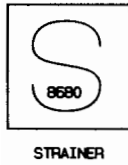
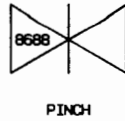
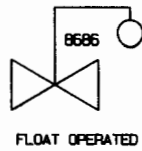
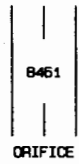

# 6 U.S. Maps

---



To use the U.S. Maps library on the HP 150 "Touchscreen" personal computer, you must have at least 384K of memory. This requirement is due to the number and complexity of the symbols that are necessary to complete a typical map.

Regardless of the amount of memory available, some symbols are too complex to be shaded using Version 3.0 of Diagraph. All of the icon, low and medium resolution state symbols can be shaded with the exception of the medium resolution version of Alaska. The states and metropolitan areas that are bordered by rivers or the coastline of the U.S. will not shade in high resolution.

The U.S. Maps library (#18) is shipped on two discs labeled Optional Libraries. To install the libraries, follow the instructions on page viii at the front of this manual.

The Sample Maps discs contain a series of maps that have been prepared using the U.S. Maps library and saved as Diagraph files. You can modify and customize the sample maps to suit your needs. See page 6-39 for more information about the sample maps.

To create your own maps, combine symbols from the following categories:

- Outline of the U.S.
- States scaled to state boundaries
- States scaled to regions
- States scaled to the U.S.
- Metropolitan areas

The state symbols are available in four resolutions: icon, low, medium and high. The icon and low resolution versions are ideal when presenting data that requires a generalized map to convey the geographic nature of the data. The simplified boundaries also allow you to greatly reduce the size of the map.

## Requirements

## Introduction

---

## *U.S. Maps, continued*

---

The medium resolution state symbols are appropriate when printing or plotting a map of the United States on 8½ × 11 inch paper. The high resolution state symbols should be used when plotting maps on larger sized paper or when producing an 8½ × 11 inch map of an individual state.

The U.S. Maps library, unlike most of the other Diagraph symbol libraries, requires an understanding of how to overlay symbols that are scaled to the same boundaries. In addition, it is important to review the use of Erase by Re-draw, No Shading and “invisible symbols”.

### **Overlaying Symbols**

The map symbols were designed to be used individually or in combination with other symbols that share the same boundaries.

To overlay symbols, they must be scaled to the same boundary, such as the outline of the U.S., a region or metropolitan area and be of the same resolution.

For example, you can overlay symbols 6161 (U.S. outline) and 6165 (drop shadow) as shown below. Both are icons scaled to the U.S.



---

*U.S. Maps, continued*

---

Similarly, you can overlay symbols 7219 (Maine), 7229 (New Hampshire) and 7245 (Vermont) as shown below.

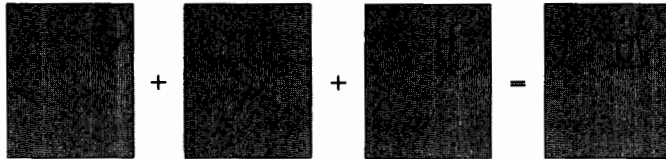

Notice that the frame (grey area) surrounding each state symbol indicates the size of the Northeast region and the relative position of the state within that region.

By overlaying symbols you can vary the color, linetype and shading pattern of each component of the map. For example, the icon symbols 6161 (outline), 6162 (state lines) and 6116 (Kansas) are overlaid to create a map of the U.S. with Kansas solid-shaded for emphasis.

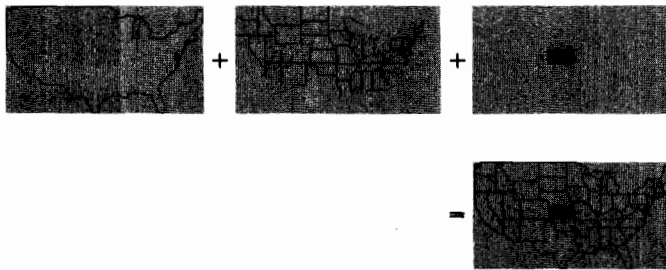

The following procedure outlines the process of building maps by overlaying symbols so that they are perfectly aligned and the same scale relative to each other.

**Building  
Maps**



Begin with a single proportioned symbol. Use the LARGER SYMBOL and SMALLER SYMBOL functions to size the symbol. Use the arrow keys and rotate functions to position the symbol relative to the page border. Use the flashing frame of the first symbol to position the map on the page. If the symbol is scaled to a region, the flashing frame defines the size and position of the entire region, as shown on page 6-3. Once the map is complete, you can reposition and resize the symbols.

To overlay the first symbol,

**Press** 

**Press** 

When the Symbol menu appears at the top of the screen, type the number of the second symbol.

**Press** 

**Press** 

**Press** 

The second symbol appears in the proper location and scale relative to the first symbol.

---

## U.S. Maps, continued

---

To overlay another symbol,

Press 

When the Symbol menu appears at the top of the screen, type the number of the third symbol.

Press 

Press 

Repeat the procedure to overlay any other symbols that are necessary to complete the map.

The Erase by Re-draw option is at the User Aids level. When the option is "on," as indicated by an asterisk in the function key, you can change, move, size, or rotate a symbol, without clearing the entire area defined by the flashing frame.

**Erase by  
Re-draw**

The No Shading option is available at the Set Plot Options level. If you need to move or resize a map, you can eliminate the time it takes to shade each symbol on the screen by turning off the shading. The time saved is even more significant if Erase by Re-draw is on because Diagraph must shade a symbol to erase it.

**Turn Off  
Shading**

To add titles, legends and footnotes to a map, add a rectangle (#1001) and move it outside of the page border. Thereafter, use the symbol as a source of text nodes which can be moved anywhere on the map. Note that any text associated with a map symbol will be windowed if the map symbol is shaded.

**Adding Text  
To Maps**

**Invisible Symbols**

To overprint text on a shaded symbol without windowing, add an "invisible" symbol to the map.

Press 

Press 

Specify symbol #1001 (rectangle) and change the Linetype to "0".

Press 

Press 

Press 

The invisible rectangle will coincide with the frame surrounding the state, region or outline of the U.S. Add text to the invisible symbol and position the text anywhere on the map. As the text belongs to the invisible symbol it will not be windowed when the map is shaded.

If you adjust the position or size of the map, perform the same operations on the invisible symbol to ensure that the text will appear in the correct location relative to the updated map symbols.

**Identifying Symbols**

When symbols are overlaid, the flashing frame does not identify the active symbol because all of the symbols share the same boundary.

To identify which symbol is active,

**Press** 

Identify the active symbol by the number in the Symbol menu and,

**Press** 

Press the Next key to select the next symbol and repeat the process until the desired symbol is identified.

If the overlaid symbols are states, to identify the active state symbol,

**Press** 

The blinking text node identifies the active symbol. If the node does not fall within the boundaries of the desired state,

**Press** 

**Press** 

**Press** 

### **Identifying State Symbols**

The blinking text node identifies the next state in the sequence the symbols were added. Continue switching state symbols until the desired state is identified.

### **Repositioning Maps**

It is possible to reposition a map, consisting of overlaid symbols, without disturbing the alignment of the symbols. A useful aid in this process is the Align Symbol function.

With Erase by Re-draw turned on, move the first symbol to the desired location.

**Press** 

**Press** 

The area defined by the flashing frame will be highlighted.

Press the Next key to activate the next symbol and use the align functions to align each symbol with the highlighted reference symbol.

**Note: Do NOT attempt to visually align the symbols on the screen or combine moving and sizing operations in a single procedure.**

### **Resizing Maps**

To change the size of a map consisting of overlaid symbols, use the following procedures to ensure the alignment of the symbols.

With Erase by Re-draw turned on, select the first symbol and from the Size Symbol level,

Press 

or,

Press 

until the symbol is the desired size.

You must use the LARGER SYMBOL and SMALLER SYMBOL functions to proportionately change the size of the symbols.

Be sure to note the number of times (keystrokes) you press LARGER SYMBOL or SMALLER SYMBOL.

When the first symbol is the desired size, change the Frame option from "N" to "Y" on the Symbol menu. The frame around the first symbol can then be used for reference when sizing subsequent symbols. While the frame cannot be used to ensure the perfect alignment of the symbols, you will know that an error has occurred if the flashing frame of a subsequent symbol does not coincide with the frame around the first (reference) symbol.

Press the Next key to activate the next symbol and repeat the process using the same number of keystrokes.

It is recommended that you save the Diagraph file under different filenames several times during the resizing process. Then, if you discover an error later on in the process, you can restore the previous version without starting over.

**Plotting  
Maps**

When shading overlaid symbols on a plotter, the outline of the symbols should be plotted after the symbols are shaded to prevent bleeding. Place the pen to be used as the "outline pen" (usually black) in well #1 of the plotter. The number assigned to the symbol outline pen should be one greater than the number of pens available in your plotter. That is, if you have a six pen plotter, assign pen seven as the outline pen. Once all of the other symbols and text have been plotted, a message will appear at the top of the screen asking you to change pens. Press YES and Diagraph will plot the outline of the symbols.

**World  
Maps**

Included with the U.S. Maps library are icon versions of the World (#7997), North & South America (#7998), and Europe, Asia & Africa (#7999).



## U.S. Maps State Symbols

	Icon U.S.	Low Resolution			Medium Resolution			High Resolution		
		State	U.S.	Region	State	U.S.	Region	State	U.S.	Region
Alabama	6101	7001	7101	7201	7301	7401	7501	7601	7701	7801
Alaska	6102	7002	7102	....	7302	7402	....	7602	7702	....
Aleutian Islands	....	....	....	....	....	....	....	7651	7751	....
Arizona	6103	7003	7103	7203	7303	7403	7503	7603	7703	7803
Arkansas	6104	7004	7104	7204	7304	7404	7504	7604	7704	7804
California	6105	7005	7105	7205	7305	7405	7505	7605	7705	7805
Colorado	6106	7006	7106	7206	7306	7406	7506	7606	7706	7806
Connecticut	6107	7007	7107	7207	7307	7407	7507	7607	7707	7807
Delaware	6108	7008	7108	7208	7308	7408	7508	7608	7708	7808
District of Columbia	....	....	....	....	7352	7452	7552	7652	7752	7852
Florida	6109	7009	7109	7209	7309	7409	7509	7609	7709	7809
Georgia	6110	7010	7110	7210	7310	7410	7510	7610	7710	7810
Hawaii	6111	7011	7111	....	7311	7411	....	7611	7711	....
Idaho	6112	7012	7112	7212	7312	7412	7512	7612	7712	7812
Illinois	6113	7013	7113	7213	7313	7413	7513	7613	7713	7813
Indiana	6114	7014	7114	7214	7314	7414	7514	7614	7714	7814
Iowa	6115	7015	7115	7215	7315	7415	7515	7615	7715	7815
Kansas	6116	7016	7116	7216	7316	7416	7516	7616	7716	7816
Kentucky	6117	7017	7117	7217	7317	7417	7517	7617	7717	7817
Louisiana	6118	7018	7118	7218	7318	7418	7518	7618	7718	7818
Maine	6119	7019	7119	7219	7319	7419	7519	7619	7719	7819
Maryland	6120	7020	7120	7220	7320	7420	7520	7620	7720	7820
Massachusetts	6121	7021	7121	7221	7321	7421	7521	7621	7721	7821
Michigan	6122	7022	7122	7222	7322	7422	7522	7622	7722	7822
Minnesota	6123	7023	7123	7223	7323	7423	7523	7623	7723	7823
Mississippi	6124	7024	7124	7224	7324	7424	7524	7624	7724	7824
Missouri	6125	7025	7125	7225	7325	7425	7525	7625	7725	7825
Montana	6126	7026	7126	7226	7326	7426	7526	7626	7726	7826
Nebraska	6127	7027	7127	7227	7327	7427	7527	7627	7727	7827
Nevada	6128	7028	7128	7228	7328	7428	7528	7628	7728	7828
New Hampshire	6129	7029	7129	7229	7329	7429	7529	7629	7729	7829
New Jersey	6130	7030	7130	7230	7330	7430	7530	7630	7730	7830
New Mexico	6131	7031	7131	7231	7331	7431	7531	7631	7731	7831
New York	6132	7032	7132	7232	7332	7432	7532	7632	7732	7832
North Carolina	6133	7033	7133	7233	7333	7433	7533	7633	7733	7833
North Dakota	6134	7034	7134	7234	7334	7434	7534	7634	7734	7834
Ohio	6135	7035	7135	7235	7335	7435	7535	7635	7735	7835
Oklahoma	6136	7036	7136	7236	7336	7436	7536	7636	7736	7836
Oregon	6137	7037	7137	7237	7337	7437	7537	7637	7737	7837
Pennsylvania	6138	7038	7138	7238	7338	7438	7538	7638	7738	7838
Rhode Island	6139	7039	7139	7239	7339	7439	7539	7639	7739	7839
South Carolina	6140	7040	7140	7240	7340	7440	7540	7640	7740	7840
South Dakota	6141	7041	7141	7241	7341	7441	7541	7641	7741	7841
Tennessee	6142	7042	7142	7242	7342	7442	7542	7642	7742	7842
Texas	6143	7043	7143	7243	7343	7443	7543	7643	7743	7843
Utah	6144	7044	7144	7244	7344	7444	7544	7644	7744	7844
Vermont	6145	7045	7145	7245	7345	7445	7545	7645	7745	7845
Virginia	6146	7046	7146	7246	7346	7446	7546	7646	7746	7846
Washington	6147	7047	7147	7247	7347	7447	7547	7647	7747	7847
West Virginia	6148	7048	7148	7248	7348	7448	7548	7648	7748	7848
Wisconsin	6149	7049	7149	7249	7349	7449	7549	7649	7749	7849
Wyoming	6150	7050	7150	7250	7350	7450	7550	7650	7750	7850



# U.S. Maps - Icon

## U.S. Outline with State Lines and City Indicators

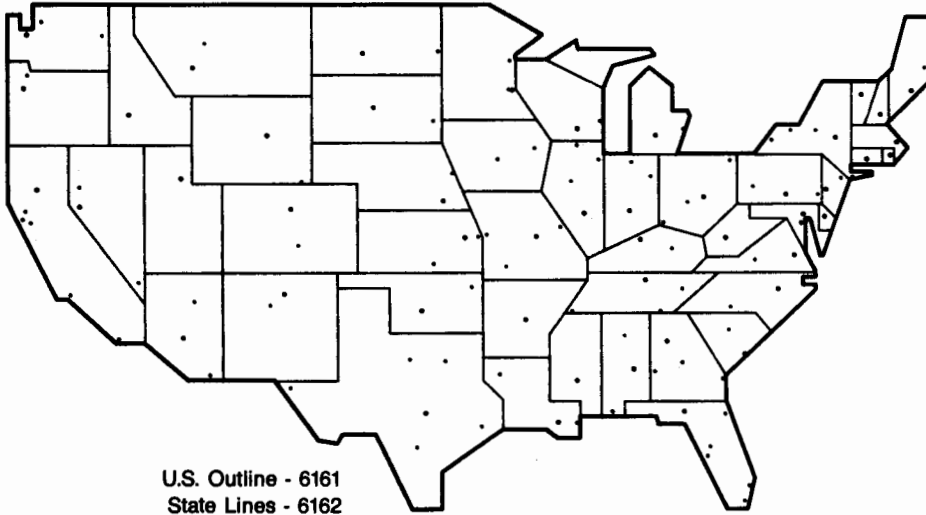

U.S. Outline - 6161  
State Lines - 6162  
City Indicators - 6163

## U.S. Outline with Time Zones

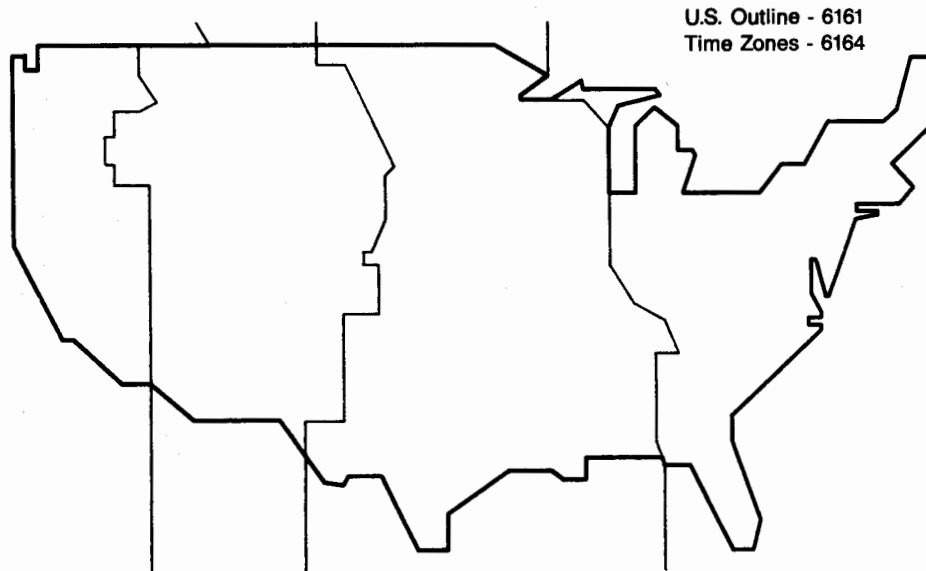

U.S. Outline - 6161  
Time Zones - 6164

**U.S. Maps - Icon**

**U.S. Outline with Drop Shadow 1**

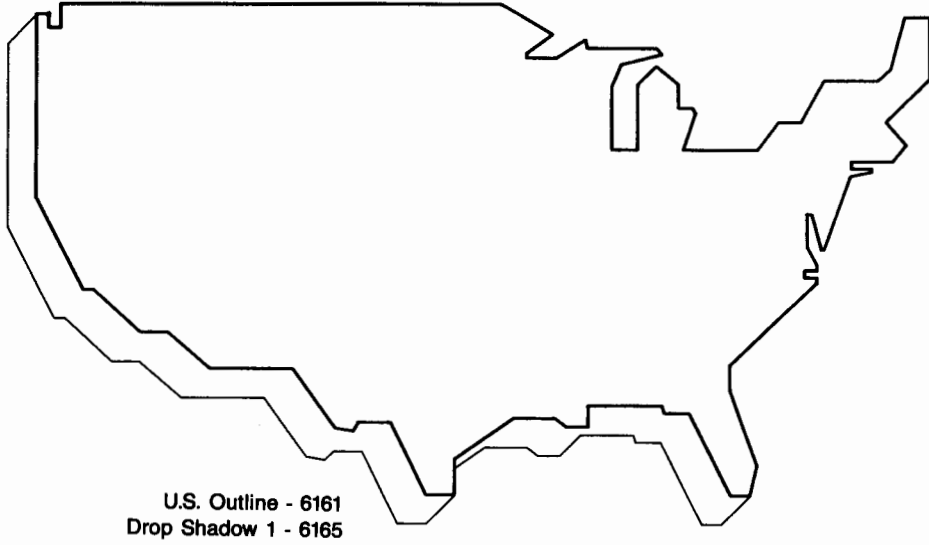

**U.S. Outline with Drop Shadow 2**

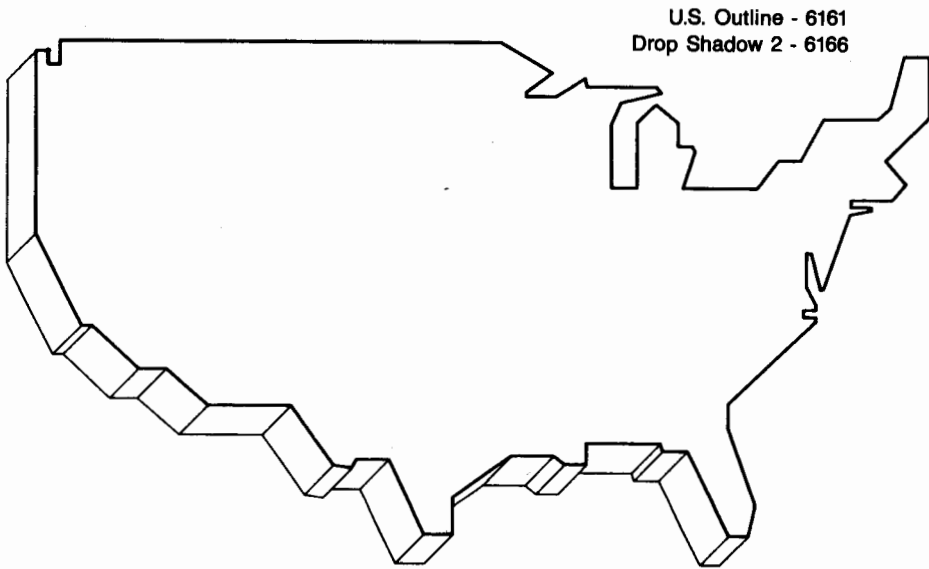

**U.S. Maps - Icon**  
**States Scaled to the U.S.**

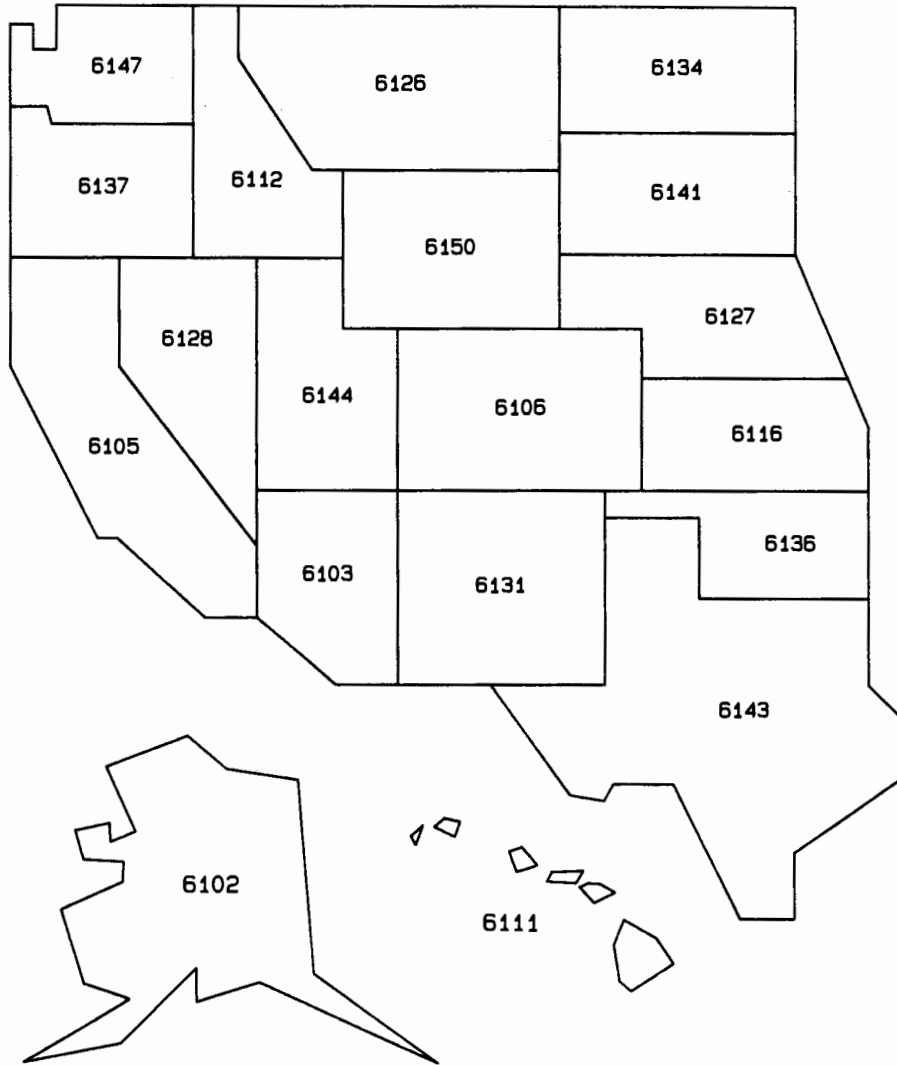

The icon state symbols were designed using as few lines as possible to represent the shape of each state. Vertical and horizontal lines were used predominantly.

**U.S. Maps - Icon**  
**States Scaled to the U.S.**

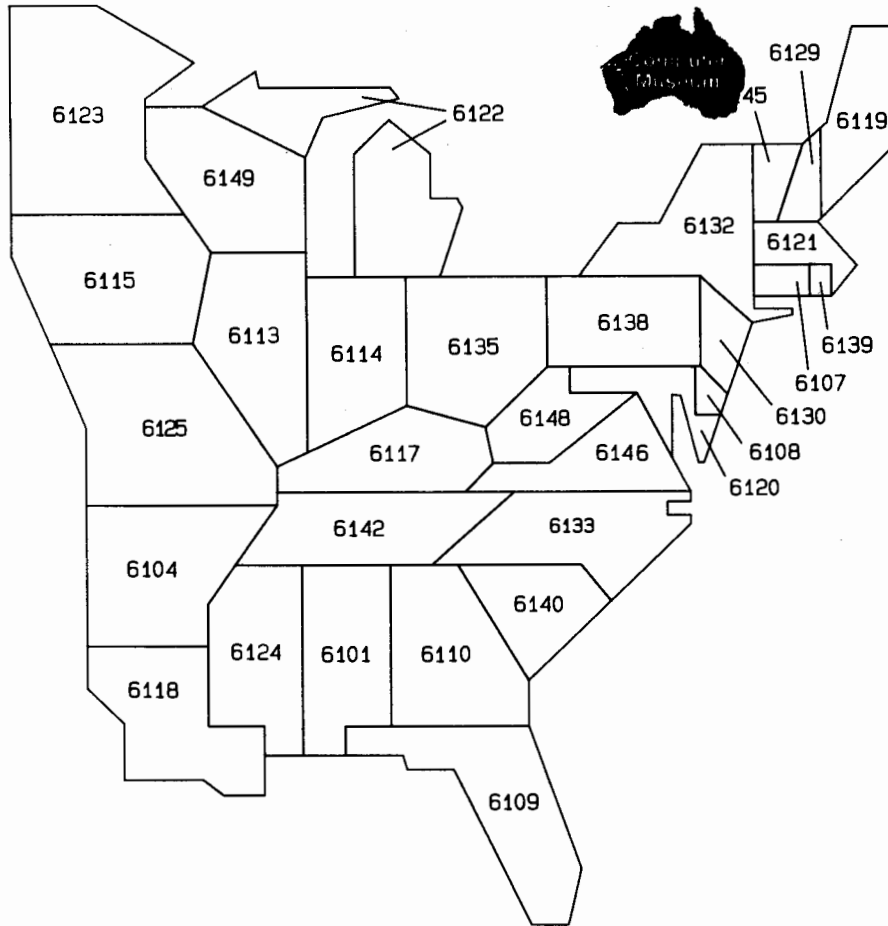

Each of the icon state symbols is scaled to the outline of the U.S. To build a map of the U.S. or a portion thereof, combine the symbols as explained in the introduction to the U.S. Maps library.

A map of the U.S., combining the icon symbols shown above is saved as a Diagraph file on the Sample Maps #1 disc. To display the map, load "US-2-1".

**U.S. Maps - Low Resolution**  
**U.S. Outline with State Lines and City Indicators**

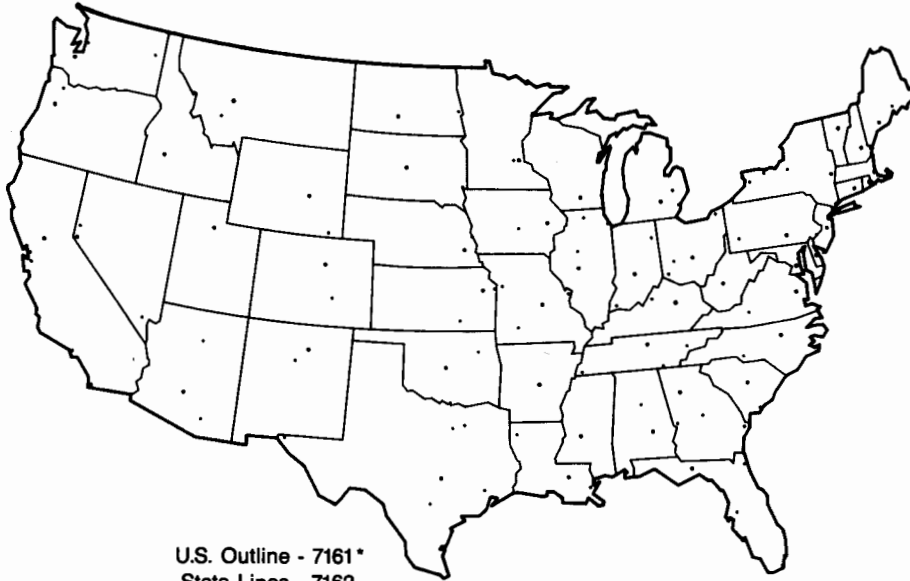

U.S. Outline - 7161\*  
State Lines - 7162  
City Indicators - 7163

**U.S. Outline with Time Zones**



U.S. Outline - 7161\*  
Time Zones - 7164

\*Does not shade

**U.S. Maps - Low Resolution**

**U.S. Outline with Drop Shadow 1**

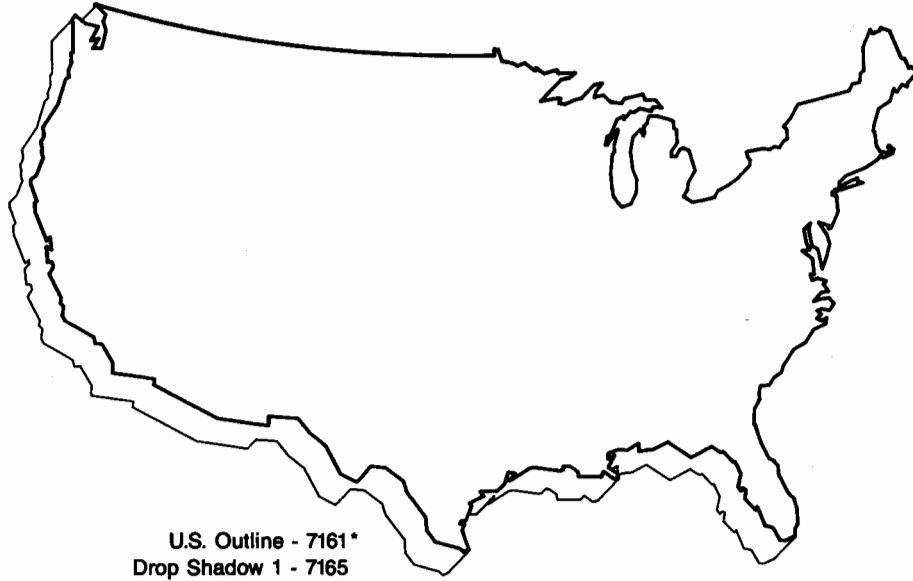

**U.S. Outline with Drop Shadow 2**

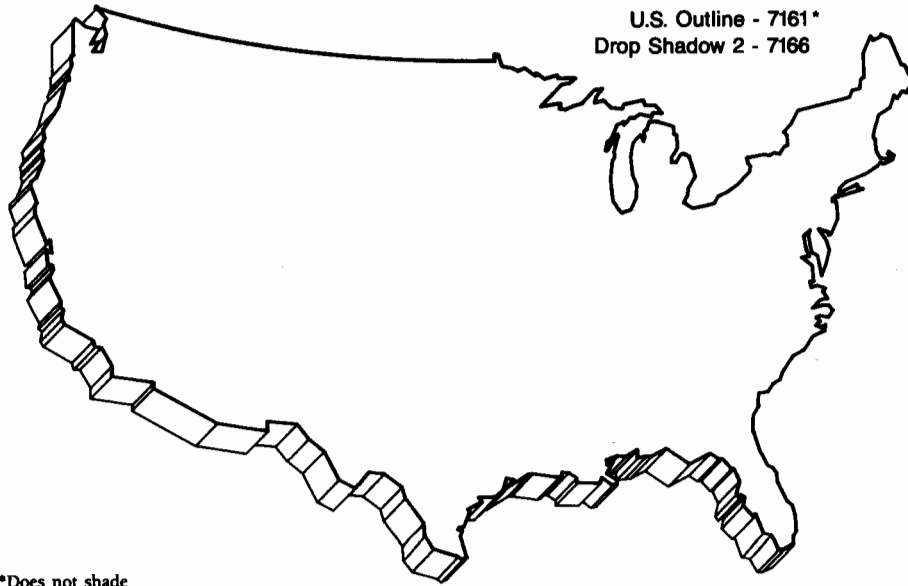

\*Does not shade

**U.S. Maps - Low Resolution**  
**States Scaled to State Boundaries**



**U.S. Maps - Low Resolution**  
**States Scaled to State Boundaries**



Each of the low-resolution state symbols pictured above is scaled to the state boundaries. They are intended for use on an individual basis and are presented here in combination for identification purposes only.

A high-resolution map of each state, along with the names of major cities is saved as a Diagraph file on the Sample Maps #2 disc. To display a state map, load "S-XX-H" substituting the two character abbreviation of the state for XX in the Filename field.



**U.S. Maps - Low Resolution**  
**States Scaled to the U.S.**



## U.S. Maps - Low Resolution

States Scaled to the U.S.

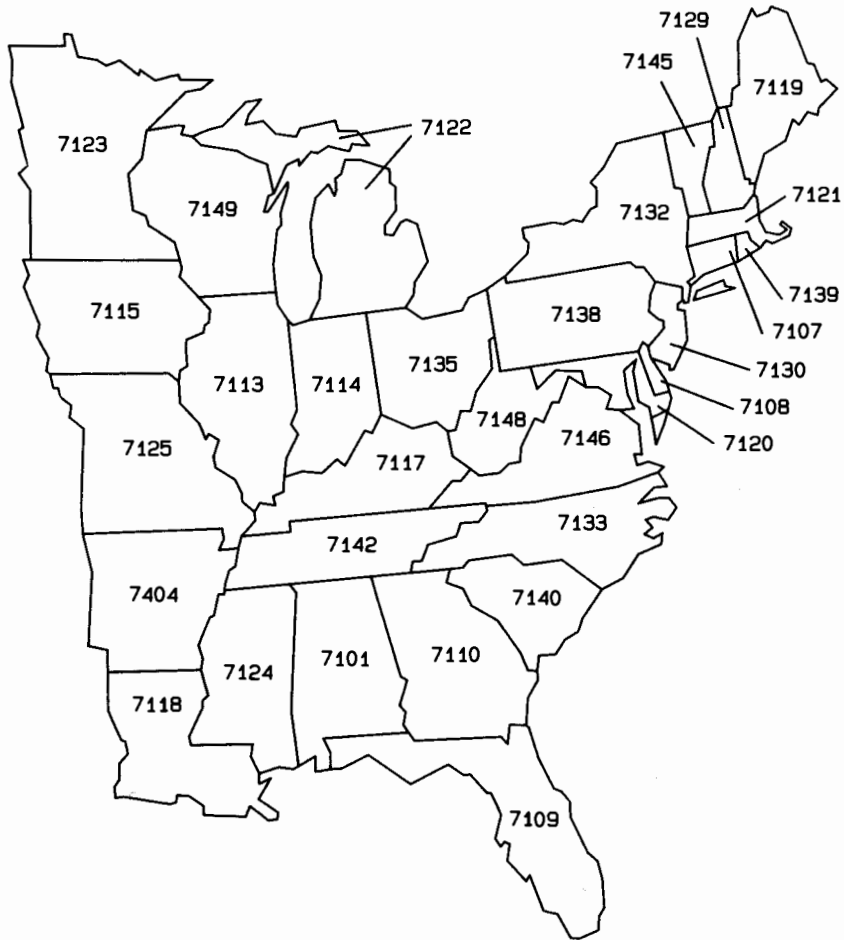

Each of the low-resolution state symbols pictured above is scaled to the outline of the U.S. To build a map of the U.S. or a portion thereof, combine the symbols as explained in the introduction to the U.S. Maps library.

A map of the U.S., combining the 50 symbols pictured above, is saved as a Diagraph file on the Sample Maps #1 disc. To display the map, load "US-2-L".

**U.S. Maps - Low Resolution**  
**States Scaled to Regions**



Each of the low-resolution state symbols pictured above is scaled to one of the six regions. To build a regional map or a portion thereof, combine the symbols as explained in the introduction to the U.S. Maps library.

**U.S. Maps - Low Resolution**  
**States Scaled to Regions**



Maps of each of the regions pictured above and three other regional alignments are saved as Diagraph files on the Sample Maps #1 disc. To display a map of the Northeast region, load "R-5-H". See the Sample Maps section titled Regions for a listing of the other region maps.

**U.S. Maps - Medium Resolution**  
**U.S. Outline with State Lines and City Indicators**

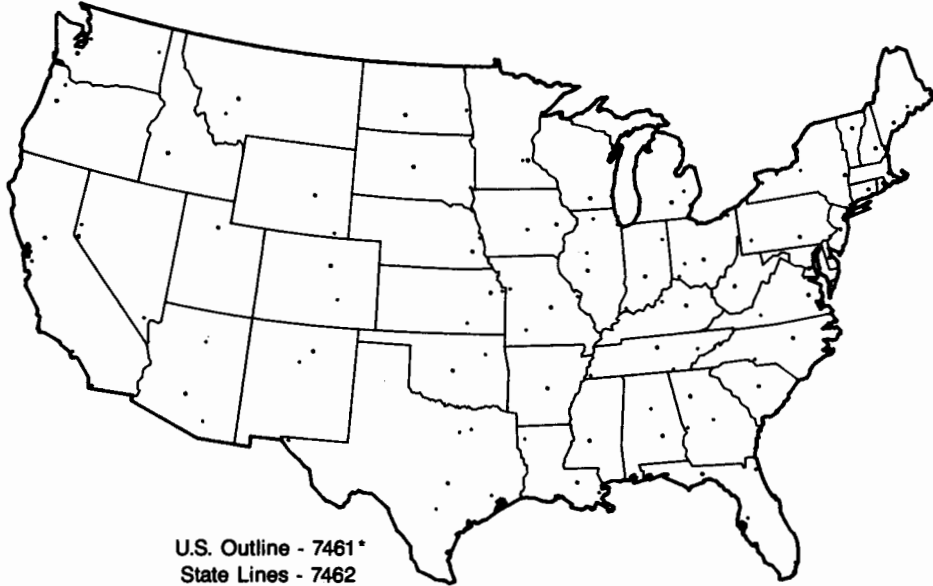

U.S. Outline - 7461\*  
State Lines - 7462  
City Indicators - 7463

**U.S. Outline with Time Zones**

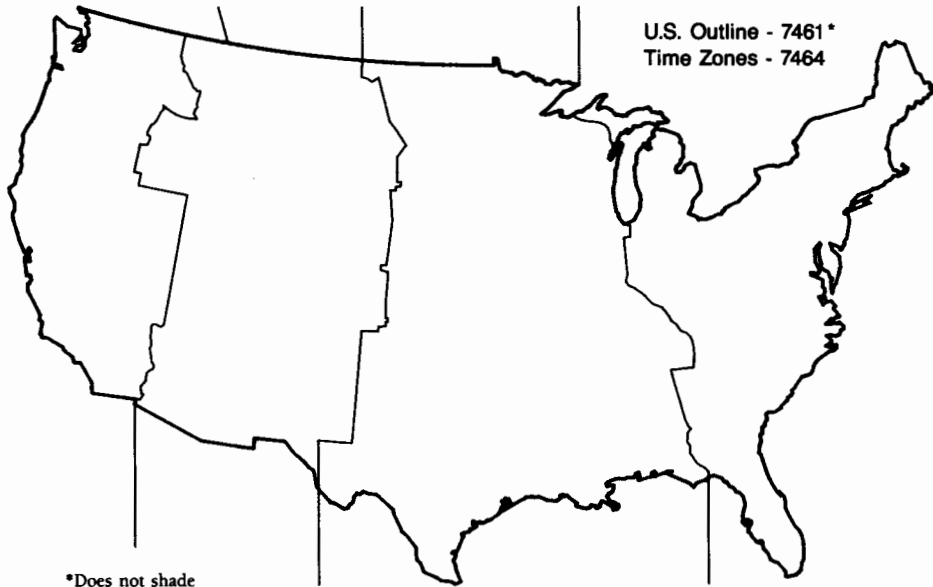

U.S. Outline - 7461\*  
Time Zones - 7464

\*Does not shade

**U.S. Maps - Medium Resolution**

**U.S. Outline with Drop Shadow 1**

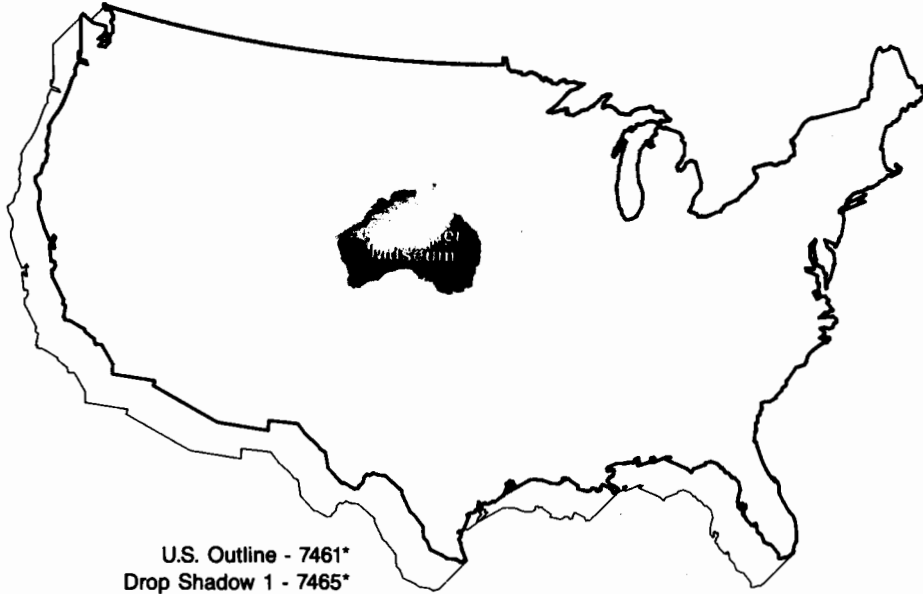

**U.S. Outline with Drop Shadow 2**

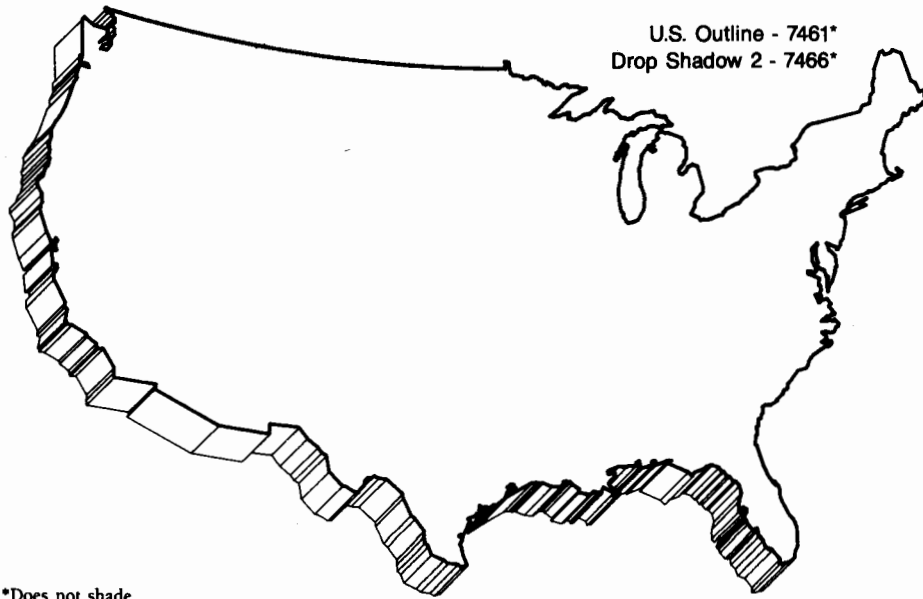

\*Does not shade

# U.S. Maps - Medium Resolution

States Scaled to State Boundaries



\*Alaska does not shade

**U.S. Maps - Medium Resolution**  
**States Scaled to State Boundaries**



Each of the medium-resolution state symbols pictured above is scaled to the state boundaries. They are intended for use on an individual basis and are presented here in combination for identification purposes only.

A high-resolution map of each state, along with the names of major cities is saved as a Diagraph file on the Sample Maps #2 disc. To display a state map, load "S-XX-H" substituting the two character abbreviation of the state for XX in the Filename field.



# U.S. Maps - Medium Resolution

States Scaled to the U.S.



## U.S. Maps - Medium Resolution

States Scaled to the U.S.



Each of the medium-resolution state symbols pictured above is scaled to the outline of the U.S. To build a map of the U.S. or a portion thereof, combine the symbols as explained in the introduction to the U.S. Maps library.

A map of the U.S., combining the 50 symbols pictured above, is saved as a Diagraph file on the Sample Maps #1 disc. To display the map, load "US-2-M".

# U.S. Maps - Medium Resolution

## States Scaled to Regions



Each of the medium-resolution state symbols pictured above is scaled to one of the six regions. To build a regional map or a portion thereof, combine the symbols as explained in the introduction to the U.S. Maps library.

**U.S. Maps - Medium Resolution**  
**States Scaled to Regions**

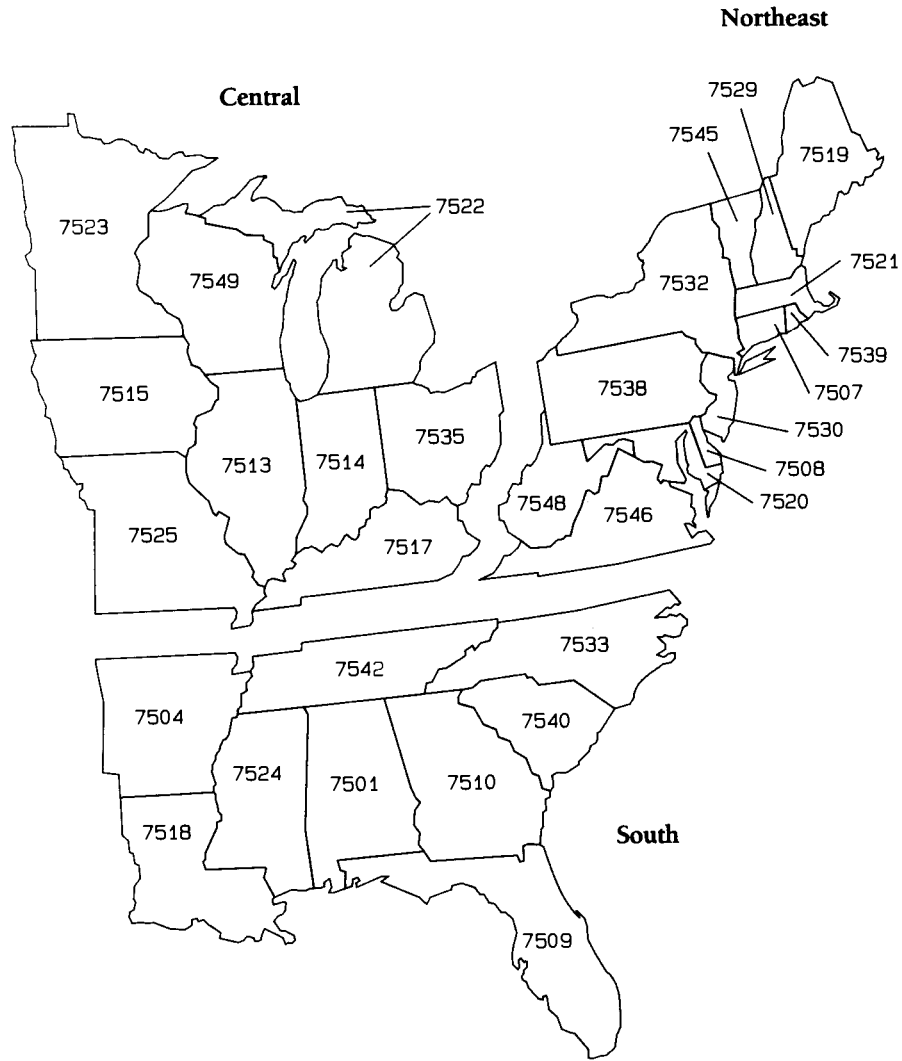

Maps of each of the regions pictured above and three other regional alignments are saved as Diagraph files on the Sample Maps #1 disc. For example, to display a map of the Northeast region, load "R-5-H". See page 6-46 for a listing of the region maps.

**U.S. Maps - High Resolution**  
**States Scaled to State Boundaries**



**U.S. Maps - High Resolution**  
**States Scaled to State Boundaries**



Each of the high-resolution state symbols pictured above is scaled to the state boundaries. They are intended for use on an individual basis and are presented here in combination for identification purposes only.

A high-resolution map of each state, with the names of each of the cities is saved as a Diagraph file on the Sample Maps #2 disc. To display a state map, load "S-XX-H" substituting the two character abbreviation of the state for XX in the Filename field.

# U.S. Maps - High Resolution

States Scaled to the U.S.



## U.S. Maps - High Resolution

### States Scaled to the U.S.



Each of the high-resolution state symbols pictured above is scaled to the outline of the U.S. To build a map of the U.S. or a portion thereof, combine the symbols as explained in the introduction to the U.S. Maps library.

A map of the U.S., combining the 50 symbols pictured above, is saved as a Diagraph file on the Sample Maps #1 disc. To display the map, load "US-2-H".



**U.S. Maps - High Resolution**  
**States Scaled to Regions**



Each of the high-resolution state symbols pictured above is scaled to one of the six regions. To build a regional map or a portion thereof, combine the symbols as explained in the introduction to the U.S. Maps library.

# U.S. Maps - High Resolution

## States Scaled to Regions



Maps of each of the regions pictured above and three other regional alignments are saved as Diagraph files on the Sample Maps #1 disc. See the Sample Maps section titled Regions for a listing of the region maps. To display a map of the Northeast region, load "R-5-H".

## U.S. Maps Metropolitan Areas

The metropolitan area map symbols are divided into four groups. The symbols are scaled to the same boundaries so that they can be overlaid to create a metropolitan area map on 8½ × 11 inch paper.

The metro area symbols define the boundaries of the metropolitan area including any geographic features.

The state and county lines are separate groups so that the lines can be plotted in bold, different linetypes or colors to distinguish them from each other.

The city indicator symbols are templates that identify the location of many of the cities within a metropolitan area.

To build a metro map, size and position the metropolitan area symbol. Use the Add function to overlay the appropriate state lines, county lines and city indicator symbols selected from the table shown below.

Twenty metropolitan area maps, including the names of the counties and cities are saved on the Sample Maps #1 disc. The filenames are listed on page 6-50.

Metropolitan Areas:	Metro Areas	State Lines	County Lines	City Indicators
Atlanta	7901	7902	7903	7904
Baltimore/Washington DC	7905*	7906	7907	7908
Boston	7909*	7910	7911	7912
Chicago	7913	7914	7915	7916
Cincinnati	7917	7918	7919	7920
Cleveland	7921	....	7923	7924
Dallas/Fort Worth	7925	7926	7927	7928
Denver	7929	7930	7931	7932
Detroit	7933*	....	7935	7936
Houston	7937*	7938	7939	7940
Indianapolis	7941	7942	7943	7944
Los Angeles	7945*	7946	7947	7948
Miami/St. Petersburg	7949*	....	7951	7952
Minneapolis	7953	7954	7955	7956
New York City	7957*	7958	7959	7960
Philadelphia	7961*	7962	7963	7964
Pittsburgh	7965	7966	7967	7968
Saint Louis	7969	7970	7971	7972
San Francisco	7973	....	7975	7976
Seattle	7977*	7978	7979	7980

\*Does not shade

# Sample Maps

## Introduction

For your convenience, a series of sample maps have been prepared using the U.S. Maps library and saved as Diagraph files on the Sample Maps #1 and #2 discs.

The maps are organized into four groups; United States, regions, states and metropolitan areas. Examples of each classification are shown on the following pages with additional information about the maps.

The sample maps were designed to be plotted or printed full scale on 8½ × 11 inch paper at one of four resolutions: icon, low, medium or high. Each map is arranged on the page with room for a title, text, and other information.

The map of the United States and the regional maps are built by combining the individual state symbols scaled to the United States or to a region. You can select each state (symbol) and assign a different color or shading pattern to distinguish the states and regions.

Because all of the states are scaled to the same size, the flashing frames will coincide. To identify which state is the active symbol, press Text Functions. A text node will blink somewhere within the boundary of the active state symbol. Press Done and the Next key to proceed to the next state symbol.

You can reposition the map on the page by moving all of the symbols the same number of increments. However, it is very tedious to resize the states and compute the number of increments adjoining states must be moved to ensure the proper alignment of the state boundaries. Generally, it is easier to build a map starting at the correct size than to change the size of an existing map.

Text has been added to identify the states, cities, counties or geographic features. The name of the state, geographic features, counties and cities are associated with "invisible" symbols (linetype=0) so that the text will not be windowed if the symbols are shaded.

The first characters of the filename indicate the type of map. The suffix indicates the resolution.

US – United States Map	I – Icon
R – Regional Map	L – Low Resolution
S – State Map	M – Medium Resolution
M – Metropolitan Area	H – High Resolution

For example, "R-5-H" is a sample map of the Northeast region composed of high resolution state symbols. The filenames of the sample maps are listed on the following pages.

In summary, you should be able to adapt many of the sample maps by simply adding additional information or deleting symbols and text that are not pertinent to your map.

## Sample Maps

### Outline of the U.S. with Major Cities



The sample map pictured above is composed of a U.S. outline symbol, a city indicator symbol and an "invisible" symbol (#1001) with which all of the city names are associated. You can change and delete the city names but you cannot change the city indicators.

The city indicator symbol was designed as a template to show the location of many of the major cities. To indicate the location of the cities you want to show, add symbol #1002 in the margin and size it accordingly. Use the Copy function to overlay symbol #1002 over the appropriate city indicators. Delete the city indicator symbol and replot the map to the screen.

# Sample Maps

## Outline of U.S. with Major Cities



Once the city indicators (#1002) are positioned, use the Line functions to connect city symbols illustrating route structures or the reporting relationships of plants and branch offices, etc.

The U.S. Outline sample map is saved in three resolutions on the Sample Maps #1 disc. The filenames are:

US-1-I (Icon)

US-1-L (Low)

US-1-M (Medium)

To add Alaska and Hawaii, select the state symbol scaled to the U.S. at the appropriate resolution.

**Sample Maps**  
**United States**



## Sample Maps

### United States



The sample map shown above is composed of the 50 state symbols scaled to the U.S. Because all of the states are scaled to the U.S., the flashing frames will coincide. To identify which state is the active symbol, press Text Functions. A text node will blink somewhere within the boundary of the active state symbol. Press Done and the Next key to proceed to the next state symbol.

Four sample maps, developed from the state symbols in each of the four resolutions (icon, low, medium and high) are saved on the Sample Maps #1 disc. The filenames are:

US-2-I (Icon)      US-2-L (Low)      US-2-M (Medium)      US-2-H (High)



## Sample Maps

### Regions



The sample map shown above is composed of 22 state symbols that are scaled to the Northeast region. The names of the states are associated with an “invisible” symbol so that you can shade each state without windowing the text.

Because each of the 22 states are scaled to the same region, the frames will coincide. To identify which state is the active symbol, press Text Functions. A text node will blink somewhere within the boundary of the active state symbol. Press Done and the Next key to proceed to the next state symbol.

## Sample Maps

### Regions

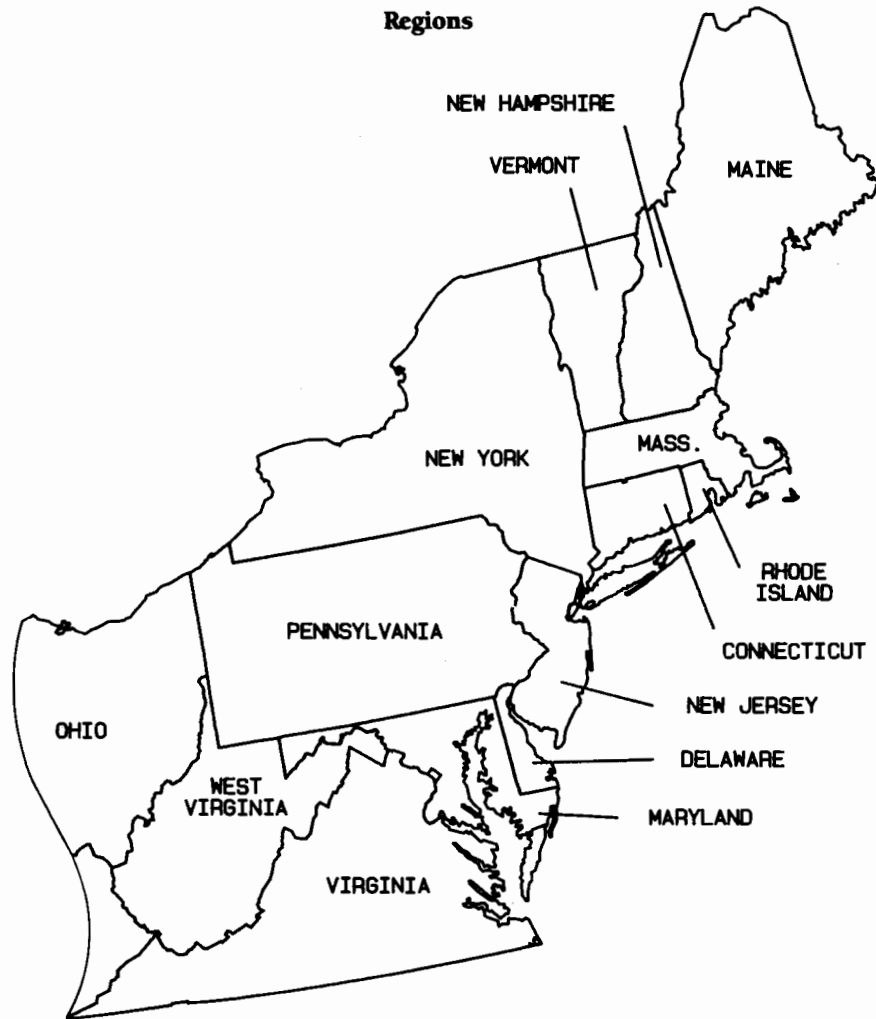

Four different approaches have been used to divide the United States into regions. The number of subdivisions varies from four to nine regions as shown on the next two pages.

The regional maps are constructed using the high-resolution versions of the state symbols. To build your own regional maps, start with the most appropriate sample map and delete any states that are not appropriate. If you must move any of the states, remember the number of increments you move the first state symbol and repeat the process for each of the remaining symbols.

# Sample Maps

## Regions

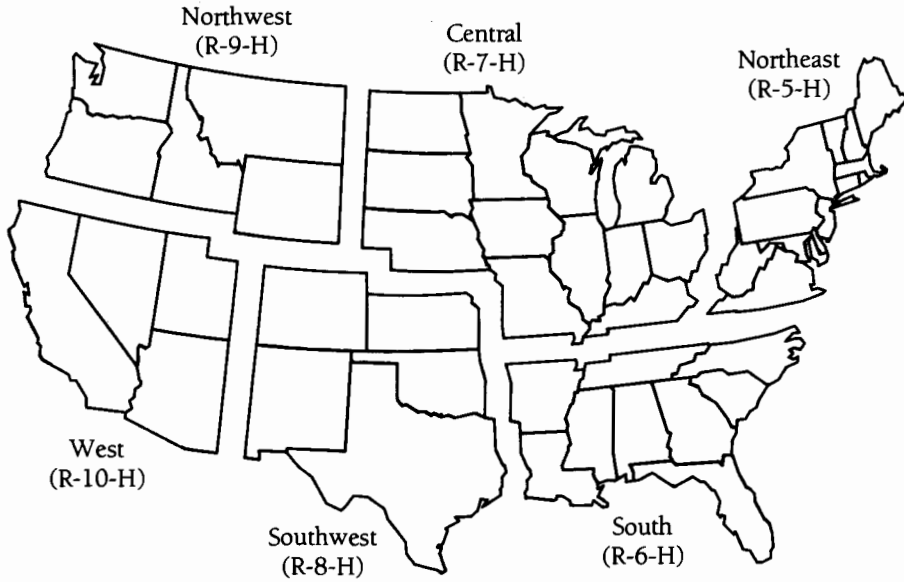
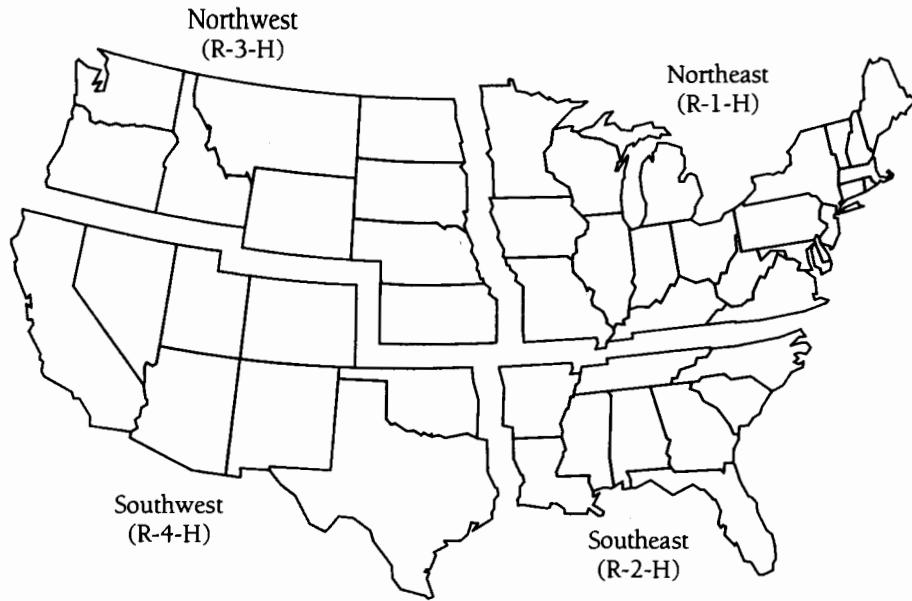

The sample maps shown above are plotted at low resolution for illustration purposes only. The filenames of the sample maps saved on the Sample Maps #1 disc are in parentheses.

# Sample Maps

## Regions

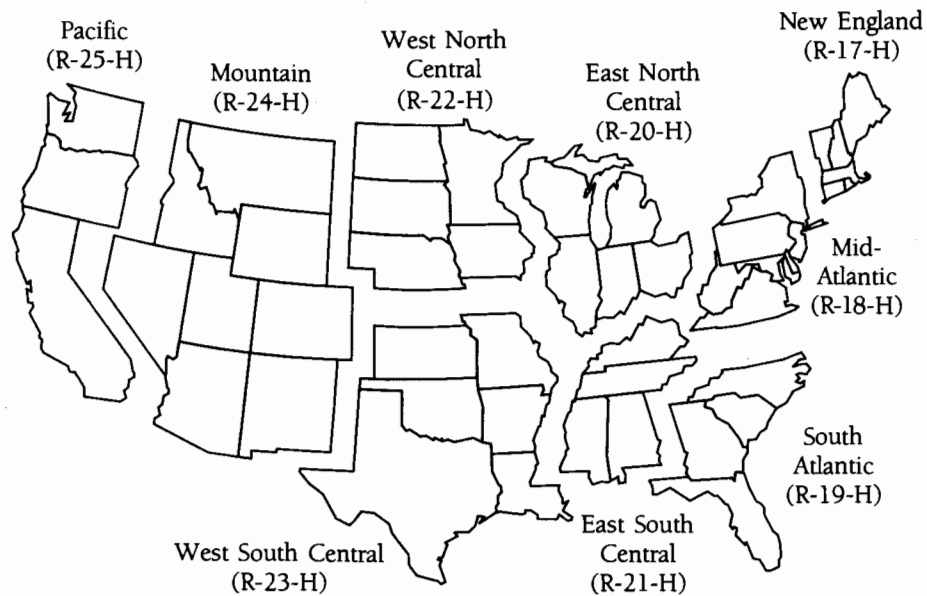
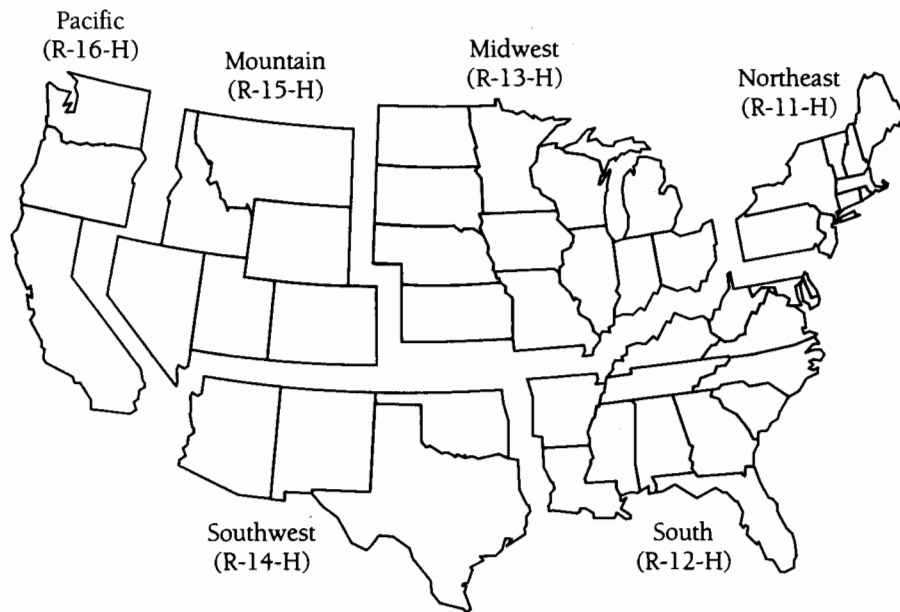

The sample maps shown above are plotted at low resolution for illustration purposes only. The filenames of the sample maps saved on the Sample Maps #1 disc are in parentheses.

## Sample Maps

### State Maps

The state maps are saved as Diagraph files on the Sample Maps #2 disc. Each of the state maps consists of the state boundaries, the location of the state capital and many of the larger cities.

The state maps were developed using the high-resolution versions of the state symbols scaled to the state boundaries. The name of the state, geographic features and major cities are associated with an "invisible" symbol (linetype=0) so that the text will not be windowed if the state symbol is shaded. Use the Next key to select the "invisible" symbol (#1001), the city indicators (#1002), or state capital indicators (#1651).

Because the "invisible" symbol is the same size as the state symbol, the flashing frames will coincide. Press Change Symbol to determine the symbol number and then Cancel Task.

The state maps were designed to be plotted or printed full scale on 8½ x 11 inch paper. Each state is arranged on the page with room for a title, text and other information.

State	Filename	State	Filename
Alabama	S- AL -H	Montana	S- MT -H
Alaska	S- AK -H	Nebraska	S- NE -H
Arizona	S- AZ -H	Nevada	S- NV -H
Arkansas	S- AR -H	New Hampshire	S- NH -H
California	S- CA -H	New Jersey	S- NJ -H
Colorado	S- CO -H	New Mexico	S- NM -H
Connecticut	S- CT -H	New York	S- NY -H
Delaware	S- DE -H	North Carolina	S- NC -H
Florida	S- FL -H	North Dakota	S- ND -H
Georgia	S- GA -H	Ohio	S- OH -H
Hawaii	S- HI -H	Oklahoma	S- OK -H
Idaho	S- ID -H	Oregon	S- OR -H
Illinois	S- IL -H	Pennsylvania	S- PA -H
Indiana	S- IN -H	Rhode Island	S- RI -H
Iowa	S- IA -H	South Carolina	S- SC -H
Kansas	S- KS -H	South Dakota	S- SD -H
Kentucky	S- KY -H	Tennessee	S- TN -H
Louisiana	S- LA -H	Texas	S- TX -H
Maine	S- ME -H	Utah	S- UT -H
Maryland	S- MD -H	Vermont	S- VT -H
Massachusetts	S- MA -H	Virginia	S- VA -H
Michigan	S- MI -H	Washington	S- WA -H
Minnesota	S- MN -H	West Virginia	S- WV -H
Mississippi	S- MS -H	Wisconsin	S- WI -H
Missouri	S- MO -H	Wyoming	S- WY -H

# Sample Maps

## States



## Sample Maps Metropolitan Areas

The metropolitan area maps are saved as Diagraph files on the Sample Maps #1 disc. Each of the metropolitan area maps that consists of the metropolitan area, state boundaries, county lines, and the location of the cities that fall within the metropolitan area. You can change or delete any of the seven component symbols that have been combined to create the metropolitan area map.

The name of the state, geographic features, counties and cities are associated with "invisible" symbols (linetype=0) so that the text will not be windowed if the metro area symbol is shaded. Use the Next key to select the "invisible" symbols (#1001, #1002, #1003): state lines, county lines and city indicator symbols.

Because the "invisible" symbols are the same size as the metro area symbol, the flashing frames will coincide. Press Change Symbol to determine the symbol number and then Cancel Task.

The map files are organized as follows:

Symbols	Symbol Number*	Line Type
Metro Area	nnnn	1
State Lines (if applicable)	nnnn	1
County Lines	nnnn	1
City Indicators	nnnn	1
City Names	1001	0
County Names	1002	0
State Name/Geographic Features	1003	0

*\*The symbol numbers for the first four symbols in the table above will vary for each metropolitan area. To build your own metropolitan area maps, see page 6-38.*

Metropolitan Area	Filename	Metropolitan Area	Filename
Atlanta	M-ATL-M	Indianapolis	M-IND-M
Baltimore/Washington DC	M-BAL-M	Los Angeles	M-LOS-M
Boston	M-BOS-M	Miami/St. Petersburg	M-MIA-M
Chicago	M-CHI-M	Minneapolis	M-MIN-M
Cincinnati	M-CIN-M	New York	M-NEW-M
Cleveland	M-CLE-M	Philadelphia	M-PHI-M
Dallas/Fort Worth	M-DAL-M	Pittsburgh	M-PIT-M
Denver	M-DEN-M	St. Louis	M-SAI-M
Detroit	M-DET-M	San Francisco	M-SAN-M
Houston	M-HOU-M	Seattle	M-SEA-M

# Sample Maps

## Metropolitan Areas

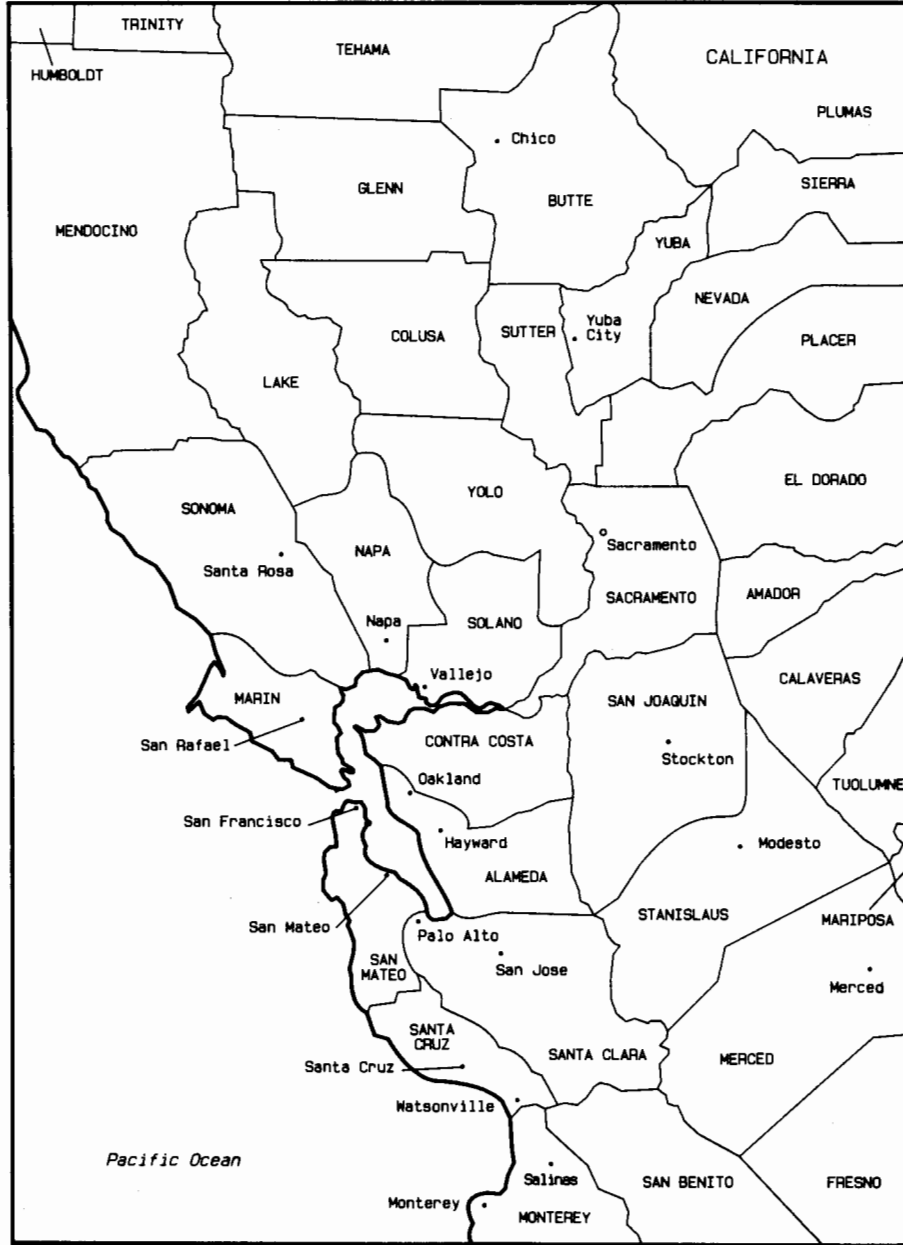

Filename = M-SAN-M



# Sample Maps

## Metropolitan Areas

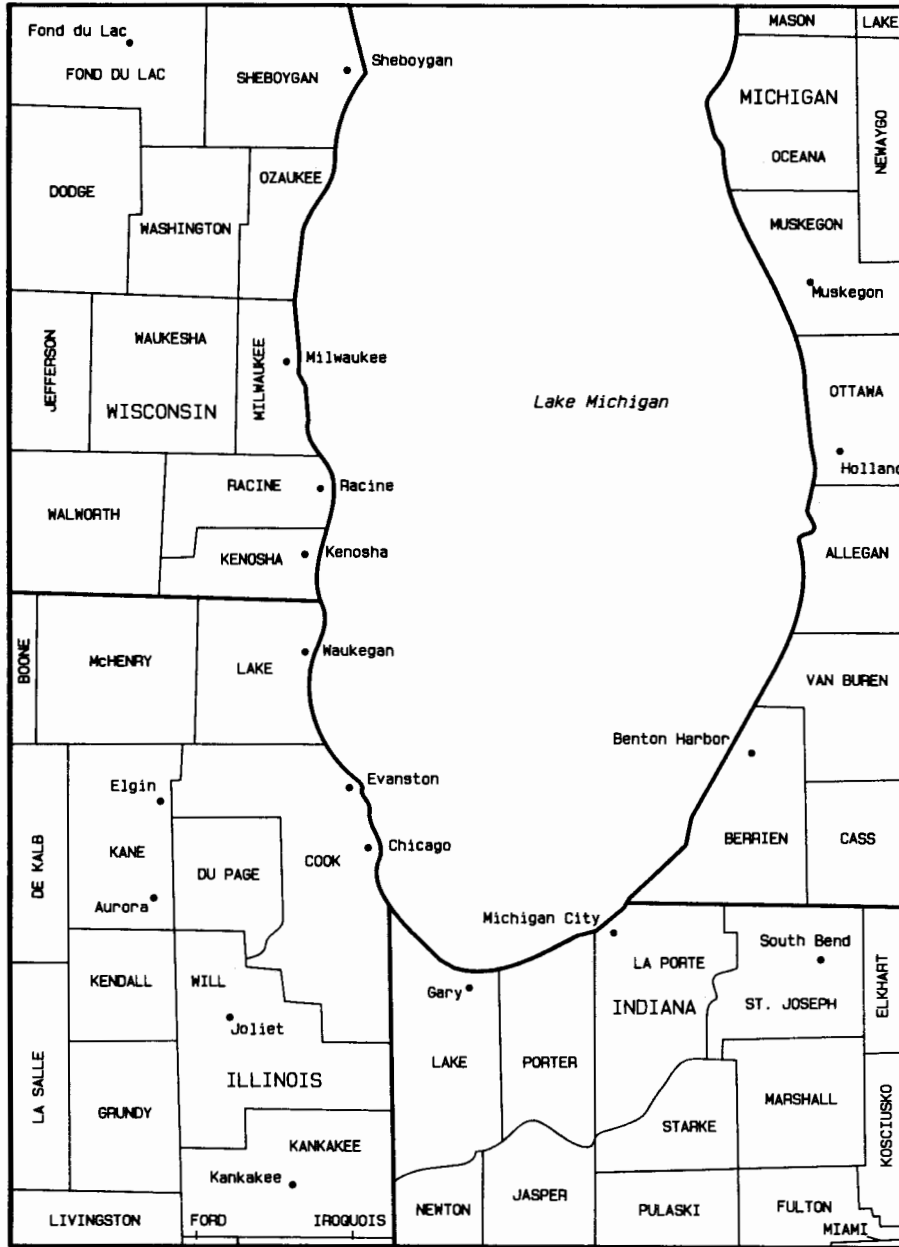

Filename = M-CHI-M



# Symbol Index

Alphabetical

Description	Number	Lib.	Page	Description	Number	Lib.	Page
Abacus	3925	17	3-21	Chicken	4071		3-7
Abraham Lincoln	4831P	2	4-11	Cockroach	3017	16	3-18
Accents (Graphic Aids)			1-1	Cow	4070		3-7
Account Current (%)	2032		3-1	Crow	3084	9	3-15
Acoustic Coupler	1674		5-5	Deer (Stag)	4082		3-7
Acoustics (Electronics)		4	5-16	Dog, Puppy	2278		3-7
Air Brush	3502	1	3-11	Dog, Terrier	2272		3-7
Airplane Crash	3099	8	3-13	Donkey	4058		3-7
Airplanes				Dove w/Olive Branch	3076	9	3-15
Biplane w/Banner	4330P		4-4	Dragon	4116P		4-3
Bomber/Twin Prop	3695	10	3-17	Dragon/Serpent	4369P		4-3
Commercial Jet	2018		3-6	Duckling (Swimming)	4471P	3	4-16
Commercial Jet	4106P		4-4	Eagle (Emblematic)	3651	17	3-20
Commercial Jet (3 Jets)	4520	1	3-11	Easter Bunny	4709P	2	4-11
Fighter	2017		3-6	Easter Chick	4787P	2	4-11
Fighter, 3/4 View	4153P		4-4	Easter Duckling	4710P	2	4-11
Fighter, Side View	4418P		4-4	Education Owl	4757P	2	4-10
Four Engine Jet	2991	10	3-17	Elephant	4057		3-7
Four Engine Prop	2990	10	3-17	Fish	3028	9	3-15
Jet Fighter	2946	8	3-13	Fish	4111P		4-5
Jet Fighter w/Explosion	2947	8	3-13	Fish Chasing Fish Chasing Fish	3517P	3	4-17
Single Engine Prop	3015	10	3-17	Flamingo	3795	17	3-21
Small Engine Prop	2971	10	3-17	Fly	3650	16	3-18
Straight Wing Jet w/Tip Tanks	2973	10	3-17	Giraffe	3010	10	3-16
Swept-Wing Bomber	2015		3-6	Ground Hog	4812P	2	4-9
Swept-wing Jet	3109	10	3-17	Halloween Bat Corner	4834P	2	4-13
Trainer, Jet	2016		3-6	Halloween Bats w/Moon			2-4-12
Twin (Rear) Engine Jet	3696	10	3-17	Halloween Cat	4768P	2	4-13
Twin Boom/Twin Prop	3110	10	3-17	Halloween Cat	4868P	2	4-13
Twin Engine Prop	2972	10	3-17	Halloween Owl	4777P	2	4-13
Airport Sign	4067		3-3	Hen	4071		3-7
Alarm Bell	4408	8	3-13	Horse in Motion	3972	17	3-21
Alarm Siren	3256	9	3-15	Insect	3017	16	3-18
Alien World				Mechanical Dog	4291P	3	4-16
City	3772P	7	4-22	Migrating Geese	4809P	2	4-10
Fauna (6 Legs)	4966P	7	4-23	Mouse	3020	9	3-15
Fauna (Flying)	4959P	7	4-23	Mule	4058		3-7
Fauna (Flying)	4961P	7	4-23	Ostrich w/Head in Sand	2996	10	3-16
Fauna (Intelligent Blob)	4977P	7	4-23	Parrot	3796	17	3-21
Flora 1	4968P	7	4-23	Penguin w/Suit	4464P	3	4-17
Flora 2	4969P	7	4-23	Pig	3140	16	3-19
Flora 3	4970P	7	4-23	Pig	4328P		4-3
Flora 4	4971P	7	4-23	Rabbit	3019	9	3-15
Humanoid, Friendly	3757P	7	4-23	Reindeer	4845P	2	4-15
Humanoid, Pointing	3756P	7	4-23	Reindeer	4847P	2	4-15
Planet w/Asteroid Belt	4874P	7	4-23	Rhinoceros	3663	16	3-19
Settlement	3752P	7	4-21	Rooster	4469P	3	4-16
Vehicle/Transporter	4975P	7	4-23	Sailfish	3957	10	3-16
Ampersand (&)	2669		3-1	Sheep (One)	3137	10	3-16
Anchor	3052	17	3-20	Snake	4442P		4-3
Anchor	4329P		4-1	Snake	3935	16	3-19
Angle				Spider	3134	16	3-18
Acute	2617		2-1	Stork w/Hat	4470P	3	4-16
Right	2620		2-1	Summer Dog	4755P	2	4-9
Angle Notation	1708		3-2	Turkey	4778P	2	4-13
Angles			2-1	Unicorn	3931	17	3-21
Animals				Antenna			
Ape (Baboon)	4450P		4-3	Dish	3259	9	3-14
Bear	3011	10	3-16	Television	2923	8	3-12
Bear, Teddy	4235P		4-3	Anvil	4293	1	3-11
Bird of Prey	3126	16	3-19	Ape (Baboon)	4450P		4-3
Bird w/Worm	4744P	2	4-9	Apollo			
Blue Whale	3954	17	3-21	Capsule	4931P	7	4-19
Bull Weevil	3045	16	3-18	Lunar Module	3546P	7	4-19
Bull	3159	16	3-19	Apple	2852P	11	4-24
Butterfly	3119	16	3-18	Approximately Equals (≈)	1701		3-2
Butterfly	4211P		4-3	Apricots	2859P	11	4-24
Camel	3021	9	3-15	April Flower	4762P	2	4-9
Cat	2423		3-1	Arc (90 degrees)	2624		2-1
Cat	3272	16	3-19	Arches			2-3
Caterpillar	4117P		4-3	Arcs			2-1
Chick in Egg	4320P		4-3	Arm and Hammer	4810P	2	4-12

## Alphabetical Symbol Index, continued

Description	Number	Lib.	Page	Description	Number	Lib.	Page
Armchair (Layout)	1295	..	5-6	Bank Safe	3058	10	3-17
Arrowheads	..	..	1-3	Banners	..	..	1-7
Arrows	..	..	1-3	Bar Charts	..	..	5-3
3-D	..	..	1-6	Barbed Wire	4523	8	3-12
Multidirectional	..	..	1-6	Barley	4505P	11	4-25
Artichoke	2866P	11	4-24	Barrel	2930	8	3-13
Asparagus	2861P	11	4-24	Barrel	4019	..	3-5
Asterisk (*)	2029	..	3-1	Barrel, Wooden	4549	1	3-11
Asterisk (8 points)	2107	..	3-1	Barricade	3194	16	3-19
Asteroid	4982P	7	4-20	Barrier (Road Signs)	4060	..	3-4
Asteroids	4973P	7	4-20	Bars	..	..	..
Astronaut	..	..	..	Bars, Gold	4043P	..	4-1
Explorer 1	3767P	7	4-22	Bars, Jail	4002	..	3-7
Explorer 2	3768P	7	4-22	Bass Clef	1749	..	1-1
Explorer 3	3769P	7	4-22	Bathtub	4411	8	3-13
w/Maneuvering Unit	4962P	7	4-18	Battery	..	..	..
w/Maneuvering Unit (Front)	4878P	7	4-18	Automotive	4538	1	3-11
w/Maneuvering Unit (Side)	3758P	7	4-18	D Cell	3133	16	3-18
w/Umbilical Cord	4879P	7	4-18	Beach Umbrella	3960	17	3-21
Astronomer	4475P	3	4-17	Beaker	4385P	..	4-5
At (@)	2033	..	3-2	Beans	2879P	11	4-24
Atlas Centaur	4850P	7	4-19	Bear	3011	10	3-16
Atomic Power	4007	..	3-6	Bear, Teddy	4235P	..	4-3
Atomic Power Plant	4047	..	3-5	Bed	2046	..	3-8
Auger	4526	8	3-12	Beer Mug	4179	..	3-8
Automobile Battery	4538	1	3-11	Beet	2880P	11	4-24
Automobile Parts	4254	1	3-11	Bell Curve	3323	..	2-1
Automobile Repair	4184	1	3-11	Curve w/Axes	1251	..	5-3
Automobiles	..	..	..	Bell Pepper	2878P	11	4-24
2-Door	4122P	..	4-4	Bell, Ring-The- (Front View)	4333P	..	4-1
4-Door	4342P	..	4-4	(Top View)	4335P	..	4-1
Auto. on Hydraulic Lift	4184	1	3-11	Bench Vise	4539	1	3-10
Compact	4387P	..	4-4	Bicycle	2269	10	3-17
Compact Sports Car	5011P	15	4-28	Bicycle	2271	..	3-6
Convertible, Large	5029P	15	4-28	Biplane w/Banner	4330P	..	4-4
Coupe (Two-Door)	5005P	15	4-28	Bird of Prey	3126	16	3-19
Coupe (Two-Door)	5007P	15	4-28	Bishop (Chess Piece)	3123	16	3-18
Mid-Sized Four-Door	5021P	15	4-28	Blast Furnaces	4048	..	3-5
Mid-Sized Two-Door	5017P	15	4-28	Blender	3692	17	3-21
Police Cruiser	5033P	15	4-28	Block and Tackle	4297	8	3-12
Simple	1965	..	3-6	Blue Ribbon	3018	9	3-15
Sports Car	4388P	..	4-4	Blue Whale	3954	17	3-21
Station Wagon	5013P	15	4-28	Blueprint	3090	16	3-18
Station Wagon	5023P	15	4-28	Boll Weevil	3045	16	3-18
Stretched Limousine	5027P	15	4-28	Bolt of Cloth	4651	1	3-10
Sub-Compact	5001P	15	4-28	Bomb	2951	9	3-14
Taxi	5031P	15	4-28	Bomb	3074	8	3-13
Wrecked	3669	8	3-13	Book	4357P	..	4-5
Autumn Tree Composite	..	2	4-10	Book, Open	2953	9	3-14
Auxiliary Operation (Flowchart)	1017	..	5-4	Border	..	..	..
Avocado	2868P	11	4-24	Curled Edge	1547	..	1-13
Award/Document	2954	9	3-14	Parchment	1937	..	1-9
Ax	4457	..	3-8	Scroll	3381	..	1-9
Axes (X and Y)	..	..	5-2	Stamp	1496	..	3-9
Baboon	4450P	..	4-3	Borders, Page	..	..	1-9
Baby Bottle	4185	8	3-12	Bottle	..	..	..
Baby Carriage	3936	17	3-21	Baby Bottle	4185	8	3-12
Back Hoe	4578P	15	4-29	Plastic (Gallon)	3151	9	3-14
Badge	..	..	..	w/Potion Inside	3131	10	3-16
Police	3262	10	3-16	Bow and Arrow	2294	..	3-8
Sheriff's	2932	8	3-13	Bowling	2977	8	3-13
Baggage Check	4188	1	3-10	Box	..	..	..
Balance Scale	..	..	..	Closed	3035	9	3-14
Equal	4005	..	3-7	Open (Flaps Up)	4038P	..	4-1
Unequal	4006	..	3-7	Open (Flaps Down)	4545	1	3-11
Bale of Cotton	3270	17	3-20	Taped	3658	16	3-19
Ball Bearings	3155	9	3-15	Boxcar	2943	8	3-12
Balloon, Hot Air	4347P	..	4-4	Boxes	..	..	1-8
Balloons, Word	..	..	1-14	Boxes	..	..	..
Ballot Box	3273	16	3-18	w/Arrow	4012P	..	4-1
Banana	2853P	11	4-24	Four (Jumbled)	4045P	..	4-1
Bandage	2919	8	3-12	Tumbling	4360P	..	4-1

## Alphabetical Symbol Index, continued

Description	Number	Lib.	Page	Description	Number	Lib.	Page
Boxing Gloves	4365P		4-1	Bushel Basket	2955	9	3-14
Boy	2262		3-7	Businessman	3111	10	3-16
Brace				Butcher Knife and Meat	3271	17	3-20
({})	2133		3-2	Butterfly	3119	16	3-18
Long	3331		5-1	Butterfly	4211P		4-3
Short	1265		5-1	Buzz Saw	4171		3-6
Bracket ([])	2132		3-2	CRT			
Bracket/Paranthesis ({}).	2131		3-2	Communications (Flowchart)	2023		5-5
Brain (Profile)	3294	16	3-19	Display (Flowchart)	1654		5-4
Bread Loaf	4575P	11	4-25	Personal Computer	1970		3-9
Bridge				Screen	1097		5-4
Simple	2410		3-5	w/Function Keys	1264		5-4
Suspension	3083	10	3-16	w/Function Keys Enlarged.	1263		5-4
Trestle	2403		3-5	Cabin, Log	4824P	2	4-11
w/Islands	4376P		4-8	Caboose	3673	8	3-12
Briefcase	3129	16	3-18	Cacti	3355P		4-7
Broadax	2437		3-8	Cactus	3167	16	3-18
Broadsword	4346P		4-2	Cactus	3354P		4-7
Broken Glass				Cactus, Prickly	3351P		4-7
Hole	4128P		4-2	Caduceus	4052		3-7
Pieces	4127P		4-2	Calculators		5	5-19
Broom	3257	9	3-15	Calendar	3117	16	3-18
Bucket	2952	9	3-14	Calendar Pad (Daily)	2906	8	3-12
Bucket and Scrub Brush	4649	1	3-10	Calipers	4295	1	3-10
Bugle	3688	17	3-20	Calligraphy Pen	3932	17	3-21
Building				Camel	3021	9	3-15
Barn	4046		3-5	Camera	4498	1	3-10
Capitol	4215		3-5	Movie	2265		3-6
Castle	2995	10	3-17	Movie/TV	4405	1	3-10
Cathedral/Mission	3958	17	3-21	Video (Hand-Held)	3013	9	3-15
Church	2402		3-5	Camper	3285	16	3-19
Cottage w/Snow	4811P	2	4-10	Can			
Courthouse	2405		3-5	Aluminum	3016	16	3-18
Factory w/Explosion	2938	8	3-13	Tin (Open Lid)	4525	1	3-11
Factory, Heavy Industry	2411		3-5	Candle	4424P		4-2
Factory, Light Industry	2408		3-5	Candle w/Holder	4144P		4-2
Factory, w/Smoke	4016		3-5	Candy Cane	4770P	2	4-14
Grain Elevator	2435		3-5	Candy Cane	4953P	2	4-14
Grain Silo	3130	16	3-18	Canned Food	3261	16	3-19
House	2298		3-5	Cannon	3056	8	3-13
House under Construction	3661	16	3-19	Cantaloupe	2865P	11	4-24
House, Split Level	3136	10	3-16	Cantaloupe	4554P	11	4-24
Lighthouse	2442		3-5	Capacitors (Electronics)		4	5-11
Log Cabin	4824P	2	4-11	Capitol Building	4215		3-5
Mine Head	2436		3-5	Cardboard Box (Open Top)	4545	1	3-11
Nuclear Power Plant	4047		3-5	Cards			
Office, One Story	4011		3-5	Computer Punch	2960	17	3-20
Oil Derrick	2936	8	3-12	Hand of	3670	10	3-16
Radio Tower w/Explosion	2939	8	3-13	Care Of (%)	2031		3-1
Rowhouse	4010		3-5	Cargo Ship	1947		3-6
Schoolhouse	2040		3-5	Carpentry (Framing)	3038	9	3-14
Skyscraper	4050		3-5	Carpet Roll	3037	9	3-14
Windmill	4051		3-5	Carrot	4513P	11	4-24
Buildings				Cart	2426	1	3-10
City Skyline	4123		3-5	Cartesian Coordinate Axes			5-2
City Skyline (Horizon)	3347P		4-7	Carton (Open)	4038P		4-1
Cityscape	2414	8	3-12	Cash Register	4178	1	3-10
Farm Scene	2883P	11	4-25	Cassette Tape	3027	10	3-17
Light Industry (Horizon)	3345P		4-7	Caster	3029	9	3-14
Pueblo	3680	17	3-20	Castle	2995	10	3-17
Refinery	2434		3-5	Cat	2423		3-7
Refinery Skyline (Horizon)	4078P		4-7	Cat	3272	16	3-19
Ruins	3103	8	3-13	Caterpillar	4117P		4-3
Suburbia (Horizon)	4079P		4-7	Cathedral/Mission	3958	17	3-21
Bull	3159	16	3-19	Ceiling Lamp	3183	9	3-15
Bulldozer	3968P	15	4-29	Celebration/Horn	3945	17	3-21
Bulldozer	4580P	15	4-29	Celery	2856P	11	4-24
Bulldozer	4581P	15	4-29	Cement Truck	3523P	15	4-28
Bunsen Burner	4225P		4-5	Cent Sign (¢)	2027		3-1
Buoy w/Light	4138		3-5	Ceramics	4569	1	3-10
Bus	2441		3-6	Certificate	3691	17	3-21
Bus	4301P		4-4				

## Alphabetical Symbol Index, continued

Description	Number	Lib.	Page	Description	Number	Lib.	Page
Chain and Sprockets	4524	1	3-10	Clouds			
Chair				Cloud	2985	9	3-15
Conference (Layout)	1692		5-6	Cumulus	4140P		4-6
Executive Swivel (Layout)	1292		5-6	Funnel (Tornado)	4143P		4-6
Secretary's	2276		3-9	Rain Cloud	2988	9	3-15
Secretary's	4437P		4-5	Snow Cloud	3104	9	3-15
Secretary's (Layout)	1552		5-6	Stratocumulus	4139P		4-6
Side Chair (Layout)	1293		5-6	Thunder Cloud	2987	9	3-15
Chair Swivel	4422P		4-5	Thunderhead	4141P		4-6
Champagne Glass	4343P		4-5	Tornado Cloud	2986	9	3-15
Channel-Lock Pliers	4322P		4-2	w/Lightning	4142P		4-6
Charts				Cloudy, Partly	2984	9	3-15
Organizational			5-1	Clover Leaf	1948		3-8
Pie, Bar and Line			5-2	Club (Playing Card)	1904		1-1
Check Mark	1296		1-1	Cockroach	3017	16	3-18
in 3rd Box	2041P		4-1	Coconut	4519P	11	4-24
in Grid	4353P		4-1	Coffee Bean	4511P	11	4-25
in Square	4379P		4-1	Coffee Cup	4183	8	3-12
Checkered Flag	3114	16	3-18	Coffee Mug	2286	8	3-12
Cheese Block	4574	1	3-10	Cold Drink	3263	16	3-19
Chemical				Combine Harvester	2895P	11	4-25
Bottle, Glass	3043	9	3-14	Comedy Mask	3172	16	3-18
Chemical/Petroleum Process Flow				Comet	4983P	7	4-20
Library		14	5-41	Commas			3-1
Glassware	4014		3-6	Commercial Airliner	4520	1	3-11
Plant	2412		3-5	Communication Links			5-5
Plant	4316P		3-5	Communication Tower	3127	9	3-14
Cherries	2867P	11	4-24	Communications Flowcharts			5-5
Chess Pieces	4320P	16	3-18	Compact Car	4387P		4-4
Chick in Egg	4320P		4-3	Compact Sports Car	5011P	15	4-28
Chicken	4071		3-7	Comparison (Flowchart)	1004		5-4
Child				Compass Rose			1-3
Boy	2262		3-7	Compass and 45° Triangle	4435	1	3-10
Girl	2283		3-7	Composition Aids			4-6
Chili Pepper	4560P	11	4-25	Compressed-Gas Cylinder	4533	1	3-11
Chimney and Smoke Composite		2	4-15	Computer Equipment		5	5-19
Christmas				Computer Paper	1495		3-9
Bell Border Composite		2	4-15	Computer Punch Cards	2960	17	3-20
Candle Border Composite		2	4-15	Computer Terminal	1971		3-9
Ornament	4771P		2-4-14	Cones			2-7
Presents	4788P		2-4-14	Conference Chair (Layout)	1692		5-6
Stocking	4784P		2-4-15	Conference Table (Layout)	1940		5-6
Tree	4780P		2-4-14	w/6 Chairs	1698		5-6
Tree, 5-Part Composite			2-4-15	w/8 Chairs	2051		5-6
Tree, 8-Part Composite			2-4-14	Congruent (≈)	1701		3-2
Church	2402		3-5	Connector			
Off-Page (Flowchart)			1924	Off-Page (Flowchart)			5-4
On-Page (Flowchart)			1980	On-Page (Flowchart)			5-4
Cigar	3933	17	3-21	Connectors (Electronics)		4	5-11
Cigarette Pack	3790	8	3-12	Containers (Plastic Jugs)	4871	1	3-10
Cinder Block	4572	1	3-10	Convenience Store	2966	10	3-17
Circle	1002		2-3	Convertible, Large	5029P	15	4-28
Circles, Partial			2-1	Convex Lens	2551		2-3
Circuits				Copyright (©)	2744		3-2
(SHF, UHF, VHF)		4	5-17	Corn	3085	16	3-18
Integrated		4	5-18	Corn	4501P	11	4-24
City Skyline				Cornucopia	4805P	2	4-13
Horizon	3347P		4-7	Corrugated Sheet Metal	4541	1	3-11
Skyline	4123		3-5	Cosine/Sine Curve	3330		2-1
w/Globe	4364P		4-5	Cottage w/Snow	4811P	2	4-10
City, Futuristic	3772P	7	4-22	Cotton Picker Combine	2894P	11	4-25
Cityscape	2414	8	3-12	Cotton	5045P	11	4-25
Civil Defense Siren	3256	9	3-15	Cotton, Bale of	3270	17	3-20
Clapboard (Movie)	4441P		4-3	Council/Board	3096	9	3-15
Claw Hammer	3156	9	3-15	Coupler, Acoustic (Flowchart)	1674		5-5
Clay Pipe	4544	1	3-11	Courthouse	2405		3-5
Clipboard	1950	8	3-12	Cow	4070		3-7
Clipboard	4440P		4-5	Cowboy (Pointing at You)	4124P		3-4-17
Clock				Cowboy Boot	2976	8	3-13
Alarm	2289		3-9	Crane Truck	3536P	15	4-29
Round	2273		3-9	Crane, Tower	4367P		4-4
Square	4042		3-9	Crate	3160	9	3-15
Clothesline	3288	16	3-19				
Clothing	2430		3-7				

## Alphabetical Symbol Index, continued

Description	Number	Lib.	Page	Description	Number	Lib.	Page
Crate, Cargo	3280	16	3-19	and Disc Drives	5	5	5-21
Crawler Tractor	3541P	15	4-29	3½ Inch	2994	10	3-17
w/Scraper Trailer	3540P	15	4-29	Dish Antenna	4433P		4-4
Crescent Wrench	4499	1	3-10	Dish Antenna/Tracking Station	4799P	7	4-19
Crop Harvest	4813P	2	4-10	Dish Antenna/Tracking Station	4965P	7	4-20
Cross Hairs			1-1	Diskette			
Cross				Drive	1972		3-9
Narrow	1684		2-3	3½ Inch	4439		3-9
Wide	2535		2-3	5¼ Inch	1974		3-9
Crosses, 3-D			2-7	Display	1654		5-4
Crow	3084	9	3-15	Ditch Digger	3501P	15	4-29
Crowd (Facing Away)	3703P	3	4-16	Division (÷)	1703		3-2
Crown	3144	17	3-20	Dock Crane	3006	9	3-14
Crucible	4224P		4-5	Doctor	3077	10	3-16
Crystal Ball	4394P		4-2	Document	3164	17	3-20
and Hat	4217P		4-2	Document/Award	2954	9	3-14
Cubes				Documents	1982		3-9
Four Jumbled	4045P		4-1	Dog			
Oblique			2-4	Mechanical	4291P	3	4-16
Perspective			2-5	Puppy	2278		3-7
Stacked			2-8	Terrier	2272		3-7
Tumbling	4360P		4-1	Dollar Sign			
w/Arrow	4012P		4-1	3-D, ¾ View	4119P		4-1
Cucumber	2851P	11	4-24	3-D, End View	4381P		4-1
Culvert	4559	1	3-11	3-D, Front View	4115P		4-1
Cup, Trophy	4027		3-7	One Bar	2025		3-1
Cupid	4720P	2	4-11	Split Down the Middle	3975	17	3-21
Curves			2-1	Text Block	1057		1-13
Cutlass	4340P		4-2	Two Bars	2026		3-1
Cylinder, Graduated	4229P		4-5	Dolly			
Cylinders				2 Wheel w/Boxes	3031	9	3-14
3-D Oblique			2-4	4 Wheel	3030	9	3-14
3-D Perspective			2-7	Hand Truck	2047		3-8
Dagger				Donkey	4058		3-7
Double (‡)	2037		3-2	Doors			
Single (†)	2038		3-1	Door	2049		3-8
Daggers	4359P		4-2	Open, w/View	4341P		4-8
Dash (-)	1706		3-2	to Cellar	4158P		4-8
Data Access Arrangement	1672		5-5	Double Dagger (‡)	2037		3-1
Data Processing			5-4	Dove w/Olive Branch	3076	9	3-15
Data Processing Equipment		5	5-19	Dragon	4116P		4-3
Daydreamer	4247P	3	4-17	Dragon/Serpent	4369P		4-3
Dead-End Overpass	4431P		4-4	Dress	2997	8	3-12
Decagon	2529		2-2	Drill Press	2805	8	3-12
Decision (Flowchart)	1920		5-4	Droplet	2598		1-1
Deer	4082		3-7	Dropper Bottle	3283	16	3-19
Delivery Van	5041P	15	4-28	Drum, Kettle	3116	16	3-18
Derrick, Oil	2936	8	3-12	Drum			
Desert/Mesas (Horizon)	3344P		4-6	55 Gallon	4019		3-5
Desk Mat	3965	17	3-21	55-Gallon	2930	8	3-13
Desks				55-Gallon	3530	1	3-11
Ensemble (Layout)	1294		5-6	Drumstick	3299	10	3-16
Five-Drawer	4427P		4-5	Duckling (Swimming)	4471P	3	4-16
Secretary's (Layout)	1290		5-6	Dumbbell	2553		2-3
Secretary's w/Chair (Layout)	1291		5-6	Dump Truck	3508P	15	4-28
Six-Drawer	2706		3-9	Dump Truck	3509P	15	4-28
Destroyer (Ship)	2014		3-6	Dump Truck (Large)	3510P	15	4-28
Diagraph Logo	9002P		4-1	EDP			
Diamond (Jewel)	4069P		4-1	Equipment		5	5-19
Diamond Playing Card	1928		1-1	Flowcharts			5-4
Diamond Ring	3041	9	3-14	Printout (Flowchart)	1655		5-4
Diamonds (Accents)			1-1	Eagle (Emblematic)	3651	17	3-20
Dice, Pair of (Lucky Seven)	3072	10	3-16	Earth	3773P	7	4-20
Dingbats (Accents)			1-1	Earth Mover/Scraper	3529P	15	4-29
Diodes (Electronics)		4	5-13	Earth Remover Digging	3938	17	3-21
Diploma	3128	10	3-16	Earth Scraper	3539P	15	4-29
Direction Arrow (Flowchart)	1666		5-5	Earth Station (Flowchart)	1145		5-5
Dirt w/Shovel	4557	1	3-11	Easel w/Canvas	3948	17	3-21
Disc				Easter			
Platters	2801	8	3-12	Bunny	4709P	2	4-11
Storage (Flowchart)	1914		5-4	Chick	4787P	2	4-11
Discs				Duckling	4710P	2	4-11

## Alphabetical Symbol Index, continued

Description	Number	Lib.	Page	Description	Number	Lib.	Page
Eggs Composite		2	4-11	Film Strip	4406	1	3-10
Education Owl	4757P	2	4-10	Fire	2449		3-8
Egg (w/Baby Chick)	4320P		4-3	Fire Extinguisher	2413		3-8
Eggplant	2871P	11	4-24	Fire Hose	4563	8	3-13
Eiffel Tower	3672	17	3-20	Fire Hydrant	4410	1	3-10
Eight Ball	3359		3-7	Fire Truck	5044P	15	4-28
Eighth Note (Music)	1753		1-1	Firecracker			
Eighth Notes (Music)	1748		1-1	w/Fuse	4823P	2	4-12
Electric				Exploding	4717P	2	4-12
Plug (Curved Cord)	4537	1	3-10	Fireworks	4719P	2	4-12
Plug (Straight Cord)	2974	8	3-13	First Aid Kit	3274	10	3-16
Socket	2264		3-8	Fish	3028	9	3-15
Electron Tubes		4	5-15	Fish	4111P		4-5
Electronic Components	4552	1	3-11	Fish Chasing Fish Chasing Fish	3517P	3	4-17
Electronics and Logic		4	5-11	Flag			
Elephant	4057		3-7	Flag	1944		3-8
Ellipses			2-3	Flag	4397P		4-2
Engine				13 Colonies	4718P	2	4-12
Modern	1967		3-6	Checkered	3114	16	3-18
Steam	4098		3-6	United States (Stylized)	3507	1	3-10
Envelope				Waving	1946		3-8
Back	2295		3-9	Flame	2249		3-8
Front	2297		3-9	Flame and Nozzle	4516	1	3-11
Equals (=)	2673		3-2	Flamingo	3795	17	3-21
3-D	1718		3-2	Flashlight w/Spot	2708P		4-2
Erlenmeyer Flask	4201		3-6	Flask			
Erlenmeyer Flask	4230P		4-5	Chemical	3791	10	3-16
Excavator	3537P	15	4-29	Erlenmeyer	4201		3-6
Exclamation Point				Erlenmeyer	4230P		4-5
3-D	1720		3-2	Florence	4221P		4-5
Block	1506		3-1	Volumetric	4231P		4-5
Round	2130		3-1	Flasks			4-5
Executioner's Ax	2437		3-8	Flat-Bed Trailer	3535P	15	4-28
Explosion				Flat-Bed Truck	3521P	15	4-28
Fragments	4127P		4-2	Flatcar	2945	8	3-12
Hole	4128P		4-2	Flowcharts			5-5
of Sphere	1723P		4-2	Flowcharts, DP			5-4
w/Fragments	4981P	7	4-23	Flowers in Vase	3166	9	3-15
Explosions			1-10	Fly	3650	16	3-18
Exponential				Foil (Fencing)	4336P		4-2
Curve	3324		2-1	Food Service Sign	4088		3-3
w/Axes	1255		5-3	Foot in Mouth	4472P	3	4-17
Inverse	3325		2-1	Foot in the Door	4243P	3	4-17
Inverse w/Axes	1256		5-3	Football	4801P	2	4-10
Extinguisher, Fire	2413		3-8	Football Helmet	3060	10	3-17
Extract (Flowchart)	1003		5-4	Footprints	3346P		4-6
Eye	3057	10	3-17	Footprint	3007	17	3-20
Eyeglasses	4675	1	3-10	(Shoe On)	2931	8	3-13
Faces				Forest (Burned)	3653	16	3-19
Cartoon Form	4118		3-7	Fork Lift	3531P	15	4-29
Men's		13	4-26	Fork Lift	4534	1	3-11
Profile	1969		3-7	Forms			3-9
Profile	4384P		4-3	Four Leaf Clover	1948		3-8
Profile w/Globe	4370P		4-3	Frames			
Smiling Man	4146P		4-3	3-D			2-8
Woman	4402P		4-3	Page Borders			1-9
Women's		13	4-27	Sign			3-3
Factory w/Explosion	2938	8	3-13	French Horn	4521	1	3-10
Family	2433		3-7	Front-End Loader	4576P	15	4-29
Farm				Front-End Loader, Small	4577P	15	4-29
Barn	4046		3-5	Fruit			
Buildings Scene	2883P	11	4-25	Apple	2852P	11	4-24
Buildings/Fields	4080P		4-7	Apricots	2859P	11	4-24
Faucet	4383P		4-2	Banana	2853P	11	4-24
Felt Tip Pen	3185	10	3-17	Cantaloupe	2865P	11	4-24
Female Symbol	1709		3-2	Cantaloupe	4554P	11	4-24
File and Drum Corps Composite		2	4-12	Cherries	2867P	11	4-24
File Cabinet	2274		3-9	Grapefruit	2875P	11	4-24
File Cabinet	4423P		4-5	Grapes	4550P	11	4-24
File Cabinet, Open	4352P		4-5	Lemon	2869P	11	4-24
File Folders	2915	8	3-12	Orange	2855P	11	4-24
Film (35mm Roll)	3951	17	3-21	Peach	4508P	11	4-24

## Alphabetical Symbol Index, continued

Description	Number	Lib.	Page	Description	Number	Lib.	Page
Pear	2421P	11	4-24	Work	3276	16	3-19
Pineapple	2899P	11	4-24	Gold Bars	4043P		4-1
Strawberries	2854P	11	4-24	Golf Ball (on Tee)	4363P		4-1
Tomato	4551P	11	4-24	Golf Ball and Flag	3930	17	3-21
Watermelon	4990P	11	4-24	Goodbye, Man Waving	4476P	3	4-17
Function Keys				Graduated Cylinder	4229P		4-5
(On Screen)	1264		5-4	Grain			
10	2678		5-4	Barley	4505P	11	4-25
8	2677		5-4	Corn	3085	16	3-18
Enlarged	1263		5-4	Corn	4501P	11	4-24
Functions				Oats	4504P	11	4-25
Bell	3323		2-1	Rice	4503P	11	4-25
Cubic	3326		2-1	Rye	4506P	11	4-25
Exponential	3324		2-1	Wheat, Shock of	2957	9	3-14
Hyperbolic	3329		2-1	Wheat	4502P	11	4-25
Inverse Exponential	3325		2-1	Grain Elevator	2435		3-5
Parabolic	3328		2-1	Grain Silo	3130	16	3-18
Quartic	3327		2-1	Grain Truck	3520P	15	4-28
Sine/Cosine	3330		2-1	Gramophone	4428		4-1
Tangent	2644		2-1	Grapefruit	2875P	11	4-24
Functions w/Axes				Grapes	4550P	11	4-24
Bell	1251		5-3	Gravestone	3169	9	3-15
Cubic	1253		5-3	Graveyard	4769P	2	4-13
Cubic, Inflection	1252		5-3	Grease Gun	4535	1	3-11
Exponential	1255		5-3	Green Beans	2860P	11	4-24
Inverse Exponential	1256		5-3	Grids			
Logarithmic	1257		5-3	Circular			5-2
Parabolic	1258		5-3	Composition Aids			4-8
Funnel	4227P		4-5	Grim Reaper	4773P	2	4-13
Funnel Cloud (Tornado)	4143P		4-6	Groceries, Sack of	3173	16	3-19
Galaxy	4907P	7	4-20	Ground Hog	4812P	2	4-9
Gallon Jug	3151	9	3-14	Guitar, 3-String	3022	9	3-15
Garbage Truck	5043P	15	4-28	Gun			
Garlic	2857P	11	4-25	Pistol	2285		3-8
Gas Generating Jar	4234P		4-5	Rifle	2712		3-8
Gas Lamp	2912	8	3-13	Half Moon	4086		1-2
Gas Mask	3282	16	3-19	Half Moon	4170P		4-7
Gas Plant	4049		3-5	Half Note (Music)	1752		1-1
Gas/Oil Well w/Underground Pocket	3942	17	3-21	Halloween			
Gasoline				Bat Corner	4834P	2	4-13
Can	4266	1	3-11	Bats w/Moon Composite			2 4-12
Pump	2263		3-5	Cat	4768P	2	4-13
Pumping	3690	17	3-21	Cat	4868P	2	4-13
Gate, Security	3269	17	3-20	Owl	4777P	2	4-13
Gaussian Curve	3323		2-1	Skull Corner	4835P	2	4-13
w/Axes	1251		5-3	Ham	2882P	11	4-25
Gavel	2042		3-7	Hammer, Sledge	3047	10	3-17
Gear	4496	1	3-11	Hand			
Gears	4061		3-6	Halt!	3046	10	3-17
Geese, Migrating	4809P	2	4-10	Holding World	4467P	3	4-16
Genie's Lamp	3132	10	3-16	OK Sign	3048	10	3-17
Geometrics				Peace/Victory	3009	10	3-17
George Washington	4816P	2	4-11	Pointing	1121		1-6
w/Cherry Tree Composite				Pointing (Palm Down)	4132P		4-3
Ghost, Flying	4764P	2	4-12	Pointing (Palm Out)	4131P		4-3
Gibbons Moon	2730		1-2	Thumbs Up	3184	10	3-17
Giraffe	3010	10	3-16	Uncle Sam's w/Palm Up	3115	10	3-17
Girl	2283		3-7	Hands			
Glass				Reaching Toward Each Other	3165	10	3-17
of Cold Liquid	3263	16	3-19	Shaking	4996	10	3-16
w/Straw	4181	8	3-12	Shaking	4130P		4-3
Broken	3293	16	3-19	Hand-to-Person Confrontation	3516P	3	4-17
Martini	4343P		4-5	Hand Truck (Dolly)	2047		3-8
Globe				w/Boxes	3031	9	3-14
w/Grid	4036		3-9	Harbor Scene	4455P		4-7
w/Head	4370P		4-3	Hard Hat	2290		3-7
w/Meridian Lines	4037		3-9	Hats			
w/Skyline	4364P		4-5	Flat Brim	2922	8	3-12
w/Stand	4298	1	3-10	Hard Hat	2290		3-7
Glove	2929	8	3-13	Miner's Helmet	2424		3-7
Gloves				Top	4237		3-7
Boxing	4365P		4-1	Uncle Sam's	4332P		4-2



## Alphabetical Symbol Index, continued

Description	Number	Lib.	Page	Description	Number	Lib.	Page
Western Style	3973	8	3-12	Humpty Dumpty	4311P		4-3
Hay Bales	2873P	11	4-25	Hurricane Lamp	4518	1	3-11
Heads				Hydraulic Jack	4528	1	3-10
Cartoon	4118		3-7	Hyphen (-)	1706		3-2
Profile w/Globe	4370P		4-3	I-Beam			
Profile	1969		3-7	Cross Section	2420		3-6
Profile	4384P		4-3	and Pulley	4532	1	3-11
Smiling Man	4146P		4-3	Ice Cream Cone	4571	1	3-10
Woman	4402P		4-3	Icons			3-5
Headphones	3286	9	3-15	In/Out Basket	3383		3-9
Hear No Evil, See No Evil etc.	4466P	3	4-16	Indian			
Heart	1580		3-7	Scout	3701P	3	4-17
Heart (Playing Card)	1581		1-1	w/Headdress	3170	17	3-20
Heavy Equipment				Inductors (Electronics)			4 5-11
Back Hoe	4578P	15	4-29	Infinity (Notation)	1780		3-2
Bulldozer	3968P	15	4-29	Ingots	4043P		4-1
Bulldozer	4580P	15	4-29	Input, Manual (Flowchart)	1921		5-4
Bulldozer	4581P	15	4-29	Input/Output (Flowchart)	1915		5-4
Crawler Tractor	3541P	15	4-29	Insect	3017	16	3-18
Crawler Tractor w/Trailer	3540P	15	4-29	Insulated Wire/Cable	3181	8	3-13
Ditch Digger	3501P	15	4-29	Integral (f)	1714		3-2
Dock Crane	3006	9	3-14	Integrated Circuits			4 5-18
Earth Mover/Scraper	3529P	15	4-29	Interrupt, Terminal (Flowchart)	1656		5-4
Earth Remover Digging	3938	17	3-21	Inverse Multiplexer (Flowchart)	2019		5-5
Earth Scraper	3539P	15	4-29	It's a Small World	4467P	3	4-16
Excavator	3537P	15	4-29	Jack O'Lantern	4767P		2 4-12
Fork Lift	3531P	15	4-29	Jack O'Lantern Composite			2 4-12
Fork Lift	4534	1	3-11	Jack, Hydraulic	4528	1	3-10
Front-End Loader	4576P	15	4-29	Jacket	2909	8	3-12
Front-End Loader, Small	4577P	15	4-29	Jail	4002		3-7
Portable Generator	3526P	15	4-29	Jalapeno	2877P	11	4-25
Power Shovel	3966P	15	4-29	Jar, Gas Generating	4234P		4-5
Road Grader	4582P	15	4-29	Jeans	3055	10	3-17
Road Grader	3542P	15	4-29	Jet Fighter	2946	8	3-13
Scissor Lift	3967P	15	4-29	w/Explosion	2947	8	3-13
Sheeps Foot Dozer	4885P	15	4-29	Jewel (Diamond)	4069P		4-1
Sheeps Foot Dozer Wheel	4886P	15	4-29	Judge	4029		3-7
Snorkle Lift	3969P	15	4-29	Jupiter	4911P	7	4-20
Steam Roller	3524P	15	4-29	w/Space Probe in Orbit	3751P	7	4-21
Steam Roller	4583P	15	4-29	Kerosene Lamp	4518	1	3-11
Tractor	4579P	15	4-29	Keys			
Truck Crane	3955P	15	4-29	Common	4407P		4-2
Heavy Industry	4077P		4-7	Old-Fashioned	4210P		4-2
Helicopter	2280		3-6	Several On Ring	4314P		4-2
Hen	4071		3-7	Skeleton	4361P		4-2
Hexagons				Keyhole	4073		3-7
High Amp Switch (Open)	4543	1	3-11	Keying (Flowchart)	1653		5-4
Highlight (Whorl)	1932		1-2	King (Chess Piece)	3125	16	3-18
Highway	3343P		4-8	Kite	3959	17	3-21
Highway (Symbolic)	3190	16	3-18	Knife, Hunting	3195	16	3-19
Highway Overpass, Unfinished	4431P		4-4	Knight (Chess Piece)	3122	16	3-18
Hills	4153P		4-6	Ladder	3062	17	3-20
Hills/Mountains (Horizon)	3346P		4-6	Ladle, Steel Mill	2407		3-6
Hilly Road	4236P		4-8	Lamps			
Hole	4128P		4-2	Aladdin's	3132	10	3-16
Holidays and Seasons			2 4-9	Gas	2912	8	3-13
Holly Border Composite			2 4-14	Kerosene	4518	1	3-11
Holly Leaves and Berries Composite			2 4-15	Table	2292		3-8
Hook (Industrial)	3978	17	3-20	Lamps (Electronics)			4 5-15
Hopper Car	3674	8	3-12	Landscapes			4-6
Horn				Layout, Office			5-6
French	4521	1	3-10	Leaf			
Celebration	3945	17	3-21	Maple	1949		3-8
Horse in Motion	3972	17	3-21	Maple	4041P		4-1
Hospital Patient	3290	16	3-19	Oak	4356P		4-1
Hot Air Balloon	4347P		4-4	Leaves, Man Raking	4795P	2	4-10
Hot Dog	4570	1	3-10	Lemon	2869P	11	4-24
Hour Glass	2981	9	3-14	Lens, Convex	2551		2-3
House				Leprechaun	4804P	2	4-11
Small	2298		3-5	Less Than (<)	1702		3-2
Split Level	3136	10	3-16	Less Than or Equal To (≤)	1707		3-2
under Construction	3661	16	3-19	Lettuce	2858P	11	4-24

## Alphabetical Symbol Index, continued

Description	Number	Lib.	Page	Description	Number	Lib.	Page
Liberty Bell	4822P	2	4-12	w/Magnifying Glass	4165P		4-3
Light				Manual Input (Flowchart)	1921		5-4
Beam	1799		1-2	Manual Operation (Flowchart)	1916		5-4
Bulb	3051	9	3-15	Map			
Bulb	4425P		4-2	State Lines for USA	4395P		4-5
Bulbs	4565	1	3-11	Time Zones for USA	4126P		4-5
Tube	3187	9	3-15	USA 3-D	4350P		4-5
Lighted Buoy	4138		3-5	USA Outline	4103P		4-5
Lighthouse	2442		3-5	USA w/States	4349P		4-5
Lightning				1949			3-8
Bolt	4815P	2	4-9	4041P			4-1
Bolt (Curved)	2053		1-2	4016P			7 4-21
Bolt (Straight)	2052		1-2	4963P			7 4-21
Storm	4142P		4-6	w/Orbiting Spacecraft	4928P		2 4-11
Line Charts				Martini Glass	4343P		4-5
Line Concentrator (Flowchart)	1667		5-5	Masks			
Line of People Waiting	4474P	3	4-16	Comedy	3172	16	3-18
Line Sharing (Flowchart)	1669		5-5	Robbers	3147	17	3-20
Line, Single	2487		2-1	Tragedy	3171	16	3-18
Lines				Match	2934	17	3-20
Parallel	2488		2-1	Burning	2935	17	3-20
Perpendicular			2-1	Maze	4445P		4-1
Links, Communication (Flowchart)			5-5	Medal	4004		3-7
Lipstick	3153	10	3-16	Medical Logo (Caduceus)	4052		3-7
Lock				Medical Tape	2918	8	3-12
Padlock	4109P		4-2	Medicine Bottle and Capsules	2913	8	3-12
Keyhole	4073		3-7	Memorial Day	4714P		2 4-12
Locomotive	2941	8	3-12	Menorah	4790P		2 4-15
w/Explosion	2942	8	3-13	Mercury Capsule	4929P		7 4-19
Modern	1967		3-6	Mercury Landscape	3763P		7 4-21
Steam	4098		3-6	Merge (Flowchart)	1918		5-4
Log Cabin	4824P		2 4-11	'Merry Christmas' Composite	3278		16 3-10
Logarithmic				Mesas	2663		1-13
Curve w/Axes	1257		5-3	Message (Bulletin Board)	4967P		7 4-20
Grids			5-2	Meteor	4529	1	3-10
Logic Symbols (Electronics)			4 5-18	Microphone			
Loving Cup (Trophy)	4027		3-7	Hand-Held	3281	16	3-19
Lozenges			2-3	On Stand	2299		3-6
Luggage w/Travel Stickers	3687	17	3-20	Microscope	2043		3-6
Lumber	4672	1	3-11	Mid-Sized Automobile			
Lunar				Four-Door	5021P	15	4-28
Module	3546P	7	4-19	Two-Door	5017P	15	4-28
Roving Vehicle	4933P	7	4-19	Migrating Geese	4809P		2 4-10
Lungs	3977	17	3-21	Milk Can	4564		1 3-10
Magnet	1578		3-7	Milk Carton	3277	16	3-19
Magnetic Tape (Flowchart)	1662		5-4	Milling Machine	2415	1	3-11
Magnifying Glass	4351P		4-2	Mine Head	2436		3-5
Magnifying Glass	4368		3-8	Mine Ore Car	4264	1	3-11
Mail	2916	8	3-12	Miner's Helmet	2424		3-7
Mail Deposit Box	3061	10	3-17	Mining	3188	10	3-17
Mailbox	2970	9	3-14	Mining w/Tunnels	3937	17	3-21
Male Symbol	1710		3-2	Mining, Strip	3938	17	3-21
Man				Minus (-)	1706		3-2
Chastising	4465P	3	4-16	Missile (On Launch Pad)	3660	8	3-13
Cracking Whip	3515P	3	4-17	Missiles	4053		3-6
Daydreaming	4247P	3	4-17	Mission (Church Building)	3958	17	3-21
Hands in Pockets	2282		3-7	Modem	1973		3-9
in Washing Machine	4477P	3	4-16	Flowchart	1665		5-5
Indifferent/Unconcerned	4954P	3	4-16	Multiport (Flowchart)	1670		5-5
Looking Around Corner	3702P	3	4-16	Molar	3073	10	3-17
On Strike/Protesting	4473P	3	4-16	Money			
Pulling Rope	4145P		4-3	Bag	2962	9	3-14
Reading (Standing)	3708P	3	4-17	Talks	4848P	3	4-16
Reading in Easy Chair	4468P	3	4-16	International	4451		3-8
Running	4246P	3	4-17	Stack of	3054	10	3-16
Running Scared	4446P		4-3	Monkey Wrench	3667	17	3-20
Smiling	4146P		4-3	Monopoly Board	3940	17	3-21
Symbolic	1953		3-7	Moon			
Taking Charge	4463P	3	4-16	Crescent	4170P		4-7
Waving (Facing Away)	4476P	3	4-17	First Quarter	4086		1-2
Weightlifter	4204P		4-3	Rocks	4985P	7	4-23
w/Foot in Mouth	4472P	3	4-17				

## Alphabetical Symbol Index, continued

Description	Number	Lib.	Page	Description	Number	Lib.	Page
Third Quarter	2730		1-2	Rig	4366		3-5
Topographic	4910P	7	4-20	Rig	4372P		4-4
w/Smiling Face	4708P	2	4-11	Tanker Truck	3534P	15	4-28
Moons in Orbit	4989P	7	4-21	Well w/Underground Pocket	3942	17	3-21
Mop and Bucket	3287	9	3-15	Olives	2874P	11	4-25
Mortar and Pestle	4495	1	3-10	On-Line Storage (Flowchart)	1658		5-4
Motor, Electric	4255	1	3-11	On-Page Connector (Flowchart)	1980		5-4
Mountain				One, 3-D	4228P		4-1
Curve	4081P		4-8	Onion	2876P	11	4-24
Peaks	4155P		4-6	Open Box	4038P		4-1
Scene	3348P		4-6	Orange	2855P	11	4-24
Mountains	3145	17	3-20	Organizational Charts			5-1
Mountains/Hills (Horizon)	3346P		4-6	Ostrich w/Head in Sand	2996	10	3-16
Mouse	3020	9	3-15	Ounce (oz)	2792		3-1
Mouth (Open Wide)	4245P	3	4-17	Output (Flowchart)	1915		5-4
Movie				Ovals			2-3
Camera	2265		3-6	Overpass, Unfinished	4431P		4-4
Projector	3040	9	3-14	Owl			
Moving Truck	3522P	15	4-28	Education	4757P	2	4-10
Moving Van	3528P	15	4-28	Halloween	4777P	2	4-13
Mug, Coffee	2286	8	3-12	PBX (Flowchart)	1677		5-5
Mule	4058		3-7	Packet (Flowchart)	1001		5-5
Multiplexer				Pad and Pencil	2296		3-9
Flowchart	1671		5-5	Pad of Paper (Border)	4196		1-9
Inverse (Flowchart)	2019		5-5	Padlock	4109P		4-2
Multiplication (X)	1704		3-2	Page Borders			1-9
Multiport Modem (Flowchart)	1670		5-5	Paint			
Mushrooms	4584P	11	4-24	Brush and Can	2419		3-8
Music	4015		3-8	Brush, Artists	3066	10	3-17
Musical Notes			1-1	Bucket	3927	17	3-21
Nail Gun, Pneumatic	3666	17	3-20	Roller	3039	9	3-14
Nativity Scene	4785P	2	4-14	Palette	4389P		4-1
Natural Gas (Nozzle w/Flame)	4516	1	3-11	Palm Tree	2982	16	3-18
Neptune	4960P	7	4-21	Palm Tree	3366P		4-7
Networks			5-7	Pamphlet	1526		3-9
New Year's Reveller	4806P	2	4-15	Paper			
New Year's Toast	4819P	2	4-15	and Pulp Process Flow Library		12	5-38
Newspaper	3106	16	3-18	Bent Corner	1547		1-13
Nickle	3118	10	3-16	Certificate	3691	17	3-21
Node (Flowchart)	1980		5-5	Computer	1495		3-9
North Wind and Leaves Composite		2	4-10	Continuous Form	3080	10	3-16
Not Equal	2674		3-2	Diploma	3128	10	3-16
Notation			3-1	Document	3164	17	3-20
Note (Bulletin Board)	2663		1-13	Folded	4345		3-9
Notes, Music	4015		3-8	Money (Generic)	2956	9	3-14
Notes, Music (Individual)			1-1	Pad w/Pencil	2296		3-9
Nuclear Power Plant	4047		3-5	Pages Lifted	1979		3-9
Number Sign (#)	2028		3-1	Reams of	3152	9	3-14
3-D	4040		3-2	Roll of	4562	1	3-11
Number One, 3-D	4228P		4-1	Strewn About	3657	17	3-20
Nut and Bolt	2928	8	3-13	Torn	4374		3-9
Oak Leaf	4356P		4-1	Unfolded w/Dart	3961	17	3-21
Oats	4504P	11	4-25	w/Corner Curved Up	2715	17	3-20
Oblique, 3-D Geometrics			2-4	w/Corner Mountings	3965	17	3-21
Observatory	4922P	7	4-19	Parabola	3328		2-1
Octagons			2-2	Parabola w/Axes	1258		5-3
Octahedrons			2-8	Parachute	3179	10	3-17
Off-Page Connector (Flowchart)	1924		5-4	Paragraph (%)	2791		3-2
Office Building				Parallelograms			2-2
One Story	4011		3-5	Parchment (Border)	1937		1-9
Skyscraper	4050		3-5	Parenthesis ( )	2129		3-2
Office Layout			5-6	Parenthesis/Bracket (())	2131		3-2
Offshore Oil Platform	2959	8	3-13	Parrot	3796	17	3-21
Oil				Pawn (Chess Piece)	3120	16	3-18
Can	4299	8	3-13	Payload Assist Module	4979P	7	4-20
Can (Pour)	4358P		4-5	Peace/Victory Sign	3009	10	3-17
Can (Squirt)	4338P		4-5	Peach	4508P	11	4-24
Derrick	2936	8	3-12	Peanut	4510P	11	4-25
Derrick	4366		3-5	Pear	2421P	11	4-24
Pump	1966		3-5	Peas in a Pod (One Pod)	4324P	11	4-24
Refinery	2434		3-5	Peas in a Pod (Three Pods)	4515P	11	4-24
Refinery	4078P		4-7	Pen, Calligraphy	3932	17	3-21

## Alphabetical Symbol Index, continued

Description	Number	Lib.	Page	Description	Number	Lib.	Page
Pencil	4039P		4-5	Royal Guard	3671	9	3-15
Penguin w/Suit	4464P	3	4-17	Royal Guard at Attention	3944	17	3-21
Pennant	4398P		4-2	Santa Claus	4783P	2	4-14
Pennant w/Hand	3962	10	3-16	Santa Claus and Sleigh	4844P	2	4-15
One Point	1945		3-8	Sergeant (Angry/Pointing)	4241P	3	4-17
Swallowtail	2438		3-8	Smiling Man	4146P		4-3
Pentagon				Soldier	3069	10	3-16
Equilateral	2519		2-2	Soldier, Cowering	4242P	3	4-17
Irregular	2520		2-2	Strong Man	4204P		4-3
People				Student/Man at Desk	3071	10	3-16
Abraham Lincoln	4831P	2	4-11	Swimming Pool Cartoon	4789P	2	4-9
Astronomer	4475P	3	4-17	Thanksgiving Indian	4807P	2	4-13
Audience Watching Screen	3108	17	3-20	Thanksgiving Pilgrim	4808P	2	4-13
Boy	2262		3-7	Trudging through Snow	4772P	2	4-10
Boy	4775P	2	4-11	Wait a Moment	4246P	3	4-17
Businessman	3111	10	3-16	Waiting in Line	4474P	3	4-16
Bust of Lincoln	3067	10	3-17	Weighlifter	4204P		4-3
Committee/Board	3096	9	3-15	Witch w/Moon		2	4-12
Cowboy (Pointing at You)	4124P	3	4-17	Witch w/Moon	2284		3-7
Crowd (Facing Away)	3703P	3	4-16	Woman	2439		3-7
Cupid	4720P	2	4-11	Woman	4402P		4-3
Daydreamer	4247P	3	4-17	Woman Working at Desk	3002	10	3-16
Doctor	3077	10	3-16	Woman w/Shopping Cart	3026	10	3-16
Family	2433		3-7	Women's Heads and Faces		13	4-27
Fife and Drum Corps		2	4-12	Per Thousand (Notation)	2035		3-1
George Washington	4816P	2	4-11	Percent (%)	2034		3-1
George Washington w/Cherry Tree		2	4-11	Perpendicular Lines			2-1
Ghost	4764P	2	4-12	Person	1959		3-7
Girl	2283		3-7	Perspective, 3-D Geometrics			2-7
Girl	4776P	2	4-11	Petroleum/Chemical Process Flow Library		14	5-41
Grim Reaper	4773P	2	4-13	Phone	2275		3-9
Hand-to-Person Confrontation	3516P	3	4-17	Phone	4444P		4-5
Hear No Evil, See No Evil etc.	4466P	3	4-16	Phonograph	4428P		4-1
Hospital Patient	3290	16	3-19	Photo w/Corner Mountings	3965	17	3-21
Indian Scout	3701P	3	4-17	Photographic Enlarger	3088	9	3-15
Indian w/Headress	3170	17	3-20	Slide	3091	16	3-18
Inept Skier	4786P	2	4-15	Pi ( $\pi$ )	1712		3-2
Judge	4029		3-7	Pick and Shovel	2417		3-6
Leprechaun	4804P	2	4-11	Pick-Up Truck	3525P	15	4-28
Line of People Waiting	4474P	3	4-16	Pick-Up Truck	5035P	15	4-28
Man	2282		3-7	Pick-Up Truck w/Portable Generator	3532P	15	4-29
Man Cracking Whip	3515P	3	4-17	Pictorials			4-1
Man Daydreaming	4247P	3	4-17	Pie Charts			5-3
Man Drinking at Table	3025	10	3-16	Pig	3140	16	3-19
Man Looking Around Corner	3702P	3	4-16	Pig	4328P		4-3
Man On Strike/Protesting	4473P	3	4-16	Pilgrim Hat	4820P	2	4-13
Man Pulling Rope	4145P		4-3	Pin Insulator	3186	8	3-13
Man Raking Leaves	4795P	2	4-10	Pinch Rollers	4674	1	3-11
Man Reading (Standing)	3708P	3	4-17	Pineapple	2899P	11	4-24
Man Reading in Easy Chair	4468P	3	4-16	Pinwheels			1-2
Man Running	4246P	3	4-17	Pipe Fittings and Valves Library		6	5-29
Man Running	4446P		4-3	Corrugated	4559	1	3-11
Man Smiling	4146P		4-3	T-Joint	4536	1	3-11
Man Taking Charge	4463P	3	4-16	Pipeline Symbolic	3664	16	3-18
Man Waving (Facing Away)	4476P	3	4-17	End (Liquid Pouring Out)	2969	8	3-13
Man Waving Goodbye	4476P	3	4-17	Valve	4497	1	3-11
Man Working at Desk	3001	10	3-16	Pipes (Three Stacked)	4544	1	3-11
Man at Podium	3097	10	3-17	Pistol	2285		3-8
Man in Washing Machine	4477P	3	4-16	Plane, Wood	2416		3-6
Man w/Foot in Mouth	4472P	3	4-17	Planet w/Rings	1741		3-6
Man w/Magnifying Glass	4165P		4-3	Planetary Probe	4976P	7	4-22
Man, Chastising	4465P	3	4-16	Planets/Moons Earth	3773P	7	4-20
Man, Indifferent/Unconcerned	4954P	3	4-16	Jupiter	4911P	7	4-20
Martin Luther King, Jr.	4928P	2	4-11	Jupiter w/Space Probe	3751P	7	4-21
Men Drinking at Table	3024	10	3-16	Mars	4906P	7	4-21
Men Shaking Hands	3023	10	3-16	Mars w/Orbiting Spacecraft	4963P	7	4-21
Men's Heads and Faces		13	4-26	Mercury Landscape	3763P	7	4-21
Murder Victim/Outline	3654	10	3-16				
Person (Symbolic)	1959		3-7				
Policeman	3079	10	3-16				
Professor	3075	10	3-16				

## Alphabetical Symbol Index, continued

Description	Number	Lib.	Page	Description	Number	Lib.	Page
Moon	4910P	7	4-20	Oil Well	1966		3-5
Moons in Orbit	4989P	7	4-21	Punched Card (Flowchart)	1652		5-4
Neptune	4960P	7	4-21	Punched Tape (Flowchart)	1657		5-4
Planet Rising over Rocks	4972P	7	4-21	Purse	2999	10	3-16
Pluto	4988P	7	4-21	Push-cart	2924	8	3-13
Pluto Landscape	3760P	7	4-21	Puzzle Pieces	4555	8	3-12
Saturn	4908P	7	4-20	Pyramids	4375P		4-6
Saturn	4987P	7	4-21	Pyramids			2-4
Uranus Landscape	3762P	7	4-21	Quadrilaterals			2-2
Venus	4869P	7	4-20	Quarry	3943	17	3-21
Plant	3139	16	3-18	Quarter Note (Music)	1753		1-1
Plastic Containers	4871	1	3-10	Queen (Chess Piece)	3124	16	3-18
Plate Glass	3504	1	3-11	Question Mark	1505		3-1
Platform Truck	3030	9	3-14	3-D	2731		3-2
Pliers, Channel Lock	4322P		4-2	Tapered	1583		3-1
Plotters		5	5-24	Quill and Ink Well	4531	1	3-10
Plus (+)	1705		3-2	Quotation Marks			3-1
3-D	1719		3-2	Rabbit	3019	9	3-15
Plus or Minus (±)	1715		3-2	Radiation	1598		1-1
Pluto	4988P	7	4-21	Radio			
Pluto Landscape	3760P	7	4-21	Tower	2406		3-5
Plywood	4673	1	3-11	Tower w/Explosion	2939	8	3-13
Polar Coordinate Axes			5-2	Modern	2288		3-6
Police Cruiser	5033P	15	4-28	Old-Fashioned	2048		3-8
Policeman	3079	10	3-16	Radishes	2862P	11	4-24
Polled Terminal (Flowchart)	1675		5-2	Railcar			
Polyhedron, 20-Sided	2447		2-8	Double Wheel and Assembly	3176	16	3-19
Polyhedrons			2-8	Single Wheel and Assembly	3175	16	3-19
Poolside Accessories	4794P	2	4-9	Railroad			
Popsicle	3686	17	3-20	Car	1968		3-6
Portable Generator	3526P	15	4-29	Engine, Modern	1967		3-6
Portrait Gallery Library		13	4-26	Engine, Steam	4098		3-6
Potato	4522P	11	4-24	Tracks	4339P		4-8
Pots and Pans	4561	1	3-10	Tracks (Symbolic)	3189	16	3-18
Pottery	4569	1	3-10	Rain Cloud	2988	9	3-15
Pound				Rainbow w/Pot of Gold	2702P		4-1
(#)	2028		3-1	Raking Leaves	4795P	2	4-10
3-D	4040		3-2	Razor	3655	17	3-20
(lb.)	2036		3-1	Razor Blade, Single Edge	3268	17	3-20
Sterling (Notation)	2039		3-1	Razor, Double-Edge	4265	1	3-10
Power				Reactor	4047		3-5
Plant, Nuclear	4047		3-5	Record			
Shovel	3966P	15	4-29	Album	3146	10	3-17
Prairie	4152P		4-6	Player	4428P		4-1
Preparation (Flowchart)	1917		5-4	Redstone Rocket	4938P	7	4-19
Prescription (B)	1716		3-2	Reel of Tape	2914	8	3-12
Pressure Valve	4105P		4-2	Reference Point (Flowchart)	1116		5-4
Price Tag	3668	9	3-14	Refinery	2434		3-5
Primitives			2-1	Refinery (Horizon)	4078P		4-7
Printer				Refrigerator	2293		3-8
3-D	1978		3-9	Registered Trademark (®)	2745		3-2
Simple	1977		3-9	Registration Marks			1-1
Printers		5	5-26	Reindeer	4845P	2	4-15
Printout (Flowchart)	1655		5-4	Reindeer	4847P	2	4-15
Prisms				Relays (Electronics)		4	5-13
3-D			2-6	Remote Batch Terminal	1678		5-5
Oblique			2-4	Resistors (Electronics)		4	5-11
Process	1669		5-4	Retort	4390P		4-5
Production Line Rollers	4540	1	3-10	Retort, Glass	3098	10	3-16
Professor	3075	10	3-16	Rhinoceros	3663	16	3-19
Profile				Rhombus	1004		2-2
w/Globe	4370P		4-3	Ribbon (1st Place)	4371P		4-1
Human Head	1969		3-7	Rice	4503P	11	4-25
Human Head	4384P		4-3	Rifle	2712		3-8
Profile/Bust of Lincoln	3067	10	3-17	Right Angle	2620		2-1
Propane Torch	4256	1	3-11	Ring-The-Bell			
Protractor	2664		2-1	Front View	4333P		4-1
Puddle	1549		1-10	Top View	4335P		4-1
Pueblo	3680	17	3-20	Road			
Pulp and Paper Process Flow Library		12	5-38	Intersections			4-8
Pump				w/Hills	4154P		4-8
Gasoline	2263		3-5	w/Hills	4236P		4-8

## Alphabetical Symbol Index, continued

Description	Number	Lib.	Page	Description	Number	Lib.	Page
w/Signs	4302P		4-8	Saturn Rocket			
Curved	4459P		4-8	IB	4932P	7	4-18
Mountainside	4081P		4-8	V	4849P	7	4-19
Straight	3343P		4-8	V w/Apollo Capsule	4946P	7	4-19
Road Grader	4582P	15	4-29	V w/Skylab	4935P	7	4-20
Road Grader	3542P	15	4-29	Saw	3049	16	3-18
Road Roller	4110P		4-4	Saxophone	3949	17	3-21
Robot Arm	3070	10	3-17	Scale			
Rockets	4053		3-6	Hanging Produce Type	3929	17	3-21
Rockets/Capsules				Balanced	4005		3-7
Apollo Capsule	4931P	7	4-19	Unbalanced	4006		3-7
Atlas Centaur	4850P	7	4-19	Scales of Justice	3107	10	3-16
Mercury Capsule	4929P	7	4-19	Schoolhouse	2040		3-5
Redstone	4938P	7	4-19	Schooner	3082	10	3-16
Rocket	4974P	7	4-20	Scissor Lift	3967P	15	4-29
Rocket w/Flames	3749P	7	4-22	Scissors	3005	9	3-14
Rocket, 1-Stage	3764P	7	4-19	Scissors			
Rocket, 3-Stage	3759P	7	4-19	Closed	4321P		4-2
Saturn 1B	4932P	7	4-18	Open	4382P		4-2
Saturn V	4849P	7	4-19	Screen			
Saturn V w/Apollo Cap	4946P	7	4-19	CRT	1097		5-4
Saturn V w/Skylab	4935P	7	4-20	w/Function Keys	1264		5-4
Rocks/Boulders	4985P	7	4-23	w/Function Keys Enlarged	1263		5-4
Rocky Slopes	4151P		4-6	w/People Watching	3108	17	3-20
Roll of Paper	4562	1	3-11	Screwdriver w/Screw	3291	9	3-15
Rolodex Card	3265	17	3-20	Scroll	2113		3-9
Rook (Chess Piece)	3121	16	3-18	Scroll	3652	9	3-15
Rooster	4469P	3	4-16	Scroll (Page Borders)	3381		1-9
Rooster Weather Vane	3193	17	3-20	Scrub Brush and Bucket	4649	1	3-10
Rose	4558	1	3-10	"Season's Greetings" Composite		2	4-15
Rotary (Flowchart)	2024		5-5	Section Mark (Notation)	1717		3-1
Round Table w/Chairs (Layout)	1693		5-6	Security Gate	3269	17	3-20
Rowhouse	4010		3-5	Semi-Truck	3511P	15	4-28
Royal Guard (Side of Head)	3671	9	3-15	Septagon	2523		2-2
Rubber Stamp	2917	8	3-12	Sergeant (Angry/Pointing)	4241P	3	4-17
Ruins	3103	8	3-13	Sewage Pipe	2969	8	3-13
Ruler	3102	16	3-18	Shaking Hands	4130P		4-3
Ruler	4024P		4-5	Shamrock	1948		3-8
Running Figure	4446P		4-3	Shamrock	4715P	2	4-11
Rural Scene	4080P		4-7	Sheep (One)	3137	10	3-16
Russian Space Shuttle	4958P	7	4-22	Sheeps Foot Dozer	4885P	15	4-29
w/Gear Down	4926P	7	4-22	Sheeps Foot Dozer Wheel	4886P	15	4-29
Rye	4506P	11	4-25	Sheet Metal, Corrugated	4541	1	3-11
Safe	3058	10	3-17	Sheriff's Badge	2932	8	3-13
Safe (Vault)	4213P		4-5	Ship			
Sailboat	2045		3-6	Cargo	1947		3-6
Sailfish	3957	10	3-16	Destroyer	2014		3-6
Santa Claus	4783P	2	4-14	Front View	3003	9	3-14
Santa Claus and Sleigh	4844P	2	4-15	Helm/Wheel	2980	9	3-14
Satellite	4054		3-6	Ship	4355P		4-4
Satellite Flowchart	2022		5-5	Ship	2948	8	3-13
Satellite Dish Antenna	4433P		4-4	Sinking	2949	8	3-13
Satellites				Shipyard (Horizon)	4455P		4-7
Communications	3779P	7	4-18	Shirt	3095	10	3-17
Communications w/Dishes	4880P	7	4-18	Shoeprint	2931	8	3-13
Cylindrical Body	3786P	7	4-19	Shoes	1031	8	3-12
Generic/Futuristic	4909P	7	4-19	Shopping Cart	2968	9	3-14
IUE	4897P	7	4-19	Shortsword	4359P		4-2
Landstat	4883P	7	4-19	Shovel			
Multimission	4980P	7	4-20	and Pick	2417		3-6
Open	4888P	7	4-19	in Ground	3928	17	3-21
Round Body	3754P	7	4-19	w/Dirt	4557	1	3-11
Scientific	4881P	7	4-20	Shrimp Trawler	3681	17	3-20
Skylab	3587P	7	4-19	Shrubs			4-7
Space Telescope	4884P	7	4-19	Sigma ( $\Sigma$ )	1713		3-2
Telstar	4887P	7	4-19	Sign Borders			3-3
Vela 6	4899P	7	4-19	Signal Light	1926		3-4
Weather	3781P	7	4-18	w/Arrow	1925		3-4
w/Panels	3761P	7	4-19	Signboard	3382		1-9
Saturn	1741		3-6	Signpost			
Saturn	4908P	7	4-20	3 Arrows	4412P		4-8
Saturn	4987P	7	4-21	4 Arrows	4432P		4-8

## Alphabetical Symbol Index, continued

Description	Number	Lib.	Page	Description	Number	Lib.	Page
<b>Signs</b>				Sink	2291		3-8
Many/Confusing	4310P		4-4	Siren, Alarm	3256	9	3-15
on Roadside	4302P		4-8	Six Pack	3081	9	3-15
Airport	4067		3-3	Skeleton Key	4361		4-2
Baggage	4001		3-3	Skier, Inept	4786P	2	4-15
Bar	4064		3-3	Skull and Crossbones	4056P		3-8
Barrier	4060		3-4	Skylab	3587P	7	4-19
Bus Stop	4134		3-3	Skyscraper	4050		3-5
Construction	4083		3-3	Slide, Photographic	3091	16	3-18
Danger!	1996		3-3	Snail	4442P		4-3
Directional	4176		3-4	Snake	3935	16	3-19
Do Not Enter	1930		3-4	Snorkle Lift	3969P	15	4-29
Electrical Danger	1629		3-3	Snow Cloud	3104	9	3-15
Elevator	4062		3-3	Snowflake	1553		1-2
Explosives	4085		3-3	Snowflake	4817P	2	4-10
Falling Rocks	1975		3-3	Snowflake	4818P	2	4-10
Fire Hazard	4075		3-3	Snowman	4774P	2	4-10
First Aid	4066		3-3	Socket, Electrical	2264		3-8
Flammable	4075		3-3	Sofa			
Food Available	2267	8	3-12	2 Cushion (Layout)	1289		5-6
Food Service	4088		3-3	3 Cushion (Layout)	1551		5-6
Handicapped	1597		3-3	Soft Drink			
Highway (Symbolic)	3190	16	3-18	Bottle (16 oz.)	3296	16	3-19
In Ground w/Post	3094	16	3-18	Bottle (2 liter)	3298	16	3-19
Information	4065		3-3	Transfer Tank	3297	16	3-19
Intersection	1957		3-4	Solar System	3782P	7	4-20
Interstate Highway	1997		3-3	Soldier	3069	10	3-16
Keep Right	4092		3-4	Soldier			
Left Turn	4094		3-4	Royal Guard at Attention	3944	17	3-21
Left Turn or Straight	4093		3-4	Cowering	4242P	3	4-17
Median Ahead	1998		3-4	Sombrero	3679	17	3-20
Merging Traffic	4177		3-4	Sort (Flowchart)	1919		5-4
No Bridge	1999		3-3	Sow (Pig)	4328P		4-3
No Left Turn	1909		3-4	Space City	3772P	7	4-22
No Parking	2111		3-4	Space Shuttle			
No Right Turn	1911		3-4	Bay Doors Open	3778P	7	4-18
No Smoking	4055		3-3	In Flight (Front View)	3788P	7	4-18
No Trucks	1910		3-4	In Flight (Front View)	3789P	7	4-18
No U-Turn	1908		3-4	In Flight (Side View)	4882P	7	4-18
One Way	1929		3-4	In Flight (Side View)	4978P	7	4-18
Parking Permitted	2112		3-4	Landing (Side View)	3787P	7	4-18
Pedestrian Crossing	1995		3-4	Landing (Side View)	4876P	7	4-18
Picnic Area	4096		3-3	Landing (Underneath View)	3780P	7	4-18
Pipeline (Symbolic)	3664	16	3-18	Launch Scene	4941P	7	4-18
Prohibited (Generic)	1801		3-3	Re-entering Atmosphere	4852P	7	4-18
Radiation	4074		3-3	Russian	4958P	7	4-22
Railroad	1939		3-4	Russian w/Gear Down	4926P	7	4-22
Railroad Crossing	4136		3-4	w/Launch Rocket (Side View)	4798P	7	4-18
Railroad Tracks (Symbolic)	3189	16	3-18	w/Launch Rocket (Top View)	3765P	7	4-18
Restaurant	4088		3-3	w/Launch Rocket (Top View)	4851P	7	4-18
Riverbank	1999		3-3	Space Station	3750P	7	4-22
Road Curves	1902		3-4	Space Station	3783P	7	4-21
Road Narrows	1994		3-4	Spacecraft, Futuristic			
Road Splits	1730		3-4	Battleship	4927P	7	4-22
Road Turns	1956		3-4	Cruiser 1 (Top View)	3771P	7	4-22
S-Curve	1729		3-4	Cruiser 2 (Side View)	3784P	7	4-22
School Crossing	4135		3-3	Cruiser 2 (Side View)	4923P	7	4-22
Secondary Road	1955		3-4	Cruiser 2 (Top View)	3766P	7	4-22
Slippery When Wet	4175		3-4	Fighter 1	3770P	7	4-22
Stop	1912		3-4	Fighter 1 (Disabled)	4964P	7	4-22
Taxi	4068		3-3	Fighter 2	3785P	7	4-22
Telephone	3392		3-3	Fighter 2	4924P	7	4-22
Three-Way	1907		3-4	Freighter	3753P	7	4-22
Train Stop	4084		3-3	Interceptor	4925P	7	4-22
U.S. Highway	1630		3-3	Interceptor	4957P	7	4-22
Universal Man	3158	17	3-20	Spacecraft, Other			
Wear Goggles	4087		3-3	Lunar Module	3546P	7	4-19
Winding Road	1903		3-4	Lunar Roving Vehicle	4933P	7	4-19
Y-Intersection	1730		3-4	Payload Assist Module	4979P	7	4-20
Yield	1906		3-4	Planetary/Space Probe	4976P	7	4-22
Silo, Grain	3130	16	3-18	Spade (Playing Card)	1934		1-1
Sine/Cosine Curve	3330		2-2	Spark Plug	4354P		4-2

## Alphabetical Symbol Index, continued

Description	Number	Lib.	Page	Description	Number	Lib.	Page
Sparkles			1-2	Sun	1731		3-6
Speaker, 3-Way	3064	16	3-19	Sun	2989	9	3-15
Sphere, Shiny	2967	9	3-14	Sun	3353P		4-7
Spider	3134	16	3-18	Heat Wave	3101	9	3-15
Spilled Liquid	2743		1-10	Mean	4754P	2	4-9
Splashes			1-10	Summer	4478P	2	4-9
Spool of Thread	3053	10	3-17	w/Cloud	2983	9	3-15
Sports (3 Balls)	3089	9	3-15	w/Two Clouds	2984	9	3-15
Sports Car	4388P		4-4	Sunrise	2720		1-2
Spray Bottle	3793	17	3-21	Surveyor's Transit	2418		3-6
Sprayer (Air Brush)	3502	1	3-11	Sweet Potatoes	2863P	11	4-24
Spring (Season)				Swimming Pool Cartoon	4789P	2	4-9
Bird w/Worm	4744P	2	4-9	Switch, High Amp (Open)	4543	1	3-11
Mushroom	4716P	2	4-9	Switches (Electronics)			4 5-12
Nest	4758P	2	4-9	Sword			
Planting Tools	4756P	2	4-9	Broadsword	4346P		4-2
Shower Composite		2	4-9	Cutlass	4340P		4-2
Tree	4825P	2	4-9	Foil	4336P		4-2
Spring				Short	4359P		4-2
Compressed	4566	1	3-10	Syringe	2921	8	3-12
Expanded	4567	1	3-10	T-Square	3036	9	3-14
Spyglass	4377P		4-2	TV	4072		3-9
Square Root ( $\sqrt{\quad}$ )	1711		3-2	Table	2401		3-8
Squash	2872P	11	4-24	Table			
Stag (Deer)	4082		3-7	w/Open Side	3050	16	3-18
Stairs (Perspective)	4429P		4-8	Work	4257	1	3-10
Stamp, Postage	1496		3-8	Tables, Office (Layout)			5-6
Stapler	2429		3-8	Tag (Package)	4114P		4-5
Star				Tank	2910	8	3-13
Cluster	4905P	7	4-20	w/Explosion	2911	8	3-13
in a Circle	2932	8	3-13	Tank Truck	3538P	15	4-28
of Bethlehem	4934P	2	4-9	Tank, Horizontal Storage	3068	10	3-17
Smiling	4752P	2	4-12	Tankcar	2944	8	3-12
Stars			1-11	Tape Dispenser	2428		3-9
Stars (Night Sky)	3360P		4-6	Tape Drives		5	5-22
State Lines (for USA Map)	4395P		4-5	Tape, Magnetic (Flowchart)	1662		5-4
States (USA Map)	4349P		4-5	Tape, Punched (Flowchart)	1657		5-4
Station Wagon	5013P	15	4-28	Tape, Transmittal (Flowchart)	1923		5-4
Station Wagon	5023P	15	4-28	Tax Man (Uncle Sam's Hand)	3115	10	3-17
Statue of Liberty	3086	16	3-18	Taxi	5031P	15	4-28
Steam				Tea Bag	3934	17	3-21
Engine	4098		3-6	Teardrop	2598		1-1
Roller	3524P	15	4-29	Teddy Bear	4235P		4-3
Roller	4583P	15	4-29	Telephone			
Roller	4110P		4-4	Telephone	2275		3-9
Steel Mill Ladle	2407		3-6	Telephone	4444P		4-5
Stereo Receiver	3065	16	3-19	Flowchart	2021		5-5
Sterling, Pound (Sign)	2039		3-1	Handset	3004	9	3-14
Stock Market Ticker	3012	9	3-14	Pole	2933	8	3-13
Stone Tablets	2736		1-13	Poles			4-8
Stool	2287		3-8	Teletypewriter (Flowchart)	2020		5-5
Stopwatch	3953	17	3-21	Telescope	4377P		4-2
Storage				Telescope (Refractor)	3941	17	3-21
Disc (Flowchart)	1914		5-4	Television			
On-Line (Flowchart)	1658		5-4	Television	2940	8	3-12
Stork w/Hat	4470P	3	4-16	Television	4072		3-9
Strawberries	2854P	11	4-24	Antenna	2923	8	3-12
Street Lamp	2920	8	3-13	Screen	3008	16	3-18
Streetlamp	2404		3-5	Tennis Racket and Ball	3677	17	3-20
Stretched Limousine	5027P	15	4-28	Tent	4137		3-5
Stroller, Baby	3936	17	3-21	Tepee	2277		3-5
Strong Man	4204P		4-3	Terminal Interrupt (Flowchart)	1656		5-4
Sub-Compact Car	5001P	15	4-28	Terminals			
Submarine	2013		3-6	(Electronics)		4	5-11
Suburbs (Horizon)	4079P		4-7	CRT	1971		3-9
Sugar Cane	4507P	11	4-25	Display (Flowchart)	2023		5-5
Summer (Season)				Polled (Flowchart)	1675		5-5
Dog	4755P	2	4-9	Remote Batch (Flowchart)	1678		5-5
Sailboats	4846P	2	4-9	Test Equipment (Flowchart)	1655		5-5
Sun	4478P	2	4-9	Test Tube	4020		3-6
Tree Composite		2	4-9	Test Tube	4121P		4-5
Sun				Tetrahedrons			2-8



## Alphabetical Symbol Index, continued

Description	Number	Lib.	Page	Description	Number	Lib.	Page
Text Blocks			1-12	Tornado	3970	9	3-15
Bulletin Board Note	2663		1-13	Tornado	4143P		4-6
Dollar Sign	1057		1-13	Tornado Cloud	2986	9	3-15
Paper (Curled Edge)	1547		1-13	Towels on Rack	3264	17	3-20
Quotation Marks	2116		1-13	Tower			
Stone Tablets	2736		1-13	Crane	4367P		4-4
Thanksgiving				Communications	3127	9	3-14
Harvest Corner	4836P	2	4-13	Toy Wagon	2268	1	3-10
Indian	4807P	2	4-13	Toys	3266	9	3-14
Pilgrim	4808P	2	4-13	Tracking Station/Dish Antenna	4799P	7	4-19
Turkey Corner	4837P	2	4-13	Tracking Station/Dish Antenna	4965P	7	4-20
Theatre and Audience	3108	17	3-20	Tracks, Railroad	4339P		4-8
Thermometer	3032	9	3-14	Tractor	4579P	15	4-29
Thermometer	4494	8	3-13	Tractor	2884P	11	4-25
Thumbs Up	3184	10	3-17	Tractor			
Thunder Cloud	2987	9	3-15	Covered Cab	3675	17	3-21
Ticket	2993	16	3-18	and Bailer	2893P	11	4-25
Ticket, Torn	2992	16	3-18	and Chemical Spreader	2885P	11	4-25
Tight Rope w/Humpty Dumpty	4311P		4-3	and Cultivator	2890P	11	4-25
Time Flies	4244P	3	4-17	and Cutter Bar	2898P	11	4-25
Time Zones (for USA Map)	4126P		4-5	and Disc Harrow	2887P	11	4-25
Tin Can (Open Lid)	4525	1	3-11	and Fertilizer Spreader	2891P	11	4-25
Tire	4275	1	3-11	and Hay Rake	2892P	11	4-25
Tire Tread	3182	10	3-16	and Plow	2886P	11	4-25
Tissue, Bathroom	3289	16	3-19	and Seed Drill	2889P	11	4-25
Tobacco Leaf	4512P	11	4-24	and Spring Tooth Harrow	2888P	11	4-25
Toilet	4294	9	3-14	w/Cab and Large Tires	2896P	11	4-25
Tomato	4551P	11	4-24	w/Driver	4099		3-6
Tools				Tragedy Mask	3171	16	3-18
Air Brush	3502	1	3-11	Trailer, Large	3533P	15	4-28
Anvil	4293	1	3-11	Tramway, Aerial	3292	16	3-19
Auger	4526	8	3-12	Transformer	3260	8	3-13
Ax	2437		3-8	Transistor Radio	2288		3-6
Bench Vise	4539	1	3-10	Transistors (Electronics)		4	5-14
Block and Tackle	4297	8	3-12	Transit	2418		3-6
Buzz Saw	4171		3-6	Transmission Tower	2440		3-5
Calipers	4295	1	3-10	Transmittal Tape (Flowchart)	1923		5-4
Claw Hammer	3156	9	3-15	Transmitter Tower, Radio	2406		3-5
Compass and 45° Triangle	4435	1	3-10	Trapezoids			2-2
Crescent Wrench	4499	1	3-10	Trash Basket (Door/Lid)	2044		3-8
Drill Press	2805	8	3-12	Trash Can	2281		3-8
Flashlight w/Spot	2708P		4-2	Trawler (Shrimper)	3681	17	3-20
Grease Gun	4535	1	3-11	Treble Clef	1750		1-1
Hammer, Sledge	3047	10	3-17	Tree	2270		3-8
Hunting Knife	3195	16	3-19	Tree	3196	16	3-18
Hydraulic Jack	4528	1	3-10	Tree			
Magnet	1578		3-7	Stump	3034	9	3-14
Micrometer	4529	1	3-10	Evergreen	2266		3-8
Monkey Wrench	3667	17	3-20	Trees			4-7
Nail Gun	3666	17	3-20	Trestle Bridge	2403		3-5
Oil Can	4299	8	3-13	Triangle			
Paint Brush and Can	2419		3-8	Equilateral	2501		2-2
Paint Roller	3039	9	3-14	Isosceles	2502		2-2
Pick and Shovel	2417		3-6	Obtuse	2504		2-2
Plane, Wood	2416		3-6	Right	2503		2-2
Pliers, Channel Lock	4322P		4-2	Tripod	4393P		4-5
Propane Torch	4256	1	3-11	Trophy Cup	4027		3-7
Protractor	2664		2-1	Truck			
Ruler, 6 Inch	4024P		4-5	Crane	3955P	15	4-29
Ruler, 12 Inch	3102	16	3-18	18-Wheeler	4108P		4-4
Saw	3049	16	3-18	Truck Wheels and Rear Assembly			
Screwdriver (w/Screw)	3291	9	3-15	Single Axle	3177	16	3-19
Shovel in Ground	3928	17	3-21	Dual Axle	3178	16	3-19
Shovel w/Dirt	4557	1	3-11	Trucks			
Spring Gardening Tools	4756P	2	4-9	3-Axle	4421	1	3-11
Surveyor's Transit	2418		3-6	Cement Truck	3523P	15	4-28
T-Square	3036	9	3-14	Crane Truck	3536P	15	4-29
Tooth	3073	10	3-17	Delivery Van	5041P	15	4-28
Toothpaste Tube	2925	8	3-13	Dump Truck	3508P	15	4-28
Top Hat	4237		3-7	Dump Truck	3509P	15	4-28
Top Hat (Uncle Sam's)	4332P		4-2	Dump Truck (Large)	3510P	15	4-28
Torch	3143	17	3-20	Fire Truck	5044P	15	4-28

## Alphabetical Symbol Index, continued

Description	Number	Lib.	Page	Description	Number	Lib.	Page
Flat-Bed Trailer	3535P	15	4-28	Sweet Potatoes	2863P	11	4-24
Flat-Bed Truck	3521P	15	4-28	Turnip	4509P	11	4-24
Garbage Truck	5043P	15	4-28	Venus	4869P	7	4-20
Grain Truck	3520P	15	4-28	Vial	4020	..	3-6
Moving Truck	3522P	15	4-28	Vial	4121P	..	4-5
Moving Van	3528P	15	4-28	Victrola (Top View)	3939	17	3-21
Oil Tanker Truck	3534P	15	4-28	Video			
Pick-Up Truck	3525P	15	4-28	Camera (Hand-Held)	3013	9	3-15
Pick-Up Truck	5035P	15	4-28	Game	3059	10	3-17
Pick-Up Truck w/Port. Generator	3532P	15	4-29	Screen	1097	..	5-4
Semi-Truck	3511P	15	4-28	Violin	3676	17	3-20
Tank Truck	3538P	15	4-28	Vise, Bench	4539	1	3-10
Trailer, Large	3533P	15	4-28	Volcano	3197	16	3-19
Truck Crane	3955P	15	4-29	Volumetric Flask	4231P	..	4-5
Utilities Truck	3527P	15	4-28	Vote!	4791P	2	4-13
Van	5037P	15	4-28	Wagon	2427	1	3-10
Wrecker	5039P	15	4-28	Wagon Wheel	2050	8	3-12
Trudging through Snow	4772P	2	4-10	Wagon, Toy	2268	1	3-10
Tube, Light	3187	9	3-15	Wait a Moment	4246P	3	4-17
Tumbling Boxes	4360P	..	4-1	Waiting in Line	4474P	3	4-16
Turkey	4778P	2	4-13	Washed Up (Man in Washing Machine)	4477P	3	4-16
Turnip	4509P	11	4-24	Washing Machine	4258	1	3-11
Turntable	4186	8	3-12	Water	2958	17	3-20
Twinkle	4939P	2	4-14	Water			
Twister (Tasmanian Devil)	3970	9	3-15	Can	4568	8	3-13
Two-Door Coupe	5005P	15	4-28	Droplet	2598	..	1-1
Two-Door Coupe	5007P	15	4-28	Droplet	2927	9	3-15
USA Map				Geyser	3279	17	3-20
3-D	4350P	..	4-5	Tower	2409	..	3-5
Outline	4103P	..	4-5	Water/Ocean	3365P	..	4-6
State Lines	4395P	..	4-5	Watermelon	4990P	11	4-24
States	4349P	..	4-5	Waves	2937	17	3-20
Time Zones	4126P	..	4-5	Weather Vane, Rooster	3193	17	3-20
Umbrella	2926	8	3-12	Welding	3284	16	3-19
Umbrella, Beach	4203P	..	4-2	Western Wear	2975	8	3-13
Uncle Sam's Hand (Palm Up)	3960	17	3-21	Whale, Blue	3954	17	3-21
Unicorn	3115	10	3-17	Wheat	4502P	11	4-25
United States Flag (Stylized)	3931	17	3-21	Wheat, Shock of	2957	9	3-14
Uranus Landscape	3507	1	3-10	Wheel and Bracket	3174	16	3-19
Utilities Truck	3762P	7	4-21	Whiskey Barrel	4549	1	3-11
Vacuum Cleaner	3527P	15	4-28	Whorl (Accent)	1932	..	1-2
Valentine	3092	9	3-15	Wind Blowing Trees	3105	9	3-15
Boy	4775P	2	4-11	Wind Rower	2897P	11	4-25
Girl	4776P	2	4-11	Windmill	3799	17	3-21
Hearts and Arrow	4712P	2	4-11	Windmill	4051	..	3-5
Valve (Pipeline)	4497	1	3-11	Wine			
Van	5037P	15	4-28	Bottle	4573	1	3-10
Vault Safe	4213P	..	4-5	Glass	3042	9	3-14
Vegetables				Winter (Season)			
Artichoke	2866P	11	4-24	Cottage	4811P	2	4-10
Asparagus	2861P	11	4-24	Tree	4830P	2	4-10
Avocado	2868P	11	4-24	Wire Spring			
Beans	2879P	11	4-24	Compressed	4566	1	3-10
Beet	2880P	11	4-24	Expanded	4567	1	3-10
Bell Pepper	2878P	11	4-24	Witch w/Moon	..	2	4-12
Carrot	4513P	11	4-24	Witch w/Moon	..	2	4-13
Celery	2856P	11	4-24	Wizard's Hat w/Crystal Ball	4217P	..	4-2
Corn	4501P	11	4-24	Woman	2284	..	3-7
Cucumber	2851P	11	4-24	Woman	2439	..	3-7
Eggplant	2871P	11	4-24	Woman (Face)	4402P	..	4-3
Garlic	2857P	11	4-25	Wood Plane	2416	..	3-6
Green Beans	2860P	11	4-24	Wooden Barrel	4549	1	3-11
Jalapeno	2877P	11	4-25	Word Balloons	..	..	1-14
Lettuce	2858P	11	4-24	Work			
Mushrooms	4584P	11	4-24	Gloves	3276	16	3-19
Onion	2876P	11	4-24	Stations (Layout)	..	..	5-6
Peas in a Pod (One Pod)	4324P	11	4-24	Table (Square)	4257	1	3-10
Peas in a Pod (Three Pods)	4515P	11	4-24	World			
Potato	4522P	11	4-24	w/Grid	4036	..	3-9
Radishes	2862P	11	4-24	w/Meridians	4037	..	3-9
Squash	2872P	11	4-24	Wrecker	5039P	15	4-28
				Wrench			

---

## Alphabetical Symbol Index, continued

---

Description	Number	Lib.	Page
Crescent .....	4499	1	3-10
Monkey .....	3667	17	3-20
X-Axes			
12 Months .....	4192	..	5-2
24 Months .....	4193	..	5-2
53 Weeks .....	4194	..	5-2
X-Mark .....	1765	..	1-1
X-Mark on Grid .....	4223P	..	4-1
Yelling Mouth .....	4245P	3	4-17
Yen Sign .....	2735	..	3-1