

HP DIRECT COMPUTER USERS CATALOG

**HP supplies and accessories...designed expressly for
Hewlett-Packard computers, peripherals & workstations**

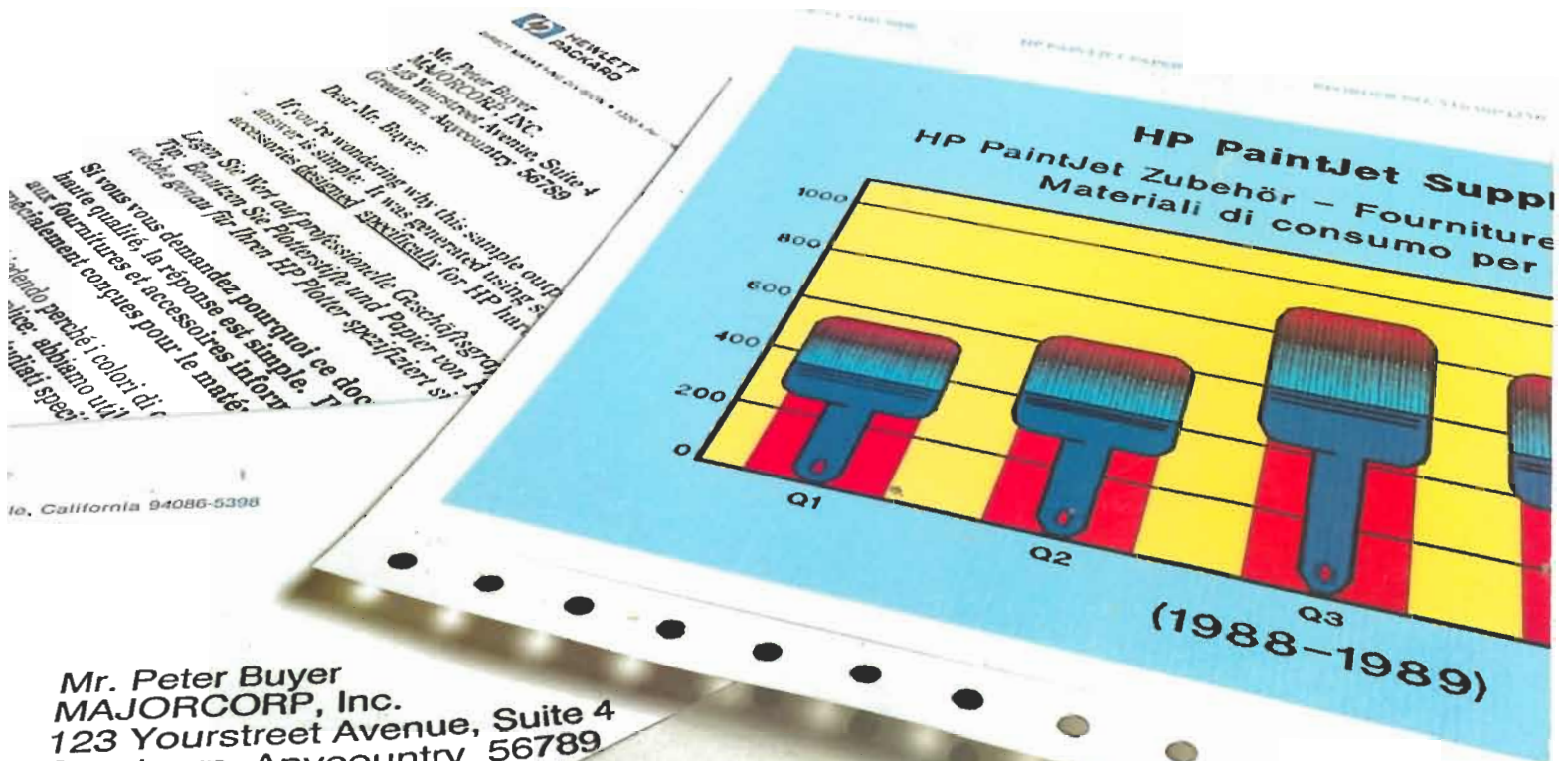

HEWLETT
PACKARD

Mr. Peter Buyer
MAJORCORP, INC.
123 Yourstreet Avenue, Suite 4
Greatown, Anycountry 56789

Dear Mr. Buyer:

If you're wondering why this sample output
appears so simple, it was generated using
accessories designed specifically for HP hardware.

Eigen Sie: Wir auf Professionelle Geschäfte/Agro
Tip: Bewahren Sie Plotterstifte und Papier von A
unabhängig davon für Ihren HP Plotter spezifiziert si

Si vous vous demandez pourquoi ce doc
haute qualité, la réponse est simple. Il
sur fournitures et accessoires inform
confiamment conçues pour le maté

rendo perché i colori di
liche, abbiamo util
spetti speci

California 94086-5398

Mr. Peter Buyer
MAJORCORP, Inc.
123 Yourstreet Avenue, Suite 4
Greatown, Anycountry 56789

HP PaintJet Supplies
HP PaintJet Zubehör - Fourniture
Materiali di consumo per

1000
800
600
400
200
0

Q1 Q2 Q3
(1988-1989)

Plotters

**Your output can look this good
too, when you use genuine HP
supplies! See our complete
selection of media, software,
fonts and accessories inside.**

HP Computer Museum
www.hpmuseum.net

For research and education purposes only.

Call on HP for the best computer hardware —and HP DIRECT for accessories to match!

Expect great service from HP DIRECT, too:



We've banished backorders...

"Some companies couldn't stay in business without backorders, but we pledge to ship your orders the day we get them—and we mean it."

Debra
Debra Deadwyler
Purchasing Manager



...never leave you hanging on hold

"We value your business too much to make you wait. You'll almost always talk to a telemarketer by the second ring."

Dave
Dave Iuppa
Telemarketing Manager



...and clear credit purchases on the spot!

"Our on-line systems can verify your credit card within 5 seconds. If there's a error—like a wrong digit—we can resolve it before you hang up."

Cindy
Cindy Orth
Credit Manager

*To produce the output on our cover, we used Laser-Control, Microsoft® Word and HP Graphics Gallery 3.0 software, plus an HP LaserJet Envelope Feeder, HP PaintJet Color Print Cartridges, Z-Fold Paper, Transparency Plotter Film and Fiber-tip Transparency Pens.

**Call 800-538-8787 today.
And remember:
we ship the day you order!**

Looking for supplies and accessories good enough for HP hardware? Look to HP DIRECT.

Our products are designed specifically for HP computers and peripherals. They range from the media, software, fonts and accessories used to produce the output on our cover,* to computer terminals and workstation furniture.

All products are covered by HP's well-known warranty, plus our 50-year reputation for excellence. And our products are in-stock 99.7% of the time—a claim few others can make!

Sincerely,

Craig A. Clark

Craig Clark
HP DIRECT
Worldwide Distribution
Manager



Contents

Summer 1989



2

New Products

Optical disks, LaserJet fonts, printer furniture, calculators, software and other exciting new products!



9

Printers

Toner, print cartridges, paper and more for your HP printer from LaserJets to Impact printers.



47

Plotters

Pens, media and accessories for HP business and drafting plotters.



65

LANs & Cables

Everything to connect your HP computers, peripherals and networks to almost any computer system.

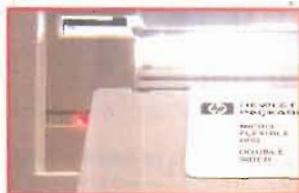

84

Discs & Tapes

Floppy discs, data cartridges, mag tapes, rigid discs, and storage accessories to keep data secure.



100

Furniture

Tables, cabinets, chairs and accessories to complement your HP computers and peripherals.



127

Calculators & PC Supplies

Calculators, hardware accessories, books and manuals to help you in your work.



146

Terminals

HP 700 Series Terminals to expand your DEC, IBM, ASCII or HP computer system.



152

Data Communications & Power Conditioners

Cable testers, modems, and power protection to complete your HP computer system.





161

Blue Section

Ordering information and three handy indexes to help you find and purchase the products you want.

Many of our products are available at your Authorized HP dealer.

These products are identified throughout this catalog with the dealer symbol, . It's our way of letting you know that a product can be purchased from either an authorized dealer or HP DIRECT. If every product on a page is carried by our dealers, the  will appear at the top of that page. For the name and location of your closest HP dealer, call 1-800-752-0900.



Enter the age of optical storage with the disk that goes beyond drive compatibility to optimal drive performance.

Getting the most reliability, performance and longevity from your HP Optical Drive investment is easy when you choose the disk developed with your drive in mind.

By using HP Rewritable Optical Disks, you're assured of disk-to-drive compatibility—the key to secure protection of your valuable data.

What's more, these are the only optical disks tested with the HP Optical Drive, under worst-case conditions, to meet ANSI and ISO standards. And they're guaranteed to be 100 percent error-free for a full year.

By choosing HP, you take advantage of the expertise we developed



For HP Optical Drives



A single HP Rewritable Optical Disk offers as much storage as 16 1600 BPI mag tapes—plus greater reliability and easier access

as the provider of a total optical storage solution. That's because focusing on a total solution allowed us to develop disks that don't just match your drive, but actually optimize drive reliability and performance.

Combining easy access with large capacity is no longer a hard (disk) choice Each 5.25-in., double-sided HP Rewritable Optical Disk gives you 650 megabytes of removable capacity, for a fraction of what hard disk storage costs.

Stretching your storage dollar no longer means relegating information to magnetic tape because it's too expensive to store on hard disk. That means no more frustrating waits for data buried off-line on paper and mag tape.

92280A HP Optical Rewritable Disks (1024Kbyte per sector)

(1 disk)	\$249.00 ea.
(2-4)	231.00 ea.
(5-10)	224.00 ea.
(11+)	219.00 ea.

Available after June 1, 1989

1988/89 Comparative Storage Costs
1 Drive + Required Media

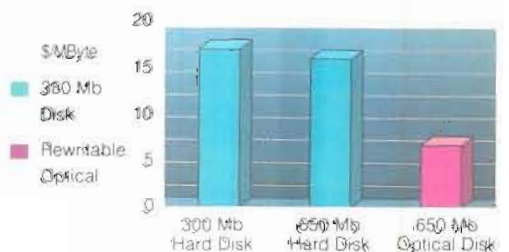

Rewritable optical storage costs as little as 1/30th the price of hard disk storage.

Give word processing, spreadsheet and DTP applications a fresh new (type)face!



See pages 13 and 17 for new HP LaserJet Printer fonts.

Print up to 50 envelopes on your HP LaserJet IID Printer, electronically

Now you can print as many as 50 two-page letters—letterhead and a second page—plus matching envelopes, right on your LaserJet IID Printer...quickly, easily and electronically.

That means no more switching from printer to typewriter to print envelopes.

And no more entering mailing data twice, because this electronic feeder works with the mail-merge function of most popular word processing applications. You no longer have to waste time collating your pages and envelopes—the printer and software do it for you!

This Envelope Feeder adds a third tray to your printer, so you won't

have to waste time swapping paper trays or manually feeding envelopes.

It plugs right into your printer, so set-up is easy, and works with most major word processing programs with envelope feeder drivers.

And it's perfect for handling business and letter-size envelopes, as small as 86 x 178mm (3.4 x 7 in.) and as large as 188 x 267mm (7.4 x 10.5 in.)

33457A Envelope Feeder for the HP LaserJet Series IID Printer \$350.00 ea.



Don't waste time swapping trays! Print envelopes and two-page letters in an instant.

Our big organizer for small spaces puts your HP LaserJet Printer—and supplies!—on any table



Need a place for your LaserJet Printer and supplies, but short of space for a free-standing cabinet or printer stand?

No problem! Our compact LaserJet Organizer positions your printer and supplies on a table or desktop.

It's custom-designed for your LaserJet's footprint, so our Organizer doesn't waste one inch of precious space. And it's designed to accommodate the supplies you need most often.

Consolidate your supplies Our Organizer has three slots underneath for legal and regular-size paper trays. It also has a drawer with foam compartments to hold up to



Slots store extra paper trays handily, while foam compartments hold up to four cartridge fonts and six softfonts in place.

four font cartridges and a half-dozen softfonts in place.

Completely compatible The LaserJet Organizer's quality construction, gray matte laminate finish, circular handle and contemporary design blend handsomely with *Design Plus* tables and cabinets.

Tough rubber molding on its edges protect your equipment by absorbing bumps and knocks. And the molding on the bottom minimizes skidding by creating additional friction.

The LaserJet Printer Organizer comes assembled and ready to use. It measures 228.6 H x 457.2 W x 457.2 D mm (19 H x 18 W x 18 D in.).

92166J HP LaserJet Printer Organizer
 (1-2) \$149.00 ea.
 (3-9) 141.00 ea.
 (10+) 134.00 ea.

Who says a printer cabinet has to cost more to be better? Not the designers of *our* printer cabinet!

Thanks to your input, we've revamped our HP LaserJet Printer Cabinet.

We kept the quality—it's still sturdy as ever and perfectly compatible with your *Design Plus* furniture. It accommodates months of daily printing supplies. And it still has heavy-duty, lockable casters.

But our Cabinet now comes fully assembled, so you can use it the moment it arrives. And it's priced substantially less—less, in fact, than any other high-quality printer cabinet on the market today.

We even added a slot under the Cabinet top for easy attachment to other *Design Plus* components with our Bracket Kit (see page 104).

Shouldn't you add our LaserJet Printer Cabinet to your workplace?



Our redesigned LaserJet Printer Cabinet is ready to use, right out of the box!

92211D HP LaserJet Printer Cabinet	
(1-2)	\$385.00 ea.
(3-9)	385.00 ea.
(10+)	345.00 ea.

The Printer Cabinet now attaches firmly to *Design Plus* tables, and provides ample space for manuals, paper trays, toner cartridges, months' of paper, and fonts (see page 21 for Font Organizer).

Interested in our top-quality *Design Plus* furniture? Flip ahead to pages 101 to 106.

Want economical storage for your HP LaserJet Printer and supplies? You need our MicroManager Printer Station

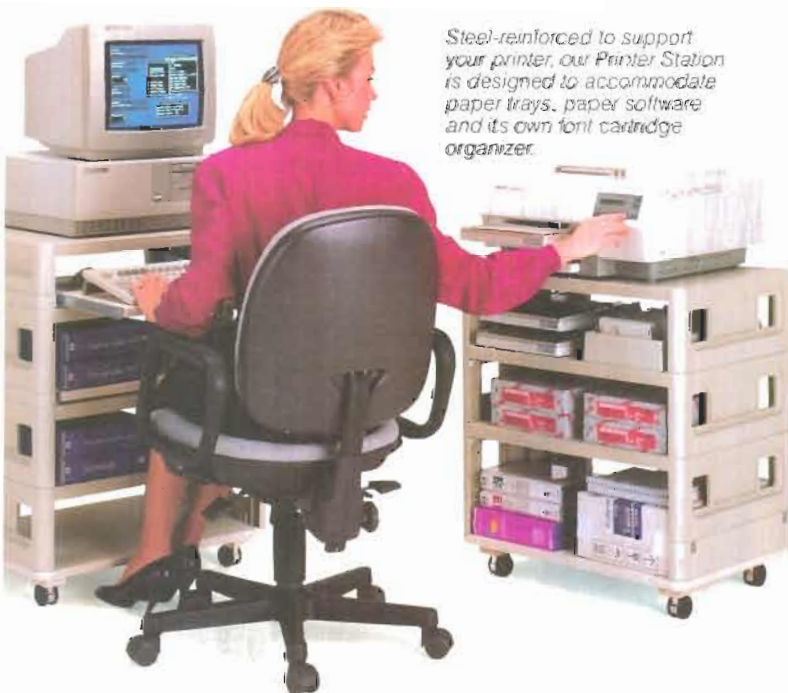

Steel-reinforced to support your printer, our Printer Station is designed to accommodate paper trays, paper software and its own font cartridge organizer.

Don't let a tight budget cramp your style! Here's affordable storage for your HP LaserJet Printer and supplies.

Our Printer Station is easy to assemble, mobile and versatile. It's also cream-gray, high-impact styrene to match your MicroManager® system.

Assembly's easy—all you need is a screwdriver. Its snap-together stacking-module design allows assembly in less than 10 minutes. And MicroManager's pop-out slots and channels route cables out of harm's way, creating a safe set-up with a clean look.

Sturdy like never before The Printer Station's platform top is steel-reinforced to support up to 80 pounds—more than adequate for your LaserJet! The two lower shelves each hold up to 60 pounds. And the sturdy wood base supports up to 80 pounds—more than enough for your manuals, fonts, toner cartridges, paper and paper trays.

Customize it MicroManager's versatility lets you customize the Station to fit your needs. For instance, you can add the optional Paper Catcher Basket (see page 114) to collect output.

What's more, our Printer Station comes with a removable font organizer that holds seven fonts, and casters that lock in place for stability as well.

92299H HP LaserJet Printer Station	
(1-2)	\$219.00 ea.
(3-5)	209.00 ea.
(6-9)	195.00 ea.
(10+)	180.00 ea.

See pages 114 and 115 for more about MicroManager.

Professional graphics and charts are simple to create with Graphics Gallery!

The Graphics Gallery collection teamed up with your HP LaserJet Printer is a match made in heaven. Instantly, you can create dynamic drawings and data driven charts for powerful business graphics that get noticed!

No task is too big for Graphics Gallery—whether it's creating graphics to supplement a desktop publishing program or integrating with text, Graphics Gallery can do it all and do it fast.

Zoom, rotate, skew or align your text and line drawings—whatever it takes to get your message across, Graphics Gallery has the features to make it happen in black and white or gray scale. And 384Kbyte memory means you can create full-page graphics with no interruption.

Graphics Gallery lets you directly read in Lotus WKS or WK1 files using just one soft-key selection. You can also import ASCII text and export TIF and PCX formats. Graphics Gallery also supports the industry standard CGM (Computer Graphics Meta file) format for importing and exporting to other graphics programs. Graphics Gallery runs on HP Vectra PC and other IBM PC compatibles. ☐



- D1711A #ABA** Graphics Gallery Collection 3.0 (Includes Drawing Gallery, Graphics Gallery and Business Management Portfolio) \$499.00 ea.
- D1709A #ABA** Drawing Gallery \$349.00 ea.
- D1710A #ABA** Charting Gallery \$249.00 ea.
- 68326F** Business Management Portfolio \$95.00 ea.
- 68324F** Office Management Portfolio \$95.00 ea.
- 68325F** Chemical/Petrochemical Portfolio \$150.00 ea.
- 68327F** HP Draw Portfolio \$195.00 ea.

Free Graphics Gallery demo disc available! Call 800-752-0900 and ask for Reference Dept. 428K.



Take full control of your HP LaserJet or DeskJet Printer!

How? With LaserControl Software. Read all about it on pages 19 and 31.

Free the colors inside your Apple Macintosh with the HP PaintJet Printer Interface Kit

Join the Mac you love for creating presentation graphics, to the printer that delivers top-of-the-line color output—affordably!

Our PaintJet Printer Interface Kit makes it easy. There's nothing new to learn. Just use your favorite software applications, like MacDraw II, Cricket Draw and Cricket Presents, to generate graphics.

Then, instead of settling for ordinary black-and-white hardcopy, produce dazzling color output—on paper or transparencies—with your PaintJet Printer.

It's simple and economical with the PaintJet Printer Interface Kit.

You'll feel at home with PaintJet color printing from day one, because you work within the familiar Macintosh environment. The only change is the impact of your presentations.

After all, why create in color if you can't print in color? Especially when color presentations are so

much easier to understand, attention-getting and memorable.

The kit includes a driver, fonts, cable and users' guide. It works with the HP PaintJet Opt. 001 and Macintosh Plus, SE and II computers. ☐

17305A HP PaintJet Printer Interface Kit for Macintosh® Computers .. \$125.00 ea.

Print brilliant color output from your Mac on the affordable HP PaintJet Printer.

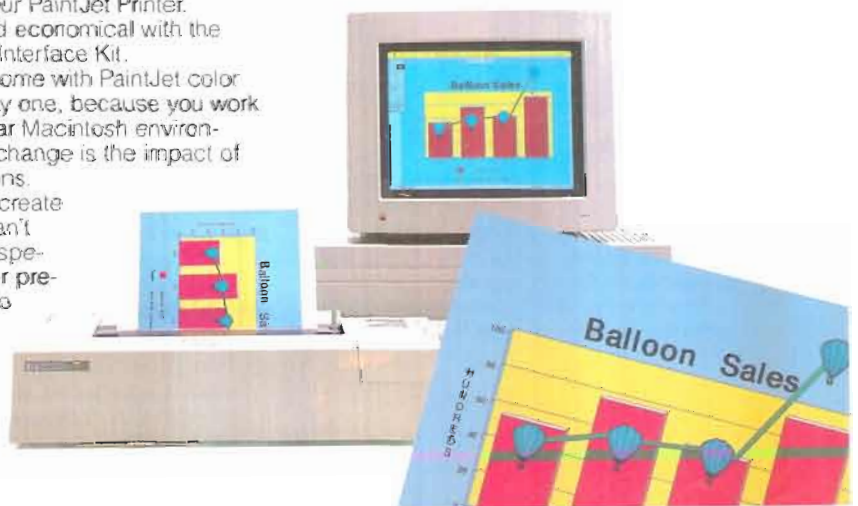

Transmit data to HP StarLAN 10 workstations with compact, convenient twisted-pair MAU

Reply on the StarLAN 10 MAU (medium attachment unit) for a fast, efficient way to share data and peripherals.

This MAU connects computers with AUI (attachment unit interface) ports to HP StarLAN 10 networks. A reliable alternative to coax-based PC LANs, StarLAN 10 is a 10 Mbps network hardware system that utilizes convenient, cost-effective unshielded twisted-pair wiring.

The StarLAN 10 MAU lets you build large networks, without using thin or thick backbones, by simply cascading StarLAN 10 hubs: Connect a StarLAN 10 MAU to one of the ports on a hub, then connect the AUI cable to the AUI port of another hub to gain 12 more ports.

StarLAN 10 allows for hassle-free adjustments when you add, move or make

changes to your network. A 12-port modular adapter simplifies connections to the StarLAN 10 hub, while an 8-pin telephone-style jack plugs into the hub on one end and directly into the PC interface card on the other.

Perhaps best of all, the network remains intact while you make adjustments—its star configuration allows for connections or disconnections *without* incurring downtime.

28664A Twisted pair MAU with integrated 1-meter AUI cable \$295.00 ea.

StarLAN 10's twisted pair MAU sends and receives data, detects collision on the network and monitors malfunctions on the hub-MAU link.



See pages 66-71 for additional information on LANs.

Learn HP Vectra PC skills with our affordable tutorial software —at your own pace!

You've just acquired a Vectra PC. You're anxious to use it. But you can't afford time away from the office to take a class. What do you need? HP Vectra PC Family Fundamentals!

This computer-based tutorial helps you get to know your Vectra step by step—without leaving your workplace—by giving you a comprehensive introduction to the basics of personal computing and MS-DOS.™

What's more, our Tutorial lets you learn at your own pace. Complete all six sections within six hours. Develop "spot" expertise by concentrating on one section at a time. Stop in the middle of a section—a unique "bookmark" feature notes where you leave off.



Our computer-based tutorial builds your HP Vectra PC skills, and your use of MS-DOS.

The Tutorial provides simulated everyday Vectra tasks for hands-on experience, then lets you gauge your progress with self-tests and reviews.

With a solid understanding of the basics, you're bound to develop additional PC skills more easily. And perhaps best of all, you'll pay substantially less for our Tutorial than for a class!

The Tutorial runs on all HP Vectra PCs except the Portable CS. Four 5.25-inch discs and a Student Reference Guide are included.

51410B HP Vectra PC Family Fundamentals: A Computer-Based Tutorial \$125.00 ea.

Simplify HP FORTRAN 77 training with our economical video course



Sit back. Relax. Get comfortable. Slip the HP FORTRAN 77 tape into a video cassette recorder and prepare to learn—at a convenient time, at your own speed, and in your own office or home!!

This money-saving introductory course includes lessons on FORTRAN 77 syntax,

as well as structured programming concepts and how they apply to HP 3000, HP 9000 and HP 1000 Computers.

Lab exercises give you hands-on experience in using FORTRAN 77 to develop and execute programs.

Available in VHS or Beta format, our course includes a video tape plus an information-packed manual and workbook.

30697A HP FORTRAN 77 Self-Paced Course Options (select one):

Opt. 001 VHS: \$500.00 ea.
Opt. 002 Beta 500.00 ea.

When classes are impractical, learn HP FORTRAN 77 through our self-paced video course.



Anything you can solve with a calculator, you can solve better with our new business and technical calculators.

See what we mean on pages 128 and 129.

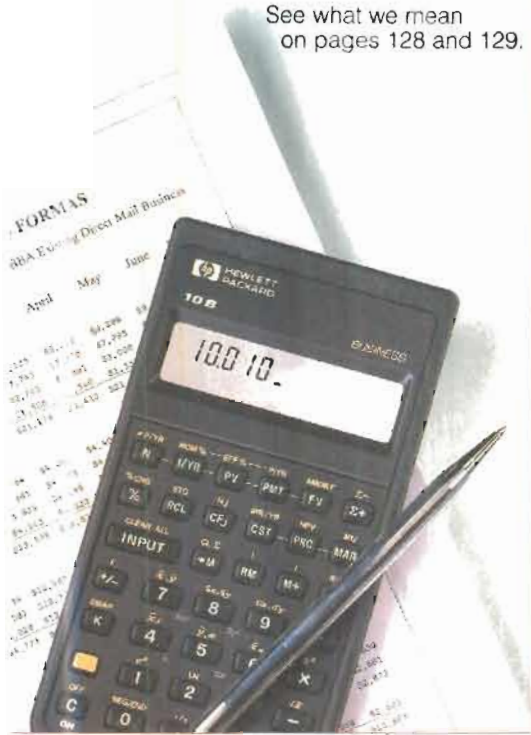

Get the big picture with your HP Vectra LS/12 PC—without losing desktop space!

Now you can enjoy full use of your desktop space while using your Vectra LS/12 and a standard-size monitor!

Just slide your Vectra under our acrylic monitor stand. You not only save space—you'll save yourself eye, neck and back strain as well.

This stand raises your monitor to a comfortable viewing height, so there's no need to crane or hunch. And your Vectra's built-in display slides *under* the stand, instead of coming between you and your monitor.

Our stand even has side cutouts for easy access to your Vectra's disc drive and on/off switch. When you finished working on your Vectra, slide it all the way under our stand for use of your desktop.



92166K HP Vectra LS/12 PC Monitor Stand

(1-2 units)	\$59.00 ea.
(3-9)	56.00 ea.
(10+)	53.00 ea.



Access your disc drive and power switch quickly and easily through the stand's side cutout.

Carry your HP Vectra LS/12 PC and all supplies in one case

No more juggling multiple cases on important sales and service calls!

Our custom-designed case lets you transport your PC (with or without the battery attached), files folders and other supplies in a single, convenient carry-all. There's even room for the adapter/re-charger and discs. Yet it's so compact, you can slip it under your airline seat.

You also get serious protection, because our case is constructed of durable, water-resistant nylon Cordura with nylon webbing, with sturdy metal zippers and Velcro closures, and closed-foam padding to insulate your PC from bumps and bruises.

35178F HP Vectra LS/12 PC Carrying Case \$99.00 ea.



Pack your Vectra in the main section, with or without battery. Fitted pockets hold discs.



Insert the padded divider to keep PC and adapter/recharger snugly separate.



Tuck file folders into the expandable outside pocket; a zippered case holds pens and more.



The leather handstrap and padded, adjustable shoulder strap allow comfortable carrying.

Protect your plotter investment! Our dust covers ensure dust and other dangers won't damage your plotter

For just a fraction of your plotter investment, our 100 percent cotton dust covers provide immediate plotter protection.

The treated cotton repels moisture and liquids. At the same time, it "breathes" to prevent condensation from forming inside your plotter's vital workings.

The covers' neutral tan color coordinates well with any office environment, and their custom fit adds to their sleek, attractive appearance. But our dust covers don't just look good. They work hard—even in busy industrial environments.

Cover your plotters against dust, grime and spills—it's the best insurance value for the money!

92259Q HP DraftPro & DraftPro DX Dust Covers \$50.00 ea.
92259P HP DraftMaster I & II Dust Covers 55.00 ea.
92259R HP DraftPro EXL Dust Covers 55.00 ea.

Our 100% cotton covers "breathe" so they don't trap heat or moisture, which can damage your plotter.



Is the network down while you write programs to test it? Reach for our Protocol Analyzer's ready-to-test library

You're ready for troubleshooting the moment you unpack your HP 4951C Protocol Analyzer.

The key is a 3.5-inch disc of 58 pre-written monitor and simulate programs for diagnosing common datacomm problems. No more writing test programs before testing!

Our programs can be customized to meet special conditions, so you won't have to write test programs from scratch.

And because this disc includes installation and acceptance tests for printers and terminals, you handle these tasks quicker than ever.

Designed for flexibility The ability to simultaneously display multiple formats lets you see both the data and lead status, so interface handshaking problems can be quickly isolated.

Optional installation and maintenance software is available for IBM 3270 and

compatible terminals. There's also an optional statistics package for link-level (level 2) performance analysis of SNA and X.25 networks (SDLC and HDLC).

You have options for reviewing test data, too. View results on-screen, or use the Analyzer's RS-232/V.24 port for connection to an ASCII printer for hard copies. You can even use the RS-170 video port for attachment to a more convenient big screen monitor.

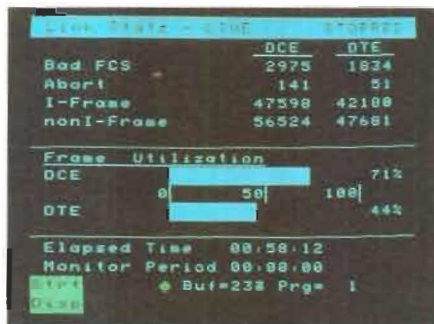

Convenient, too All programs are stored on 3.5-inch discs, which you insert into the analyzer's built-in disc drive. The same disc format is used for data storage, so it can be easily transported to the office or another analyzer.

Other conveniences include built-in Bit Error Rate Testing and an Auto Configure function.

And it all comes in a portable 7kg (15 lb) package that operates to 19.2kbps.

Up and running in no time Order the 4951C Protocol Analyzer from HP DIRECT and get our special tutorial package! The disc and manual take you step by step through each of the features making it easy to get the full benefit of the instrument's many capabilities. Actual sample data lets you see the effect of running various tests.

4951C 19.2kbps Protocol Analyzer \$3,940.00 ea.

Required (select one):

18180A Interface Pod (RS-232/V.24 and RS449/422A/423A) \$900.00 ea.

18179A RS-232/V.24 Interface Pod with full break-out box 650.00 ea.

Optional:

18332D 3270 Software \$350.00 ea.

18333D X.25 and SNA Link Level Statistics 350.00 ea.

18331D X.25, DDCMP, SNA Decodes 350.00 ea.

NOTE: If you need testing for 64K bps, order the HP 4952A Protocol Analyzer.



This 19.2kbps instrument features programs developed with inputs from actual protocol analyzer users. Above is a sample screen from the link-level statistics package.

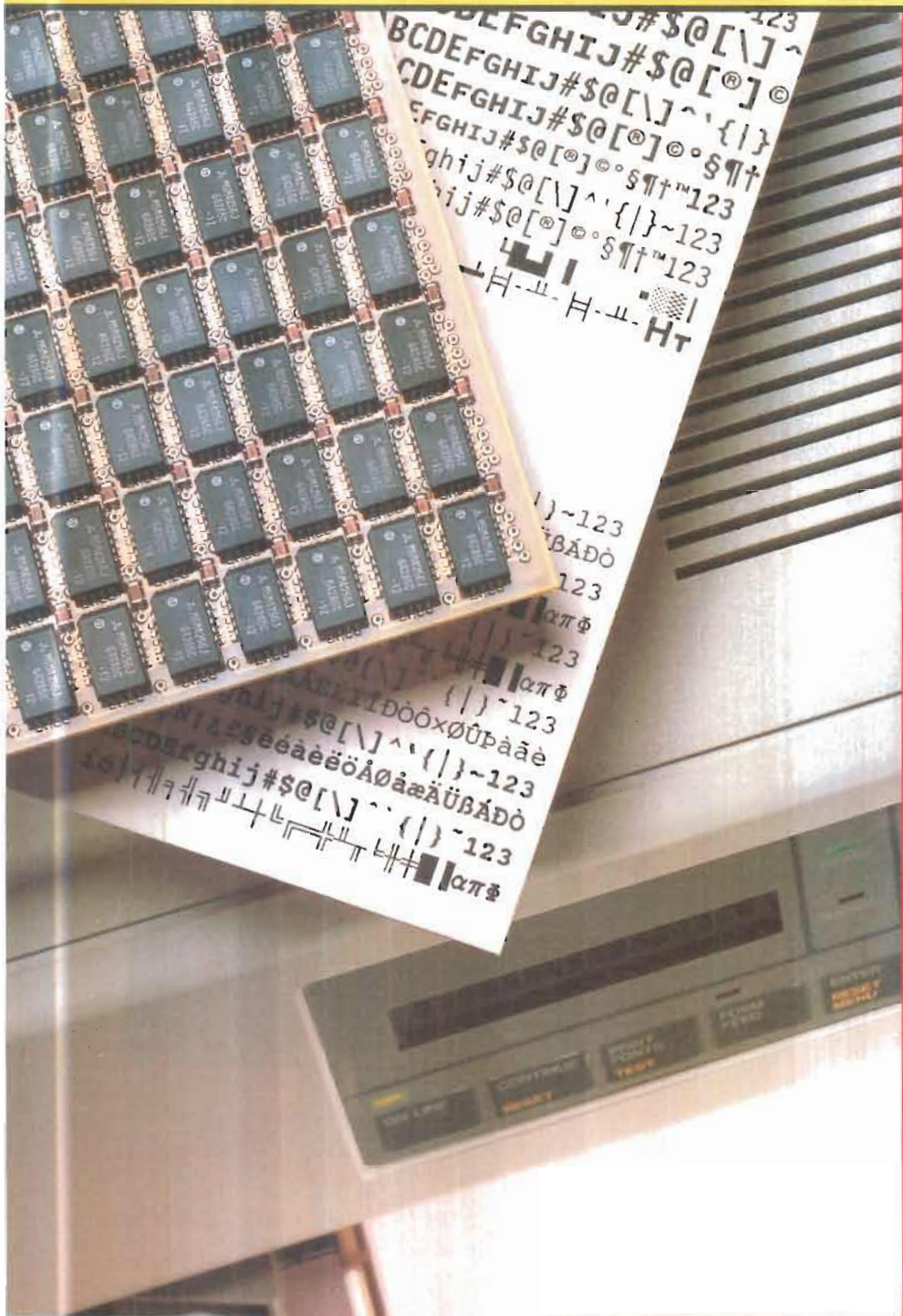

HP LaserJet...the world's best-selling printer is now more popular than ever with its wide range of available cartridge and soft fonts, utility software, expandable memory and even custom-designed printer cabinets.

LaserJet supplies & accessories	3-5, 10-23
Laser printer vacuum	23
LaserJet Cabinet	23
Laser page printer supplies	24
Peripheral-sharing devices	25-27
HP PaintJet supplies	28-30
HP DeskJet supplies	30-33
HP ThinkJet/QuietJet Series Printers	34
HP ThinkJet/QuietJet Series supplies	35-38
HP RuggedWriter supplies ...	39
HP 2603A Daisywheel Printer & supplies	40
Impact printer supplies & accessories	41-45
Thermal printer paper	46

***Each time you replace your HP LaserJet
you become a team***



Printer's toner cartridge, of engineers and a service technician



There's more to a toner cartridge than toner

Ever wonder why the toner for your HP LaserJet Printer comes packaged in a cartridge? Or why you have to replace the entire cartridge once the print begins to fade?

You may think we'd be smarter to just sell you the toner. But we think not.

You see, your HP LaserJet Printer is built around a sensitive, state-of-the-art imaging system. We've estimated that every several thousand pages, parts in that system could wear out.

The organic photoreceptive drum could become scratched. The corona wire could become contaminated, lessening print quality. The cleaning blade could wear and stop cleaning effectively. Excess toner might even spill into the cleaner assembly and clog your printer.

HP toner cartridges provide a fresh imaging system for your HP LaserJet Printer:

The cleaner blade prepares the drum for fresh toner, so images print sharply.

The toner reservoir holds the correct amount of toner, so images print cleanly.

The photoreceptor attracts toner with controlled static, so images print evenly.

The corona wire charges the drum to prepare it for image formation, so images print without missing parts.



A new toner cartridge is worth a team of engineers...

Thanks to the ingenious design of HP's LaserJet printer, you replace worn imaging parts yourself—every time you install a new toner cartridge from HP.

Remember the service technician who always had the office copier in pieces? He was performing regular maintenance—cleaning, adjusting and replacing delicate parts.

Your LaserJet requires similar maintenance. But because of its modular design, it doesn't need the expensive technician. All it needs is you...and the brand new, perfectly tuned parts built into every HP Toner Cartridge.



...or a visit from your repairperson!

In the minutes it takes you to install a new HP Toner Cartridge, you've done much more than replace the toner.

You've enabled your LaserJet to produce the sharpest, cleanest, problem-free printing possible.

You've given yourself the peace of mind of a 90-day money-back cartridge guarantee.

You've refreshed your printer's imaging system with a single, easily installed cartridge.

And you've taken the place of your printer service technician.

Next time your LaserJet's print begins to fade, put on your LaserJet engineer/technician hat—and put in an HP LaserJet Toner Cartridge.

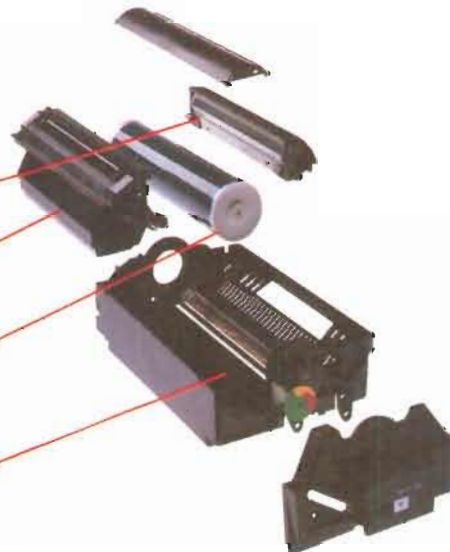

92295A Toner Cartridge for the HP LaserJet Series II and IID, black print

(1 unit)	\$127.00 ea.
(2-3)	115.00 ea.
(4-15)	110.00 ea.
(16-63)	99.00 ea.
(64+)	89.00 ea.

92285A Toner Cartridge for HP LaserJet, LaserJet PLUS and LaserJet 500 PLUS Printers, black print

(1 unit)	\$128.00 ea.
(2-3)	115.00 ea.
(4-15)	110.00 ea.
(16-35)	103.00 ea.
(36+)	95.00 ea.

922856 Toner Cartridge for HP LaserJet, LaserJet PLUS and LaserJet 500 PLUS Printers, brown print

(1 unit)	\$149.00 ea.
(2-7)	142.00 ea.
(8-35)	135.00 ea.

Get your documents noticed! User fonts and typefaces from HP's LaserJet Printer Type Library

You've spent hours researching, writing and compiling information for that all important report. Don't compromise on the presentation of your hard work! Give your documents the flair and style they deserve by using HP type products.

Our comprehensive family of professional-looking fonts and typefaces welcomes two new additions: the ProCollection font cartridge and Premier Collection typefaces.

ProCollection is the ideal offering for office workers with 65 fonts to meet all the typical business day needs. The Premier Collection typeface products are a dream come true for desktop publishing fans.

Both typefaces make your LaserJet Printer tremendously flexible by providing almost any size font up to 200 points.



Headline the news with HP's new typefaces.

Detailed information is more readable than ever with ProCollection fonts.

1. Peanut

A tasty, unique assortment from plantations in Africa and Southeast Asia. And, yes, from Georgia (too).

2. Hazelnut

Cakes, cookies, ice cream, chocolate, salads. They'll never taste better than with this delicious French variety.

3. Brazil Nut

4. Pecan

Another great favorite in the bakery. And our own superb pecans will satisfy even the most discriminating taster.

ASSET NATIONAL BANK
CREDIT APPLICATION FOR

ASSET NATIONAL BANK
10101 State Drive, Suite 515
Seattle, WA 98178

OFFICER EMPLOYMENT

NAME	POSITION	DATE	STATUS
George Samuel, President	President	June 1, 1988	Full-time
Robertson Lyons North & Partners	Partner	1988	Part-time

PARTNER EMPLOYMENT

NAME	POSITION	DATE	STATUS
Mr. Les Wingate Jr.	Partner	1988	Part-time

OTHER INCOME

SOURCE	AMOUNT
TOTAL OTHER INCOME	\$10,000
TOTAL MONTHLY INCOME	\$9,200

Crisp correspondence from ProCollection fonts gets your point across.

Know the difference between a font and a typeface.

Font: a complete set of letters, numbers and symbols of a specific typeface design, which are the same size, treatment, pitch and orientation.

Typeface design: the particular design or style of the characters and symbols, such as *TmsRmn* or *Courier*.

Treatment: the emphasis placed on a typeface design, such as bold, italic or bold italic.

Point size: the height of the characters.



Pitch: the number of characters printed per horizontal inch.



Fixed Pitch
(Same spacing for all characters)



Proportional Pitch
(Spacing varies with each character)

Fixed-pitch fonts are the most effective fonts for aligning columns of data. Proportionally spaced fonts print text that's easy to read and pleasing to the eye.

Orientation: the direction of the print on the page. Portrait fonts print across the width of the page, while landscape fonts print across the length of the page.



PORTRAIT



LANDSCAPE

Symbol set: the specific alphabetic, numeric, punctuation and special symbols contained in a font.

Compatibility: a font's ability to work with the built-in features of a software application. Check your software manual.

Typeface Products: Each HP typeface product consists of a master typeface design. Use our versatile Type Director software to create fonts from 4 to 200 points size. To learn more about HP typefaces, see page 17.

ProCollection—the ideal font cartridge for word processing and spreadsheet software users.



Sixty-five fonts packed into one cartridge makes ProCollection the obvious choice for anyone who prints from word processing and spreadsheet software packages.

Your HP LaserJet Printer conveniently finds all HP "typewriter" fonts inside this cartridge, along with the highly readable proportional fonts, TmsRmn and Helv. Fonts in landscape (sideways) orientation let you print spreadsheet or tables of data across length of a page. The compact 4.6- and 6-point Letter Gothic fonts help you present large quantities of information without sacrificing readability.

ASCII symbols included in each font contain most of the characters and symbols needed for printing in American English. The Legal symbol set adds trademark, copyright and other useful symbols.

And perhaps best of all, The ProCollection font cartridge works with all HP LaserJet Printers.

92286PC ProCollection \$300.00 ea.

ASCII symbol set

Portrait & Landscape	Pitch	Point
Letter Gothic med.	27,27, 18, 16,66, 12	3,6, 6, 9,5, 12
Letter Gothic bold	12	12
Letter Gothic italic	12	12
Courier medium	12	10
Courier bold	12, 10	12, 10
Courier italic	12, 10	12, 10
Prestige Elite med.	16,66, 12	7, 10
Prestige Elite bold	12	10
Prestige Elite italic	12	10
Line Printer	16,66	8,5

ASCII symbol set

Portrait	Pitch	Point
TmsRmn medium	prop.	8, 10, 12
TmsRmn bold	prop.	10, 12
TmsRmn italic	prop.	10, 12
Helv bold	prop.	14

Legal symbol set

Portrait	Pitch	Point
Courier medium	12, 10	10, 12
Courier bold	12, 10	10, 12
Courier italic	12, 10	10, 12
Prestige Elite med.	16,66, 12	7, 10
Prestige Elite bold	12	10
Prestige Elite italic	12	10

ASCII and Legal symbol sets

Portrait	Pitch	Point
Helv medium	prop.	8, 10, 12
Helv bold	prop.	10, 12
Helv italic	prop.	10, 12

Typewriter Font Cartridges

Courier



Courier Document 1
92290S1
\$250.00 ea.

Roman-8, PC-8, PC-8 D/N and ECMA-94 Latin 1 symbol sets

Portrait & Landscape	Pitch	Point
Courier medium	12	10
Courier bold	12	10
Courier italic	12	10
Courier italic	10	12

Note: This cartridge is not compatible with the LaserJet, LaserJet PLUS or LaserJet 500 PLUS printers.



Courier 1
92286A
\$150.00 ea.

Roman-8 symbol set

Portrait	Pitch	Point
Courier bold	10	12
Courier italic	10	12

Landscape	Pitch	Point
Line Printer	16,66	8,5



PC Courier 1
92286Y
\$250.00 ea.

PC Set 1 and PC Ext. symbol sets

Portrait	Pitch	Point
Courier medium	10	12
Courier bold	10	12
Courier italic	10	12

Portrait & Landscape	Pitch	Point
Line Printer	16,66	8,5



Memo 1
92286Q
\$250.00 ea.

Roman-8 symbol set

Portrait & Landscape	Pitch	Point
Courier bold	10	12
Courier italic	10	12

Portrait	Pitch	Point
Letter Gothic medium	12	12
Letter Gothic bold	12	12



Courier P&L
92286L
\$250.00 ea.

Roman-8 symbol set

Portrait & Landscape	Pitch	Point
Courier bold	10	12
Courier italic	10	12
Line Printer	16,66	8,5



International
92286C
\$150.00 ea.

ASCII, Roman-8, Roman Ext., French, German, United Kingdom, Danish/Norwegian, Swedish/Finnish, Spanish and Italian symbol sets

Portrait	Pitch	Point
Courier medium	10	12
Courier bold	10	12
Courier italic	10	12

Portrait & Landscape	Pitch	Point
Line Printer	16,66	8,5

Typewriter Font Cartridges

Letter Gothic



Letter Gothic P&L
92286N
\$250.00 ea.

Roman-8 symbol set

Portrait & Landscape	Pitch	Point
Letter Gothic medium	12	12
Letter Gothic bold	12	12
Letter Gothic italic	12	12



Letter Gothic
92286E
\$150.00 ea.

ASCII, Roman-8 and Roman Ext. symbol sets

Portrait	Pitch	Point
Letter Gothic medium	12	12
Letter Gothic bold	12	12
Letter Gothic italic	12	12

Prestige Elite



Prestige Elite P&L
92286M
\$250.00 ea.

Roman-8 symbol set

Portrait & Landscape	Pitch	Point
Prestige Elite medium	12	10
Prestige Elite bold	12	10
Prestige Elite italic	12	10



Prestige Elite
92286D
\$150.00 ea.

ASCII, Roman-8 and Roman Ext. symbol sets

Portrait	Pitch	Point
Prestige Elite medium	12	10
Prestige Elite bold	12	10
Prestige Elite italic	12	10

Publication Font Cartridges

TmsRmn/Helv



Microsoft® 1A
92286Z
\$330.00 ea.

ASCII, Roman-8 and ECMA-94 Latin 1 symbol sets

Portrait	Pitch	Point
TmsRmn medium	prop.	8, 10, 12
TmsRmn bold	prop.	10, 12, 14
TmsRmn italic	prop.	10, 12
Helv medium	prop.	8, 10, 12
Helv bold	prop.	10, 12, 14
Helv italic	prop.	10, 12

Landscape	Pitch	Point
Line Printer	16:66	8.5



TmsRmn 2
92286F
\$250.00 ea.

ASCII, Roman-8 and Roman Ext. symbol sets

Portrait	Pitch	Point
TmsRmn medium	prop.	8
TmsRmn medium	prop.	10
TmsRmn bold	prop.	10
TmsRmn italic	prop.	10
Helv bold	prop.	14.4
Line Printer	16:66	8.5



TmsRmn/Helv
Report 1
92290S2
\$250.00 ea.

Roman-8, PC-8, PC-8 D/N and ECMA-94 Latin 1 symbol sets

Portrait	Pitch	Point
TmsRmn medium	prop.	8
TmsRmn medium	prop.	12
TmsRmn bold	prop.	12
TmsRmn italic	prop.	12
Helv bold	prop.	14

Note: This cartridge is not compatible with the LaserJet, LaserJet PLUS or LaserJet 500 PLUS printers



TmsRmn IP&L
92286P
\$250.00 ea.

Roman-8 symbol set

Portrait & Landscape	Pitch	Point
TmsRmn medium	prop.	10
TmsRmn bold	prop.	10
TmsRmn italic	prop.	10

HELPFUL IDEA!

Consider the following factors when choosing from HP's Type Library:

- What *typeface* would most complement your message, and appeal to your readers?
- Which *treatments* and sizes would be most effective for the message?
- Would *portrait or landscape* orientation present your message best?
- Does your document require special *symbol sets* for non-English languages or mathematics?
- Are the fonts you've selected *compatible* with your software application?

Professional Font Cartridges



Tax 1
92286T
\$250.00 ea.

ASCII symbol set (does not include symbols)

Portrait	Pitch	Point
Helv medium	prop.	6, 8
Helv bold	prop.	8, 10, 12, 14

Tax Line-Draw symbol set

Portrait	Pitch	Point
Tax Line-Draw bold	10	12



Presentations 1
92286R
\$330.00 ea.

ASCII and Legal symbol sets

Portrait & Landscape	Pitch	Point
PRESENTATION BOLD	10, 8.1, 6.5	14, 16, 18
Letter Gothic med.	10	14

PC Line symbol set

Portrait & Landscape	Pitch	Point
PC Line medium	10	14

Line Draw symbol set

Portrait & Landscape	Pitch	Point
Line Draw medium	10	14

Professional Font Cartridges

Legal



Legal Elite 92286G
\$150.00 ea.

ASCII and Legal symbol sets

Portrait	Pitch	Point
Prestige Elite med.	12	10
Prestige Elite bold	12	10
Prestige Elite italic	12	10

Portrait & Landscape	Pitch	Point
Prestige Elite medium	16.66	7

Line Draw symbol set

Portrait	Pitch	Point
Line Draw medium	12	12



Legal Courier 92286H
\$150.00 ea.

ASCII and Legal symbol sets

Portrait	Pitch	Point
Courier medium	10	12
Courier bold	10	12
Courier italic	10	12

Portrait & Landscape	Pitch	Point
Prestige Elite medium	16.66	7

Line Draw symbol set

Portrait	Pitch	Point
Line Draw medium	10	12

Math



Math Elite 92286J
\$250.00 ea.

ASCII, Roman-8 and Roman Ext. symbol sets

Portrait	Pitch	Point
Prestige Elite med.	16.66, 12.7, 10	
Prestige Elite bold	12	10
Prestige Elite italic	12	10

Math8, Math8a and Math8b symbol sets

Portrait	Pitch	Point
Prestige Elite med.	16.66, 12.7, 10	

Math7, Pi Font and Pi Fonta symbol sets

Portrait	Pitch	Point
Prestige Elite med.	12	10



Math TmsRmn 92286K
\$250.00 ea.

ASCII, Roman-8 and Roman Ext. symbol sets

Portrait	Pitch	Point
TmsRmn medium	prop.	8, 10
TmsRmn bold	prop.	10
TmsRmn italic	prop.	10

Math8, Math8a and Math8b symbol sets

Portrait	Pitch	Point
TmsRmn medium	prop.	8, 10

Math7, Pi Font and Pi Fonta symbol sets

Portrait	Pitch	Point
TmsRmn medium	prop.	10

Forms Design Font Cartridges

Forms



Forms Portrait 92286U
\$250.00 ea.

Roman-8 and Roman Ext. symbol sets

Portrait	Pitch	Point
Helv medium	prop.	6, 8
Helv bold	prop.	10, 12, 14
Letter Gothic medium	16.66	9.5

Line Draw symbol set

Portrait	Pitch	Point
Line Draw medium	10	12



Forms Landscape 92286V
\$250.00 ea.

Roman-8 and Roman Ext. symbol sets

Landscape	Pitch	Point
Helv medium	prop.	6, 8
Helv bold	prop.	10, 12, 14
Letter Gothic medium	16.66	9.5

Line Draw symbol set

Landscape	Pitch	Point
Line Draw medium	10	12

Forms Design Font Cartridges

Bar Codes and Labels



Bar Code 3-of-9/OCR-A 92286W1
\$250.00 ea.

ASCII, Roman-8 and Roman Ext. symbol sets

Portrait	Pitch	Point
Letter Gothic medium	16.66	9.5
Letter Gothic med.	10	14

OCR-A symbol set

Portrait	Pitch	Point
OCR-A medium	10	12

Code 39 symbol set

Portrait	Pitch	Point
Bar Code 3-of-9 medium	4.6	12
Bar Code 3-of-9 medium	8.1	12

Line Draw symbol set

Portrait	Pitch	Point
Line Draw medium	10	12

Note: Extensive testing has been conducted on these bar codes; however, HP cannot warrant that the bar codes and OCR-A characters are readable with all bar code or OCR-A reading devices.



EAN/UPC/OCR-B 92286X
\$250.00 ea.

ASCII, Roman-8 and Roman Ext. symbol sets

Portrait	Pitch	Point
Letter Gothic medium	16.66	9.5
Letter Gothic med.	10	14

OCR-B and OCR-B Ext. symbol sets

Portrait	Pitch	Point
OCR-B medium	10	12

EAN/UPC symbol set

Portrait	Pitch	Point
EAN/UPC (10 mil) medium	prop.	12
EAN/UPC (13 mil) bold	prop.	12

Line Draw symbol set

Portrait	Pitch	Point
Line Draw medium	10	12

Note: Extensive testing has been conducted on these bar codes; however, HP cannot warrant that the bar codes and OCR-B characters are readable with all bar code or OCR-B reading devices.

Soft Fonts

Typewriter Soft Fonts



Presentations/Letter Gothic
33412DA 5.25 in. disc
\$200.00 ea.

Portrait & Landscape	Treatment	Pitch	Point
Symbol sets: ASCII and Legal			
PRESENTATION	Bold	10, 8.1, 6.5, 5.7, 4.6	14, 16, 18, 24, 30
Symbol sets: ASCII, Roman-8, Roman Ext. and Legal			
Letter Gothic	Medium	16.66, 12, 10	9.5, 12, 14
Letter Gothic	Bold	12	12
Letter Gothic	Italic	12	12
Symbol set: Math8			
Letter Gothic	Medium	16.66, 12	9.5, 12
Symbol sets: Math7 and PI Font			
Letter Gothic	Medium	12	12
Symbol set: Line Draw			
Line Draw	Medium	12, 16.66, 10, 8.1, 6.5	9.5, 12, 14, 16, 18
Symbol set: PC Line			
PC Line	Medium	16.66, 12	9.5, 12
PC Line	Bold	12, 10, 8.1, 6.5	12, 14, 16, 18



Presentations/Letter Gothic
33412DC 5.25 in. disc
33413DC 3.5 in. PS/2 disc
\$200.00 ea.

Portrait & Landscape	Treatment	Pitch	Point
Symbol sets: ASCII, Roman-8, ECMA-94 Latin 1 and Legal			
PRESENTATION	Bold	10, 8.1, 6.5, 5.7, 4.6	14, 16, 18, 24, 30, 36, 48
Symbol sets: ASCII, Roman-8, Roman Ext, ECMA-94 Latin 1, PC-8, PC-8 DN, PC-860, PC-863, PC-865 and Legal			
Letter Gothic	Medium	16.66, 12, 10	9.5, 12, 14
Letter Gothic	Bold	12	12
Letter Gothic	Italic	12	12
Symbol set: Math8			
Letter Gothic	Medium	16.66, 12	9.5, 12
Symbol sets: Math7 and PI Font			
Letter Gothic	Medium	12	12
Symbol set: Line Draw			
Line Draw	Medium	12, 16.66, 10, 8.1, 6.5	9.5, 12, 14, 16, 18



Prestige Elite Family
33412EA 5.25 in. disc
\$200.00 ea.

Portrait & Landscape	Treatment	Pitch	Point
Symbol sets: ASCII, Roman-8, Roman Ext. and Legal			
Prestige Elite	Medium	16.66	7
Prestige Elite	Medium, Bold, Italic	12	10
Symbol set: Math8			
Prestige Elite	Medium	16.66, 12	7, 10
Symbol sets: Math7 and PI Font			
Prestige Elite	Medium	12	10
Symbol sets: Line Draw and PC Line			
Line Draw	Medium	12	12

Publication Soft Fonts



TmsRmn/Helv
33412AC ASCII, 5.25 in. disc
33412AD Roman-8, 5.25 in. disc
\$200.00 ea.

Portrait & Landscape	Treatment	Pitch	Point
TmsRmn	Medium, Bold, Italic	prop.	6, 8, 10, 12, 14
TmsRmn	Bold only	prop.	18, 24, 30
Helv	Medium, Bold, Italic	prop.	6, 8, 10, 12, 14
Helv	Bold only	prop.	18, 24, 30



TmsRmn/Helv
33412AE ASCII, 5.25 in. disc
33412AF Roman-8, 5.25 in. disc
\$200.00 ea.

Portrait & Landscape	Treatment	Pitch	Point
TmsRmn	Medium, Bold, Italic	prop.	7, 9, 11
TmsRmn	Medium, Italic	prop.	18, 24, 30
Helv	Medium, Bold, Italic	prop.	7, 9, 11
Helv	Medium, Italic	prop.	18, 24, 30



ITC Garamond®
33412RA ASCII, 5.25 in. disc
33412RB Roman-8, 5.25 in. disc
\$200.00 ea.

Portrait	Treatment	Pitch	Point
ITC Garamond	Medium, Bold, Italic	prop.	6, 7, 8, 9, 10, 11, 12, 14, 18, 24, 30



Century Schoolbook®
33412SA ASCII, 5.25 in. disc
33412SB Roman-8, 5.25 in. disc
\$200.00 ea.

Portrait	Treatment	Pitch	Point
Century Schoolbook	Medium, Bold, Italic	prop.	6, 7, 8, 9, 10, 11, 12, 14, 18, 24, 30



Zapf Humanist 601™
33412TA ASCII, 5.25 in. disc
33412TB Roman-8, 5.25 in. disc
\$200.00 ea.

Portrait	Treatment	Pitch	Point
Zapf Humanist 601	Medium, Bold, Italic	prop.	6, 7, 8, 9, 10, 11, 12, 14, 18, 24, 30

Publication fonts continued next page

Headline Soft Fonts



Helv Headlines
33412AG 5.25 in. disc
\$200.00 ea.

Portrait & Landscape	Treatment	Pitch	Point
Symbol sets: ASCII, Roman-8, Legal, ECMA-94 Latin 1, PC-8, PC-8 D/N, PC-850, French, German, United Kingdom, Swedish, Norwegian, Spanish and Italian			
Helv	Black Outline	prop.	14, 18, 24, 30, 36, 48
Helv	Black Condensed	prop.	14, 18, 24, 30, 36, 48
Helv	Black Condensed Italic	prop.	14, 18, 24, 30, 36, 48
Serifa*	Black	prop.	14, 18, 24, 30, 36, 48

Note: The 36- and 48-point sizes, and PC-8, PC-8 D/N and PC-850 symbol sets are not compatible with the LaserJet, LaserJet PLUS and LaserJet 500 PLUS printers.



Headline Typefaces 1™
33412UA ASCII, 5.25 in. disc
33412UB Roman-8, 5.25 in. disc
\$200.00 ea.

Portrait	Treatment	Pitch	Point
Bauer Bodoni Black*	—	prop.	14, 18, 24, 30
Broadway*	—	prop.	14, 18, 24, 30
Cooper Black*	—	prop.	14, 18, 24, 30
Coronet	—	prop.	14, 18, 24, 30
University Roman	—	prop.	14, 18, 24, 30

HELPFUL IDEA!

Cartridge vs. soft fonts...which to choose?

The LaserJet PLUS, LaserJet 500 PLUS, LaserJet Series II, LaserJet IID and LaserJet 2000 printers can use both soft (disk-based) and hard (cartridge) fonts. In determining which type of font to purchase, consider the following:

Cartridge fonts—

- No downloading time. Because the cartridge font is plugged into the printer, you don't have to wait while the font is downloading to the printer's memory.
- No computer or printer memory is required. The cartridge font has all the memory needed to store the font data.

Soft fonts—

- More versatility in the combinations of fonts you can use.
- With no hardware involved, soft fonts generally cost less.
- Can be stored on your hard disk for convenient access.

To access cartridge fonts or download soft fonts, use a utility software like LaserControl or Type Director to supplement your application software.

Premier Collection brings desktop publishing to your HP LaserJet Printer

Thanks to HP's Premier Collection typeface products, you now have more flexibility in creating new designs and sizes.

The Premier Collection includes the Type Director font management program and 12 scalable typefaces. This innovative program not only scales typefaces to the size you need, it also helps you download and manage all your disc-based fonts.

For users of Aldus® Pagemaker™ and Xerox Ventura Publisher software, Type Director provides screen fonts to the software program so you can see how your document will look as you create it.

Type Director also works with Microsoft® Word and Microsoft Windows®

software. Consult the manufacturer to determine support with other programs.

C2054A Opt.ABA Premier Collection. Includes Type Director font management program plus four CG Times typefaces, four Univers 1 typefaces, Dom Casual, Uncial, Park Avenue and Brush typefaces. 5.25-in. disc format \$225.00 ea.

C2052A Opt.ABA Premier Collection. Includes all of above on 3.5-disc format \$225.00 ea.

C2051A Opt.D01 Type Director Font Management Program. Includes CG Times medium and Univers bold typeface. 5.25- and 3.5-in. disc formats \$95.00 ea.

C2050A Opt.ABA CG Times typefaces. Include CG Times medium, bold, italic typefaces. 5.25- and 3.5-in. disc formats \$195.00 ea.

C2050A Opt.D02 Univers 1 typefaces. Include Univers medium, bold and bold italic typefaces. 5.25- and 3.5-in. disc formats \$195.00 ea.

C2050A Opt.D03 Decorative 1 typefaces. Includes Dom Casual, Uncial, Park Avenue and Brush typefaces. 5.25- and 3.5-in. disc formats \$195.00 ea.

Note: For use with HP LaserJet PLUS, LaserJet 500 PLUS, LaserJet 2000, LaserJet Series II or LaserJet IID Printers. Minimum 2 MByte LaserJet Printer Memory Board recommended for frequent users of large size fonts or graphics, or for multiple users. Check with your dealer for additional typeface availability.

CG Times
CG Times Bold
CG Times Italic
CG Times Bold Italic

ABC def 1!&
ABC def 1!&
ABC def 1!&
ABC def 1!&

Univers
Univers Bold
Univers Italic
Univers Bold Italic

ABC def 1!&
ABC def 1!&
ABC def 1!&
ABC def 1!&

Brush
Dom Casual
Park Avenue
Uncial

ABC def 1!&
ABC def 1!&
ABC def 1!&
ABC def 1!&



Get crisp 'plots' quickly with LaserPlotter software



Take advantage of a world of plotter-oriented engineering and business-graphics software applications with LaserPlotter™

This easy-to-use software lets the family of HP LaserJet Printers produce high-resolution plots. How? By enabling your LaserJet Printer to emulate the HP 7475A, 7470A or ColorPro Plotter.

Works unattended! Forget babysitting your plotter. LaserPlotter can output graphic

after graphic while you're at work, or out to lunch or coffee. And LaserPlotter translates color plotter lines into 72 combinations of line width and grey texture. So your "color" graphics will photocopy into black and white.

What's more, LaserPlotter employs a unique data compression routine that lets you print faster and get higher-resolution graphics, *without* upgrading your LaserJet's memory.

Don't wait for a shot at the office plotter when you can get the equivalent of a printer and plotter in a single package! Available for the HP Vectra PC and other IBM PC-compatibles. Supported by Insight Development Corporation.

35188A LaserPlotter software \$150.00 ea.

Your output will be this clean, this crisp, this descriptive!

Want to get the most out of your HP LaserJet Printer? See our LaserJet books, page 21.

Treat your LaserJet to extra memory—treat yourself to high-resolution graphics!

Plug a 1, 2 or 4 MByte memory board into your HP LaserJet Series II family printer, and quickly print both full-page 300 x 300 dot-per-inch graphics and multiple softfonts. A must for printing fast, high-resolution charts, presentations and diagrams, or for desktop publishing applications.

1 MByte Memory Board is perfect for the single user who has a dedicated LaserJet and uses only a few standard

sized soft fonts per document or prints presentation-quality graphics.

33443B 1 MByte Memory Board \$595.00 ea.

2 MByte Memory Board is excellent for several users who share a LaserJet or for a sophisticated single user who needs many fonts or forms accessible in memory.

33444B 2 MByte Memory Board \$1195.00 ea.

4 MByte Memory Board is great for LaserJet printers shared by several users who need access to a variety of complex forms, detailed graphics or a wider selection of larger point-size fonts.

33445B 4 MByte Memory Board \$2295.00 ea.

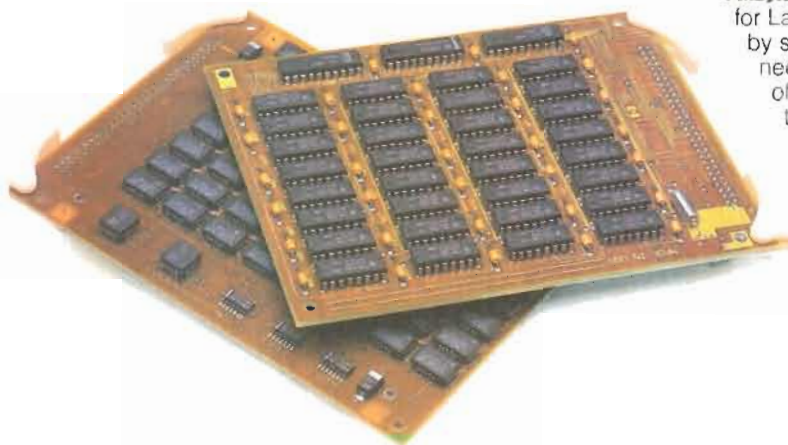

Custom-configure LaserJet printing

Tired of typing those troublesome escape sequences to laser print? PCLPak lets you custom-configure your printing to select fonts, page length, lines-per-page and more. Completely menu-driven.

33406B PCLPak for the HP Vectra PC and IBM PC/AT compatibles 79.00 ea.

Download soft fonts easily

FontLoad lets you download soft fonts to your HP LaserJet PLUS, 500 PLUS, Series II or 2000 printer with a single-word command. Supports the Microsoft® and HP Mouse, and Microsoft Windows; available on 5.25-in. disc. (Supplied free with new HP soft fonts.)

33407B FontLoad \$20.00 ea.

Create perfect documents

This handy Type Design Ruler can help you create the perfect document using your word processing system. Specially recommended for use with HPWORD. Design your documents for any size printer up to 132 columns wide (14 7/8 in. forms).

- 10-, 12- and 15-pitch spacing guides (positions/inch)
- 6 and 8 lines/inch spacing scales (reverse side)
- See-through windows for easy reading
- Convenient 15-inch length

5957-8407 Type Design Ruler .. \$4.00 ea.



Use JetForm to generate forms from your PC, and kiss that typewriter, correction fluid and carbon paper goodbye!



Are you surrounded by PCs and printers, but still coping with the tedious, error-prone task of typing pre-printed business forms? Let JetForm software automate the process.

JetForm lets you design and fill in your business forms or labels with your HP LaserJet Printer. Simply store your blank forms electronically. Then complete them when needed—directly from your PC!

- With JetForm software, you can:
- Develop or customize your own forms, on-screen and without the expense of typesetting—you even get shading, logos and bar codes!
 - Eliminate pre-printed form storage by generating forms as you need them, quickly and electronically.
 - Reduce errors and repetition, because you can fill out forms by merging data directly from dBase files. Or enter data manually on your PC, letting JetForm

edit your data and do calculations for you.

- Toss out that messy carbon paper and correction fluid! JetForm lets you correct errors on your PC. And you can complete as many versions of a form as you need, exactly the way you need them—in less time than ever before!

JetForm software system comes in two parts:

JetForm Design: Contains the electronic forms features you need to develop forms, including form design, HP ScanJet compatibility, screen form fill-in, file merge and a run-time version of MS Windows.

JetForm Print: A subset of JetForm Design with features necessary to fill in forms only. Two versions are available:

- IBM PC/AT version including a run time version of Microsoft® Windows™
 - IBM PC/XT version without MS Windows.
- An HP LaserJet Series II family printer is required to use JetForm software.



Produce your own forms, then fill in the blanks on the screen or by merging with computer files.

35188E JetForm Design for HP Vectra PCs and other IBM/AT compatibles with mouse \$495.00 ea.

35188G JetForm Print Windows for HP Vectra PCs and other IBM AT/compatibles

(1 unit) \$199.00 ea.
(2-4) 180.00 ea.
(5+) 170.00 ea.

35188H JetForm Print for IBM PC/XT and compatibles

(1 unit) \$199.00 ea.
(2-4) 180.00 ea.
(5+) 170.00 ea.

Make your HP LaserJet print envelopes or spreadsheets in multiple timesteps and sizes



LaserControl gives you control of your LaserJet's full range of capabilities.

A single stroke of your PC keyboard activates a pop-up menu, allowing

you to print on envelopes, download and access cartridge and soft fonts for word-processing software.

It even lets you combine timesteps and typesizes within a spreadsheet—without the inconvenience of leaving your software application.

You install LaserControl on your HP Vectra PC or other IBM-PC compatible in mere minutes.

And there's no need to upgrade your existing software with a new printer drivers for your LaserJet. Simply use LaserControl's built-in ability to emulate Epson, NEC, Qume or IBM printers. Then pop-up LaserControl for legal, envelope tray or even two-sided printing with the HP LaserJet Series IID.

LaserControl works with Lotus® 1-2-3®, DisplayWrite® and other popular applications. Available in 5.25 in. discs.

35190J
LaserControl \$150.00 ea.

<p>Russ Woodstein Product Manager Apples & Oranges, 1423 Cagigas Blvd Tel Aviv, Israel</p> <p>Dear Mr. Woodstein:</p> <p>Thank you very much for your May 20. Your comments will be very helpful in further improving the service we offer our fruit customers. It also shows how to pick our customers as well as our fruit.</p>	<p>Russ Woodstein Product Manager Apples & Oranges, 1423 Cagigas Blvd Tel Aviv, Israel</p> <p>Dear Mr. Woodstein:</p> <p>Thank you very much for your input. Your comments will be very helpful in improving the service we give to our fruit customers. It also shows how we know how to pick our customers as well as our fruit.</p>	<p>Russ Woodstein Product Manager Apples & Oranges, 1423 Cagigas Blvd Tel Aviv, Israel</p> <p>Dear Mr. Woodstein</p>
---	--	--

LaserControl lets you access the many different timesteps and sizes of your cartridge fonts, without exiting from your software application.

SALES UP 15%

PICK-OF-THE-TREE Inc.

Product Manager
Apples & Oranges,
1423 Cagigas Blvd
Tel Aviv, Israel

Dear Mr. Woodstein:

Thank you very much for your input of May 20. Your comments will be very helpful in further improving the service we offer our fruit customers. It also shows how we know how to pick our customers as well as our fruit.

Best regards,
Russ Woodstein
Product Manager
Apples & Oranges,
1423 Cagigas Blvd
Tel Aviv, Israel

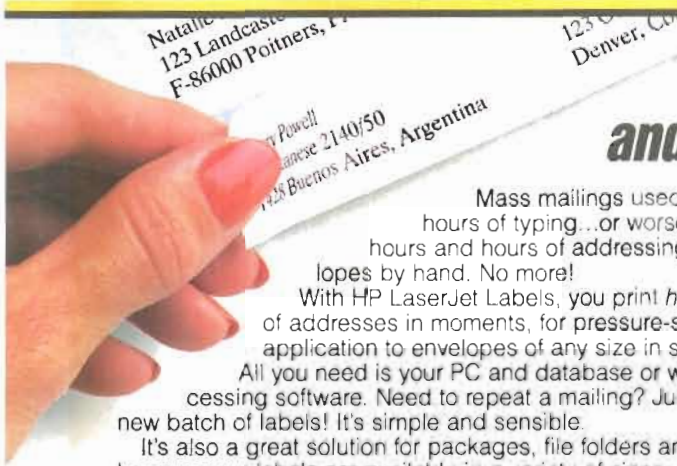

Get the drudgery out of mailing and labeling with HP LaserJet Labels

Mass mailings used to mean hours of typing...or worse yet, hours and hours of addressing envelopes by hand. No more!

With HP LaserJet Labels, you print *hundreds* of addresses in moments, for pressure-sensitive application to envelopes of any size in seconds. All you need is your PC and database or word-processing software. Need to repeat a mailing? Just run a new batch of labels! It's simple and sensible.

It's also a great solution for packages, file folders and discs, because our labels are available in a variety of sizes.

Because they're designed expressly for HP LaserJet printers, these labels print crisp and dark, and hold up to shipping and handling without fading. And unlike other labels, ours are made to withstand the high-heat of your LaserJet—there's no danger of glue melting and damaging your printer.

Get HP LaserJet Labels today—and put your time to better use! 100 8½ x 11 in. sheets per box.

LaserJet Labels					
Product no.	Height	Width	Number across	Number per sheet	Border edge?
92285K	1"	2½"	3	33	no
92157K	1"	2½"	3	30	yes
92285L	1¾"	2½"	3	24	no
92157N	1½"	2½"	3	21	yes
92157P	2"	4¼"	2	10	yes
92285M	2¾"	4¼"	2	8	no
92285W	6¼"	11"	1	1	no

(1 box) \$44.00 ea.
 (2-19) 37.50 ea.
 (20+) 31.00 ea.

Note: Labels are designed for automatic feeding into LaserJet Series II Printers only. Please manually feed labels into the back of LaserJet, LaserJet PLUS or LaserJet 500 PLUS Printers to assure continued maintenance support.



Label envelopes, files and packages with speed and efficiency—no more retyping or hand-writing!

Quick overheads from a LaserJet? With our transparency film, you bet!



Print your transparencies directly from PC to LaserJet... so your concepts are ready for the screen in a matter of moments!

Now you can produce transparencies directly from your PC and HP LaserJet Printer, as easily as typing a memo!

With HP LaserJet Film, words or graphics generated from your word-processing, spreadsheet or graphics applications are ready for overhead projection in seconds. You can even use large-sized LaserJet fonts to create attention-getting text.

This film was designed expressly for the high heat of your LaserJet, so it won't jam, melt or yellow. Why take chances with anything else? Available in 50-sheet boxes.

92285J HP LaserJet Overhead Transparency Film
 (1 box) \$32.00 ea.
 (2-9) 27.20 ea.
 (10-49) 24.00 ea.
 (50+) 21.75 ea.

HELPFUL IDEAS!

Produce overheads as quickly as typing a memo! Here's how:

- 1 Select a font with your desired typestyle and typesize, then plug the cartridge into your LaserJet or download the softfont to your PC.
- 2 Use your wordprocessor to create text.
- 3 Specify the font for your output by either embedding a Setup String at the beginning of your document text, or putting a Setup String in your software printer menu.

The Setup String consists of both an *Escape Code* that varies for each software package and can be found in your software manual, and *Control Characters* telling the printer what font to access and the character spacing.

Examples for 18 Point Presentation Font on the **92286R** Cartridge (see pages 12-17 for font cartridges):

Lotus® 1-2-3® Enter:
`\\027&113C\\027(OU\\027(sOp6.5h18V`
 in Print-Printer-Options-Setup.

Executive Memomaker Enter:
`ESC &113C ESC (OU ESC (sOp6.5h18V`
 in the Printer Setup String on the Print Menu.

Note: Check and adjust margins and line spacing as needed. Use upper and lower case characters as shown. "0" here is a zero; be careful of the difference between one (1) and lower case L (l). To learn more, just check your font documentation and LaserJet Technical Reference Manual.

Print envelopes to match your letters, quickly and easily!

Laser print directly on business or personal-sized envelopes with the HP LaserJet Series II family of Printers Envelope Tray.

This tray lets you print mailing addresses on envelopes preprinted with logos or addresses. It even lets you print your own logos and return addresses on envelopes, then print mailing addresses. And it works with most popular word processing software applications or purchase LaserControl (see page 19).

The envelope tray is perfect for moderate-volume mailings, holding a maximum of 15 envelopes sized between 86 x 178mm (3.4 x 7.0 in.) and 188 x 267mm (7.4 x 10.5 in.). This includes standard business (#10) and letter (Monarch) envelopes.

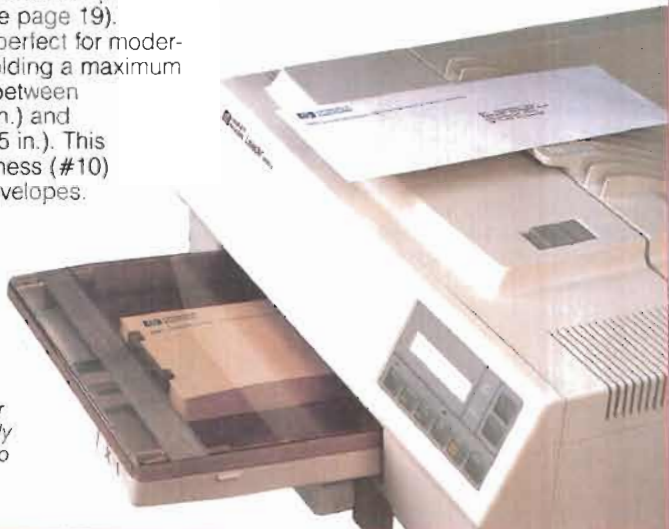

Use this easy-to-use envelope tray with your LaserJet Series II family of Printers to print up to 15 envelopes in a jiffy!

92295F HP LaserJet Series II family of Printers Envelope Tray

(1-2 units)	\$89.00 ea.
(3-9)	79.00 ea.
(10+)	69.00 ea.

NOTE: Users may find the envelope tray has a slightly higher jam rate than cut-sheet paper trays. We recommend that you test the envelopes you'll be printing before purchasing large quantities.



Organize LaserJet cartridge fonts

They're too valuable to be left out in the open. Stored in our LaserJet font organizer, your cartridge fonts can be easily found when you need them, or locked away in a desk drawer when you don't.

Up to four cartridges can be secured between high-density foam separators in this attractive acrylic box.

92285P Font Organizer

(1 unit)	\$42.95 ea.
(2-9)	38.95 ea.
(10+)	34.95 ea.

Tap into your HP LaserJet printer's type & graphics options—these books tell how!

Unlocking the LaserJet Howard and Janelle Gluckman/WizyWags Publishing 1988
This book makes easy work of the most difficult spreadsheet. You produce informational business graphics from Lotus® 1-2-3® or Symphony®—even add logos, shadow boxes and vary typesizes within them!
92176E \$19.95 ea.

Looking Good in Print: A Guide to Basic Design for Desktop Publishing Roger Parker/Ventana Press 1988

Here's a book that offers everything the title implies, and more! It shows you how to integrate type, graphics and photos through your desktop publishing applications, to produce

desktop publishing applications, to produce truly eye-catching newsletters, reports and other documents.

92220W \$23.95 ea.

LaserJet Unlimited, 2nd edition Ted Nace and Michael Gardner/Peachpit Press 1988

This updated edition offers concise, authoritative information and hands-on advice to most every aspect of laser printing, with special emphasis on the HP LaserJet Series II Printer. It discusses all applications, as well as Printer Command Language and setup utilities.

92235U \$25.00 ea.

See page 141 for more books.

Protect your printer

Shield your LaserJet Printer from dust and spills with this 100 percent cotton dust cover. It's custom-fitted for a professional look and durable enough to last for years. And because our dust cover is styled to complement your printer, it can enhance the appearance of your office as well.

92259G Dust cover for only the LaserJet Series II Printer \$30.00 ea.

92259C Dust cover for LaserJet, LaserJet PLUS and LaserJet 500 PLUS Printers \$30.00 ea.



These books tell how to vary your typesizes and typesyles...

get business graphics from...Lotus® 1-2-3®...

...and get DTP assistance, too!

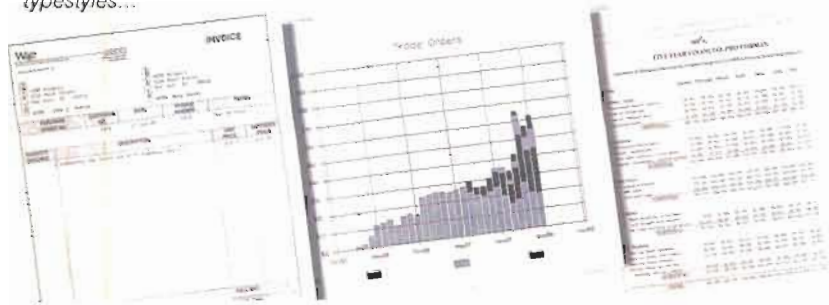

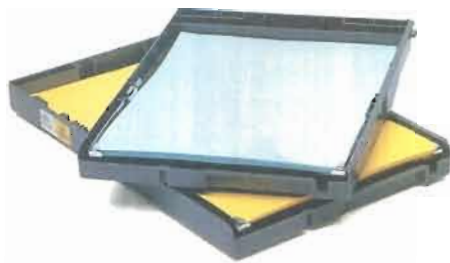

Change printer paper in a snap with replacement paper trays

Paper trays let you switch paper color, size or type in mere moments! Keep extras close by. You'll be able to change from letter to legal, white to goldenrod, as easily as slipping out one tray and sliding in another. Extra trays also lessen unnecessary downtime in the unlikely event that a tray should become damaged. With extra paper trays you'll work more quickly and efficiently.

For HP LaserJet and LaserJet PLUS Printers:

92285B U.S. letter-size paper tray. Holds 100 sheets of 216 x 279mm (8.5 x 11 in.) paper.	
(1-2 trays)	\$59.00 ea.
(3-9)	55.00 ea.
(10+)	50.00 ea.
92285C U.S. legal-size paper tray. Holds 100 sheets of 216 x 356mm (8.5 x 14 in.) paper.	
(1-2 trays)	\$59.00 ea.
(3-9)	55.00 ea.
(10+)	50.00 ea.
92285D Metric A4-size paper tray. Holds 100 sheets of 210 x 297mm (8.3 x 11.7 in.) paper.	
(1-2 trays)	\$59.00 ea.
(3-9)	55.00 ea.
(10+)	50.00 ea.
92285E Metric B5-size paper tray. Holds 100 sheets of 182 x 254mm (7.2 x 10 in.) paper.	
(1-2 trays)	\$59.00 ea.
(3-9)	55.00 ea.
(10+)	50.00 ea.

For LaserJet 500 PLUS Printers:

92287B U.S. letter-size paper tray. Holds 250 sheets of 216 x 279mm (8.5 x 11 in.) paper.	
(1-2 trays)	\$99.00 ea.
(3-9)	88.50 ea.
(10+)	81.00 ea.
92287C U.S. legal-size paper tray. Holds 250 sheets of 216 x 356mm (8.5 x 14 in.) paper.	
(1-2 trays)	\$99.00 ea.
(3-9)	88.50 ea.
(10+)	81.00 ea.
92287D Metric A4-size paper tray. Holds 250 sheets of 210 x 297mm (8.3 x 11.7 in.) paper.	
(1-2 trays)	\$99.00 ea.
(3-9)	88.50 ea.
(10+)	81.00 ea.
92287E Metric B5-size paper tray. Holds 250 sheets of 182 x 254mm (7.2 x 10 in.) paper.	
(1-2 trays)	\$99.00 ea.
(3-9)	88.50 ea.
(10+)	81.00 ea.

For HP LaserJet Series II or IID family of Printers:

92295B U.S. letter-size paper tray. Holds 200 sheets of 216 x 279mm (8.5 x 11 in.) paper.	
(1-2 trays)	\$69.00 ea.
(3-9)	59.00 ea.
(10+)	53.00 ea.
92295C U.S. legal-size paper tray. Holds 200 sheets of 216 x 356mm (8.5 x 14 in.) paper.	
(1-2 trays)	\$79.00 ea.
(3-9)	69.00 ea.
(10+)	62.00 ea.
92295D Metric A4-size paper tray. Holds 200 sheets of 210 x 297mm (8.3 x 11.7 in.) paper.	
(1-2 trays)	\$69.00 ea.
(3-9)	59.00 ea.
(10+)	53.00 ea.
92295E Executive-size paper tray. Holds 100 sheets of 184 x 267mm (7.25 x 10.5 in.) paper.	
(1-2 trays)	\$75.00 ea.
(3-9)	65.00 ea.
(10+)	58.00 ea.

HP LaserJet Printer accessories

Product no.	Description	Price
92285F	Forward Collator for the LaserJet and LaserJet PLUS Printers. Holds 200 pages.	\$49.95 ea
92285Q	Replacement Output Shelf—holds letter size 216 x 279mm (8.5 x 11 in.) paper. For the LaserJet and LaserJet PLUS Printers.	\$ 5.75 ea
92285R	Replacement Auxiliary Output Shelf Extension to attach to 92285Q Output Shelf (see above). Holds legal size 216 x 356mm (8.5 x 14 in.) paper. For LaserJet and LaserJet PLUS Printers.	\$ 5.50 ea
92285S	Replacement LaserJet Manual Input Tray for the LaserJet, LaserJet PLUS Printers.	\$ 5.25 ea
92285T	Service Kit for the LaserJet, LaserJet PLUS and 500 PLUS Printers (contains 2 separator belts, and 2 felt cleaner pads).	\$19.50 ea.
92295R	Replacement Top Cover for 92295B D E paper trays for the LaserJet Series III family of printers.	\$28.00 ea.
92295S	Replacement Top Cover for 92295C paper trays for the LaserJet Series II family of printers.	\$28.00 ea.

Get more from your HP LaserJet, subscribe to the LaserJet Journal

For updates on new products, and tips and techniques to better use your HP LaserJet Printer, subscribe to the *LaserJet Journal*. Working closely with HP, the *LaserJet Journal* writes articles based on actual customer questions from the HP Printer Hotline. Each bi-monthly issue is filled with articles such as:

- Six rules for using Lotus®
- Printing envelopes easily
- Managing fonts
- Updates on the latest HP LaserJet software
- HP LaserJet and WordPerfect

Yearly subscriptions are \$49 in the U.S., \$79 in Canada and \$99 elsewhere. All payments should be in U.S. funds. Call or write: *LaserJet Journal, Inc.*, 1945 Techny Road, Northbrook, IL 60062, U.S.A. (800) 323-2686 (in IL: 312-498-0920)

Attach this forward collator to the output lip of your HP LaserJet or LaserJet PLUS Printer, and up to 200 pages of printing can be neatly stacked in perfect order.



Who says a printer cabinet has to cost more to be better? Not the designers of our printer cabinet!



Thanks to your input, we've revamped our HP LaserJet Printer Cabinet.

We kept the quality—it's still sturdy as ever and perfectly compatible with your *Design Plus* furniture. It accommodates months of daily printing supplies. And it still has heavy-duty, lockable casters.

But our Cabinet now comes fully assembled, so you can use it the moment it arrives. And it's priced substantially less—less, in fact, than any other high-quality printer cabinet on the market today.

We even added a slot under the Cabinet top for easy attachment to other *Design Plus* components with our Bracket Kit (see page 104).

Shouldn't you add our LaserJet Printer Cabinet to your workplace?

The Printer Cabinet now attaches firmly to Design Plus tables, and provides ample space for manuals, paper trays, toner cartridges, months' of paper, and fonts (see page 21 for Font Organizer).



Our redesigned LaserJet Printer Cabinet is ready to use, right out of the box!

92211D HP LaserJet Printer Cabinet	
(1-2)	\$385.00 ea.
(3-9)	365.00 ea.
(10+)	345.00 ea.

Interested in our top-quality Design Plus furniture? Flip ahead to pages 101 to 106.

Clean up toner & paper dust fast! This improved vacuum is so easy to use, it makes laser printer upkeep a breeze.

Your vacuum comes with: 1) a filter, 2) a 1.8m (6 ft.) stretch hose, 3) a flexible goose neck, 4) a crevice tool with brush, 5) a 3.7m (12 ft.) power cord, 6) a static-draining ground wire with wrist strap—all packed into a light-weight, easy-to-carry case.



This specially designed vacuum makes cleaning your laser printers and copiers so easy, you'll never risk dirty-equipment problems again!

This is no ordinary vacuum! No general-purpose vacuum seeks out, whisks away and—most important—traps tiny toner particles the way this one does. Our vac's hose is "toner-proof," that is, it will not get stiff or sticky from toner, so there's no danger of toner escaping into the atmosphere. And the vacuum itself is smaller, lighter, quieter and 20 percent more powerful than before.

Custom-made for toner pickup The disposable filter traps particles as small as .3

microns (toner measures 5 microns). When it's full, an indicator light tells you so. No guessing, and no messing with bags. An extra-long hose and thoughtful accessories, like the rubber gooseneck that bends around corners, let you reach every nook and cranny without getting a speck of dust on yourself.

A static-draining wire and wrist strap protect your printer's sensitive circuits. And everything packs neatly in a carrying case not much bigger than a lunch box. UL/CSA listed. ☑

92175V HP PM Vacuum	
(1 unit)	\$249.00 ea.
(2+)	219.00 ea.

Why your office vac isn't enough



Ordinary vacuums allow particles smaller than 70 microns to escape back into the air you breathe.

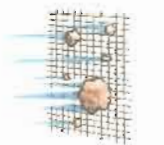

The HP PM Vacuum filter traps toner particles as fine as .3 microns—much, much smaller than your toner!

Replacement accessories:

92175W Filter for 92175V	
(1 unit)	\$22.00 ea.
(2-3)	18.00 ea.
(4+)	15.00 ea.
92175F Stretch hose*	
1.8m (6 ft.)	26.95 ea.
92175G Power cord*	
3.7m (12 ft.)	15.25 ea.
92175H Crevice tool/brush* ..	12.95 ea.
92175K Rubber gooseneck* ..	15.25 ea.
92175E Vacuum bags/filter for	
92175D, 10 per box	39.99 ea.

*for HP PM VAC 92175V or 92175D



HELPFUL IDEAS!

What kind of paper should you use with LaserJet Printers?

LaserJet Printers have been designed to work well with most types of paper, although some variables in paper composition may significantly affect print quality and paper handling. Paper manufactured for high quality photocopying yields good results for general purpose applications. For other applications where cotton bond is desirable (i.e., company letterhead), you should test the paper fully before you purchase it in order to ensure desirable performance.

If you are new to choosing paper for your LaserJet Printer, we recommend that you use the specifications below (also listed in your Operator's Reference Manual), when selecting paper.

Standard White Photocopy Paper Specifications

Basic Weight

LaserJet: 60-90g/m²
(16-21 lbs.)
LaserJet II: 60-150g/m²
(16-35 lbs.)

Thickness 0.086 to 0.107mm
(3.4 to 4.2 mils)

Moisture Content 4 to 6%

Cutting Dimensions (Accuracy of paper size) ±0.7mm
(.0276 in.)

Cutting Angle (Accuracy of paper edges) 90 degrees ± 4
(86 to 94 degrees)

Paper Grain Long Grain
(parallel to length)

We recommend that all paper be tested before it is purchased for your LaserJet Printer. Our office paper, page 44, meets these specifications.

HP LaserJet 2000



Laser printer supplies & accessories

Printer	Description	Product number	Price	
LaserJet 2000	Toner. Box contains two .5 kilogram bags. Will print approx. 14,000 216 x 279mm (8.5 x 11 in.) pages	92282A	(1-4 boxes) \$90.00 ea. (5-12) 80.00 ea. (13-24) 72.00 ea. (25+) 67.50 ea.	
	Standard Extra Paper Cassette Tray. 216 x 279mm (8.5 x 11 in.) Holds 250 sheets, landscape orientation.	92282B	(1-2 trays) \$99.00 ea. (3-9) 90.00 ea. (10+) 80.00 ea.	
	Legal Extra Paper Cassette Tray. 216 x 356mm (8.5 x 14 in.) Holds 250 sheets, portrait orientation.	92282C	(1-2 trays) \$99.00 ea. (3-9) 90.00 ea. (10+) 80.00 ea.	
	Extra Paper Cassette Tray, Metric A4 210 x 297mm (8.3 x 11.7 in.) Holds 250 sheets, landscape orientation.	92282D	(1-2 trays) \$99.00 ea. (3-9) 90.00 ea. (10+) 80.00 ea.	
	Executive Paper Cassette Tray. 184 x 267mm (7.25 x 10.5 in.) Holds 250 sheets, portrait orientation.	92282E	(1-2 trays) \$99.00 ea. (3-9) 90.00 ea. (10+) 80.00 ea.	
	Ledger Paper Cassette Tray. 275 x 432mm (11 x 17 in.) Holds 250 sheets, portrait orientation.	92282F	(1-2 trays) \$99.00 ea. (3-9) 90.00 ea. (10+) 80.00 ea.	
	Extra Paper Cassette Tray, Metric A3 297 x 420mm (11.7 x 16.5 in.) Holds 250 sheets, portrait orientation.	92282G	(1-2 trays) \$99.00 ea. (3-9) 90.00 ea. (10+) 80.00 ea.	
	Toner Disposal Boxes, Package of four.	92282P	\$26.00 pkg.	
	Plug-in Cartridge Font Organizer. Stores up to 4 fonts in sturdy acrylic box. Hinged lid keeps out dust (see page 25).	92285P	(1 unit) \$42.95 ea. (2-9) 38.95 ea. (10+) 34.95 ea.	
	2680A/2685A/2689A Laser Printer	Paper. Continuous feed. 18 lbs. (69-gm/sq meter). 305 x 216mm (12 x 8.5 in.), 3600 sheets/box, 45 boxes/pallet. Available in pallet quantities only.	92184A	(1-2 pallets) ... \$1290.00 ea. (3+) 1240.00 ea.
		Toner. 12-one kilogram bags per box. 3000,000 to 400,000 pages per box. For HP 2680 and 2689A.	92180A	(1-2 boxes) \$405.00 ea. (3-10) 380.00 ea. (11-19) 365.00 ea. (20+) 355.00 ea.
		Drum Kit. Includes new cleaner blade.	92180D	\$230.00 ea.
		Disposal Containers. Box of 6 for spent toner collection.	92181A	(1-2 boxes) \$78.00 ea. (3-5) 70.00 ea. (6+) 66.00 ea.
	Carrier. Box of 24 bottles. (Product sold by weight, not volume.)	92182A	(1-3 boxes) \$74.00 ea. (4-9) 70.00 ea. (10+) 68.00 ea.	
	Developer. Box of 6 bottles. Use 1 bottle per drum replacement.	92182D	215.00 ea.	
	Splicing Tape. Box of 6 rolls.	92183A	\$72.00 ea.	
2687A/2688A Desktop Laser Page Printer	Toner. Box of 6 bottles plus one empty collection bottle. For HP 2687A and 2688A.	92185A	(1 box) \$84.00 ea. (2-5) 78.00 ea. (6+) 74.00 ea.	
	Cleaning Pads. Box of 3. 60,000 cleanings per box	92185B	(1 box) \$72.00 ea. (2-5) 65.00 ea. (6+) 61.00 ea.	
	Ozone Filters. Box of 3.	92185D	(1 box) \$53.00 ea. (2-5) 48.00 ea. (6+) 44.00 ea.	
	OPC Belts. Box of 3.	92185E	(1 box) \$220.00 ea. (2-5) 210.00 ea. (6+) 200.00 ea.	
	Input Tray. 210 x 297mm or 8.5 x 11 in. Holds 250 sheets.	92185T	\$87.00 ea.	

HP 2680A Laser Printer



2688A Desktop Laser Page Printer



Save money, time and space with our peripheral-sharing devices...available to suit various needs

Our peripheral-sharing devices help you get the most from your PC by letting you share peripherals and use peripherals that speed up data transmission.

For example, ShareSpool lets as many as four people share the same printer without waiting. Our surge-protected RS-232C ABC switches let you switch freely between printer, plotter and modem while avoiding the risk of sending damaging surges

and spikes to those peripherals.

Our HP-IB ABC switch also promotes efficiency by letting you and two others share as many as three HP-IB plotters or printers. And you can rely on MicroSpooler™ to help you save time and print more efficiently.

Use the chart below to find out which devices can help you get the most from your personal computer and peripherals.

Peripheral-sharing devices comparison guide

Number of PCs to connect	Types of Peripherals	Number of Peripherals	Port Expansion	Buffer Memory Size	Interface	Product no.	Page no.
Up to 6	Printers, Plotters, Modems	Up to 6	Yes	None	RS-232C	92205F Surge Protected RS232C Dual ABC Switch	See page 27
Up to 3	Printer, Plotters, Modems	Up to 3	Yes	None	RS-232C	92205E Surge Protected RS232C ABC Switch	See page 27
Up to 4	LaserJet Series II family	Up to 4	Yes	265 Kbyte	RJ-45 to PC connections*	92204W ShareSpool™	See page 26
Up to 3	Printers, Plotters	Up to 8	Yes	None	HP-1B	92205Y HP-IB ABC Switch	See page 27
1	Printers	1	No	64 Kbytes	RS-232C	92205V MicroSpooler™ 64	See below
1	Printers	1	No	128 Kbytes	RS-232C	92205W MicroSpooler™ 128	See below

*25-pin RS-232C (IBM XT), 9-pin RS-232C (Vectra or IBM AT) or 25-pin RS-232C (JHP-150).

Why wait? Now you can work on the next task while MicroSpooler™ handles your printing for you!

Print without waiting for a turn on the printer with MicroSpooler.

This device accepts data from your computer at up to 5800 characters per second, stores it until your printer is ready, then sends it at the fastest pace the printer can accept. While the MicroSpooler is transmitting you can start your next task.

Choose the MicroSpooler that suits your application: MicroSpooler 64 handles applications with 64 Kbytes of buffer memory, like correspondence and short text. MicroSpooler 128's 128 Kbyte buffer memory is ideal for complex documents, scientific and business processing applications.

Easy-to-operate controls allow you to interrupt and resume operations, or to

clear buffer memory. A digital read-out updates and displays amount of memory in use and indicates system status. And single-initial commands let you print or transmit up to 256 duplicate copies.*

Installation is simple with a standard RS-232C extension cable. MicroSpooler is fully supported by Consolink® Corporation and available in the U.S. only. ☺

92205U MicroSpooler™ 64 . . . \$395.00 ea.

92205W MicroSpooler™ 128 . . . 495.00 ea.

31391A RS-232C cable (5m) 70.00 ea.

*If the length of your document exceeds your MicroSpooler's memory capacity, additional CPU time will be required to print and only the last portion can be duplicated.



Choose the MicroSpooler 64 for correspondence or short text, and the MicroSpooler 128 for more advanced tasks.

Without MicroSpooler™ 21 minutes
(CPU time for 20 pgs.; 80 CPS Bidirectional)



With MicroSpooler™ 8 seconds*
(CPU time for 20 pgs.; 80 CPS Bidirectional)



Feel like you have your own HP LaserJet Series II Printer when 4 are sharing it!

Increase productivity as if you had your own HP LaserJet Series II printer! ShareSpool™ lets up to four people share the printer without waiting.

ShareSpool reduces the cost of the HP LaserJet Series II printer because it's distributed among four users. So you, not only save time, you save money for your company.

Installation is a snap! Just slide ShareSpool into your HP LaserJet Series II printer I/O slot. Then run an HP StarLAN cable and an adapter to each PC. Check the chart below for what you need.

ShareSpool won't interfere with the RAM Expansion slot, so you can still install an additional memory card in your HP LaserJet Series II printer. 158.8 H x 82.6 W x 28 D mm (6.25 H x 3.25 W x 1.10 D in.) Service and support provided by Extended Systems.

92204W ShareSpool for the HP LaserJet Series II Printer.

(1 unit)	\$495.00 ea.
(2-4)	450.00 ea.
(5-19)	425.00 ea.
(20+)	396.00 ea.

Specifications

- 256K bytes of memory (about 150 pages of text)
- Direct communication to HP LaserJet Series II Printer backplane.
- 9600 or 19.2K baud supported on all input ports.
- Data Terminal Ready hardware or Xon/Xoff software handshake.
- Data-embedded commands.
 - multiple copies (background print)
 - multiple copies (foreground print)
 - end-of-job reset sequence.
 - end-of-job timeout.
 - disable embedded commands.
- RJ-45 cable connection from ShareSpool to PC
- User installable
- Power-on integral self-test diagnostic



No waiting in line to use the department PC. With ShareSpool all you do is hit the print command.



You'll only have to leave your desk to pick up your printout! You can do everything else at your own workstation!



ShareSpool frees up your PC to work on other projects, while another is being printed!



ShareSpool keeps each user's file in on-board memory until it's printed. All four of you can input jobs simultaneously.

What you'll need to connect ShareSpool™

Adapters (Choose one adapter for each PC)

PC	Description	Product no.	Price*
IBM PC, PC/XT, PS/2	25-pin RS-232 to modular jack for PC's with a 25-pin male connector.	92204X	(1 unit) \$20.00 ea.
			(2-4) 18.00 ea.
			(5-19) 17.00 ea.
			(20+) 16.00 ea.
HP Vectra PC, IBM PC/AT	9-pin RS-232 to modular jack for PC's with a 9-pin male connector.	92204Y	(1 unit) \$20.00 ea.
			(2-4) 18.00 ea.
			(5-19) 17.00 ea.
			(20+) 16.00 ea.
HP Touchscreen (HP 150)	25-pin RS-232 to modular jack for PC's with 25-pin female connector.	92204Z	(1 unit) \$20.00 ea.
			(2-4) 18.00 ea.
			(5-19) 17.00 ea.
			(20+) 16.00 ea.

*Note: Quantity discounts only apply when ordering the same adapter type.

Cables (Choose one cable for each PC)

Length	Product no.	Price
Less than 4m (13.1 ft.)	92268A	(1-4 units) ... \$18.00 ea.
		(5-8) 14.00 ea.
		(9+) 13.00 ea.
Less than 8m (26.2 ft.)	92268B	(1-4 units) ... \$19.00 ea.
		(5-8) 17.00 ea.
		(9+) 16.00 ea.
Less than 16m (52.5 ft.)	92268C	(1-4 units) ... \$22.00 ea.
		(5-8) 20.00 ea.
		(9+) 19.00 ea.
Less than 32m (105 ft.)	92268D	(1-4 units) ... \$27.00 ea.
		(5-8) 25.00 ea.
		(9+) 24.00 ea.

A screwdriver and a few minutes are all it takes to install the time-saving ShareSpool board into your HP LaserJet Series II printer.



Protect RS-232 peripherals while you share them! Now our ABC switches have surge protection!

Because of their unique surge suppression capabilities, our ABC switches are the only products of their kind approved and supported for use with HP LaserJet printers. Now you can switch freely between printers, plotters and modems without the risk of sending damaging surges and spikes to your peripherals.

ABC switches also offer one of the lowest priced sharing solutions. With just the turn of a switch each user can access any peripheral from their own workstation.

What you need to know about cabling For each peripheral and/or PC you connect to the single ABC switch, order one 3m (9.9 ft.) **17355M** extension cable.

The dual ABC switch is supplied with two 1.9m (7 in.) **92205U** Y cables. If you want to use the dual ABC switch to connect a third peripheral to two PCs, order an additional **92205U** Y cable. At most, three cables would be required for any configuration.

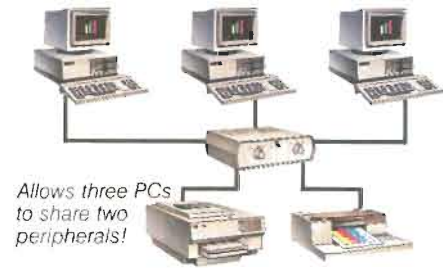
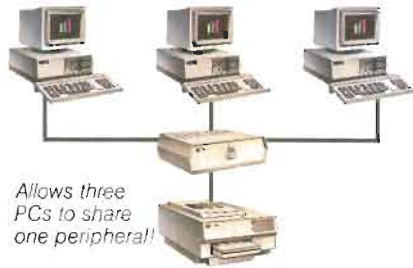

This ABC switch lets three PCs share the same printer or plotter. Or can be configured to allow one PC to access three peripherals, such as printer, plotter and modem.

92205E ABC Switch with built-in surge protection

(1 unit)	\$189.00 ea.
(2-4)	177.00 ea.
(5+)	165.00 ea.



This switch lets three PCs share two peripherals, or allows two PCs to share up to three peripherals. Also, it can be used as two separate ABC switches. Includes two 1.9m (7 in.) **92205U** Y cables.

92205F Dual ABC switch with built-in surge protection.

(1 unit)	\$369.00 ea.
(2-4)	332.00 ea.
(5+)	295.00 ea.

Specifications

Size: 76.2 H x 177.8 W x 254 D mm (3.0 H x 7.0 W x 10.0 D in.)

Weight: 0.8Kg (2 lbs.)

Enclosure: ABS plastic

Clamping voltage: + or -25V

Line capacitance: RS-232 signal

Regulatory approvals: FCC Part 15, Subsection J, Class B compliant

Characteristics:

- 4 female DB-25 connectors (92205E), 8 female DB-25 connectors (92205F)
- Pins 2-8, 20 and 22 protected (other pins not passed through)
- Pin 1s are tied common—chassis ground
- Pin 7s are tied common—signal ground

HELPFUL IDEA!

Valuable information about surge protection



Additional surge protectors at your peripherals eliminate the risk of port damage.

Our ABC switches prevent surges from entering the datacomm lines and being passed on to your peripheral. However, spikes and surges can enter between the switchbox and the peripheral, causing the delicate interface circuitry to slowly deteriorate.

For maximum surge and spike protection of equipment with sensitive RS-232 data ports, invest in the **92165R** surge protector (page 159). It's inexpensive insurance against surge-induced equipment failure.

HP-IB ABC switch will enable you and two co-workers to share an HP-IB printer or plotter, or several HP-IB printers and plotters. No more plugging or unplugging cords. No more waiting. With one turn of the dial, each of you can have access to one, two, three or more peripherals.* Installation is easy. Depending on whether three PCs or terminals will be hooked up to the switch and the peripherals, you need one or more additional HP-IB cables (10833A/B/C.)

92205Y HP-IB ABC switch	\$259.00 ea.
10833A 1m HP-IB cable**	80.00 ea.
10833B 2m HP-IB cable**	90.00 ea.
10833C 4m HP-IB cable**	100.00 ea.

*For use with printers and plotters only. When connecting several peripherals, make sure the total length (in meters) of all the HP-IB cables is no greater than twice the number of devices being connected.

**See page 74 for quantity break pricing on cables.

Three users—one peripheral

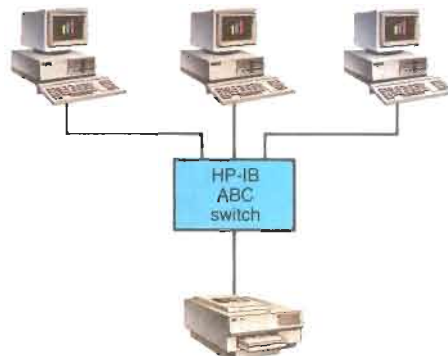

Three users—three peripherals

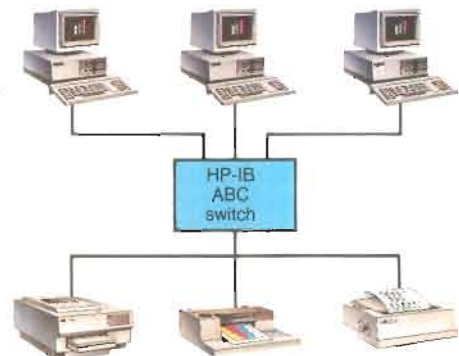

Graphics come alive! PaintJet paper, transparency film and print cartridges make the difference

Brilliant colors. Sharp images. And letters so crisp and sharp your text seems to spring from the page! Graphics like these are possible thanks to the way HP specifically designed PaintJet papers, transparency film and print cartridges to work together.

HP PaintJet Paper has a unique surface coating specifically formulated to match the ink in PaintJet print cartridges. The results? Instant ink drying and crisp, dark letters that won't smudge or smear.

And since HP PaintJet Paper is vacuumed to make it virtually dust-free, there's no floating paper dust to clog print cartridges and cause printing problems. If other papers are used, printing quality and printhead maintenance will vary.



HP PaintJet paper



Plain paper

You can see the difference! Notice how the smooth surface of the HP PaintJet Paper minimizes bleeding and intensifies color. And, since lines won't run, you achieve the fine detail you need on graphs and complex engineering drawings. Plain paper can be used but may produce "draft quality" output.

HP PaintJet Transparency Film* has been designed with a special surface coating that controls dot spread. Just print out a graph and watch the color deepen and develop before your eyes. Now, the transparency film has a leader which makes loading easy and allows for full page printing.

Plastic sleeves, provided with the film, are specifically designed to protect your transparencies and control film color development. Printed transparencies can be inserted into the sleeves and projected after just 5 minutes. The sleeved transparency will achieve its maximum color intensity after one-to-two hours.

HP PaintJet supplies

Description	Product number	Price
Z-Fold PaintJet Paper, 8.5 x 11 in. (216 x 279 mm) finished size, 250 sheets per pack.	51630P	(1-3 pack(s)) \$18.95 ea. (4-7) 16.95 ea. (8-63) 14.95 ea.
Z-Fold PaintJet Paper, Metric A4 (210 x 305 mm) finished size, 250 sheets per pack.	51630R	Available in Europe Only
Cut Sheet PaintJet Paper, 8.5 x 11 in. (216 x 279 mm), 250 sheets per pack.	51630Y	\$22.95 ea.
Cut Sheet PaintJet Paper, Metric A4 (210 x 297 mm) size, 250 sheets per pack.	51630Z	Available in Europe Only
PaintJet Transparency Film, 8.5 x 11 in. (216 x 279 mm) finished size, 50 sheet box includes 50 plastic sleeves. Required film for PaintJet Printer.	51630Q*	(1-4 boxes) \$64.95 ea. (5-9) 58.95 ea. (10+) 54.95 ea.
PaintJet Transparency Film, Metric A4 (210 x 297 mm) size, 50 sheet box includes 50 plastic sleeves. Required film for PaintJet printer.	51630S*	Available in Europe Only

*NOTE: HP PaintJet Film is the only film recommended for use with the HP PaintJet Printer.

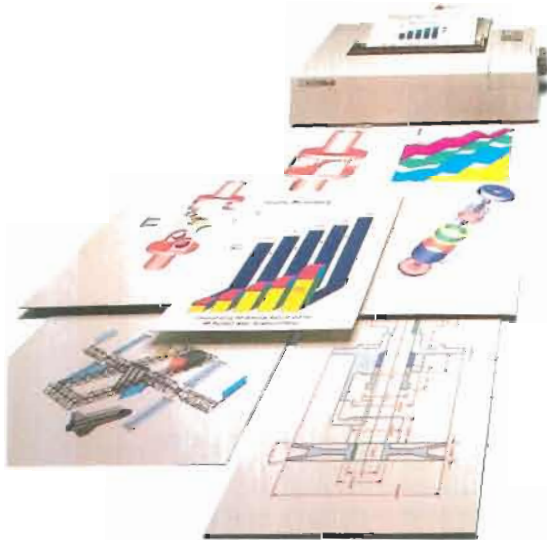

Like magic! Create a full palette of color with just two print cartridges

Snap in a color print cartridge and a black print cartridge and the HP PaintJet Printer is ready to splash all the colors of the rainbow on paper or transparency film.

Specially formulated inks in black, yellow, cyan and magenta, contained in just two print cartridges, provide many shades of brilliant color depending upon software, and a deep, true black. These rich gradations of color make possible professional-looking reports, overhead transparencies and technical images like the 3-D mechanical drawings shown at the right.*

The long-lasting black ink cartridge can print approximately 1100 pages of text while the color cartridge can typically print 180 pages of color graphics with 13 percent solid area fill. Every time you replace a print cartridge you are replacing the ink, the nozzles and even the electrical elements.

- 51606A** Black Print Cartridge
 (1-19) \$27.95 ea.
 (20-99) 25.71 ea.
 (100-199) 24.60 ea.
- 51606C** Color Print Cartridge
 (1-19) \$34.95 ea.
 (20-99) 32.15 ea.
 (100-199) 30.76 ea.

*Sample plots by VeriCAD™

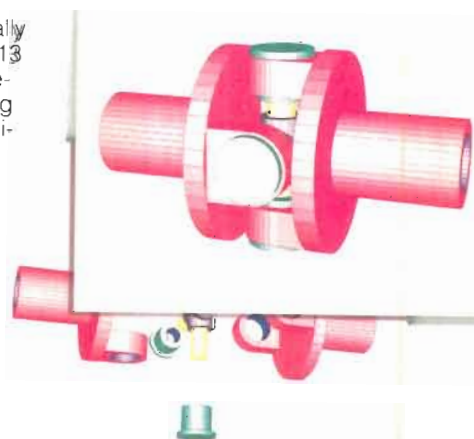

Reclaim desktop space! Place your HP PaintJet on a stand and suspend a paper catcher



This custom-designed, acrylic stand lets you stack the printer above the paper supply to cut in half the amount of desktop space required.

The curved edge on the rear of the stand serves two purposes: it directs the supply of fanfold paper evenly into the printer and channels cables out of the paper path. Dimensions: 124 H x 467 W x 337 D mm (4.9 H x 18.4 W x 13.25 D in.).

92269A Desktop Printer/Plotter Stand	
(1-2)	\$79.00 ea.
(3-9)	71.00 ea.
(10+)	64.00 ea.

Add a paper catcher to the back of the PaintJet Desktop Stand and fanfold paper will refeed and stack neatly as it flows from the printer. The 92261G Paper Catcher works in conjunction with the 92269A PaintJet Desktop Stand and attaches to the curved rear edge of the stand.

92261G Paper Catcher	\$28.00 ea.
-----------------------------------	-------------

HP PaintJet Dust Cover provides custom-tailored protection



Black edging and the HP logo add to the trim, professional look of the PaintJet Dust Cover.



Keep your HP PaintJet Printer in tip-top shape by protecting it from dirt, dust and spills. This form-fitting, custom-designed dust cover is tailored to fit the exact dimensions of the HP PaintJet Printer.

It's made of durable, 100% cotton fabric that's water-resistant, yet breathable, so moisture can escape. Even when you fold or roll the dust cover up for storage, it resists wrinkles.

92250Z PaintJet Dust Cover ..	\$22.00 ea.
--------------------------------------	-------------

Add bold, colorful text to your documents! It's easy with HP PaintJet Soft Fonts



What you see is what you get when you use these soft fonts with your HP PaintJet Color Graphics Printer!

HP PaintJet Soft Fonts work in tandem with your favorite Microsoft® Windows™ application

to help you create high-quality color text and graphics. You get:

16 strikingly varied fonts These soft fonts let you print in TmsRmn and Helv typefaces...8-, 10-, 12- and 14-point sizes...in medium, bold and italic type styles! Mix and match easily, as you please. It's an excellent solution for eye-catching reports or minor desktop publishing jobs, or for any text that needs a little extra life.

Very near letter-quality HP Soft Fonts make your documents look so sharp, they demand to get read! That's because our software engineers manipulated these fonts pixel by pixel for cleaner, more precise letters. It's called "hand-tuned bit-mapping." And it gives you a finished look that's more accurate than any other soft fonts available.



In living color Make your words leap from the page by printing them in readable red...believable blue...go-ahead green! The choices are yours.

These soft fonts are available on 3.5-in. and 5.25-in. discs for HP Vectra PCs and other IBM PC compatibles.

17301A HP PaintJet Printer Soft Fonts for Microsoft® Windows™	\$49.00 ea.
--	-------------

See that large, colorful type on the screen? You see it on paper, too, with HP PaintJet Soft Fonts!

SETTING UP THE PAGE

Page size equals the dimensions of your publication—not the dimensions of the paper you will use for printing. Page size does not have to match paper size. Working on a double-sided publication? If you want to work on two pages at a time, choose "Facing pages" with the "New..." or "Page setup..." command from the File menu. If you know approximately how many pages your publication will have, specify the "# of pages" with the "New..." command so the pages are ready when you are. You can change the page setup at any time.

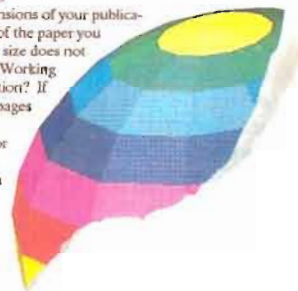

Pair that HP PaintJet with JetPlotter Software, and plot dazzling color graphics



Tap into your HP PaintJet Printer's full graphics potential with JetPlotter™. This powerful software turns your HP PaintJet into a fully compatible HP plotter. How? By making it HP plotter-

compatible with most business graphics, CAD or scientific software applications. You'll get dazzling color graphics at your desk, and full text printing from one printer—right at your desk!
Tailor your graphics output. JetPlotter allows you to vary color, line width, texture and even

vary the printer's resolution and speed. And since JetPlotter allows your HP PaintJet to function as both text printer and graphics plotter, you save desktop space, too!

- Take a look at these features:**
- Lets you produce polished high-resolution output, or quick draft-quality graphics.
 - Allows you to inverse, position, shrink and expand output size, and vary background and line color.
 - Offers 72 line-width and -texture control settings—great for photocopying color output in black and white.
 - Lets you print color or black and white output.
 - Makes HP PaintJet compatible with most software that uses HP 7475A, 7470 and ColorPro® Plotters.
- This easy-to-use, menu-driven software is available for the HP Vectra PC and other IBM PC-compatibles. Supported by Insight Development Corporation.
- 35190P** JetPlotter Software ... \$99.00 ea.

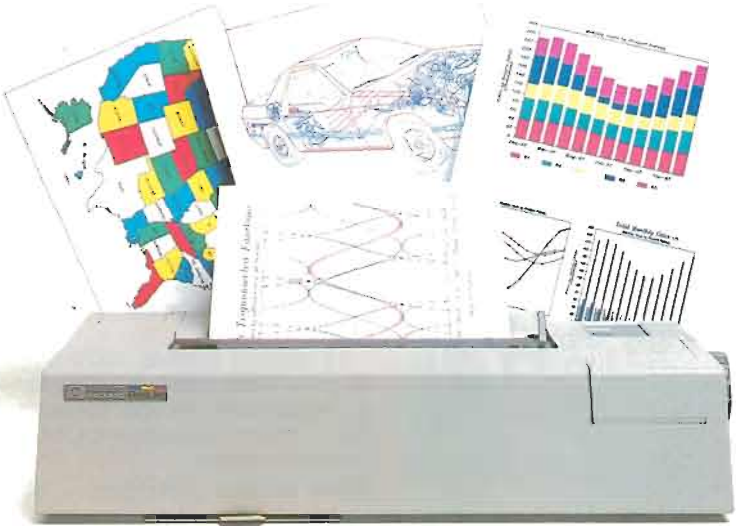

Print your graphics—quicker, quieter and directly from your HP PaintJet.

Transform your DeskJet into a super printer with new DeskPlotter Software



DeskPlotter™ Software lets your HP DeskJet emulate a plotter, and by taking advantage of DeskJet's 300 dpi capability, it produces high-resolution black-and-white graphics.

Produce dramatic graphics that photocopy completely. Choose from 72 different textures and line widths to create dynamic, easy-to-read images. Because DeskPlotter's black-and-white masters copy thoroughly, they're ideal for presentation handouts. This isn't true of copies of color plots since photocopying turns the different colors gray, eliminating the very points you tried to make with color.

You'll also save time because DeskPlotter graphics print up to six times faster than graphics on a plotter. Produce rush drafts in a hurry—the quiet DeskJet outputs page after page without your constant supervision. Plus, you'll never have to wait for your turn on the office plotter again!

You can also use DeskPlotter to produce inverse graphics (like blueprints) and for plotting designs from CAD software, as well as business graphics from packages like Lotus® 1-2-3® and ChartMaster.

35184E DeskPlotter Software for the HP DeskJet Printer ... \$129.00 ea.

DeskPlotter's high-resolution output copies perfectly.



Color plots muddle together when they're photocopied, unlike DeskPlotter's "textured" output.

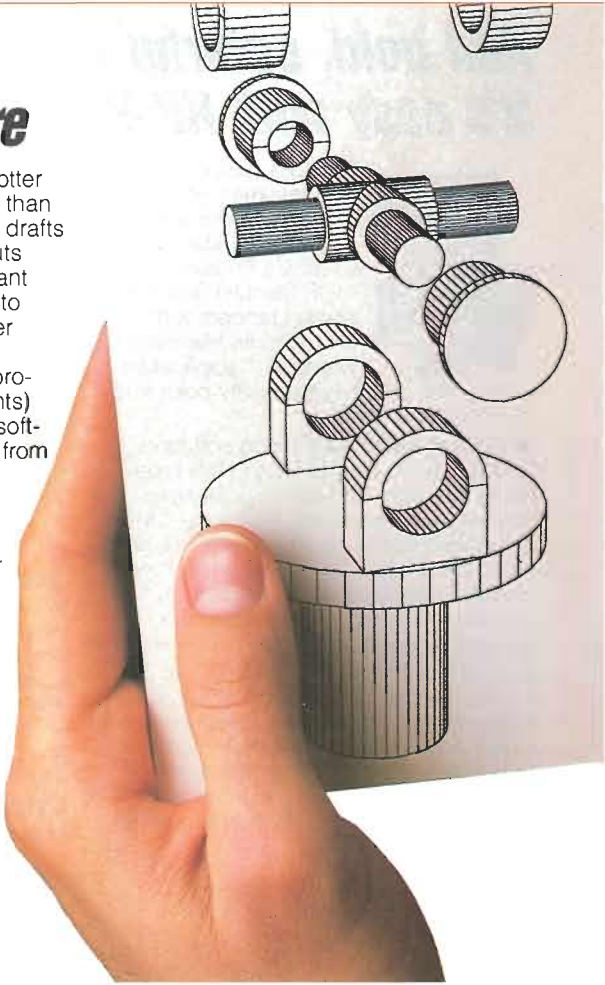

Make your HP DeskJet print envelopes, or spreadsheets in multiple typestyles and sizes!



LaserControl gives you control of your HP DeskJet Printer's full range of capabilities.

A single stroke of your PC keyboard activates a pop-up menu, allowing you to print on envelopes, access cartridge fonts and softfonts, download softfonts, and even switch printers—without the inconvenience of having to leave your software application.

You install LaserControl on your HP Vectra PC or other IBM-PC compatible in mere minutes.

And there's no need to upgrade your existing software with new printer drivers

for your DeskJet. Simply use LaserControl's built-in ability to emulate Epson, NEC, Qume or IBM printers.

LaserControl works with Lotus® 1-2-3®, DisplayWrite® or any application that needs a DeskJet driver. Available in 5.25 in. discs.

35190J
LaserControl \$150.00 ea.

Use LaserControl with your DeskJet to print envelopes and eye-catching spreadsheets—without executing complex escape codes!

<p>Mr. Alan Hirsch Product Manager Hewlett Packard 1927 Landings Drive Mountain View, CA 94040</p> <p>Dear Mr. Hirsch:</p> <p>This letter and the en wide area network serv</p>	<p>Mr. Alan Hirsch Product Manager Hewlett Packard 1927 Landings Drive Mountain View, CA 94043</p> <p>Dear Mr. Hirsch:</p> <p>This letter and the enclosed wide area network services at</p>	<p>Mr. Alan Hirsch Product Manager HEWLETT PACKARD 1927 LANDINGS DRIVE MOUNTAIN VIEW, CA 94043</p> <p>DEAR MR. HIRSCH:</p> <p>THIS LETTER AND THE ENCL WIDE AREA NETWORK SERVICE</p>	<p>Mr. Alan Hirsch Product Manager Hewlett Packard 1927 Landings Drive Mountain View, CA 94043</p> <p>Dear Mr. Hirsch:</p> <p>This letter and the enclosed in wide area network services and</p>
---	--	--	--

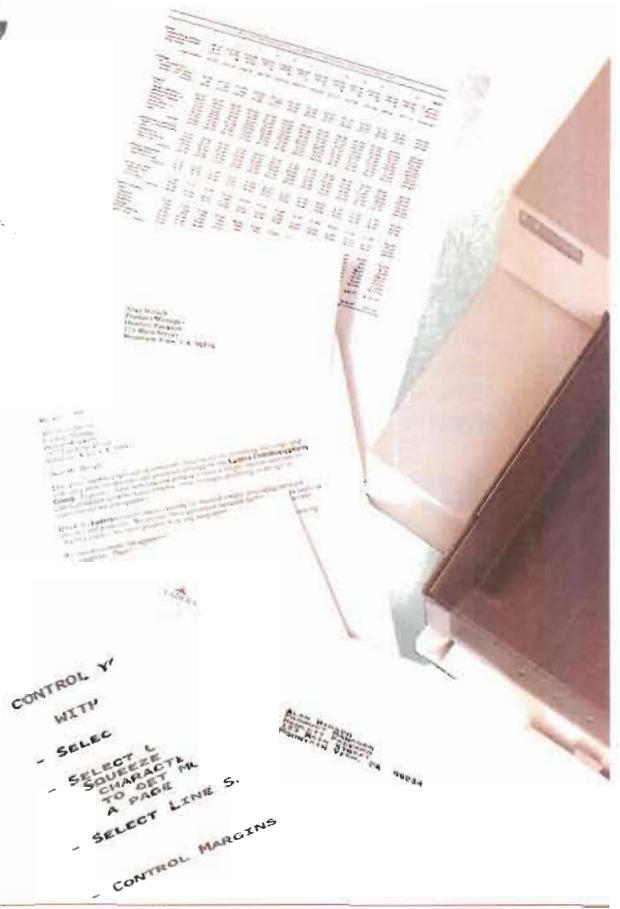

Don't rummage for your DeskJet supplies! Keep them neat & handy in a drawer tucked under the printer!

Ever watched your productivity grind to a halt as you searched for the supplies you needed to do your job? What a drain! Slip your DeskJet accessories into our acrylic organizer drawer and you'll never waste another minute hunting them down. Using the "hidden" space under your printer, the organizer adds storage room without subtracting workspace!

Custom designed for perfect fit and function.

Created just for your HP DeskJet, the handsome organizer looks like part of your system. The supplies drawer glides silently on teflon runners. Inside, foam cut-outs secure two print cartridges in their sealed containers, four font or memory modules and a full ream of 8.5 x 11 in. or European A4 paper. Legal documents? Just remove the foam spacer from the paper section and your 8.5 x 14 in. paper fits right in! Order your DeskJet Organizer today.

92177Z DeskJet Organizer. Exterior dimensions: 11 H x 445 W x 384 D mm (4.38 H x 17.5 W x 15.13 D in.)

- (1-2) \$129.00 ea.
- (3-9) 122.00 ea.
- (10+) 115.00 ea.

Don't waste your day playing hide-and-seek with printer supplies. Take control with our DeskJet Organizer. You'll get more done with less aggravation. And you'll never run short because you'll see when to reorder.

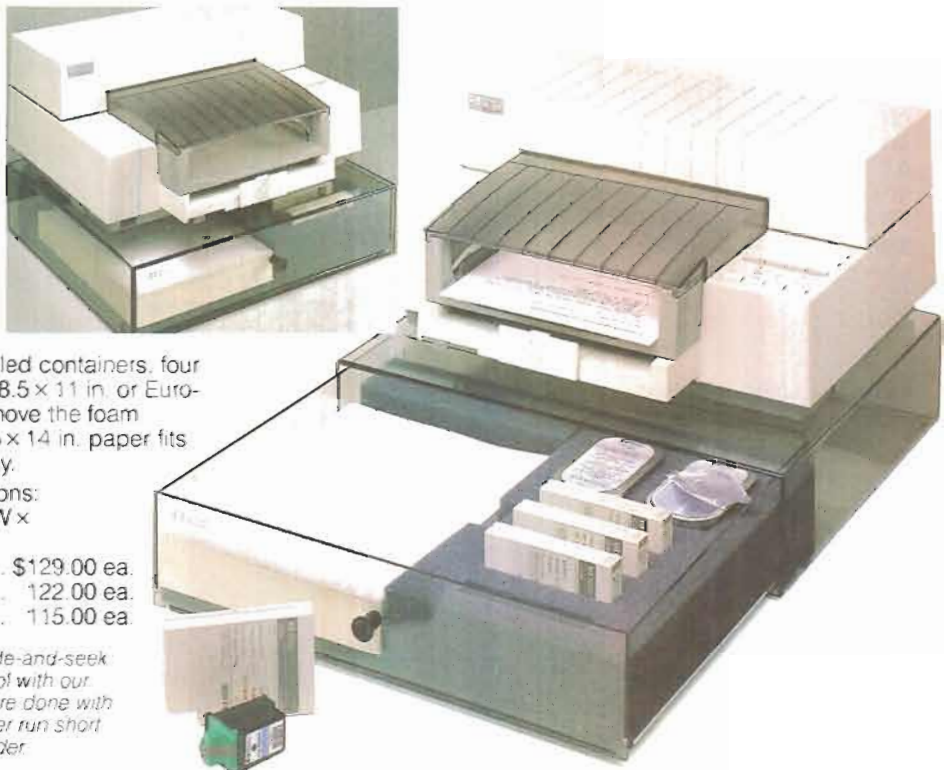

Count on the HP DeskJet Printer for economical, laser-quality output. Count on the DeskJet Printer soft font to make it easy!

This soft font makes it easy to vary the type of your low-cost, letter-quality HP DeskJet Printer.

With it, you can switch between TmsRmn and Helv in 8, 10, 12 and 14 point sizes. But you do so directly from your PC, instead of having to change the font cartridge in your printer.

The soft font is available on 5.25-inch disc for use with the HP Vectra PC and the IBM PC, PC/AT, PC/XT and IBM PC compatibles. For more efficient performance, the addition of a 128K byte RAM cartridge is recommended (see 22707A below).

22708A HP DeskJet Printer softfont *Reduced Price!* \$75.00 ea.

Add memory to your printer.

Our 128K byte RAM cartridge expands your printer's memory to accommodate softfont downloading. Installation is simple—just plug it into your HP DeskJet Printer.

22707A 128K byte RAM cartridge *Reduced Price!* \$125.00 ea.

For replacement external power modules, see page 38.



Print letter-quality on plain paper

Put this print cartridge in your HP DeskJet Printer, and get your message to the world on the common office bond or copier paper of your choice.

It produces crisp text and razor-sharp graphics. A single cartridge typically prints 525,000 letter-quality characters, or a million characters in draft mode (based on Courier 12 font). And it's totally self-contained for quick, clean installation.

51608A HP DeskJet Printer black print cartridge
 (1-19) \$18.95 ea.
 (20-99) 18.00 ea.
 (100+) 17.00 ea.



Emulate an Epson FX-80 with your HP DeskJet Printer

Enjoy the benefits of Epson-compatible software applications and the HP DeskJet Printer's economical laser-quality printing!

Just plug this emulation cartridge into either of your HP DeskJet Printer's cartridge slots. You'll print quietly and efficiently.

22707E HP Epson FX-80 Printer emulation cartridge \$75.00 ea.

Here's protection for your HP DeskJet Printer

Shield your HP DeskJet Printer from dust and spills with this 100 percent cotton dust cover. It's custom-fitted for a professional look and durable enough to last for years. And because our dust cover is wrinkle-resistant and styled to complement your printer, it can enhance the appearance of your office as well.

92250R HP DeskJet Printer dust cover \$35.00 ea.



Enjoy the silent, practical power of an HP ThinkJet, QuietJet or QuietJet Plus Printer

HP's ThinkJet, QuietJet and QuietJet Plus Printers let you think, talk and handle other tasks while you print—in draft or near letter-quality, at the office or at home.

All five (including the battery-powered HP 2225P) of our ThinkJet Printers and our QuietJet and QuietJet Plus Printers are built around HP's low-decibel, non-impact ink-jet technology. The heart of this technology is our inexpensive, disposable ink print cartridge that combines innovation and user convenience. You just snap it in, or lift it out—no handling of ribbons, no contact with ink. Simple, clean, efficient!

Choose the HP QuietJet Printer for near letter-quality output

The QuietJet and the QuietJet Plus Printers are engineered to give ultra-quiet performance and high quality printing. The QuietJet is almost the same printer as the QuietJet Plus—it just costs less and takes up less space! The wide-carriage QuietJet Plus Printer is perfect for larger spreadsheets while the narrow-carriage QuietJet Printer accommodates standard size paper. With the QuietJet or QuietJet Plus Printer, you can:

- Get sharp characters when printing quick drafts at 192 cps and near-letter quality (NLQ) for important letters and reports at 48 cps.
- Print graphics in three densities for professional-looking charts and illustrations.
- Change print sizes using six print pitches, and print enhancements to highlight, clarify or get more information on a page.
- Choose NLQ, draft or compressed print with just one keystroke on a convenient key panel.
- Connect to HP, IBM or Apple personal computers. QuietJet and QuietJet Plus Printers come with Centronics and RS-232C interfaces, or an HP-IB interface—a feature normally found in higher-priced printers.

The QuietJet Series printers offer excellent Z-Fold paper handling with a fully adjustable tractor and a paper-advance knob. A friction-feed full platen allows for easier manual sheet-feeding.

QuietJet Printer dimensions: 118 H x 395 W x 214 D mm (4.65 H x 15.5 W x 8.43 D in.).

QuietJet Plus dimensions: 121 H x 527 W x 221 D mm (4.76 H x 20.75 W x 8.7 D in.).

- HP 2228A** QuietJet Printer ... \$599.00 ea.
- HP 2227A** QuietJet Plus Printer ... \$799.00 ea.
- HP 2227B** QuietJet Plus Printer with HP-IB interface ... \$799.00 ea.



You can rely on the QuietJet, QuietJet Plus and ThinkJet Printers for fast, quiet and quality performance every time!

Get a ThinkJet Printer for quick, economical drafts

Quick, quiet, and small describe our best-priced ink-jet printer—the ThinkJet. Lightweight and compact, it allows you the convenience of personal printing whenever or wherever you need to print. With the ThinkJet Printer, you can:

- Print a standard letter in less than a minute at a print speed of 150 cps.
- Have graphics printed with the same speed and silence.
- Connect to HP, IBM or Apple personal computers.
- Highlight and vary your output using four print pitches, underlines and bold.
- Have the convenience of using Z-Fold paper.
- Have the freedom of taking your printer anywhere.

ThinkJet dimensions: 89 H x 292 W x 206 D mm (3.5 H x 11.5 W x 8.1 D in.)

We ship your ThinkJet Printer with a print cartridge, a packet of Z-Fold paper, an owner's manual, a warranty card and a supplies brochure!

- HP 2225A** ThinkJet Printer with HP-IB interface and power cord ... \$495.00 ea.
- HP 2225B** ThinkJet Printer with HP-IL interface, 1m HP-IL cable, battery pack and recharger ... \$495.00 ea.
- HP 2225C** ThinkJet Printer with Centronics interface and power cord for use with HP and non-HP PCs ... \$495.00 ea.
- HP 2225D** ThinkJet Printer with RS-232C interface and power cord for use with HP and non-HP PCs ... \$495.00 ea.
- HP 2225P** ThinkJet Printer with Centronics interface, battery pack and recharger for use with non-HP portables ... \$495.00 ea.
- 92219Z** Centronics cable to connect HP 2225P to IBM PC-compatibles. 1m (3.3 ft.) shielded with 25-pin male/15-pin male connectors ... \$51.00 ea.

To order cables for your ThinkJet or QuietJet Printer, see pages 78-80. For power modules, see page 38.

Warranty and post-warranty services are available for HP printers. Call your local HP sales office for more information.

Tidy up your desk with our space-utilizing Printer Stand

Slip one of our lightweight, durable acrylic Printer Stands under your HP ThinkJet, QuietJet or QuietJet Plus

Choose a Printer Stand for your HP ThinkJet...

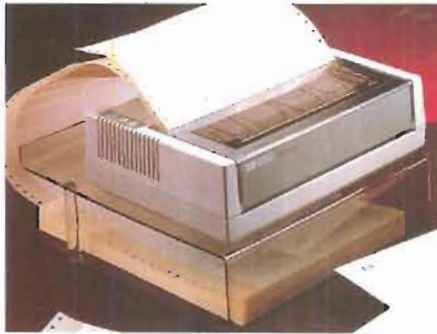

Printer, and your desk just got bigger.

How so? Because our stands let you stack printer over printer paper.

What's more, they feature a cleverly raised rear edge to keep cables away from the flow of your output. And that edge easily supports a wire paper catcher (see below).

Choose a stand customized for your particular HP personal printer, or the versatile model suitable for a desktop printer or a graphics plotter.

92261S HP ThinkJet Printer Stand	\$49.00 ea.
92261U HP QuietJet Printer Stand	\$79.00 ea.
92261T HP QuietJet Plus Printer Stand	\$84.00 ea.



...or your HP QuietJet Printer.

92269A Desktop printer/plotter stand (1-2 units)	\$79.00 ea.
(3-9)	71.00 ea.
(10+)	64.00 ea.

Keep that printer output in its place!

Attach our Wire Paper Catcher to the stand of your HP personal printer for output that folds neatly, undisturbed by power cords and cables.

It can be positioned flat on your desk,



Lay the Wire Paper Catcher on your desktop behind your printer...

or suspended behind your printer by its connecting chain at a 30-degree angle.

You can even attach our Paper Catcher to a Terminal Top Printer Stand (see page 37) and suspended it behind both printer and terminal.

92261G HP QuietJet/QuietJet Plus Printer Paper Catcher (1-2 units)	\$35.00 ea.
(3-9)	31.00 ea.
(10+)	28.00 ea.
92261R HP ThinkJet Printer Paper Catcher (1-2 units)	\$35.00 ea.
(3-9)	31.00 ea.
(10+)	28.00 ea.

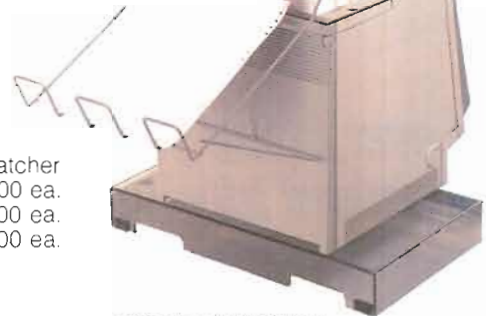

...or suspend our Wire Paper Catcher behind your HP personal printer and desk to maximize space.

Produce mailing labels, directly from your HP ThinkJet, QuietJet or QuietJet Plus Printer

Our HP JetLabels are engineered for optimum printing on HP personal printers, without jamming or tearing.

Economical and simple to use, HP JetLabels are the *only* Z-Fold labels designed specifically to conform with the built-in margin spacing in HP ThinkJet Printers.

And you can expect the same high level of print quality on HP JetLabels as with HP JetPaper, because these pressure-sensitive, self-adhesive labels are made from the same paper stock.

Labels come two across, 2,000 per box; dimensions are 89 x 24mm (3.5 x 1 1/16 in.) on 241mm (9.5-in.) form width.

51630L HP JetLabels (1-2 boxes)	\$18.95 ea.
(3-11)	17.95 ea.
(12+)	16.95 ea.

HP JetLabels are the *only* labels designed specifically for printing on your HP ThinkJet, QuietJet or QuietJet Plus.



Plain paper or JetPaper, draft or letter...we've got the print cartridge for your HP ThinkJet, QuietJet or QuietJet Plus Printer

If you think HP JetPaper is the only media that works with your HP ThinkJet or QuietJet Printer, think again! Now you've got options.

HP's Plain Paper Cartridge lets you produce drafts and memos on plain paper. You're sure to appreciate the convenience.

For more important correspondence and business presentations, stick with the HP JetPaper Print Cartridge and HP JetPaper (see page 38). You'll feel confident your finished work looks its best. ☺

- 51604A** HP Plain Paper Print Cartridge, black \$10.95 ea.
- 92261A** HP JetPaper Print Cartridge, black (1-19) \$10.95 ea.
- (20-99) 10.40 ea.
- (100-199) 9.86 ea.



Snap in our Plain Paper Print Cartridge for drafts and memos, or a JetPaper Cartridge for top-quality printing on HP JetPaper.

When color counts, HP has the hues!



Basic black may be the accepted standard in business visuals. But there's nothing like HP JetPaper color Print Cartridges to get your message across with flair.

These cartridges let you produce attention-getting correspondence and presentations in green, blue or red, in moments. Print pages of text in a totally unexpected color. Or print text in black and use a color for graphics. It's your choice!

Each color cartridge prints about 500 pages. Use one color per JetPaper page for more effective printing. ☺

- 51605B** HP JetPaper print cartridge, blue \$12.95 ea.
- 51605G** HP JetPaper print cartridge, green 12.95 ea.
- 51605R** HP JetPaper print cartridge, red 12.95 ea.

Get everything you need for your HP printer in a single, convenient kit—and save more than 15%



Put your HP ThinkJet Printer to work for you immediately with this five-in-one kit.

Five essential products for your ThinkJet Printer This kit includes all the basics: two black HP JetPaper Print Cartridges that print up to 1,000 pages, plus our acrylic Printer Stand to help you save desktop space, and our water-resistant cotton Dust Cover to protect your printer.

Completing the kit is 500 sheets of microperforated Z-Fold HP JetPaper

(finished size: 216 × 279mm or 8.5 × 11 in.), and 500 sheets of individually-cut JetPaper (216 × 279mm or 8.5 × 11 in.).

- 92261D** HP ThinkJet Accessory Kit ☺ \$95.00 ea.

Eight essential products for your QuietJet Plus Printer This sampler kit gets you off to a productive start.

You'll print as many as 2,000 pages with its four HP JetPaper Print Cartridges in black, blue, red and green.

You'll save desktop space with its acrylic Printer Stand, and protect your printer with the static- and water-resistant cotton Dust Cover.

And you'll get a 500-sheet supply of microperforated narrow Z-Fold HP JetPaper, plus 500 sheets of perforated Z-Fold Wide HP JetPaper.

- 92261P** HP QuietJet Plus Accessory Kit with 279mm (11 in.) paper . . . \$159.00 ea.
- Narrow paper finished size: 216 × 279mm (8.5 × 11 in.)
- Wide paper finished size: 378 × 279mm (14 7/8 × 11 in.)

92261X HP QuietJet PLUS Accessory Kit with 305mm (12 in.) paper. Available in Europe only. Narrow paper finished size: 210 × 305mm (8 1/4 × 12 in.) Wide paper finished size: 376 × 305mm (14 3/4 × 12 in.)



The eight starter products in our HP QuietJet Plus Printer kit start you off productively.

JetPlotter software makes your HP JetSeries Printer think like a plotter!

No more waiting for the office plotter! JetPlotter™ lets you unlock the powerful graphics capabilities of your HP ThinkJet, QuietJet or QuietJet Plus Printer, and makes it function like a full-featured HP plotter.

This software package converts the graphics language of HP plotters into high-resolution ink-jet printouts. You can take advantage of most CAD, engineering or business graphics software supported by HP 7475A, 7470 or ColorPro Plotters.

Double your printer power. Ever tried to photocopy color plotter pen output in black and white? The colors blend, don't they? Not so with JetPlotter! It lets you print in 72 combinations of line width and texture—all of which photocopy into perfect black and white.

Print those Lotus® or HP Drawing Gallery graphics—silently and without additional desk space! JetPlotter lets you position, shrink and even expand graphics. You can even use a blue ink-jet printer head and inverse function to simulate blueprints.

JetPlotter is available for the HP Vectra PC and other IBM PC compatibles. Supported by Insight Development Corporation.

35190P JetPlotter ☐ ... \$99.00 ea.

You can "plot" graphics in black and white or single colors, even in large sizes or as simulated blueprints.

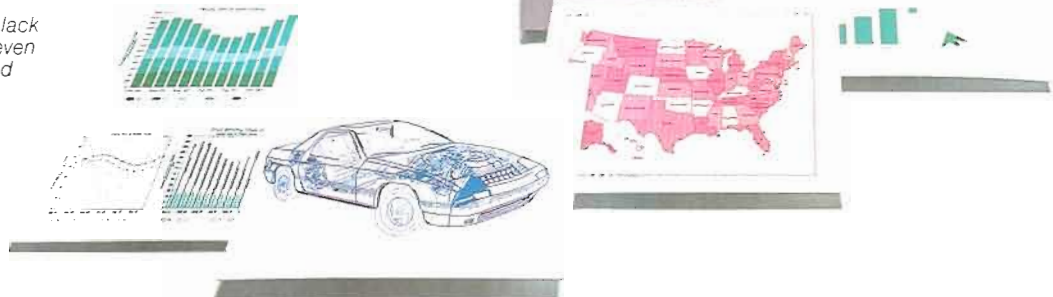

Stack ThinkJet/paper above terminal and save desktop space.

Off your desk and atop your HP 2392A Terminal, this acrylic stand gives you more work surface and maximum use of terminal space.

Lower tier holds approximately 400 sheets of Z-Fold JetPaper. Rear edge is raised to route cables and power cord away from the paper path, and support the 92261R Wire Paper Catcher.

Printer and stand won't interfere with terminal ventilation. Stand also works with the HP 150 II PC, other HP 239x Terminals. Dimensions: 64 H x 325.6 W x 276.9 D mm (2.5 H x 12.7 W x 10.8 D in.).

92171X Terminal-top ThinkJet Stand ☐
(1-2 units) \$59.00 ea.
(3-9) 53.00 ea.

Stack your ThinkJet on your HP 700 Terminal? Yes! In the grip of this sturdy, space-saving stand

Snap this ingenious stand onto your HP 700 Terminal and watch your HP ThinkJet printer do the unthinkable! It moves "upstairs," and suddenly you've got room to work. Your printer's right in front of you—taking zero desk space!

Completely secure at any angle. Custom-designed just for the HP 700, this easy-to-install acrylic stand "grabs" your terminal under tension and can't let go.

Just slide the 38.1mm (1.5 in.) prongs all the way into your terminal's screw-holes and push the stand forward until its lip clicks over the front edge of your terminal.

Then set the ThinkJet on top. Four rubber grippers squeeze the printer snugly so it can't budge. Slide in up to 400 sheets of fanfold paper, and you're set. Now swivel or tilt your terminal to any position. Your printer is 100 percent secure, and you've found the space you need to get things done. Dimensions: 165.1 H x 298.5 W x 304.8 D mm (6.5 H x 11.75 W x 12 D in.).

92269B ThinkJet Printer Stand for HP 700 Terminals
(1-2 units) \$49.00 ea.
(3-9) 46.00 ea.
(10+) 41.00 ea.

Discover new room on your desk! Custom stand holds your ThinkJet safely at any angle, without taking a bit of your workspace.



ThinkJet/QuietJet/QuietJet Plus supplies and accessories

Product no.	Description	Price	Product no.	Description	Price
92261A	JetPaper Print Cartridge, black. 600,000 characters (approx. 500 pages). Fits QuietJet, ThinkJet and QuietJet Plus Printers.	(1-19) \$10.95 ea. (20-99) 10.40 ea. (100+) 9.86 ea.	51630L	Pressure-sensitive, self-adhesive ink-jet labels. Dimensions: 89 x 24mm (3½ x 1½ in.) (241mm or 9½ in. form width). Two across, 2,000 per box, fanfold.	(1-2 boxes) .. \$18.95 ea. (3-11) 17.95 ea. (12+) 16.95 ea.
51604A	Plain Paper Print Cartridge, black. For use on common printer papers. 500,000 characters (approx. 400 pages). Fits QuietJet, ThinkJet and QuietJet Plus Printers.	(1-19) \$10.95 ea. (20-99) 10.40 ea. (100+) 9.86 ea.	92250W	QuietJet Plus dust cover.	(1-2) \$27.00 ea. (3-4) 25.00 ea. (5+) 23.00 ea.
51605B	JetPaper Print Cartridge, blue. 600,000 characters (approx. 500 pages). Fits QuietJet, ThinkJet and QuietJet Plus Printers.	\$12.95 ea.	92250X	QuietJet dust cover.	(1-2) \$20.00 ea. (3-4) 18.00 ea. (5+) 16.00 ea.
51605G	JetPaper Print Cartridge, green. 600,000 characters (approx. 500 pages). Fits QuietJet, ThinkJet and QuietJet Plus Printers.	\$12.95 ea.	92250V	ThinkJet dust cover.	\$19.00 ea.
51605R	JetPaper Print Cartridge, red. 600,000 characters (approx. 500 pages). Fits QuietJet, ThinkJet and QuietJet Plus Printers.	\$12.95 ea.	35178C	ThinkJet carrying case.	\$59.00 ea.
51630A	Z-Fold JetPaper. 500 sheet box. 75g (20 lb.) microperforated. Finished size is 8.5 x 11 in. Fits ThinkJet, QuietJet and QuietJet Plus Printers.	(1-3 boxes) .. \$14.95 ea. (4-23) 13.75 ea. (24+) 13.25 ea.	92261G	Paper catcher for 92261U QuietJet Printer stand and 92261T QuietJet Plus Printer stand. Set catcher on, or suspend at up to a 30° angle from your desk. Dimensions: 64 H x 414 W x 343 D mm (2.5 H x 16.3 W x 13.5 D in.)	(1-2) \$35.00 ea. (3-9) 31.00 ea. (10-49) 28.00 ea. (50+) 25.00 ea.
51630C	Z-Fold JetPaper, 500 sheet box. 75g (20 lb.) microperforated. Finished size is 210 x 297mm. Fits ThinkJet, QuietJet and QuietJet Plus Printers.	Available in Europe only.	92261R	Paper catcher for 92261S ThinkJet Printer stand. Dimensions: 64 H x 305 W x 343 D mm (2.5 H x 12 W x 13.5 D in.)	(1) \$35.00 ea. (2-4) 31.00 ea. (5-9) 28.00 ea. (10-49) 26.00 ea. (50+) 24.00 ea.
92261K	Z-Fold JetPaper, 2500 sheet box. 75g (20 lb.) microperforated. Finished size is 210 x 297mm. Fits ThinkJet, QuietJet and QuietJet Plus Printers.	Available in Europe only.	92261S	ThinkJet Printer stand. Dimensions: 82 H x 298 W x 305 D mm (3.3 H x 11.75 W x 12 D in.)	(1-2) \$49.00 ea. (3-9) 46.00 ea. (10+) 41.00 ea.
92261N	Z-Fold JetPaper. Five individually wrapped 500 sheet packs. (2500 sheets total.) 75g (20 lb.) microperforated. Finished size is 8.5 x 11 in. Fits ThinkJet, QuietJet and QuietJet Plus Printers.	(1-2 boxes) .. \$59.95 ea. (3-10) 57.50 ea. (11-24) 54.95 ea. (25+) 52.95 ea.	92261T	QuietJet Plus Printer stand. Dimensions: 89 H x 533 W x 297 D mm (3.5 H x 21 W x 11.7 D in.)	(1-2) \$84.00 ea. (3-9) 81.00 ea. (10-49) 79.00 ea. (50+) 77.00 ea.
51630B	Z-Fold Wide JetPaper. 500 sheet box. 75g (20 lb.) perforated. Finished size is 14½ x 11 in. Fits QuietJet Plus Printer.	(1-3 boxes) .. \$15.95 ea. (4-23) 14.95 ea. (24+) 13.95 ea.	92261U	QuietJet Printer stand. Dimensions: 89 H x 400 W x 297 D mm (3.5 H x 15.75 W x 11.7 D in.)	(1-2) \$79.00 ea. (3-9) 73.00 ea. (10-49) 69.00 ea. (50+) 66.00 ea.
51630D	Z-Fold Wide JetPaper. 2500 continuous sheet box. 75g (20 lb.) Finished size is 14½ x 11 in. Fits QuietJet Plus Printer.	(1-2 boxes) .. \$75.00 ea. (3-10) 71.00 ea. (11-24) 68.00 ea. (25-63) 65.00 ea. (64+) 56.00 ea.	92171X	Terminal-top ThinkJet Printer stand. Dimensions: 70 H x 320 W x 272 D mm (2.75 H x 12.7 W x 10.8 D in.)	(1-2) \$59.00 ea. (3-9) 53.00 ea. (10+) 49.00 ea.
51630F	Z-Fold Wide JetPaper. 500 sheet box. 75g (20 lb.) Finished size 375 x 305mm. Fits QuietJet Plus Printer.	Available in Europe only.	82199A	ThinkJet battery pack (For use with 2225B/P only)	\$47.00 ea.
51630H	Z-Fold Wide JetPaper, 2500 sheet box. 75g (20 lb.) Finished size 375 x 305mm. Fits QuietJet Plus Printer.	Available in Europe only.	82059D	AC adapter/recharger for HP 2225B/P. (120V)	\$20.00 ea.
51630J	Cut Sheet JetPaper. 500 sheet box. 75g (20 lb.) Finished size is 8.5 x 11 in. Fits ThinkJet, QuietJet and QuietJet Plus Printers.	(1-3 boxes) .. \$12.95 ea. (4-23) 11.95 ea. (24+) 10.95 ea.	82241A	AC adapter for HP 2225CX. (120V)	\$15.00 ea.
51630K	Cut Sheet A4-size JetPaper. 500 sheet box. 75g (20 lb.) 210 x 297mm. Fits ThinkJet, QuietJet and QuietJet Plus Printers.	Available in Europe only.	82241AB	AC adapter for HP 2225CX.	Available in Europe only.
			82066B	AC adapter/recharger for HP 2225B/P. (220V)	\$25.00 ea.
			82068B	AC adapter/recharger for HP 2225P. (Australia)	Available in Europe only.
			17122B	Replacement external power module for U.S. and Canada. 120V/50/60Hz. Use with the PaintJet, DeskJet, QuietJet or QuietJet Plus Printers.	\$66.00 ea.
			17222B	Replacement external power module for Europe. 220V/50Hz. For other countries and different configurations, call for info.	\$66.00 ea.
			35190P	JetPlotter software for ThinkJet, QuietJet and QuietJet Plus Printers.	\$99.00 ea.

Three reasons to choose HP JetPaper

1. HP JetPaper produces the sharpest image. HP JetPaper is specially engineered for printing with HP ink-jet print cartridges. When droplets of ink are "fired" from an ink-jet cartridge, the uniformly laid fibers in the HP JetPaper surface absorb the ink evenly in all directions, facilitate fast ink drying, and prevent the printed characters from smudging, running or blotting.

2. Produces cleaner edges. HP JetPaper features ultra-fine microperforated edges to allow you to cleanly separate each sheet of paper.

3. Enhances printer reliability. HP JetPaper is designed to significantly reduce the amount of floating paper dust which can clog ink-jet cartridges.

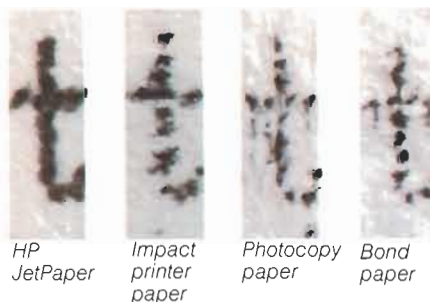



Conserve desktop space

Use this sturdy, color-coordinated printer/PC stand with your HP RuggedWriter 480 Printer, and you can store up to 250 sheets of continuous-feed paper on your desktop. This stand allows your paper to flow from underneath your printer un-hindered by power cords or desktop clutter. The dove gray color is complementary to your printer. Dimensions are 201 H x 612 W x 396 D mm (4.0 H x 24.1 W x 15.6 D in.).

92166A RuggedWriter 480 Printer Stand (or Keyboard Park)
 (1-2) \$99.00 ea.
 (3-9) 95.00 ea.
 (10+) 89.00 ea.

Simplify cut-sheet printing on your HP RuggedWriter 480 Printer (HP 2235 series)

The RuggedWriter 480 Printer lets you print on most any cut-sheet stock, in draft- or letter-quality mode.

Our RuggedWriter 480 sheetfeeder accessory makes this versatility easy. The paper cassette holds up to 100 sheets, while the accessory loads and aligns each page into the printer's carriage for you.

Designed to become an integral part of your printer, this accessory snaps easily and securely into the printer frame and requires no additional space.

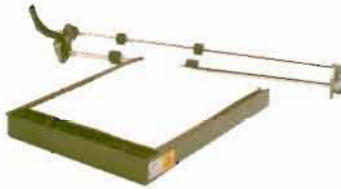

Snap the metal accessory inside, fit the cassette into the rear—takes only moments.

12239A RuggedWriter 480 Sheetfeeder accessory with US letter-size paper cassette (**92285B**) \$250.00 ea.

12239B RuggedWriter 480 Sheetfeeder accessory with European A4-size paper cassette (**92285D**) (Available in Europe only.)

For extra paper trays (**92285B/D**), see page 22.



Customize your RuggedWriter 480 printing

The RuggedWriter 480 font cartridge expands your printing capabilities, to help your letters and reports stand out in a crowd. Included are Prestige Elite 12, Letter Gothic 12, TmsRmn PS and Helv 10. It also features 16K bytes of RAM to allow for downloading and customized font printing, or to be used as additional buffer space.

12235A RuggedWriter Font cartridge \$150.00 ea.

Prestige Elite 12

ABC abc 123 !"#%&'()*+*

Letter Gothic 12

ABC abc 123 !"#%&'()*+*

TmsRmn PS

ABC abc 123 !"#%&'()*+*

Helv 10

ABC abc 123 !"#%&'()*+*

Create crisp, sharp graphics right at your desk with MatrixPlotter



Now you can get black and white graphics from your HP RuggedWriter 480 Printer!

MatrixPlotter lets you produce graphics so clean, your colleagues will think you used a laser printer.

Print when you're ready because MatrixPlotter lets you print multiple files unattended.

Translates Plotter graphics into files that can be output by most any dot-matrix printer, including the HP RuggedWriter, Epson and Toshiba.

Work efficiently because MatrixPlotter lets you print quickly. And it translates color graphics into black-and-white textures sharp enough to photocopy.

MatrixPlotter is compatible with Lotus® 1-2-3®, ChartMaster and other popular software applications, and runs on the HP Vectra PC and IBM PC compatibles. Supported by Insight Development Corp. Available in 5.25 in. discs.

35190R MatrixPlotter Software for dot matrix printers \$99.00 ea.

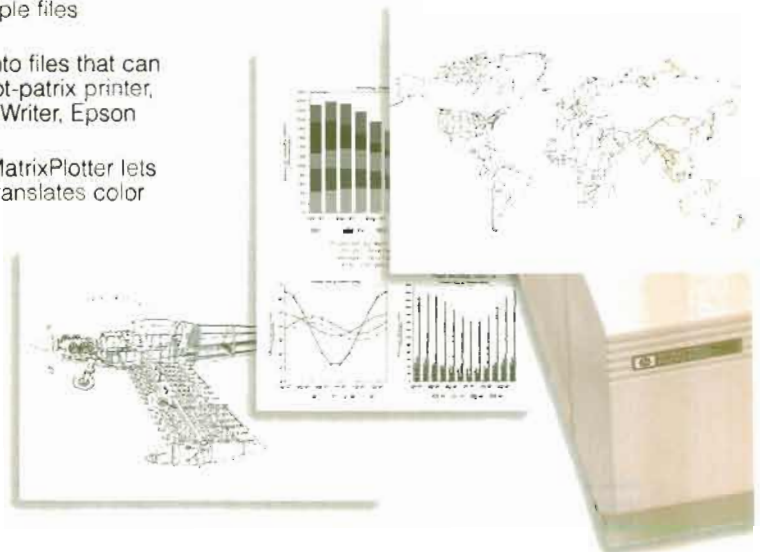

Produce professional-looking graphics from your RuggedWriter, with up to 72 line widths and patterns!

Tempted to switch to another brand of ribbon for your HP printer? Read this first. Learn why ours are the best to use...no matter what else is available!

Why buy HP ribbons for your HP printer when so many other brands are available? Good question. The answer:

HP ribbons work better on your printer They give you the most consistent, problem-free printing, start to finish, time after time, of any ribbon you can buy. And they last millions of characters longer.

The difference is design Engineers who design HP printers spend months perfecting ribbons to work with them.

They specify gearing and carbon/oil ratios so the cartridge

friction matches the torque of the printer ribbon motor, preventing jams.

They match the density of the ribbon weave to the impact of your printhead. And they continue their refinements with every comment they get from our customers.

What's more, we tell you how long your ribbon will last—in writing!—and guarantee it. And our ribbons are just a toll-free telephone call away.

You cared enough to invest in the best printer. Insist on HP ribbons as well. It's the *only* ribbon engineered to make your HP printer a perfect printing system.



HP ribbons give you no "hot spots"

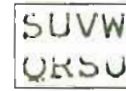

...no "dropouts"



...no overinking or smearing!

The dark truth about ribbons Ribbons need the right balance of solids (carbon) to liquids (oil). Too much solid stalls the ribbon, giving you "drop-outs". Too much oil, and you get solid O's (over-inking) and uneven dark/light areas ("hot spots"). HP ribbons print crisply, smoothly every time.

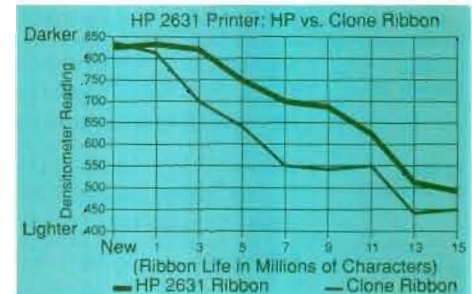

Ours are typically darker at 15 million characters than others at 13 million. Cost less over time!



















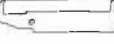





The HP Ribbon Guarantee: Within one year of purchase, your HP printer ribbon will produce crisp, clear, trouble-free print for the number of characters specified in this catalog, or return it and get a new ribbon free!

Impact printer ribbons

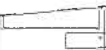
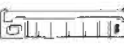
Impact printer model number	Description	Dimensions & measurements	Ribbon life	Unit of measure	Product number	Price
2235A/B/C/D Ruggedwriter 480 Dot Matrix Printers	Ribbon cartridges, continuous feed. Black print.	.75 in. (3/4) ribbon, 29.5 yards	4 million characters	Box of 3	92156S	(1-2 boxes) \$45.00 ea. (3-7) 40.00 ea. (8+) 35.00 ea.
2563A/2563B/2564B Dot Matrix Printers	Ribbon cartridges, mobius loop construction, continuous feed. Blue/black print.*	.75 in. (3/4) ribbon, 100 yards	24 million characters	Box of 3	92158A	(1-2 boxes) \$77.00 ea. (3-7) 69.50 ea. (8+) 62.00 ea.
	Ribbon cartridges, for optical mark recognition applications. Black print.	.75 in. (3/4) ribbon, 100 yards	2.4 million characters	Box of 3	92158M	(1-2 boxes) \$77.00 ea. (3-7) 69.50 ea. (8+) 62.00 ea.
2565A/2566A/2567B/ High Speed Dot Matrix Printers	Wide nylon ribbon. Blue/black print.	15 in. ribbon, 20 yards, .004 in. thick	1 million lines	Each	9282-0545	(1-3 ribbons) \$49.00 ea. (4+) 35.00 ea.
2613A Line Printer (Also 12975A Subsystem)						
2617A Line Printer (Also 13053A Subsystem)						

Chart continued next page.

Impact printer ribbons (continued)

Impact printer model number	Description	Dimensions & measurements	Ribbon life	Unit of measure	Product number	Price
2601A Daisywheel Printer	Multistrike, high-capacity, reel-to-reel ribbon cartridges. Black print. 	.31 in. (5/16) ribbon	235,000 characters	Box of 12 	92151C	(1 box) \$60.00 ea. (2-3) 57.00 ea. (4+) 55.00 ea.
	Fabric, continuous cycle feed ribbon cartridges. Black print. 	.31 in. (5/16) ribbon	800,000 characters	Box of 12 	92151D	(1 box) \$62.00 ea. (2-3) 59.00 ea. (4+) 57.00 ea.
2602A Daisywheel Printer	Multistrike, high capacity reel-to-reel ribbon cartridge. Black print. 	.31 in. (5/16) ribbon	450,000 characters	Box of 12 	92151H	(1 box) \$78.00 ea. (2-3) 74.00 ea. (4+) 71.75 ea.
	Multistrike, high-capacity, reel-to-reel ribbon cartridges. Black print. 	.56 in. (14.3 mm) ribbon, 153 yards	500,000 characters (500 pages)	Each 	92271A	(1-2 boxes) \$18.00 ea. (3-9) 16.40 ea. (10+) 14.80 ea.
2603A Daisywheel Printer	Fabric, continuous cycle feed ribbon cartridges. Black print. 	.56 in. (14.3 mm) ribbon, 43.7 yards	1.2 million characters	Box of 2 	92271E	(1-2 boxes) \$45.00 ea.
	Ribbon cartridges, mobius loop construction, continuous feed. Blue/black print.* 	.75 in. (3/4) ribbon, 100 yards	24 million characters	Box of 3	92158A	(1-2 boxes) \$77.00 ea. (3-7) 69.50 ea. (8+) 62.00 ea.
2608A/S Dot Matrix Printer	Ribbon cartridges, for optical mark recognition applications. Black print. 	.75 in. (3/4) ribbon, 100 yards	3 million characters	Box of 3	92158M	(1-2 boxes) \$77.00 ea. (3-7) 69.50 ea. (8+) 62.00 ea.
	Wide nylon ribbon for normal print applications. Blue/black print.* 	14 in. ribbon, 15 yards, .005 in. thick	1 million lines	Each	1535-3914	(1-2 ribbons) \$36.00 ea. (3-11) 30.00 ea. (12+) 26.00 ea.
2611A Line Printer	Wide nylon ribbon for high-contrast print applications. Black print. 	14 in. ribbon, 18 yards, .004 in. thick	360,000 lines	Each	92230A	(1-2 ribbons) \$52.00 ea. (3-11) 43.00 ea. (12+) 38.00 ea.
	Wide nylon ribbon for normal print applications. Blue/black print.* 	14 in. ribbon, 15 yards, .005 in. thick	1 million lines	Each	1535-3914	(1-2 ribbons) \$36.00 ea. (3-11) 30.00 ea. (12+) 26.00 ea.
2619A Line Printer	Wide nylon ribbon for high-contrast print applications. Black print. 	14 in. ribbon, 18 yards, .004 in. thick	1.2 million lines	Each	92230A	(1-2 ribbons) \$52.00 ea. (3-11) 43.00 ea. (12+) 38.00 ea.
	Ribbon cartridges, mobius loop construction, continuous feed. Black print. 	.75 in. (3/4) ribbon, 55 yards	12 million characters	Box of 3 	92155A	(1-2 boxes) \$60.00 ea. (3-7) 51.00 ea. (8+) 44.00 ea.
2631A/B Dot Matrix Printer 2635A/B Printing Terminal 2639A Printing Terminal	Ribbon cartridges, used with 2631G, opt. 200 only. Black print. 	.75 in. (3/4) ribbon, 55 yards	5000 bar code labels (10 characters each)	Box of 3	92155B	(1-2 boxes) \$65.00 ea. (3-7) 56.00 ea. (8+) 50.00 ea.
2932/33/34A Dot Matrix Printers:	Ribbon cartridges, continuous feed. Black print. 	.75 in. (3/4) ribbon, 50 yards	8 million characters	Box of 3 	92155L	(1-2 boxes) \$72.00 ea. (3-7) 62.00 ea. (8+) 55.00 ea.
2933A/2934A Dot Matrix Printer	OCR ribbon cartridge (used to print bar code). 	.75 in. (3/4) ribbon 50 yards	2 million lines	Box of 3 	92155M	(1-2 boxes) \$79.00 ea. (3-7) 69.00 ea. (8+) 59.00 ea.
44653A for 3065 Board Tester	Ribbon cartridges, continuous feed. Black print. 	.50 in. (1/2) ribbon, 15 yards	1.2 million characters	Box of 2	46295A	(1-2 boxes) \$46.00 ea. (3-7) 44.00 ea. (8+) 36.00 ea.
82905A/B Dot Matrix Printer	Ribbon cartridges, continuous feed. Black print. 	.5 in. (1/2) ribbon, 20 yards	2.4 million characters	Box of 2 	92156A	(1-2 boxes) \$22.00 ea. (3-7) 20.00 ea. (8+) 18.00 ea.
82906A Dot Matrix Printer						

*Blue/Black ink appears black to the eye. The addition of some color tint increases the perceived darkness of the printing as compared to ordinary black ink.

Now...your office paper is just a phone call away!

Why make a special trip to buy office paper when we can send it to you? Ours is quality paper, measuring a standard 216 x 279mm (8.5 x 11 in.) It's practical for typing, photocopying. LaserJet printing and general office use. What's more, you don't have to leave the office to get it—just order it by phone when you call for your other supplies!



Our price is competitive with other high-quality brands, and delivery costs are included in the price. 5,000 sheets per package.

92157L Office Paper	
(1 unit)	\$59.95 ea.
(2)	54.95 ea.
(3-6)	46.76 ea.
(7-39)	42.56 ea.
(40+)	32.97 ea.



Impact Printer Paper

For use with:	Description	Dimensions & measurements	Product number	Price
2235A/B/C/D (Ruggedwriter 480) 2563A/B 2564B 2565A 2566A/B 2567B 2601A 2602A 2603A 2607A 2608A/S 2611A 2613A 2617A 2618A 2619A 2631/35/39 2932A 2933A 2934A 82905A/B 82906A (Must have optional tractor feed mechanism to use 9280-0705 or 9280-0218 papers.)	Fanfold, blank printer paper.	241mm (9.5 in.) 216mm (8.5 in.) 	18 lb. bond, white, 2400 sheets/box 92157A	(1-2 boxes) \$42.00 ea. (3-5) 37.00 ea. (6-11) 35.00 ea. (12+) 33.00 ea.
	Fanfold, 3-hole punched, blank printer paper.	241mm (9.5 in.) 216mm (8.5 in.) 	18 lb. bond, white, 3200 sheets/box 92157B	(1-2 boxes) \$50.00 ea. (3-5) 46.00 ea. (6-11) 44.00 ea. (12+) 42.00 ea.
	Fanfold, microperforated printer paper for high-quality word processing applications.	241mm (9.5 in.) 216mm (8.5 in.) 	20 lb. no. 1 bond, white, 2400 sheets/box 92157C	(1-2 boxes) \$59.00 ea. (3-5) 56.00 ea. (6-11) 54.00 ea. (12+) 52.00 ea.
	Fanfold, blank printer paper Available in Europe only.	241mm (9.5 in.) 210mm (8.25 in.) 	18 lb. bond white, 2400 sheets/box 92157D	
	72-column blank printer paper.	216mm (8.5 in.) 191mm (7.5 in.) 	15 lb. bond, white, 3200 sheets/box 9280-0705	(1-67 boxes) \$47.00 ea. (68+) 40.00 ea.
	80-column green-bar printer paper.	251mm (9.9 in.) 279mm (11 in.) 	15 lb. bond green-bar 0.5 in. (1/2) 3200 sheets/box 9280-0218	(1-51 boxes) \$52.00 ea. (52+) 44.00 ea.
	132-column blue-bar printer paper.	378mm (14.9 in.) 279mm (11 in.) 	18 lb. bond blue-bar 0.5 in. (1/2) 2400 sheets/box 9320-1515	(1-2 boxes) \$55.00 ea. (3-5) 47.00 ea. (6-11) 44.00 ea. (12+) 42.00 ea.

Impact printer supplies

Printer	Description	Product number	Price
2601A	9.5 × 11.6 in. (241 × 295mm) Printwheel storage album. Bone-colored with black accent. Holds six printwheels.	92167W	(1-2 albums) \$13.00 ea. (3-4) 12.00 ea. (5+) 11.00 ea.
	Extra paper trays for HP 26010D sheet feeder. (8.5 × 11 inch)	92177J	(1-2 trays) \$100.00 ea. (3+) 90.00 ea.
	(landscape: 11 × 8.5 inch)	92177K	
	(legal: 8.5 × 14 inch)	92177L	
	(210 × 297mm/A4)	92177M	
	(landscape: 210 × 297mm/A4)	92177N	
	Printwheel clean kit Cleaner box, single element pad, interchangeable wheel holder, and 4 oz. bottle of cleaning solution.	92193C	(1 kit) \$22.00 ea. (2-4) 20.00 ea. (5+) 19.00 ea.
Printwheel clean kit refill 4 oz. bottle of cleaning solution, and single element pad.	92193D	(1-4 refills) \$17.00 ea. (5+) 15.00 ea.	
2602A	305 × 338mm (12 × 13.3 in.) Printwheel storage album. Bone-colored with brown accent. Holds six 98-character printwheels.	92167V	(1-2 albums) \$15.00 ea. (3-9) 12.00 ea. (10+) 10.00 ea.
2608A/S	Package of layout forms. Total 250 sheets on 5 pads.	02608-60091	\$17.00 pkg.
2611A	Individual pre-punched VFU tape. (88 lines/page)	02619-80003	\$10.00 ea.
2613A	Blank VFU tape, self adhesive. 25 blank tapes per package.	4114-0371	(1 pkg) \$41.00 ea.
2617A			(2+) 37.00 ea.
2618A	Package of 3 vacuum bags (min. order 5 packages).	9300-0750	\$4.10 ea.
2619A			
2619A	Chain train oil. 1 oz. bottle.	92230B	\$8.50 ea.
	Chain train oil. 1 qt. refill bottle.	92230C	\$67.50 ea.
2631/A/B/G 2635/39	Replacement print head.	92154G	(1-2 heads) \$185.00 ea. (3+) 160.00 ea.
2932/33/34A Dot Matrix Printers	Replacement print head. Average life is 50 to 100 million characters.	92154B	\$140.00 ea.
	Printout paper catcher. Wire construction, easy mounting.	92171G	(1-2 catchers) \$48.00 ea. (3-9) 42.00 ea. (10+) 38.00 ea.
	Print head. Reliable and user installable. Average life is 50 to 100 million characters.	92154P	\$109.00 ea.
82906A	Print head. User installable. Average life is 50 to 100 million characters.	92154N	\$141.00 ea.
Miscellaneous supplies	12-Channel VFU tape punch. Will punch either six or eight lines-per-inch control tapes. Splicing easy with precision registration pins and hold-down arms on punch. Bidirectional control knob moves tape easily through punch.	92231A	\$225.00 ea.
	Paper perforator tape. Box of 28 Rolls. (Supersedes 9280-0063.) Oiled gray paper tape, 25.4mm (1 in.) Each roll 305m (1000 ft.) long.	92231B	(1 box) \$93.00 ea. (2-4) 81.00 ea. (5-9) 75.00 ea. (10+) 73.00 ea.
	Platen Cleaner Pak™ for all impact printers. Reduces service calls and paper jams by eliminating paper slippage.	92193T	(1 box of 10) \$16.00 ea. (2-5) 14.00 ea. (6+) 11.00 ea.

Call us with your Purchase Orders or



We ship same day

**CALL HP DIRECT
800-538-8787**

Thermal paper for HP computers (see paper styles below)

	Description	Measurements	Unit of Measure	Product number	Price
COMPUTERS/ CALCULATORS	Continuous roll Blue print	108mm (4.25 in.) width 122m (400 ft.) roll length	Box of 2 rolls	82931A	(1-4 boxes) \$33.00 ea. (5+) 29.00 ea.
	Continuous roll Black print	108mm (4.25 in.) width 122m (400 ft.) roll length	Box of 2 rolls	82954A	(1-4 boxes) \$33.00 ea. (5+) 29.00 ea.
125A/B Touchscreen (HP 150)			See 92160A/B thermal paper below.		
9000 Model 520	Fanfold pack Black print U.S. dimensioned	216mm (8.5 in.) width 279mm (11 in.) length 330 sheets per pack	Box of 4 packs	9270-0640	(1 box) \$104.00 ea. (2-5) 95.00 ea. (6+) 92.00 ea.
	Fanfold pack Black print Metric dimensioned.	211mm (8.27 in.) width 297mm (11.69 in.) length 330 sheets per pack	Box of 4 packs	9270-0642*	(1 box) \$104.00 ea. (2-5) 95.00 ea. (6+) 92.00 ea.
9810A 9820A 9821A 5150A	Continuous roll Blue print	57mm (2.25 in.) width 76m (250 ft.) roll length	Box of 6 rolls	9281-0401	(1 box) \$26.00 ea. (2-4) 24.00 ea. (5-19) 23.00 ea. (20+) 19.00 ea.
	Continuous roll Blue print	57mm (2.25 in.) width 76m (250 ft.) roll length	Box of 6 rolls	9270-0479	(1 box) \$35.00 ea. (2-4) 33.00 ea. (5-19) 30.00 ea. (20+) 28.00 ea.
	Continuous roll Black print	57mm (2.25 in.) width 76m (250 ft.) roll length	Box of 6 rolls	9270-0664*	(1 box) \$35.00 ea. (2-4) 33.00 ea. (5-19) 30.00 ea. (20+) 28.00 ea.
	Page-perforated roll. Black print. High-contrast. U.S. dimensioned.	216mm (8.5 in.) width 279mm (11 in.) length 61m (200 ft.) roll length	Box of 6 rolls	92161E	(1 box) \$106.00 ea. (2-5) 102.50 ea. (6+) 99.00 ea.
9845A/B/C/S/T	Continuous roll. Blue print. High-contrast. Metric dimensioned.	210mm (8.27 in.) width 60m (197 ft.) roll length	Box of 6 rolls	92181N*	(1 box) \$79.50 ea. (2-5) 77.50 ea. (6+) 75.50 ea.
	Continuous roll. Black print. High-contrast. Metric dimensioned.	210mm (8.27 in.) width 60m (197 ft.) roll length	Box of 6 rolls	92161P*	(1 box) \$79.50 ea. (2-5) 77.50 ea. (6+) 75.50 ea.
	Page-perforated roll. Black print. High-contrast. Metric dimensioned. Horizontal perforation only	210mm (8.27 in.) width 297mm (11.69 in.) length 60m (197 ft.) roll length	Box of 6 rolls	92161R*	(1 box) \$106.00 ea. (2-5) 102.50 ea. (6+) 99.00 ea.
	Continuous roll Blue print U.S. dimensioned	216mm (8.5 in.) width 30.5m (100 ft.) roll length	Box of 24 rolls	92160A	(1-2 boxes) \$137.00 ea. (3-23) 126.00 ea. (24+) 122.00 ea.
PRINTERS/ CALCULATORS 2671A 2671G 2673A 2674A	Continuous roll Black print U.S. dimensioned	216mm (8.5 in.) width 30.5m (100 ft.) roll length	Box of 24 rolls	92160B	(1-2 boxes) \$137.00 ea. (3-23) 127.00 ea. (24+) 122.00 ea.
	Fanfold pack Blue print U.S. dimensioned	216mm (8.5 in.) width 279mm (11 in.) length 330 sheets per pack	Box of 4 packs	92160M	(1 box) \$104.00 ea. (2-5) 95.00 ea. (6+) 92.00 ea.
	Fanfold pack Black print U.S. dimensioned	216mm (8.5 in.) width 279mm (11 in.) length 330 sheets per pack	Box of 4 packs	92160N	(1 box) \$104.00 ea. (2-5) 95.00 ea. (6+) 92.00 ea.
	Page-perforated roll Black print Metric dimensioned	241mm (9.5 in.) width outside perforation 210mm (8.27 in.) width inside perforation 296.5mm (11.75 in.) length, 61m (200ft.) roll length	Box of 2 rolls	9270-0607*	(1-5 boxes) \$45.00 ea. (6-35) 43.50 ea. (36+) 41.50 ea.
7240A 7245B	Page-perforated roll Black print U.S. dimensioned	241mm (9.5 in.) width outside perforation 216mm (8.5 in.) width inside perforation 279mm (11 in.) length, 61m (200ft.) roll length	Box of 2 rolls	9270-0605	(1-5 boxes) \$45.50 ea. (6-35) 43.50 ea. (36+) 41.50 ea.
	Continuous roll Black print Metric dimensioned	210mm (8.27 in.) width 75m (246 ft.) roll length	Box of 6 rolls	9270-0680*	(1-4 boxes) \$137.00 ea. (5-29) 131.00 ea. (30+) 125.00 ea.
97A, 82143A, 82162A	Continuous roll Black print U.S. dimensioned	216mm (8.5 in.) width 75m (246 ft.) roll length	Box of 6 rolls	9270-0682	(1-4 boxes) \$137.00 ea. (5-29) 131.00 ea. (30+) 125.00 ea.
	Continuous roll, Blue print	57mm (2.25 in.) width, 24m (80 ft.) roll length	Box of 6 rolls	82645A	\$12.00 ea.
82143A, 82162A, 18C	Continuous roll, Black print	57mm (2.25 in.) width, 24m (80 ft.) roll length	Box of 6 rolls	82175A	\$12.00 ea.
9866A/B HP 12996 Subsystem	Continuous roll Black print	232mm (8.75 in.) width 76m (250 ft.) roll length	Box of 6 rolls	9270-0488	(1 box) \$93.00 ea. (2-4) 85.00 ea. (5-19) 76.00 ea. (20+) 70.00 ea.
9876A	See 9270-0640 and 9270-0642 thermal paper above.				
TERMINALS 262X, 2675A	See 92160A/B thermal paper above.				
3075A, 3076A, 3077A	See 82045A and 82175A thermal paper above.				

*These metric papers are in inventory in our European warehouse. For faster delivery, U.S. customers should order from their local HP Sales Office.

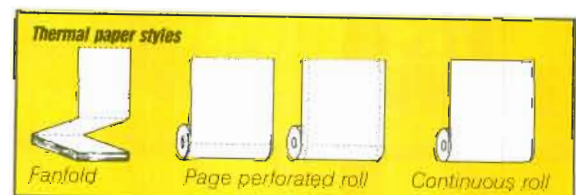

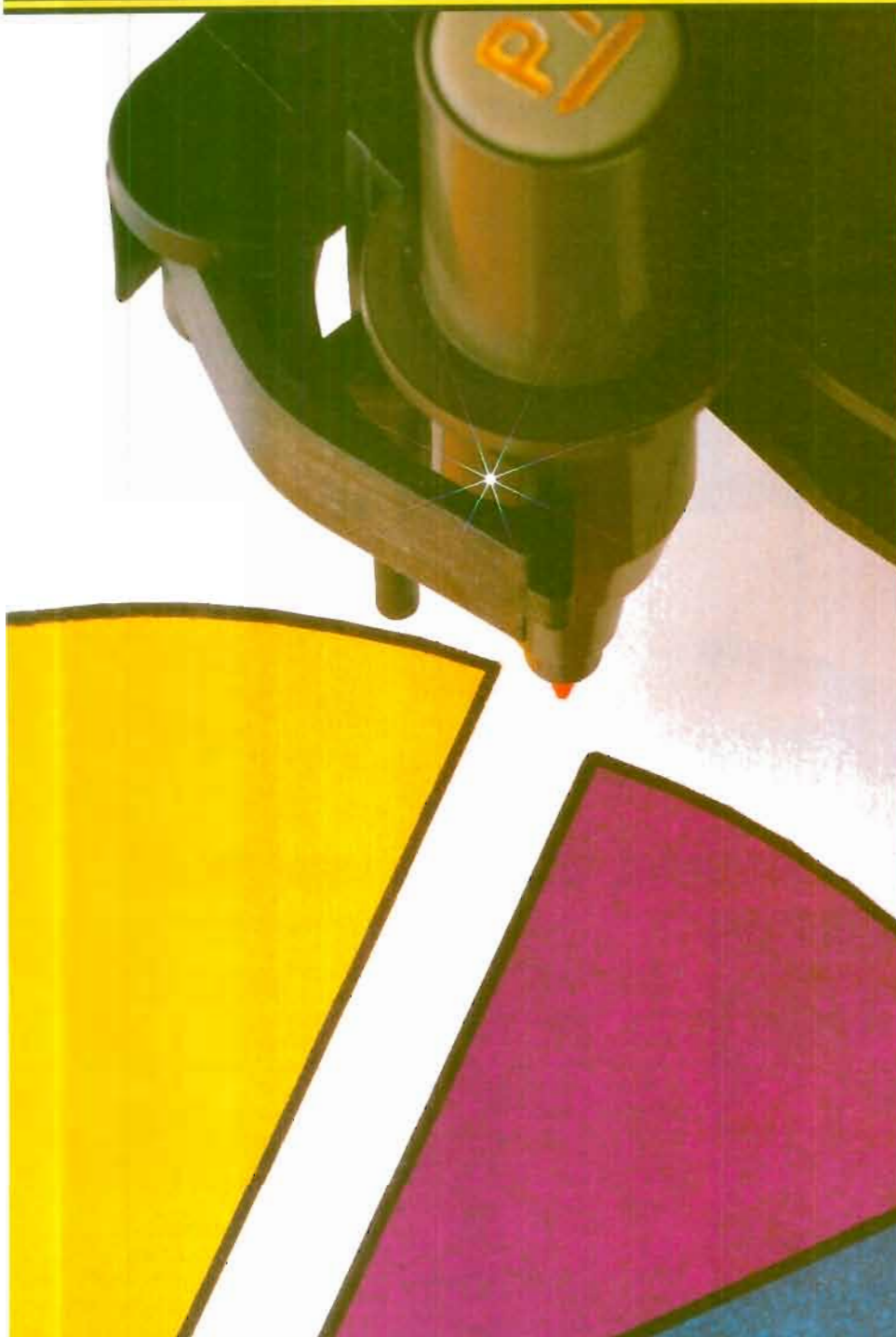

HP graphics plotters—their technological excellence is evident in the color graphics they produce—charts with evenly aligned edges, smooth curves, brilliant colors. These results are possible because HP pens and media are designed to work specifically with HP plotters. Discover our complete line of supplies in this section.

Plotter media	49
Plotter pens	52
HP ColorPro 7440A Graphics Plotter	54
HP 7475A Graphics Plotter	55
Plotter organizers, enclosures and accessories	56, 57, 64
Drafting media	58
Drafting pens	59
HP Electrostatic Plotter supplies	62

HP supplies make the difference

HP plotters, like other HP equipment, run best when they're supported by genuine HP supplies. From refillable pens to the plotter sound enclosure, each plotter supply goes through a comprehensive development phase with a group of engineers dedicated to producing superior products. The commitment to that kind of

rigorous testing has repeatedly proven itself with a reputation for quality plots for both visual and print presentations. Let HP plotter supplies make the most of your HP plotter. We guarantee you'll see the difference.



You've made a sound investment in an HP plotter—now don't use anything less than HP supplies to get the finest results!

Are your supplies where you want, when you want them?



7475A graphics organizer features an easy-access drawer with convenient slots for carousels, paper, pens and other supplies. (Supplies shown in photo are not included.)

HP plotter users: Say goodbye to desktop plotter clutter with HP's Graphics Organizer.

Space-saving. Using your Graphics Organizer as a stand for your 7550, 7475A, or ColorPro Plotter gives you convenient drawer space underneath, so plotter supplies stay out of sight until needed. Lined with a cushion of high-density foam, the easy-access drawer has specially sized compartments to separate and protect supplies.

Everything in place. The specially designed media compartment keeps your standard paper, glossy plotter paper, and transparency film ready for use. Additional compartments hold your pens and carousels. There's even room for odds and ends—pencils, paper clips, scratch pads, etc.

HP's Graphics Organizer is constructed of tough acrylic plastic, in translucent gray to complement your HP plotter.

92177X 7475A Graphics Organizer. Exterior dimensions: 95 H x 597 W x 375 D mm (3.75 H x 23.5 W x 14.75 D in.) \$179.00 ea.

92177W ColorPro Graphics Organizer. Exterior dimensions: 95 H x 476 W x 349 D mm (3.75 H x 18.75 W x 13.75 D in.) \$119.00 ea.

92177Y 7550A Graphics Organizer. Exterior dimensions: 157 H x 673 W x 456 D mm (6.19 H x 26.50 W x 17.94 D in.) \$229.00 ea.



Choose the best combination of supplies for your plotter and application

Use the handy guides below to select the type of pen and paper you need, then see the following pages for ordering information. Remember, exceptional plots are the combined results of an excellent plotter and excellent supplies.

Media and pen compatibility

Use the guide below to select the right type of plotter pen for your application.

Media type	Fiber-tip pens		Drafting pens		Rollerball pens
	Paper	Transparency	Refillable	Disposable	
Plotter paper	•			•	•
Transparency film		•			
Glossy paper	•	•			
Tracing bond					•
Vellum			•	•	
Polyester film			•	•	



See our low-cost plotters, pages 54–55.

Media sizes

Look for these media size codes on the following pages. Each code corresponds to media dimensions listed below.

ANSI (English)	Dimensions Inches Millimeters	A 8.5 × 11 216 × 279	B 11 × 17 279 × 432	C 17 × 22 432 × 559	D 22 × 34 559 × 864	E 34 × 44 864 × 1118
ISO (Metric)	Dimensions Inches Millimeters	A4 8.27 × 11.69 210 × 297	A3 11.69 × 16.54 297 × 420	A2 16.54 × 23.39 420 × 594	A1 23.39 × 33.11 594 × 841	A0 33.11 × 46.81 841 × 1189
Architectural	Dimensions Inches Millimeters	C 18 × 24 457 × 610	D 24 × 36 610 × 914	Other* 30 × 42 762 × 1067	E 36 × 48 914 × 1219	

*HP DraftMaster only

Media and plotter compatibility

Use the guide below to identify the media types and sizes supported by your plotter.

Plotter model number	Plotter paper size								Vellum size					Polyester film size						Tracing bond size		Trans. plotter film					
	ANSI		A	B	C	D	E	11" roll	Arch. 30 × 42 in.	24 & 36 in. roll	A	B	C	D	E	Arch. 30 × 42 in.	24 & 36 in. roll	A	B	C	D		E	D	E	A	
	A4	A3	A2	A1	A0	297 mm roll	A4	A3			A2	A1	A0	A4	A3			A2	A1	A0	A1		A0	A4			
7090A	•	•																								•	
7220A/C, 7221A/B/C, 9872A/B/C	•	•									•	•						•	•							•	
7220S/T, 7221S/T, 9872S/T	•	•					•				•	•						•	•							•	
7225A/B, ColorPro, 7470A	•																									•	
7475A	•	•																•	•							•	
7550A	•	•									•	•						•	•							•	
DraftPro			•	•																							
DraftPro DXL	•	•	•	•							•	•	•	•				•	•	•	•					•	
DraftPro EXL	•	•	•	•	•						•	•	•	•				•	•	•	•					•	
DraftMaster I	•	•	•	•	•			•			•	•	•	•	•			•	•	•	•					•	
DraftMaster II	•	•	•	•	•			•			•	•	•	•	•			•	•	•	•					•	
7580A/B	•	•	•	•							•	•	•	•				•	•							•	
7585A/B	•	•	•	•	•			•			•	•	•	•	•			•	•	•	•					•	
7586B	•	•	•	•	•			•			•	•	•	•	•			•	•	•	•					•	

Choose the right paper and film for your pens

Use HP media for top-quality graphics. Pen life and plot quality are dependent on matching the pens with the media. Therefore, we manufacture our own pens and select our media carefully.

Using HP pens and media assures you of:

- Low abrasion paper matched to our pen tips and ink combinations for increased pen life.
- Smooth surface for consistent lines.

- Paper fiber content and type strictly specified to prevent fibers from pulling ink outside of trace.
- No watermarks on paper to interfere with pen writing.

Whether your application is drafting or business, HP has the solution you need. For your business graphics needs, try our:

- **Plotter Paper** for vivid, professional-looking graphics that will impress your clients and superiors.
- **Transparency Plotter Film** for high quality projected graphics. Excellent for use on overhead projectors at meetings and presentations.
- **Plotter Paper** that's ideal for your everyday graphics needs including preliminary drawings in drafting applications.

For your drafting applications, try our:

- **Polyester Film** for your final-quality, diazo-reproducible, and permanent storage needs.
- **Vellum** for your final-quality, diazo-reproducible needs.
- **Tracing Bond** for your preliminary drawing, and diazo-reproducible review copies.

See the difference HP paper makes

The comparison photos below were made using the American Optical System at 18.75 magnification. The plots were made on a 7470A Plotter at 20 cm/s with a .3mm blue pen. Notice how the HP paper's smooth surface enhances line definition, and minimizes skipping, bleeding and feathering.



Copier paper

HP paper

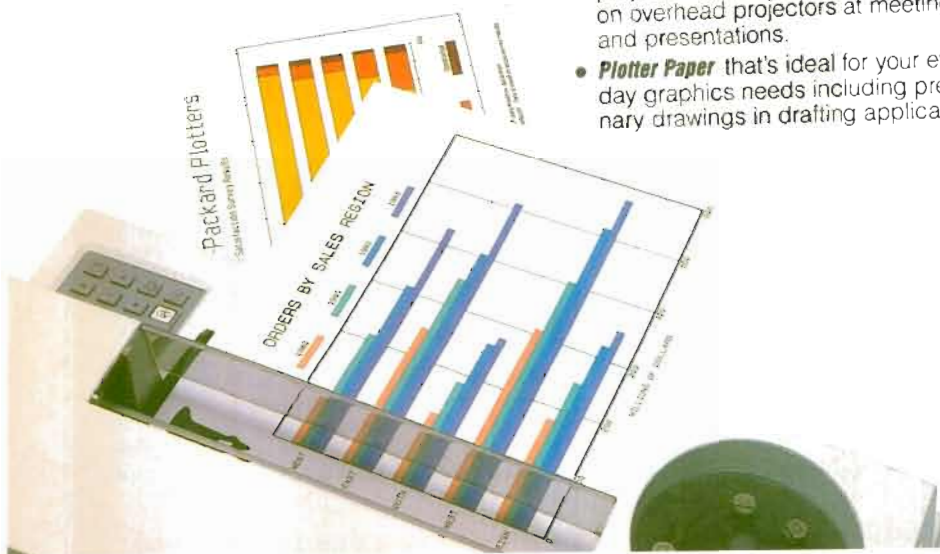

Plotter Paper

HP's strict specifications require this paper to be an opaque medium with the correct mixture of wood pulp and rag fibers. This provides the correct smoothness for clear line definition and minimizes skipping, bleeding and feathering. Use with HP paper pens, rollerball pens and disposable drafting pens. It's inexpensive, easy-to-handle and perfect for everyday use.

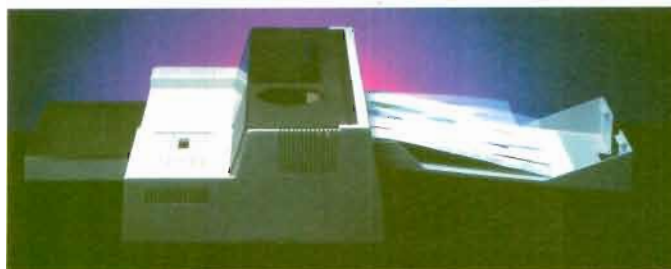

For automatic sheet-feed plotting, see the HP 7550A media catcher tray on page 56.

Media Size	Qty./pkg.	Product no.	Price	
English	A	50 sheets	17800P (1-4) ... \$ 5.50 ea.	
		250 sheets	17801P (5-30) ... 4.95 ea.	
			(31+) ... 4.40 ea.	
	B	50 sheets	17804P	\$ 10.00 ea.
		250 sheets	17805P	26.00 ea.
	C	250 sheets	9280-0728	\$ 41.00 ea.
D	200 sheets	9280-0527	\$ 60.00 ea.	
E	150 sheets	9280-0587	\$ 85.00 ea.	
Metric	A4	50 sheets	17802P \$ 5.50 ea.	
		250 sheets	17803P 13.00 ea.	
	A3	50 sheets	17806P \$ 10.00 ea.	
		250 sheets	17807P 26.00 ea.	
	A2	250 sheets	9280-0734 \$ 41.00 ea.	
	A1	200 sheets	9280-0528 \$ 60.00 ea.	
A0	150 sheets	9280-0590 \$ 85.00 ea.		
Roll	24 in. x 150 ft.	1 roll	9280-0638 \$ 26.00 ea.	
	36 in. x 150 ft.	1 roll	9280-0637 \$ 36.00 ea.	
Architectural	Arch. C	200 sheets	9280-0754 \$ 40.00 ea.	
	Arch. D*	200 sheets	9280-0759 \$ 66.00 ea.	
	30 in. x 42 in.**	200 sheets	9280-0752 \$ 95.00 ea.	
	Arch. E	200 sheets	9280-0751 \$124.00 ea.	

**D"-size architectural media is not recommended on the DraftPro plotter with software programs that do scaling.

**HP DraftMaster only

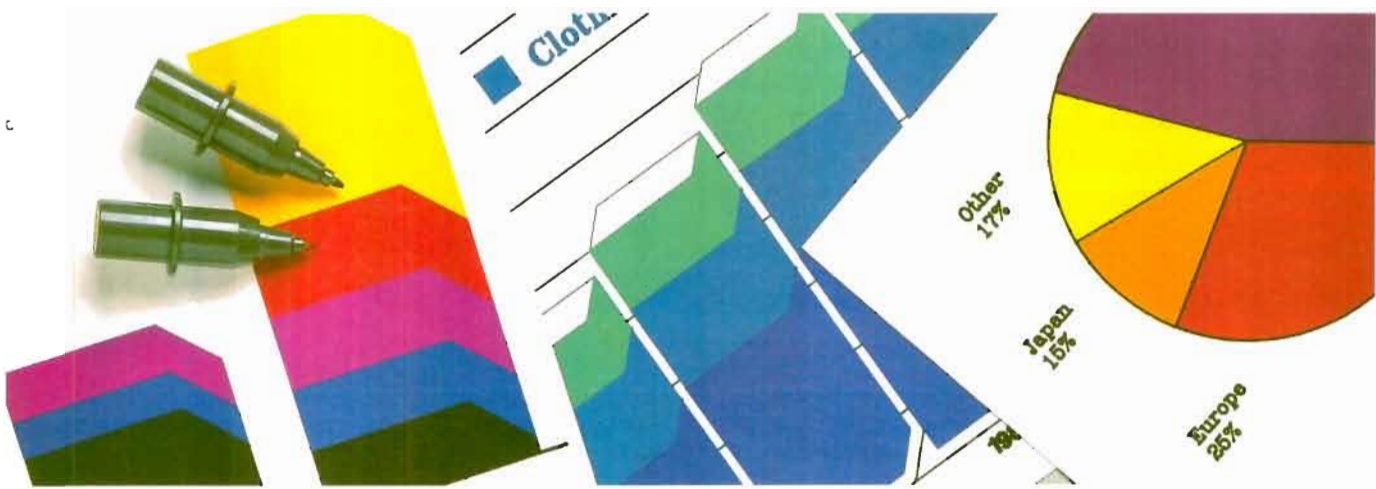

Transparency Plotter Film

Make your presentations stand out from the rest with HP's eye-catching colors and transparency film. Our fast-drying film lets ink dry quickly, minimizing bleeding and smearing. Use with HP transparency plotter pens.

Plotter	Media size*	Qty./pkg.	Product no.	Price
ColorPro (7440), 7470	A English	50 sheets	17700T	(1-9) \$50.00 ea. (10-49) 45.00 ea. (50-99) 40.00 ea. (100-500) 37.50 ea. (501+) 32.50 ea.
	A4 Metric	50 sheets	17701T	(1-9) \$50.00 ea. (10-49) 45.00 ea. (50-99) 40.00 ea. (100-500) 37.50 ea. (501+) 32.50 ea.
7475, 7550, DraftMaster, 7090, 7220, 7221, 7225, and 9872	A English	50 sheets	17702T	(1-9) \$50.00 ea. (10-49) 45.00 ea. (50-99) 40.00 ea. (100-500) 37.50 ea. (501+) 32.50 ea.
	A4 Metric	50 sheets	17703T	(1-9) \$50.00 ea. (10-49) 45.00 ea. (50-99) 40.00 ea. (100-500) 37.50 ea. (501+) 32.50 ea.

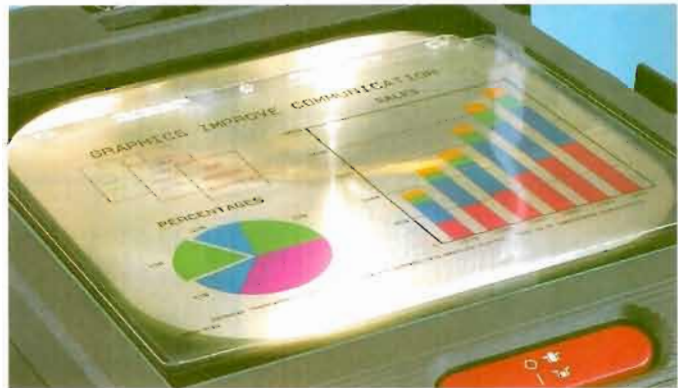

Transparency Sleeves

HP now offers sleeves for your overhead transparencies. These clear protective sleeves allow easy handling during your presentations and can be used again and again. They are three hole punched to fit neatly in a binder for easy transportation to meetings or long term storage.

Media size*	Qty./pkg.	Product no.	Price
English A	50 sheets	17710A	(1-9) \$26.00 ea. (10-49) 23.50 ea. (50-99) 20.80 ea. (100-500) 19.50 ea. (501+) 16.90 ea.

HELPFUL IDEA!

Visual presentations are always stronger
Whether you're speaking to a small or large audience, overheads take minimal time to prepare. Consider these tips when creating your next visual presentation:

- Make sure your presentation has a clear theme.
- Keep your message simple.
- Use color for special emphasis.
- Use ample slides to illustrate key points.
- Keep your formats consistent.
- Be sure everything can be easily recognized by your audience.

Glossy Plotter Paper

Impress your clients and your boss at your next meeting with reports and handouts containing high quality crisp graphics. HP's heavyweight, gloss-finish plotter paper provides the capability for producing professional looking reports. Use with HP paper pens to produce lighter shades of color and with transparency pens to produce darker shades. Use glossy plotter paper for bar code paper applications.

Media size*	Qty./pkg.	Product no.	Price
English A	100 sheets	17900G	(1-9) \$16.00 ea. (10+) 14.40 ea.
	100 sheets	17902G	\$28.00 ea.
Metric A4	100 sheets	17901G	\$16.00 ea.
	100 sheets	17903G	\$28.00 ea.

*See media size guide on page 49 for further information.

More colors for your graphics

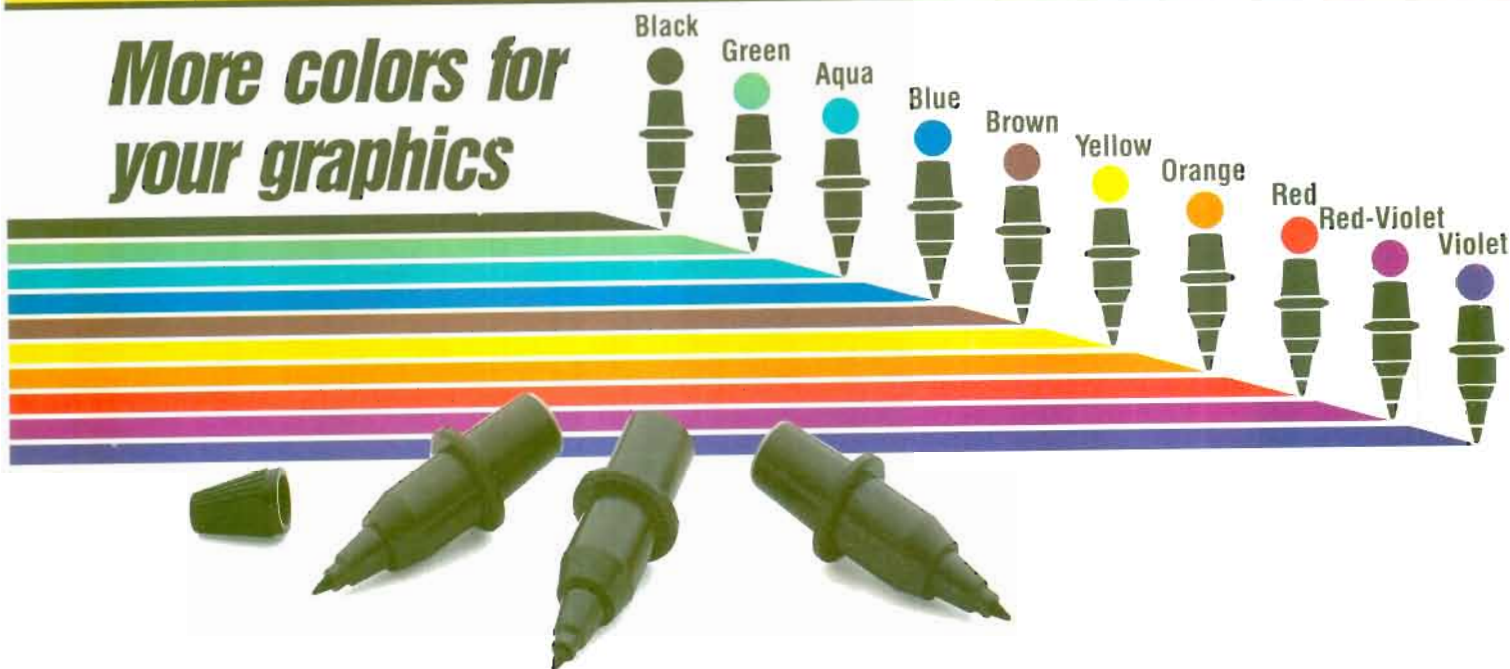

A rainbow of colorful pens and media to match give personality to your presentations!

The vibrance of violet, the brilliance of blue, the radiance of red and many more majestic colors are at your fingertips with HP's variety of plotter pens. Filling your presentations with the polish of color shows creativity, and a conscious effort to make your work stand out.

10 attractive colors

Give your hardcopy graphics that extra professional edge with HP's family of matching paper and transparency pen colors. Carefully chosen to work together harmoniously, all 10 colors are available in both narrow and wide line widths.

High quality ink formulations for long pen life

HP's paper and transparency pens provide optimum density and color consistency, with maximum writing distance.

Customize orders with single color packs

Choose just the colors you want. Select from all 10 colors in narrow-line width and wide-line width to order single-color packs of your own choice. Plus, because of your requests, we've just added 6 colors: Aqua, Violet, Brown, Yellow, Orange and Red-Violet; to our wide-line width single-color pen packages. See the chart at right for details.

Total writing system

HP pens, media and plotters are designed to work together for optimum results. Use our compatibility guides to choose the best complement of supplies for your plotter and application.

HELPFUL IDEA!

Capture them with color!

- **Use color to differentiate.** Be bold and choose colors with high contrast to help your audience make comparisons.
- **Use color to emphasize.** Draw attention to that important statistic or issue with a unique use of color.
- **Use color to identify.** Make your charts easy to understand by using color to visually portray parallel levels of information.
- **Use color wisely.** Too much color can distract your audience from your important message. We recommend to use no more than five colors for charts with graphs. For text only, stick with the attractive simplicity of black plus one other color.

International pen carousel systems

Below you'll find HP's six pen types and their corresponding international pen symbols. A symbol appears on the top of pen carousels, so it's easy for you to make the right match.



Paper Transparency Rollerball Refillable Disposable Vellum Disposable Polyester Film

Steal the show with HP's dazzling pen colors

Make your next presentation shine with HP's family of matching paper and transparency pen colors. Choose from 10 beautiful, professional-looking colors—each guaranteed to give your graphics plenty of audience appeal. These fiber-tip pens are especially suited to area-fill applications.

Fiber-tip paper pens



For use with 7090, 7220, 7221, 7225, ColorPro (7440), 7470, 7475, 7550, DraftPro (7570), DraftMaster, 7580, 7585, 7586, and 9872 Graphics Plotters.

Color selection

The fiber-tip paper pens at left and the fiber-tip transparency pens at right are both available in the colors shown below.

Fiber-tip transparency pens



For use with HP 7090, 7220, 7221, 7225, 7470, 7475, 7550, ColorPro (7440), DraftMaster and 9872 Graphics Plotters.

P3 Narrow line (0.3 mm) HP part no.	P7 Wide line (0.7 mm) HP part no.	Single-color packages (5 pens/packages)	T3 Narrow line (0.3 mm) HP part no.	T6 Wide line (0.6 mm) HP part no.
17825P	17826P	Black	17725T	17726T
17827P	17828P	Green	17727T	17728T
17829P	<i>new!</i> 17830P	Aqua	17729T	<i>new!</i> 17730T
17831P	17832P	Blue	17731T	17732T
17833P	<i>new!</i> 17834P	Violet	17733T	<i>new!</i> 17734T
17835P	<i>new!</i> 17836P	Brown	17735T	<i>new!</i> 17736T
17837P	<i>new!</i> 17838P	Yellow	17737T	<i>new!</i> 17738T
17839P	<i>new!</i> 17840P	Orange	17739T	<i>new!</i> 17740T
17841P	17842P	Red	17741T	17742T
17843P	<i>new!</i> 17844P	Red-Violet	17743T	<i>new!</i> 17744T

P3 Narrow line (0.3 mm) HP part no.	P7 Wide line (0.7 mm) HP part no.	Multi-color packages (1 pen in each color. 5 pens/package)	T3 Narrow line (0.3 mm) HP part no.	T6 Wide line (0.6 mm) HP part no.
17845P	17846P	Black, Blue, Red, Green, Yellow	17745T	17746T
17847P	17848P	Black, Blue, Aqua, Violet, Green	17747T	17748T
17849P	17850P	Brown, Yellow, Orange, Red, Red-Violet	17749T	17750T

(1-4 pkgs) \$7.00 pkg. (25-100) 5.60 pkg. (151+) 4.90 pkg.
 (5-24) 6.30 pkg. (101-150) 5.25 pkg. Price breaks apply to purchase of single product numbers only.

Pen and Plotter compatibility (Use the guide below to select the pens best suited to your plotter.)

Plotter model no.	Fiber-tip pens		Disposable drafting pens	Refillable drafting pens		Rollerball pens
	Paper	Transparency	Long body	Short body	Long body	Long body
7220, 7221, 9872	•	•		•		
7225	•	•				
ColorPro 7220, 7470, 7090	•	•				
7475	•	•		•		
7550, DraftMaster	•	•	•		•	•
DraftPro Series	•		•		•	
7580, 7585, 7586	•		•		•	•

Add vivid colors to your business graphics

Hewlett-Packard has combined advanced technology and improved packaging into the HP ColorPro 7440A graphics plotter—at an affordable price.

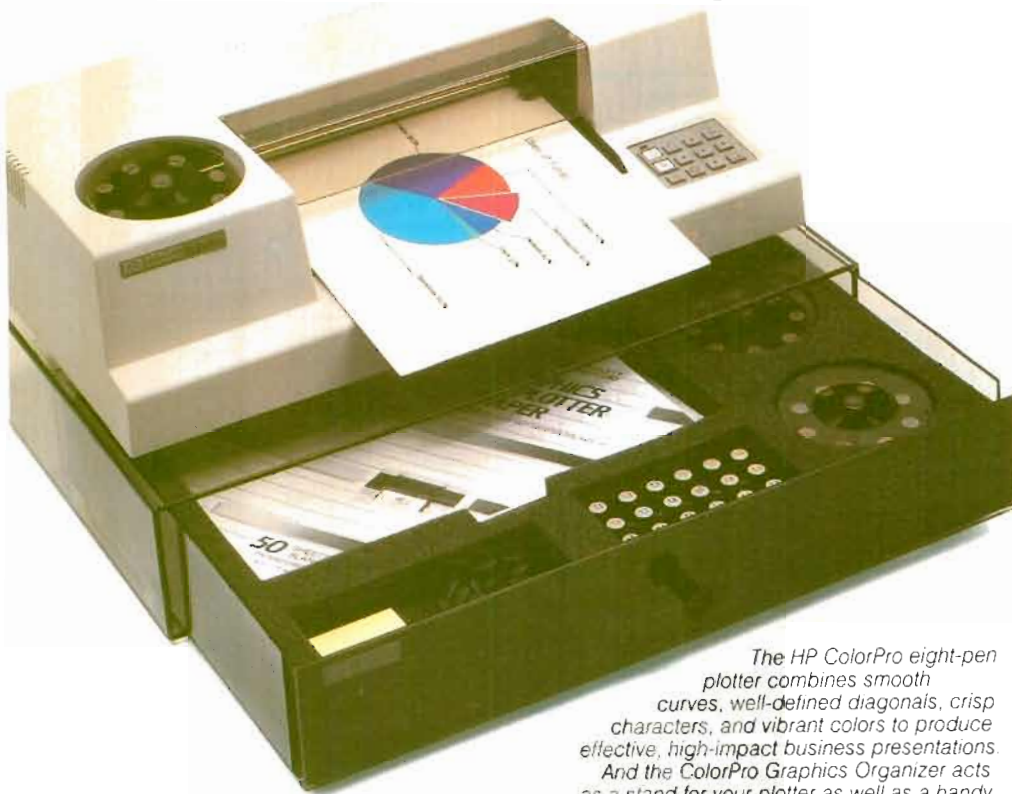

The HP ColorPro eight-pen plotter combines smooth curves, well-defined diagonals, crisp characters, and vibrant colors to produce effective, high-impact business presentations. And the ColorPro Graphics Organizer acts as a stand for your plotter as well as a handy hideaway for your supplies! For more details, see page 48.

The eight-pen HP ColorPro allows you to create high-quality color graphics on either paper or transparency film quickly and easily—right at your own personal computer workstation. No more drawing or typing original charts yourself; no more bargaining with the in-house art department; no more rush charges from outside graphics services.

Colors make the mark. Choose from HP's variety of fiber-tip pens for paper and transparency plotter film, each available in two line widths for bold and fine lines. Make your statement with color and HP's ColorPro plotter will create the professional finish that will make you look impressive.

The ColorPro pays attention to detail. You know the value of quality, and the ColorPro plotter is designed and manufactured to give your presentation materials the look of professionalism you demand.

While others may be satisfied with printer output, the ColorPro plotter offers precision and accuracy—right down to the smallest details like smooth circles, straight diagonal lines, and crisp characters.

Versatility. The ColorPro plotter is easy to use and compatible with your personal computer—from the Apple II™ to the IBM PC™, the Compaq™ Deskpro to the HP Touchscreen II (HP 150 II) and the HP Vectra PC.

The HP ColorPro plotter for your future needs. As your graphics needs expand, the Graphics Enhancement Cartridge, available as an accessory, will add more advanced capabilities to your ColorPro plotter, such as a larger RS232C buffer (from 60 to at least 1024 bytes) and handshaking similar to the HP 7475A. Also, the Graphics Enhancement Cartridge will let you run virtually any software program written for the HP 7475A—particularly packages for technical applications and mainframe graphics—on your ColorPro plotter! What's more, you will have more than 50 HP-GL (Hewlett-Packard Graphics Language) commands available if you choose to write your own programs.

Be sure to order the correct option, along with any necessary cables.

- 7440A Opt. 001** ColorPro plotter (RS232C/CCITT V.24) \$1,295.00 ea.*
- Opt. 002** (HP-IB) (IEEE 488-1978) \$1,295.00 ea.*
- 17440A** Graphics Enhancement Cartridge . . . \$150.00 ea.*
- 07440-00005** Additional 8-pen carousel** \$24.00 ea.
- 02177W** ColorPro Graphics Organizer \$119.00 ea. (see page 48)

"The plotter graphs are very neat and precise. This is important because if my presentations look good, I look good."

Bill Harwick,
 Business analyst
 Italian Swiss Colony Wine of California, Inc.

Warranty and post-warranty services for HP plotters are available from more than 100 HP sales offices in the U.S. Call (800) 835-4747 for more information.

The HP ColorPro Plotter does not have eavesdrop capability.

*Sorry, but quantity, contract, or other discount do not apply to this special off-the-shelf service.

**Extend pen life. When your plotter is not in use, remove pens from the carousel and store them capped.

HP's 92166E Plotter Sound Enclosure can protect as well as reduce the sound of your HP ColorPro (7440), 7470 or 7475 Plotter. For more details, see page 57.

Media sizes

- 8½ × 11 in. (ANSI A)
- 210 × 297 mm (ISO A4)

Media

- Paper (regular or glossy)
- Fast-drying transparency plotter film

Pens

- Number—8, automatic pen changing and capping
- Type—Fiber-tip (paper or transparency)

Resolution

- 0.025 mm (0.001 in.)

Pen Acceleration

- Approximately 1.2 g's

Pen Speed

- 40 cm/s (15.7 in./s)

Interfaces

- RS232C/CCITT V.24 or HP-IB (IEEE 488-1978)

High quality graphics that boast accuracy and precision

Add the HP 7475A graphics specialist to your technical team and you will find out why businesses around the world use the HP 7475A more than any other plotter on the market.

Whether you work in R & D, design or manufacturing, you can rely on the HP 7475A to give you precise, high-quality reproductions and drawings to meet your technical needs. The HP 7475A can easily handle your most difficult assignments—from architectural designs and mechanical drawings to measurement graphs and organizational charts.

In addition to creating 8½ × 11-inch charts and graphs, the HP 7475A is ideally suited for 11 × 17-inch drawings such as time lines, PERT charts, schematics, engineering drawings, project schedules and flow charts.

Drafting-needs bonus. Our liquid-ink drafting pens are specifically designed for our HP 7475A. Use them with durable, double-matte polyester film for the highest quality drafting results and reproductions.

Software plus. When it comes to software, the HP 7475A is one of the world's most widely supported plotters. Choose from hundreds of packages for a variety of technical and business applications—packages that will run on personal, desktop, mini or mainframe computers.

See your dealer for the right software for your technical or business needs.

A business graphics bonus. The HP 7475A is both a technical and business graphics specialist.

Not only will you be able to produce large scale drawings such as PERT charts, scattergrams or CAD drawings, you'll also be able to create colorful text, pie, bar and line charts. Create your high quality graphics on either paper, glossy paper or transparency film.

In addition, the HP 7475A has an easy-to-use front panel that will allow you to test pen colors, position your media to fit horizontal or vertical formats, scale or digitize points and run a built-in demo plot.

Quality with the technical advantage. The HP 7475A has outstanding accuracy and precision. It draws ruler-straight lines and crisp characters, plus it has the capability of plotting 1000 points per inch. And with no pen change you can command the HP 7475A to return to the same point within 0.1 mm (0.004 in.).

Hardware compatibility. You'll receive the same high-quality plotting results when you link up the HP 7475A to a personal computer, mainframe or smart instrument. You'll be pleased with its team performance.

7475A Opt. 001
(RS232C) \$1895.00 ea.**
(for cables see page 81-82)



The HP 7475A six-pen plotter is an ideal solution for your technical applications. The 92177X Graphics Organizer keeps your plotter supplies organized. For more details, see page 48.

Opt. 002
(HP-IB) \$1895.00 ea.**
(for cables see pages 81-82)
92177X 7475A
Graphics Organizer \$179.00 ea
(See page 48)

Add drafting capability to your HP 7475A Plotter!

The HP 7475A plotter can help with many of your design/drafting needs—drafting pens (pages 60-61), a special HP 7475A drafting pen carousel (page 64), and polyester film A/A4 and B/A3 sizes (page 58) are now available for the HP 7475A. The low-cost HP 7475A with drafting capability is the ideal plotter for PC CAD systems and other applications requiring high quality.

Drafting pens and polyester films offer several advantages for your technical applications—superior line quality, translucent media, permanent copies, opaque ink, and a choice of three line widths. Because of these characteristics, you'll want to use drafting pens for:

- engineering diagrams
- overlays
- charts for microfilm reduction
- charts requiring frequent handling
- archival copies
- camera-ready art

"The plot quality is very impressive and professional looking. This reflects positively on my business."

Gary Naylor
President
Engineering Surveys

Media sizes

- 8½ × 11 in. (ANSI A)
- 210 × 297 mm (ISO A4)
- 11 × 17 in. (ANSI B)
- 297 × 420 mm (ISO A3)

Media

- Paper (regular or glossy)
- Transparency plotter film
- Double-matte polyester film

Pens

- Number—6, Automatic pen changing and capping
- Types—Fiber-tip (paper or transparency), refillable short-body drafting

Resolution

- 0.025 mm (0.001 in.)

Pen Acceleration

- Approximately 2 g's

Pen Speed

- Approximately 38.1 cm/s (15.0 in./s)

Interfaces

- RS232C/CCITT V.24
- HP-IB (IEEE 488-1978)

*Also available in A4 or A3 sizes.

**Sorry, but quantity, contract, or other discounts do not apply to this special off-the-shelf service.

Spend your time plotting, not looking for pens!

Space-saving pen organizer for your desk

Our new personal pen organizer keeps your plotter pens organized and within easy reach. Made of smoked acrylic, this organizer looks attractive on your desk and also fits conveniently in a desk drawer.

Up to 33 paper writing pens, overhead transparency pens or short-body drafting pens are stored vertically for easy identification. Take advantage of our quantity discounts and order a personal pen organizer for every plotter user in your office.

92177V Personal pen organizer

(1-2)	\$34.75 ea.
(3-9)	31.75 ea.
(10+)	29.50 ea.

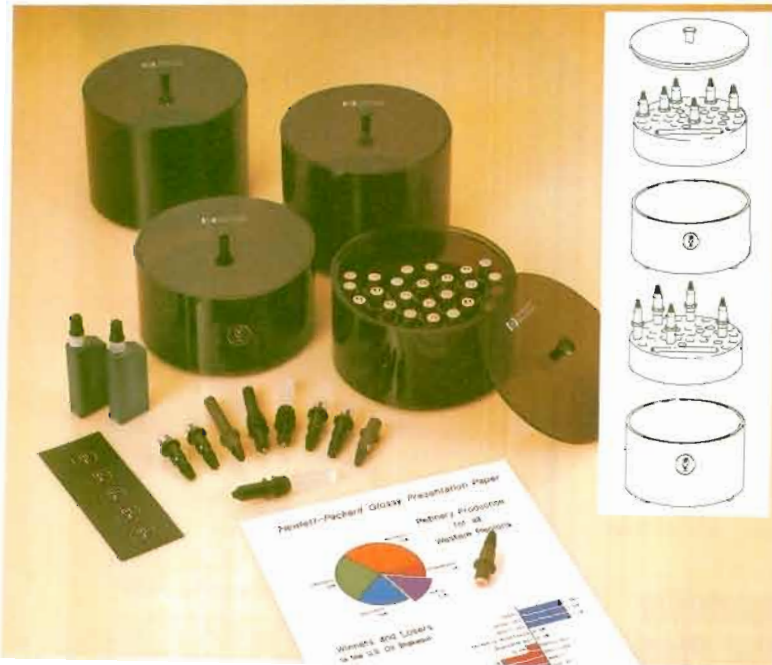

Space-saving pen organizers for your graphics workstation

Now—an elegant, yet practical solution for plotter pen storage. Our 6-inch (15 cm) diameter modular pen organizer stores up to 30 pens—60 when stacked.

As you add pens—fiber-tip, drafting, or rollerball—the modular units can be stacked to save valuable desktop space. And custom labels, with HP's international pen symbols, allow you to quickly identify the contents.

We offer two sizes (for short and long plotter pens), which can be mixed and matched according to your needs.

Pens are stored vertically for easy reach and are held securely by high-density foam. Made of sturdy acrylic plastic, the pen organizers are an attractive addition to any office setting.

92177T Short organizer

(1)	\$43.75 ea.
(2-3)	39.75 ea.
(4+)	37.25 ea.

92177U Long organizer

(1)	\$46.75 ea.
(2-3)	43.50 ea.
(4+)	41.25 ea.

HP's 6-inch diameter modular workstation organizer stores up to 30 plotter pens—60 when stacked!

7550A Media handling accessories

For use with HP's 7550A Graphics Plotter—the automatic sheet feed plotter for unattended operation of cut paper sheets.

Description	Product no.	Price
A-size media loading tray	17561A	\$110.00
A4-size media loading tray	17562A	\$110.00
A/A4-size media catcher tray	17563A	\$ 35.00
B-size media loading tray	17564A	\$120.00
A3-size media loading tray	17565A	\$120.00
B/A3-size media catcher tray	17566A	\$ 45.00
B-size media handling kit B-size media loading tray B/A3 media catcher tray B-size plotter paper, 50 sheets	17525A	\$176.00
A3-size media handling kit A3-size media loading tray A3/B media catcher tray A3-size plotter paper, 50 sheets	17526A	\$176.00

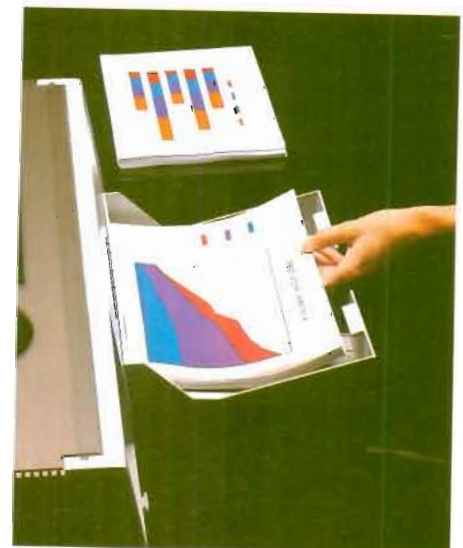

Plot color presentations from your Macintosh with Plotstart

Start plotting multi-color business presentations, straight from your Apple® Macintosh®! This high-performance disc-based driver works with Macintosh applications and the HP ColorPro, HP 7475A and HP 7550A plotters. Result? You plot drawings, charts and graphs, as easily as you print!

No more bargaining with your art department...no more rush charges from outside graphics services. Now you can have top-rate plotting, without giving up the familiarity of your 128K Mac, 512K Mac, Mac XL or MacPlus!

35184B Plotstart  \$125.00ea.

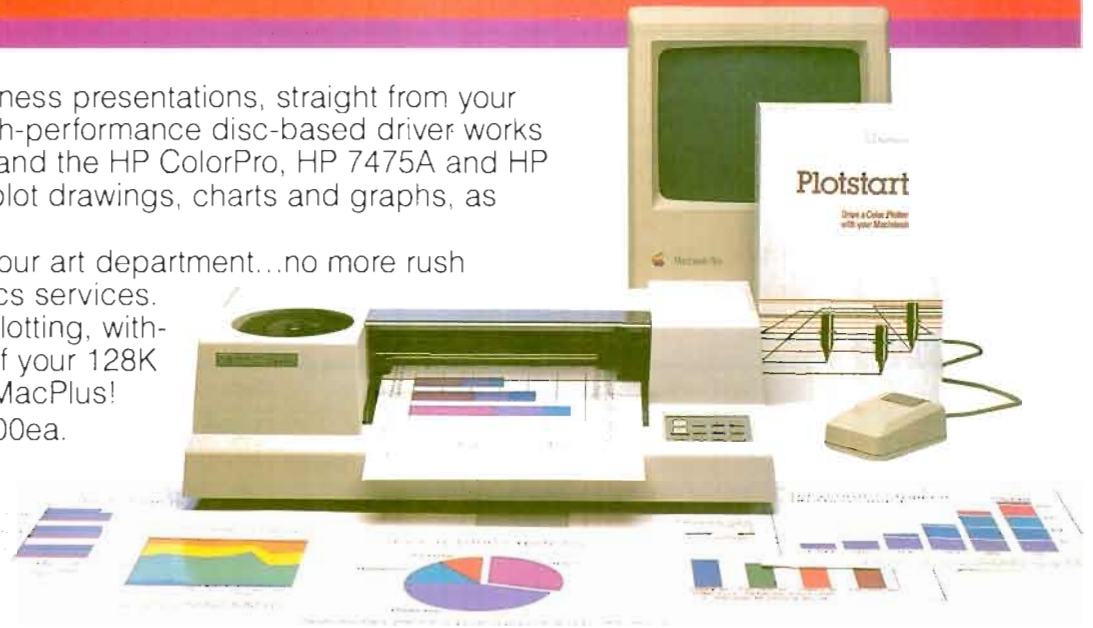

Plotstart lets you:

- MacDraw® that presentation cover, then plot it out in colors that captivate.
- Lotus® Jazz® your monthly report, then plot it out in colors that clarify.
- Microsoft® Chart™ your new organization, then plot it out in colors that correspond.

Available on 3.5-in. disc. Standard ImageWriter I type cable (DB-9 to DB-25) included.* Support provided by Softstyle.®

*In addition, the Macintosh Plus requires a DIN-8 to DB-9 adapter cable (Apple part no. 699-0372), and the HP 7550A plotter requires an RS-232C gender converter (DB-25) (HP part no. 92224F). The Macintosh XL requires a standard RS-232C printer cable instead of the one provided.

Lower the lid on plotter noise!

Do you have sensitive ears? Our all-new Plotter sound enclosure reduces the sound of your HP 7470, 7475 or ColorPro plotter by as much as 90 percent, to as low as 53.4 decibels. Your plotter becomes as quiet as a murmur... less intrusive than the sound of computer keyboarding. It's a wonderful way to improve office productivity.

The most functionality you'll find in a sound enclosure An intelligent design negates the need for an annoying cooling fan. It's constructed of sound-reducing particle board, with foam lining to absorb plotter vibrations. A foam plug can be removed to accommodate B/A3-size plotter paper, then re-inserted for further sound reduction. And the durable acrylic lid is attached by spring-loaded hinges for effortless opening and closing. Dimensions are 12 in. (305 mm) H x 25.8 in. (655 mm) W x 19.5 in. (495 mm) D; stand measures 3.9 in. (100 mm) H.

Designed to complement your HP equipment This Plotter sound enclosure is designed to coordinate with Design Plus furniture. What's more, its design allows space for our 92177W/X Graphics organizer underneath for additional convenience (see page 48).

Extra protection for your plotter This Plotter sound enclosure protects your plotter investment, too. It's a shield against dust, spills and environmental contaminants—just as it shields you from unwanted noise.

92166E Plotter sound enclosure \$249.00



HP drafting media—quality you can trust!

Tracing Bond

This lightweight Tracing Bond performs at its best when used with rollerball pens.

Tracing Bond is an uncoated, untreated and economical alternative to vellum. Use it when you need:

- Fast plotting capability of rollerballs (60cm/sec)
- Consistent line width
- Diazo-reproducible plots
- Low-abrasion media
- Check plots and preliminary drawings, not for high quality final plots

Media Size	Qty./pkg.	Product no.	Price
English	D	150 sheets	9280-0600 \$100.00 ea.
	E	150 sheets	9280-0598 \$190.00 ea.
Metric	A1	150 sheets	9280-0599 \$100.00 ea.
	A0	150 sheets	9280-0597 \$190.00 ea.

Vellum

This 100% rag vellum provides optimum performance with refillable and disposable drafting-style pens.

HP vellum has a surface coating for increased smoothness and ink receptivity. It is also treated to add strength and transparency. Use this vellum when you need:

- Relatively permanent documents
- Less expensive media than polyester film
- Diazo reproducible media

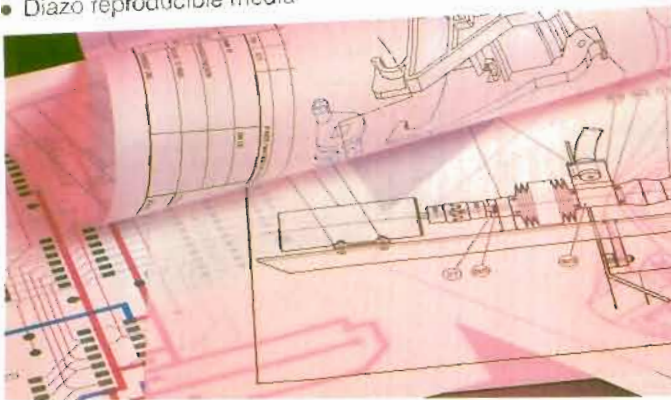

Media Size	Qty./pkg.	Product no.	Price
English	A	150 sheets	9280-0601 \$ 17.00 ea.
	B	150 sheets	9280-0602 \$ 30.00 ea.
	C	250 sheets	9280-0731 \$ 85.00 ea.
	D	150 sheets	9280-0529 \$130.00 ea.
	E	150 sheets	9280-0593 \$200.00 ea.
Metric	A4	150 sheets	9280-0603 \$ 17.00 ea.
	A3	150 sheets	9280-0604 \$ 30.00 ea.
	A2	250 sheets	9280-0733 \$ 85.00 ea.
	A1	150 sheets	9280-0530 \$130.00 ea.
	A0	150 sheets	9280-0594 \$200.00 ea.
	Roll	24in. x 150ft.	1 roll
	36in. x 150ft.	1 roll	9280-0636 \$ 75.00 ea.
Architectural	Arch. C	150 sheets	9280-0753 \$ 76.00 ea.
	Arch. D*	150 sheets	9280-0756 \$143.00 ea.
		150 sheets	9280-0749 \$190.00 ea.
	Arch. E	150 sheets	9280-0750 \$264.00 ea.

Polyester film

HP's double-matte, 3-mil film was specifically chosen to provide optimum performance when used with HP's refillable and disposable drafting pens.

This finely coated, translucent media minimizes pen and machine wear and maximizes line quality. Use this film when you need:

- Dimensionally stable media
- Close tolerance, high-accuracy plots
- Camera-ready art
- Master copies which will be handled repeatedly
- Media that will not tear, crack, peel or fade under normal use
- Clear and sharp quality reproductions
- Plots with distinct continuous lines and virtually no beading, bleeding or feathering

Media Size	Qty./pkg.	Product no.	Price
English	A	50 sheets	9280-0605 \$ 20.00 ea.
	B	50 sheets	9280-0607 \$ 32.00 ea.
	C	100 sheets	9280-0732 \$110.00 ea.
	D	50 sheets	9280-0526 \$122.00 ea.
	E	50 sheets	9280-0591 \$220.00 ea.
Metric	A4	50 sheets	9280-0608 \$ 20.00 ea.
	A3	50 sheets	9280-0606 \$ 32.00 ea.
	A2	100 sheets	9280-0730 \$110.00 ea.
	A1	50 sheets	9280-0525 \$122.00 ea.
	A0	50 sheets	9280-0592 \$220.00 ea.
Roll	24in. x 150ft.	1 roll	9280-0634 \$130.00 ea.
	36in. x 150ft.	1 roll	9280-0633 \$182.00 ea.
Architectural	Arch. C	50 sheets	9280-0758 \$ 69.00 ea.
	Arch. D*	50 sheets	9280-0757 \$135.00 ea.
	30 in. x 42 in.	50 sheets	9280-0748 \$200.00 ea.
	Arch. E	50 sheets	9280-0755 \$250.00 ea.

HELPFUL IDEAS!

Reduce static buildup on drafting film. Statically charged film attracts dust particles which clog pen tips and cause ink blots. To reduce the problem, lower the pen speed, increase the humidity around the plotter, or use vellum for your draft copies.

*"D"-size architectural media is not recommended on the DraftPro plotter with software programs that do scaling.

HP drafting pens— the choice that makes the difference!

Choose from HP's selection of disposable, refillable and rollerball pens. The right pens make all the difference in output quality.

Long body drafting pen comparison guide

Use the guide below to select the long body drafting pen features best suited for your application.

Plotter	Drafting pen	Paper	Media		Recommended plotting speed	Available line widths	Pen cleaning required
			Vellum	Polyester Film			
7550/DraftPro	Disposable	•	•	•	20cm/sec.	4	No
758X*/DraftMaster	Disposable	•	•	•	30cm/sec.	4	No
7550/758X*/DraftPro Series	Refillable		•	•	15cm/sec	6	Yes
DraftMaster	Refillable		•	•	30cm/sec	6	Yes

*Includes HP 7580A/B, HP 7585A/B, and HP 7588B Drafting Plotters.

Drafting pen carousels

Let the carousels do the work

There's more to choosing a pen for your plotter than meets the eye. That's why HP has developed drafting pen carousels that automatically determine the proper pen speed and force to meet your various plotting needs. Additionally, if you wish to experiment with different pen speeds and forces, most HP plotters feature a manual setting option. See page 64 for product numbers.



Give your plotter pens the boot

Keep your pens in peak performance, by capping them with HP's rubber boots to prevent dryness of tips. Different boots fit different pens, so refer to the listings to find the proper boot. Once you have your boots, keep them in good condition by cleaning them with a damp cotton swab to remove ink and dust. See page 64 if you need new boots.

Adopt our adapters

You won't be able to use your refillable or disposable drafting pens without this important part that connects your pen to the plotter's carousel. Our adapters include a pen cap, and are sold separately from drafting pens.

5061-7578 Package of four adapters and pen cap assemblies \$8.00 pkg.

HELPFUL IDEA!

Weather warning

Did you know the climate of your work environment—warm or cold—can affect your plotting paper? To prevent distortions in your plots, remove plotting paper from the package and expose it to air for about 15 minutes before you're ready to plot. You'll have fresh paper that's prepared to receive your plot with no variations.

We ship same day

**CALL HP DIRECT
800-538-8787**

Call us with your Purchase Orders or



Throw away the fuss and muss with our disposable pens

Now it's easy to produce picture-perfect drawings in no time with HP's waterproof and fade-resistant disposable drafting pens. These liquid-ink pens have streamlined plotting by eliminating time-consuming cleaning and refilling. Better yet, they're simple to use. Just insert the pen tip into the pre-filled ink reservoir, screw on an adapter, shake the pens and you're ready to produce plots with quality color and consistent lines. Designed for use on **HP 7550A, DraftPro Series, DraftMaster and other 758X** plotters, this line of pens can produce final-quality drawings on polyester film or vellum and preliminary-quality drawings on plotter paper.



Vellum/Paper Disposable Drafting Pens

Use HP's disposable drafting pens on vellum to produce final-quality, copier- and diazo-reproducible drawings. Or, use them on plotter paper to produce preliminary-quality drawings.

V.35 Fine line (Point size 0.35mm [†]) product no.	Single-Color Packages (4 pens/pkg.) Reusable adapters (5061-7578) are required for operation.	V.70 Broad line (Point size 0.70mm [†]) product no.
5061-7562	Black	5061-7572
5061-7563	Blue	5061-7573
5061-7564	Green	5061-7574
5061-7565	Red	5061-7575

V.25 Extra fine line (Point size 0.25mm [†]) product no.	Single-Color Packages (4 pens/pkg.) Reusable adapters (5061-7578) are required for operation.	V.50 Medium line (Point size 0.50mm [†]) product no.
5061-7619	Black	5061-7620

(1-4 pkgs.) \$22.00 ea.
(5+)* 19.80 ea.

Multi-Width (Black) Package (4 pens/pkg.) Reusable Adapters (5061-7578) are required for operation.			
V.25	Extra fine line width	Point size, 0.25mm [†]	5062-1556
V.35	Fine line width	Point size, 0.35mm [†]	
V.50	Medium line width	Point size, 0.50mm [†]	
V.70	Broad line width	Point size, 0.70mm [†]	

(1-4 pkgs.) \$25.00 ea.
(5+)* 22.50 ea.

*Line width may vary depending on media, ink, and plotting speed.

Choose black in four line widths or, choose from seven other colors. NOTE: These pens are not designed for area-fill applications, or for use on polyester film.

Multi-Color Packages (4 pens/pkg., 1 of each color) Reusable adapters (5061-7578) are required for operation.			
Point size	Black	Orange	Product No.
V.25 Extra fine line (Point size 0.25mm [†])	Red/Blue/Green/Black	Brown	5062-1557
	Orange/Brown/Yellow/Violet	Yellow	5062-1558
V.35 Fine line (Point size 0.35mm [†])	Red/Blue/Green/Black	Violet	5061-7566
	Orange/Brown/Yellow/Violet		5062-1559
V.50 Medium line (Point size 0.50mm [†])	Red/Blue/Green/Black		5062-1571
	Orange/Brown/Yellow/Violet		5062-1572
V.70 Broad line (Point size 0.70mm [†])	Red/Blue/Green/Black		5061-7576
	Orange/Brown/Yellow/Violet		5062-1573

(1-4 pkgs.) \$22.00 ea.
(5+)* 19.80 ea.

Polyester Film Disposable Drafting Pens

Use HP's black disposable drafting pens on double-matte polyester film to produce final-quality, archivable, copier- and diazo-reproducible drawings. NOTE: These pens are not designed for area-fill applications.

Single-Color (Black) Packages: (2 pens/pkg.) Reusable adapters (5061-7578) are required for operation.			
F.25	Extra fine line width	Point size, 0.25mm [†]	5062-1592
F.35	Fine line width	Point size, 0.35mm [†]	5062-1593
F.50	Medium line width	Point size, 0.50mm [†]	5062-1594
F.70	Broad line width	Point size, 0.70mm [†]	5062-1595

(1-4 pkgs.) \$22.00 ea.
(5+)* 19.80 ea.

*Price breaks apply to purchase of single part numbers only.

HELPFUL IDEA!

A tip for your tips

Keep your disposable and refillable drafting pens in tip-up shape by storing them vertically with the tips facing up. The upright position will prevent your tips from clogging and the result will be cleaner, sharper strokes on all your plots.

Plot detailed, precision graphics with refillable pens

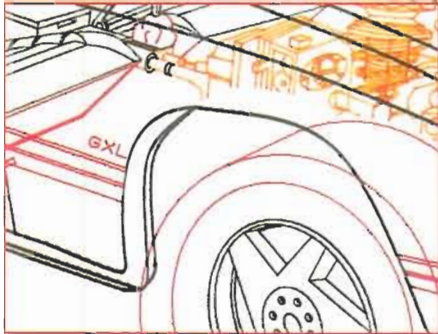

Close-up details can only look this sharp and clear by using HP's refillable drafting pens available in short or long body styles.

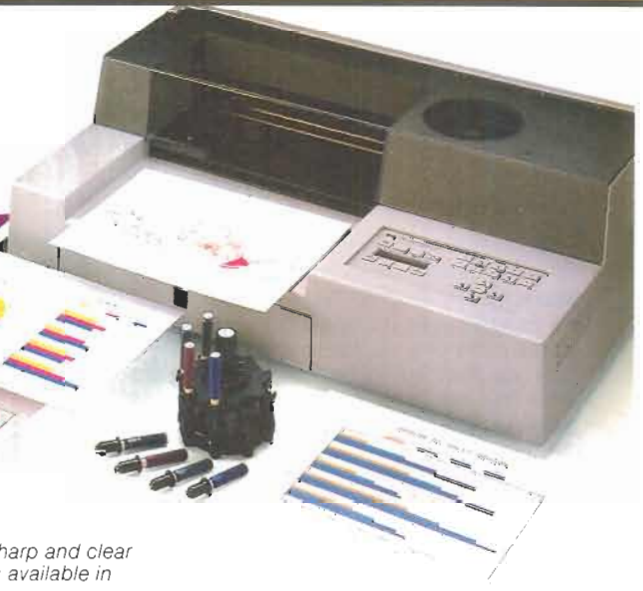

Refillable drafting pens



Refillable drafting pens—short body



5061-8119 Drafting pen, short body. For use with HP 7220, 7221 and 9872 Plotters with plotter points listed at right. For HP 7475 Plotter, use 9300-0957, 9300-0958, 9300-0959 only. Two pen bodies, adapters, caps per package.

Price \$18.00 pkg.

Plotter points (tungsten), use with short body drafting pen. Line width may vary depending on media, ink, and plotting speed. Fine-line point sizes .18 mm and .25 mm require more cleaning and care than wider point sizes and therefore are not recommended for general use.

Product no.	Point size	Price
9300-0955	.18 mm	\$32.00 ea.
9300-0956	.25 mm	29.00 ea.
9300-0957	.35 mm	25.00 ea.
9300-0958	.50 mm	25.00 ea.
9300-0959	.70 mm	25.00 ea.
9300-0960	1.00 mm	25.00 ea.



Refillable drafting pens—long body



07580-60025 Drafting pen, long body. For use with your HP 7550, DraftPro, DraftMaster, 7580, 7585, and 7586 Graphics Plotters with plotter points listed at right. One pen body, adapter, cap per package.

Price \$10.50 pkg.

Plotter points (tungsten), use with long body drafting pen. Line width may vary depending on media, ink, and plotting speed. Fine line point sizes .18 mm and .25 mm require more cleaning and care than wider point sizes and therefore are not recommended for general use.

Product no.	Point size	Price
9260-0742	.18 mm	\$32.00 ea.
9260-0741	.25 mm	29.00 ea.
9260-0588	.35 mm	25.00 ea.
9260-0744	.50 mm	25.00 ea.
9260-0579	.70 mm	25.00 ea.
9260-0743	1.00 mm	25.00 ea.

Plot fast drafts better with our improved Rollerball pens



We've improved our Rollerball Pens, so you plot higher quality drafts than ever before!

The pens have been redesigned to stay smoother longer, produce more uniform lines and to allow ink to flow more easily. Result? Cleaner drawings, without wasteful skipping—plot untended with confidence! And as always, Rollerballs deliver fast, 60 centimeter-per-second plots.

User Rollerball Pens with HP 7550, 7580, 7585, 7586 and DraftMaster Plotters. We recommend HP Blank Plotter Paper for single copies, and HP Tracing Bond for diazo-reproducible check plots or draft-quality drawings (see pages 51 and 58).

Rollerball pens



(4 pens/pkg)



Narrow line width (.3mm)

Single-color pen packages

- 5061-5034** (Red)
- 5051-5036** (Blue)
- 5061-5035** (Green)
- 5061-5033** (Black)



Multi-color pen packages

5061-5037 (red, blue, green and black)

(1-4 pkgs) \$14.00 pkg.
(5+) 13.00 pkg.

Price breaks apply to purchase of single part numbers only.

From paper to toner, stick with HP Electrostatic Plotter supplies for top-quality CAD system plots

There's more to a quality plot than 406-dots-per-inch resolution. The behind-the-scenes heroes are HP certified supplies.

Media

We carefully monitor all aspects of our media including: the smoothness of the surface and uniformity of paper coatings. Plus, we package them in single rolls and seal the ends with plastic caps to protect the edges.

Toner and Clear Dispersant

Our special blend of carbon pigments and resins produces clear, sharp, smudge-resistant plots. And because this toner is compatible with all HP 7600 Series media, you don't have to replace it every time you change media. And our clear dispersant flushes your toner system thoroughly which helps your output look its best plot after plot.

Maintenance Supplies

Our writing head cleaner evaporates quickly and leaves no residue. And our low-abrasion writing head polish won't scratch the writing head surface. Just slip on our cleaning gloves, grab our lint-free cleaning wipes and you're ready to go!



HELPFUL IDEA!

How much toner do you need?

These easy-to-use tables are excellent guidelines to help you order the right quantity of toner. Remember to always keep a few spare bottles of toner on hand as backup.

Rolls of paper/ Bottles of toner

Model 240D	Model 240E
1/1	1/1
2/1	2/1
3/1	3/2
4/2	4/2
5/2	5/3
6/2	6/3
7/3	7/4
8/3	8/4
9/3	9/5
10/4	10/5
15/5	15/8
20/7	20/11
25/8	25/13

Electrostatic Plotter Paper

Description	Roll size	Product number	Price
Report grade This economical opaque paper is perfect for everyday use. Ideal for line drawings, check plots or working copy with good line quality.	609mm (24 in.)	17265R	(1-10) \$46.00 ea. (11-30) 40.00 ea. (31-60) 36.30 ea. (61+) 33.60 ea.
	914mm (36 in.)	17266R	(1-10) 68.00 ea. (11-30) 61.90 ea. (31-60) 56.40 ea. (61+) 53.00 ea.
	609mm (24 in.)	17275P	(1-10) 70.00 ea. (11-30) 66.50 ea. (31-60) 64.40 ea. (61+) 63.00 ea.
	914mm (36 in.)	17276P	(1-10) 99.00 ea. (11-20) 94.10 ea. (21-40) 91.10 ea. (41+) 89.10 ea.
Vellum Final drawings, overlays, archival drawings and diazo reproductions never looked as good as they do on this rich, durable stock.	609mm (24 in.)	17269V	(1-10) 213.00 ea. (11-30) 202.40 ea. (31-60) 197.00 ea. (61+) 191.70 ea.
	914mm (36 in.)	17270V	(1-10) 320.00 ea. (11-20) 304.00 ea. (21-40) 296.00 ea. (41+) 288.00 ea.
	609mm (24 in.) <i>new!</i>	17267T	(1-10) 116.00 ea. (11-30) 110.00 ea. (31-60) 107.00 ea. (61+) 104.00 ea.
	914mm (36 in.) <i>new!</i>	17268T	(1-10) 174.00 ea. (11-20) 165.00 ea. (21-40) 160.00 ea. (41+) 157.00 ea.
Media Cutter The ideal media cutter to take you through the thick and thin of trimming plotter paper, complete with a metal handle and retractable blade.		17291C	(1-4) 8.00 ea. (5-) 7.00 ea.

Now maintenance is no longer a chore!

We've taken the drudgery out of maintaining your equipment. Supplies like clear dispersant, writing head cleaner, writing head polish, cleaning wipes and cleaning gloves make upkeep a snap!



Writing Head Cleaner

17279D Clear Dispersant 5 liter (1.3 gal) bottle	
(1-5)	\$50.00 ea.
(6-19)	47.50 ea.
(20+)	45.00 ea.



Clear Dispersant

92193F Writing Head Cleaner 253ml (8 oz.) can	
(1-4)	\$16.00 ea.
(5+)	14.00 ea.



Cleaning Wipes

17290P Writing Head Polish 253ml (8 oz.) can	
(1-4)	\$10.00 ea.
(5+)	8.00 ea.



Cleaning Gloves

92193W Cleaning Wipes One bag of 100	
(1-4)	\$12.00 ea.
(5+)	10.00 ea.



Writing Head Polish

92193G Cleaning Gloves 25 pairs per bag	
(1-4)	\$29.00 ea.
(5+)	25.00 ea.

HELPFUL IDEA!

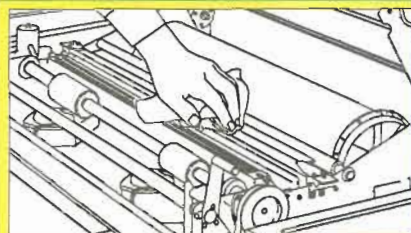

How to clean and polish your writing head

Failure to polish and clean your writing head on a regular basis can result in poor image quality and damage to your writing head. Here are some easy cleaning instructions that make maintenance a snap!

• **Cleaning the writing head**

Use HP's lint-free wipes and rub gently back and forth across the length of the head. If dust, toner or other foreign matter are stuck to the surface, use HP head cleaner.

• **Polishing the writing head**

Apply HP's head polish to a lint-free cloth and polish the length of the writing head as if you were sanding it. When the polish is absorbed, use a new clean wipe to catch any leftover residue.



Try our new & improved Toner

This special blend of Toner has been improved to optimize the performance of all HP electrostatic media with the HP 7600 series electrostatic plotters. The Toner comes pre-mixed in spill-resistant bottles.

17278A Toner, 5 liter (1.3 gal.) bottle	
(1-5)	\$43.00 ea.
(6-19)	41.00 ea.
(20+)	39.00 ea.

17278A replaces the 17278T Toner

Free the colors inside your Apple Macintosh with the HP PaintJet Printer Interface Kit

Join the Mac you love for creating presentation graphics, to the printer that delivers top-of-the-line color output—affordably!

Our PaintJet Printer Interface Kit makes it easy. There's nothing new to learn. Just use your favorite software applications, like MacDraw II, Cricket Draw and Cricket Presents, to generate graphics.

Then, instead of settling for ordinary black-and-white hardcopy, produce dazzling color output—on paper or transparencies—with your PaintJet Printer.

It's simple and economical with the PaintJet Printer Interface Kit.

You'll feel at home with PaintJet color printing from day one, because you work within the familiar Macintosh environment. The only change is the impact of your presentations.

After all, why create in color if you can't print in color? Especially when color presentations are so

much easier to understand, attention-getting and memorable.

The kit includes a driver, fonts, cable and users' guide. It works with the HP PaintJet Opt. 001 and Macintosh Plus, SE and II computers. ☑

17305A HP PaintJet Printer Interface Kit for Macintosh® Computers . . . \$125.00 ea.

Print brilliant color output from your Mac on the affordable HP PaintJet Printer.

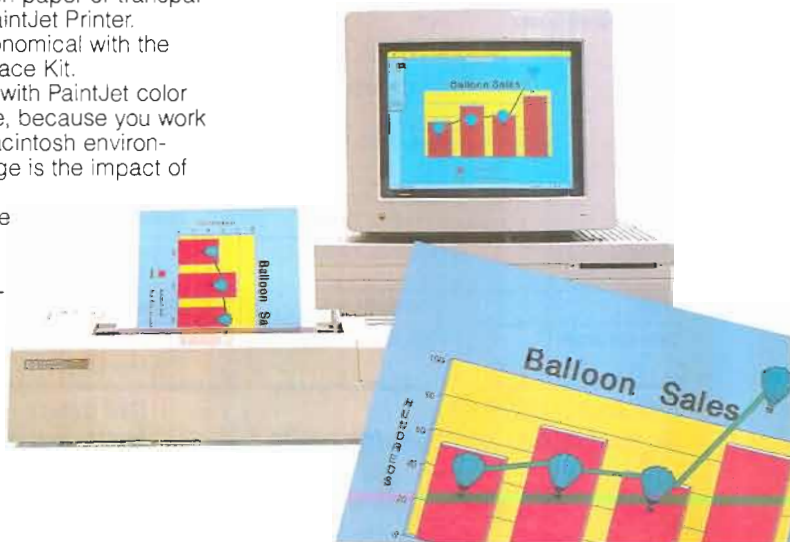

Enhance your graphics workstation with HP plotter accessories

Graphics accessories				
Item	Plotter	Description	Product no.	Price
Adapters	7550, DraftPro Series, DraftMaster, 7580, 7585, 7586	Reusable adapter and pen cap assemblies (4 of each/pkg.)	5061-7578	\$ 8.00/pkg.
Carousels	7090	Fiber-tip pen carousel (paper and transparency)	5061-5080	\$40.00 ea.
	ColorPro (7440)	Fiber-tip pen carousel (paper and transparency)	07440-60085	\$24.00 ea.
	7475	Fiber-tip pen carousel (paper and transparency)	5061-5080	\$40.00 ea.
		Refillable drafting pen carousel	07475-60030	40.00 ea.
	7550	Fiber-tip transparency pen carousel	07550-60050	\$55.00 ea.
		Fiber-tip paper pen carousel	07550-60051	55.00 ea.
		Rollerball pen carousel	07550-60052	55.00 ea.
		Refillable disposable drafting pen carousel	07550-60053	55.00 ea.
	DraftPro Series	Fiber-tip paper pen carousel	07570-60050	\$60.00 ea.
		Refillable/disposable drafting pen carousel	07570-60055	60.00 ea.
	DraftMaster	Adjustable pen carousel	5062-1576	\$70.00 ea.
	7580, 7585, 7586	Fiber-tip paper pen carousel	07580-60035	\$70.00 ea.
Refillable disposable drafting pen carousel		07580-60081	70.00 ea.	
Rollerball pen carousel		07580-60082	70.00 ea.	
Disposable drafting pen carousel. Serial No. Prefix 2444 or higher		07580-60240	70.00 ea.	
Cleaning supplies	7475, 7550, DraftPro Series, DraftMaster, 7580, 7585, 7586	Gritwheel brush	5062-1515	\$ 6.00 ea.
	For use with refillable drafting pens	Cleaning syringe	9282-0905	\$12.00 ea.
		Cleaning solution	9282-0908	6.50 ea.
Digitizing sights	For use with all HP plotters (with the exception of ColorPro) DraftPro Series, 7580, 7585, 7586	Straight sight	09872-60066	\$50.00 ea.
		Angled view sight	07585-60191	80.00 ea.
Drafting ink	7475, 7550, DraftPro Series, DraftMaster, 7580, 7585, 7586	.75 oz. bottle, black	9260-0596	\$ 2.50 ea.
Media cutter	DraftMaster	Media cutter for roll paper (5/box)	07596-60008	\$10.50/box
Overlays	17623A Graphics tablet	Overlay	4114-1033	\$ 8.50 ea.
	9111A/T Graphics tablet	Overlays (3/pkg.)	7121-0988	\$39.00/pkg.
Paper, Blank roll	7220/21, 9872S/T only	297mm x 61m roll (metric)	9280-0619	\$22.00 ea.
		11 in. x 200 ft. roll (english)	9280-0618	22.00 ea.
Paper writing pens	7200-7203, 7210, 9125, 9862	Single color pens, 5 per package Red, Blue, Green, Black	5081-1190 5081-1191 5081-1192 5081-1193	\$ 6.50/pkg. 6.50 pkg. 6.50/pkg. 6.50/pkg.
Print heads	7240, 7245	Thermal print head	07245-60001	\$85.00 ea.
Printer/Plotter power modules	ColorPro (7440), 3630A PaintJet, 2227A/B QuietJet Plus, 2228A QuietJet printers and 2276A DeskJet Printer	External power module, U.S./Canada, 120V 50/60Hz	17122B	\$60.00 ea.
		External power module, European, 220V 50Hz (Call for other international versions.)	17222B	60.00 ea.
Replacement boots	7475	Boots for refillable drafting pen carousels (6 pkg.)	07475-60038	\$ 8.75/pkg.
	7220, 7221, 9872	Boots for short-body drafting pens (2/pkg.)	9300-0967	\$ 6.25/pkg.
	7550, DraftMaster	Boots for fiber-tip and rollerball pen carousels (8/pkg.)	5061-7635	\$ 9.00/pkg.
		Boots for drafting pen carousels (8/pkg.)	5061-7636	9.00/pkg.
	7580, 7585, 7586	Boots for fiber-tip and rollerball pen carousels (8/pkg.)	5062-0098	\$ 9.00/pkg.
		Boots for drafting pen carousels (8/pkg.)	5062-0099	9.00/pkg.
DraftPro Series, ColorPro, 7475A	Boots for fiber-tip pen carousels (8/pkg.)	5062-0096	\$ 9.00/pkg.	
	Boots for drafting pen carousels (8/pkg.)	5062-0097	9.00/pkg.	
Stand	ColorPro, 7470A	Acrylic desktop stand to store paper underneath your plotter. (See page 121 for details)	92269A	\$79.00 ea.
Styli	17623A, 9111A/T	Stylus refills (2 inkless, 3 ink cartridges)	09111-68701	\$ 9.50 ea.
Take-up cores	7586, DraftMaster II	609.6mm (24 in.)	9300-1068	\$ 2.00 ea.
		914.4mm (36 in.)	9300-1069	3.00 ea.

See pages 124-125 for dust covers and carrying cases.

See pages 25-27 for peripheral sharing devices to allow many users to share one plotter.



HP-IB cables...an example of Hewlett-Packard's leadership role in developing the world instrumentation interface standard. HP DIRECT offers an extensive range of cables for applications of all types. Check our cable charts in this section—they make ordering easy.

Local Area Networks	66-71
StarLAN	67
ThinLAN	69
ThickLAN	70
Do-it-yourself cabling	72
Cable accessories	73
HP-IB cables	74
Gender converters & extenders	74
Extension cables	75
PC cables	76-78
Printer cables	78-80
Plotter cables	81-82
Terminal cables	82

Share information and resources quickly, efficiently and economically with Hewlett-Packard LANs

You work more productively when you can get the information you need, when you need it.

HP offers a means on doing just that: different Local Area Network (LAN) solutions that help you enjoy immediate access to centralized data and shared peripherals. At the same time, our LANs enable others to access your data files.

What's more, they're designed to accommodate specific layouts and specialized needs of office environments. For example, HP StarLAN 10 is the most efficient configuration for engineering and business offices. Getting hooked up is as easy as plugging into a telephone jack, and changes can be made

without disrupting the entire network.

If you're networking computer centers where one flexible coaxial cable can be used to link adjoining systems on a floor, HP ThinLAN is ideal. Each coaxial cable segment can support up to 185 meters and may be extended with the use of HP bridges or HP multi-repeaters. And all HP LANs meet IEEE 802.3 industry standards for hardware networking.

Read on for cables, tools and connectors specifically designed for HP LANs. For the latest LAN software, interface controllers and planning information, consult your HP Sales Representative.

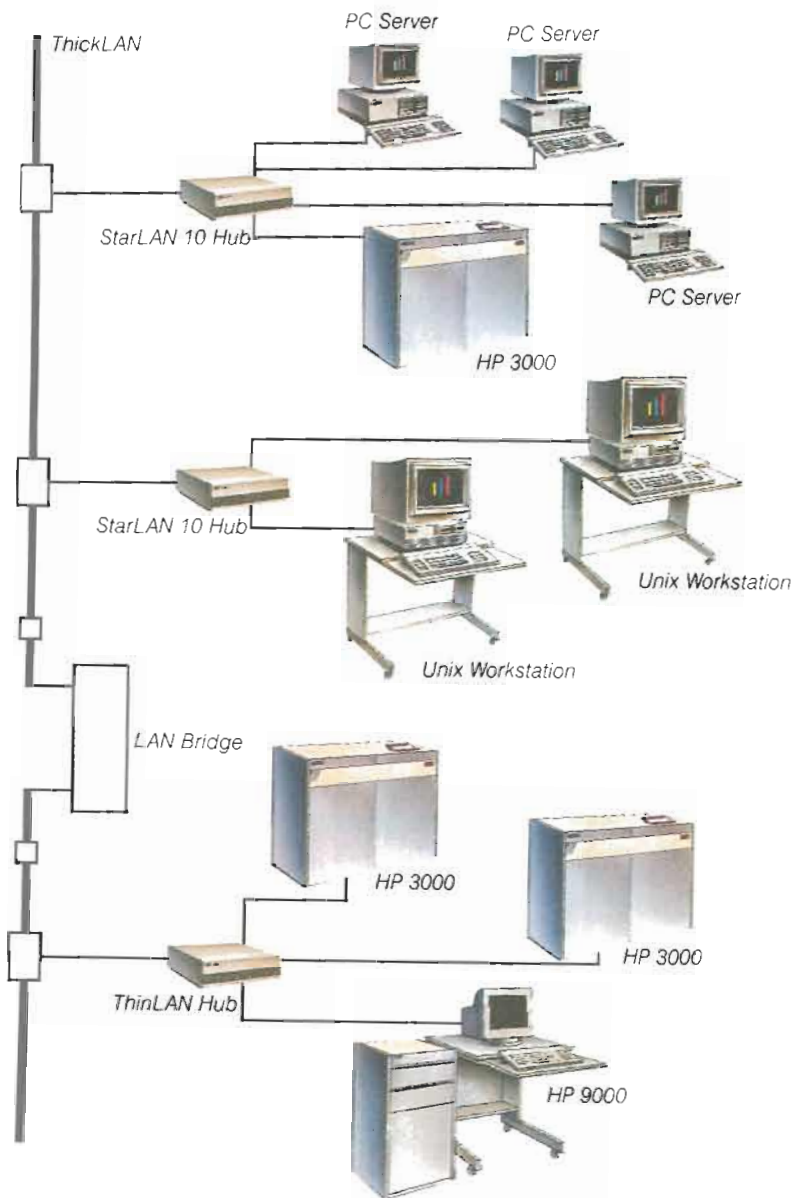

Run a better business office

HP StarLAN 10 utilizes convenient unshielded twisted-pair wiring to connect PC work-stations, so users can share data files stored on HP 3000, 9000 and 1000 Computers, as well as peripherals located in a computer center.

Enhance engineering efficiency

HP StarLAN 10 also allows you to connect multiple engineering work stations, including UNIX-based work groups. These network users can access computer center host systems, utilizing larger information files generated by other engineering or manufacturing groups.

Simplify computer center wiring

HP ThinLAN is a convenient alternative to HP ThickLAN for interconnecting multiple system computers such as HP 1000, 9000 and HP 3000 computers, as well as technical peripherals.

Transmit data to HP StarLAN 10 workstations with compact, convenient twisted-pair MAU

Reply on the StarLAN 10 MAU (medium attachment unit) for a fast, efficient way to share data and peripherals.

This MAU connects computers with AUI (attachment unit interface) ports to HP StarLAN 10 networks. A reliable alternative to coax-based PC LANs, StarLAN 10 is a 10 Mbps network hardware system that utilizes convenient, cost-effective unshielded twisted-pair wiring.

The StarLAN 10 MAU lets you build large networks, without using thin or thick backbones, by simply cascading StarLAN 10 hubs: Connect a StarLAN 10 MAU to one of the ports on a hub, then connect the AUI cable to the AUI port of another hub to gain 12 more ports.

StarLAN 10 allows for hassle-free adjustments when you add, move or make changes to your network. A 12-port modular adapter simplifies connections to the StarLAN 10 hub, while an 8-pin telephone-style jack plugs into the hub on one end and directly into the PC interface card on the other.

Perhaps best of all, the network remains intact while you make adjustments—its star configuration allows for connections or disconnections *without incurring downtime.*

28664A StarLAN 10 Twisted pair MAU with integrated 1-meter AUI cable \$295.00 ea.

StarLAN 10's twisted pair MAU sends and receives data, detects collision on the network and monitors malfunctions on the hub-MAU link.

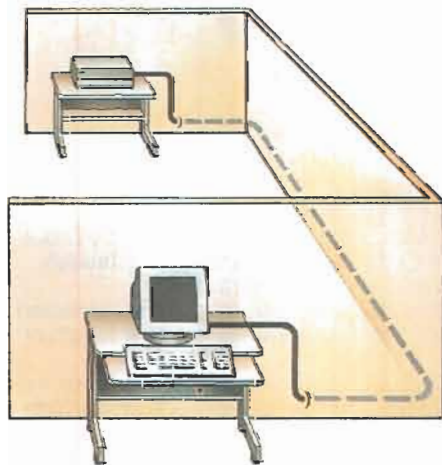
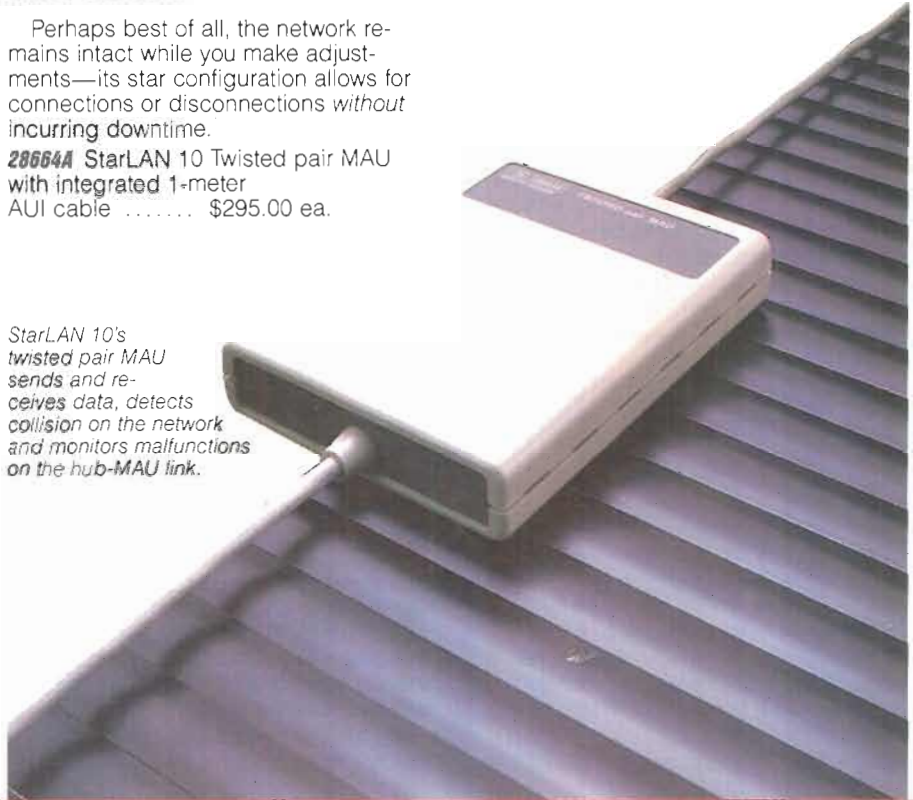

Link up to HP StarLAN 10 with low-cost, pre-measured or custom-cut HP cables

HP DIRECT is your HP StarLAN 10 cables headquarters!

Our twisted-pair cables are designed to connect HP Computers, HP Vectra PCs, IBM® PCs, and both HP and non-HP peripherals to your StarLAN hub.

Customize your network to your workplace easily with our unterminated cables. They come in two convenient

sizes so you can cut the length you need.

Set up a StarLAN conveniently with our Twisted-pair Cable Adapter. It has an 8-pin modular connector at one end and a 6-pin RJ11 plug that's compatible with standard telephone jacks at the other.

(NOTE: Connect only to unused telephone wiring.)

HP's unterminated cables can be cut to suit any StarLAN 10 configuration and pulled easily through conduits.

StarLAN cables

Description	Length	Product no.	Price	Description	Length	Product no.	Price
Terminated	4m (13.1 ft.)	92268A	(1-4) \$16.00 ea. (5-8) 14.00 ea. (9+) 13.00 ea.	Unterminated	100m (328 ft.)	92268M	(1-4) \$28.00 ea. (5-8) 24.00 ea. (9+) 21.00 ea.
Terminated	8m (25.2 ft.)	92268B	(1-4) \$19.00 ea. (5-8) 17.00 ea. (9+) 16.00 ea.	Unterminated	300m (984 ft.)	92268N	(1-4) \$70.00 ea. (5-8) 60.00 ea. (9+) 52.00 ea.
Terminated	16m (52.5 ft.)	92268C	(1-4) 22.00 ea. (5-8) 20.00 ea. (9+) 19.00 ea.	6 to 8 pin cable adapter	5m (16.4 ft.)	92268S	(1-4) \$16.50 ea. (5-8) 14.50 ea. (9+) 13.50 ea.
Terminated	32m (105.0 ft.)	92268D	(1-4) \$27.00 ea. (5-8) 25.00 ea. (9+) 24.00 ea.				

Use these tools for quick cable assembly



Rely on this tool set to securely and permanently crimp 8-pin modular plugs to our 92268M/N unterminated cables. Cable cutter included.

92268T StarLAN 10 Connector Crimper Tool \$95.00 ea.



Crimp these modular plugs onto the 92268M/N unterminated cables in seconds. They're composed of 8-conductor/4-pair modular plastic and available in boxes of 25.

92268P 8-pin modular plugs . \$37.00 ea.



Complete your LAN installation with modular wallplates

Give your twisted pair network a finished look with these molded plastic wallplates.

Designed to look like standard electrical wallplates, these plates feature an 8-pin RJ45 jack for your StarLAN 10 hub and a 6-pin RJ11 jack for your telephone. Each plate also comes with identification labels and removable plastic windows. Available in boxes of 12.

92268J Modular wallplates for StarLAN 10 \$99.00 box

Learn how to set up and utilize your StarLAN 10

Here's all the information you'll need to install StarLAN 10 cables and accessories.

This manual also includes helpful hints on cabling system-planning, plus documentation for twisted-pair cable installations.

5959-2208 HP SiteWire Twisted-Pair Cabling Installation Guide ... \$37.00 ea.

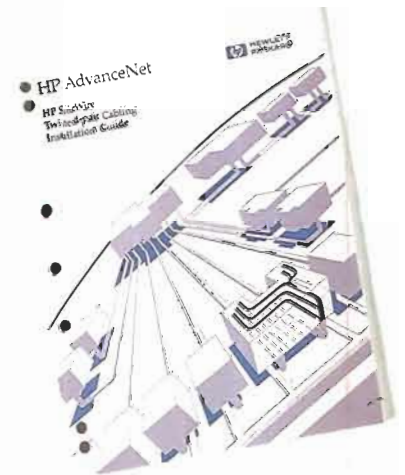

Rely on Shared Resource Management for HP 9000 networking

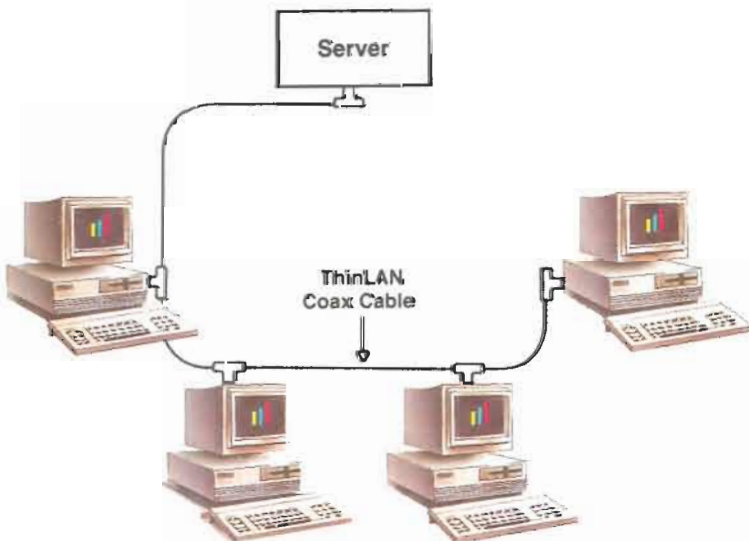

SRM Coax Link

The Shared Resource Management (SRM) is a dedicated file and printer/plotter server for the HP 9000 engineering workstations. It allows workstations in a local cluster to share centralized resources such as printers, plotters and data files.

SRM Coax Networks utilize HP 92227X ThinLAN Coax Cable (see page 69) and SRM Coax Interface Cards (order through HP sales office), resulting in a bus configuration.

Up to 25 nodes (servers and workstations) can be connected on a single coax network. Each coax can have a total length of 1000 meters.

All HP 9000 workstations are supported on the SRM coax network. However, non-SRM workstations cannot be supported on the same bus as an SRM network.

45695A SRM coaxial link terminator pair, 1 grounded, 1 non-grounded \$40.00 ea.

SRM Coax Interface Cards

Computer	Mux Link	Coax Link
HP Series 200 and 300	98629A.	50961A Opt. 200
HP Series 500	27123A.	50961A Opt. 500

Access data from HP ThinLAN resources with our easy-to-install ThinMAU

Get our ThinLAN MAU (medium attachment unit) to connect HP 9000, 3000 and 1000 Computers, as well as HP bridges, HP multi-port repeaters, HP repeaters and HP terminal servers.

A convenient alternative to ThickLAN, ThinLAN 10 Mbps network hardware system uses a thin, flexible coaxial cable as a backbone medium for interconnecting computer systems and peripherals.

It's the recommended solution in computer centers where multiple computer systems are linked for quick data access.

The ThinMAU attaches directly to ThinLAN cable with an insulated BNC tee connector, and to a computer with an integrated 1-meter AUI (attachment unit interface) cable. You can extend the length of the AUI cable by using a 92254J AUI cable (see chart below).

Each ThinLAN backbone cable segment can be up to 185 meters, which can be extended with the use of HP repeaters or bridges.

28641A ThinMAU \$350.00 ea.



Each ThinMAU includes an integrated 1-meter AUI cable and a BNC tee connector with insulated cover.

For a guaranteed connection, get your HP ThinLAN cables from HP DIRECT

Call HP DIRECT whenever you need ready-to-use ThinLAN cables.

These cables have PVC jacket material and molded connector strain relief casing for durability. FEP Jacket cable is also

available for environmentally harsh areas, and terminators are sold separately (see 92227P Terminators on the next page).

We also carry the 92254J 5-meter AUI cable which can be used to extend the

1-meter AUI cable that comes with the ThinMAU package.

And perhaps best of all, our cables are always in-stock and shipped the day you call. Just pick up the phone!



Hook up to HP ThinLAN quickly and easily with our low-cost, easy-to-install ThinLAN cables.

ThinLAN cables

Description	Length	Product no.	Price
Terminated, PVC	1m (3.3 ft.)	92227A	\$ 25.00 ea.
Terminated, PVC	2m (6.6 ft.)	92227B	\$ 27.00 ea.
Terminated, PVC	4m (13.1 ft.)	92227C	\$ 29.00 ea.
Terminated, PVC	8m (26.2 ft.)	92227D	\$ 33.00 ea.
Terminated, PVC	16m (52.5 ft.)	92227E	\$ 39.00 ea.
Terminated, PVC	32m (105 ft.)	92227F	\$ 51.00 ea.
Terminated, PVC	64m (210 ft.)	92227G	\$ 76.00 ea.
Terminated, PVC	128m (420 ft.)	92227H	\$126.00 ea.
Unterminated, PVC	300m (984.2 ft.)	92227S	\$230.00 ea.
Unterminated, FEP	100m (328.1 ft.)	92227T	\$300.00 ea.
Unterminated, FEP	300m (984.2 ft.)	92227U	\$900.00 ea.
Terminated, AUI, PVC	5m (16.7 ft.)	92254J*	\$ 45.00 ea.

*For use with 28641A ThinMAU.

We ship same day

CALL HP DIRECT
800-538-8787



You can now get these test & measurement accessories shipped the same day you order:

- Probes
- Rack mounts
- Recorder paper
- Instruments
- Test leads

Check off your instrument interests on the catalog subscription card and we'll send you the latest Test & Measurement Accessories Catalog from HP DIRECT. Available in the U.S. only.

Install your HP ThinLAN right with our manual

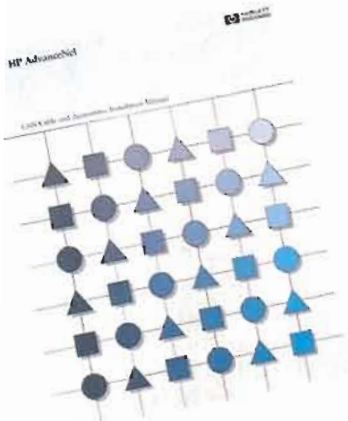

Obtain the specific information you need to install LAN cables, AUI cables, MAUs and repeaters from this easy-to-follow installation guide.

5955-7680 LAN Cable and Accessories Installation Manual \$45.00 ea.



Call HP DIRECT

to order manuals and guides for installing HP LANs—we're only a toll-free telephone call away, and ship the day you call!



Our tools help you quickly make your ThinLAN connections

- 92227L** Crimp-on style BNC connectors/ 2 per package \$22.50 pkg.
- 92227M** ThinLAN tool kit with crimping tool and cable stripper 450.00 ea.
- 92227N** ThinLAN Tee connector with insulating cover \$27.50 ea.
- 92227P** ThinLAN terminator pair (no ground wire connection) \$23.00 ea.
- 92227Q** ThinLAN loopback (Tee connector, terminator pair, insulating cover, pre-assembled) \$45.00 ea.
- 92227R** ThinLAN insulating cover for Tee connector (see photo on previous page) \$19.50 ea.



Tap into HP ThickLAN information lines with an HP ThickMAU

Our ThickMAU is the ideal solution for interior wiring and longer-distance networks.

HP ThickLANs utilize 10mm, 10Mbps semi-rigid coaxial cable as a medium, forming highly durable building backbones.

The ThickMAU facilitates data transmission, while detecting collisions on the network and making it possible for multiple devices to have access to a BUS line in minimal time.

It attaches easily to ThickLAN cable with a tap, and to the computer with an AUI (attachment unit interface) cable (NOTE: The ThinMAU tap should be left in place even if the MAU is disconnected).

30241A ThickLAN medium attachment unit and coaxial cable tap ... \$400.00 ea.



Situate your ThickMAU between ThickLAN cable and computer.

30241B Additional LAN coaxial cable tap \$45.00 ea.

Optimize HP ThickLAN with precision tools

Isolate cable segments with different grounds and systems with different power sources, while protecting your network against power surges.

92256E Thick Backbone Cable Segment Surge Protector \$90.00 ea.

Crimp an N-connector onto a thick coax cable quickly. Requires die in 92256A Installation Kit.

92229B Crimp Tool \$199.00 ea.

Get a coaxial cable stripper and a hex crimp die in one kit. Die requires 92229B Crimp Tool.

92256A LAN Coaxial Cable Installation/Tool Kit \$185.00 ea.

Choose from HP's FEP or PVC cables to hook up your HP ThickLAN—and enjoy virtually unlimited data access!

Depend on HP's 10mm thick backbone coaxial and AUI (attachment unit interface) cable for interior wiring and longer-distance networks.

Designed to meet IEEE 802.3 industry standards, these cables are available with external jacket material of PVC or FEP Teflon,® in standard lengths to prevent excessive signal reflection and distortion. AUI cables may also be ordered with FEP or PVC external linings.

Each coaxial cable kit comes with two N-connectors, one terminator, one grounded terminator, one terminal insulator,

one ground lug, two 3/8-in. nuts, one barrel connector (female to female) and one barrel insulator.

Coaxial cable kits with 500m cable include additional N-connectors and barrels with insulators for easy segmentation of coax cable and isolate faults. Extra connectors, barrels and terminators may be ordered separately (see chart below).

Each AUI cable package includes six wallplate labels with protective tape.

NOTE: Check your local building codes and placement plans to determine whether PVC may be used, or if FEP is required.

ThickLAN attachment unit interface (AUI) cables

Description	Length	Product no.	Price
Terminated, FEP	6m (19.7 ft.)	92254A*	\$ 135.00 ea.
Terminated, FEP	12m (39.4 ft.)	92254B*	\$ 200.00 ea.
Terminated, FEP	24m (78.7 ft.)	92254C*	\$ 345.00 ea.
Terminated, FEP	48m (157.5 ft.)	92254D*	\$ 635.00 ea.
Terminated, PVC	6m (19.7 ft.)	92254E*	\$ 85.00 ea.
Terminated, PVC	12m (39.4 ft.)	92254F*	\$ 110.00 ea.
Terminated, PVC	24m (78.7 ft.)	92254G*	\$ 160.00 ea.
Terminated, PVC	48m (157.5 ft.)	92254H*	\$ 250.00 ea.

*For use with 30241A LAN MAU and LAN coaxial cable tap.

ThickLAN backbone coax cables

Description	Length	Product no.	Price
Unterminated, FEP	23.4m (76.8 ft.)	92253A	\$ 400.00 ea.
Terminated, FEP	23.4m (76.8 ft.)	92253B	\$ 425.00 ea.
Unterminated, FEP	117m (383.9 ft.)	92253C	\$1500.00 ea.
Unterminated, FEP	500m (1640 ft.)	92253D	\$6000.00 ea.
Unterminated, PVC	23.4m (76.8 ft.)	92253E	\$ 200.00 ea.
Terminated, PVC	23.4m (76.8 ft.)	92253F	\$ 225.00 ea.
Unterminated, PVC	117m (383.9 ft.)	92253G	\$ 500.00 ea.
Unterminated, PVC	500m (1640 ft.)	92253H	\$2100.00 ea.
Package of 4 N-connectors		92253J	\$ 60.00 ea.
Package of 2 barrel connectors, 2 barrel insulators		92253K	\$ 65.00 ea.
Package of 1 non-grounded terminator, 1 grounded terminator, 1 terminal insulator		92253L	\$ 60.00 ea.

We ship within 24 hours

CALL HP DIRECT
800-538-8787

Call us with your Purchase Orders or



Do-it-yourself cabling—as easy as 1-2-3

1.
Choose the cabling system you need

Cable systems

Description	Connector kit	Raw cable
Universal 25-pin male RS-232C	92178A/C	92179A/B
Universal 25-pin female RS-232C	92178B/C	92179A/B
Edge connector for 264X Terminal	5061-1340	92179A/B
Multipoint connectors for 264X	5061-2401	92179A/B
For 262X Terminal (port 1) (except 2621B)	5061-2412	92179A/B
HP 3000 ATP (3-pin male RS-232C)	92224A†	92179C
HP 3000 ATP (3-pin female RS-232C)	92224B†	92179C
HP 3000 ATP (5-pin male RS-422)	92225A†	92179D
HP 3000 ATP (5-pin female RS-422)	92225B†	92179D
For HP-IB extenders	92226A	92179G
For 3081 to 92922A or 40253A	5061-3858	92179H

†Requires 92229A crimp tool for assembly.

2.
Select the appropriate connector kit

Connector kits

Each kit contains all parts necessary for a complete assembly. See examples at top of next page.

Application	Connector Kit Description	Number of Connectors per Kit	Product Number	Price
RS-232C	25-pin male RS-232C	2	92178A	(1–4 kits) . . . \$23.00 ea.
	25-pin female RS-232C	2	92178B	(5–9) 21.00 ea.
	25-pin male & female RS-232C	2 (1 male/1 female)	92178C	(10+) 19.00 ea.
264X Terminal	30-pin female edge connector	1	5061-1340	\$14.00 ea.
262X Terminal	50-pin male RS-232C for port 1 (except 2621B)	1	5061-2412	\$14.00 ea.
HP 3000 ATP	3-pin male RS-232C ATP	4	92224A†	(1 kit) \$51.00 ea.
	3-pin female RS-232C ATP	4	92224B†	(2–3) 47.00 ea.
	5-pin male RS-422 ATP	4	92225A†	(4–9) 45.00 ea.
	5-pin female RS-422 ATP	4	92225B†	(10–49) 43.00 ea. (50+) 41.00 ea.
HP-IB extender	BNC male (coaxial)	1	92226A	\$ 5.00 ea.

†Requires 92229A crimp tool for assembly.

3.
Determine the length of raw cable you need

Cut-to-length cables

Please specify lengths in meters.**

Shielded	Unshielded	No. of wires	Gauge	Product Number	Min. order	Max. continuous length*	Price per meter**
	X	12	22	92179A	10m	400m	(10–19m) . . . \$2.70/m (20–99m) . . . 2.35/m (100+) 2.10/m
	X	25	26	92179B	10m	400m	(10–19m) . . . \$4.10/m (20–99m) . . . 3.65/m (100+) 3.25/m
X		3	24	92179C	30m	300m	(30–99m) . . . \$1.25/m (100+) 0.89/m
X		5	24	92179D	30m	300m	(30–99m) . . . \$1.55/m (100+) 1.17/m
X		1 (coaxial)	18	92179G	100m	1000m	\$0.79/m
X		4	20/22	92179H	50m	1000m	\$1.00/m

*Longer continuous lengths are available on special order. Delivery time may be increased.

**Price per foot is roughly one-third the price per meter.

Our connector kits make custom cabling simple

To order, follow steps 1-2-3 on the opposite page



Kit includes male and female RS232C preassembled 25-pin connectors, strain relief rubber bushings, plastic housings and all necessary hardware.

92178C 25-pin RS232C Connector Kit ... \$22.00 ea.



Kit includes BNC connector, conductor, "wrench crimp" nut, and instructions. No special tools required for assembly.

92226A HP-IB Extender Connector Kit ... \$5.00 ea.



Kit includes plastic housing, R.F. cans, pins, connector blocks, all necessary hardware and instructions. Requires special crimp tool for assembly.

92224A HP 3000 ATP Connector Kit ... \$51.00 ea.



This precision-machined hand crimp tool is needed to crimp the RF shield included in 92224A/B and 92225A/B connector kits to the cable shield. Safety release located inside handle.

92229A Crimp Tool for ATP Connectors ... \$290.00 ea.



Cable management kit keeps cables out of sight—out of mind

Tired of tangled cables? Worried about expensive equipment accidentally being pulled to the floor? Frustrated when cables invade your workspace? Then tame your cables with HP's Cable Management Kit.

Each kit contains a 6-foot (1.8 m) flexible plastic tube, which is slit to provide convenient cable entrance and exit. Also included are five snap-together straps that can be used to attach the tube to any clean, nonporous surface. Velcro-like squares allow the straps to be mounted on a wall, desk, under a bookcase or other convenient location.

The tube is 1 inch in diameter so that several cables can be routed together; if data transmission problems occur, remove the power cord(s) and route separately.

92199F \$18.00 ea.



Protect your people and your equipment

Use these handy cable covers to eliminate costly accidents. These covers are made of long-lasting, flexible vinyl and come complete with double-faced adhesive tape for quick installation.

The 15-foot (4.8m) lengths can be trimmed to size with a sharp knife or butted for longer lengths. Beige or brown colors will match your office decor. The pre-slit channel accepts a cable up to .44 in. (7/16 in.) (11mm) diameter.

92199C Beige, 15-foot (4.8m) roll

92199D Brown, 15-foot (4.8m) roll

(1-4) \$32.00 ea.

(5-9) 30.00 ea.

(10+) 28.00 ea.

Note: HP does not recommend placing a power cord and a data communications cable in the same channel.

Power cords

Part no.	8120-1348 Black** \$9.25 8120-1378 Gray** \$8.75	8120-1351*	8120-1369*	8120-1689*	8120-2104*
Plug					
Voltage rating	125V	250V	250V	250V	250V

*Order from HP sales office.

**These power cords are 2.4m (7.5 ft.) long.

Call HP DIRECT for HP-IB cables



HP-IB/IEEE-488 cables can be used to connect two devices (e.g. a personal computer and a disc drive) or can be "daisy-chained" to connect several devices (e.g. printer, plotter, etc.).

Because HP-IB cables have a large bending radius, right-angle cables are extra convenient wherever HP-IB devices

are stacked. Right-angle connectors are available in 1-meter and 2-meter lengths.

Quantity pricing available Order large quantities of HP-IB cables, and receive a discount off our current competitive HP-IB prices. This represents an outstanding buy when you choose our IEEE 488 double-shielded HP-IB cable with metal connectors.



HP-IB Cables

Description	Length	Product Number	Price	Description	Length	Product Number	Price				
Straight-angle	.5m (1.6 ft.)	10833D	(1-5) \$80.00 ea.	Straight-angle	6.0m (19.8 ft.)	8120-3448	(1-5) \$125.00 ea.				
			(6-9) 76.00 ea.				(6-9) 119.00 ea.				
			(10-24) 70.00 ea.				(10-24) 110.00 ea.				
			(25-39) 62.00 ea.				(25-39) 100.00 ea.				
			(40-79*) 61.00 ea.				(40-79*) 84.00 ea.				
1.0m (3.3 ft.)	10833A	(1-5) \$80.00 ea.	8.0m (26.4 ft.)	8120-3449	(1-5) \$135.00 ea.						
		(6-9) 76.00 ea.			(6-9) 128.00 ea.						
		(10-24) 70.00 ea.			(10-24) 119.00 ea.						
		(25-39) 62.00 ea.			(25-39) 108.00 ea.						
		(40-79*) 61.00 ea.			(40-79*) 94.00 ea.						
2.0m (6.6 ft.)	10833B	(1-5) \$90.00 ea.	Right-angle	0.3m (1.0 ft.)	92220R	\$80.00 ea.					
		(6-9) 84.00 ea.				Right-angle for use with the HP 9807A Integral PC	1.0m (3.3 ft.)	82977A	\$105.00 ea.		
		(10-24) 78.00 ea.							2.0m (6.6 ft.)	82977B	\$115.00 ea.
		(25-39) 68.00 ea.									
		(40-79*) 65.00 ea.									
4.0m (13.2 ft.)	10833C	(1-5) \$100.00 ea.	(1-5) \$100.00 ea.								
		(6-9) 93.00 ea.	(6-9) 93.00 ea.								
		(10-24) 88.00 ea.	(10-24) 88.00 ea.								
		(25-39) 75.00 ea.	(25-39) 75.00 ea.								
		(40-79*) 73.00 ea.	(40-79*) 73.00 ea.								

*Call HP DIRECT 800-538-8787 for additional savings on quantities over 79 cables. Price breaks apply to purchase of single product numbers only.

Here's the adapter for quick HP-IB connection

The HP 10834A Adapter is a shielded HP-IB to HP-IB adapter designed to help in difficult cabling situations. The adapter provides additional clearance between the HP-IB cable and the rear panel of the instrument. Using this adapter allows easier access to switches, cables, and other connectors that may be in close proximity to the HP-IB connector. The adapter extends the first cable approximately 2.3cm away from the rear panel.

10834A Adapter \$30.00 ea.

We ship same day

**CALL HP DIRECT
800-538-8787**

The HP-IL cables you need are in stock—ready to go!

HP-IL The Hewlett-Packard Interface Loop (HP-IL) is a bit-serial interface for low-cost, battery operated systems. Devices are connected by two-wire cables leading from the output port of one device to the input port of the next until all devices form a closed loop. Use with HP 41, Series 70, The PORTABLE and The Portable PLUS.

HP-IL is not intended as a replacement for HP-IB, but rather as a low-cost, low-power alternative below HP-IB in price and performance.

For more HP-IL products, see page 130. Also see the book, *HP-IL System: An Introductory Guide to Hewlett-Packard Interface Loop*, page 138.

HP-IL Cables

Length	Product Number	Price
0.5m (1.6 ft.)	82167A	\$ 6.00 ea.
1.0m (3.3 ft.)	82167B	\$ 8.00 ea.
5.0m (16.7 ft.)	82167D	\$10.00 ea.



Cables won't mate? Try the HP connection!

Our female and male gender converters are designed to provide convenience and therefore, productivity.

The male gender converter will allow two female cables to be connected. Conversely, a female gender converter will connect two male cables.

Shielding is 100 percent from metal connector to metal connector and both devices feature all 25 wires wired pin to pin.

92224F RS232C Female shielded gender converter \$25.00 ea.
92224M RS232C Male shielded gender converter \$25.00 ea.

HELPFUL IDEAS!

Extending your RS-232C cables

HP offers RS-232C extension cables that allow you to extend the distance between your computer and peripheral. To determine which extension cable will best fill your need, we offer the following suggestions:







1 Determine the gender you need to mate the extension cable to your present cable. For example, if you want to extend a male connector, order a female-to-male extension cable. If you want to extend a female connector, order a male-to-female extension cable. (A male connector has visible pins, while a female connector has recessed pins.)

2 Check your pin configuration. Extension cables that have pins 1-25 wired end-to-end will accommodate all of your cable extension needs.

3 Select the cable you need. Various configurations are offered in different lengths.

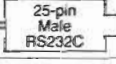
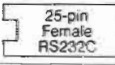

4 RS-232C cables over 50 feet in length are particularly susceptible to high voltage spikes. HP recommends 92165R surge protectors at each end of the linkage. See RS-232C surge protector on page 159.

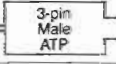
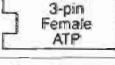
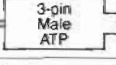
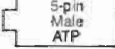
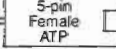
RS-232C Extension cables





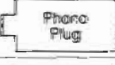
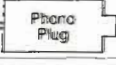

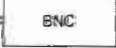







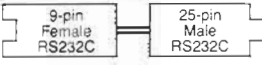

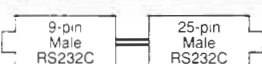

	Description	Connector Description	Length	Original system Product no.	Product no.	Price
Extension cables	Pins 1-25 wired end-to-end. Shielded.	 — 	3m (9.9 ft.)		☐ 17355M	\$ 66.00 ea.
	Pins 1-25 wired end-to-end. Shielded.	 — 	5m (16.7 ft.)	(30062C)	31391A	\$ 70.00 ea.
			10m (33.4 ft.)		31391B	80.00 ea.
			15m (50 ft.)	(30062C, Opt. 001)	☐ 92215F	109.00 ea.
			30m (100 ft.)	(30062C, Opt. 002)	☐ 92215T	\$115.00 ea.
	Pins 1-8, 11, 12, 19, 20, 22, 23, 25 wired end-to-end. Shielded.	 — 	3.8m (12.5 ft.)		☐ 92219G	\$ 65.00 ea.
	Hardwire extension; pins 2, 3, 7 wired end-to-end. Shielded.	 — 	7.6m (25 ft.)	(30062D)	30062-60018	\$ 70.00 ea.
			15m (50 ft.)		92215A	94.00 ea.
	Adapter cable between HP 3000 ATP and existing RS-232C terminal cable.	 — 	5m (16.7 ft.)	(30152A)	30152-60001	\$180.00 ea.
	Extension cable for HP 3000 ATP RS-232C interface.	 — 	15m (50 ft.)	(30153A)	30153-60001	\$205.00 ea.
Extension cable for HP 3000 ATP RS-422 interface.	 — 	30m (100 ft.)	(30154A)	30154-60001	\$205.00 ea.	

Be sure to see the book, *The RS-232 Solution*, page 138.

Video Extension cables

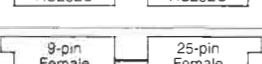
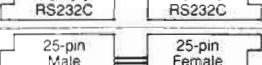
Video to:	Description	Connector Description	Length	Original system Product no.	Product no.	Price
HP Vectra PC	Monochrome video coaxial cable.	 — 	3m (9.9 ft.)		☐ 45741A	\$ 15.00 ea.
	Color video coaxial R, B, G cable.	 — 	3m (9.9 ft.)		☐ 45742A	\$ 38.00 ea.

HP Portable cables (Portable PLUS, Portable Vectra CS, & Portable Vectra CS Model 20)

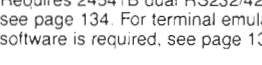











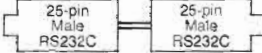

Portable to:	Description	Connector Description	Length	Original system Product no.	Product no.	Price
HP 3000	HP 3000 systems. Shielded.		3.0m (9.9 ft.)	24542M	☑ 24542M ⁴	\$ 60.00 ea.
	HP 3000 systems. Shielded.		5.0m (16.7 ft.)	(13242N)	☑ 13242-60001 ⁵	\$100.00 ea.
	RS232C interface cable for HP 3000 ATP.		5.0m (16.7 ft.)	(13242X)	92218D ⁵	\$ 72.00 ea.
	RS422 interface cable for HP 3000 ATP.		5.0m (16.7 ft.)	13242P	☑ 13242P ⁵	\$ 79.00 ea.
Modems	US European modems. Shielded.		3.0m (9.9 ft.)	24542M	☑ 24542M ⁴	\$ 60.00 ea.
	US modems. Shielded.		5.0m (16.7 ft.)	(13242N)	13242-60001 ⁵	\$100.00 ea.
	U.S. Modems. 103A, 212A, Vadic 3400 Modems. European 202C-type Modems. Acoustic Couplers. Shielded.		1.5m (5.0 ft.)	92221M	☑ 92221M	\$ 40.00 ea.
Printers	RS232C printer cable for 2225D, 2601A Opt. 826, 2603A, 2686A, 2686A Opt 300, 2932A, 2934A. Shielded.		3.0m (9.9 ft.)	24542G	☑ 24542G ⁴	\$ 60.00 ea.
	RS232C printer cable for 2225D, 2601A Opt. 826, 2603A, 2686A, 2686A Opt 300, 2932A, 2934A. Shielded.		5.0m (16.7 ft.)	(13242G)	☑ 13242-60010 ⁵	\$ 69.00 ea.
	Parallel (Centronics) printer cable for 2225C, 2686A Opt 300, 2932A Opt 042, 2934A Opt 042. Shielded.		2.0m (6.6 ft.)	24542D	☑ 24542D ⁶	\$ 55.00 ea.
	RS232C Interface cable for serial printer requiring male connector such as 2225D, 2601A, 2602A, 2932A, 2934A. Shielded.		1.5m (5.0 ft.)	92221P	☑ 92221P	\$ 42.00 ea.
	HP-IL Interface cable for 2225B, 82905B Opt. 448		0.5m (1.6 ft.)		☑ 82167A	\$ 6.00 ea.
				1.0m (3.3 ft.)	82167B	☑ 82167B
			5.0m (16.7 ft.)		☑ 82167D	10.00 ea.
Plotters	RS232C plotter cable for 7440A Opt 001, 7470A Opt 001, 7475A Opt 001, DraftPro or 758X. Shielded.		3.0m (9.9 ft.)	24542G	☑ 24542G ⁴	\$ 60.00 ea.
	RS232C plotter cable for 7440A Opt 001, 7470A Opt 001, 7475A Opt. 001, DraftPro or 758X. Shielded.		5.0m (16.7 ft.)	(13242G)	13242-60010 ⁵	\$ 69.00 ea.
	RS232 cable for 7510A or 7550A. Shielded.		3.0m (9.9 ft.)	24542H	☑ 24542H ⁴	\$ 60.00 ea.
	RS232 cable for 7510A or 7550A. Shielded.		1.2m (3.9 ft.)	17255D	☑ 17255D ⁵	\$ 44.00 ea.
	RS232C Interface cable for 7440A Opt. 001, 7470A Opt. 001 or 7475A Opt. 001. Shielded.		1.5m (5.0 ft.)	92221P	☑ 92221P	\$ 42.00 ea.
		HP-IL Interface cable for 7470A Opt. 003.		0.5m (1.6 ft.)		☑ 82167A
				1.0m (3.3 ft.)	82167B	☑ 82167B
			5.0m (16.7 ft.)		☑ 82167D	10.00 ea.

⁴Requires 24540B serial/parallel or 24541B dual RS232-422 interface card, see page 134. For terminal emulation, AdvanceLink software is required, see page 133.

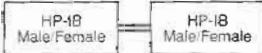
⁵Requires 24541B dual RS232/422 interface card, see page 134. For terminal emulation, AdvanceLink software is required, see page 133.

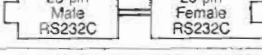
⁶Requires built-in serial/parallel port or 24540B serial/parallel interface card.

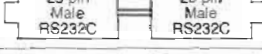
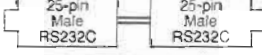
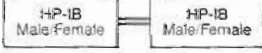
HP Touchscreen (HP 150) PC cables





Touchscreen PC to:	Description	Connector Description	Length	Original system Product no.	Product no.	Price
HP 3000	HP 1000, 3000 Systems. Shielded.		5.0m (16.7 ft.)	(13242N)	13242-60001	\$100.00 ea.
			15.0m (50.0 ft.)		92218A	110.00 ea.
	3-wire cable with EMP protection for terminals from lightning-induced transients. Shielded.		5.0m (16.7 ft.)	(13242Y)	13242-60005	\$ 95.00 ea.
			15.0m (50.0 ft.)		92218C	140.00 ea.
	RS232C Interface cable for HP 3000 ATP.		5.0m (16.7 ft.)	(13242X)	92218D	\$ 72.00 ea.
	RS422 Interface cable for HP 3000 ATP.		5.0m (16.7 ft.)	13242P	13242P	\$ 79.00 ea.
Modems	U.S. modems 103A, 202C D.S/T, 212A, Vadic 3400 modems; acoustic couplers (signal compatible only). Shielded.		5.0m (16.7 ft.)	(13242N)	13242-60001	\$100.00 ea.
			15.0m (50.0 ft.)		92218A	110.00 ea.
	European 202C-type modems. Shielded.		5.0m (16.7 ft.)	(13242M)	13242-60002	\$100.00 ea.
			15.0m (50.0 ft.)		92218B	122.00 ea.
Printers	RS232C Interface cable for serial printer requiring male connector such as 2225D, 2601A, 2602A, 2603A, 2631, 2686A, 2686A Opt. 300, 2932A, 2933A, 2934A, 82905B. Shielded.		5.0m (16.7 ft.)	(13242G)	☑ 13242-60010	\$ 69.00 ea.
	RS232C Interface cable for serial printer requiring female connectors.		5.0m (16.7 ft.)	(13242H)	☑ 13242-60011	\$ 95.00 ea.
	Centronics (parallel) cable to connect to 2225C. Requires use of HP 45643A Extended I/O accessory, available separately.		2.0m (6.6 ft.)	13242D	☑ 13242D	\$ 55.00 ea.
	HP-IB Interface cable for 2602A Opt. 046, 2225A, 2932A Opt. 046, 2933A Opt. 046, 2934A Opt. 046, 82906A, Opt. 001-004, 82906A		1.0m (3.3 ft.)		☑ 10833A ³	\$ 80.00 ea.
			2.0m (6.6 ft.)		☑ 10833B ³	90.00 ea.
			4.0m (13.2 ft.)		☑ 10833C ³	100.00 ea.
			0.5m (1.6 ft.)		☑ 10833D ³	80.00 ea.
HP-IL cable for 2225B. Requires HP45643A Extended I/O accessory, available separately.		0.5m (1.6 ft.)		☑ 82167A	\$ 6.00 ea.	
		1.0m (3.3 ft.)	82167B	☑ 82167B	8.00 ea.	
		5.0m (16.7 ft.)		☑ 82167D	10.00 ea.	
Plotters	RS232C Interface cable for 7440A Opt. 001, 7470A Opt. 001, 7475A Opt. 001, DraftPro or 758X in stand-alone mode.		1.2m (3.9 ft.)		☑ 17255M	\$ 44.00 ea.
			5.0m (16.7 ft.)	(13242G)	☑ 13242-60010	69.00 ea.
	RS232C Interface cable for 7510A or 7550A in stand-alone mode.		1.0m (3.3 ft.)		☑ 17255D	\$ 44.00 ea.
	RS232C Interface cable for 7470A Opt. 001, 7475A Opt. 001 or DraftPro in terminal mode (eavesdrop).		1.0m (3.3 ft.)	17455A	☑ 17455A ¹	\$ 82.00 ea.
			5.0m (16.7 ft.)	(13242N)	and 13242-60001	100.00 ea.
	RS232C Interface cable for 7510A or 7550A in terminal mode (eavesdrop).		5.0m (16.7 ft.)	(13242N)	13242-60001	\$100.00 ea.
	HP-IB Interface cable for 7440A Opt. 002, 7470A Opt. 002, 7475A Opt. 002, 7510A, 7550A, DraftPro ² or 758X		1.0m (3.3 ft.)		☑ 10833A ³	\$ 80.00 ea.
			2.0m (6.6 ft.)		☑ 10833B ³	90.00 ea.
		4.0m (13.2 ft.)		☑ 10833C ³	100.00 ea.	
		0.5m (1.6 ft.)		☑ 10833D ³	80.00 ea.	
Discs	Disc drive to monitor for Touchscreen II (HP 150 II) only. Not for general HP-IB use.		0.6m (2 ft.)	(45847-60002)	☑ 92220E	\$ 85.00 ea.

¹Piggyback male and female RS232C (Y-cable) supports eavesdrop mode.

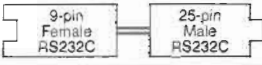

²Requires 17570A HP-IB interface

³Quantity break prices are available. see page 74.

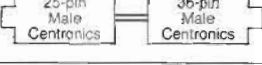
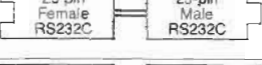
HP Vectra PC & IBM PC/AT cables

Vectra PC or IBM PC/AT to:	Description	Connector Description	Length	Original system Product no.	Product no.	Price
HP 3000	HP 3000 systems. Shielded.		3.0m (9.9 ft.)	24542M	24542M ⁴	\$ 60.00 ea.
	HP 3000 systems. Shielded.		5.0m (16.7 ft.)	(13242N)	13242-60001 ⁵	\$100.00 ea.
			15.0m (50.0 ft.)		92218A ⁵	110.00 ea.
	RS232C interface cable for HP 3000 ATP.		5.0m (16.7 ft.)	(13242X)	92218D ⁵	\$ 72.00 ea.
RS422 interface cable for HP 3000 ATP.		5.0m (16.7 ft.)	13242P	13242P ⁵	\$ 79.00 ea.	
Modems	U.S./European modems. Shielded.		3.0m (9.9 ft.)	24542M	24542M ⁴	\$ 60.00 ea.
	U.S. modems. Shielded.		5.0m (16.7 ft.)	(13242N)	13242-60001 ⁵	\$100.00 ea.
			15.0m (50.0 ft.)		92218A ⁵	110.00 ea.
European modems. Shielded.		5.0m (16.7 ft.)	(13242M)	13242-60002 ⁵	\$100.00 ea.	
			15.0m (50.0 ft.)		92218B ⁵	122.00 ea.
Printers	RS-232C printer cable for 2225D, 2601A Opt. 826, 2603A, 2686A, 2686A Opt. 300, 2932A, 2934A. Shielded.		3.0m (9.9 ft.)	24542G	24542G ⁴	\$ 60.00 ea.
	RS-232C printer cable for 2225D, 2601A Opt. 826, 2603A, 2686A, 2686A Opt. 300, 2932A, 2934A. Shielded.		5.0m (16.7 ft.)	(13242G)	13242-60010 ⁵	\$ 69.00 ea.
			Parallel (Centronics) printer cable for 2225C, 2686A Opt. 300, 2932A Opt. 042, 2934A Opt. 042. Shielded.		2.0m (6.6 ft.)	24542D
Plotters	RS-232C plotter cable for 7440A Opt. 001, 7470A Opt. 001, 7475A Opt. 001, DraftPro or 758X. Shielded.		3.0m (9.9 ft.)	24542G	24542G ⁴	\$ 60.00 ea.
	RS-232C plotter cable for 7440A Opt. 001, 7470A Opt. 001, 7475A Opt. 001, DraftPro or 758X. Shielded.		1.2m (3.9 ft.)		17255D ⁵	\$ 44.00 ea.
			RS-232C cable for 7510A or 7550A. Shielded.		3.0m (9.9 ft.)	24542H
	RS-232C cable for 7510A or 7550A. Shielded.		1.2m (3.9 ft.)	17255F	17255F ⁵	\$ 44.00 ea.

Printer cables (LaserJet, ThinkJet, QuietJet, QuietJet Plus, DeskJet, PaintJet & RuggedWriter 480 Printers)

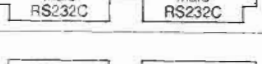
Printers to:	Description	Connector Description	Length	Original system Product no.	Product no.	Price
Touchscreen PC (HP 150)	RS-232C Interface cable for ThinkJet (2225D), LaserJet family, QuietJet and QuietJet Plus (2227A). Shielded.		1.2m (3.9 ft.)		17255M ⁵	\$ 44.00 ea.
			5.0m (16.7 ft.)	(13242G)	13242-60010 ⁵	69.00 ea.
	RS-232C Interface cable for LaserJet family. Shielded. Supports Xon/Xoff handshake only.		5.0m (16.7 ft.)		92219H	\$ 59.00 ea.
Centronics (parallel) Interface cable for ThinkJet (2225C), LaserJet PLUS (2686A Opt. 300), LaserJet 500 PLUS (2686D), QuietJet and QuietJet Plus (2227A). Shielded.		2m (6.6 ft.)		13242D ⁷	\$ 55.00 ea.	

⁴Requires 24540B serial/parallel or 24541B dual RS232/422 interface card. see page 134. For terminal emulation, AdvanceLink software is required, see page 133.











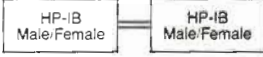

⁵Requires 24541B dual RS232/422 interface card, see page 134. For terminal emulation, AdvanceLink software is required, see page 133.

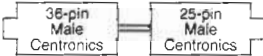
⁶Requires built-in serial/parallel port or 24540B serial/parallel interface card.

⁷Requires 45643A extended I/O accessory. see page 135.

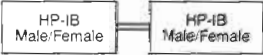
Chart continued next page

Printer cables (cont.) (HP LaserJet, ThinkJet, QuietJet, QuietJet Plus, DeskJet, PaintJet & RuggedWriter 480 Printers)

Printer to:	Description	Connector Description	Length	Original system Product no.	Product no.	Price	
Touchscreen PC (HP 150)	HP-IB Interface cable for ThinkJet (2225A). Shielded.		1.0m (3.3 ft.)		10833A ¹	\$ 80.00 ea.	
			2.0m (6.6 ft.)		10833B ²	90.00 ea.	
			4.0m (13.2 ft.)		10833C ³	100.00 ea.	
			0.5m (1.6 ft.)		10833D ³	80.00 ea.	
	HP-IL Interface cable for ThinkJet (2225B).		0.5m (1.6 ft.)			82167A ⁷	\$ 6.00 ea.
			1.0m (3.3 ft.)			82167B ⁷	8.00 ea.
5.0m (16.7 ft.)					82167D ⁷	10.00 ea.	
HP Vectra PC, IBM PC/AT	RS232C Interface cable for ThinkJet (2225D), LaserJet family, QuietJet and QuietJet Plus (2227A). Shielded.		3.0m (9.9 ft.)	24542G	24542G ⁴	\$ 60.00 ea.	
			1.2m (3.9 ft.)		17255M ⁵	\$ 44.00 ea.	
	RS232C Interface cable for ThinkJet (2225D), LaserJet family, QuietJet and QuietJet Plus (2227A). Shielded.		5.0m (16.7 ft.)	(13242G)	13242-60010 ⁵	69.00 ea.	
			2.0m (6.6 ft.)	24542D	24542D ⁶	\$ 55.00 ea.	
	Centronics (parallel) Interface cable for ThinkJet (2225C), LaserJet PLUS (2686A Opt 300), LaserJet 500 PLUS (2686D), QuietJet and QuietJet Plus (2227A). Shielded.		2.0m (6.6 ft.)				
PORTABLE, Portable PLUS	RS232C Interface cable for ThinkJet (2225D), LaserJet family, QuietJet and QuietJet Plus (2227A). Shielded.		1.5m (5.0 ft.)		92221P	\$ 42.00 ea.	
			0.5m (1.6 ft.)		82167A	\$ 6.00 ea.	
	HP-IL Interface cable for ThinkJet (2225B).		1.0m (3.3 ft.)		82167B	8.00 ea.	
			5.0m (16.7 ft.)		82167D	10.00 ea.	
239X Terminals	RS232C Interface cable for ThinkJet (2225D), LaserJet family, QuietJet and QuietJet Plus (2227A). Shielded. Terminal requires 40210R interface.		5.0m (16.7 ft.)	40242G	40242G	\$ 75.00 ea.	
					40210R	235.00 ea.	
	Centronics (parallel) Interface cable for ThinkJet (2225C), LaserJet PLUS (2686A Opt 300), LaserJet 500 PLUS (2686D), QuietJet and QuietJet Plus (2227A). Shielded. Terminal requires 40210P interface.		1.0m (3.3 ft.)	40242D	40242D	\$105.00 ea.	
					40210P	235.00 ea.	
	HP-IB Interface cable for ThinkJet (2225A). For 2393A and 2397A only. Shielded. Terminal requires 40210H interface.		1.0m (3.3 ft.)		10833A ²	\$ 80.00 ea.	
			2.0m (6.6 ft.)		10833B ²	90.00 ea.	
4.0m (13.2 ft.)				10833C ³	100.00 ea.		
0.5m (1.6 ft.)				10833D ³	80.00 ea.		
				40210H	235.00 ea.		
HP 86	Centronics (parallel) Interface cable for ThinkJet (2225C). Shielded. Requires 82949A printer interface.		1.2m (4.0 ft.)		82957A	\$ 60.00 ea.	
IBM PC, PC/XT, Compaq, AT&T PC 6300	RS232C Interface cable for ThinkJet (2225D), LaserJet family, QuietJet and QuietJet Plus (2227A). Shielded.		1.2m (3.9 ft.)		17255D	\$ 44.00 ea.	
			5.0m (16.7 ft.)		92219J	61.00 ea.	
	Centronics (parallel) Interface cable for ThinkJet (2225C), LaserJet PLUS (2686A Opt 300), LaserJet 500 PLUS (2686D), QuietJet and QuietJet Plus (2227A). Shielded.		2.7m (9.0 ft.)			92219K	\$ 52.00 ea.
IBM Convertible, compatible lap tops, Zenith 171/181, Toshiba 1100-#	Centronics (parallel) interface cable for ThinkJet (2225P) battery powered. Shielded with thumb screws.		1.0m (3.3 ft.)		92219Z	\$ 51.00 ea.	

¹Requires 24540B serial/parallel or 24541B dual RS232/422 interface card, see page 134. For terminal emulation, AdvanceLink software is required, see page 133.

²Quantity break prices are available. see page 74.





³Requires 24541B dual RS232/422 interface card, see page 134. For terminal emulation, AdvanceLink software is required, see page 133.

⁴Requires built-in serial/parallel port or 24540B serial/parallel interface card.



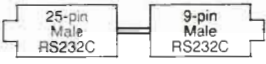

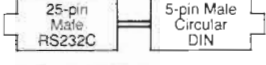

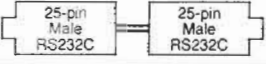

⁵Requires 45643A extended I/O accessory, see page 135.

Chart continued next page

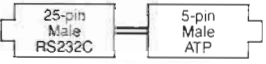
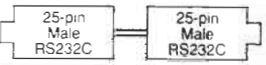
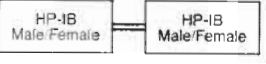
Printer cables (cont.) (HP LaserJet, ThinkJet, QuietJet, QuietJet Plus, DeskJet, PaintJet & RuggedWriter 480 Printers)

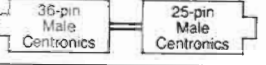
Printer to:	Description	Connector Description	Length	Original system Product no.	Product no.	Price
Apple Macintosh	RS232C Interface cable for ThinkJet (2225D), LaserJet family, QuietJet and QuietJet Plus (2227A). Shielded.		1.5m (5 ft.)		92219M ⁶	\$ 45.00 ea.
Apple Macintosh Plus/SE/II	RS232C Interface cable for PaintJet and LaserJet		1.5m (5 ft.)		17302A	\$ 60.00 ea.
Apple IIc	RS232C Interface cable for ThinkJet (2225D), LaserJet family, QuietJet and QuietJet Plus (2227A). Shielded.		1.5m (5 ft.)		92219N	\$ 45.00 ea.
Apple IIe	RS232C Interface cable for ThinkJet (2225D), LaserJet family, QuietJet and QuietJet Plus (2227A). Shielded.		3.0m (9.9 ft.)		17355M	\$ 66.00 ea.

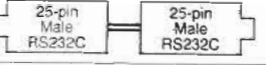
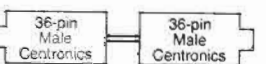
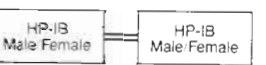
HP 2603A & 293X Printer cables

Printer to:	Description	Connector Description	Length	Original system Product no.	Product no.	Price
HP 3000	RS232C Interface cable for HP 3000 ADCC and ATP modem port. Shielded.		5.0m (16.7 ft.)	(13242Y)	13242-60005	\$ 95.00 ea.
			15.0m (50.0 ft.)		92218C	140.00 ea.
	RS232C Interface cable for HP 3000 ATP. Shielded.		5.0m (16.7 ft.)	(13242X)	92218D	\$ 72.00 ea.
	HP422 Interface cable for HP 3000 ATP. For 293X printers with Opt. 035 only. Shielded.		5.0m (16.7 ft.)	13242P	13242P	\$ 79.00 ea.
Touchscreen PC (HP 150)	RS232C Interface cable. Shielded.		1.2m (3.9 ft.)		17255M	\$ 44.00 ea.
			5.0m (16.7 ft.)	(13242G)	13242-60010	69.00 ea.
	HP-IB Interface cable for 293X printers with Opt. 046 only. Shielded.		1.0m (3.3 ft.)		10833A ³	\$ 80.00 ea.
2.0m (6.6 ft.)				10833B ³	90.00 ea.	
4.0m (13.2 ft.)				10833C ³	100.00 ea.	
0.5m (1.6 ft.)				10833D ³	80.00 ea.	
HP Vectra PC, IBM PC/AT	RS232C Interface cable. Shielded.		3.0m (9.9 ft.)	24542G	24542G ⁴	\$ 60.00 ea.
	RS232C interface cable. Shielded.		1.2m (3.9 ft.)		17255M ⁵	\$ 44.00 ea.
			5.0m (16.7 ft.)	(13242G)	13242-60010 ⁵	69.00 ea.
	Centronics (parallel) Interface cable for 293X printers with Opt. 042 only. Shielded.		2.0m (6.6 ft.)	24542D	24542D ⁶	\$ 60.00 ea.
PORTABLE and Portable PLUS	RS232C Interface cable. Shielded.		1.5m (5.0 ft.)	92221P	92221P	\$ 42.00 ea.
239X Terminals	RS232 Interface cable. Shielded. Terminal requires 40210R interface.		5.0m (16.7 ft.)	40242G	40242G	\$ 75.00 ea.
					40210R	235.00 ea.
	Centronics (parallel) Interface cable for 293X printers with Opt. 042 only. Shielded. Terminal requires 40210P interface.		1.0m (3.3 ft.)	40242D	40242D	\$105.00 ea.
					40210P	235.00 ea.
	HP-IB Interface cable for 2393A and 2397A terminals and 293X printers with Opt. 046 only. Shielded. Terminal requires 40210H interface.		1.0m (3.3 ft.)		10833A ³	\$ 80.00 ea.
			2.0m (6.6 ft.)		10833B ³	90.00 ea.
4.0m (13.2 ft.)				10833C ³	100.00 ea.	
0.5m (1.6 ft.)				10833D ³	80.00 ea.	
				40210H	235.00 ea.	
IBM PC, PC/XT, Compaq, AT&T PC 6300	RS232C Interface cable for 2603A printer only. Shielded.		1.2m (3.9 ft.)		17255D	\$ 44.00 ea.

⁴Requires 24540B serial/parallel or 24541B dual RS232/422 interface card, see page 134. For terminal emulation, AdvanceLink software is required, see page 133.

















⁵Requires 24541B dual RS232/422 interface card, see page 134. For terminal emulation, AdvanceLink software is required, see page 133.

⁶Requires built-in serial/parallel port or 24540B serial/parallel interface card.

³Macintosh Plus also requires Apple cable no. 699-0372 Peripheral Adapter cable.

⁴Quantity break prices are available, see page 74.

Plotter cables (ColorPro (7440A), 7470A, 7475A, 7510A, 7550A, DraftPro, DraftMaster & 758X Plotters)

Plotter to:	Description	Connector Description	Length	Original system Product no.	Product no.	Price	
HP 3000	RS422 Interface cable connects 7510A or 7550A to HP 3000 ATP.		5.0m (16.7 ft.)		17865A	\$220.00 ea.	
Touchscreen PC (HP 150)	RS232C Interface cable for 7440A Opt. 001, 7470A Opt. 001, 7475A Opt. 001, DraftPro and 758X. Shielded.		1.2m (3.9 ft.) 5.0m (16.7 ft.)	(13242G)	17255M 13242-60010	\$ 44.00 ea. 69.00 ea.	
	RS232C Interface cable for 7510A or 7550A. Shielded.		1.2m (3.9 ft.)		17255D	\$ 44.00 ea.	
	RS232C Interface cable for 7470A Opt. 001, 7475A Opt. 001 or DraftPro with HP 150 PC in terminal mode (eavesdrop). Both cables required. Shielded.		1.0m (3.3 ft.) 5.0m (16.7 ft.)	(13242N)	17455A¹ and 13242-60001	\$ 82.00 ea. 100.00 ea.	
	RS232C Interface cable for 7510A, 7550A or 758X with HP 150 PC in terminal mode (eavesdrop). Shielded.		3.0m (9.9 ft.) 5.0m (16.7 ft.)	(13242N)	17355M or 13242-60001	\$ 66.00 ea. 100.00 ea.	
	HP-IB Interface cable for ColorPro (7440A Opt. 002), 7470A Opt. 002, 7475A Opt. 002, 7510A, 7550A, DraftPro ² and 758X. Shielded.		1.0m (3.3 ft.) 2.0m (6.6 ft.) 4.0m (13.2 ft.) 0.5m (1.6 ft.)		10833A³ 10833B³ 10833C³ 10833D³	\$ 80.00 ea. 90.00 ea. 100.00 ea. 80.00 ea.	
	HP Vectra PC, IBM PC/AT	RS232C Interface cable for 7440A Opt. 001, 7470A Opt. 001, 7475A Opt. 001, DraftPro and 758X. Shielded.		3.0m (9.9 ft.)	24542G	24542G⁴	\$ 60.00 ea.
		RS232C Interface cable for 7440A Opt. 001, 7470A Opt. 001, 7475A Opt. 001, DraftPro and 758X. Shielded.		1.2m (3.9 ft.) 5.0m (16.7 ft.)	(13242G)	17255M⁵ 13242-60010⁵	\$ 44.00 ea. 69.00 ea.
	RS232C Interface cable for 7510A or 7550A. Shielded.		3.0m (9.9 ft.)	24542H	24542H⁴	\$ 60.00 ea.	
	RS232C Interface cable for 7510A or 7550A. Shielded.		1.2m (3.9 ft.)		17255D⁶	\$ 44.00 ea.	
PORTABLE and Portable PLUS	RS232C Interface cable for 7440A Opt. 001, 7470A Opt. 001, 7475A Opt. 001. Shielded.		1.5m (5.0 ft.)		92221P	\$ 42.00 ea.	
	HP-IL Interface cable for 7470A Opt. 003.		0.5m (1.6 ft.) 1.0m (3.3 ft.) 5.0m (16.7 ft.)		82167A 82167B 82167D	\$ 6.00 ea. 8.00 ea. 10.00 ea.	
					17455A¹ and 40242M	\$ 82.00 ea. 75.00 ea.	
2393A, 2397A Terminals	RS232C Interface cable for 7470A Opt. 001, 7475A Opt. 001 or DraftPro in terminal mode (eavesdrop). Both cables required. Shielded.		1.0m (3.3 ft.) 5.0m (16.7 ft.)	40242M	17455A¹ and 40242M	\$ 82.00 ea. 75.00 ea.	
	RS232C Interface cable for 7510A or 7550A in terminal mode (eavesdrop). Shielded.		3.0m (9.9 ft.) 5.0m (16.7 ft.)	40242M	17355M or 40242M	\$ 66.00 ea. 75.00 ea.	
	HP-IB Interface cable for ColorPro (7440A Opt. 002), 7470A Opt. 002, 7475A Opt. 002, 7510A, 7550A, DraftPro ² and 758X. Shielded. Terminal requires 40210H interface.		1.0m (3.3 ft.) 2.0m (6.6 ft.) 4.0m (13.2 ft.) 0.5m (1.6 ft.)		10833A³ 10833B³ 10833C³ 10833D³ 40210H	\$ 80.00 ea. 90.00 ea. 100.00 ea. 80.00 ea. 235.00 ea.	
					17255D	\$ 44.00 ea.	
					17255F	\$ 44.00 ea.	
Apple Macintosh	RS232C Interface cable for ColorPro (7440A Opt. 001), 7470A Opt. 001, 7475A Opt. 001, DraftPro Draftmaster and 758X. Shielded.		1.5m (5 ft.)		92219M⁸	\$ 45.00 ea.	
	RS232C Interface cable for 7510A or 7550A. Also requires 92219M cable above. Shielded.		1.5m (5 ft.)		92224F	\$ 25.00 ea.	

¹Piggyback male and female RS232C (Y-cable) supports eavesdrop mode.

²Requires 17570A HP-IB interface

⁵Requires 24541B dual RS232/422 interface card, see page 134. For terminal emulation, AdvanceLink software is required, see page 133.





⁴Requires 24540B serial/parallel or 24541B dual RS232/422 interface card, see page 134. For terminal emulation, AdvanceLink software is required, see page 133.

³Quantity break prices are available, see page 74.



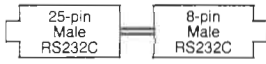

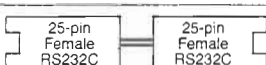

⁸Macintosh Plus also requires Apple cable no. 699-0372 Peripheral Adapter cable.

Chart continued next page

Plotter cables (cont.) (ColorPro (7440A), 7470A, 7475A, 7510A, 7550A, DraftPro, DraftMaster & 758X Plotters)

Plotter to:	Description	Connector Description	Length	Original system Product no.	Product no.	Price
Apple Macintosh Plus/SE/II	RS232C Interface cable for ColorPro, 7475A, DraftPro Series, Draftmaster, 7600 Series Electrostatic plotters.		1.5m (5 ft.)		NEW! 17302A	\$ 60.00 ea.
	RS232C Interface cable for 7550. Also requires 17302A cable above.		1.5m (5 ft.)		92224F	\$ 25.00 ea.
Apple IIc	RS232C Interface cable for ColorPro (7440A Opt. 001), 7470A Opt. 001, 7475A Opt. 001, DraftPro and 758X. Shielded.		1.5m (5 ft.)		92219N	\$ 45.00 ea.
	RS232C Interface cable for 7510A or 7550A. Also requires 92219N cable above. Shielded.		1.5m (5 ft.)		92224F	\$ 25.00 ea.
Apple IIe	RS232C Interface cable for ColorPro (7440A Opt. 001), 7470A Opt. 001, 7475A Opt. 001, DraftPro DraftMaster and 758X. Shielded.		3.0m (9.9 ft.)		17355M	\$ 66.00 ea.
	RS232C Interface cable for 7510A or 7550A. Shielded.		3.0m (9.9 ft.)		17355D	\$ 66.00 ea.

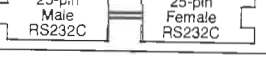
Terminal cables

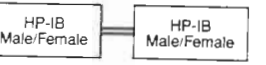
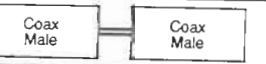
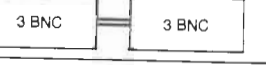
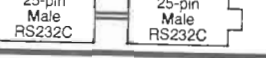



Terminal to:	Description	Connector Description	Length	Original system Product no.	Product no.	Price
HP 3000	U.S./European modem cable. Shielded.		5.0m (16.7 ft.)	40242M	40242M	\$ 75.00 ea.
	RS232C Interface cable for direct connect to HP 3000 ATP.		5.0m (16.7 ft.)	40242X	40242X	\$ 75.00 ea.
	RS422 Interface cable for direct connect to HP 3000 ATP.		5.0m (16.7 ft.)	40242P	40242P	\$ 75.00 ea.
	RS232C Interface cable for direct connect to HP 3000, protected against lightning-induced transients. Shielded.		5.0m (16.7 ft.)	40242Y	40242Y	\$105.00 ea.
	RS232C extension cable.		5.0m (16.7 ft.)	40242C	40242C	\$105.00 ea.
	RS232C modem bypass cable used with HP 12966 interface PCA.		5.0m (16.7 ft.)	40242Z	40242Z	\$105.00 ea.
Printers	RS232C Interface cable for serial printers such as ThinkJet (2225D) and QuietJet Plus (2227A). Shielded. Requires 40210R interface.		5.0m (16.7 ft.)	40242G	40242G 40210R	\$ 75.00 ea. 235.00 ea.
	Centronics type (parallel) interface cable for printers such as ThinkJet (2225C) and QuietJet Plus (2227A). Shielded. Requires 40210P interface.		1.0m (3.3 ft.)	40242D	40242D 40210P	\$105.00 ea. 235.00 ea.
HP-IB Printers & Plotters (2393A and 2397A only)	HP-IB Interface cable for printers such as ThinkJet (2225A) and plotters such as 7475A Opt. 002. Shielded. Terminal requires 40210H interface.		1.0m (3.3 ft.)		10833A ³	\$ 80.00 ea.
			2.0m (6.6 ft.)		10833B ³	90.00 ea.
			4.0m (13.2 ft.)		10833C ³	100.00 ea.
			0.5m (1.6 ft.)		10833D ³	80.00 ea.
Video Display	Composite video cable for 2393A.		0.4m (1.5 ft.)		40210H 40242V	235.00 ea. \$ 25.00 ea.
	RGB video cable for 2397A.		0.4m (1.5 ft.)		40242R	\$ 40.00 ea.
Modems	U.S./European modem cable. Shielded.		5.0m (16.7 ft.)	40242M	40242M	\$ 75.00 ea.

³Quantity break prices are available, see page 74.

HP 3000 cables

HP 3000 to:	Description	Connector Description	Length	Original system Product no.	Product no.	Price
Modems	Connects HP 3000 to modem types 103212 and 202S. Shielded.		7.6m (25 ft.)	(30062B)	30062-60022	\$ 75.50 ea.
			15.0m (50 ft.)	(30062B Opt. 001)	30062-60023	97.50 ea.

Multiplexer cables

System	Description	Connector Description	Length	Product no.	Price
98642A Multiplexer	Direct connect cable		15.0m (50 ft.)	92219R	\$ 55.00 ea.
	Modem cable		5.0m (16.7 ft.)	92219S	\$ 55.00 ea.
	RJ-11 cable		15.0m (50 ft.)	92219T	\$ 21.00 ea.
	RJ-11 to RS232C adapter plug. Adapter consists of RJ-11 female and RS232C male.		5cm x 6cm (2 in. x 2.3 in.)	 92219U	\$ 19.00 ea.
27140A Multiplexer	Modem cable		5.0m (16.7 ft.)	92219Q	\$ 55.00 ea.

SCSI (Small Computer System Interface) cables

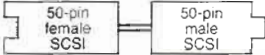
HP 9000 Series 300 CPU to:	Description	Connector Description	Length	Product no.	Price
SCSI fixed disc drive	SCSI peripheral interface cable for fixed disc desktop drives (795XS). Shielded.		0.5m (1.6 ft.)	92222A	\$49.00 ea.
			1.0m (3.3 ft.)	92222B	55.00 ea.
			2.0m (6.6 ft.)	92222C	59.00 ea.
	SCSI peripheral interface cable for fixed disc desktop drives (795XS). Shielded.		1.0m (3.3 ft.)	92222D	\$55.00 ea.

HELPFUL IDEAS!—Use these drawings of connectors to help identify the types you need.



50-pin male (for 262X Terminals).



30-pin female (for 264X Terminals)
48-pin female connector, not shown.



male and female standard 26-pin RS232C connectors.



male and female 14-pin multipoint cable connectors.



male and female 3-pin connectors for HP 3000 ATP RS232C interface.
male and female 5-pin connectors for HP 3000 ATP RS422 interface.*

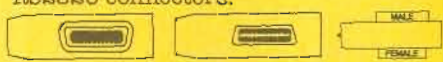

male/female HP-IB connectors.



male and female HP-IL connectors.



male coaxial (video) connector.



male and female 36-pin Centronics-type connector.



male and female 9-pin sub-miniature D connector.



male 5-position circular DIN.



male RJ-11 plug.

*Same shape as 3-pin ATP connectors but with 5 pins.

DISCS & TAPES

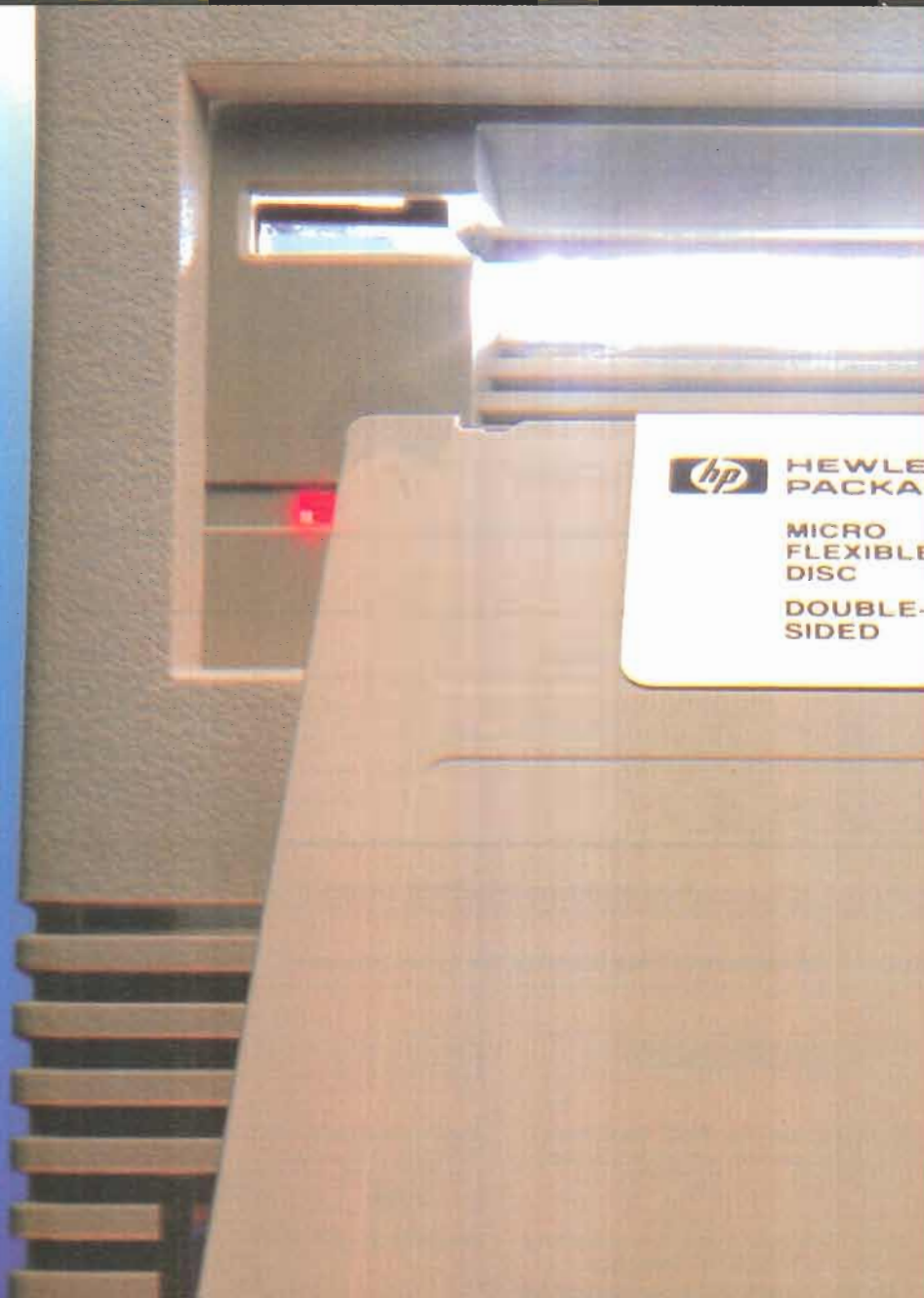

HP 3.5-inch discs...Hewlett-Packard pioneered their broad use years ago. That makes HP's track record with microfloppies one of the longest in the industry. Turn the page to learn more about the only flexible discs tried, tested and approved for use on HP disc drives.

3.5-inch discs	86
5.25-inch discs	87
8-inch discs	87
Disc storage accessories	88
Data cartridges	91
Cartridge/cassette accessories	93
Magnetic tape	94
Rigid discs	96
Cleaning accessories	98

Free surface delivery!

Discs & Tapes 85
3.5 & 5.25 in. discs



My product plan represents days of number-crunching, weeks of research and months of competitive analysis. And I trust it all to HP flexible discs.

Until recently, every product I introduced involved mounds of paper: research papers, confidential documents and scribbled notes from vendors, plus the pages of my typed product plan.

Today, I work smarter—I keep data, background information and my product plan-in-progress on HP flexible discs.

Why? Because I'm able to retrieve and correct data, in its entirety, whenever it's needed. So I spend my time composing instead of hunting for data.

I'm able to carry work home or on travel with ease, because it occupies only a few 3.5-inch discs.

And I can trust HP discs with my 100-page product introduction plan. Because at HP, quality dictates the blueprint of all flexible discs.

Uncompromised performance guaranteed HP disc performance is tested several ways. First, they make sure their discs comply with the exact engineering specifications of their disc drives.

Then, their discs must then pass a series of rigorous tests, during manufacturing and at final certification.

It's not until they're satisfied that the discs are 100 percent error-free that they give them the HP label. Even then, HP's research engineers have conducted comparison tests to determine performance.

My managers know all this, and they're as pleased with my choice of discs as they are with my work.

They're also pleased with our savings, because we enjoy substantial quantity discounts by purchasing 100 packs.

Overwrite: A Test to Measure the Ability to Write over Previously Recorded Data

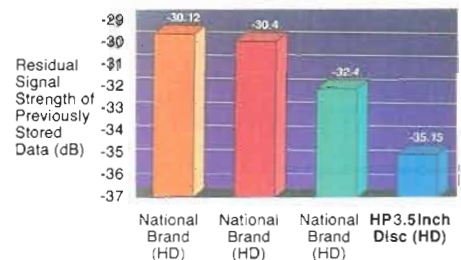

HP is lowest on Residual Signal. HP engineers tested four popular brands of 3.5 inch flexible discs. They first recorded data on each disc, then recorded new data over the same area of the discs. Ideally, each brand of media would not have the old signal present. They found HP discs had the lowest signal level from the old data.

See the next two pages for ordering information.



"After investing \$50,000 in test equipment and six months of my time, why would I want to scrimp on the discs?"

"As the project engineer, I'm conducting experiments that require me to run aging tests over a six-month period. I gather data from all these tests and at the end of the six months the data is correlated. All the test results end up on three and one-half inch discs. I want to be sure the data is still there when I come back. With HP's quality, I've got the best chance I can get."

Steve Weiss

Steve Weiss, project engineer
Astec USA (HK), Ltd., division of BSR
OEM supplier of high-volume consumer
and industrial electronics.

3.5-inch Microfloppy discs

Description	Use with HP disc drives & storage systems	Product number	Price
Box of 10, 3.5-inch, single-sided, auto-shutter, unformatted, 270 KByte (formatted capacity).	HP 9121D/S, 9133A/B, 9133V/XV disc drives.	92191A <i>Reduced price!</i>	(box 10 discs) \$26.00 box (2-4) 23.00 box (5-19) 20.00 box (20+) 19.00 box
Box of 10, 3.5-inch, double-sided, auto-shutter, unformatted, 710/720 KByte (HP formatted capacity).	HP 45813A, 9114A/B, 9122D/S, 9123D, 9133D/H/L, 9153A/B/C disc drives, HP Portable Vectra CS, HP Vectra CS/ES/RS and Touchscreen (HP 150) PCs.	92192A <i>Reduced price!</i>	(box 10 discs) \$29.00 box (2-4) 26.00 box (5-19) 24.00 box (20+) 23.00 box
Box of 100, 3.5-inch, double-sided, auto-shutter, unformatted, 710/720 KByte (HP formatted capacity).	HP 45813A, 9114A/B, 9122D/S, 9123D, 9133D/H/L, 9153A/B/C disc drives, HP Portable Vectra CS, HP Vectra CS/ES/RS and Touchscreen (HP 150) PCs.	92192N <i>Reduced price!</i>	(box 100 discs) \$230.00 box (2-4) 209.00 box (5+) 188.00 box
Package of 250, multi-colored disc labels for use with 92192N above.		92192R	(per pkg of 250 labels) .. \$19.95 pkg.
Box of 10, 3.5-inch, high-density, double-sided, auto-shutter, unformatted, 1.42/1.44 MByte (formatted capacity). NOTE: For use with 1.42/1.44 MByte disc drives only.	HP 45813A, 9122C and 9153C disc drive, HP Portable Vectra CS and HP Vectra CS/RS ES PCs.	92192X <i>Reduced price!</i>	(box 10 discs) \$69.00 box (2-4) 64.00 box (5-19) 59.00 box (20+) 55.00 box

Five-year warranty

HP flexible discs are warranted to be free from defects in material and workmanship for five years after shipment or HP will replace the disc absolutely free. Any damage sustained to the heads or media, or any consequential damage resulting from the use of non-HP media or cleaned disc media in HP equipment is excluded from warranty or service contract coverage, but will be repaired subject to HP's standard time and material charges. Use of non-HP media or cleaned disc media, however, does not affect warranty or service contract coverage of other components of the disc drive not associated with the head-media interface.

Look for *Reduced price!*
and save as much as 24%
off our regular prices

"We have never had a failure with an HP disc"

"Why do I prefer HP discs? First of all, it's easy to order. We pick up the phone and call HP DIRECT. Within one to two days the goods are delivered. So, the convenience is very important to us. And, technically, the assurance of top quality is just as important. A programmer's time is valuable. When you lose a program, you have often lost days of work. The best way to protect against that is to have quality media."

Herb Pardula, v.p. of engineering
SAT, SYSTEMS FOR AUTOMATIC TEST
Supplier of Microwave ATE based on
HP computers and instrumentation.

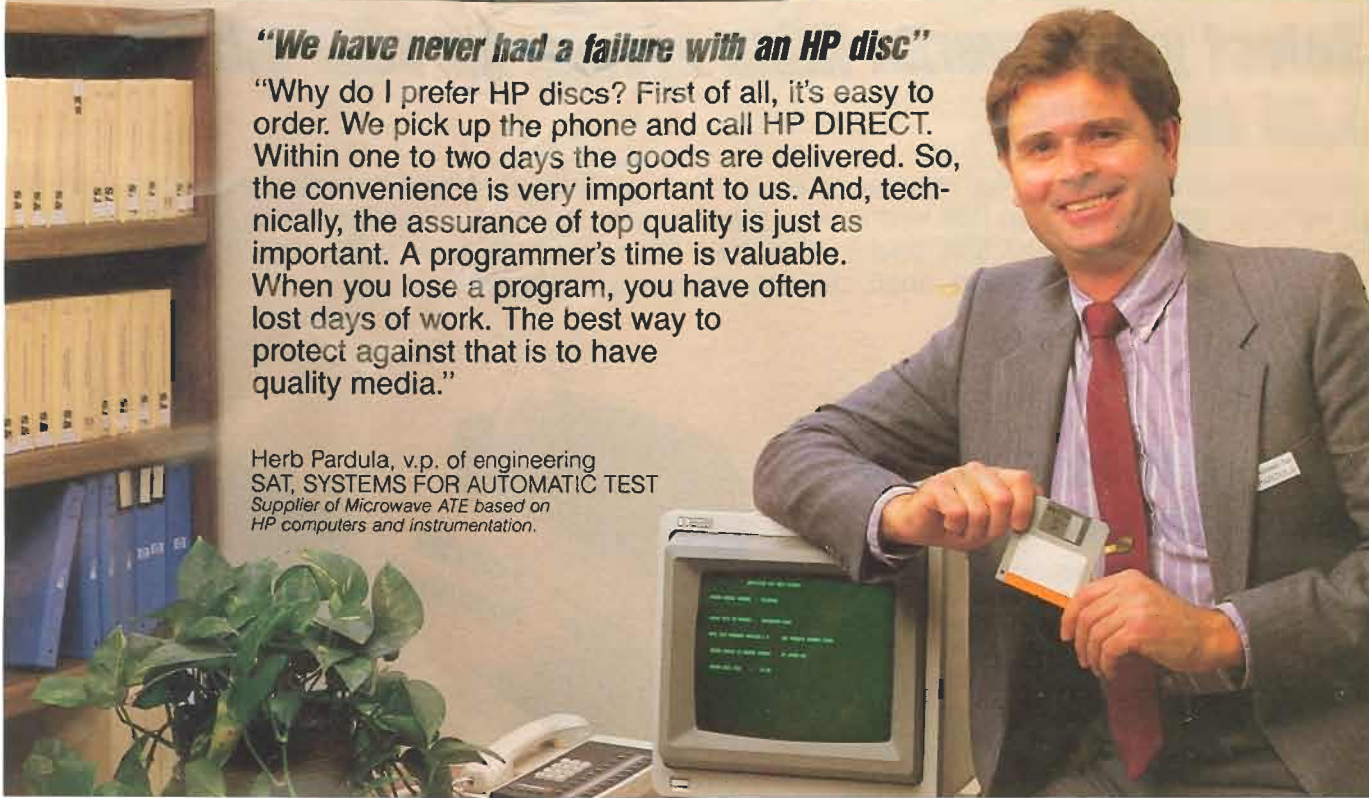

5.25-inch Flexible discs

Description	Use with HP disc drives & storage systems	Product number	Price
Box of 10, 5.25-inch, double-sided, unformatted, 360 KByte (formatted capacity).	HP 45811A, 82901M, 82902M, 9125S, 9127A, 9135A disc drives, 9826, 9836 computers and HP Vectra CS/ES/RS PCs.	92190A <i>Reduced price!</i>	(box/10 discs) \$19.00 box (2-4) 17.00 box (5-19) 15.00 box (20+) 14.00 box
Package of 50 in 5 FlexFiles, 10 discs per FlexFile, 5.25-inch, double-sided, unformatted, 360 KByte (formatted capacity).	HP 45811A, 82901M, 82902M, 9125S, 9127A, 9135A disc drives, 9826, 9836 computers and HP Vectra CS/ES/RS PCs.	92190L	(pkg/50 discs) \$99.00 pkg. (2-4) 94.00 pkg. (5+) 89.00 pkg.
Box of 100, 5.25-inch, double-sided, unformatted, 360K-byte (formatted capacity).	HP 45811A, 92901M, 82902M, 9125S, 9127A, 9135A disc drives, 9826, 9836 computers and HP Vectra CS/ES/RS PCs.	92190N <i>Reduced price!</i>	(box/100 discs) \$135.00 box (2-4) 124.00 box (5+) 116.00 box
Box of 10, 5.25-inch, high-capacity, double-sided, unformatted, 1.2 MByte (formatted capacity).	HP 45812A, Vectra PC's high-capacity 1.2 MByte internal drive and HP Vectra ES/RS PCs.	92190X <i>Reduced price!</i>	(box/10 discs) \$39.00 box (2-4) 35.00 box (5-19) 32.00 box (20+) 29.00 box
Box of 100, 5.25-inch, high-capacity, double-sided, unformatted, 1.2 MByte (formatted capacity).	HP 45812A, HP Vectra PC's high-capacity 1.2 MByte internal drive and HP Vectra ES/RS PCs.	92190Z <i>Reduced price!</i>	(box/100 discs) \$300.00 box (2-4) 270.00 box (5-19) 240.00 box (20+) 210.00 box

8-inch Flexible discs

Description	Use with HP disc drives & storage systems	Product number	Price
Box of 10, 8-inch, double-sided, unformatted, 1.2M-byte (formatted capacity).	HP 9895A	92195A	(1 box of 10 discs) \$61.00 box (2-4) 57.00 box (5-19) 53.00 box (20+) 49.00 box
Box of 10, 8-inch, single-sided, unformatted, 500K-byte (formatted capacity).	HP 9885M/S, HP 1000 Models 20 and 25 (2174A/B and 2175A/B subsystems).	9164-0105	(1 box of 10 discs) \$44.00 box (2-4) 41.00 box (5-19) 38.00 box (20+) 35.00 box
One 8-inch, single-sided, HP 9885/9825 formatted, 500K-byte capacity.	HP 9885M/S drives used with 9825A/S computers.	09885-90045	Single disc \$15.00 ea.

Select your favorite filing system for your 3.5 in. and 5.25 in. discs!

No more frantic searching for misplaced discs! Save yourself time and minimize disc damage with an HP disc storage system that keeps your discs organized, easy to locate, clean and protected. For your convenience, all 3.5 in. and 5.25 in. disc storage systems are listed together in this section, organized by desktop, shelf, drawer, and portable storage.

Roll-top files add a touch of class to your desktop

Enhance your office decor with these handsome roll-top files for storing your personal discs. The genuine rosewood cover lends richness to the file and also slides back and out of the way for easy access. Constructed of durable plastic to ensure long-lasting protection with elegant styling. Also features rubber anti-skid feet and built-in disc dividers.



92191R Roll-top file for 3.5 in. discs.
 Capacity: 50 discs.
 (1 unit) \$39.00 ea.
 (2-4) 36.00 ea.
 (5+) 33.00 ea.

92194N Roll-top file for 5.25 in. discs.
 Capacity: 120 discs.
 (1 unit) \$49.00 ea.
 (2-4) 46.00 ea.
 (5+) 43.00 ea.



Keep your 3.5 in. discs safe

Protect your microfloppy discs in this compact desktop file. Stores up to 60 discs in a durable acrylic case. Index dividers make it easy to organize your discs for easy retrieval. Also features a flip up lid for easy access.

92191D Desktop file for 3.5 in. discs.
 Capacity: 60 discs.
 (1 unit) \$39.00 ea.
 (2-4) 35.00 ea.
 (5+) 30.00 ea.

Flip-top file offers instant access

Just flip up the hinged lid. The discs inside this practical desktop file are clearly displayed and readily accessible. Tabbed dividers and index labels are included to make it simple to organize your discs. Made of durable plastic, these files offer protection from office hazards such as dust, debris and moisture.

92191Q Compact file for 3.5 in. discs.
 Capacity: 40 discs.
 (1 unit) \$22.00 ea.
 (2-4) 20.00 ea.
 (5+) 18.00 ea.

92194A Compact file for 5.25 in. discs.
 Capacity: 60 discs.
 (1 unit) \$39.00 ea.
 (2-4) 36.00 ea.
 (5+) 33.00 ea.



Micro carrying case tucks compactly in a briefcase



One of these micro carrying cases takes up so little space it's easy to safely transport up to five 3.5 or 5.25 in. discs in a briefcase. Pop-open case has self-locking lid for extra safety.

92191M Micro carrying case pack for 3.5 in. discs. Capacity: 5 discs each case.
 (1 pkg. of 3 cases) \$10.50 pkg.

92191Z Micro carrying case pack for 5.25 in. discs. Capacity: 5 discs each case.
 (1 pkg. of 7 cases) \$25.00 pkg.

Interlocking units expand to fit your space.

Flexibility is built into this disc storage system. FlexFile units interlock on the sides, top or bottom, so you can stack units like building blocks—either vertically or horizontally. Just add new units as your needs expand and make the most of any work space. Your discs automatically flip forward for easy access when the FlexFile drawer opens. And when you need to transport discs, simply separate out a modular unit and take it with you. FlexFiles are constructed of tough polystyrene, for sturdy, dust-free protection. Includes adhesive index labels and instructions. Discs not included.



92191E FlexFiles for 3.5-inch discs. Package of five FlexFiles. Each FlexFile unit holds up to 10 discs.

(1 pkg.)	\$37.00 pkg.
(2-4)	34.00 pkg.
(5+)	29.00 pkg.

92194E FlexFiles for 5.25-inch discs. Package of five FlexFiles. Each FlexFile unit holds up to 10 discs.

(1 pkg.)	\$37.00 pkg.
(2-4)	34.00 pkg.
(5+)	29.00 pkg.

Cushion your discs for safe transport.



Fragile discs are protected whenever they must be carried from one place to another because of the unique features of this portable filing system. Crimped pockets cushion each disc to prevent wrinkles or bends. And finding the disc you need is easy with the aid of color-coded index stripes on each pocket. File organization is simplified by an index on outside spine for listing discs. The floating axle design eliminates additional stress if the binder is dropped. A Velcro fastener ensures that the vinyl cover stays securely closed.

92191F Portable album file for 3.5-inch discs. Capacity: 20 discs.

(1 unit)	\$43.00 ea.
(2-4)	40.00 ea.
(5+)	37.00 ea.

92194G Portable album file for 5.25-inch discs. Capacity: 20 discs.

(1 unit)	\$43.00 ea.
(2-4)	40.00 ea.
(5+)	37.00 ea.

Reduce visual clutter with matching designs.

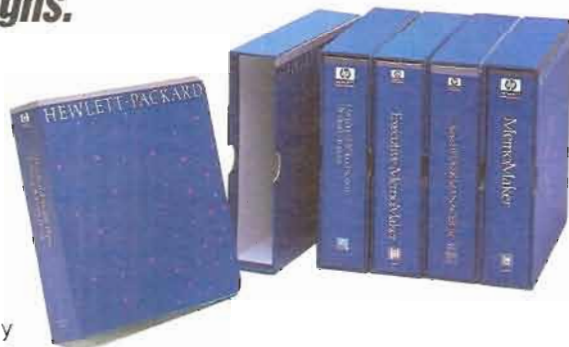

Shelve your discs in library album books designed to duplicate the size, color and style of your boxed software manuals. Your 3.5-inch discs slide into vinyl album pages: the album fits inside a cloth-covered box. Complete with 10 static-resistant vinyl pages.

92191H Library album book for 3.5-inch discs. Capacity: 20 discs.

(1-4 books)	\$26.00 ea.
(5+)	19.00 ea.

Increase capacity by adding album pages

Expand the capacity of your 92191H library album book by adding more static-resistant vinyl pages. File cards are included to help identify each disc.

92191L Package of 20 pages for 3.5-inch discs. For use with 92191H. Capacity: 40 discs.

(1 pkg.)	\$26.00 pkg.
(2-4)	23.00 pkg.
(5+)	21.00 pkg.



Hanging file pages suspend discs in drawers or filing cabinets

Gain safety and convenience by hanging your discs in sturdy, vinyl pockets suspended from the rails of your filing cabinet. Available in either U.S. or European suspension frame sizes—U.S. 12.25 in. (311 mm) standard width and European 330 mm (13 in.) standard width. File cards are included to identify each disc.



Hanging file pages for 5.25 in. discs. Package of 10. Capacity: 20 discs.

- 92194P** (U.S.)
- 92195P** (European)
(Discs not included.)
- (1 pkg.) \$26.00 pkg.
- (2-4) 23.00 pkg.
- (5+) 20.00 pkg.



Hanging file pages for 3.5 in. discs. Package of 10. Capacity: 40 discs.

- 92191P** (U.S.)
- 92191G** (European)
(Discs not included.)
- (1 pkg.) \$29.00 pkg.
- (2-4) 26.00 pkg.
- (5+) 23.00 pkg.

Micro disc case saves space and money

This durable plastic 3.5 in. micro disc case holds 10 microfloppy discs in library-like fashion for easy fingertip retrieval. The disc holder slides open to reveal your discs with step filing. Slide it closed and file snaps shut for library storage or for convenient transport. Disc identification and spine labels included.

- 92191T** Micro disc case for 3.5 in. discs. Capacity: 10 discs.
(1 case) \$7.00 ea.



HELPFUL IDEAS!

Take your choice. Store discs on your desk, shelf, or cabinet.

HP Disc Storage	Style	Disc storage capacity								Product number	Page no.
		10	15	20	35	40	60	80	120		
On your desktop	3.5" flip top					•				92191Q	88
	3.5" flip top							•		92191D	88
	3.5" roll top							•		92191R	88
	5.25" flip top								•	92194A	88
	5.25" roll top									•	92194N
On your shelf	3.5" album			•						92191F	89
	3.5" album			•						92191H	89
	3.5" FlexFiles							•		92191E	89
	5.25" album			•						92194G	89
	5.25" FlexFiles								•	92194F	89
In your desk drawer	3.5" hanging file							•		92191P (U.S.) 92191G (European)	90
	5.25" hanging file			•						92194P (U.S.) 92195P (European)	90
Portable storage	3.5" micro case	•								92191T	90
	3.5" micro case		•							92191M	88
	5.25" micro case				•					92191Z	88



Handle with care. If left exposed, discs are easily damaged by dust, heat, fingerprints, bending and accidental spills. The critical data on your discs deserves to be protected from these hazards. To help you select the system that is best for you, refer to the chart on the left.

**Choose HP Tape Cartridges for fast, easy reliable backup
—it's designed expressly for your HP tape drive!**

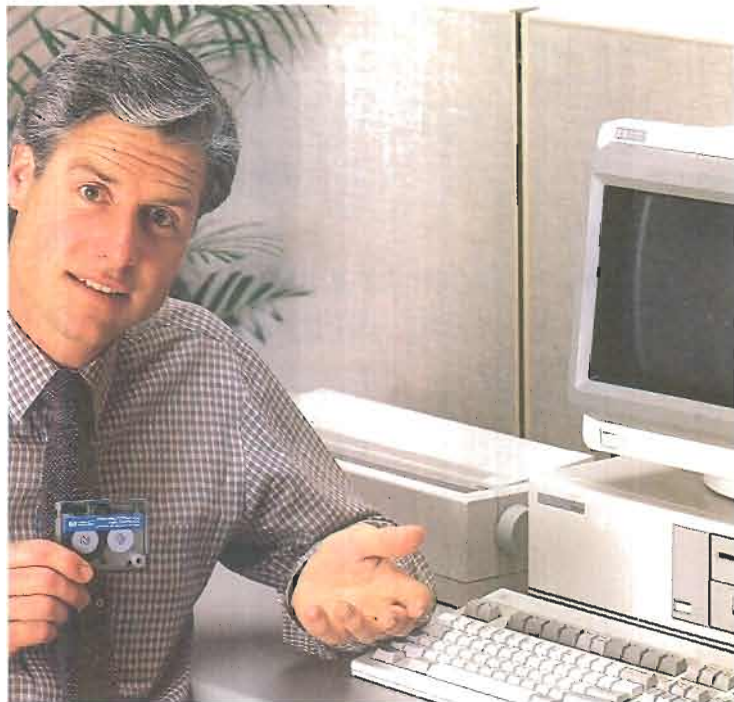

Built-in compatibility means you get total backup security with HP quarter-inch Tape Cartridges.

We engineered and tested HP Tape Cartridges expressly for HP Tape Drives. But that built-in compatibility is just one of the reasons these tape cartridges are the safest choice you can make for your valuable backup files. HP Tape Cartridges also stay cleaner, increase drive head life and improve backup speed.

The most trouble-free tape ever made HP Tape Cartridges feature a carbon backcoating over the length of the tape. This backcoating cuts the static build-up which can attract dust. The tape stays cleaner, putting less wear on your drive head. That means both the tape and the drive last longer. It also means faster, safer backups. Dust and debris keep a drive head from writing accurately. So it tries again. And again. By staying cleaner than other tapes, HP Tape Cartridges actually save you backup time. They also reduce the chance of "read" errors if you ever have to reconstruct your files.

Certified & preformatted—you save an hour per tape You can use HP Tape Cartridges as is, right from the package, reducing backup time.

Choosing just any tape cartridge for your HP Tape Drive could increase backup time, hurt your drive's longevity, and, most important, compromise your data. For worry-free, convenient backups, select the tapes that have been 100 percent mechanically and electromagnetically tested for your HP Tape Drive—HP Tape Cartridges.

See the next page for formatted or unformatted quarter-inch HP Tape Cartridges for your drive. They're only a toll-free telephone call away.

How to choose the right HP data cartridge for your HP tape drive.

HP tape drive model no.	HP data cartridge Product no.	Storage Capacity
35401A, 7908/11/12/14, 7942A, 7946A, 9144A, and 9145A (read only, doesn't write).	88140LC* 88140SC*	67 Mbyte 16 Mbyte
82161A Digital cassette drive	82176A	128 Kbyte
9142A tape drive	92242L* 92242S*	60 Mbyte 15 Mbyte
9821A Calculator, 9830A/B Desk Top Computer, 9865A Cassette Memory	9162-0050	—
HP 1000 & 3000 computer systems; HP series 264X display terminal; HP 85A, 9815A/S, 9825A/S, 9831A/B (system 35), 9835, 9845A/B/C/S/T (system 45) Desktop computers; 9875A, 9877A Tape Units; and 9915 opt. 001 Modular computer	98200A	96 Kbyte to 250 Kbyte on mainframe
D1671A tape drive	92192T	40 Mbyte
9145A tape drive	92245L 92245S	133 Mbyte 32 Mbyte

*88140LC/SC and the 92242L/S data cartridges are not interchangeable. The 92242L/S cartridges work only with the 9142A drive.

For storage accessories, see page 93.

Choose our high-density cartridges for the times when reliable backup is critical

If you need the assured reliability of pre-certified tapes, these tapes are for you.

These high-density data cartridges are formatted and certified for dependable backup with HP 7908/11/12/14, 9144A, 7942A, 7946A and 35401A tape drives.

They're ideal for data exchange among HP systems, plus software distribution and data/transaction logging.

And because they're already certified, you save from 15 to 75 minutes per tape. Formatted into 1Kbyte user data blocks.

88140LC 67Mbyte (formatted) Tape Cartridges. Five per box.	
(1 box)	\$219.00 box
(2-4)	207.00 box
(5-19)	192.00 box
(20-99)	185.00 box
(100+)	178.00 box
88140SC 16Mbyte (formatted) Tape Cartridge. Five per box.	
(1 box)	\$169.00 box
(2-4)	159.00 box
(5-19)	149.00 box
(20+)	142.00 box

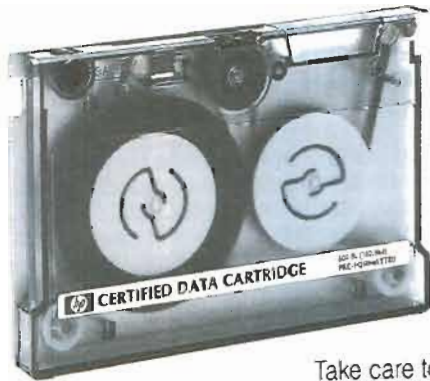

Take care to order the correct tape for your drive—this cartridge cannot be used interchangeably with the 92242L/S.



Clean as a whistle for secure Vectra backups

A carbon backcoating over the length of the Vectra 40Mbyte Tape Cartridge cuts dust-attracting static build-up. By staying cleaner, the tape puts less wear on the drive head, saves backup time and reduces the chance of read errors. For use with the D1671A drive.

92192T Vectra 40Mbyte (formatted) Tape Cartridge. Five per box.	
(1 box)	\$175.00 box
(2-4)	159.00 box
(5-19)	149.00 box
(20+)	139.00 box



Free host time with off-line certification

Designed for HP 9142A drives only, these tapes can be formatted, initialized and certified off-line without tying up your HP 150, Vectra or IBM PC/XT/AT.

92242L 60Mbyte (unformatted) Tape Cartridges. Five per box.	
(1 box)	\$189.00 box
(2-4)	175.00 box
(5-19)	165.00 box
(20+)	155.00 box
92242S 15Mbyte (unformatted) Tape Cartridges. Five per box.	
(1 box)	\$139.00 box
(2-4)	127.00 box
(5-19)	120.00 box
(20+)	113.00 box

Two reliable choices for HP 9145A drives

Trust your valuable data to these cartridges, engineered and tested expressly for the HP 9145A drive.

92245L 133Mbyte (formatted) Tape Cartridge. Five per box.	
(1 box)	\$239.00 box
(2-4)	224.00 box
(5-19)	209.00 box
(20+)	199.00 box
92245S 32Mbyte (formatted) Tape Cartridge. Five per box.	
(1 box)	\$189.00 box
(2-4)	177.00 box
(5-19)	165.00 box
(20+)	157.00 box



Count on these tapes for rugged durability

Select our Individual Digital Cassettes, Mini-Data Cassettes or Mini Data Cartridges for a variety of HP computer systems and tape units (see chart on page 91 for compatibility).

9162-0050 Individual Digital Cassettes	
(1-9 cassettes)	\$11.00 ea.
(10-99)	8.90 ea.
(100+)	7.90 ea.
82176A 128Kbyte Mini Data Cassettes.	
10 per package	\$95.00 pkg.
98200A Mini Data Cartridges. Five per box.	
(1 box)	\$110.00 box
(2-4)	99.00 box
(5-19)	88.00 box
(20+)	78.00 box

Compact storage that's easy to expand

Store six 98200A mini data cartridges in the front cover of this padded vinyl storage binder. Then add insert pages as needed to increase storage capacity to 12-18 cartridges. Each cartridge, enclosed in its protective plastic box, is held securely in a molded compartment. Related documentation can be inserted in the center three rings or the back cover pocket.

92167M Storage Binder for use with 98200A mini data cartridges.

(1 binder)	\$21.00 ea.
(2-4)	19.00 ea.
(5+)	17.00 ea.

Add to the storage capacity of the 92167M binder with a package of three insert pages. Each insert page holds six 98200A mini data cartridges. Sturdy brass-ringed eyelets and molded storage compartments are the same high quality design and construction as the 92167M binder.

92167N Storage Binder Inserts for 92167M storage binder. For use with 98200A mini data cartridges.

(1 pkg. of 3 inserts)	\$21.00 pkg.
(2-4)	19.00 pkg.
(5+)	17.00 pkg.



Simplify backup routines and save time

The HP 35401A 1/4-inch Cartridge Auto-changer Tape Drive helps simplify operations by providing unattended backup storage. With the addition of several **92192C** Tape Cartridge Magazines, each with its own set of cartridges, you can rotate through the sets of cartridges and make backup simple for your operators. Holds up to eight standard 1/4-inch cartridges (up to 536 Mb of storage).

92192C Tape Cartridge Magazine

(1-2)	\$65.00 ea.
(3-5)	55.00 ea.
(6+)	45.00 ea.

Secure data cartridges in a locked tray



Keep your 88140LC/SC and 92242L/S data cartridges safe and organized in this handsome new storage tray. Features a key-locking, removable lid, which nests under the base when not in use. Constructed of durable high-impact plastic with transparent anti-static acrylic lid. Cream-colored base with molded slots holds up to 10 data cartridges securely in place.

92167F Data Cartridge Tray for use with 88140LC/SC and 92242L/S data cartridges.

(1-2 units)	\$45.00 ea.
(3-6)	42.00 ea.
(7+)	39.00 ea.



Albums make data cartridges easy to store, easy to carry.

Now you can store and transport your 88140LC/SC and 92242L/S data cartridges in a dust-free album that helps eliminate the mishandling and misplacing of individual cartridges. The albums are constructed of sturdy vinyl and hinged for easy access. Each album holds four cartridges.

92167L Storage Album for use with 88140LC/SC or 92242L/S data cartridges

(1 pkg. of 5 albums)	\$34.00 pkg.
(2-4)	31.00 pkg.
(5+)	29.00 pkg.

Organize up to 18 mini data cartridges under lock and key.

Here's a convenient way to organize your 98200A or 92192T mini data cartridges, while protecting them from dust, spills and "casual borrowing." This locking tray includes tabbed dividers and labels for quick identification and access, and a back-up key in case you misplace the original. A detachable hinge lets you nest the clear acrylic, anti-static lid under the cream-color, high-impact plastic base, cutting desk-top clutter so you have room to get down to business.

92192Q Data Cartridge Tray for use with 98200A or 92192T mini data cartridges.

(1-2 units)	\$45.00 ea.
(3-6)	42.00 ea.
(7+)	39.00 ea.



Here's the half-inch tape that came in first, test after test. Choose it for superior HP tape drive performance!

You can be sure that your HP tape drive turns in a winning performance time after time by selecting HP half-inch magnetic tape. Why? Because this is the tape that beat out every other major half-inch tape on the market during six months of testing.

We invested time and money in these tests because we weren't comfortable recommending just any ANSI specified tape for our drives. And you shouldn't be comfortable using just any tape either.

After all, a tape may work perfectly on one drive but not on another because of differences in the head, tape path and/or electronics.

But thanks to our extensive testing, you can be satisfied that this tape does more than just "match" your HP drive. It actually optimizes drive performance, eliminating the "skip and rewrite" problems inferior tape can cause.

We tested 26 tapes in the same way on the same HP tape drive for 220 full reel passes. Then we tested for wear, environmental and magnetic properties. This is the one tape that passed all our tests with flying colors. And it's setting new standards for signal quality, cleanliness and durability with customers such as NASA.

HP tape is inspected over every inch to assure that it's totally error-free, certified end-to-end for use through 6250 characters per inch, and warranted against defects for five years.

And you don't just have our word. You have our written guarantee!

This magnetic tape sets new standards for signal quality, tape cleanliness and durability. We inspect it against errors, certify it for use through 6250 CPI, and give it a full five-year warranty. No wonder NASA chose it for the space program!



Magnetic tapes

Description	Systems	Product no.	Price
600 ft. (183m) tapes on reels, in seals 0.5 in. (12.7mm) wide, box of 10	HP 7970, 7971, 7974, 7976, 7978, 7979, 7980 Tape Drives and subsystems	92150D	(1 box of 10 tapes) \$135.00 box (2-5) 125.00 box (6+) 115.00 box
1200 ft. (366m) tapes on reels, in seals 0.5 in. (12.7mm) wide, box of 10	HP 7970, 7971, 7974, 7976, 7978, 7979, 7980 Tape Drives and subsystems	92150E	(1 box of 10 tapes) \$175.00 box (2-5) 165.00 box (6+) 155.00 box
2400 ft. (732m) tapes on reels, in seals 0.5 in. (12.7mm) wide, box of 10	HP 7970, 7971, 7974, 7976, 7978, 7979, 7980 Tape Drives and subsystems	92150F <i>Reduced price!</i>	(1 box of 10 tapes) \$229.00 box (2-5) 215.00 box (6+) 200.00 box
2400 ft. (732m) tapes on reels, in Easy Load II cartridges 0.5 in. (12.7mm) wide, box of 10	HP 7976 Tape Drive only	92150P	(1 box of 10 tapes) \$260.00 box (2-5) 245.00 box (6+) 230.00 box

Mag tape care is easy with the right accessories.

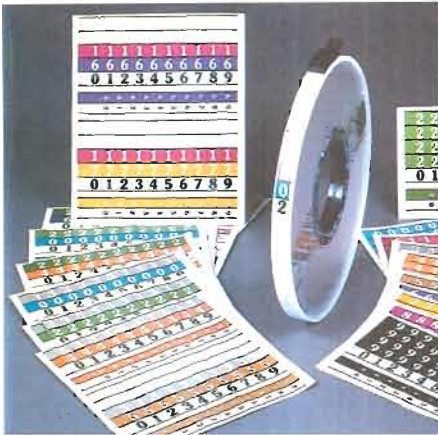

Blank white adhesive labels.

For quick identification and indexing of your tapes and other items. Roll of 1000 labels.

92150K Magnetic Tape Reel Labels
(1-4 rolls) \$78.00 ea.
(5+) 74.00 ea.

Replace broken reels and keep extras on hand. Five 10.5 in. reels to a box. Clear plastic front.

92150X Mag Tape Take-up Reels
(1 box of 5) \$30.00 bx.

Organization means time savings! Our mobile 15 reel capacity storage rack will help you and your people stay organized. Chrome-finished steel rack designed for use with 600 ft., 1200 ft., or 2400 ft. tapes in seals. Order today and transform your desk or shelf into an organized data library.

92206T Mag Tape Rack
(1-2 racks) \$26.00 ea.
(3+) 20.00 ea.

Accurately adjust tape head alignment. Our Head Alignment Tape has tracks, recorded at 800 BPI, precisely located on its 183m (600 ft.) length. Used during testing or adjustment of 7 and 9 track head alignment on 12.7mm (0.5 in.) tape units. In protective canister.

9162-0027 Head Alignment Tape \$245.00 ea.

Conveniently mark your tape. These reflective, pressure-sensitive markers offer convenient tape beginning and ending indicators. 250 markers to a card.

92150M Mag Tape Sense Markers
(1-9 cards) \$10.50 ea.
(10+) 9.50 ea.

Ring Seals for Easy Load II Self-Threading Cartridges. To be used on 2400 ft. tapes (10.5 in. reels) when using the auto-load feature on HP 7976 Tape Drives.

92150Q Ring Seals for Easy Load II Self-Threading Cartridges (box of 10)
(1 box) \$46.00 bx.
(2-5) 43.00 bx.
(6+) 40.00 bx.

Prevent misfiling! Our simple color-coded numbering system will help you eliminate misfiles in your magnetic tape library. 1000 labels (numbered 0-999).

- Designed with pressure-sensitive labels, which are inserted into label area of Tape-in-Seal cartridges.
- Each label is provided with location tabs which can be used on library tape racks or cabinets to quickly identify filing spot.

92150L Mag Tape Color/Numbering Kit. \$98.00 ea.

Mag tape storage solutions—portable or permanent



Carry 2400 ft. Mag Tapes easily with our Transport/Carrying Case. Holds up to four reels in either tape seals or Easy Load Cartridges. This case combines durable impact-resistant polyethylene construction on the outside with shock absorbing foam on the inside to ensure reliable protection when carrying or shipping your valuable data and software. Built-in hasp for your personal padlock. Dimensions: 40 H x 43.2 W x 16.5 D cm (15.8 H x 17 W x 6.5 D in.) Weight: 3.4 Kg (7.5 lbs.)

92150T Transport/Carrying Case
(1-2) \$79.00 ea.
(3+) 69.00 ea.

Efficiently store up to 300 tape reels. Our library Tape Storage Rack is designed to match our complete furniture line. It helps you utilize wall and floor space for high density tape storage at minimum cost. Up to 300 tape reels in seals may be stored in any combination of 600 ft., 1200 ft. or 2400 ft. reels. Construction is of welded steel. Color is cream-gray. Exterior dimensions: 200 H x 123 W x 33 D mm (79.5 H x 48.5 in. W x 13.2 D in.)

92272F Library Tape Storage Rack
(1) \$335.00 ea.
(2+) 308.00 ea.

Be sure to see pages 100-117 for our complete line of cabinets and furniture.



People with a lot on the line depend on HP rigid media. Here's why you should, too.

You've already invested in a top-quality HP computer. You can help assure its smooth performance by using HP rigid discs exclusively.

HP discs are matched precisely to HP drives for smooth performance. In fact, we develop our drives and media at the same time. We make sure our discs' flatness, thickness, magnetic distribution, and thermal properties match the critical specs of our drives.

Your data's safe when you use HP rigid media.

The accuracy of the HP 7925 drive is an example why so much precision testing is essential for your data's safety.

This drive detects as many as 7.5 million data bits each second and flies 27 millionths of an inch off the media surface at over 100 miles per hour.

For an idea of the exactness required for smooth operation, see Figure 1. When you see how tight the tolerance is, you'll understand why your media and drive should be as closely matched as possible.

You can trust because we test. Here's how we test our rigid discs so you can trust them with your data:

- visually inspect raw disc platters for imperfections

- mechanically analyze them for flatness and smoothness
- electronically evaluate their magnetic properties
- balance them for vibration-free rotation
- mechanically analyze them again for flatness and smoothness
- burnish the disc surfaces
- magnetically purify all the surfaces

For precise read/write head positioning, we also write permanent servo code bands for HP drives in each pack. And because we control the manufacturing and testing, we can assure the accurate head positioning of HP media.

You'd never torture media like we do. We put our media through exhaustive electromagnetic data transfer testing under "worst case" conditions. We use a marginal head, well under spec, and we write a problematic data pattern over its entire surface. If the inferior head can pick up the complex electrical transitions, the disc has proven its strength and we know you can rely on it.

We also guarantee that our discs have spare tracks on every surface so you can always count on getting sufficient memory.

Keep your system running smoothly by using only HP rigid discs. Find your drive in the chart on the following page and order your HP discs.

Store your rigid media in our multi-purpose rack. See pg. 116 for details.



You can trust your valuable data with HP rigid discs.

We've had disc drive customers who used non-HP media and developed problems. When they returned to HP rigid media, their problems cleared up.

You may find cheaper media but you won't find better or more reliable media.

The difference between our media and non-HP media is—we stand behind ours. We support the customer after the sale. We sell a product we're proud of.

Gene Williams
Gene Williams
Support Engineer
Disk Memory Division, HP

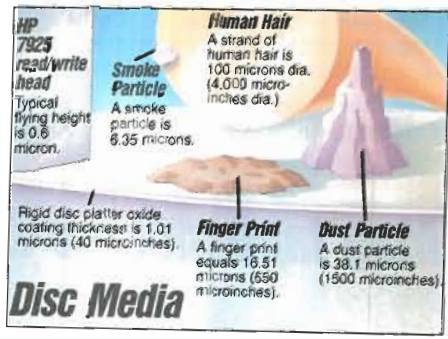

Minute substances like smoke and dust, drawn to scale, illustrate how smooth your disc must be to be properly read at a flying height of 27 millionth of an inch.



HP rigid discs are 100% tested

Rigid discs

Description	Systems	Product number	Price
2.5 MByte Disc Cartridge formatted front loading	HP 7900A, 7901A, 9880B, 12960A, 12961A, 30110A Disc Drives and Subsystems	12869A	(1-3 units) \$149.00 ea. (4-41) 127.00 ea. (42+) 116.00 ea.
9.8 MByte Disc Cartridge formatted front loading	HP 7905A, 7906H/M/S, 12962C/D, 13180A/B Disc Drives and Subsystems	12940A	(1-3 units) \$189.00 ea. (4-41) 171.00 ea. (42-99) 158.00 ea. (100+) 143.00 ea.
50 MByte Disc Pack removable formatted	HP 7920 H/M/S Disc Drives	13394A	(1-5 packs) \$560.00 ea. (6-19) 510.00 ea. (20+) 475.00 ea.
120 MByte Disc Pack removable formatted	HP 7925 H/M/S Disc Drives	13356A	(1-5 packs) \$905.00 ea. (6-19) 850.00 ea. (20+) 815.00 ea.
404 MByte Disc Pack removable formatted	HP 7935 Disc Drives	97935A	(1-4 modules) \$1250.00 ea. (5-19) 1210.00 ea. (20+) 1170.00 ea.

Rack organizes nine rigid discs.

Keep your rigid disc cartridges in order and easy to access. Our light-weight storage rack holds nine discs and makes retrieval of crucial data and programs quick and easy.

Our sturdy rack is constructed of heavy-gauge steel wire with nickel-chrome plating. Rubber non-skid feet secure your discs and protect your furniture.

92206D Rigid disc rack for 12869A and 12940A disc cartridges
(1-2 units) \$26.00 ea.
(3+) 20.00 ea.



I actually enjoy phoning in an order for supplies from the catalog." The HP employees who help us are friendly and informed, and it's more like being helped by an old friend than dealing with a large company."

*Joel Nossoff, Director
California State University,
Los Angeles
Los Angeles, California*

Removable disc is compact and compatible with the HP 1000/9000.



20.5Mbyte removable disc cartridge can be used with the HP 7907A Fixed/Removable Mass Storage Subsystem. Now you can interchange large volumes of data quickly and conveniently. In fact, with this 8-inch removable disc, you can copy data from the fixed disc in less than three minutes!

When security is essential, the removable disc can be taken off line and stored in a safe place. Its protective jacket provides additional storage safety.

The HP 7907A drive is compatible with CS/80 and HP-IB. It's also available in an optional version that emulates the 7906M drive. The disc cartridge must be formatted before use.

97907A
(1 cartridge) \$225.00 ea.
(2-5) 210.00 ea.
(6+) 190.00 ea.

Here's how easy it is to prevent errors, downtime and permanent damage.

Let's face it, the average work environment's a jungle for computer equipment. Even as you read, smoke, dust and other contaminants are attacking your media and drives, causing errors and possible permanent damage.

Plus, oxide from the tape itself chips off and sticks to heads, capstans and guides. This also causes read/write errors and reduces the life of your head and media.

You can't always see the dirt. A clear film of oxide or binder may form on your tape head without being visible. But you'll find out it's there when you lose data or your drives don't work!

Regular cleaning with the correct materials eliminates this invisible enemy. And cleaning is fast and easy. Just a few minutes each week will help keep your HP drives running smoothly for years to come.

Clean your drive with confidence. Incorrect cleaning materials can actually cause more problems than they solve. Eliminate the worry—use the supplies and accessories that have been rigorously tested on HP drives so you can trust them on yours.

Regular cleaning will not only protect your data and drives, it will save you the expense of downtime and damaged equipment. Follow our Helpful Ideas on this page and protect your investment the fast and easy way.

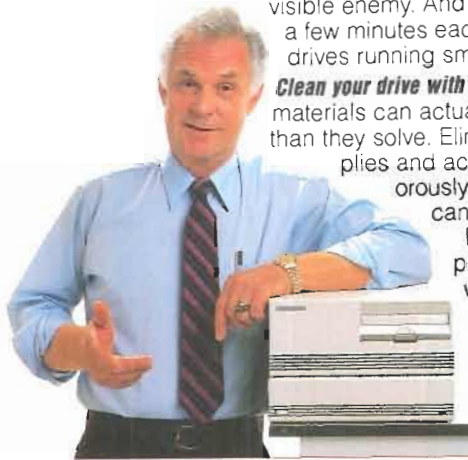

HELPFUL IDEAS!

By cleaning your drive's read/write head on a regular basis, you can prevent problems. Cleaning takes just a few minutes and will decrease the likelihood of downtime, lost data and damaged equipment.

When to clean under normal conditions—

- after every 10 reels of tape (about every 1.5 hours of continuous running).

Also clean if—

- tapes from outside your computer center are being read.
- new tapes with only one or two uses are being used. (New tapes pick up debris during manufacturing.)
- extended periods (days) of tape drive inactivity before use.
- there's an abnormal dust level in your computer center because of a delivery or equipment being moved.

How to clean your heads.



◀ If you use magnetic tape drives, apply the correct magnetic head cleaning solution to the head with a swab. Then clean all visible parts with a blower, cleaning solution and swabs.

If your system has an 8-inch or a 5.25-inch drive, use a cleaning disc. ▶



◀ If your system has a 1/4" tape drive, use a cleaning cartridge.



Expertly clean your magnetic tape heads with this kit.

All you need for swabbing your heads. Use these supplies regularly and minimize read/write errors while prolonging head and media life. Routine cleaning also reduces dust and oxide build-up. Kit includes two 4-ounce bottles of cleaning solution, 50 lint-free wipes, 10 plastic swabs with urethane foam tips and one easy-pour dispensing cap.

- 92193H** Magnetic head clean kit
- (1 kit) \$35.00 ea.
 - (2-4) 33.00 ea.
 - (5+) 30.00 ea.



Here's all you need to clean magnetic tape systems.

Clean heads, guides, capstans, screens, printers and equipment surfaces. Our Master kit includes 4-ounce bottles of mag head cleaning, anti-static and screen-cleaning solutions, 10 plastic swabs with urethane foam tips, 16 screen-clean wipes, 50 lint-free wipes, two pump spray tops, gloves and instructions.

- 92193M** Master clean kit
- (1 kit) \$44.00 ea.
 - (2-4) 42.00 ea.
 - (5+) 40.00 ea.

Prevent drive contamination with our magnetic head cleaning solution.

Apply it to drive heads with cleaning swabs to clean magnetic tape drives. It's 100% Freon TF, the safest solvent for your tape path. Freon TF cuts oil and grease and evaporates quickly. Use compressed air to dry it thoroughly so it doesn't touch the tape, which could cause sticking problems. Be sure not to use alcohol, aerosol cleaners or Freon TA, which contain an acetone that could dissolve the epoxy holding the head together. The 12-ounce bottle has a flip top that releases drops so you don't contaminate the solution by dipping a dirty swab into it.



- 92193F** Magnetic head cleaning solution
- (1-4 bottles) \$16.00 ea.
 - (5+) 14.00 ea.



Protect your hands from dirt and solvents.

Keep your hands clean while cleaning your equipment. Each bag contains twenty-five pairs of plastic gloves.

- 921936** Cleaning gloves (1-4 bags) \$29.00 bag
- (5+) 25.00 bag

Clean safely with non-abrasive lint-free wipes.



Because our lint-free wipes won't bring abrasives into your tape's path, they're safe for all HP equipment surfaces. One bag includes 100 4x4-inch (10.2 x 10.2 cm) thermal-bonded polyester wipes.

- 92193W** Lint-free wipes (1-4 bags) \$12.00 bag
- (5+) 10.00 bag



Compressed air cleaner speeds evaporation.

Cut cleaning time by using this compressed air cleaner to dry the cleaning solution on your head and tape path. It's also great for blowing dirt and dust out of hard-to-reach spots, and the extension spray tube makes it safe and easy to use. One box includes two 12-ounce cans.

- 92193Y** Compressed air cleaner (1-4 boxes) \$21.00 ea.
- (5+) 19.00 ea.



Soft, urethane foam-tipped swabs clean equipment gently but firmly.

Use our wooden swabs for cleaning your high density 1/4" data cartridge transports with our 92193F cleaning solution. These swabs are non-abrasive and safe for your system. 50 swabs/box.

- 9300-0468** Lint-free wooden swabs (1-2 boxes) \$15.00 ea.
- (3+) 12.00 ea.

Use these plastic swabs with our 92193F magnetic head cleaning solution to clean the tape head and capstans in your HP 7908/11/12/14 tape transports. Non-abrasive swabs won't harm your tape path. 50 swabs/box.

- 9300-0767** Lint-free plastic swabs \$27.00 box



Clean your 1/4" tape drive in a flash.

Cleaning the head on your HP 9144A, 9142A or 35401A tape drive is as easy as inserting a media cartridge. Our kit includes a cleaning cartridge, two bottles of cleaning solution, 13 foam pads, plastic tweezers, a cleaning maintenance record, plus instructions for each type of drive.

- 92193E** Cleaning cartridge kit for 1/4" tape drives (1 kit) \$52.50 ea.

When supplies run low in your 92193E kit, order this to replenish it. Includes two bottles of cleaning fluid, 24 foam pads, tweezers and a maintenance record. Just keep the cleaning cartridge from the original kit.

- 92193F** Replenishment Kit (1 kit) \$26.00 ea.

5.25-inch Kit



8-inch Kit

Clean your 8-inch or 5.25-inch drives with these easy-to-use kits.

Clean your drive in less than two minutes without messy liquids! Just insert our cleaning disc in your drive and activate your system's initialize command or cleaning utility, which moves the head across the cleaning surface of the disc. Both kits include two double-sided cleaning discs good for 26 cleanings each, instructions and a storage case.

- 92193L** Kit for 8-inch disc drives (1 kit) \$36.00 kit
- (2-4) 33.00 kit
- (5+) 30.00 kit
- 92193K** Kit for 5.25-inch disc drives (except the HP Vectra PC drives) (1 kit) \$32.00 kit
- (2-4) 30.00 kit
- (5+) 28.00 kit



Keep video screen crystal clear

Clean your CRT terminal screens and other glass surfaces with two 4-ounce bottles of screen-cleaning solution, fifty 8 x 13cm (3 x 5 in.) lint-free wipes and one easy-pour dispensing cap.

- 92193V** Video Clean Kit (1 kit) \$17.00 ea.
- (2-4) 16.00 ea.
- (5+) 15.00 ea.

FURNITURE



HP furniture...intelligently designed for the work you do and the computers you use to do it. One such example is our *Design Plus* CAD workstation, developed specifically for optimal space utilization. Peruse the section ahead to learn more.

Office & workstation	101-119
Design Plus Furniture	101-106
Standard Furniture ..	107-110
Sound enclosures	111
Ergonomic chairs	112
Cabinets	116
Workstation accessories	120
Anti-static accessories ...	122
Dust Covers	124
Carrying Cases	125
Security Kits	126

Design Plus

Developed with your HP computer system—and you—in mind. This furniture's clean, utilitarian design matches your equipment perfectly, giving your workstations an appealingly coordinated look. Because components work together, workstations are easily re-configured to suit changing system needs.

What's the "Plus?" There are several. Like infinitely expandable storage space. Intelligent cable management. Generous desktop space and dimensions sized to fit the human body, allowing for enormous working convenience and comfort.

Expect quality "plus," too, because **Design Plus** is constructed of the highest grade of materials. Attractive matte surfaces resist scratches and stains, while protecting your eyes from the glare of overhead lighting. And solidly die-cast legs withstand the weight of your equipment—and the pressures of normal office moves—without danger of buckling or breaking.



Fits your Hewlett-Packard system like a glove

Our System Tables conform to stringent ergonomic standards for your optimal working comfort.

Our cabinetry is similarly well-conceived. The Mini-Rack Cabinet, designed to hold the CPU and disc drive of your HP 9000 Series 200, 300 or 500 computer, is the cabinet that encases the HP 3000 Series 37, HP 260 or MICRO 3000. Not only does it match the height and depth of our tables, it can be locked into place. Result? Additional work surface, flush-fitted and uninterrupted by troublesome gaps or height discrepancies.

Depend on our Mobile Drawer Units to store files, documentation and other valuables. Like the Mini-Rack Cabinets, they match the height of our tables exactly. You can slip hard-disc drives and tape back-up systems into Mobile Support Cabinets, and tuck them conveniently under our tables.

We offer printer stands that combine fit with durability and mobility. Look to the new Mobile LaserJet Printer Cabinet for an abundance of work- and storage space. Choose a Mobile Sound Enclo-

sure Cabinet for HP serial impact dot matrix printers. Or the Universal Support Stand for other printers and small plotters. All roll easily on self-locking casters.



Tabletops slide on and lock into position in just seconds to form a sturdy, secure working surface. It's as easy as drop, slide, lock.



A durable wire cable management system neatly routes cables along the back side of tables, allowing for equipment connection at the point most convenient to you.



L-configuration lays large expanses of desk before you.

Design Plus One was designed with your comfort and convenience in mind. It offers ample desktop space for you to spread out and work, as well as for your terminal, keyboard and laser printer.

Included are two roomy drawers for your office supplies and documentation, plus a deeper one for hanging files and records.

And because the cabinet of your HP 3000 Series 37, MICRO 3000, MICRO 3000 XE or HP 260 computer is perfectly flush with your system table, you get bonus workspace.

This system includes:
92214A Terminal support table
92214B Medium system table
92214J Corner turn
92211N Mobile drawer unit

92214AA

Design Plus One \$1890.00 ea.

Save \$150!

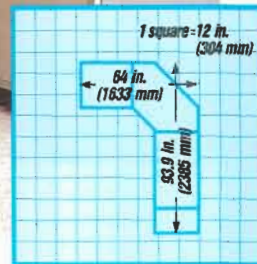

Basic system packs maximum utility into minimal space.

Design Plus Two makes the most of compact work spaces, and is well-suited for use with HP 9000 technical computers and personal computers.

It offers enough desktop space for a monitor, keyboard and printer. Place its Mobile drawer unit at either end of its System table for your files and supplies. And its Mobile support cabinet keeps your CPU and mass storage device handy without taking up valuable desktop space. The cabinet even comes with a shelf for software, manuals or additional office supply storage.

This system includes:
92214C Large system table
92211N Mobile drawer unit
92211L Mobile support cabinet

92214BB *Design Plus Two* ... \$1515.00 ea.

Save \$125!

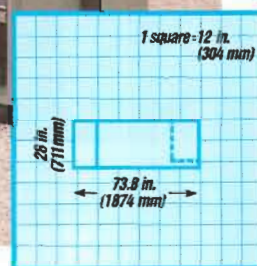

See our ergonomically designed, economically priced chairs on page 112.

CAD Workstation lets you stretch out and design in comfort

Keep your resources within convenient reach without overcrowding.

Our spacious CAD Workstation lets you extend your work area instantly with a 36-inch pull-out surface, and tuck your keyboard away when it's not in use.

The Corner Turn and Medium System Table offer space for reviewing reference materials. The two Mobile Mini-racks offer extra work surface plus off-table storage for CPUs and mass storage.

Get our Ergonomic Task Lamp for non-glare light that's easy on your eyes, and our Drawing Holder to hold "C" and "D" size drawings at eye-level. You never worked smarter!

This configuration incorporates:

- 92214B** Medium System Table
- 92213Q** Deskclamp
- 92214J** Corner Turn
- 92213F** CAD Workstation
- 92213D** "C" and "D" Sized Drawing Holder
- 92211B** Mini-rack (two)

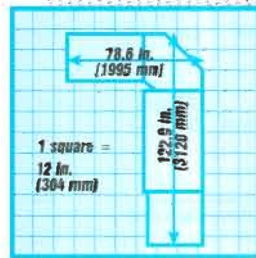

CAD Corner handles jumbo monitors and expansive drawings

Our CAD Corner Workstation supports oversized monitors, and fits perfectly between a Medium System Table and Mobile Mini-rack System Cabinets.

Mini-racks and Drawer Units keep peripherals and files within easy reach while offering table-top space, as do the Corner Turn and Mobile Support Table.

Illuminate it all with the cool, non-glare light of our Design Plus Desk Lamp. The result? A U-shaped configuration that optimizes CAD ease and efficiency.





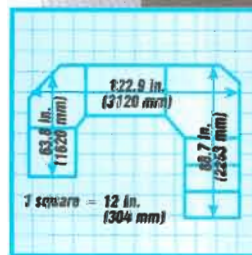





This configuration incorporates:

- 92214A** Mobile Support Table
- 92214J** Corner Turn
- 92213Q** Deskclamp
- 92214B** Medium Table
- 92214K** CAD Corner Workstation
- 92211R** Mini-rack (two)
- 92211E** Small Drawer Unit (two)
- 92211G** Large Drawer Unit







See the charts on page 104 and 105 for the components you need.





Design Plus Workstation Furniture

	Description	Height	Width	Depth	Product no.	Price
	<i>Design Plus</i> CAD Mini-Workstation. For use with the HP 9000 Series 300/500 computers. Comes with 362mm (14.25 in.) wide raised monitor platform, pull-out work surface that extends to 914mm (36 in.) deep, pull-out keyboard drawer and cable management. Same height as 92211R mobile mini-rack; 92211L/M fits underneath.	720mm (28.4 in.)	1125mm (44.3 in.)	711mm (28.0 in.)	92213B	(1-2) \$849.00 ea. (3+) 799.00 ea.
	<i>Design Plus</i> CAD Workstation is designed for use with HP CAD systems. It comes with a pull-out work surface, keyboard drawer, raised monitor platform and cable management. It attaches to other <i>Design Plus</i> furniture.	720mm (28.4 in.)	1500mm (59.0 in.)	711mm (28.0 in.)	92213F	(1-2) \$899.00 ea. (3+) 849.00 ea.
	<i>Design Plus</i> CAD Corner Workstation. Perfectly fitted for use with HP CAD systems. Workstation comes with a keyboard drawer and cable management. It can be joined to <i>Design Plus</i> furniture.	720mm (28.4 in.)	1125mm (44.3 in.)	1125mm (44.3 in.)	92214K	(1-2) \$899.00 ea. (3+) 849.00 ea.
	"C" and "D" sized Drawing Holder. Mounts to the monitor platform of the 92213B/F CAD table. Two-section arm for height and tilt position extends from 330mm (13.0 in.) to 565mm (22.25 in.)	508mm (20.0 in.)	762mm (30.0 in.)	6mm (2.6 in.)	92213D	(1-2) \$219.00 ea. (3+) 199.00 ea.
	<i>Design Plus</i> Mobile Terminal Support and Transport System Table. Designed to safely move terminals and small systems. Comes with cable management, locking casters, and is same height as 92211R mobile rack system cabinet.	720mm (28.4 in.)	750mm (29.5 in.)	711mm (28.0 in.)	92214A	(1-2) \$475.00 ea. (3+) 445.00 ea.
	Medium <i>Design Plus</i> System Table. Comes with cable management, locking casters, and is same height as 92211R mobile rack system cabinet.	720mm (28.4 in.)	1125mm (44.3 in.)	711mm (28.0 in.)	92214B	(1-2) \$525.00 ea. (3+) 495.00 ea.
	Large <i>Design Plus</i> System Table. Comes with cable management, adjustable leveling glides, and is same height as 92211R mobile rack system cabinet.	720mm (28.4 in.)	1500mm (59.0 in.)	711mm (28.0 in.)	92214C	(1-2) \$585.00 ea. (3+) 545.00 ea.
	90-degree <i>Design Plus</i> Corner Turn. Used for joining two system tables together for a larger work area. NOTE: not intended to support CAD monitors.	Each side:	711mm (28.0 in.)		92214J	(1-2) \$295.00 ea. (3+) 270.00 ea.
	<i>Design Plus</i> Joining Bracket Kit. For use on all <i>Design Plus</i> furniture pieces to anchor one to another. Comes with needed screws and instructions for assembly and use.	N/A	N/A	N/A	92211U	(1-2) \$40.00 ea. (3-9) 37.00 ea. (10+) 34.00 ea.
	<i>Design Plus</i> Ergonomic Task Lamp. Specifically designed for computer workstations. Two nine-watt emitters produce the same light as 80-watt incandescent. Lamp stem fits <i>Design Plus</i> tables. UL listed and CSA approved.	N/A	N/A	N/A	92213Q	(1-2) \$280.00 ea. (3-9) 260.00 ea. (10+) 240.00 ea.
	<i>Design Plus</i> Lamp Clamp. Designed for the <i>Design Plus</i> Lamp (92213Q). For use on non- <i>Design Plus</i> table tops. Maximum clamp opening is 127mm (5-in.) Use this clamp for HP standard tables.	N/A	N/A	N/A	92213R	\$28.00 ea.

Design Plus system storage and support furniture

	Description	Height	Width	Depth	Product no.	Price
	<i>Design Plus</i> Mobile Sound Enclosure Cabinet. For use with all 293X serial impact dot matrix printers. Rolls easily and sits level with all <i>Design Plus</i> tables. Features gas cylinder door lifts, locking casters, paper storage, paper catcher tray and print monitoring window. Designed for rear paper exit. Comes fully assembled.	720mm (28.4 in.)	750mm (29.5 in.)	500mm (19.7 in.)	92211C	(1-2) \$675.00 ea. (3-9) 640.00 ea. (10+) 620.00 ea.
	<i>Design Plus</i> LaserJet Printer Cabinet. Features a deep cabinet with a shelf to store months of daily printing supplies. Rolls easily and sits level with system tables. Comes assembled.	720mm (28.3 in.)	508mm (20.0 in.)	711mm (28.0 in.)	92211D	(1-2) \$385.00 ea. (3-9) 365.00 ea. (10+) 345.00 ea.
	<i>Design Plus</i> Universal Support Stand. For use with HP LaserJet, HP 2932/33/34, HP 2563A printers and small HP plotters. Comes with printout catcher shelf, casters and leveling glides. Has slot in top for bottom feeding and slot in door for front feeding. Also has sound control pads inside.	720mm (28.4 in.)	600mm (23.6 in.)	450mm (17.7 in.)	92214P	(1-2 units) .. \$295.00 ea. (3+) 265.00 ea.
	<i>Design Plus</i> Mobile Support Cabinet. Rolls easily under the 92214B/C <i>Design Plus</i> system tables. Can be used as a stand-alone system cabinet for the HP 9000 Series 200/300/500. Comes with two sets of mounting rails, cable routing kit (92199F), and two storage shelves. Internal dimensions are 325 W x 520 Hmm (12.8 W x 20.40 H in.)	620mm (24.4 in.)	425mm (16.7 in.)	525mm (20.7 in.)	92211L	(1-2) \$310.00 ea. (3-9) 290.00 ea. (10+) 270.00 ea.
	<i>Design Plus</i> Small Mobile Support Cabinet. Rolls under the 92214B/C system tables. Can be used as a stand-alone system cabinet for the Series 200, Model 237 or 300. Comes with one set of mounting rails, a storage shelf, a cable routing kit (922199F), and a pad to put under the Model 237. Internal dimensions are 325 W x 338 Hmm (12.8 W x 13.26 H in.)	435mm (17.1 in.)	425mm (16.7 in.)	425mm (16.7 in.)	92211M	(1-2) \$250.00 ea. (3-9) 230.00 ea. (10+) 210.00 ea.

Design Plus system storage and support furniture (continued)

	Description	Height	Width	Depth	Product no.	Price
	Design Plus Mobile Drawer Unit. Rolls easily and sits next to all Design Plus System Tables (also same height as tables). Comes with three drawers, 104mm, 156mm, and 312mm (4 in., 6 in., and 12 in.)	720mm (28.4 in.)	375mm (14.8 in.)	711mm (28.0 in.)	92211N	(1-2) \$745.00 ea. (3-9) 705.00 ea. (10+) 665.00 ea.
	Design Plus Mobile Mini-Rack System Cabinet for HP modular peripherals and systems. Comes fully assembled with casters. Back opens for easy access. Accessories available are the 92211S mounting rail and module lock kit, 92211T filler panel kit, and 92199B power strip. Internal dimensions are 325 W x 572 Hmm (12.8 W x 22.44 H in.)	720mm (28.4 in.)	375mm (14.8 in.)	711mm (28.0 in.)	92211R	(1-2) \$585.00 ea. (3-9) 550.00 ea. (10+) 515.00 ea.
	Large (12 inch) Drawer Unit for 92211R mobile mini-rack system cabinet. Designed for easy installation and constructed of sturdy metal. Comes with its own key lock.	305mm (12 in.)	324mm (12.75 in.)	473mm (18.62 in.)	92211G	(1-2) \$159.00 ea. (3-9) 149.00 ea. (10+) 139.00 ea.
	Medium (6 inch) Drawer Unit for 92211R mobile mini-rack system cabinet. Designed for easy installation and constructed of sturdy metal. Comes with its own key lock.	152mm (6 in.)	324mm (12.75 in.)	473mm (18.62 in.)	92211F	(1-2) \$149.00 ea. (3-9) 139.00 ea. (10+) 129.00 ea.
	Small (4 inch) Drawer Unit for 92211R mobile mini-rack system cabinet. Designed for easy installation and constructed of sturdy metal. Comes with its own key lock.	102mm (4 in.)	324mm (12.75 in.)	473mm (18.62 in.)	92211E	(1-2) \$139.00 ea. (3-9) 129.00 ea. (10+) 119.00 ea.
	Rail Kit for 92211R mobile mini-rack cabinet. Comes with four sets of rails and module locks. Used to mount up to four HP computer and peripheral equipment modules.			Rail length: 638mm (25.1 in.)	92211S	(1-2 kits) \$50.00 ea. (3-9) 45.00 ea. (10+) 40.00 ea.
	Filler Panel Kit for 92211R mobile mini-rack cabinet. Kit contains 20 snap-in panels used to fill empty space not occupied by computer equipment modules.	23mm (0.9 in.)	325mm (12.8 in.)	23mm (0.9 in.)	92211T	(1-2 kits) \$40.00 ea. (3-9) 35.00 ea. (10+) 30.00 ea.

Design Plus furniture compatibility guide

Equipment	Recommended cabinet
HP 9000 Series 300	92211R Mini-rack system cabinet.
HP 3000 Series 37, MICRO 3000, MICRO 3000 XE	Comes mounted in 92211R cabinet. For larger configurations of disc and tape support, order an additional 92211R cabinet.
HP 9000, Series 300	92211L Mobile support cabinet. Computers mount in cabinet. Has space for two additional disc or tape peripherals.
HP 9000, Series 300	92211M Small mobile support cabinet. Computer sits on top of cabinet. Two additional disc or tape peripherals will mount in cabinet.
HP 7941A, 7942A, 7945A, 7946A, 9122D, 9125S, 9133D, 9133V, 9133XV, 9134D, 9134XV, 9144A mass storage devices	92211L Mobile support cabinet, 92211M small mobile support cabinet and 92211R mobile mini-rack. NOTE: These cabinets can accommodate peripheral devices up to 325mm (12.8 in.) wide.

Slide this Euro-style lamp into your Design Plus desktop. Unique louvers focus cool light on your work—not in your eyes

From Germany, where designers mastered the science of comfort, comes a desk lamp unlike any you've ever used.

Raise, lower, pivot or swivel it into position. It gives you all the light you need to read and work comfortably, even in low-lit areas. But what makes it superior is what it won't do.

It won't glare into your eyes, or onto your screen. Unlike a bare-bulb lamp, ours has a unique silver-coated grid that reflects and directs the soft light just where you want it.

It won't make you sweat. Two 9-watt fluorescent bulbs provide as much light as an 80-watt incandescent bulb. Yet they use 77 percent less energy, and stay perfectly cool.

And it won't waste a millimeter of your desktop space. Slip it into the opening on your **Design Plus** tabletop. Or attach it to our optional clamp.

Try the **Design Plus** Desklamp and you'll agree—it makes all other lamps seem glaringly obsolete! Dimensions: 152 H x 305 W x 610 D mm (6 H x 12 W x 24 D in.). Bulb life: approximately 5 years.

92213Q Design Plus Ergonomic Task Lamp
(1-2) \$280.00 ea.
(3-9) 260.00 ea.
(10+) 240.00 ea.

92213R Lamp Clamp \$28.00 ea.



Optional lamp clamp provides support for surfaces up to 127mm (5 in.) deep.



At last, a truly ergonomic desk lamp! Bulbs stay cool, louvers keep light out of your eyes...and it wastes zero desktop space!

Need versatile stands for your workplace? Get our Universal Support Stand for any office printer...or plotter!

Give your workplace a more coordinated look with our Universal Stand. It's perfect for most business printers and plotters, and ideal for the evolving needs of growing offices or departments.



Use it with HP LaserJet Printers
Place your printer on top and keep the movable shelf inside for daily supplies.



Use it with HP RuggedWriter Printers
Stock a full box of Z-fold paper inside—enough for months of output—and it feeds from behind.



Use it with HP 293X Printers
You'll appreciate the way the shelf can be moved outside to work as a paper-catcher.

Designed for versatility Our Stand features an inside shelf that slides outside for use as exterior paper tray—great for keeping output neatly stacked. It also has a slot on top for bottom-feeders like HP 293X Printers.

As for the inside of our Stand, you can use it two ways: Stock a box of Z-Fold paper for bottom-feed printers. Or stock your daily supplies—reams of paper, a dozen toner cartridges, a hundred fonts, or any combination thereof.

Built to last This Stand has rubber padding inside to absorb potentially damaging printer vibrations. Self-locking casters add mobility. And it's compatible with **Design Plus**, right down to the color, construction and height.

The Universal Support Stand comes pre-assembled for your convenience and measures 720 H x 600 W x 450 D mm (28.4 H x 23.6 W x 17.7 D in.).

92214P Universal Support Stand
(1-2) \$295.00 ea.
(3+) 265.00 ea.



Styled to match **Design Plus** furniture, padded to minimize vibrations, built to keep printer supplies you need where they're needed!

Turn empty space into useful space

These easy-to-install drawer units provide additional storage space in your 92211R HP Mobile Mini-rack Cabinet.

Mount your equipment in the cabinet, then add one, two or all three drawer units. It's perfect for documents, manuals, office supplies, tools or cables.

These attractive, sturdy metal drawers are available in 102mm, 152mm and 305mm (4-in., 6-in. and 12-in.) sizes, with key lock.

92211E 102mm (4 in.) Mobile Mini-rack Drawer Unit \$139.00 ea.
92211F 152mm (6 in.) Mobile Mini-rack Drawer Unit \$149.00 ea.
92211G 305mm (12 in.) Mobile Mini-rack Drawer Unit \$159.00 ea.

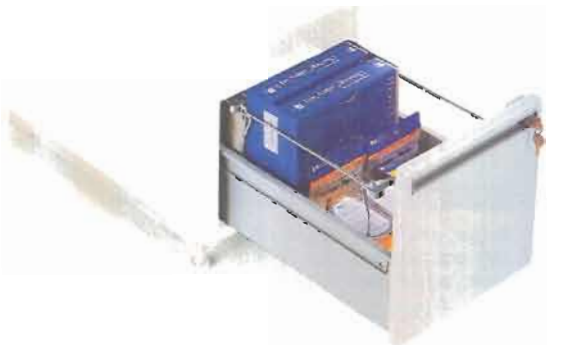

Design Plus CAD Corner Workstation handles jumbo monitors

If you use a large graphics monitor, this workstation's for you.

Designed expressly to accommodate an oversized monitor, the CAD Corner offers the same amount of desktop space as the 92213B CAD Mini-workstation (page 104).

Its die-cast metal legs support as much as 200 pounds—more than adequate for a graphics monitor and other computer peripherals.

Designed for a perfect fit between **Design Plus** components, this workstation features a convenient keyboard drawer, and cable management to keep your work area safe and neat.

Exterior dimensions are 720 H x 1125 W x 1125 D mm (28.4 H x 44.3 W x 44.3 D in.).

92214K **Design Plus** CAD Corner Workstation
(1-2 units) \$849.00 ea.
(3+) 799.00 ea.

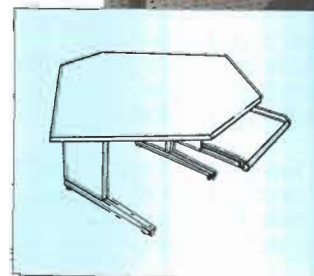
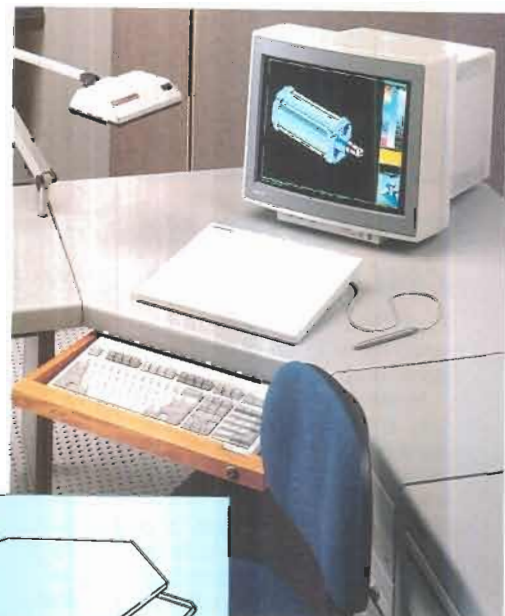

HP Standard Furniture combines durability, economy and flexibility

With HP Standard Furniture, it's easy and economical to create a work environment that looks attractive and runs smoothly. Our solidly-built furniture helps you organize your office or department's PCs, terminals, peripherals and resource materials for maximum productivity.

Building your HP Standard workplace is simple: Select what you need to promote efficiency today. As your requirements grow, add coordinated pieces to your initial workstation.

Assembly's easy, too—the only tool you need is a Phillips screwdriver. All mounting holes are pre-drilled/tapped, and all hardware and brackets are included.

And it's very easy to make your office attractive and professional-looking with HP Standard Furniture. It's simply styled and color-coordinated to match HP computers and peripheral products.

Easy to grow or change With HP Standard Furniture, you always have the freedom to expand or alter your work area to keep up with new challenges.

For example, you can add work space to either our Compact or Standard Workstation Tables with Work Surface Extensions. Or join tables together to make

convenient "L" or "U" shaped arrangements with triangular Workstation Table-top Connectors.

Mobile Drawer Units and Workstation Tables let you bring equipment and resources into your area at a moment's notice, then reclaim space by wheeling these components away. This mobility also makes it easy to share resources.

Ready access Other HP Standard Furniture components keep the tools of your trade close without making you feel crowded.

Storage areas are spacious, so even files and materials you use only occasionally don't have to be shuffled off to a remote location. Storage is also versatile—Suspended Drawer Units, for example, hold letter- and legal-size files as well as computer printout binders.

Desktop Storage Shelves include both a handy area for keeping paper and built-in message boards.



HP Furniture surfaces are smooth and glare-free, with durable rounded corners.



Workstation Table Keyboard section adjusts to your height, preventing backstrain.

Our HP Standard CAD Corner is ideal for graphics monitors

You and your jumbo graphics monitor will feel right at home in this HP Standard CAD Corner Workstation configuration.

Designed expressly for an oversized monitor, the CAD Corner offers expansive desktop space for drawing and reference materials, but lets you slide away your keyboard when it's not in use.

Keep letter- and legal-sized files and computer printouts on hand with our versatile Suspended Drawer Unit.

And our Design Plus Desk Lamp increases lighting without glare problems. It attaches to the roomy Workstation Table with a Lamp Clamp.

This configuration incorporates:

922108 Workstation Table (two)

922100 Suspended Drawer Unit

92210U CAD Corner Workstation

922130 Desk lamp

92213R Lamp clamp

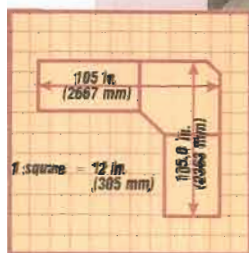

See the chart on page 108 and 109 for the components you need.

Streamline printing and increase convenience with these sturdy Printer and Terminal Stands



Choose this stand for keyboarding comfort.

These two Stands are designed and color-coordinated to match your HP Standard Furniture Workstations and HP printers.

Our 92210P Printer Stand has a slot in its top that enables paper to flow smoothly into your printer from a bottom feed paper source. Also featured is a rear paper-catcher with a slot to facilitate convenient paper transport to rear feed printers. Cable management slots keep cables orderly and out of the way. The Stand also comes with a handy seven-inch shelf.

Our 92210T Mobile Workstation Table features self-locking casters for secure portability. It also has a dropped pull-out keyboard surface for working comfort and cable management slots.

92210P Printer Stand
(1-2 units) \$285.00 ea.
(3+) 265.00 ea.

92210T Mobile Workstation Table
(1-2 units) \$330.00 ea.
(3+) 305.00 ea.



Get this stand for convenient printing.

HP Standard furniture



















	Description	Height	Width	Depth	Product no.	Price
	Printer Stand. Design matches HP 92210 series workstation system. Convenient paper feed slot (102 x 483mm, 4 x 19 in.) in top allows bottom paper feed. Also features rear printout catcher with 38mm (1.5 in.) slot to allow paper transport to rear feed printers. Cable management slots, 178mm (7 in.) shelf standard.	686mm (27 in.)	Work surface 762mm (30 in.)	610mm (24 in.)	92210P (see photo above)	(1-2 units) .. \$285.00 ea. (3+) 265.00 ea.
		470mm (18.5 in.)	Printout catcher 432mm (17 in.)	343mm (13.5 in.)		
	Mobile Workstation Table for terminals. Design matches HP 92210 series workstation system. Features a dropped, pull-out keyboard surface. Cable management slots, locking casters and 178mm (7 in.) shelf standard.	720mm (28.3 in.)	Work surface 762mm (30 in.)	712mm (28 in.)	92210T (see photo above)	(1-2 units) .. \$330.00 ea. (3+) 305.00 ea.
		670mm (26.4 in.)	Keyboard surface 597mm (23.5 in.)	305mm (12 in.)		
	Compact Workstation Table, with leg levelers and modesty panel. 7-in. (178 mm) shelf standard. See 92210L casters next page to adapt table height to 720mm (28.4 in.).	686mm (27.0 in.)	1220mm (48.0 in.)	762mm (30.0 in.)	92210A	(1-2 units) .. \$325.00 ea. (3+) 305.00 ea.
	Standard Workstation Table, with leg levelers and modesty panel. 178mm (7 in.) shelf standard. See 92210L casters next page to adapt table height to 720mm (28.4 in.).	686mm (27.0 in.)	1524mm (60.0 in.)	762mm (30.0 in.)	92210B	(1-2 units) .. \$380.00 ea. (3+) 360.00 ea.
	Compact Workstation Table, with leg levelers and modesty panel. 178mm (7 in.) shelf standard. 29 in. high to complement your 29 in. high standard furniture workstations.	736mm (29.0 in.)	1220mm (48.0 in.)	762mm (30.0 in.)	92211J <i>new!</i>	(1-2 units) .. \$325.00 ea. (3+) 305.00 ea.
	Standard Workstation Table, with leg levelers and modesty panel. 178mm (7 in.) shelf standard. 29 in. high to complement your 29 in. high standard furniture workstations.	736mm (29.0 in.)	1524mm (60.0 in.)	762mm (30.0 in.)	92211K <i>new!</i>	(1-2 units) .. \$380.00 ea. (3+) 360.00 ea.

Chart continued next page

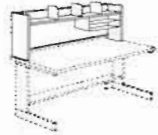
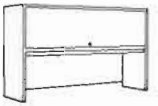
HP Standard furniture (continued)

	Description	Height	Width	Depth	Product no.	Price
	Workstation Table with right-hand adjustable keyboard section. Leg levelers, modesty panel and 178mm (7 in.) shelf standard. Keyboard section starts 76mm (3 in.) from the right side, adjusts down a total of 53mm (2.1 in.) from table top and can be tilted 10 degrees from the horizontal. Manual adjustments. See 92210L casters next page to adapt table height to 720mm (28.4 in.). Adjustable keyboard dimensions 30mm 610mm 254mm (1.2 in.) (24.0 in.) (10.0 in.)	736mm (29.0 in.)	1524mm (60.0 in.)	762mm (30.0 in.)	92210C	(1-2 units) .. \$445.00 ea. (3+) 405.00 ea.
	Workstation Table with left-hand adjustable keyboard section. Leg levelers, modesty panel and 178mm (7 in.) shelf standard. Keyboard section starts 76mm (3 in.) from the left side, adjusts down a total of 53mm (2.1 in.) from the table top and can be tilted 10 degrees from the horizontal. Manual adjustments. See 92210L casters next page to adapt table height to 720mm (28.4 in.). Adjustable keyboard dimensions 30mm 610mm 254mm (1.2 in.) (24.0 in.) (10.0 in.)	736mm (29.0 in.)	1524mm (60.0 in.)	762mm (30.0 in.)	92210D	(1-2) \$445.00 ea. (3+) 405.00 ea.
	Work Surface Extension (return), with leg levelers and modesty panel. Fits right or left side of 92210B table, left side of 92210C, right side of 92210D. Requires use of 'Z' bracket (included) when mounting on 92210C/D. Not for 92210A.	686mm (27.0 in.)	1016mm (40.0 in.)	610mm (24.0 in.)	92210E	(1-2) \$235.00 ea. (3+) 215.00 ea.
	CAD Corner Workstation Table, with leg levelers, modesty panel, and shelf. Also includes a pull-out keyboard shelf.	737mm (29.0 in.)	1143mm (45.0 in.)	762mm (30.0 in.)	92210U	(1-2) \$599.00 ea. (3+) 559.00 ea.
	Workstation Tabletop Connector, 90-degree triangle. Joins two 92210A/B/C/D tables together.	Each side	763mm (30.0 in.)		92210V	(1-2) \$155.00 ea. (3+) 145.00 ea.
	Desktop Storage Shelf for 92210A workstation table. Includes two book supports and back-wall message board. 279mm (11 in.) storage shelf adjusts from 381mm (15 in.) to 483mm (19 in.) above work surface of table. Convenient paper/storage shelf included.	584mm (23.0 in.)	1194mm (47.0 in.)	305mm (12.0 in.)	92210F	(1-2) \$265.00 ea. (3+) 245.00 ea.
	Desktop Storage Shelf for 92210B/C/D workstation table. Includes three book supports and back-wall message board. 279mm (11 in.) storage shelf adjusts from 381mm (15 in.) to 533mm (21 in.) above work surface of table. Convenient paper/storage shelf included.	584mm (23.0 in.)	1499mm (59.0 in.)	305mm (12.0 in.)	92210G	(1-2) \$285.00 ea. (3+) 265.00 ea.
	Desktop Storage Unit with wide-flipper door for 92210B/C/D workstation table. Includes lockable flipper door, back-wall fabric-covered message board and hanging paper/storage shelf. Space from table top to shelf bottom is 495mm (19.5 in.).	864mm (34.0 in.)	1499mm (59.0 in.)	356mm (14.0 in.)	92210Z	(1-2) \$495.00 ea. (3+) 455.00 ea.
	Task Light Unit. Screws into place underneath the 92210F/G/Z desktop storage units. Includes 20-watt fluorescent bulb, lens and power cord wire management clips. UL listed and CSA approved.	50.8mm (2.0 in.)	610mm (24.0 in.)	168mm (6.6 in.)	92210W	(1-2) \$119.00 ea. (3+) 109.00 ea.
	Mobile Drawer Unit, on casters. Two drawers, with identical key lock units. Deep bottom drawer like 92210Q below. Unit rolls easily to any workstation; top same height as 92210A/B.	686mm (27.0 in.)	391mm (15.4 in.)	508mm (20.0 in.)	92210N	(1-2) \$335.00 ea. (3+) 305.00 ea.
	Suspended Drawer Unit. Two drawers, with identical key lock units. Deep bottom drawer can store three types of hanging files: letter-size, legal-size, and computer printout binders. Fits right or left side of 92210A/B/C/D/E tables.	533mm (21.0 in.)	375mm (14.8 in.)	493mm (19.4 in.)	92210Q	(1-2) \$245.00 ea. (3+) 225.00 ea.
	Storage Module Unit, with three-position adjustable shelf. Rear of module is open for ventilation and access to 92210A/B/C/D cable management system, when module used to hold electronic equipment. Fits right or left side of 92210A/B/C/D tables. Inside module dimensions 432mm 493mm 493mm (17.0 in.) (19.4 in.) (19.4 in.)	483mm (19.0 in.)	534mm (21.0 in.)	493mm (19.4 in.)	92210R	(1-2) \$115.00 ea. (3+) 105.00 ea.
	Set of four heavy-duty, double-wheel Casters. Use in place of leg levelers on 92210A/B/C/D tables or 92210P stand where mobility is desired. Caster height 45mm (1.75 in.) Adapts height of tables to 720mm (28.4 in.).				92210L	(1-2) \$29.00 set (3+) 27.00 set

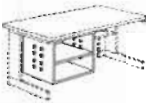
EASY ASSEMBLY! A Phillips screwdriver is the only tool needed to assemble HP Standard Furniture. All mounting holes are pre-drilled/tapped, and all hardware and brackets are included.

Our prices include the cost of shipment. See back of catalog for details.

Buy HP Standard Furniture by the bundle, and **SAVE!**

The durability and expandability of HP Standard Furniture is even more valuable when you take advantage of our bundled offerings.

We're making three workstation bundles available: the Professional Workstation, Administrative Support Workstation and Team Workstation. All three feature glare-free work surfaces and

space-saving strategies.

Choose the one that matches your needs, budget and space...and save substantially over the cost of buying separate components! Want to know more? Read about the bundles below, and see the charts on pages 108 and 109 for product details.

Professionals appreciate the Professional Workstation

For maximum work and storage space. It features a large, glare-free work surface area, 90-degree turn for PC or terminal, cable management, drawer unit to mount on either side of the table, a desktop storage unit and space for optional suspended drawers. Included are:

- 92210A** Compact Table
- 92210B** Standard Table
- 92210G** Desktop Storage Shelf
- 92210Q** Suspended Drawer Unit
- 92210V** 90-degree Tabletop Connector

92210AA Professional Workstation \$1290.00 ea.

Save \$100!



Enjoy maximum flexibility with our Administrative Support Workstation

For compact areas this space-saving workstation has an extension (return) that can be mounted on either side of its table, suspended drawers you can mount on either the table or the return and cable management. All surfaces are glare-free.

Included are:

- 92210B** Standard Table
- 92210Q** Suspended Drawer Unit
- 92210E** Workstation Extension (return)

92210BB Administrative Support Workstation \$805.00 ea.

Save \$55!



Make the most of compact spaces with our Team Workstation

For sharing computers and peripherals within your department. This economical workstation includes an adjustable keyboard surface, storage module for equipment or documentation, cable management and glare-free work surfaces. Included are:

- 92210C** Standard Table with right-hand adjustable keyboard section
- 92210R** Storage module

92210CC Team Workstation \$515.00 ea.

NOTE: The cabinet at right in photo is not included in bundle. See page 116 for information.

Save \$45!



Our prices include the cost of shipment to you. See back of catalog for details.

Lower the lid on plotter noise!

Do you have sensitive ears? Our all-new Plotter sound enclosure reduces the sound of your HP 7470, 7475 or ColorPro plotter by as much as 90 percent, to as low as 53.4 decibels. Your plotter becomes as quiet as a murmur... less intrusive than the sound of computer keyboarding. It's a wonderful way to improve office productivity.

The most functionality you'll find in a sound enclosure An intelligent design negates the need for an annoying cooling fan. It's constructed of sound-reducing particle board, with foam lining to absorb plotter vibrations. A foam plug can be removed to accommodate B/A3-size plotter paper, then re-inserted for further sound reduction. And the durable acrylic lid is attached by spring-loaded hinges for effortless opening and closing. Dimensions are 12 in. (305 mm) H x 25.8 in. (655 mm) W x 19.5 in. (495 mm) D; stand measures 3.9 in. (100 mm) H.

Extra protection for your plotter This Plotter sound enclosure protects your plotter investment, too. It's a shield against dust, spills and environmental contaminants—just as it shields you from unwanted noise.

92166E Plotter sound enclosure \$249.00

Designed to complement your HP equipment

This Plotter sound enclosure is designed to coordinate with Design Plus furniture. What's more, its design allows space for our 92177W/X Graphics organizer underneath for additional convenience (see page 48).



Muffle printer clatter!

Our Mobile sound enclosure cabinet is designed to make the HP 293X Serial Impact Dot Matrix Printer easy on your ears. This cabinet totally encases your printer, acting as a shield against dust and moisture while it absorbs noise.



Inside, there's a sturdy shelf for your printer and ample storage for continuous-feed paper. The wide front door has a handy finger-pull opener, and the top swings up on gas-cylinder lifts.

Monitor your printing through the attractive acrylic top panel; printed copies exit from the rear of your printer into a convenient paper catcher tray at the cabinet's rear.

The Mobile cabinet is the perfect height for Design Plus tables, rolls smoothly on self-locking casters and comes fully assembled. Exterior dimensions are 28.4 in. (720 mm) H; 29.5 in. (750 mm) W; 19.7 in. (500 mm) D.

92211C Design Plus Mobile sound enclosure cabinet

((1-2 units) \$675.00 ea.
((3-9) 640.00 ea.
((10+) 620.00 ea.



Absorb that printer sound!

Help quiet your HP 2601A/2602A or other printers. Distracting printer noise and vibrations are minimized when this sound absorbing pad is placed under your printer. Sound and vibrations first penetrate through the pad's nylon surface, then further are absorbed into the sponge-like layers of natural rubber. This sound absorbing pad will provide firm support for your printer and is highly resistant to indenting and sliding. Size is 18 in. (457 mm) x 21 in. (559 mm). Order several and save!

92177B Sound absorbing pad
(1 pad) \$31.00 ea.
(2-4) 25.00 ea.
(5+) 21.00 ea.



HP Ergonomic Workstation/Managerial Chair tilts forward to support the position your body takes at a keyboard. Optional armsets install two ways to let you pull close to your work or rest your hands.

HP Ergonomic Executive Chair provides top-to-bottom back support, rocks freely or locks in any of three positions. Takes the discomfort out of long meetings and calls. Armsets are standard.

HP Ergonomic Workbench Chair provides full support and independently adjustable foot support. Ideal for CAD, drafting and work that requires elevated work surfaces.

HP ergonomic chairs: From the bottom up, they redefine your entire concept of comfort

Any ergonomic chair can look pretty. But for a chair that's built to feel good and work better for years to come, take a close look at an HP ergonomic chair.

Our chairs look good, but that's only the beginning. These remarkable "comfort machines" are built to last. Just sit in one—you feel the difference *immediately*. It's more than firm support. Amazing adjustability. Or even top-notch quality. Our chairs offer *security*. Here's how:

They adjust to fit you...and your job If you work at a keyboard, you'll love the way our Workstation Chair leans forward when you do. Lift a lever and the seat tilts, while the backrest moves in close.

The Workbench Chair does the same. It also lets you set its footing where you want it, independent of seat height. And if you spend a lot of time on the phone, you'll appreciate the way our Executive Chair lets you rock freely or lock your chair in virtually any tilting position.

All three styles cradle your body in a most comforting way. The curved backrest hugs your back, with gentle indentations to accommodate your shoulder blades and a raised area to support your lower back.

On the seat bottom, a raised back and waterfall front-edge balances your spine while allowing free circulation in your

thighs. Its high-density foam padding is thicker than in most chairs, yet resilient enough to stay firm when too-soft foams "bottom out."

Quality from the casters up Many other ergonomic chairs are strong on style but short on substance. HP chairs give you both.

In fact, we've built in features found in chairs that cost as much as a thousand dollars. Like a sturdier-than-normal gas cylinder that meets strict European standards. Armrest brackets with the strength of motor mounts. And thoughtfully placed levers and knobs that let you make as many as five individual adjustments without leaving your seat.

Tested without mercy No chair—no matter how adjustable—is comfortable when it's broken. So we tested the design of our chairs in ways that would make most manufacturers shudder.

We gave the arms 200 pounds of downward pressure and 100 pounds of outward pressure. We stressed the backrest and seat front thousands of times. The base had to stand up to 2,500 pounds!

We didn't have to but, we had our chairs built to meet all BIFMA* standards for safety, performance and durability. Few others can make that claim. And ours are covered by Hewlett-Packard's well-known money-back guarantee.

*Business & Institutional Furniture Manufacturers Association

Deeply contoured foam backrest comforts your upper back and shoulder blades, while offering lumbar support where it counts most.

Fabric is tightly woven for strength, yet breathes so you stay cool. Won't pill, resists stains and acids, won't discolor like nylon.

State-of-the-art molded base is stronger than steel bases. And because the color's molded in, it can't scratch like the paint on steel.

Individual controls let you adjust seat height, backrest tension, backrest support and more, while remaining comfortably seated in your chair.

Molded metal five-star base offers maximum stability—keeps your feet on solid ground no matter how active your day.

German-made pneumatic cylinder adjusts seat height securely, absorbs shock when you sit. It's wider than the cylinder on most chairs, and meets the most stringent European standards for durability.

Self-locking casters roll when you need to move about freely, hold steady when you need stability.



Look at the range of adjustment you get with each chair:



Raise or lower your seat up to 152.4mm (6 in.)—your legs are angled comfortably whether you're tall or petite.



Move your backrest as much as 127mm (5 in.) up or down, to suit your posture or working preference.



Tilt your seat upward or downward—great for close keyboarding or casual meetings at your desk.



Lock your chair back into virtually any position.



Move the Workbench Chair's footrest upward or downward 177.8mm (7 in.)—hook your heels in and lean forward with confidence.

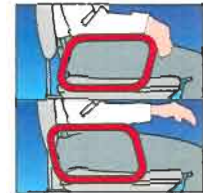

Angle the armsets of your Workstation/Managerial Chair and Executive Chair in either direction—rest your hands or get up close to your desk.

HP Ergonomic Chairs and accessories

	Description/Specifications	Color	Product number	Price
HP Ergonomic Executive Chair	Seat specifications Height 413-483mm (16.25-19 in.) Width 483mm (19 in.) Depth 457mm (18 in.) Adjustment 413-483mm (16.25-19 in.)	Chair back specifications Height 457mm (18 in.) Width 445mm (17.5 in.) Adjustment 457-514mm (18-20 in.)	Gray	92208M (1-2) \$475.00 ea.
			Blue	92208N (3+) 440.00 ea.
			Beige	92208P
HP Ergonomic Workstation/Managerial Chair	Seat specifications Height 413-527mm (16.25-20.75 in.) Width 470mm (18.5 in.) Depth 457mm (18 in.) Adjustment 413-527mm (16.25-23 in.)	Chair back specifications Height 267mm (10.5 in.) Width 406mm (16 in.) Adjustment 267-394mm (10.5-15.5 in.)	Gray	92208E (1-2) \$245.00 ea.
			Blue	92208F (3+) 225.00 ea.
			Beige	92208G
HP Ergonomic Workbench Chair	Seat specifications Height 483-648mm (19-25.5 in.) Width 470mm (18.5 in.) Depth 457mm (18 in.) Adjustment 483-648mm (19-25.4 in.)	Blue	92208S (1-2) \$365.00 ea. (3+) 340.00 ea.	
Cylinder (MNP)	Replacement cylinder for 92208M/N/P HP Ergonomic Executive Chair		92208Q (1-2) \$40.00 ea. (3+) 37.00 ea.	
Cylinder (EFG)	Replacement cylinder for 92208E/F/G HP Ergonomic Workstation/Managerial Chair		92208H (1-2) \$40.00 ea. (3+) 37.00 ea.	
Cylinder (S)	Replacement cylinder for 92208S HP Ergonomic Workbench Chair		92208U (1-2) \$55.00 ea. (3+) 51.00 ea.	
Black Armset	Optional, reversible armset for 92208E/F/G HP Ergonomic Workstation/Managerial Chair		92208K (1-2) \$79.00 ea. (3+) 69.00 ea.	
Caster Set	Replacement sets for all the above HP Ergonomic Chairs		92208L (1-2) \$39.00 ea. (3+) 35.00 ea.	

Snap together your own custom workstation

Be creative—The MicroManager™ System introduces a practical alternative to custom designed workstations. You can mix and match the snap-together stacking modules into a peripheral stand, monitor cabinet, PC workstation, or whatever your working needs demand. The configurations are practically endless. Expand your workstation to meet your growing needs.

Each module conceals unsightly cables to give you a clean, cable-free appearance. Cable channels run vertically and horizontally throughout the frame of each module. Simple snap off the cable covers to route your cables along the channel system. Snap the cable covers back into place to conceal the cable path. With cables safely hidden, you won't have to worry about tripping over dangling cables when you move the MicroManager around your office.

Starting with the basics

The base floor unit (92299A) consists of two standard modules stacked together, mounted on a four-wheel base. Mobile and sturdy, it forms a convenient platform for your HP ColorPro (7440) or 7470 Plotter, printers and disc drives.

Store modems, switches and other devices by simply adding on the standard module (92299B) to the base floor unit. You gain a taller mobile unit and more storage space.

Add versatility Mount the pull-out shelf (92299C) between your base floor unit and standard module and gain easy access to your printers, plotters and disc drives.

Add the keyboard drawer module (92299D) to your base floor unit (92299A) and standard module (92299B) and you get a built-in roll-out drawer. The keyboard drawer locks into place to give you solid support for data entry.

Save with PC workstation kits Save time and money—take advantage of our two computer workstation kits. Use the 92299E compact PC workstation for your HP Touchscreen I/II (HP 150 Personal Computers) and Model 16 computers, as well as for your terminals. Use the 92299F compact workstation for your HP Vectra PC. The packaged price will save you money over the cost of modules when purchased individually.

Order what you need now. Later on, add to your workstation as your needs grow. The MicroManager System puts you in control of your budget. See the latest additions to HP's MicroManager™ system on the next page.









Channels along each module conceal unsightly cables.



Constructed of high-impact styrene, the modules are easily assembled with a screwdriver.

HP MicroManager™ system*

	Description	Product no.	Price
	Floor Unit. Two standard modules on a locking caster base. 457 H x 616 W x 445 Dmm (18 H x 24.25 W x 17.5 D in.)	92299A	(1-2) \$119.00 ea. (3-5) 112.00 ea. (6-9) 105.00 ea. (10+) 98.00 ea.
	Standard Module. Can be stacked on 92299A or used on desktop as a printer stand. 184 H x 616 W x 445 Dmm (7.25 H x 24.25 W x 17.5 D in.)	92299B	(1-2) \$46.00 ea. (3-5) 43.00 ea. (6-9) 40.00 ea. (10+) 37.00 ea.
	Pull-Out Shelf Module. Mounted between two 92299B modules. 38 H x 616 W x 445 Dmm (1.5 H x 24.25 W x 17.5 D in.) Shelf: 19 H x 527 W x 394 Dmm (.75 H x 20.75 W x 15.5 D in.)	92299C	(1-2) \$59.00 ea. (3-5) 55.00 ea. (6-9) 51.00 ea. (10+) 47.00 ea.
	Keyboard Drawer Module. Can be stacked on standard modules or used on desktop. 114 H x 616 W x 445 Dmm (4.5 H x 24.25 W x 17.5 D in.) Drawer: 66 H x 518 W x 254 Dmm (2.6 H x 20.4 W x 10 D in.)	92299D	(1-2) \$99.00 ea. (3-5) 93.00 ea. (6-9) 87.00 ea. (10+) 81.00 ea.
	Compact PC Workstation Kit for HP Touchscreen I, II, Model 16 computers. Combination of 92299A/B/C/D. 775 H x 616 W x 445 Dmm (30.5 H x 24.25 W x 17.5 D in.) Simple assembly required.	92299E	(1-2) \$290.00 ea. (3-5) 275.00 ea. (6-9) 260.00 ea. (10+) 245.00 ea.
	Compact Workstation Kit for Vectra PC. Combination of 92299A, 92299B, a special 1/2 height module, and 92299C (two each). 806 H x 616 W x 445 Dmm (31.75 H x 24.25 W x 17.5 D in.) Simple assembly required.	92299F	(1-2) \$280.00 ea. (3-5) 265.00 ea. (6-9) 250.00 ea. (10+) 235.00 ea.

*All modules come in cream-gray color

Workstations that grow along with your needs

With the help of the MicroManager™ System your office can be quickly organized. These compact units can be set up in almost endless configurations to make customized desktop stands, peripheral stations, or mobile work areas. Later, when you add new equipment or rearrange the office, you can interchange the modules or add new modules in a snap.

The stands are sturdy enough to hold CRT monitors, CPU's, printers or plotters. Each standard module contains concealed channels through which cables can be routed to reduce wire clutter. See previous page for the basic line of MicroManager components.



Place your work at the right angle Free up more space by attaching a copy holder (92299K) to the corner of any standard unit. This handy snap-on device is a must when data entry and word processing are your main activities. The viewing angle revolves 360 degrees so that documents can be positioned right where the operator can comfortably see and work with them. Combine the copy holder with a keyboard drawer unit (92299D) or your PC workstation (92299E/F) to form a complete data entry workstation.

Add to your work space Attach the side tray (92299J), shown in photo at left, to any standard module and gain extra surface area to spread out your work. It conveniently holds documents, flexible disk boxes, and other small accessories. The tray mounts on the front and rear corner channels. Two "snap-on" brackets are included to support up to 10 pounds of weight (4.5 kg).

Store plotter supplies in one place—right with the plotter

With a mobile plotter station (92299G) your HP plotter and all the pens, paper, and film used with it are conveniently organized in one compact unit. And it easily rolls into place wherever it's needed in the office. The plotter station consists of a floor unit (92299A), a custom plotter drawer that extends and retracts on ball bearing slides, and a standard module (92299B). Inside the plotter drawer are three storage bins, an organizer for 20 pens, space for two plotter pen carousels, a tray for paper and a tray for packaged pens. Extra paper and transparency film store on bottom shelves.



HP MicroManager™ accessories

	Description	Product no.	Price
	Mobile Plotter Station* for HP ColorPro, 7470A, and 7475A plotters. Floor unit and standard module (92299A/B) combined with special plotter drawer. 667 H x 616 W x 445 D mm (26.25 H x 24.25 W x 17.5 D in.)	92299G	(1-2) \$249.00 ea. (3-5) 239.00 ea. (6-9) 225.00 ea. (10+) 210.00 ea.
	LaserJet Printer Station* for Printers up to 80 lbs. Two shelves and a sturdy base store all your LaserJet supplies. Includes a removable font organizer. 711 H x 610 W x 445 D mm (28.0 H x 24.0 W x 17.5 D in.)	92299H	(1-2) \$219.00 ea. (3-5) 209.00 ea. (6-9) 195.00 ea. (10+) 180.00 ea.
	Side Tray.* Can be mounted on 92299G or 92299E/F, or any standard module. 12.7 H x 251 W x 445 D mm (.5 H x 9.9 W x 17.5 D in.)	92299J	(1-2) \$22.00 ea. (3-5) 20.00 ea. (6-9) 19.00 ea. (10+) 18.00 ea.
	Copy Holder.* Mounts into corner of 92299G or 92299E/F, or any standard module. 241 W x 318 H mm (9.5 W x 12.5 H in.)	92299K	(1-2) \$39.00 ea. (3-5) 36.00 ea. (6-9) 34.00 ea. (10+) 32.00 ea.
	Paper Refold Guide. Wire guide hooks onto back of module. 191 H x 457 W x 51 D mm (7.5 H x 18 W x 2 D in.)	92299L	(1-2) \$24.00 ea. (3-5) 20.00 ea. (6-9) 19.00 ea. (10+) 18.00 ea.
	Paper Catcher Basket. Wire basket hooks onto back of module. 114 H x 457 W x 406 D mm (4.5 H x 18 W x 16 D in.)	92299M	(1-2) \$39.00 ea. (3-5) 36.00 ea. (6-9) 34.00 ea. (10+) 32.00 ea.



Paper refold guide (92299L) hooks onto the rear of any module to direct printouts into the module shelf below. The guide allows you to feed, print, and smoothly refold a stack of paper 5¼-inches (140

mm) high, yet only increases the depth of the unit by 2-inches (51 mm).

The paper catcher basket

(92299M) hooks to the rear of standard modules to catch lengthy printouts. Paper is neatly and smoothly stacked outside the module, freeing the unit shelves below for equipment. Leave it in place permanently or add when needed.

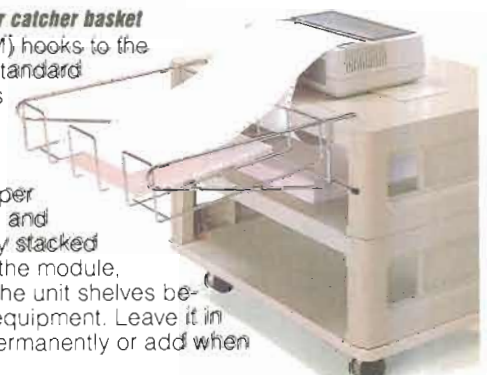

*Constructed of high-impact styrene, in cream-gray color.

HP storage cabinets offer versatility and convenience plus!

Our line of cabinets offers you a more versatile, preconfigured system that will help save time and better organize your filing and storage needs.



They come pre-assembled in five common configurations so you don't have to build them—they arrive ready to use.

Another outstanding feature is the side-opening tambour door. No more bending or reaching to open and close your cabinet door. It glides open easily and when closed, locks to protect your stored data and media.

Other standard features:

- All steel construction
- Three cabinet heights to fit your storage needs
- Fixed and roll-out shelves for three-ring binders, disc cartridges and packs
- Hanger bars for data binders and mag tape in seals
- Optional oak woodgrain top for small and medium height cabinet tops
- Extra accessories for special storage requirements

With an attractive cream-grey finish, these cabinets are a perfect complement to HP *Design Plus* and HP Standard furniture, or any other office environment.

Also available are small and large data binder handles that convert standard data binders to single point suspension units. All hanger bars in the 92272 Series cabinets require a single or center point suspension capability for data binders. HP data binders, 92174A-H and J-K already support single point suspension.

Finally, we pay the freight! That's right, we pay the freight to your location. No freight bill surprise when your cabinet arrives. Call and order today. Do allow extra time for delivery as these cabinets are shipped by truck.

Media and documentation storage cabinet guide (ordering information page 117)

Product no.	Cabinet description	Dimensions				Installed components		
		Height	Width	Depth	Weight	Fixed shelf	Hanger bars	Roll-out shelves
92272A	Workstation Storage	Outer:	98cm (38.5 in.)	93cm (36.5 in.)	53cm (21.0 in.)	67.3kg (148 lbs.)	1	2
		Inner:	84cm (33.0 in.)	79cm (31.0 in.)	47cm (18.6 in.)			
92272B	Medium Storage	Outer:	152cm (60.0 in.)	93cm (36.5 in.)	53cm (21.0 in.)	103.2kg (227 lbs.)	1	1*
		Inner:	139cm (54.8 in.)	79cm (31.0 in.)	47cm (18.6 in.)			
92272C	Printout/documentation Storage*	Same as 92272B above				90.0kg (198 lbs.)	1	2*
92272D	Mag Tape Storage	Outer:	213cm (84.0 in.)	93cm (36.5 in.)	53cm (21.0 in.)	113.2kg (249 lbs.)	5*	2
		Inner:	199cm (78.5 in.)	79cm (31.0 in.)	47cm (18.6 in.)			
92272E	Large Storage	Same as 92272D above				132.7kg (292 lbs.)	1	2*
92272F	Library Tape Storage Rack	200cm (79.5 in.)	123cm (48.5 in.)	33cm (13.2 in.)			6*	

*Mag tape-in-seals hang directly on bars. Printout/documentation requires 92174-Series HP data binders or 92272K/L data binder handles to hang on bars.

Cabinet accessories

92272G Hanger Bar for data binders and mag tape. Holds 34 tapes-in-seals
(1 bar) \$53.00 ea.
(2+) 48.00 ea.

92272H Fixed Shelf for documentation binders and miscellaneous items.
(1 shelf) \$65.00 ea.
(2+) 59.00 ea.

92272J Oak Top for 92272A/B/C cabinets. (Top is simulated oak woodgrain.)
(1 top) \$95.00 ea.
(2+) 85.00 ea.

92272K Data Binder Handles. Converts 30cm x 21cm (12 x 8.5 inch) data binders to single-point or center-point suspension for hanging on hanger bars. Handle length is 35cm (14 inches). Not needed if using HP data binders unless you want to convert to center-point suspension. Comes in box of 10.
(1 box) \$49.00 ea.
(2+) 43.00 ea.

92272L Data Binder Handles. Converts 37cm x 28cm (14.8 x 11 inch) data binders to single point or center point suspension for hanging on hanger bars. Handle length is 43cm (17 inches). Not needed if using HP data binders unless you want to convert to center point suspension. Comes in box of 10.
(1 box) \$59.00 ea.
(2+) 53.00 ea.

**HP storage cabinets . . .
pre-assembled and space-efficient**



Comes with one fixed shelf and two installed roll-out shelves.

92272A Workstation Storage Cabinet.*
(1 cabinet) \$825.00 ea.
(2+) 780.00 ea.

*Shown with optional 92272J oak top



Comes with one fixed shelf, two roll-out shelves and one installed hanger bar.

92272B Medium Storage Cabinet.*
(1 cabinet) \$990.00 ea.
(2+) 940.00 ea.



Comes with one fixed shelf and two installed hanger bars.

92272C Printout/Documentation Storage Cabinet.*
(1 cabinet) \$825.00 ea.
(2+) 785.00 ea.



Comes with five installed hanger bars. Holds 170 tapes-in-seals.

92272D Mag Tape Storage Cabinet.
(1 cabinet) \$900.00 ea.
(2+) 855.00 ea.



Comes with one fixed shelf, two roll-out shelves, and two hanger bars.

92272E Large Storage Cabinet.
(1 cabinet) \$1125.00 ea.
(2+) 1050.00 ea.



Storage for high-density tape storage at minimum cost. Up to 300 tape reels in seals may be stored in any combination of 600-foot, 1200-foot or 2400-foot reels.

92272F Library Tape Storage Rack.
(1 rack) \$335.00 ea.
(2+) 308.00 ea.

**Remember! Our listed prices include shipment to you
(see back of catalog for details).**

Locking mobile PC Centre saves space, adds security

HP's Mobile PC Centre—space efficient in dimension and spacious in design. It stands 1.31m (4½ ft.) high and takes up a minimum of floor space. Yet it has lots of room for your computer/terminal, disc drive and printer as well as your software, diskette holder, printer paper and other supplies. With no computer clutter on your desk you gain more work surface and more space for your other office needs.

You can easily maneuver this PC Centre behind, or next to, your desk, or anywhere you want your computer system to be. And when you're through for the day, simply slide in the roll-out shelves, close the doors and lock your PC Centre. No need to worry about the security of your computer equipment and invaluable data!

Top shelf accommodates any of the following HP computers and terminals: HP Vectra PC, Touchscreen/Touchscreen II (HP 150 Personal Computers), the Model 16 Technical Computer, and the 239X Series Terminals. Middle shelf will support either one of the HP InkJet Series Printers or 2603A Daisywheel Printer. Dimensions: 1,232 H x 658 W x 602 D mm (48.5 H x 25.9 W x 23.7 D in.).

92208A Mobile PC Centre	
(1-2)	\$659.00 ea.
(3-9)	629.00 ea.
(10+)	595.00 ea.

The PC Centre is shipped unassembled and requires assembly with simple tools

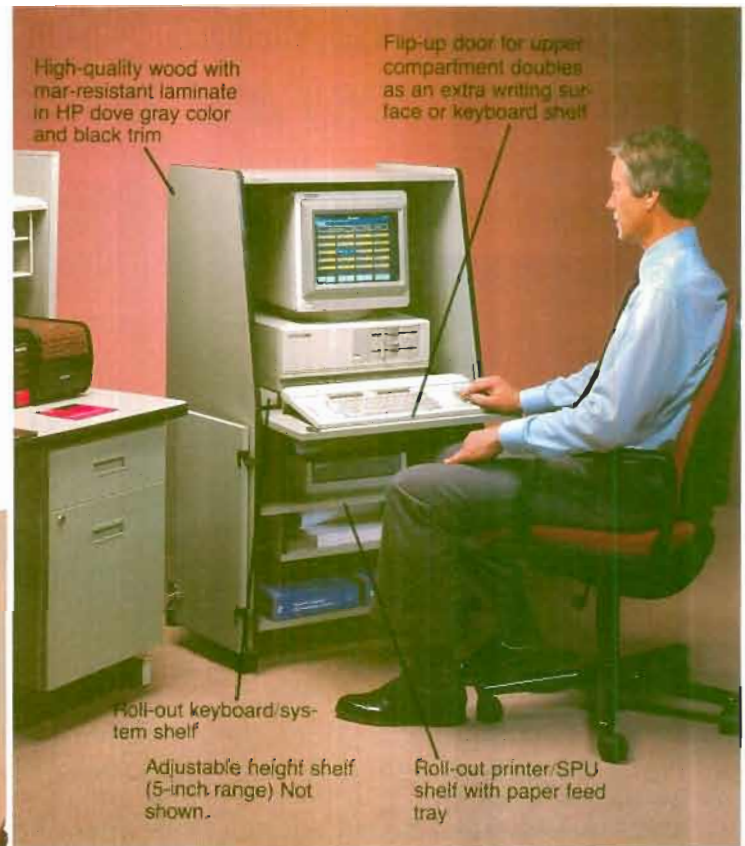

HP's mobile PC Centre keeps your computer/terminal, disc drive, printer, software, and other supplies all in one secure place.

Roll your files where they're needed most

Store your documents with our Mobile File Unit. Files and Handles—then roll them all away on smooth, gliding casters for a more organized workplace!

These durable, steel drop-filing systems come in compact and large sizes. The compact model has 343mm (13.5 in.) of horizontal filing capacity while the large unit accommodates 610mm (24 in.) of files. And our Data Binders and Handles offer transportable security for your important files.

92272N Compact Mobile File Unit	
(1-2)	\$67.00 ea.
(3+)	59.00 ea.
92272M Mobile File Unit	
(1-2)	\$139.00 ea.
(3+)	129.00 ea.

Data Binders, box of 10. Measure 376 x 279mm (14.8 x 11.0 in.):	
92174A Red	
92174B Gray	
92174C Light blue	
92174D Dark blue	
(1-4)	\$44.00 ea.
(5-9)	41.00 ea.
(10+)	38.00 ea.

Data Binders, box of 10. Measure 305 x 216mm (12.0 x 8.5 in.):	
92174E Red	
92174F Gray	
92174G Light blue	
92174H Dark blue	
(1-4)	\$44.00 ea.
(5-9)	41.00 ea.
(10+)	38.00 ea.

Data Binders, box of 10. Measure 241 x 279mm (9.5 x 11.0 in.):	
92174J Red	
92174K Dark blue	
(1-4)	\$44.00 ea.
(5-9)	41.00 ea.
(10+)	38.00 ea.
92272K Black 14-in. Data Binder Handles, box of 10.	
(1)	\$49.00 ea.
(2+)	43.00 ea.

92272L Black 17-in. Data Binder Handles, box of 10.	
(1)	\$59.00 ea.
(2+)	53.00 ea.



Large Mobile Unit is chair-level for easy-to-reach files, while the Compact Mobile Unit fits under any desk or table.