



HEWLETT
PACKARD

COMPUTER USERS CATALOG

Winter 1988/89

CALL HP DIRECT
800-538-8787

We ship same day

*HP and the
San Francisco Symphony
make beautiful music
together.*

See cover story on page 1.

*Over 75 new products await you!
See pages 2-13.*



Quality means customer satisfaction at HP DIRECT!

"The dozens of on-going quality improvement projects and hundreds of people involved in them have one common goal—the best customer service in the industry.

Customers like you help by telling us what's important. Then we set goals like those discussed below by a few of our managers. When we achieve our goal, you get better service and we get loyal, satisfied customers. This is how we plan to remain the best in the industry.

Give us a hand—tell us what's important to you. Just give us a call and pass your idea on to a telemarketer (800-538-8787).

Thanks for your help!"

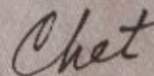

Chet Harmer
HP DIRECT Controller



First order of business: banish backorders.

"While some companies couldn't stay in business without backorders, we've pledged to ship your order the same day and we mean it. We set up a 15-person team to study and eliminate out-of-stock situations. As a result of their guidelines and training programs, we ship 99.7% of all orders, complete, within 24 hours. You get what you need and you get it fast."

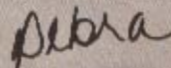

Debra Deadwyler
Materials Manager



We won't leave you hanging on "hold".

We value your business too much to make you wait. Eighty percent of the time, you'll be talking to a telemarketer before the third ring. We also strive to have fewer than 2 percent of our callers wait more than 60 seconds for service. So if you don't hear a telemarketer answer after the second ring, chances are it's because they answered it before the first!

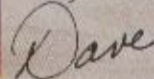

Dave Iuppa
Telemarketing Manager



Credit card clearance on the spot.

"To ship your order in 24 hours or less, we have to resolve credit problems fast. The on-line systems we've put in place can verify your credit card number in 4 to 5 seconds. If everything checks out, you won't even know we've done it. But if there's a problem—like a wrong digit—we can resolve it before you hang up. So when you're counting on delivery, you'll get a package...not a phone call."

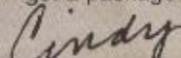

Cindy Orth
Credit Manager

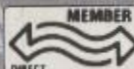

HP Computer Museum
www.hpmuseum.net

For research and education purposes only.

Win an HP Calculator

Just return the catalog subscription card inside this catalog.

The sooner you do, the more chances you have to win!

Locate your card between pages 96 and 97.



Table of Contents



2

New Products

Over 75 new products: Design Plus CAD furniture, StarLan cables, peripheral share devices and much more....



98

Furniture

Tables, cabinets, chairs and accessories to complement your HP computers and peripherals.



14

Printers

Toner, print cartridges, paper and more for your HP printer from LaserJets to Impact printers.



125

Calculators & PC supplies

Calculators, hardware accessories, books and manuals to help you in your work.



48

Plotters

Pens, media and accessories for HP business and drafting plotters.



144

Terminals

HP 700 Series Terminals to expand your DEC, IBM, ASCII or HP computer system.



64

Cables

Everything to connect your HP computers, peripherals and networks to almost any computer system.



150

Data communications & power conditioners

Cable testers, modems, and power protection to complete your HP computer system.



82

Disc & tape products

Floppy discs, data cartridges, mag tapes, rigid discs, and storage accessories to keep data secure.



Blue section

Ordering information and three handy indexes to help you find and purchase the products you want.

On the Cover

Thanks to HP the San Francisco Symphony has a song in its heart. One of the melodies is OLIS...the Orchestra Library Information System. With just strokes of the keyboard, OLIS provides symphony musicians and staff with archives of information on artists, composers, repertory, programming and instrumentation through the use of Vectra workstations.

In harmony with OLIS is PACT/3000, the Patron Accounting System, driven by HP terminals and HP 150's. PACT/3000 tracks season and box office ticket sales

and fundraising records for over 279,000 patrons. The system also allows concertgoers to choose their seats from a computerized image of Davies Symphony Hall, home of the San Francisco Symphony.

Financial accounting, word processing and electronic mail help round out the programs' perfect orchestration of high technology and musical tradition. With HP as the conductor, and this host of software as the musicians, the world will enjoy beautiful music for years to come.



Add bold, colorful text to your documents! It's easy with HP PaintJet Soft Fonts



What you see is what you get when you use these soft fonts with your HP PaintJet Color Graphics Printer!

HP PaintJet Soft Fonts work in tandem with your favorite Microsoft® Windows™ application

to help you create high-quality color text and graphics. You get:

16 strikingly varied fonts These soft fonts let you print in TmsRmn and Helv typefaces .8-, 10-, 12- and 14-point sizes...in medium, bold and italic type styles! Mix and match easily, as you please. It's an excellent solution for eye-catching reports or minor desktop publishing jobs, or for any text that needs a little extra life.

Very near letter-quality HP Soft Fonts make your documents look so sharp, they demand to get read! That's because our software engineers manipulated these fonts pixel by pixel for cleaner, more precise letters. It's called "hand-tuned bit-mapping." And it gives you a finished look that's more accurate than any other soft fonts available.

SETTING UP THE PAGE

Page size equals the dimensions of your publication—not the dimensions of the paper you will use for printing. Page size does not have to match paper size. Working on a double-sided publication? If you want to work on two pages at a time, choose "Facing pages" with the "New..." or "Page setup..." command from the File menu. If you know approximately how many pages your publication will have, specify the "# of pages." with the "New..." command so the pages are ready when you are. You can change the

In living color Make your words leap from the page by printing them in readable red...believable blue...go-ahead green! The choices are yours.

These soft fonts are available on 3.5-in. and 5.25-in. discs for HP Vectra PCs and other IBM PC compatibles. ☺

17301A HP PaintJet Printer Soft Fonts for Microsoft® Windows™ \$49.00 ea.

See that large, colorful type on the screen? You see it on paper, too, with HP PaintJet Soft Fonts!

SETTING UP THE PAGE

Page size equals the dimensions of your publication—not the dimensions of the paper you will use for printing. Page size does not have to match paper size. Working on a double-sided publication? If you want to work on two pages at a time, choose "Facing pages" with the "New..." or "Page setup..." command from the File menu. If you know approximately how many pages your publication will have, specify the "# of pages." with the "New..." command so the pages are ready when you are. You can change the page setup at any time.

HP PaintJet paper and print cartridges were used to get the crisp details and bright colors you see here. See page 30 for more information.

Create crisp, sharp graphics right at your desk with MatrixPlotter



Get high resolution graphics from your HP RuggedWriter 480 Printer! MatrixPlotter software lets you optimize the graphics capability of your 24-pin dot matrix printer, so you can produce

graphics so clean, your colleagues will think you used a laser printer.

Just think! The graphics you create—whether you use Lotus® 1-2-3®, ChartMaster, CAD or other software—will look sharper and more polished, for just a fraction of the cost of a graphics printer or plotter.

Print when you're ready—no more waiting in line for the office plotter! And you won't be chained to your RuggedWriter either, because MatrixPlotter lets you print multiple files unattended.

MatrixPlotter translates plotter graphics into files that can be output by any printer with Epson emulation capabilities. Just switch your RuggedWriter to the Epson emulation mode and follow MatrixPlotter's easy-to-use menus.

You'll save time because MatrixPlotter lets you print quickly. And since it translates color graphics into black-and-white textures, you'll get output sharp enough to photocopy or even transmit by telefacsimile.

MatrixPlotter is available for the HP Vectra PC and other IBM PC/AT compatibles. Supported by Insight Development Corporation. ☺

35190R MatrixPlotter Software for HP RuggedWriter 480 Printers \$99.00 ea.

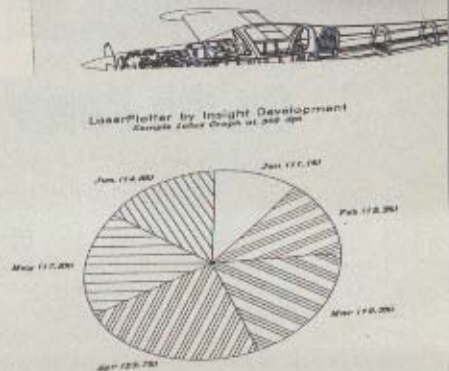
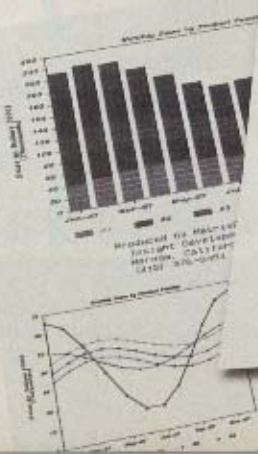
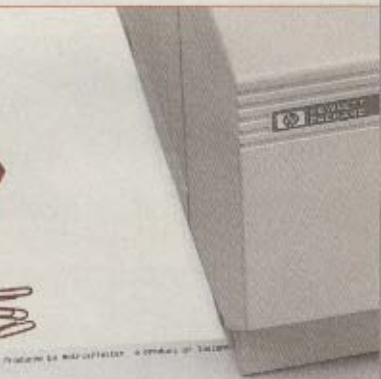

Now your RuggedWriter 480 Printer can produce professional-looking graphics with up to 72 line widths and patterns.

Protect RS-232 peripherals while you share them! Now our ABC switches have surge protection!

Because of their unique surge suppression capabilities, our ABC switches are the only products of their kind approved and supported for use with HP LaserJet printers. Now you can switch freely between printers, plotters and modems without the risk of sending damaging surges and spikes to your peripherals.

ABC switches also offer one of the lowest priced sharing solutions. With just the turn of a switch each user can access any peripheral from their own workstation.

What you need to know about cabling For each peripheral and/or PC you connect to the single ABC switch, order one **17355M** cable.

The dual ABC switch is supplied with two **92205U** Y cables. If you want to use the dual ABC switch to connect a third peripheral to two PCs, order an additional **92205U** Y cable. At most, three cables would be required for any configuration.

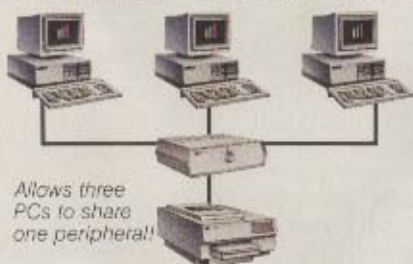

Allows three PCs to share one peripheral!



Allows three PCs to share two peripherals!



This ABC switch lets three PCs share the same printer or plotter. Or can be configured to allow one PC to access three peripherals, such as printer, plotter and modem.

92205E ABC Switch with built-in surge protection	
(1 unit)	\$189.00 ea.
(2-4)	177.00 ea.
(5+)	165.00 ea.



This switch lets three PCs share two peripherals, or allows two PCs to share up to three peripherals. Also, it can be used as two separate ABC switches. Includes two **92205U** Y cables.

92205F Dual ABC switch with built-in surge protection.	
(1 unit)	\$369.00 ea.
(2-4)	332.00 ea.
(5+)	295.00 ea.

Specifications

Size: 76.2 H x 177.8 W x 254 D mm
(3.0 H x 7.0 W x 10.0 D in.)

Weight: 0.8Kg (2 lbs.)

Enclosure: ABS plastic

Clamping voltage: + or - 25V

Line capacitance: RS-232 signal

Regulatory approvals: FCC Part 15, Subsection J, Class B compliant

Characteristics:

- 4 female DB-25 connectors (92205E), 8 female DB-25 connectors (92205F)
- Pins 2-8, 20 and 22 protected (other pins not passed through)
- Pin 1s are tied common—chassis ground
- Pin 7s are tied common—signal ground

HELPFUL IDEA!

Valuable information about surge protection



Additional surge protectors at your peripherals eliminate the risk of port damage.

Our ABC switches prevent surges from entering the datacomm lines and being passed on to your peripheral. However, spikes and surges can enter between the switchbox and the peripheral, causing the delicate interface circuitry to slowly deteriorate.

For maximum surge and spike protection of equipment with sensitive RS-232 data ports, invest in the **92165R** surge protector (page 158). It's inexpensive insurance against surge-induced equipment failure.

New DeskJet Cartridge Fonts



Landscape Upgrade. Allows DeskJet to print in landscape mode. Courier 16.7 pitch type style. Not for use with proportional-spaced fonts nor the 22707E HP Epson FX-80 printer emulation cartridge.

Landscape Upgrade
22707K
\$95.00 ea.

ABCabc123!"#\$%&'()*+úääååçèéèìì
ÀÀÊæÆöóóúÿÛÜçŁŸóúnñ•º¿¡¡¡¡¡¡¡¡¡



Landscape fonts cartridge. Supplements the 22707K. Courier 10 pitch, Letter Gothic 12 and 16.67 pitch, and Letter Gothic Italic 12 pitch. Can only be used with the 22707K Landscape Upgrade Cartridge.

Landscape Fonts
22707L
\$95.00 ea.

ABCabc123!"#\$%&'()*+úääååçèéèìì
ÀÀÊæÆöóóúÿÛÜçŁŸóúnñ•º¿¡¡¡¡¡¡¡¡¡

Take full control of your HP DeskJet Printer with LaserControl!

It lets you print easily from your existing software, without reconfiguring that software—or investing in additional printer drivers! Want to learn more about this unique product? Turn to page 23.



If you like WordPerfect, you'll love HP DIRECT

That's because we now offer this best-selling word processor for the HP Touchscreen PC (HP 150). It's the full-blown Version 4.2, complete with comprehensive thesaurus and 115,000-word spelling checker.

35190L WordPerfect on single-sided disc	
35190K WordPerfect on double-sided disc	
(1-4)	\$389.00 ea.
(5-9)	369.00 ea.
(10+)	359.00 ea.

Feel like you have your own HP LaserJet Series II Printer when 4 are sharing it!

Increase productivity as if you had your own HP LaserJet Series II printer! ShareSpool™ lets up to four people share the printer without waiting.

ShareSpool reduces the cost of the HP LaserJet Series II printer because it's distributed among four users. So you, not only save time, you save money for your company.

Installation is a snap! Just slide ShareSpool into your HP LaserJet Series II printer I/O slot. Then run an HP StarLAN cable and an adapter to each PC. Check the chart below for what you need.

ShareSpool won't interfere with the RAM Expansion slot, so you can still install an additional memory card in your HP LaserJet Series II printer. 158.8 H x 82.6 W x 28 D mm (6.25 H x 3.25 W x 1.10 D in.) Service and support provided by Extended Systems.

92204W ShareSpool for the HP LaserJet Series II Printer.

(1 unit)	\$495.00 ea.
(2-4)	450.00 ea.
(5-19)	425.00 ea.
(20+)	396.00 ea.

Specifications

- 256K bytes of memory (about 150 pages of text)
- Direct communication to HP LaserJet Series II Printer backplane.
- 9600 or 19.2K baud supported on all input ports.
- Data Terminal Ready hardware or Xon/Xoff software handshake.
- Data-embedded commands.
 - multiple copies (background print)
 - multiple copies (foreground print)
 - end-of-job reset sequence.
 - end-of-job timeout.
 - disable embedded commands.
- RJ-45 cable connection from ShareSpool to PC
- User installable
- Power-on integral self-test diagnostic



No waiting in line to use the department PC. With ShareSpool all you do is hit the print command.



You'll only have to leave your desk to pick up your printout! You can do everything else at your own workstation!



ShareSpool frees up your PC to work on other projects, while another is being printed!



ShareSpool keeps each user's file in on-board memory until it's printed. All four of you can input jobs simultaneously.

What you'll need to connect ShareSpool™

Adapters (choose one adapter for each PC)

PC	Description	Product no.	Price*
IBM PC, PC/XT, PS/2	25-pin RS-232 to modular jack for PC's with a 25-pin male connector.	92204X	(1 unit) ... \$20.00 ea.
			(2-4) ... 18.00 ea.
			(5-19) ... 17.00 ea.
			(20+) ... 16.00 ea.
HP Vectra PC, IBM PC/AT	9-pin RS-232 to modular jack for PC's with a 9-pin male connector.	92204Y	(1 unit) ... \$20.00 ea.
			(2-4) ... 18.00 ea.
			(5-19) ... 17.00 ea.
			(20+) ... 16.00 ea.
HP Touchscreen (HP 150)	25-pin RS-232 to modular jack for PC's with 25-pin female connector.	92204Z	(1 unit) ... \$20.00 ea.
			(2-4) ... 18.00 ea.
			(5-19) ... 17.00 ea.
			(20+) ... 16.00 ea.

*Note: Quantity discounts only apply when ordering the same adapter type.

Cables (Choose one cable for each PC)

Length	Product no.	Price
Less than 4m (13.1 ft.)	92268A	(1-4 units) ... \$16.00 ea.
		(5-8) ... 14.00 ea.
		(9+) ... 13.00 ea.
Less than 8m (26.2 ft.)	92268B	(1-4 units) ... \$18.00 ea.
		(5-8) ... 17.00 ea.
		(9+) ... 16.00 ea.
Less than 16m (52.5 ft.)	92268C	(1-4 units) ... \$22.00 ea.
		(5-8) ... 20.00 ea.
		(9+) ... 19.00 ea.
Less than 32m (105 ft.)	92268D	(1-4 units) ... \$27.00 ea.
		(5-8) ... 25.00 ea.
		(9+) ... 24.00 ea.

A screwdriver and a few minutes are all it takes to install the time-saving ShareSpool board into your HP LaserJet Series II printer.



Float your terminal above your desk!

Position your HP 700 Terminal where you need it most with this sturdy steel Swivel Stand. Raise it up to 228.6mm (9 in.) above your desk. Rotate it 360 degrees. Or clear it away from your desktop altogether. It's perfect for data entry!

There when you need it, gone when you don't—simply swing your terminal out of the way! Your keyboard floats away too, on

an attached holder. And the 360-degree rotation feature provides for easy terminal sharing.

Holds up to 50 pounds. This stand is great for any terminal or monitor with measurements similar to HP 700 Terminals*. Its heavy-duty clamp secures to work surfaces up to 50.8mm (2 in.) thick, with a

minimum overhang of 50.8mm (2 in.). Minor assembly required.

92166C Swivel Stand for HP 700 Terminals (1-2 units) \$99.00 ea.
(3+) 94.00 ea.

*HP 700 Terminals measure 241.3 H x 298.5 W x 520.7 D mm (9.5 H x 11.75 W x 20.5 D in.).



Raise your terminal for a clearer personal view, or rotate it to share information with others. You'll avoid much of the neck, back and shoulder fatigue associated with data entry.



Need your desktop for other tasks? Just swing that terminal and keyboard to the side on this sturdy steel stand.

Stack your ThinkJet on your HP 700 Terminal? Yes! In the grip of this sturdy, space-saving stand

Snap this ingenious stand onto your HP 700 Terminal and watch your HP ThinkJet printer do the unthinkable! It moves "upstairs," and suddenly you've got room to work. Your printer's right in front of you—taking zero desk space!

Completely secure at any angle. Custom-designed just for the HP 700, this easy-to-install acrylic stand "grabs" your terminal under tension and can't let go.

Just slide the 38.1mm (1.5 in.) prongs all the way into your terminal's screw-holes and push the stand forward until its lip clicks over the front edge of your terminal.

Then set the ThinkJet on top. Four rubber grippers squeeze the printer snugly so it can't budge. Slide in up to 400 sheets of fanfold paper, and you're set. Now swivel or tilt your terminal to any position. Your printer is 100 percent secure, and you've found the space you need to get things done. Dimensions: 165.1 H x 298.5 W x 304.8 D mm (6.5 H x 11.75 W x 12 D in.).

92269B ThinkJet Printer Stand for HP 700 Terminals (1-2 units) \$49.00 ea.
(3-9) 46.00 ea.
(10+) 41.00 ea.

Discover new room on your desk! Custom stand holds your ThinkJet safely at any angle, without taking a bit of your workspace.



Save 15% on high-capacity discs!

If you use a lot of high-capacity, 5.25-inch discs, you'll love our box of 100 that saves you 15% off the regular price.*

92190Z Box of 100, 5.25-inch, high-capacity, double-sided, unformatted, 1.2 MByte (formatted capacity) discs. (1 box) \$340.00 ea.
(2-4) 306.00 ea.
(5-19) 272.00 ea.
(20-99) 238.00 ea.

*Regular price applies to ten boxes with ten discs in each.



Prepare yourself for life's little emergencies with our Office Toolkit.

If you've ever tightened eyeglasses or unjammed a stapler, you recognize the worth of a miniature screwdriver and needle-nose pliers. And if you've ever upgraded an HP PC memory board, you know to keep a Pozidrive screwdriver handy.

Our Office Toolkit puts these and other expertly-crafted tools at your fingertips. Just look what you get:

- Pozidrive screwdriver with #1- and #2-size blades for HP equipment*. You won't find this in other office tool kits!
- Screwdriver with small slotted blade at one end and #0-size Phillips blade at the other—great for tightening cables.
- Miniature diagonal cutters for semi-flush wire cutting.
- Miniature chain-nose pliers with tapered, serrated jaws to hold, bend, loop and pull wires in close quarters.
- Adjustable wrench to handle nuts up to 19mm (¾ in.) in diameter.
- Groove-joint pliers that open up to 25mm (1 in.).

- Thin-line scissors.
- Miniature safety knife with retractable/reversible blade, plus one spare.
- Miniature tape measure to gauge up to 3m (10 ft.).
- Hammer with four slotted screwdrivers nested into its handle.

The tools come in a gray enforced canvas case that opens flat for easy access, with each tool held in place by wide elastic bands. It zips to a tidy 152 H x 152 W x 25 D mm (6 H x 6 W x 1 D in.)—the perfect fit for drawer, bookshelf, briefcase or handbag.

46297A Office Toolkit
 (1 unit) \$95.00 ea.
 (2-4) 93.00 ea.
 (5+) 91.00 ea.

This kit has everything you need for minor repairs, including a range of screwdrivers—even a Pozidrive!



*NOTE: Unauthorized repairs could void your service warranty. Contact your authorized HP dealer or sales representative for information.

Protect your HP Vectra PC from dirt and disaster



Now you can shield your HP Vectra CS/ES/ES12 or RS Personal Computer from office grime and static build-up, and even those inevitable liquid spills.

How? With our 100 percent cotton dust covers. They're specially treated to allow liquids to roll off, instead of leaking through to damage your PC.

At the same time, our covers let harmful condensation diffuse easily—unlike synthetics or vinyls. And our covers are designed to resist wrinkling, even after folding.

They're custom-tailored for a perfect fit, sure to enhance your total office environment. Each set is available in neutral tan with black piping, and completely machine-washable. ☺

92259L Dust Cover for the EGA/VGA Vectra CS/ES/ES12 or RS monitor and keyboard \$35.00 ea.

92259K Dust Cover for the monochrome Vectra CS/ES/ES12 or RS monitor and keyboard \$35.00 ea.

92259M Dust Cover for the monochrome VGA Vectra CS/ES/ES12/RS monitor and keyboard \$35.00 ea.



Liquids roll right off our dust covers—even hot coffee!

Interested in dust covers for all your HP equipment? See page 120.



Store your HP Vectra PC on the floor?

Of course! This low-cost upright Vectra PC floorstand saves you desk space without sacrificing the power and speed you need from your PC. Store it under your desk and still keep your display and keyboard within easy reach on your desk top. With the turn of two screws, you're ready to make room and take on any project that comes your way.

45989A Vectra Floorstand ... \$153.00 ea.

The engineers who designed your Vectra Tape Drive didn't start from scratch. They started with this cartridge. Here's why you should, too



You've got the tape drive. Now be sure you use the tape it was designed to run...the Vectra 40MB Tape Cartridge. It's the one that came with your tape drive...the one you can count on for perfect backups:

The most trouble-free tape ever made A carbon backcoating over the length of the tape reduces static buildup that attracts dust. Because the tape stays cleaner, it puts less wear on your drive head. That means they both last longer. It also means faster, safer backups. Dust and debris keep a drive head from writing accurately. So it tries again. And again. By staying cleaner than other tapes, this one

actually saves you backup time. And it reduces the chance of "read" errors if you ever have to reconstruct your files.

Certified & preformatted—you save an hour per tape Add to all this the fact you can use it as is, right from the package, and you'll see why this is the cartridge for fast, easy Vectra backups you can trust. For use with D1671A drive.

92192T Box of five pre-formatted, certified cartridges. Each 62.48m (205 ft.) long, 40 MB, 24 track, 6.27mm (.25 in.) wide.
 (1 box of 5 cartridges) \$175.00 box
 (2-4) 159.00 box
 (5-19) 149.00 box
 (20+) 139.00 box

Built-in compatibility means you get total backup security with the Vectra 40 MB Tape Cartridge.

Attention HP 9145A drive users: Protect your precious data with our reliable cartridges

These cartridges were engineered and tested for your HP 9145A drive so you can trust them with your valuable data. The high-capacity 133MB size reduces

cartridge switching, while the 33MByte size is ideal for situations requiring less memory.

You'll save time, too! Thanks to the 4MB/minute data transfer rate, and 120 inches per second tape speed, you'll be able to back up your hard disc in half the time it takes the 9144 drive!

We give you two options to meet your storage needs—133MB or 33MB capacity cartridge.



92245L 133MB preformatted data cartridges. 182.9m (600 ft.) long, 32 track, 6.4mm (.25 in.) wide. Five cartridges in each box, plus labels.
 (1 box) \$239.00 ea.
 (2-4) 224.00 ea.
 (5-19) 209.00 ea.
 (20+) 199.00 ea.

92245S 32MB preformatted data cartridges. 45.7m (159 ft.) long, 32 track, 6.4mm (.25 in.) wide. Five cartridges in each box, plus labels.
 (1 box) \$189.00 ea.
 (2-4) 177.00 ea.
 (5-19) 165.00 ea.
 (20+) 157.00 ea.

Compatibility Chart

Use this chart to select the right cartridge and capabilities for your drive.

Cartridge	HP 9144A drive	HP 9145A drive
16-track cartridge HP 88140LC/SC	Loads, reads and writes.	Loads and reads but doesn't write.
32-track cartridge HP 92245L/S	Doesn't load, read or write.	Loads, reads and writes.

Organize up to 18 mini data cartridges under lock and key.

Here's a convenient way to organize your 92192T or 98200A mini data cartridges, while protecting them from dust, spills and "casual borrowing." This locking tray includes tabbed dividers and labels for quick identification and access, and a back-up key in case you misplace the original. A detachable hinge lets you nest the clear acrylic, anti-static lid under the

cream-color, high-impact plastic base, cutting desk-top clutter so you have room to get down to business.

921920 Data cartridge tray for use with 92192T or 98200A mini data cartridges.
 (1-2 units) \$45.00 ea.
 (3-6) 42.00 ea.
 (7+) 39.00 ea.



HP StarLAN cable— low-cost and easy to install



HP now offers premeasured and connectorized StarLAN cable to link your computer system to your StarLAN hub. Via a central StarLAN hub you can exchange data files, share data storage facilities, and pool your printers and plotters.

- HP StarLAN cable was designed to connect HP computer systems, IBM PCs and peripherals to your StarLAN hub.*
- HP StarLAN cable consists of four twisted pair cable with an 8-pin RJ 45 connector and installs as easily as telephone cable.
- HP StarLAN cable conforms to the Ethernet IEEE 802.3 1BASE5 standard.

*Not designed for Touchscreens (HP 150s).



StarLAN Cables

Length	Product no.	Price
4m (13.1 ft.)	92268A	(1-4) ... \$16.00 ea.
		(5-8) ... 14.00 ea.
		(9+) ... 13.00 ea.
8m (26.2 ft.)	92268B	(1-4) ... \$19.00 ea.
		(5-8) ... 17.00 ea.
		(9+) ... 16.00 ea.
16m (52.5 ft.)	92268C	(1-4) ... \$22.00 ea.
		(5-8) ... 20.00 ea.
		(9+) ... 19.00 ea.
32m (105.0 ft.)	92268D	(1-4) ... \$27.00 ea.
		(5-8) ... 25.00 ea.
		(9+) ... 24.00 ea.

Plug your StarLAN into a phone jack

Set up your StarLAN conveniently with this 5m (16.4 ft.) twisted-pair cable adapter. It has an 8-pin modular connector at one end, and a 6-pin RJ11 plug that's compatible with standard telephone jacks at the other. NOTE: Connect only to unused telephone wiring.

92268S 6- to 8-pin cable adapter	
(1-4 units)	\$16.50 ea.
(5-8)	14.50 ea.
(9+)	13.50 ea.

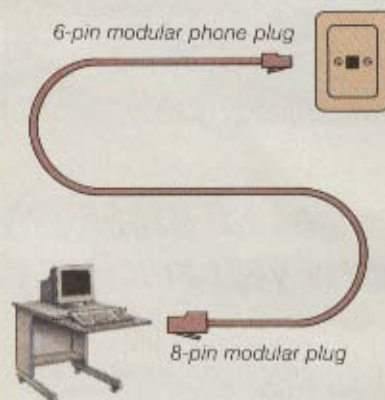

Customize your StarLAN easily with unterminated cables

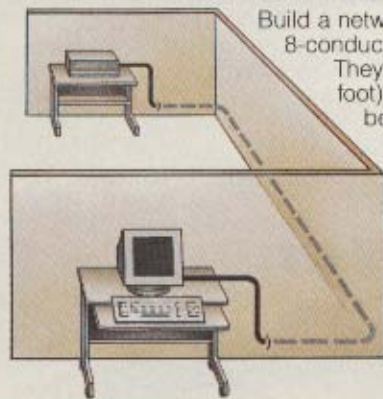

Build a network totally suited to your workplace with our 8-conductor twisted-pair cables.

They're available in 100m and 300m (328 and 984 foot) lengths, so you can cut the length you need between your StarLAN hub and PCs. Because they're unterminated, you cut to length and install plugs as necessary—our 92268P RJ45 Modular Plugs and 92268T Crimper Tool make it easy.

And unlike pre-connectorized cables, these cables are easy to insert and run through conduit.

These cables can be cut to suit any StarLAN1/10 configuration, and fed easily through conduits.



StarLAN Connector Crimper Tool lets you crimp 8-pin modular plugs to 92268M/N unterminated cables, securely and permanently. Cable cutter included.

92268T	\$95.00 ea.
---------------------	-------------



8-Pin Modular Plugs can be crimped onto 92268M/N unterminated cables in seconds. They're composed of 8-conductor/4-pair modular plastic and available in boxes of 25.

92268P	\$37.00 box
---------------------	-------------

Unterminated StarLAN cables

Length	Product no.	Price
100m (328 ft.)	92268M	(1-4 units) ... \$28.00 ea.
		(5-8) ... 24.00 ea.
		(9+) ... 21.00 ea.
300m (984 ft.)	92268N	(1-4 units) ... \$70.00 ea.
		(5-8) ... 60.00 ea.
		(9+) ... 52.00 ea.

NOTE: Maximum distance for StarLAN1 cabling is 250 meters. Maximum distance for StarLAN10 cabling is 100 meters.



Complete your installation with Modular Wallplates

Give your twisted pair network a finished look with these molded plastic wallplates. Designed to look like standard electrical wallplates, these plates feature an 8-pin RJ45 jack for your StarLAN as well as a 6-pin RJ11 jack for your telephone. Each plate also has identification labels and removeable plastic windows. Available in boxes of 12.

92268J Modular Wallplate for StarLAN1/10 \$99.00 box

Learn how to set up and utilize your StarLAN1/10

Here's all the information you'll need to install StarLAN1 or StarLAN10 cables and accessories. This informational manual also includes helpful hints on cabling system-planning, plus documentation for twisted pair installations.

5959-2208 HP SiteWire Twisted-Pair Cabling Installation Guide ... \$37.00 ea.



Redefine your concept of comfort with our Ergonomic Chairs! See pages 108-109.

Clean up toner & paper dust fast! This improved vacuum is so easy to use, it makes laser printer upkeep a breeze.



Your vacuum comes with: 1) a filter, 2) a 1.8m (6 ft.) stretch hose, 3) a flexible goose neck, 4) a crevice tool with brush, 5) a 3.7m (12 ft.) power cord, 6) a static-draining ground wire with wrist strap—all packed into a light-weight, easy-to-carry case.

This specially designed vacuum makes cleaning your laser printers and copiers so easy, you'll never risk dirty-equipment problems again!

This is no ordinary vacuum! No general-purpose vacuum seeks out, whisks away and—most important—traps tiny toner particles the way this one does. Our vac's hose is "toner-proof," that is, it will not get stiff or sticky from toner, so there's no danger of toner escaping into the atmosphere. And the vacuum itself is smaller, lighter, quieter and 20 percent more powerful than before.

Custom-made for toner pickup The disposable filter traps particles as small as .3

microns (toner measures 5 microns). When it's full, an indicator light tells you so. No guessing, and no messing with bags. An extra-long hose and thoughtful accessories, like the rubber gooseneck that bends around corners, let you reach every nook and cranny without getting a speck of dust on yourself.

A static-draining wire and wrist strap protect your printer's sensitive circuits. And everything packs neatly in a carrying case not much bigger than a lunch box. UL/CSA listed. ☑

92175V HP PM Vacuum
(1 unit) \$249.00 ea.
(2+) 219.00 ea.

Why your office vac isn't enough

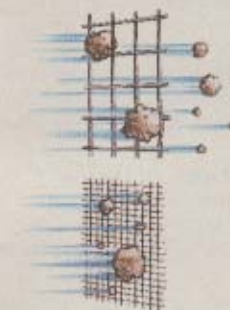

Ordinary vacuums allow particles smaller than 70 microns to escape back into the air you breathe.

The HP PM Vacuum filter traps toner particles as fine as .3 microns—much, much smaller than your toner!

Replacement accessories:

92175W Filter for 92175V (1 unit)	\$22.00 ea.
(2-3)	18.00 ea.
(4+)	15.00 ea.
92175F Stretch hose* 1.8m (6 ft.)	26.95 ea.
92175G Power cord* 3.7m (12 ft.)	15.25 ea.
92175H Crevice tool/brush*	12.95 ea.
92175K Rubber gooseneck* ..	15.25 ea.
92175E Vacuum bags/filter for 92175D, 10 per box	39.99 ea.

*for HP PM VAC 92175V or 92175D

The HP Standard CAD Corner—ideal for graphics monitors

This workstation is perfect for you and your jumbo graphics monitor.

It offers an expansive desktop that's shaped expressly to accommodate an oversized monitor. Sturdy die-cast metal legs support up to 200 pounds—more than adequate for your monitor, drawings, graphics tablet and more.

Like the *Design Plus* CAD Corner, this CAD Corner features a keyboard drawer to further free up your desktop space, and rear cable management.

The clean design incorporates a dove gray laminated wood table top and sturdy metal legs, wonderfully coordinated with your HP Standard furniture. Exterior dimensions are 736 H x 1143 W x 1143 D mm (29.0 H x 45.0 W x 45.0 D in.).

92210U CAD Standard Corner Workstation (1-2 units) \$569.00 ea.
(3+) 539.00 ea.

We also now have 29 in. high tables to complement your 29.0 in. high standard furniture.

92211J Compact Workstation Table, 736 H x 1220 W x 762 D mm (29.0 H x 48.0 W x 30.0 D in.) \$320.00 ea.

92211K Standard Workstation Table, 736 H x 1524 W x 762 D mm (29.0 H x 60.0 W x 30.0 D in.) \$380.00 ea.

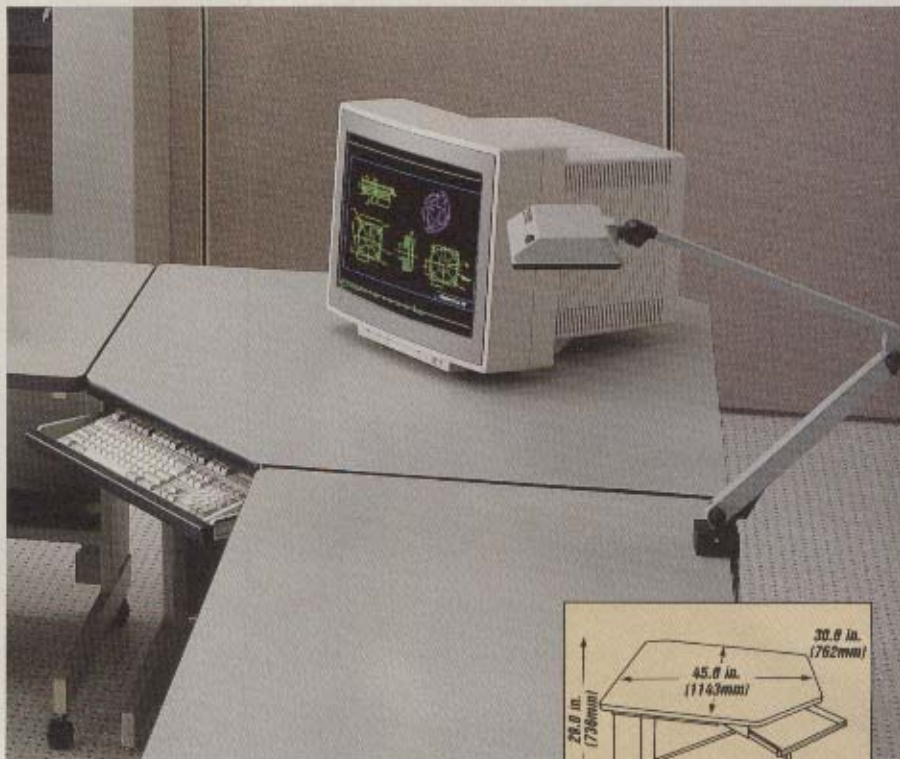

For more information about our affordable HP Standard furniture, see page 104.

Slide this Euro-style lamp into your *Design Plus* desktop. Unique louvers focus cool light on your work—not in your eyes

From Germany, where designers mastered the science of comfort, comes a desk lamp unlike any you've ever used.

Raise, lower, pivot or swivel it into position. It gives you all the light you need to read and work comfortably, even in low-light areas. But what makes it superior is what it won't do.

It won't glare into your eyes, or onto your screen. Unlike a bare-bulb lamp, ours has a unique silver-coated grid that reflects and directs the soft light just where you want it.

It won't make you sweat. Two 9-watt fluorescent bulbs provide as much light as an 80-watt incandescent bulb. Yet they use 77 percent less energy, and stay perfectly cool.

And it won't waste a millimeter of your desktop space. Slip it into the opening on your *Design Plus* tabletop. Or attach it to our optional clamp.



Optional lamp clamp provides support for surfaces up to 127mm (5 in.) deep.



Try the *Design Plus* DeskLamp and you'll agree—it makes all other lamps seem glaringly obsolete! Dimensions: 152 H x 305 W x 610 D mm (6 H x 12 W x 24 D in.). Bulb life: approximately 5 years.

922130 *Design Plus* DeskLamp (1-2 units) \$280.00 ea.
(3-9) 260.00 ea.
(10+) 240.00 ea.
92213R Lamp clamp \$28.00 ea.



At last, a truly ergonomic deskLamp! Bulbs stay cool, louvers keep light out of your eyes...and it wastes zero desktop space!

Solidify your system with our clever bracket kit

Your *Design Plus* components fit more perfectly than ever with our Bracket Kit. Use it to lock your tables, mini-racks and cabinets into one integral system, able to withstand jolts without budging. Each kit contains two steel brackets, screws and complete installation instructions.

92211U Bracket Kit (1-2 units) \$40.00 ea.
(3-9) 37.00 ea.
(10-99) 34.00 ea.

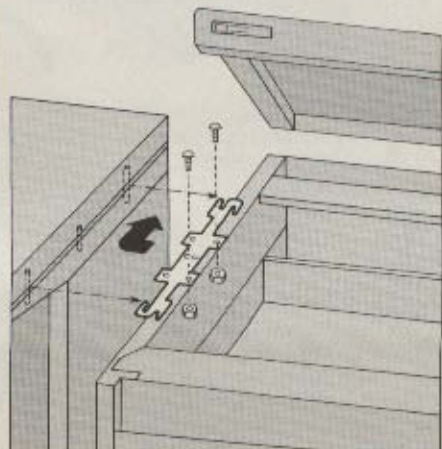

Large CAD Workstation takes on the tools of your trade

Here's optimal space for computer-aided design.

Expect more room: It offers a full 33 percent more desktop space than our 92213B CAD Mini-Workstation. What's more, there's a 36-inch deep worksurface you can pull out of its front, to extend that space even further.

Look for convenience, too. Slide your keyboard away in the workstation's drawer when it's not in use, or into perfect position when it's needed. Your graphics monitor is up and viewable on a raised platform. Reinforced openings hold your 92213D Drawing Holder or 92213Q Desk Lamp securely. Your power cords and cables are guided neatly along the rear.

It's as attractive as it is sturdy, boasting a glare-free surface with natural real wood accents, die-cast metal legs and adjustable leveling glides. Exterior dimensions are 720 H x 1500 W x 711 D mm (28.4 H x 59.0 W x 28.0 D in.).

92213F Design Plus CAD Workstation
 (1-2 units) \$849.00 ea.
 (3+) 799.00 ea.

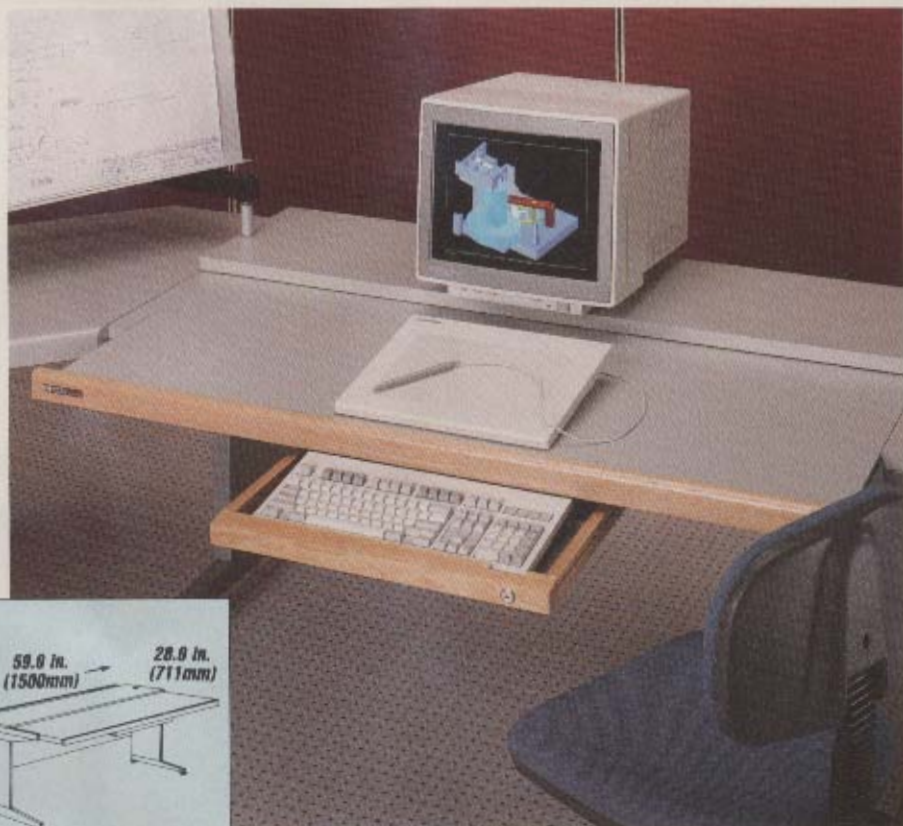
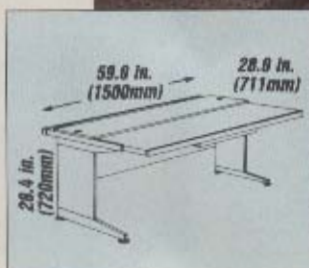

Design Plus CAD Corner handles jumbo monitors

If you use a large graphics monitor, this workstation's for you.

Designed expressly to accommodate an oversized monitor, the CAD Corner offers the same amount of desktop space as the 92213B CAD Mini-workstation (page 103). Its die-cast metal legs support as much as 200 pounds—more than adequate for a graphics monitor and other computer peripherals.

Designed for a perfect fit between *Design Plus* components, this workstation features a convenient keyboard drawer, and cable management to keep your work area safe and neat. Exterior dimensions are 720 H x 1125 W x 1125 D mm (28.4 H x 44.3 W x 44.3 D in.).

92214K Design Plus CAD Corner Workstation
 (1-2 units) \$849.00 ea.
 (3+) 799.00 ea.

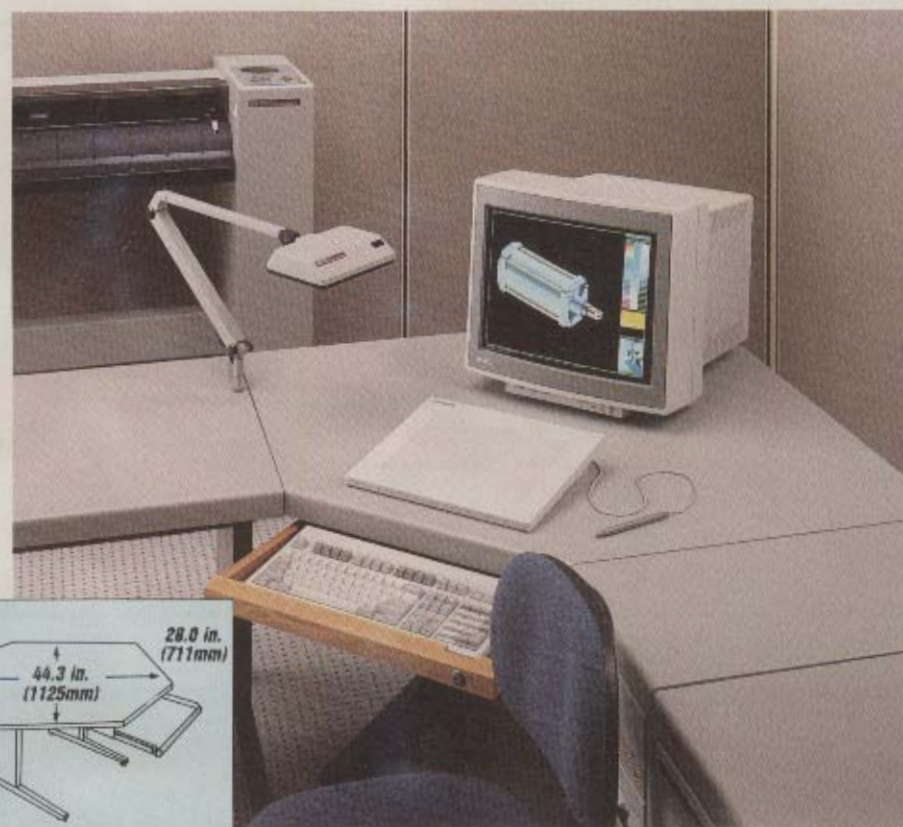
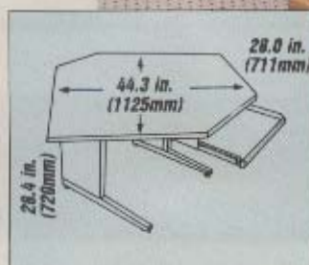

For more information about our top-quality Design Plus furniture, see page 99.

From paper to toner, stick with HP Electrostatic Plotter supplies for top-quality CAD system plots

There's more to a quality plot than 406-dots-per-inch resolution. The behind-the-scenes heroes are HP certified supplies.

Media

We carefully monitor all aspects of our media including: the smoothness of the surface and uniformity of paper coatings. Plus, we package them in single rolls and seal the ends with plastic caps to protect the edges.

Toner and Clear Dispersant

Our special blend of carbon pigments and resins produces clear, sharp, smudge-resistant plots. And because this toner is compatible with all HP 7600 Series media, you don't have to replace it every time you change media. And our clear dispersant flushes your toner system thoroughly which helps your output look its best plot after plot.

Maintenance Supplies

Our writing head cleaner evaporates quickly and leaves no residue. And our low-abrasion writing head polish won't scratch the writing head surface. Just slip on our cleaning gloves, grab our lint-free cleaning wipes and you're ready to go!

The preferred paper

Electrostatic Plotter Paper

Description	Roll size	Product number	Price
Report grade This economical opaque paper is perfect for everyday use. Ideal for line drawings, check plots or working copy with good line quality.	609mm (24 in.)	17265R	(1-10) \$46.00 ea. (11-30) 40.00 ea. (31-60) 36.30 ea. (61+) 33.60 ea.
	914mm (36 in.)	17266R	(1-10) 68.00 ea. (11-30) 61.90 ea. (31-60) 56.40 ea. (61+) 53.00 ea.
	609mm (24 in.)	17275P	(1-10) 70.00 ea. (11-30) 66.50 ea. (31-60) 64.40 ea. (61+) 63.00 ea.
	914mm (36 in.)	17276P	(1-10) 99.00 ea. (11-20) 94.10 ea. (21-40) 91.10 ea. (41+) 89.10 ea.
Vellum Final drawings, overlays, archival drawings and diazo reproductions never looked as good as they do on this rich, durable stock.	609mm (24 in.)	17269V	(1-10) 213.00 ea. (11-30) 202.40 ea. (31-60) 197.00 ea. (61+) 191.70 ea.
	914mm (36 in.)	17270V	(1-10) 320.00 ea. (11-20) 304.00 ea. (21-40) 296.00 ea. (41+) 288.00 ea.

Trim plots neatly

The ideal media cutter to take you through the thick and thin of trimming plotter paper, complete with a metal handle and retractable blade.

17291C Media Cutter

(1-4)	\$8.00 ea.
(5+)	7.00 ea.

Try our toner

Optimize the performance of the HP 7600 Series electrostatic plotters with this special blend of toner that's pre-mixed in spill-resistant bottles.

17278T Toner, 5 liter (1.3 gal.) bottle

(1-5)	\$39.00 ea.
(6-19)	37.00 ea.
(20+)	35.10 ea.

HELPFUL IDEA!

How much toner do you need?

These easy-to-use tables are excellent guidelines to help you order the right quantity of toner. Remember to always keep a few spare bottles of toner on hand as backup.

Rolls of paper/ Bottles of toner

Model 240D	Model 240E
1/1	1/1
2/1	2/1
3/1	3/2
4/2	4/2
5/2	5/3
6/2	6/3
7/3	7/4
8/3	8/4
9/3	9/5
10/4	10/6
15/5	15/8
20/7	20/11
25/8	25/13



HELPFUL IDEA!



How to clean and polish your writing head

Failure to polish and clean your writing head on a regular basis can result in poor image quality and damage to your writing head. Here are some easy cleaning instructions that make maintenance a snap!

• Cleaning the writing head

Use HP's lint-free wipes and rub gently back and forth across the length of the head. If dust, toner or other foreign matter are stuck to the surface, use HP head cleaner.

• Polishing the writing head

Apply HP's head polish to a lint-free cloth and polish the length of the writing head as if you were sanding it. When the polish is absorbed, use a new clean wipe to catch any leftover residue.

Now maintenance is no longer a chore!

We've taken the drudgery out of maintaining your equipment. Supplies like clear dispersant, writing head cleaner, writing head polish, cleaning wipes and cleaning gloves make upkeep a snap!



Writing Head Cleaner



Cleaning Wipes



Cleaning Gloves



Clear Dispersant



Writing Head Polish

172790 Clear Dispersant	
5 liter (1.3 gal) bottle	
(1-5)	\$60.00 ea.
(6-19)	57.00 ea.
(20+)	54.00 ea.

92193F Writing Head Cleaner	
253ml (8 oz.) can	
(1-4)	\$16.00 ea.
(5+)	14.00 ea.

17290P Writing Head Polish	
253ml (8 oz.) can	
(1-4)	\$10.00 ea.
(5+)	8.00 ea.

92193W Cleaning Wipes	
One bag of 100	
(1-4)	\$12.00 ea.
(5+)	10.00 ea.

92193G Cleaning Gloves	
25 pairs per bag	
(1-4)	\$29.00 ea.
(5+)	25.00 ea.

Simplify complex scientific problems

Whether you're a scientist or engineer, or studying to become one, you can expect unparalleled performance from an HP-22S or HP-32S Scientific Calculator.

The HP-22S helps students spend study time mastering coursework instead of their calculator. There's no programming to learn, cryptic keycodes to decipher or complex formulas to rearrange.

The formulas you need most are already programmed in: Ideal Gas Law, kinetic energy, roots of a quadratic equation and more. A library of 16 equations—66 variables in all!—makes easy

work of the calculations your courses require. No need to rearrange or re-enter equations to solve for different variables!

Use the HP-22S to uncomplicate statistics, linear regression, hyperbolics, unit and base conversions and polar/rectangular coordinate conversion. Its display is easy to read, with messages and prompts spelled out in English for easy identification and editing.

HP-22S Scientific Calculator . . . \$59.95 ea.

Professionals use the HP-32S to transform raw data into meaningful results. It's built around the Reverse-Polish Notation (RPN) entry system, so you calculate without entering parentheses, or making extra keystrokes.

Prompts, menu labels and short messages help you every step of the way, and single-key macros simplify repetitive problems. Play out "what if" situations by setting your equation to zero, then solve for any variable—when the situation changes, simply enter the new values for your variables.

The HP-32S also features two-variable statistics with linear regression. Arithmetic can be performed in decimal, hexadecimal, octal or binary.

HP-32S Scientific Calculator . . . \$69.95 ea.

Science and engineering professionals will appreciate the HP-32S calculator's RPN entry system, while students will love the algebraic HP-22S.



PRINTERS



The HP LaserJet...the world's best selling laser printer is now better than ever with the introduction of the LaserJet Series II. It's lower in price yet has added features—like expandable memory for desktop publishing applications.

LaserJet supplies & accessories	15
Laser printer vacuum	27
Mobile LaserJet Cabinet	27
Laser page printer supplies	28
Peripheral-sharing devices	29
HP PaintJet supplies	30
HP DeskJet supplies	32
ThinkJet/QuietJet Series Printers	35
ThinkJet/QuietJet Series supplies	36
HP 2603A Daisywheel Printer & supplies	41
Impact printer supplies & accessories	42
Thermal printer paper	47

Depend on HP toner cartridges for consistently great print, every time!

HP cartridges hold more than just a fresh supply of toner. When you install a fresh HP toner cartridge, you're equipping your HP LaserJet Printer with an entirely new imaging system. That system is designed to produce *consistently* crisp, well-defined text and graphics—no blurs, no imperfections! And the system is guaranteed to last as long as the original supply of toner.

HP toner cartridges refresh your printing with vital new imaging components:

- **Cleaner blade** prepares drum to pick up toner. A used one can let the drum carry imperfections to your page, or leave you with a dingy gray background.
- **Toner reservoir.** If it's filled improperly, you'll get spotty printouts and a very messy printer. And if it's filled with poor quality toner, that toner may cause extra wear to parts of your printer.
- **Photosensitive drum** transfers toner from toner reservoir to page. Worn drums result in blurred characters, dark lines and scratches.
- **Primary corona** enables the drum to carry print to the page. A worn corona can result in irregular printing, or a blurred, spotted, black or blank page—and a voided HP Service Contract.



We use only rich, high-quality toner, and we use the *same* quality of toner every time. So you can count on your page 999 looking as snappy as your page 9. And every cartridge provides at least 3,000 pages* of excellent print, backed by a 90-day, money-back guarantee.

The bottom line? Highly legible text. Well-defined graphics. Unshadowed backgrounds. *Every* time you print.

You may pay a fraction more in the short term, but you could save hundreds of dollars in out-of-pocket printer repairs. And the difference in output? Priceless!

92295A Toner (EP) cartridge for LaserJet Series II family of printers, black print.	
(1 unit)	\$125.00 ea.
(2-7)	114.00 ea.
(8-63)	109.00 ea.
(64+)	98.00 ea.

92285A Toner (EP) cartridge for LaserJet, LaserJet PLUS and LaserJet 500 PLUS Printers, black print.	
(1 unit)	\$125.00 ea.
(2-7)	114.00 ea.
(8-35)	109.00 ea.
(36+)	98.00 ea.
922856 Toner (EP) cartridge for LaserJet, LaserJet PLUS and LaserJet 500 PLUS Printers, brown print.	
(1 unit)	\$149.00 ea.
(2-7)	142.00 ea.
(8+)	135.00 ea.

*Based on double-spaced text with 19mm (.75 in.) margins.

Perk up your printing with HP fonts.

Want to add punch to your documents? Turn to HP fonts! Our fonts add impact to everything you print on your HP LaserJet Printer. You get sharp, bold titles that grab immediate attention...crisp, descriptive text that invites readers to read... professional-looking documents that let the world know you have something important to say! As for using HP fonts, just follow these three steps: Pick the cartridge font that best tells your story. Prompt your LaserJet Printer. And Print!

Find your font on the following pages.

We offer a broad selection of font cartridges, covering applications ranging from word processing and spreadsheets to specialized form and bar-code label-

making. You'll find fonts grouped by application type on the following pages. And you can learn more about one of those cartridges below.

Add zip to your print with Z.

Pique reader interest with our Z cartridge. This near-typeset quality font is perfect for sales letters, proposals, users' manuals and other documents that help you make a great impression.

The Z cartridge offers a selection of proportionally-spaced fonts, with TmsRmn and Helv typefaces in four different sizes. It's designed to run under Microsoft® Windows, and works beautifully with WordPerfect®, MS Word®,

MultiMate®, WordStar 2000® and many other applications. The Z cartridge even includes the international symbol sets needed for non-English languages. And this cartridge gives you great-looking documents on the original HP LaserJet Printer and the LaserJet Series II Printer. Want a sample? See the output below. Want to know more about the Z cartridge? See page 19.

92286Z Microsoft® 1A \$330.00 ea.

Make your message absolutely clear with bold, medium or italic type in 10- or 12-point, TmsRmn or Helv.

Highlight titles and major points with 14-pt bold TmsRmn and Helv.

Print subordinate text or footnotes legibly in 8-point medium TmsRmn or Helv.

Produce international characters and symbols that speak the reader's language.



South Seas Shipping Company 6 Embarcadero Center,

Greg Thompson
South Seas Shipping Company
31-41 Joseph Street
Blackburn, Victoria 3130
Melbourne, Australia

Dear Greg,

So you were impressed with my sales report. I'd be glad to
with our LaserJet Series II printers! The quality is so g
fast, we convinced the boss to order two n

The real beauty of these printers is the imp ve output yo
fonts. We chose the Z font cartridge because s got TmsR
medium, bold, and italic in a variety of sizes

Remember those little footnotes in the sales report Z cartridge do

The Z cartridge even gives us international symbols so I can print the "ö" in
Böeblingen, Germany properly, and can even the yen (¥) and other

Choosing fonts? As easy as 1, 2, 3.

1 Familiarize yourself with these industry-standard definitions.

Font: a complete set of letters, numbers and symbols for a specific typeface that is of the same size, treatment, pitch and orientation. Example: 10-pt. TmsRmn medium, proportionally spaced, portrait orientation.

Typeface: a complete set of letters, numbers and symbols of a particular design, such as TmsRmn.

Treatment: the emphasis placed on a typeface, such as bold stroke.

Point size: the height of the characters, such as those running down this page.

Pitch: the number of characters printed per horizontal inch. For example, fixed-pitch fonts (like typewriter type) are great for aligning columns of data, while proportionally spaced fonts print wonderfully readable text and headings.

Orientation: the direction of the print on the page. Portrait fonts print across the width of the page, while landscape fonts print along the length of the page.

Symbol set: the specific alphabetic, numeric, punctuation and special symbols contained in a font. While the ASCII symbol set satisfies most printing needs, HP also offers fonts with special symbol sets for legal, math and bar code characters, and for symbols used in many non-English languages.

Compatibility: a font's ability to work with the built-in features of a particular software application. Check your software manual, or with your software manufacturer.

2 Consider the following factors.

- What **typeface** would most complement your message, and appeal to your readers?
- Which **treatments** and sizes would be most effective for the message?
- Would **portrait or landscape** orientation present your message best?
- Does your document require special **symbol sets** for non-English languages or mathematics?
- Are the fonts you've selected **compatible** with your software application?

3 Look for fonts in the HP group that best handle your task.

- Typewriter fonts (fixed pitch)
- Publication fonts (proportionally spaced)
- Professional fonts (include special symbol sets)
- Forms design fonts (include special symbol sets)
- Soft fonts (on floppy discs)

Ee
10 point
Ee
14 point
Ee
18 point
Ee
24 point
Ee
30 point
Ee
36 point
Ee
48 point

Typewriter Fonts

Courier



The S1 cartridge is specially designed to complement the Courier fonts already built into the LaserJet Series II printer (10-pitch Courier in medium and bold). It includes a smaller, 12-pitch Courier font which allows more text to be printed on a page (especially useful for European A4-size pages). The PC-8 symbol sets make the S1 cartridge a perfect partner for IBM and IBM-compatible PCs.

Courier Document 1
92290S1
\$250.00 ea.

Portrait & Landscape	Pitch	Point
Symbol sets: Roman-8, PC-8, PC-8 D/N and ECMA-94 Latin 1		
Courier medium	12	10
Courier bold	12	10
Courier italic	12	10
Courier italic	10	12

Note: This cartridge is not compatible with the LaserJet, LaserJet PLUS or LaserJet 500 PLUS printers.



The Y cartridge contains Courier fonts specifically designed for word processing with the IBM PC and compatibles. The PC Set 1 and PC Extension symbol sets are included so that IBM PC display-screen fonts match the LaserJet, LaserJet PLUS and LaserJet 500 PLUS printer fonts. The symbol sets also contain line drawing symbols for creating lines and boxes in documents.

PC Courier 1
92286Y
\$250.00 ea.

Portrait	Pitch	Point
Symbol sets: PC Set 1 and PC Ext.		
Courier medium	10	12
Courier bold	10	12
Courier italic	10	12
Portrait & Landscape	Pitch	Point

Symbol sets: PC Set 1 and PC Ext.		
Line Printer	16.66	8.5



The C cartridge provides many characters and symbols needed in languages besides American English. It also complements the internal Courier font in the original LaserJet, LaserJet PLUS and LaserJet 500 PLUS printers (10-pitch Courier medium) by adding 10-pitch Courier bold and italic.

International
92286C
\$150.00 ea.

Symbol sets: ASCII, Roman-8, Roman Ext., French, German, United Kingdom, Danish/Norwegian, Swedish/Finnish, Spanish and Italian

(same as Y cartridge above except for symbol sets of characters)



The L cartridge complements the internal Courier font in the original LaserJet, LaserJet PLUS and LaserJet 500 PLUS printers (10-pitch Courier medium). The L cartridge fonts are in both portrait and landscape orientations.

Courier P&L
92286L
\$250.00 ea.

Portrait & Landscape	Pitch	Point
Symbol set: Roman-8		
Courier bold	10	12
Courier italic	10	12
Line Printer	16.66	8.5



The A cartridge is similar to the L cartridge above except it offers the Courier fonts in portrait only and Line Printer in landscape orientation only.

Courier 1
92286A
\$150.00 ea.

(same as L cartridge above except for orientation options)



The Q cartridge also complements the Courier fonts already built into the original LaserJet, LaserJet PLUS and LaserJet 500 PLUS printers. In addition, it offers Letter Gothic fonts as another choice for word processing.

Memo 1
92286Q
\$250.00 ea.

Portrait & Landscape	Pitch	Point
Symbol set: Roman-8		
Courier bold	10	12
Courier italic	10	12
Portrait	Pitch	Point
Symbol set: Roman-8		
Letter Gothic medium	12	12
Letter Gothic bold	12	12

Letter Gothic



The N cartridge contains Letter Gothic fonts, which are useful for both word processing and lists or columns of data. It offers the fonts in both portrait and landscape orientations, and contains many symbols needed in languages besides American English.

Letter Gothic P&L
92286N
\$250.00 ea.

Portrait & Landscape	Pitch	Point
Symbol set: Roman-8		
Letter Gothic medium	12	12
Letter Gothic bold	12	12
Letter Gothic italic	12	12



The E cartridge offers the Letter Gothic fonts in portrait orientation only. It includes many symbols needed in languages besides American English.

Letter Gothic
92286E
\$150.00 ea.

Portrait	Pitch	Point
Symbol sets: ASCII, Roman-8 and Roman Ext.		
Letter Gothic medium	12	12
Letter Gothic bold	12	12
Letter Gothic italic	12	12

Prestige Elite



The M cartridge contains Prestige Elite fonts which are easy to read and often used for memos, reports, proposals and other types of documents. The smaller size of Prestige Elite characters allows more text to fit on a page than 10-pitch Courier fonts. The M cartridge fonts can be printed in both portrait and landscape orientations.

Prestige Elite P&L
92286M
\$250.00 ea.

Portrait & Landscape	Pitch	Point
Symbol set: Roman-8		
Prestige Elite medium	12	10
Prestige Elite bold	12	10
Prestige Elite italic	12	10



The D cartridge offers Prestige Elite fonts in portrait orientation only. It includes many symbols needed in languages besides American English.

Prestige Elite
92286D
\$150.00 ea.

Portrait	Pitch	Point
Symbol sets: ASCII, Roman-8 and Roman Ext.		
Prestige Elite medium	12	10
Prestige Elite bold	12	10
Prestige Elite italic	12	10

Publication Fonts

TmsRmn/Helv



With 18 fonts, the Z cartridge offers the broadest selection of any LaserJet font cartridge. It works well with most major word processing software programs and all LaserJet printer models, and is specially designed to work in the Microsoft® Windows environment. The Line Printer font is perfect for printing spreadsheets or tables.

Microsoft®
1A
92286Z
\$330.00 ea.

Portrait	Pitch	Point
Symbol sets: ASCII, Roman-8 and ECMA-94 Latin 1		
TmsRmn medium	prop.	8, 10, 12
TmsRmn bold	prop.	10, 12, 14
<i>TmsRmn italic</i>	prop.	10, 12
Helv medium	prop.	8, 10, 12
Helv bold	prop.	10, 12, 14
<i>Helv italic</i>	prop.	10, 12
Portrait & Landscape	Pitch	Point
Symbol sets: ASCII, Roman-8 and ECMA-94 Latin 1		
Line Printer	16.66	8.5



The S2 cartridge is specifically designed to provide proportional fonts for the LaserJet Series II and LaserJet 2000 printers. It features the PC-8 symbol set which makes page design easier by ensuring the symbols printed on output from a LaserJet printer are the same as shown on an IBM PC display screen.

TmsRmn/
Helv
Report 1
92290S2
\$250.00 ea.

Portrait	Pitch	Point
Symbol sets: Roman-8, PC-8 D/N and ECMA-94 Latin 1		
TmsRmn medium	prop.	8
TmsRmn medium	prop.	12
TmsRmn bold	prop.	12
<i>TmsRmn italic</i>	prop.	12
Helv bold	prop.	14

Note: This cartridge is not compatible with the LaserJet, LaserJet PLUS or LaserJet 500 PLUS printers



The P cartridge features the TmsRmn fonts in both portrait and landscape orientation. The landscape orientation is useful for applications requiring a highly readable font printed along the length of a page.

TmsRmn
P&L
92286P
\$250.00 ea.

Portrait & Landscape	Pitch	Point
Symbol set: Roman-8		
TmsRmn medium	prop.	10
TmsRmn bold	prop.	10
<i>TmsRmn italic</i>	prop.	10



The ASCII symbol set found on the B cartridge is sufficient for most American English-language printing.

TmsRmn
Proportional 1
92286B
\$250.00 ea.

Portrait	Pitch	Point
Symbol set: ASCII		
TmsRmn medium	prop.	8
TmsRmn medium	prop.	10
TmsRmn bold	prop.	10
<i>TmsRmn italic</i>	prop.	10
Helv bold	prop.	14.4
Landscape	Pitch	Point
Symbol set: ASCII		
Line Printer	16.66	8.5



The F cartridge provides proportional fonts in portrait orientation only. It also includes many symbols needed in languages besides American English.

TmsRmn 2
92286F
\$250.00 ea.

Portrait	Pitch	Point
Symbol sets: ASCII, Roman-8 and Roman Ext.		
TmsRmn medium	prop.	8
TmsRmn medium	prop.	10
TmsRmn bold	prop.	10
<i>TmsRmn italic</i>	prop.	10
Helv bold	prop.	14.4
Line Printer	16.66	8.5

Forms Design Fonts

Bar Codes and Labels



The Bar Code 3-of-9 fonts on the W1 cartridge are useful for bar-coding labels, tickets and forms. The Letter Gothic fonts can then be used to print text on your document, and the Line Draw font will produce lines and boxes. It also includes an OCR-A font for applications requiring optical character recognition capability.*

Bar Code
**3-of-9/
OCR-A**
92286W1
\$250.00 ea.

Portrait	Pitch	Point
Symbol sets: ASCII, Roman-8 and Roman Ext.		
Letter Gothic medium	16.66	9.5
Letter Gothic med.	10	14
Symbol set: OCR-A		
OCR-A medium	10	12
Symbol set: Code 39		
Bar Code 3-of-9 medium	4.6	12
Bar Code 3-of-9 medium	8.1	12
Symbol set: Line Draw		
Line Draw medium	10	12



The EAN/UPC fonts are useful for bar-coding labels, tickets and forms for a variety of uses. The X cartridge also includes Letter Gothic and Line Draw fonts, as well as many characters used in languages besides American English. It offers an OCR-B font for applications requiring optical character recognition capability.*

EAN/UPC/
OCR-B
92286X
\$250.00 ea.

Portrait	Pitch	Point
Symbol sets: ASCII, Roman-8 and Roman Ext.		
Letter Gothic medium	16.66	9.5
Letter Gothic med.	10	14
Symbol sets: OCR-B and OCR-B Ext.		
OCR-B medium	10	12
Symbol set: EAN/UPC		
EAN/UPC (10 mil) medium	prop.	12
EAN/UPC (13 mil) bold	prop.	12
Symbol set: Line Draw		
Line Draw medium	10	12

*Note: Extensive testing has been conducted on these bar codes, however HP cannot warrant that the bar codes and OCR-A characters are readable with all bar code or OCR-A reading devices.

Forms



The U cartridge is designed for creating forms in a portrait (vertical) orientation. It features easy-to-read Helv Bold fonts for headings, and smaller Helv fonts for fine type. The fixed-pitch Letter Gothic font is useful for lining up columns of words or numbers. Many characters for languages besides American English are included.

Forms Portrait 92286U
\$250.00 ea.

Portrait	Pitch	Point
Symbol sets: Roman-8 and Roman Ext.		
Helv medium	prop.	6, 8
Helv bold	prop.	10, 12, 14
Letter Gothic medium	16.66	9.5
Symbol set: Line Draw		
Line Draw medium	10	12



The V cartridge is designed for printing forms in a landscape (horizontal) orientation. Similar to U cartridge above.

Forms Landscape 92286V
\$250.00 ea.

Landscape	Pitch	Point
Symbol sets: Roman-8 and Roman Ext.		
Helv medium	prop.	6, 8
Helv bold	prop.	10, 12, 14
Letter Gothic medium	16.66	9.5
Symbol set: Line Draw		
Line Draw medium	10	12

Professional Fonts

Tax & Legal



The T cartridge is designed for printing tax forms with tax form software. It offers Helv Bold fonts for titles and emphasized text, and small-sized Helv fonts that fit in smaller areas of the forms. The Tax Line-Draw font lets you create the lines, boxes and shading specific to tax forms.

Tax 1 92286T
\$250.00 ea.

Portrait	Pitch	Point
Symbol set: ASCII (does not include ~ symbols)		
Helv medium	prop.	6, 8
Helv bold	prop.	8, 10, 12, 14
Tax Line-Draw symbol set		
Tax Line-Draw bold	10	12



Like the G cartridge, the H cartridge is designed for legal word processing with special symbols such as copyrights and trademarks. It offers 10-pitch Courier fonts for correspondence, legal briefs and court documents, and a 16.66-pitch Prestige Elite font for the fine print in your documents. It includes Line Draw for creating lines and boxes.

Legal Courier 92286H
\$150.00 ea.

Portrait	Pitch	Point
Symbol sets: ASCII and Legal		
Courier medium	10	12
Courier bold	10	12
<i>Courier italic</i>	10	12
Symbol set: Line Draw		
Line Draw medium	10	12
Portrait & Landscape	Pitch	Point
Symbol sets: ASCII and Legal		
Prestige Elite medium	16.66	7



Legal Elite 92286G
\$150.00 ea.

The G cartridge is designed for legal word processing with the very legible Prestige Elite fonts. The 12-pitch Prestige Elite fonts allow more text to fit on a page than 10-pitch Courier fonts, and the 16.66-pitch Prestige Elite is great for footnotes, superscripts, subscripts and spreadsheets. The Line Draw font helps you create lines and boxes for charts and tables.

Portrait	Pitch	Point
Symbol sets: ASCII and Legal		
Prestige Elite medium	12	10
Prestige Elite bold	12	10
<i>Prestige Elite italic</i>	12	10
Symbol set: Line Draw		
Line Draw medium	12	12
Portrait & Landscape	Pitch	Point
Symbol sets: ASCII and Legal		
Prestige Elite medium	16.66	7

Math



Math Elite 92286J
\$250.00 ea.

The J cartridge features special mathematic and scientific symbols used in technical word processing. The fixed-pitch Prestige Elite fonts are useful for aligning columns of numbers, and the 16.66-pitch size is perfect for footnotes and references. The J cartridge includes many symbols needed in languages besides American English.

Portrait	Pitch	Point
Symbol sets: ASCII, Roman-8 and Roman Ext.		
Prestige Elite med.	16.66, 12	7, 10
Prestige Elite bold	12	10
<i>Prestige Elite italic</i>	12	10
Symbol sets: Math8, Math8a and Math8b		
Prestige Elite med.	16.66, 12	7, 10
Symbol sets: Math7, Pi Font and Pi Fonta		
Prestige Elite medium	12	10



Math TmsRmn 92286K
\$250.00 ea.

The K cartridge features scientific and mathematic symbols used in technical word processing. The proportionally spaced TmsRmn fonts are attractive and easy to read, even in long stretches of body copy. An 8-point TmsRmn font is included for footnotes or smaller text, and many international characters are included for languages besides American English.

Portrait	Pitch	Point
Symbol sets: ASCII, Roman-8 and Roman Ext.		
TmsRmn medium	prop.	8, 10
TmsRmn bold	prop.	10
<i>TmsRmn italic</i>	prop.	10
Symbol sets: Math8, Math8a and Math8b		
TmsRmn medium	prop.	8, 10
Symbol sets: Math7, Pi Font and Pi Fonta		
TmsRmn medium	prop.	10

Professional Fonts continued next page

Professional fonts continued

Presentation



The R cartridge includes 6 fonts for creating presentations. The Presentation and Letter Gothic typefaces let you communicate clearly on overhead transparencies, and the Line Draw fonts let you create lines and boxes to highlight information. With the Legal symbol set, you can print symbols such as copyrights and trademarks.

Presentations 1
92286R
\$330.00 ea.

Portrait & Landscape	Pitch	Point
Symbol sets: ASCII and Legal		
PRESENTATION BOLD	10, 8.1, 6.5	14, 16, 18
Letter Gothic med.	10	14
Symbol set: PC Line		
PC Line medium	10	14
Symbol set: Line Draw		
Line Draw medium	10	14

Soft Fonts

LaserJet soft fonts (software) offer you a larger selection of typefaces and sizes than cartridge fonts. Fonts can be downloaded from your PC to your HP LaserJet PLUS, LaserJet 500 PLUS, LaserJet Series II or LaserJet 2000 printer. Soft fonts also provide you with eye-catching headline typefaces for newsletters and sales literature.

Typewriter Soft Fonts



Presentation/Letter Gothic
33412DA 5.25 in. disc
33411DA HP 150 disc
\$200.00 ea.

The DA soft font offers a great selection of fixed-pitch fonts in both portrait and landscape orientations. The Presentation fonts are perfect for creating overhead transparencies and agendas, and include the legal symbol set.

The Letter Gothic fonts include math symbol sets for creating math and engineering formulas, and contain many characters used in languages besides American English.

The line drawing fonts are useful for creating lines and boxes on forms or reports. The line drawing font sizes match the Letter Gothic and Presentations sizes so they're convenient to use together. The PC Line symbol set is included so that IBM PC display-screen fonts match the LaserJet printer fonts.

Portrait & Landscape	Treatment	Pitch	Point
Symbol sets: ASCII and Legal			
PRESENTATION	Bold	10, 8.1, 6.5, 5.7, 4.6	14, 16, 18, 24, 30
Symbol sets: ASCII, Roman-8, Roman Ext. and Legal			
Letter Gothic	Medium	16.66, 12, 10	9.5, 12, 14
Letter Gothic	Bold	12	12
Letter Gothic	Italic	12	12
Symbol set: Math8			
Letter Gothic	Medium	16.66, 12	9.5, 12
Symbol sets: Math7 and Pi Font			
Letter Gothic	Medium	12	12
Symbol set: Line Draw			
Line Draw	Medium	12, 16.66, 10, 8.1, 6.5	9.5, 12, 14, 16, 18
Symbol set: PC Line			
PC Line	Medium	16.66, 12	9.5, 12
PC Line	Bold	12, 10, 8.1, 6.5	12, 14, 16, 18



Presentations/Letter Gothic
33412DC 5.25 in. disc
33413DC 3.5 in. PS/2 disc
\$200.00 ea.

The DC soft font product is packaged in a condensed format, which increases the number of point sizes available in the Presentations font. You can now create presentations and agendas in 36 and 48 point type, in addition to the point sizes offered in the DA soft font.

The Letter Gothic fonts include math symbol sets for creating math and engineering formulas, and contain many characters used in languages besides American English.

Portrait & Landscape	Treatment	Pitch	Point
Symbol sets: ASCII, Roman-8, ECMA-94 Latin 1 and Legal			
PRESENTATION	Bold	10, 8.1, 6.5, 5.7, 4.6	14, 16, 18, 24, 30, 36, 48
Symbol sets: ASCII, Roman-8, Roman Ext, ECMA-94 Latin 1, PC-8, PC-8 D-N, PC-860, PC-863, PC-865 and Legal			
Letter Gothic	Medium	16.66, 12, 10	9.5, 12, 14
Letter Gothic	Bold	12	12
Letter Gothic	Italic	12	12
Symbol set: Math8			
Letter Gothic	Medium	16.66, 12	9.5, 12
Symbol sets: Math7 and Pi Font			
Letter Gothic	Medium	12	12
Symbol set: Line Draw			
Line Draw	Medium	12, 16.66, 10, 8.1, 6.5	9.5, 12, 14, 16, 18



Prestige Elite Family
33412EA 5.25 in. disc
33411EA HP 150 disc
\$200.00 ea.

The EA soft font features fixed-pitch Prestige Elite fonts with special symbols needed in legal, math and engineering professions, as well as many characters needed in languages besides American English. A line drawing font is provided for creating lines and boxes. The PC Line symbol set is included so IBM PC display-screen fonts match LaserJet printer fonts.

Portrait & Landscape	Treatment	Pitch	Point
Symbol sets: ASCII, Roman-8, Roman Ext. and Legal			
Prestige Elite	Medium	16.66	7
Prestige Elite	Medium, Bold, Italic	12	10
Symbol set: Math8			
Prestige Elite	Medium	16.66, 12	7, 10
Symbol sets: Math7 and Pi Font			
Prestige Elite	Medium	12	10
Symbol sets: Line Draw and PC Line			
Line Draw	Medium	12	12

Cartridge vs. soft fonts...
which to choose?

The LaserJet PLUS, LaserJet 500 PLUS, LaserJet Series II and LaserJet 2000 Printers can use both soft (downloadable) and hard (cartridge) fonts. In determining which type of font to purchase, consider the following:

Cartridge fonts—

- No downloading time: Because the cartridge font is plugged into the printer, you don't have to wait while the font is downloading to the printer's memory.
- No computer or printer memory is required. The cartridge font has all the memory needed to store the font data.

Soft fonts—

- More versatility in the combinations of fonts you can use.
- With no hardware involved, soft fonts generally cost less.
- Can be stored on your hard disc for convenient access.

Publication Soft Fonts



TmsRmn/Helv
33412AC ASCII, 5.25 in. disc
33411AC ASCII, HP 150 disc
33412AD Roman-8, 5.25 in. disc
33411AD Roman-8, HP 150 disc
 \$200.00 ea.

The AC and AD soft fonts feature the highly legible TmsRmn and Helv typefaces in a wide variety of sizes. These attractive fonts are perfect for sales letters, proposals, manuals or any other important document. The AD fonts provide additional characters in the Roman-8 symbol set which are used in many languages besides American English.

Portrait & Landscape	Treatment	Pitch	Point
TmsRmn	Medium, Bold, Italic	prop.	6, 8, 10, 12, 14
TmsRmn	Bold only	prop.	18, 24, 30
Helv	Medium, Bold, Italic	prop.	6, 8, 10, 12, 14
Helv	Bold only	prop.	18, 24, 30



TmsRmn/Helv
33412AE ASCII, 5.25 in. disc
33411AE ASCII, HP 150 disc
33412AF Roman-8, 5.25 in. disc
33411AF Roman-8, HP 150 disc
 \$200.00 ea.

The AE and AF soft fonts offer the easy-to-read TmsRmn and Helv typefaces in additional sizes and treatments to complement the AC and AD soft fonts. AF fonts provide characters in the Roman-8 symbol set which are used in many languages besides American English.

Portrait & Landscape	Treatment	Pitch	Point
TmsRmn	Medium, Bold, Italic	prop.	7, 9, 11
TmsRmn	Medium, Italic	prop.	18, 24, 30
Helv	Medium, Bold, Italic	prop.	7, 9, 11
Helv	Medium, Italic	prop.	18, 24, 30



ITC Garamond® Bitstream® Soft Fonts
33412RA ASCII, 5.25 in. disc
33412RB Roman-8, 5.25 in. disc
 \$200.00 ea.

The RA and RB soft font from Bitstream Inc. provide the ITC Garamond typeface in 11 point sizes. This graceful and readable typeface is appropriate for almost any use, including long blocks of copy. It is often chosen to add a touch of elegance to a document.

Portrait	Treatment	Pitch	Point
ITC Garamond	Medium, Bold, Italic	prop.	6, 7, 8, 9, 10, 11, 12, 14, 18, 24, 30



Century Schoolbook® Bitstream® Soft Fonts
33412SA ASCII, 5.25 in. disc
33412SB Roman-8, 5.25 in. disc
 \$200.00 ea.

The SA and SB Bitstream soft fonts feature the superbly readable Century Schoolbook typeface, originally designed to help children learn to read. A sturdy, discernible typeface, it will facilitate long stretches of reading with little fatigue. It is excellent for a number of uses, from signs to full-length books.

Portrait	Treatment	Pitch	Point
Century Schoolbook	Medium, Bold, Italic	prop.	6, 7, 8, 9, 10, 11, 12, 14, 18, 24, 30



Zapf Humanist 601™ Bitstream® Soft Fonts
33412TA ASCII, 5.25 in. disc
33412TB Roman-8, 5.25 in. disc
 \$200.00 ea.

The sleek, modern-looking Zapf Humanist 601 typeface in these Bitstream soft fonts produces crisp, friendly text. It is well-suited for manuals, magazines and technical matter, and mixes well with many serif typefaces (serifs are the short cross lines on the tops and bottoms of the letters in some typefaces, such as TmsRmn and Century Schoolbook).

Portrait	Treatment	Pitch	Point
Zapf Humanist 601	Medium, Bold, Italic	prop.	6, 7, 8, 9, 10, 11, 12, 14, 18, 24, 30

Headline Soft Fonts



Helv Headlines
33412AG 5.25 in. disc
 \$200.00 ea.

The variations of the Helv typeface found in the AG soft font each include a large selection of characters used in many languages besides American English. The PC-8 and PC-850 symbol sets also provide display-screen compatibility for IBM PCs. Choose the font that makes your headlines, logos and key messages leap off the page, in up to 48-point sizes (approximately 1/2-inch high).

Portrait & Landscape	Treatment	Pitch	Point
Symbol sets: ASCII, Roman-8, Legat, ECMA-94 Latin 1, PC-8, PC-8 D/N, PC-850, French, German, United Kingdom, Swedish, Norwegian, Spanish and Italian			
Helv	Black Outline	prop.	14, 18, 24, 30, 36, 48
Helv	Black Condensed	prop.	14, 18, 24, 30, 36, 48
Helv	Black Condensed Italic	prop.	14, 18, 24, 30, 36, 48
Serifa*	Black	prop.	14, 18, 24, 30, 36, 48

Note: The 36- and 48-point sizes, and PC-8, PC-8 D/N and PC-850 symbol sets are not compatible with the LaserJet, LaserJet PLUS and LaserJet 500 PLUS printers.



Headline Typefaces 1™ Bitstream® Soft Fonts
33412UA ASCII, 5.25 in. disc
33412UB Roman-8, 5.25 in. disc
 \$200.00 ea.

The five headline typefaces offered on the UA and UB Bitstream soft fonts let you design your newsletters or sales literature with a tone that reflects your message. Bauer Bodoni Black is clear, clean and commanding; Broadway is an aggressive, modern typeface; Cooper Black is a super-black typeface that will always be noticed; Coronet is a more informal typeface that's full, free and flowing; and University Roman is a popular poster face, sprightly and unique.

Portrait	Treatment	Pitch	Point
Bauer Bodoni Black*	—	prop.	14, 18, 24, 30
Ercadway*	—	prop.	14, 18, 24, 30
Cooper Black*	—	prop.	14, 18, 24, 30
Coronet	—	prop.	14, 18, 24, 30
University Roman	—	prop.	14, 18, 24, 30



Get crisp 'plots' quickly with LaserPlotter software

Take advantage of a world of plotter-oriented engineering and business-graphics software applications with LaserPlotter™.

This easy-to-use software lets the family of HP LaserJet Printers produce high-resolution plots. How?

By enabling your LaserJet Printer to emulate the HP 7475A, 7470A or ColorPro Plotter.

Works unattended!

Forget babysitting your plotter. LaserPlotter can output graphic

after graphic while you're at work, or out to lunch or coffee. And LaserPlotter translates color plotter lines into 72 combinations of line width and grey texture. So your "color" graphics will photocopy into black and white.

What's more, LaserPlotter employs a unique data compression routine that lets you print faster and get higher-resolution graphics, without upgrading your LaserJet's memory.

Don't wait for a shot at the office plotter when you can get the equivalent of a printer and plotter in a single package! Available for the HP Vectra PC and other IBM PC-compatibles. Supported by Insight Development Corporation.

35188A LaserPlotter software \$150.00 ea.

Your output will be this clean, this crisp, this descriptive!

Want to get the most out of your HP LaserJet Printer? See our new LaserJet books, page 25.

Treat your LaserJet to extra memory—treat yourself to high-resolution graphics!

Plug a 1, 2 or 4 MByte memory board into your HP LaserJet Series II family printer, and quickly print both full-page 300 x 300 dot-per-inch graphics and multiple softfonts. A must for printing fast, high-resolution charts, presentations and diagrams, or for desktop publishing applications.

1 MByte Memory Board is perfect for the single user who has a dedicated LaserJet and uses only a few standard

sized soft fonts per document or prints presentation-quality graphics.

33443B 1 MByte Memory Board \$495.00 ea.

2 MByte Memory Board is excellent for several users who share a LaserJet or for a sophisticated single user who needs many fonts or forms accessible in memory.

33444B 2 MByte Memory Board \$995.00 ea.

4 MByte Memory Board is great for LaserJet printers shared by several users who need access to a variety of complex forms, detailed graphics or a wider selection of larger point-size fonts.

33445B 4 MByte Memory Board \$1995.00 ea.

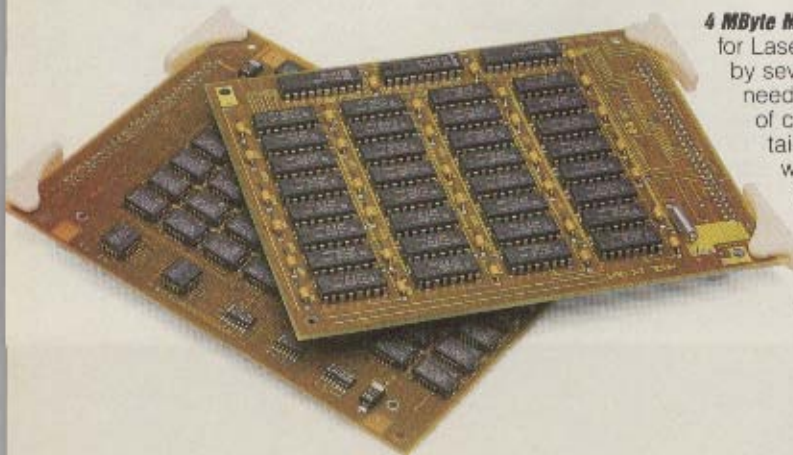

Custom-configure LaserJet printing

Tired of typing those troublesome escape sequences to laser print? PCLPak lets you custom-configure your printing to select fonts, page length, lines-per-page and more. Completely menu-driven.

33406A PCLPak for the HP Touchscreen PC \$79.00 ea.
33406B PCLPak for the HP Vectra PC and IBM PC/AT compatibles 79.00 ea.

Download soft fonts easily

FontLoad lets you download soft fonts to your HP LaserJet PLUS, 500 PLUS, Series II or 2000 printer with a single-word command. Supports the Microsoft® and HP Mouse, and Microsoft Windows; available on 5.25-in. disc. (Supplied free with new HP soft fonts.)

33407B FontLoad \$20.00 ea.

Use JetForm to generate forms from your PC, and kiss that typewriter, correction fluid and carbon paper goodbye!

Are you surrounded by PCs and printers, but still coping with the tedious, error-prone task of typing pre-printed business forms? Let JetForm software automate the process.

JetForm lets you design and fill in your business forms or labels with your HP LaserJet Printer. Simply store your blank forms electronically. Then complete them when needed—directly from your PC!

- With JetForm software, you can:
 - Develop or customize your own forms, on-screen and without the expense of typesetting—you even get shading, logos and bar codes!
 - Eliminate pre-printed form storage by generating forms as you need them, quickly and electronically.
 - Reduce errors and repetition, because you can fill out forms by merging data from Lotus® 1-2-3®, dBase III® or other database files. Or enter data manually on your PC, if you wish.
 - Toss out that messy carbon paper and correction fluid! JetForm lets you cor-

rect errors on your PC. And you can complete as many versions of a form as you need, exactly the way you need them—in less time than ever before!

JetForm software system comes in two parts:

JetForm Design: Contains the electronic forms features you need to develop forms, including form design, HP ScanJet compatibility, screen form fill-in, file merge and a run-time version of MS Windows.

JetForm Print: A subset of JetForm Design with features necessary to fill in forms only. Two versions are available:

- IBM PC/AT version including a run time version of Microsoft® Windows™.
- IBM PC/XT version without MS Windows.

An HP LaserJet Series II family printer is required to use JetForm software.

35188E JetForm Design for HP Vectra PCs and other IBM/AT compatibles \$495.00 ea.



Produce your own forms, then fill in the blanks on the screen or by merging with computer files.

35188G JetForm Print Windows for HP Vectra PCs and other IBM AT/compatibles	
(1 unit)	\$199.00 ea.
(2-4)	180.00 ea.
(5+)	170.00 ea.
35188H JetForm Print for IBM PC/XT and compatibles	
(1 unit)	\$199.00 ea.
(2-4)	180.00 ea.
(5+)	170.00 ea.

Tilt tables! Shrink spreadsheets! Find fonts with LaserControl

LaserControl lets you tilt print orientation from landscape to portrait, make type larger or smaller, and even change margins—without typing complex

escape codes. This easy-to-install software features a pop-up menu to let you access the features of your HP LaserJet or HP DeskJet Printer and fonts, without exiting from the software application you're using. You can:

- Increase the readability of your spreadsheets.
- Print more or fewer lines on a page
- Print from any software via LaserControl's "printer emulation" capability.

LaserControl works with Lotus® 1-2-3®, WordStar®, HP Executive MemoMaker, DisplayWrite® and other popular applications, and is available for the HP Vectra PC and other IBM PC/AT/compatibles. Supported by Insight Development.

35190J LaserControl ... \$150.00 ea.

LaserControl lets you access the many different type styles and sizes of your cartridge fonts, without exiting from your software application!



Give Mac applications LaserJet power!

Want to print those Macintosh graphics you love on your HP LaserJet Printer? Now you can with Printworks!

This printer driver allows your applications to "talk" to your HP LaserJet Printer, so you can take full advantage of its silent high speed and high resolution.

Printworks lets you print the most detailed of graphics, merge those graphics with text, and even vary print resolution—all on the same page.

It's an easy-to-use utility that supports all HP cartridge fonts and runs on the Macintosh 512, 512E. Plus and SE, using Finder 5.3, 5.4 and 5.5 or equivalent. Supported by Softstyle.

35179P Printworks for the Macintosh/Laser version \$145.00 ea.

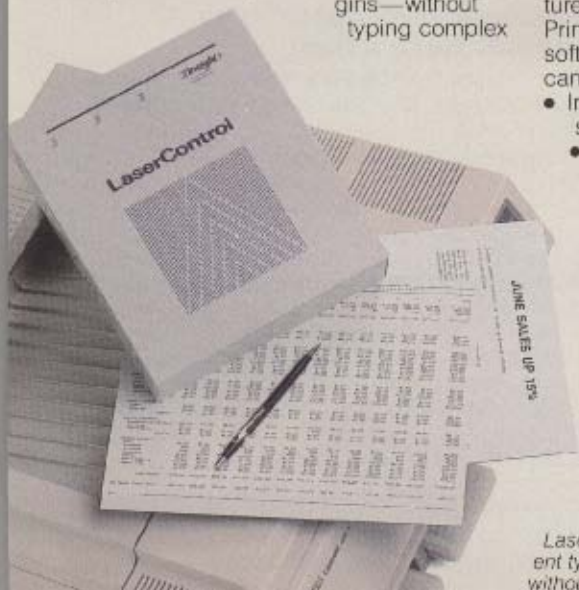

<p>MC 35190J LaserControl 36190 LaserControl Common Fresno, California 94308</p> <p>Dear Mr. Customer:</p> <p>Thank you for your letter.</p>	<p>MC 35190J LaserControl 36190 LaserControl Common Fresno, California 94308</p> <p>Dear Mr. Customer:</p> <p>Thank you for your letter.</p>	<p>MC 35190J LaserControl 36190 LaserControl Common Fresno, California 94308</p> <p>Dear Mr. Customer:</p> <p>Thank you for your letter.</p>	<p>MC 35190J LaserControl 36190 LaserControl Common Fresno, California 94308</p> <p>Dear Mr. Customer:</p> <p>Thank you for your letter.</p>	<p>ANNUAL MEETING PRESENTATION SOUTH SEA SHIPPING & SALES ** AGENDA **</p>
--	--	--	--	--

Get the drudgery out of mailing and labeling with HP LaserJet Labels

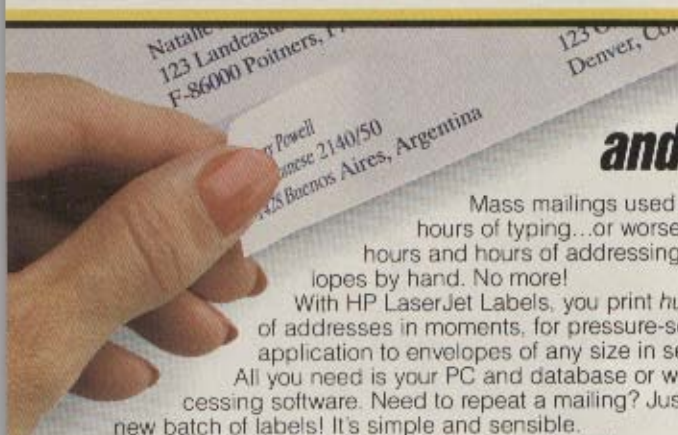

Mass mailings used to mean hours of typing...or worse yet, hours and hours of addressing envelopes by hand. No more!

With HP LaserJet Labels, you print *hundreds* of addresses in moments, for pressure-sensitive application to envelopes of any size in seconds. All you need is your PC and database or word-processing software. Need to repeat a mailing? Just run a new batch of labels! It's simple and sensible.

It's also a great solution for packages, file folders and discs, because our labels are available in a variety of sizes.

Because they're designed expressly for HP LaserJet printers, these labels print crisp and dark, and hold up to shipping and handling without fading. And unlike other labels, ours are made to withstand the high-heat of your LaserJet—there's no danger of glue melting and damaging your printer.

Get HP LaserJet Labels today—and put your time to better use! 100 labels per box.

LaserJet Labels*

Product no.	Height	Width	Number across	Number per page	Border edge?
92285K	1"	2 5/8"	3	33	no
92157K	1"	2 5/8"	3	30	yes
92285L	1 3/8"	2 5/8"	3	24	no
92157N	1 1/2"	2 5/8"	3	21	yes
92157P	2"	4 1/4"	2	10	yes
92285M	2 3/4"	4 1/4"	2	8	no
92285W	8 1/2"	11"	1	1	no

(1 box) \$44.00 ea.
(2-19) 37.50 ea.
(20+) 31.00 ea.

*Each sheet is 8 1/2 x 11 inches.

Note: Labels are designed for automatic feeding into LaserJet Series II Printers only. Please manually feed labels into the back of LaserJet, LaserJet PLUS or LaserJet 500 PLUS Printers to assure continued maintenance support.



Label envelopes, files and packages with speed and efficiency—no more retyping or hand-writing!

Quick overheads from a LaserJet? With our transparency film, you bet!

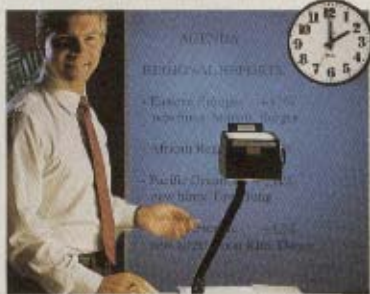

Print your transparencies directly from PC to LaserJet...

...so your concepts are ready for the screen in a matter of moments!

Now you can produce transparencies directly from your PC and HP LaserJet Printer, as easily as typing a memo!

With HP LaserJet Film, words or graphics generated from your word-processing, spreadsheet or graphics applications are ready for overhead projection in seconds. You can even use large-sized LaserJet fonts to create attention-getting text.

This film was designed expressly for the high heat of your LaserJet, so it won't jam, melt or yellow. Why take chances with anything else? Available in 50-sheet boxes.

92285J HP LaserJet Overhead Transparency Film
(1 box) \$32.00 ea.
(2-9) 27.20 ea.
(10-49) 24.00 ea.
(50+) 21.75 ea.

HELPFUL IDEAS!

Produce overheads as quickly as typing a memo! Here's how:

1 Select a font with your desired typestyle and typesize, then plug the cartridge into your LaserJet or download the softfont to your PC.

2 Use your wordprocessor to create text.

3 Specify the font for your output by either embedding a Setup String at the beginning of your document text, or putting a Setup String in your software printer menu.

The Setup String consists of both an *Escape Code* that varies for each software package and can be found in your software manual, and *Control Characters* telling the printer what font to access and the character spacing.

Examples for 18 Point Presentation Font on the **92286R** Cartridge (see pages 17-21 for font cartridges):

Lotus® 1-2-3™ Enter:
\027&113C\027(OU\027(sOp6.5h18V
in Print-Printer-Options-Setup.

Executive Memomaker Enter:
ESC &113C ESC (OU ESC (sOp6.5h18V
in the Printer Setup String on the Print Menu.

Note: Check and adjust margins and line spacing as needed. Use upper and lower case characters as shown. "O" here is a zero; be careful of the difference between one (1) and lower case L (l). To learn more, just check your font documentation and LaserJet Technical Reference Manual.

Print envelopes to match your letters, quickly and easily!

Laser print directly on business or personal-sized envelopes with the HP LaserJet Series II Printer Envelope Tray.

This tray lets you print mailing addresses on envelopes preprinted with logos or addresses. It even lets you print your own logos and return addresses on envelopes, then print mailing addresses. And it works with most popular word processing software applications.

The envelope tray is perfect for moderate-volume mailings, holding a maximum of 15 envelopes sized between 86 x 178mm (3.4 x 7.0 in.) and 188 x 267mm (7.4 x 10.5 in.). This includes standard business (#10) and letter (Monarch) envelopes.



Use this easy-to-use envelope tray with your LaserJet Series IID Printer to print up to 15 envelopes in a jiffy!

92295F HP LaserJet Series IID Printer Envelope Tray

(1-2 units)	\$89.00 ea.
(3-9)	79.00 ea.
(10+)	69.00 ea.

NOTE: Users may find the envelope tray has a slightly higher jam rate than cut-sheet paper trays. We recommend that you test the envelopes you'll be printing before purchasing large quantities.



Organize LaserJet cartridge fonts

They're too valuable to be left out in the open. Stored in our LaserJet font organizer, your cartridge fonts can be easily found when you need them, or locked away in a desk drawer when you don't.

Up to four cartridges can be secured between high-density foam separators in this attractive acrylic box.

92285P Font Organizer

(1 unit)	\$42.95 ea.
(2-9)	38.95 ea.
(10+)	34.95 ea.

Tap into your HP LaserJet printer's type & graphics options—these books tell how!

Unlocking the LaserJet Howard and Janelle Gluckman/WizzyWags Publishing 1988

This book makes easy work of the most difficult spreadsheet. You produce informational business graphics from Lotus® 1-2-3® or Symphony®—even add logos, shadow boxes and vary typesizes within them! ☺

92176E *new!* \$19.95 ea.

Looking Good in Print: A Guide to Basic Design for Desktop Publishing Roger Parker/Ventana Press 1988

Here's a book that offers everything the title implies, and more! It shows you how to integrate type, graphics and photos through your desktop publishing applications, to produce

desktop publishing applications, to produce truly eye-catching newsletters, reports and other documents. ☺

92220W *new!* \$23.95 ea.

LaserJet Unlimited, 2nd edition Ted Nace and Michael Gardner/Peachpit Press 1988

This updated edition offers concise, authoritative information and hands-on advice to most every aspect of laser printing, with special emphasis on the HP LaserJet Series II Printer. It discusses all applications, as well as Printer Command Language and setup utilities. ☺

92235U *new!* \$25.00 ea.

See page 138 for more books.

Protect your printer

Shield your LaserJet Printer from dust and spills with this 100 percent cotton dust cover. It's custom-fitted for a professional look and durable enough to last for years. And because our dust cover is wrinkle-resistant and styled to complement your printer, it can enhance the appearance of your office as well.

922596 Dust cover for only the LaserJet Series II Printer \$30.00 ea.

92259C Dust cover for LaserJet, LaserJet PLUS and LaserJet 500 PLUS Printers ☺ \$30.00 ea.



These books tell how to vary your typesizes and typesizes...

get business graphics from...Lotus® 1-2-3®...

...and get DTP assistance, too!

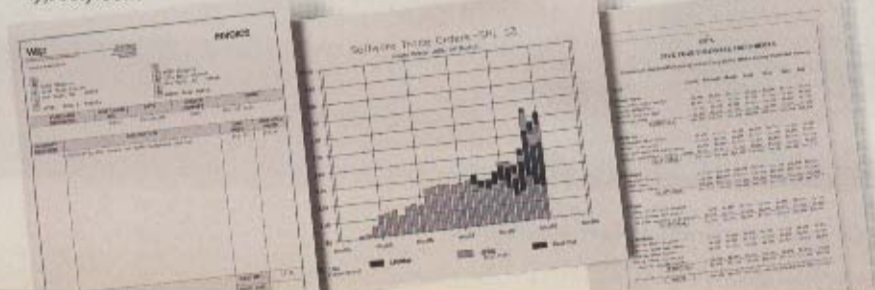

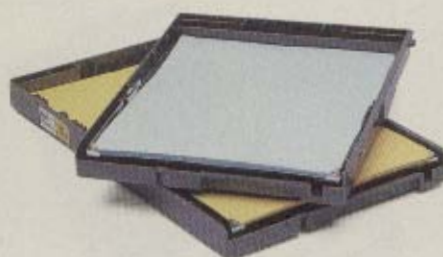

Change printer paper in a snap with replacement paper trays

Paper trays let you switch paper color, size or type in mere moments! Keep extras close by. You'll be able to change from letter to legal, white to goldenrod, as easily as slipping out one tray and sliding in another. Extra trays also lessen unnecessary downtime in the unlikely event that a tray should become damaged. With extra paper trays you'll work more quickly and efficiently.

For HP LaserJet and LaserJet PLUS Printers:

92285B U.S. letter-size paper tray. Holds 100 sheets of 216 x 279mm (8.5 x 11 in.) paper.

(1-2 trays) \$49.00 ea.
 (3-9) 45.00 ea.
 (10+) 40.00 ea.

92285C U.S. legal-size paper tray. Holds 100 sheets of 216 x 356mm (8.5 x 14 in.) paper.

(1-2 trays) \$49.00 ea.
 (3-9) 45.00 ea.
 (10+) 40.00 ea.

92285D Metric A4-size paper tray. Holds 100 sheets of 210 x 297mm (8.3 x 11.7 in.) paper.

(1-2 trays) \$49.00 ea.
 (3-9) 45.00 ea.
 (10+) 40.00 ea.

92285E Metric B5-size paper tray. Holds 100 sheets of 182 x 254mm (7.2 x 10 in.) paper.

(1-2 trays) \$49.00 ea.
 (3-9) 45.00 ea.
 (10+) 40.00 ea.

For LaserJet 580 PLUS Printers:

92287B U.S. letter-size paper tray. Holds 100 sheets of 216 x 279mm (8.5 x 11 in.) paper.

(1-2 trays) \$72.00 ea.
 (3-9) 61.50 ea.
 (10+) 54.00 ea.

92287C U.S. legal-size paper tray. Holds 100 sheets of 216 x 356mm (8.5 x 14 in.) paper.

(1-2 trays) \$72.00 ea.
 (3-9) 61.50 ea.
 (10+) 54.00 ea.

92287D Metric A4-size paper tray. Holds 100 sheets of 210 x 297mm (8.3 x 11.7 in.) paper.

(1-2 trays) \$72.00 ea.
 (3-9) 61.50 ea.
 (10+) 54.00 ea.

92287E Metric B5-size paper tray. Holds 100 sheets of 182 x 254mm (7.2 x 10 in.) paper.

(1-2 trays) \$72.00 ea.
 (3-9) 61.50 ea.
 (10+) 54.00 ea.

For HP LaserJet Series II family of printers:

92295B U.S. letter-size paper tray. Holds 200 sheets of 216 x 279mm (8.5 x 11 in.) paper.

(1-2 trays) \$65.00 ea.
 (3-9) 55.00 ea.
 (10+) 49.00 ea.

92295C U.S. legal-size paper tray. Holds 200 sheets of 216 x 356mm (8.5 x 14 in.) paper.

(1-2 trays) \$69.00 ea.
 (3-9) 59.00 ea.
 (10+) 52.00 ea.

92295D Metric A4-size paper tray. Holds 200 sheets of 210 x 297mm (8.3 x 11.7 in.) paper.

(1-2 trays) \$65.00 ea.
 (3-9) 55.00 ea.
 (10+) 49.00 ea.

92295E Executive-size paper tray. Holds 100 sheets of 184 x 267mm (7.25 x 10.5 in.) paper.

(1-2 trays) \$69.00 ea.
 (3-9) 59.00 ea.
 (10+) 52.00 ea.

HP LaserJet Printer accessories

Product no.	Description	Price
92285F	Forward Collator for the LaserJet and LaserJet PLUS Printers. Holds 200 pages.	\$49.95 ea.
92285Q	Replacement Output Shelf —holds letter size 216 x 279mm (8.5 x 11 in.) paper. For the LaserJet and LaserJet PLUS Printers.	\$ 5.75 ea.
92285R	Replacement Auxiliary Output Shelf Extension for 92285Q shelf. Holds legal size 216 x 356mm (8.5 x 14 in.) paper. For LaserJet and LaserJet PLUS Printers.	\$ 5.50 ea.
92285S	Replacement LaserJet Manual Input Tray for the LaserJet, LaserJet PLUS Printers.	\$ 5.25 ea.
92285T	Service Kit for the LaserJet, LaserJet PLUS and 500 PLUS Printers (contains 2 separator belts, and 2 felt cleaner pads).	\$19.50 ea.
92295R	Replacement Top Cover for 92295B/D/E paper trays for the LaserJet Series II family of printers.	\$19.25 ea.
92295S	Replacement Top Cover for 92295C paper trays for the LaserJet Series II family of printers.	\$19.25 ea.

Attach this forward collator to the output lip of your HP LaserJet or LaserJet PLUS Printer, and up to 200 pages of printing can be neatly stacked in perfect order.



Get more from your HP LaserJet, subscribe to the LaserJet Journal

For updates on new products, and tips and techniques to better use your HP LaserJet Printer, subscribe to the *LaserJet Journal*. Working closely with HP, the *LaserJet Journal* writes articles based on actual customer questions from the HP Printer Hotline. Each bi-monthly issue is filled with articles such as:

- Six rules for using Lotus®
- Updates on the latest HP LaserJet software
- Printing envelopes easily
- HP LaserJet and WordPerfect
- Managing fonts

Yearly subscriptions are \$49 in the U.S., \$79 in Canada and \$99 elsewhere. All payments should be in U.S. funds. Call or write: *LaserJet Journal, Inc.*, 1945 Techny Road, Northbrook, IL 60062, U.S.A. (800) 323-2686 (in IL: 312-498-0920)

Cut clutter, promote productivity with our Mobile LaserJet Printer cabinet.

Here's a single piece of furniture to fill most every laser printing need! This roomy cabinet features a wide drawer for fonts and manuals, with customized slots to keep everything tidy. It has expansive shelves for printer paper, paper trays and toner cartridges. And a shelf slides out from either side for additional workspace. It's a highly functional, attractive stand for the entire HP LaserJet family of printers. In fact, everything you need for months of printing can be right where you need it most!

92211B Mobile LaserJet Printer Cabinet \$585.00 ea.

Comes unassembled

- Handy **slide-out shelf** keeps paper and printing necessities within easy reach.
- A **perfect fit** for all LaserJet Printers—and Design Plus furniture too! Measures 720 H x 600 W x 711 D mm (28.3 H x 23.6 W x 28.0 D in.).



- Drawer has a **customized foam insert** for font cartridges and 3.5-in. soft fonts, and a **movable divider** to keep 5.25-in. soft fonts and manuals well-organized.
- **Two large shelves** let you stock up to three paper trays and several reams of paper on top, and at least two toner cartridges below—supplies for months!
- **Heavy-duty, self-locking casters** give this cabinet mobility when you need to share printing resources, and perfect stability while printing.



Clean up toner & paper dust fast! This improved vacuum is so easy to use, it makes laser printer upkeep a breeze.

Your vacuum comes with: 1) a filter, 2) a 1.8m (6 ft.) stretch hose, 3) a flexible goose neck, 4) a crevice tool with brush, 5) a 3.7m (12 ft.) power cord, 6) a static-draining ground wire with wrist strap—all packed into a light-weight, easy-to-carry case.



Why your office vac isn't enough



Ordinary vacuums allow particles smaller than 70 microns to escape back into the air you breathe.



The HP PM Vacuum filter traps toner particles as fine as .3 microns—much, much smaller than your toner!

This specially designed vacuum makes cleaning your laser printers and copiers so easy, you'll never risk dirty-equipment problems again!

This is no ordinary vacuum! No general-purpose vacuum seeks out, whisks away and—most important—traps tiny toner particles the way this one does. Our vac's hose is "toner-proof," that is, it will not get stiff or sticky from toner, so there's no danger of toner escaping into the atmosphere. And the vacuum itself is smaller, lighter, quieter and 20 percent more powerful than before.

Custom-made for toner pickup The disposable filter traps particles as small as .3

microns (toner measures 5 microns). When it's full, an indicator light tells you so. No guessing, and no messing with bags. An extra-long hose and thoughtful accessories, like the rubber gooseneck that bends around corners, let you reach every nook and cranny without getting a speck of dust on yourself.

A static-draining wire and wrist strap protect your printer's sensitive circuits. And everything packs neatly in a carrying case not much bigger than a lunch box. UL/CSA listed.

92175V HP PM Vacuum
(1 unit) \$249.00 ea.
(2+) 219.00 ea.

Replacement accessories:

92175W Filter for 92175V
(1 unit) \$22.00 ea.
(2-3) 18.00 ea.
(4+) 15.00 ea.
92175F Stretch hose*
1.8m (6 ft.) 26.95 ea.
92175G Power cord*
3.7m (12 ft.) 15.25 ea.
92175H Crevice tool/brush* 12.95 ea.
92175K Rubber gooseneck* 15.25 ea.
92175E Vacuum bags/filter for
92175D, 10 per box 39.99 ea.

*for HP PM VAC 92175V or 92175D.

HELPFUL IDEAS!

What kind of paper should you use with LaserJet Printers?

LaserJet Printers have been designed to work well with most types of paper, although some variables in paper composition may significantly affect print quality and paper handling. Paper manufactured for high quality photocopying yields good results for general purpose applications. For other applications where cotton bond is desirable (i.e., company letterhead), you should test the paper fully before you purchase it in order to ensure desirable performance.

If you are new to choosing paper for your LaserJet Printer, we recommend that you use the specifications below (also listed in your Operator's Reference Manual), when selecting paper.

Standard White Photocopy Paper Specifications

Basic Weight	
LaserJet:	60-90g/m ² (16-21 lbs.)
LaserJet II:	60-150g/m ² (16-35 lbs.)
Thickness 0.086 to 0.107mm (3.4 to 4.2 mils)	
Moisture Content 4 to 6%	
Cutting Dimensions (Accuracy of paper size) ± 0.7mm (.0276 in.)	
Cutting Angle (Accuracy of paper edges) 90 degrees ± 4 (86 to 94 degrees)	
Paper Grain	Long Grain (parallel to length)

We recommend that all paper be tested before it is purchased for your LaserJet Printer. Our office paper, page 43, meets these specifications.

HP LaserJet 2000



Laser printer supplies & accessories

Printer	Description	Product number	Price	
LaserJet 2000	Toner. Box contains two .5 kilogram bags. Will print approx. 14,000 216 x 279mm (8.5 x 11 in.) pages	92282A	(1-4 boxes) \$90.00 ea. (5-12) 80.00 ea. (13-24) 72.00 ea. (25+) 67.50 ea.	
	Standard Extra Paper Cassette Tray. 216 x 279mm (8.5 x 11 in.) Holds 250 sheets, landscape orientation.	92282B	(1-2 trays) \$89.00 ea. (3-9) 80.00 ea. (10+) 70.00 ea.	
	Legal Extra Paper Cassette Tray. 216 x 356mm (8.5 x 14 in.) Holds 250 sheets, portrait orientation.	92282C	(1-2 trays) \$89.00 ea. (3-9) 80.00 ea. (10+) 70.00 ea.	
	Extra Paper Cassette Tray. Metric A4 210 x 297mm (8.3 x 11.7 in.) Holds 250 sheets, landscape orientation.	92282D	(1-2 trays) \$89.00 ea. (3-9) 80.00 ea. (10+) 70.00 ea.	
	Executive Paper Cassette Tray. 184 x 267mm (7.25 x 10.5 in.) Holds 250 sheets, portrait orientation.	92282E	(1-2 trays) \$89.00 ea. (3-9) 80.00 ea. (10+) 70.00 ea.	
	Ledger Paper Cassette Tray. 275 x 432mm (11 x 17 in.) Holds 250 sheets, portrait orientation.	92282F	(1-2 trays) \$89.00 ea. (3-9) 80.00 ea. (10+) 70.00 ea.	
	Extra Paper Cassette Tray. Metric A3 297 x 420mm (11.7 x 16.5 in.) Holds 250 sheets, portrait orientation.	92282G	(1-2 trays) \$89.00 ea. (3-9) 80.00 ea. (10+) 70.00 ea.	
	Toner Disposal Boxes. Package of four.	92282P	\$26.00 pkg.	
	Plug-in Cartridge Font Organizer. Stores up to 4 fonts in sturdy acrylic box. Hinged lid keeps out dust (see page 25).	92285P	(1 unit) \$42.95 ea. (2-9) 38.95 ea. (10+) 34.95 ea.	
	2680A/ 2685A/ 2689A Laser Printer	Paper. Continuous feed. 18 lbs. (69-gm/sq meter), 305 x 216mm (12 x 8.5 in.), 3600 sheets/box, 45 boxes/pallet. Available in pallet quantities only.	92184A	(1-2 pallets) ... \$1290.00 ea. (3+) 1240.00 ea.
		Toner. 12-one kilogram bags per box. 3000,000 to 400,000 pages per box. For HP 2680 and 2689A.	92180A	(1-2 boxes) \$405.00 ea. (3-10) 380.00 ea. (11-19) 365.00 ea. (20+) 355.00 ea.
		Drum Kit. Includes new cleaner blade.	92180D	\$230.00 ea.
		Disposal Containers. Box of 6 for spent toner collection.	92181A	(1-2 boxes) \$78.00 ea. (3-5) 70.00 ea. (6+) 66.00 ea.
Carrier. Box of 24 bottles. (Product sold by weight, not volume.)		92182A	(1-3 boxes) \$74.00 ea. (4-9) 70.00 ea. (10+) 68.00 ea.	
Developer. Box of 6 bottles. Use 1 bottle per drum replacement.		92182D	215.00 ea.	
Splicing Tape. Box of 6 rolls.		92183A	\$72.00 ea.	
2687A/ 2688A Desktop Laser Page Printer		Toner. Box of 6 bottles plus one empty collection bottle. For HP 2687A and 2688A.	92185A	(1 box) \$78.00 ea. (2-5) 72.00 ea. (6+) 68.00 ea.
		Cleaning Pads. Box of 3. 60,000 cleanings per box	92185B	(1 box) \$72.00 ea. (2-5) 65.00 ea. (6+) 61.00 ea.
		Ozone Filters. Box of 3.	92185D	(1 box) \$53.00 ea. (2-5) 48.00 ea. (6+) 44.00 ea.
		OPC Belts. Box of 3.	92185E	(1 box) \$220.00 ea. (2-5) 210.00 ea. (6+) 200.00 ea.
		Input Tray. 210 x 297mm or 8.5 x 11 in. Holds 250 sheets.	92185T	\$87.00 ea.

HP 2680A Laser Printer



2688A Desktop Laser Page Printer



Protect RS-232 peripherals while you share them! Now our ABC switches have surge protection!

Because of their unique surge suppression capabilities, our ABC switches are the only products of their kind approved and supported for use with HP LaserJet printers. Now you can switch freely between printers, plotters and modems without the risk of sending damaging surges and spikes to your peripherals.

ABC switches also offer one of the lowest priced sharing solutions. With just the turn of a switch each user can access any peripheral from their own workstation.

What you need to know about cabling For each peripheral and/or PC you connect to the single ABC switch, order one **17355M** cable.

The dual ABC switch is supplied with two **92205U** Y cables. If you want to use the dual ABC switch to connect a third peripheral to two PCs, order an additional **92205U** Y cable. At most, three cables would be required for any configuration.



Allows three PCs to share one peripheral!



Allows three PCs to share two peripherals!



This ABC switch lets three PCs share the same printer or plotter. Or can be configured to allow one PC to access three peripherals, such as printer, plotter and modem.

92205E ABC Switch with built-in surge protection
(1 unit) \$189.00 ea.
(2-4) 177.00 ea.
(5+) 165.00 ea.



This switch lets three PCs share two peripherals, or allows two PCs to share up to three peripherals. Also, it can be used as two separate ABC switches. Includes two **92205U** Y cables.

92205F Dual ABC switch with built-in surge protection.
(1 unit) \$369.00 ea.
(2-4) 332.00 ea.
(5+) 295.00 ea.

Specifications

Size: 76.2 H x 177.8 W x 254 D mm
(3.0 H x 7.0 W x 10.0 D in.)

Weight: 0.8Kg (2 lbs.)

Enclosure: ABS plastic

Clamping voltage: + or - 25V

Line capacitance: RS-232 signal

Regulatory approvals: FCC Part 15,
Subsection J,
Class B compliant

Characteristics:

- 4 female DB-25 connectors (92205E),
8 female DB-25 connectors (92205F)
- Pins 2-8, 20 and 22 protected (other pins not passed through)
- Pin 1s are tied common—chassis ground
- Pin 7s are tied common—signal ground

HELPFUL IDEA!

Valuable information about surge protection

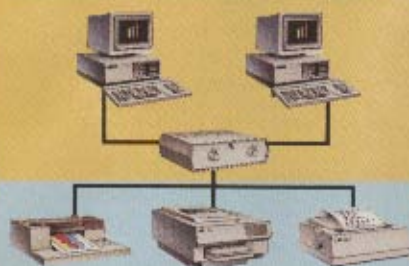

Additional surge protectors at your peripherals eliminate the risk of port damage.

Our ABC switches prevent surges from entering the datacomm lines and being passed on to your peripheral. However, spikes and surges can enter between the switchbox and the peripheral, causing the delicate interface circuitry to slowly deteriorate.

For maximum surge and spike protection of equipment with sensitive RS-232 data ports, invest in the **92165R** surge protector (page 158). It's inexpensive insurance against surge-induced equipment failure.

HP-IB ABC switch will enable you and two co-workers to share an HP-IB printer or plotter, or several HP-IB printers and plotters. No more plugging or unplugging cords. No more waiting. With one turn of the dial, each of you can have access to one, two, three or more peripherals.* Installation is easy. Depending on whether three PCs or terminals will be hooked up to the switch and the peripherals, you need one or more additional HP-IB cables (10833A/B/C.)

92205Y HP-IB ABC switch .. \$259.00 ea.
10833A 1m HP-IB cable 80.00 ea.
10833B 2m HP-IB cable 90.00 ea.
10833C 4m HP-IB cable 100.00 ea.

*For use with printers and plotters only. When connecting several peripherals, make sure the total length (in meters) of all the HP-IB cables is no greater than twice the number of devices being connected.

Three users—one peripheral

Three users—three peripherals

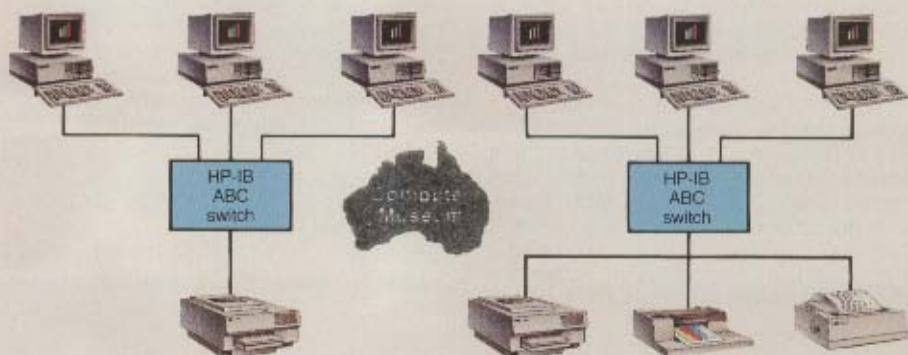

Graphics come alive! PaintJet paper, transparency film and print cartridges make the difference

Brilliant colors. Sharp images. And letters so crisp and sharp your text seems to spring from the page! Graphics like these are possible thanks to the way HP specifically designed PaintJet papers, transparency film and print cartridges to work together.

HP PaintJet Paper has a unique surface coating specifically formulated to match the ink in PaintJet print cartridges. The results? Instant ink drying and crisp, dark letters that won't smudge or smear.

And since HP PaintJet Paper is vacuumed to make it virtually dust-free, there's no floating paper dust to clog print cartridges and cause printing problems. If other papers are used, printing quality and printhead maintenance will vary.



HP PaintJet paper



Plain paper

You can see the difference! Notice how the smooth surface of the HP PaintJet Paper minimizes bleeding and intensifies color. And, since lines won't run, you achieve the fine detail you need on graphs and complex engineering drawings. Plain paper can be used but may produce "draft quality" output.

HP PaintJet Transparency Film has been designed with a special surface coating that controls dot spread. Just print out a graph and watch the color deepen and develop before your eyes.

Plastic sleeves, provided with the film, are specifically designed to protect your transparencies and control film color development. Printed transparencies can be inserted into the sleeves and projected after just 5 minutes. The sleeved transparency will achieve its maximum color intensity after one-to-two hours.

NOTE: HP PaintJet Film is the only film recommended for use with the HP PaintJet Printer.

HP PaintJet supplies

Description	Product number	Price
Z-Fold PaintJet Paper , 8.5 x 11 in. (216 x 279 mm) finished size. 250 sheets per pack.	51630P	(1-3 packs) \$18.95 ea. (4-7) 16.95 ea. (8-63) 14.95 ea.
Z-Fold PaintJet Paper , Metric A4 (210 x 297 mm) finished size. 250 sheets per pack.	51630R	Available in Europe Only
Cut Sheet PaintJet Paper , 8.5 x 11 in. (216 x 279 mm). 250 sheets per pack.	51630Y	\$22.95 ea.
Cut Sheet PaintJet Paper , Metric A4 (210 x 297 mm) size. 250 sheets per pack.	51630Z	Available in Europe Only
PaintJet Transparency Film , 8.5 x 11 in. (216 x 279 mm) finished size. 50 sheet box includes 50 plastic sleeves. Required film for PaintJet Printer.	51630Q	(1-4 boxes) \$64.95 ea. (5-9) 58.95 ea. (10+) 54.95 ea.
PaintJet Transparency Film , Metric A4 (210 x 297 mm) size. 50 sheet box includes 50 plastic sleeves. Required film for PaintJet printer.	51630S	Available in Europe Only
PaintJet Black Print Cartridge	51606A	\$27.95 ea.
PaintJet Color Print Cartridge	51606C	\$34.95 ea.

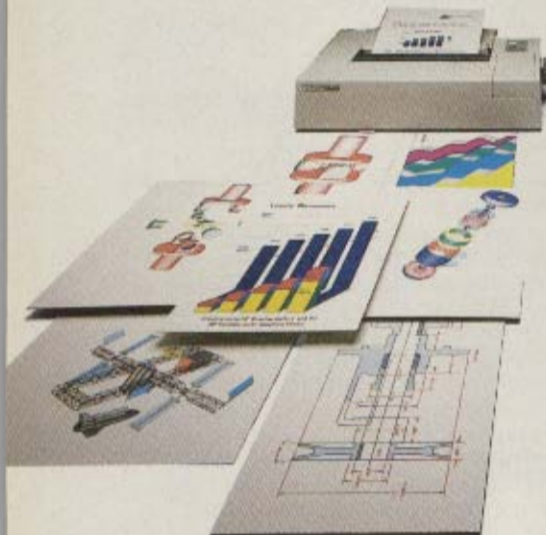

Like magic! Create a full palette of color with just two print cartridges

Snap in a color print cartridge and a black print cartridge and the HP PaintJet Printer is ready to splash all the colors of the rainbow on paper or transparency film.

Specially formulated inks in black, yellow, cyan and magenta, contained in just two print cartridges, provide many shades of brilliant color depending upon software, and a deep, true black. These rich gradations of color make possible professional-looking reports, overhead transparencies and technical images like the 3-D mechanical drawings shown at the right.*

The long-lasting black ink cartridge can print approximately 1100 pages of text while the color cartridge can typically print 180 pages of color graphics with solid area fill. Every time you replace a print cartridge you are replacing the ink, the nozzles and even the electrical elements.

51606A Black Print Cartridge \$27.95 ea.
51606C Color Print Cartridge \$34.95 ea.

*Sample plots by VersaCAD™

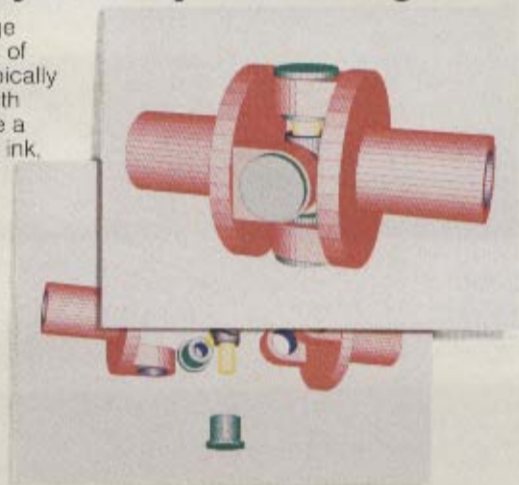

Pair that HP PaintJet with JetPlotter Software, and plot dazzling color graphics



Tap into your HP PaintJet Printer's full graphics potential with JetPlotter™.

This powerful software turns your HP PaintJet into a fully compatible HP plotter. How? By making it HP plotter-

compatible with most business graphics, CAD or scientific software applications.

You'll get dazzling color graphics at your desk, and full text printing from one printer—right at your desk!

Tailor your graphics output. JetPlotter allows you to vary color, line width, texture and even

vary the printer's resolution and speed. And since JetPlotter allows your HP PaintJet to function as both text printer and graphics plotter, you save desktop space, too!

Take a look at these features:

- Lets you produce polished high-resolution output, or quick draft-quality graphics.
- Allows you to inverse, position, shrink and expand output size, and vary background and line color.
- Offers 72 line-width and -texture control settings—great for photocopying color output in black and white.
- Lets you print color or black and white output.
- Makes HP PaintJet compatible with most software that uses HP 7475A, 7470 and ColorPro® Plotters.

This easy-to-use, menu-driven software is available for the HP Vectra PC and other IBM PC-compatibles. Supported by Insight Development Corporation.

35190P JetPlotter Software ... \$99.00 ea.

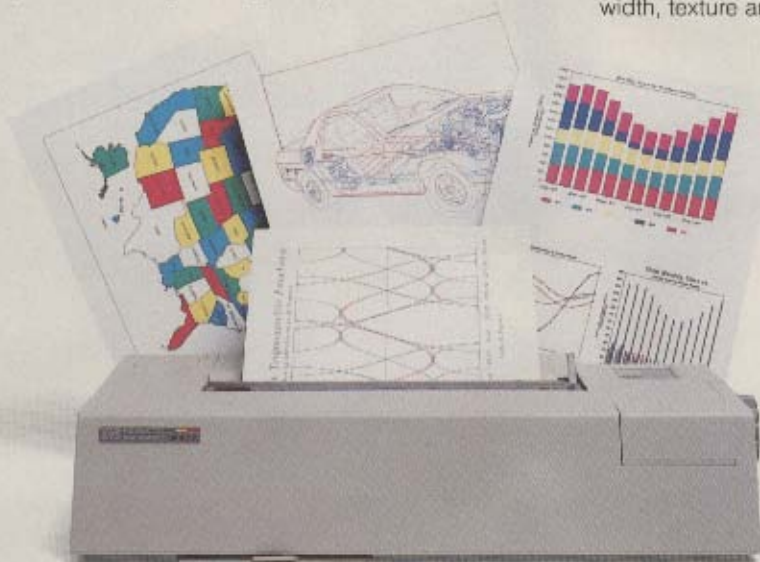

Print your graphics—quicker, quieter and directly from your HP PaintJet.

Reclaim desktop space! Place your HP PaintJet on a stand and suspend a paper catcher

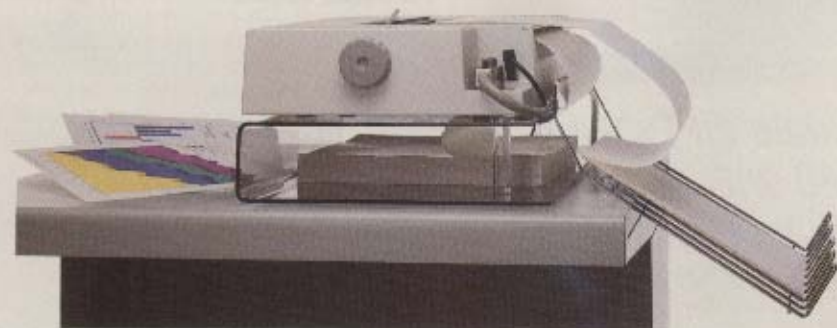

This custom-designed, acrylic stand lets you stack the printer above the paper supply to cut in half the amount of desktop space required.

The curved edge on the rear of the stand serves two purposes: it directs the supply of fanfold paper evenly into the printer and channels cables out of the paper path. Dimensions: 124 H x 467 W x 337 D mm (4.9 H x 18.4 W x 13.25 D in.).

92269A Desktop Printer/Plotter Stand
(1-2) \$79.00 ea.
(3-9) 71.00 ea.
(10+) 64.00 ea.

Add a paper catcher to the back of the PaintJet Desktop Stand and fanfold paper will re-fold and stack neatly as it flows from the printer. The 92261G Paper Catcher works in conjunction with the 92269A PaintJet Desktop Stand and attaches to the curved rear edge of the stand.

92261G Paper Catcher \$28.00 ea.

HP PaintJet Dust Cover provides custom-tailored protection



Black edging and the HP logo add to the trim, professional look of the PaintJet Dust Cover.



Keep your HP PaintJet Printer in tip-top shape by protecting it from dirt, dust and spills. This form-fitting, custom-designed dust cover is tailored to fit the exact dimensions of the HP PaintJet Printer.

It's made of durable, 100% cotton fabric that's water-resistant, yet breathable, so moisture can escape. Even when you fold or roll the dust cover up for storage, it resists wrinkles.

92250Z PaintJet Dust Cover .. \$22.00 ea.

Count on the HP DeskJet Printer for economical, laser-quality output. Count on the DeskJet Printer soft font to make it easy!

This soft font makes it easy to vary the type of your low-cost, letter-quality DeskJet Printer.

With it, you can switch between Times Roman and Helvetica in 8, 10, 12 and 14 point sizes. But you do so directly from your PC, instead of having to change the font cartridge in your printer.

The soft font is available on 5.25-inch disc for use with the HP Vectra PC and the IBM PC, PC/AT, PC/XT and IBM PC compatibles. For more efficient performance, the addition of a 128K byte RAM cartridge is recommended (see 22707A below).

22708A DeskJet Printer softfont \$95.00 ea.

Add memory to your printer.

Our 128K byte RAM cartridge expands your printer's memory to accommodate softfont downloading. Installation is simple—just plug it into your DeskJet Printer.

22707A 128K byte RAM cartridge \$150.00 ea.

For replacement external power modules, see page 39.



Print letter-quality on most any cut-sheet paper

Put this print cartridge in your DeskJet Printer, and get your message to the world on the common office bond or copier paper of your choice.

It produces crisp text and razor-sharp graphics. A single cartridge typically prints 525,000 letter-quality characters, or a million characters in draft mode (based on Courier 12 font, 1500 characters per page). And it's totally self-contained for quick, clean installation.

51608A DeskJet Printer black print cartridge \$18.95 ea.



Emulate an Epson FX-80 with your DeskJet Printer

Enjoy the benefits of Epson-compatible software applications and the DeskJet Printer's economical laser-quality printing!

Just plug this emulation cartridge into either of your DeskJet Printer's cartridge slots. You'll print quietly and efficiently.

22707E HP Epson FX-80 Printer emulation cartridge \$75.00 ea.

Here's protection for your DeskJet Printer

Shield your DeskJet Printer from dust and spills with this 100 percent cotton dust cover. It's custom-fitted for a professional look and durable enough to last for years. And because our dust cover is wrinkle-resistant and styled to complement your printer, it can enhance the appearance of your office as well.

92250R DeskJet Printer dust cover \$35.00 ea.



Don't rummage for your DeskJet supplies! Keep them neat & handy in a drawer tucked under the printer!

Ever watched your productivity grind to a halt as you searched for the supplies you needed to do your job? What a drain! Slip your DeskJet accessories into our acrylic organizer drawer and you'll never waste another minute hunting them down. Using the "hidden" space under your printer, the organizer adds storage room without subtracting workspace!

Custom designed for perfect fit and function.

Created just for your HP DeskJet, the handsome organizer looks like part of your system. The supplies drawer glides silently on teflon runners. Inside, foam cut-outs secure two print cartridges in their sealed containers, four font or memory modules and a full ream of 8.5 x 11 in. or European A4 paper. Legal documents? Just remove the foam spacer from the paper section and your 8.5 x 14 in. paper fits right in! Order your DeskJet Organizer today.

92177Z DeskJet Organizer. Exterior dimensions: 111 H x 445 W x 384 D mm (4.38 H x 17.5 W x 15.13 D in.) \$99.00 ea.

Don't waste your day playing hide-and-seek with printer supplies. Take control with our DeskJet Organizer. You'll get more done with less aggravation. And you'll never run short because you'll see when to reorder.

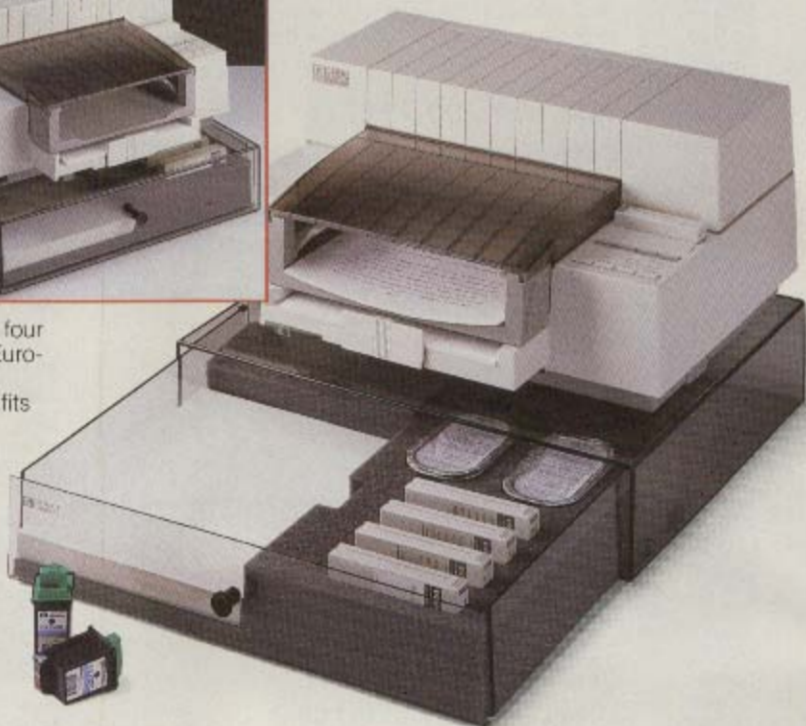
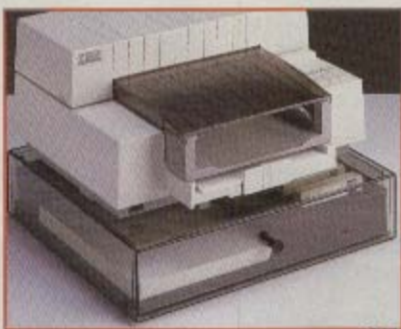

Transform your DeskJet into a super printer with new DeskPlotter Software



DeskPlotter™ Software lets your HP DeskJet emulate a plotter, and by taking advantage of DeskJet's 300 dpi capability, it produces high-resolution black-and-

white graphics.

Produce dramatic graphics that photocopy completely. Choose from 72 different textures and line widths to create dynamic, easy-to-read images. Because DeskPlotter's black-and-white masters copy thoroughly, they're ideal for presentation handouts. This isn't true of copies of color plots since photocopying turns the different colors gray, eliminating the very points you tried to make with color.

You'll also save time because DeskPlotter graphics print up to six times faster than graphics on a plotter. Produce rush drafts in a hurry—the quiet DeskJet outputs page after page without your constant supervision. Plus, you'll never have to wait for your turn on the office plotter again!

You can also use DeskPlotter to produce inverse graphics (like blueprints) and for plotting designs from CAD software, as well as business graphics from packages like Lotus® 1-2-3® and ChartMaster.

35184E DeskPlotter Software for the HP DeskJet Printer ... \$129.00 ea.

DeskPlotter's high-resolution output copies perfectly.

Color plots muddle together when they're photocopied, unlike DeskPlotter's "textured" output.

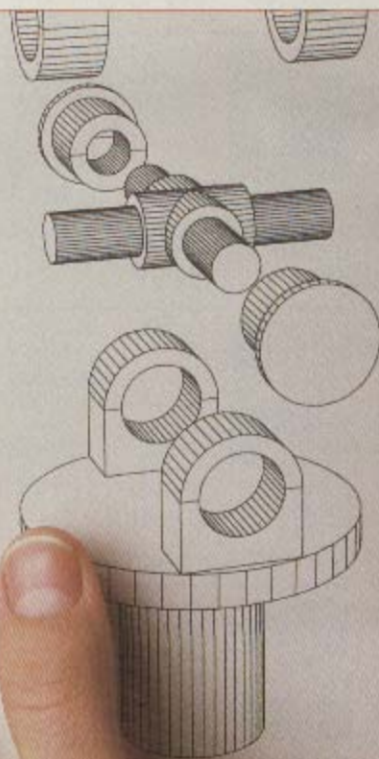

Enjoy the silent, practical power of an HP ThinkJet, QuietJet or QuietJet Plus Printer

HP's ThinkJet, QuietJet and QuietJet Plus Printers let you think, talk and handle other tasks while you print—in draft or near letter-quality, at the office or at home.

All five (including the battery-powered HP 2225P) of our ThinkJet Printers and our QuietJet and QuietJet Plus Printers are built around HP's low-decibel, non-impact ink-jet technology. The heart of this technology is our inexpensive, disposable ink print cartridge that combines innovation and user convenience. You just snap it in, or lift it out—no handling of ribbons, no contact with ink. Simple, clean, efficient!

Choose the HP QuietJet Printer for near letter-quality output

The QuietJet and the QuietJet Plus Printers are engineered to give ultra-quiet performance and high quality printing. The QuietJet is almost the same printer as the QuietJet Plus—it just costs less and takes up less space! The wide-carriage QuietJet Plus Printer is perfect for larger spreadsheets while the narrow-carriage QuietJet Printer accommodates standard size paper. With the QuietJet or QuietJet Plus Printer, you can:

- Get sharp characters when printing quick drafts at 192 cps and near-letter quality (NLQ) for important letters and reports at 48 cps.
- Print graphics in three densities for professional-looking charts and illustrations.
- Change print sizes using six print pitches, and print enhancements to highlight, clarify or get more information on a page.
- Choose NLQ, draft or compressed print with just one keystroke on a convenient key panel.
- Connect to HP, IBM or Apple personal computers. QuietJet and QuietJet Plus Printers come with Centronics and RS-232C interfaces, or an HP-IB interface—a feature normally found in higher-priced printers.

The QuietJet Series printers offer excellent Z-Fold paper handling with a fully adjustable tractor and a paper-advance knob. A friction-feed full platen allows for easier manual sheet-feeding.

QuietJet Printer dimensions: 118 H x 395 W x 214 D mm (4.65 H x 15.5 W x 8.43 D in.).

QuietJet Plus dimensions: 121 H x 527 W x 221 D mm (4.76 H x 20.75 W x 8.7 D in.).

- HP 2228A** QuietJet Printer ... \$599.00 ea.
HP 2227A QuietJet Plus Printer ... \$799.00 ea.
HP 2227B QuietJet Plus Printer with HP-IB interface ... \$799.00 ea.



You can rely on the QuietJet, QuietJet Plus and ThinkJet Printers for fast, quiet and quality performance every time!

Get a ThinkJet Printer for quick, economical drafts

Quick, quiet, and small describe our best-priced ink-jet printer—the ThinkJet. Lightweight and compact, it allows you the convenience of personal printing whenever or wherever you need to print. With the ThinkJet Printer, you can:

- Print a standard letter in less than a minute at a print speed of 150 cps.
- Have graphics printed with the same speed and silence.
- Connect to HP, IBM or Apple personal computers.
- Highlight and vary your output using four print pitches, underlines and bold.
- Have the convenience of using Z-Fold paper.
- Have the freedom of taking your printer anywhere.

ThinkJet dimensions: 89 H x 292 W x 206 D mm (3.5 H x 11.5 W x 8.1 D in.)

We ship your ThinkJet Printer with a print cartridge, a packet of Z-Fold paper, an owner's manual, a warranty card and a supplies brochure!

- HP 2225A** ThinkJet Printer with HP-IB interface and power cord ... \$495.00 ea.
HP 2225B ThinkJet Printer with HP-IL interface, 1m HP-IL cable, battery pack and recharger ... \$495.00 ea.
HP 2225C ThinkJet Printer with Centronics interface and power cord for use with HP and non-HP PCs ... \$495.00 ea.
HP 2225D ThinkJet Printer with RS-232C interface and power cord for use with HP and non-HP PCs ... \$495.00 ea.
HP 2225P ThinkJet Printer with Centronics interface, battery pack and recharger for use with non-HP portables ... \$495.00 ea.
92219Z Centronics cable to connect HP 2225P to IBM PC-compatibles, 1m (3.3 ft.) shielded with 25-pin male/15-pin male connectors ... \$51.00 ea.

To order cables for your ThinkJet or QuietJet Printer, see pages 76 and 77. For power modules, see page 39.

Warranty and post warranty services for HP printers are available from more than 100 HP sales offices in the U.S. Call (800) 835-4747 for more information.

Different colors, plain paper? Yes! with HP Print Cartridges

These cartridges let you print black or three brilliant colors directly from your HP QuietJet Plus, QuietJet or ThinkJet Printer. Each cartridge prints as many as 600,000 characters, or up to 500 pages—sparkle for any presentation or correspondence!

92261A	JetPaper Print Cartridge, black	\$10.95 ea.
51604A	Plain Paper Print Cartridge, black	10.95 ea.
51685B	JetPaper Print Cartridge, blue	12.95 ea.
51605G	JetPaper Print Cartridge, green	12.95 ea.
51605R	JetPaper Print Cartridge, red	12.95 ea.

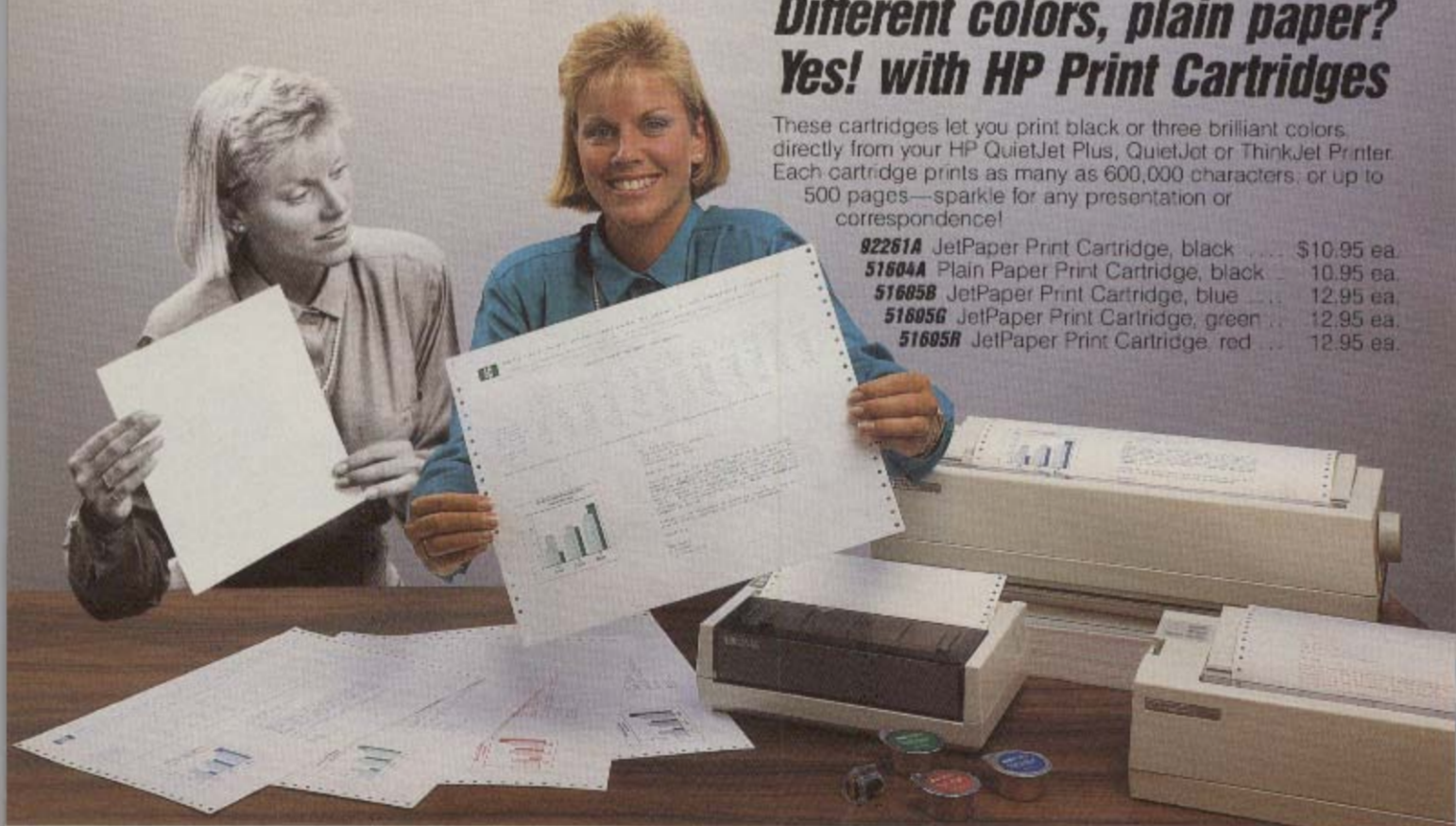

Save 15% with the 5-in-1 ThinkJet Accessory Kit

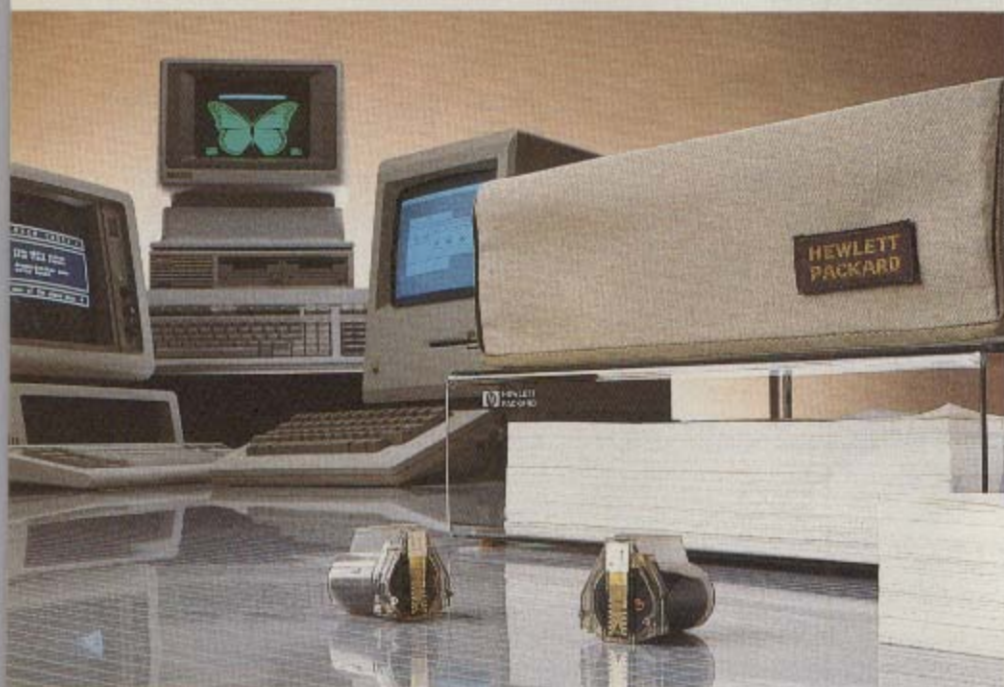

Get your ThinkJet off to a great start or keep it going strong with five essential products in one convenient package. This 5-in-1 kit saves you 15 percent off the price you'd pay when you purchase these products individually.

The kit contains:

- Two JetPaper black print cartridges (each prints approx. 500 pages)
- One spacesaving acrylic printer stand (holds 400 sheets of microperforated Z-Fold Jetpaper)
- One static-resistant, cotton dust cover
- 500 sheets of microperforated Z-Fold JetPaper. Finished size: 216 x 279mm (8.5 x 11 in.)
- 500 sheets of individually-cut JetPaper (216 x 279mm or 8.5 x 11 in.)

92261D ThinkJet
Accessory Kit \$95.00 ea.

Your ThinkJet Printer can be up and running in no time at all with five ThinkJet accessories packaged into one.

Choose printer accessories too good to keep quiet

Wire paper catchers attach to your ThinkJet, QuietJet or QuietJet Plus Printer stand, and paper will neatly refold and stack as it flows from your printer. Chance of paper running back into the printer and getting jammed is minimized. The catcher can lay flat on your desk or suspend at a 30 degree angle. Suspended catcher will hold approximately 200 sheets.

92261R Paper Catcher for ThinkJet Printer Stand (1 unit) \$35.00 ea.
(2-4) 31.00 ea.
(5-9) 28.00 ea.

92261G Paper Catcher for QuietJet or QuietJet Plus Printer Stand \$28.00 ea.

Desktop printer stands for the QuietJet, QuietJet Plus and ThinkJet increase your work surface, store paper and help control paper flow. Raised rear edges route cables away from the paper path, and support paper catcher.

92261S ThinkJet Printer Stand \$49.00 ea.

92261U QuietJet Printer Stand 79.00 ea.

92261T QuietJet Plus Printer Stand 84.00 ea.



Save 15% with 8-in-1 QuietJet Plus Accessory Kit

Start your QuietJet Plus Printer off right with a sampler kit featuring eight important products:

- Four JetPaper print cartridges in black, blue, green, and red colors (Each prints approx. 500 pages)
- One space-saving acrylic stand (You can store 500 sheets of Z-Fold or Z-Fold Wide JetPaper under your printer)
- One static-resistant, cotton dust cover
- 500 sheets of microperforated narrow Z-Fold JetPaper
- 500 sheets of perforated Z-Fold Wide JetPaper

This kit saves you more than 15 percent off the price you'd pay when you purchase these products individually.

92261P QuietJet Plus Accessory Kit with 11-in. (279 mm) paper \$159.00 ea.
Narrow paper finished size: 8 1/2 x 11 in. (216 x 279 mm)
Wide paper finished size: 14 3/4 x 11 in. (378 x 279 mm)

92261X QuietJet Plus Accessory Kit with 12-in. paper Available in Europe only.
Narrow paper finished size: 8 1/2 x 12 in. (210 x 305 mm)
Wide paper finished size: 14 3/4 x 12 in. (376 x 305 mm)



See our full line of ThinkJet and QuietJet Series supplies on page 39.

JetPlotter software makes your HP JetSeries Printer think like a plotter!

No more waiting for the office plotter! JetPlotter™ lets you unlock the powerful graphics capabilities of your HP ThinkJet, QuietJet or QuietJet Plus Printer, and makes it function like a full-featured HP plotter.

This software package converts the graphics language of HP plotters into high-resolution ink-jet printouts. You can take advantage of most CAD, engineering or business graphics software supported by HP 7475A, 7470 or ColorPro Plotters.

Double your printer power. Ever tried to photocopy color plotter pen output in black and white? The colors blend, don't they? Not so with JetPlotter! It lets you print in 72 combinations of line width and texture—all of which photocopy into perfect black and white.

Print those Lotus® or HP Drawing Gallery graphics—silently and without additional desk space! JetPlotter lets you position, shrink and even expand graphics. You can even use a blue ink-jet printer head and inverse function to simulate blueprints.

JetPlotter is available for the HP Vectra PC and other IBM PC compatibles. Supported by Insight Development Corporation.

35190P JetPlotter \$99.00 ea.

You can "plot" graphics in black and white or single colors, even in large sizes or as simulated blueprints.

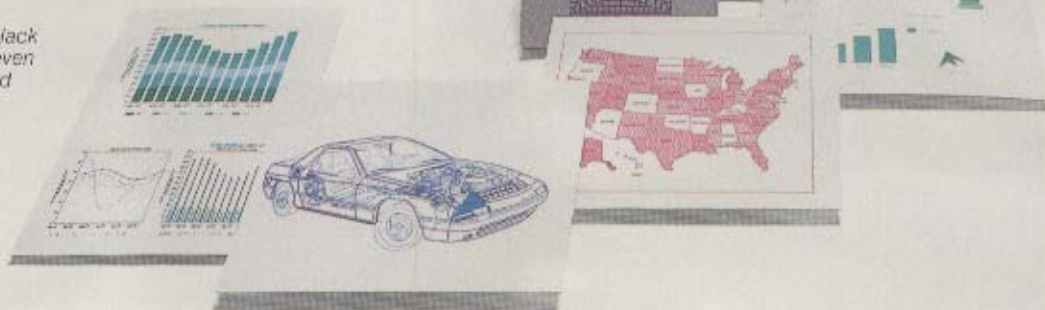

JetStart lets your Macintosh print on HP JetSeries Printers



JetStart™ software allows standard Mac/MacPlus applications to run on QuietJet/ QuietJet PLUS and 2225D ThinkJet Printers.

Its features include:

- Compatibility with Apple's enhancement option
- Enhanced word and tab spacing
- Full support of printer features
- Access to "choose" and "chooser" features in the Mac/MacPlus.

The 92219M cable is required.

35177M JetStart™ \$45.00 ea.
92219M Cable 45.00 ea.

Stack ThinkJet/paper above terminal and save desktop space.

Off your desk and atop your HP 2392A Terminal, this acrylic stand gives you more work surface and maximum use of terminal space.

Lower tier holds approximately 400 sheets of Z-Fold JetPaper. Rear edge is raised to route cables and power cord away from the paper path, and support the 92261R Wire Paper Catcher.

Printer and stand won't interfere with terminal ventilation. Stand also works with the HP 150 II PC, other HP 239x Terminals. Dimensions: 64 H x 325.6 W x 276.9 D mm (2.5 H x 12.7 W x 10.8 D in.).

92171X Terminal-top ThinkJet Stand
 (1-2 units) \$59.00 ea.
 (3-9) 53.00 ea.



Print labels on your ThinkJet, QuietJet or PaintJet!

HP's pressure-sensitive, self-adhesive ink-jet labels are designed to run on your HP ThinkJet/ QuietJet/ QuietJet PLUS/ PaintJet Printers without jamming or tearing. Economical and simple to run, these labels will be your most widely used supply. Use them on envelopes or just to identify files.

51830L Ink-jet Labels
 (1-2 boxes) \$18.95 ea.
 (3-11) 17.95 ea.
 (12+) 16.95 ea.
92261S Acrylic Mini-printer Stand
 (1-2 stands) \$49.00 ea.
 (3-9) 46.00 ea.
 (10+) 41.00 ea.

JetSeries supplies and accessories

Product no.	Description	Price	Product no.	Description	Price
92261A	JetPaper Print Cartridge, black. 600,000 characters (approx. 500 pages). Fits QuietJet, ThinkJet and QuietJet Plus Printers.	\$10.95 ea.	51630L	Pressure-sensitive, self-adhesive ink-jet labels. Dimensions: 89 x 24mm (3 1/2 x 1 5/8 in.) (241mm or 9 1/2 in. form width). Two across, 2,000 per box, fanfold. See previous page.	(1-2 boxes) . . . \$18.95 ea. (3-11) 17.95 ea. (12+) 16.95 ea.
51604A	Plain Paper Print Cartridge, black. For use on common printer papers. 500,000 characters (approx. 400 pages). Fits QuietJet, ThinkJet and QuietJet Plus Printers.	\$10.95 ea.	92250W	QuietJet Plus dust cover.	(1-2) \$27.00 ea. (3-4) 25.00 ea. (5+) 23.00 ea.
51605B	JetPaper Print Cartridge, blue. 600,000 characters (approx. 500 pages). Fits QuietJet, ThinkJet and QuietJet Plus Printers.	\$12.95 ea.	92250X	QuietJet dust cover.	(1-2) \$20.00 ea. (3-4) 18.00 ea. (5+) 16.00 ea.
51605G	JetPaper Print Cartridge, green. 600,000 characters (approx. 500 pages). Fits QuietJet, ThinkJet and QuietJet Plus Printers.	\$12.95 ea.	92250V	ThinkJet dust cover.	\$19.00 ea.
51605R	JetPaper Print Cartridge, red. 600,000 characters (approx. 500 pages). Fits QuietJet, ThinkJet and QuietJet Plus Printers.	\$12.95 ea.	35178C	ThinkJet carrying case.	\$59.00 ea.
51630A	Z-Fold JetPaper. 500 sheet box. 75g (20 lb.) microperforated. Finished size is 8.5 x 11 in. Fits ThinkJet, QuietJet and QuietJet Plus Printers.	(1-3 boxes) . . \$14.95 ea. (4+) 13.75 ea.	92261G	Paper catcher for 92261U QuietJet Printer stand and 92261T QuietJet Plus Printer stand. Set catcher on, or suspend at up to a 30° angle from your desk. Dimensions: 64 H x 414 W x 343 D mm (2.5 H x 16.3 W x 13.5 D in.)	(1-2) \$28.00 ea. (3-9) 25.00 ea. (10-49) 23.00 ea. (50+) 19.00 ea.
51630C	Z-Fold JetPaper, 500 sheet box. 75g (20 lb.) microperforated. Finished size is 210 x 297mm. Fits ThinkJet, QuietJet and QuietJet Plus Printers.	Available in Europe only.	92261S	Acrylic mini-printer stand. See photo previous page. Dimensions: 82 H x 298 W x 305 D mm (3.3 H x 11.75 W x 12 D in.)	(1-2) \$49.00 ea. (3-9) 46.00 ea. (10+) 41.00 ea.
92261K	Z-Fold JetPaper, 2500 sheet box. 75g (20 lb.) microperforated. Finished size is 210 x 297mm. Fits ThinkJet, QuietJet and QuietJet Plus Printers.	Available in Europe only.	92261T	QuietJet Plus Printer stand. Dimensions: 89 H x 533 W x 297 D mm (3.5 H x 21 W x 11.7 D in.)	(1-2) \$84.00 ea. (3-9) 81.00 ea. (10-49) 79.00 ea. (50+) 77.00 ea.
92261N	Z-Fold JetPaper. Five individually wrapped 500 sheet packs. (2500 sheets total.) 75g (20 lb.) microperforated. Finished size is 8.5 x 11 in. Fits ThinkJet, QuietJet and QuietJet Plus Printers.	(1-2 boxes) . . \$59.95 ea. (3-10) 57.50 ea. (11-24) 54.95 ea. (25-63) 52.95 ea. (64+) 49.95 ea.	92261U	QuietJet Printer stand. Dimensions: 89 H x 400 W x 297 D mm (3.5 H x 15.75 W x 11.7 D in.)	(1-2) \$79.00 ea. (3-9) 73.00 ea. (10-49) 69.00 ea. (50+) 66.00 ea.
51630B	Z-Fold Wide JetPaper. 500 sheet box. 75g (20 lb.) perforated. Finished size is 14 7/8 x 11 in. Fits QuietJet Plus Printer.	(1-3 boxes) . . \$15.95 ea. (4+) 14.95 ea.	92171X	Terminal-top ThinkJet Printer stand. Dimensions: 70 H x 320 W x 272 D mm (2.75 H x 12.7 W x 10.8 D in.)	(1-2) \$59.00 ea. (3-9) 53.00 ea. (10+) 49.00 ea.
51630D	Z-Fold Wide JetPaper. 2500 continuous sheet box. 75g (20 lb.) Finished size is 14 7/8 x 11 in. Fits QuietJet Plus Printer.	(1-2 boxes) . . \$75.00 ea. (3-10) 71.00 ea. (11-24) 68.00 ea. (25-63) 65.00 ea. (64+) 56.00 ea.	82199A	ThinkJet battery pack (For use with 2225B/P only)	\$47.00 ea.
51630F	Z-Fold Wide JetPaper, 500 sheet box. 75g (20 lb.) Finished size 375 x 305mm. Fits QuietJet Plus Printer.	Available in Europe only.	82059D	AC adapter/recharger for HP 2225B.	\$20.00 ea.
51630H	Z-Fold Wide JetPaper, 2500 sheet box. 75g (20 lb.) Finished size 375 x 305mm. Fits QuietJet Plus Printer.	Available in Europe only.	82067B	AC adapter/recharger for HP 2225B.	Available in Europe only.
51630J	Cut Sheet JetPaper. 500 sheet box. 75g (20 lb.) Finished size is 8.5 x 11 in. Fits ThinkJet, QuietJet and QuietJet Plus Printers.	(1-3 boxes) . . \$12.95 ea. (4+) 11.95 ea.	82241A	AC adapter/recharger for HP 2225C.	\$15.00 ea.
51630K	Cut Sheet A4-size JetPaper, 500 sheet box. 75g (20 lb.) 210 x 297mm. Fits ThinkJet, QuietJet and QuietJet Plus Printers.	Available in Europe only.	82241AB	AC adapter/recharger for HP 2225C.	Available in Europe only.
			82066B	AC adapter/recharger for HP 2225P.	\$25.00 ea.
			82068B	AC adapter/recharger for HP 2225P.	Available in Europe only.
			17122B	Replacement external power module for U.S. and Canada, 120V/50/60Hz. Use with the PaintJet, DeskJet, QuietJet or QuietJet Plus Printers.	\$60.00 ea.
			17222B	Replacement external power module for Europe, 220V/50Hz. Use with the PaintJet, DeskJet, QuietJet or QuietJet Plus Printers. For other countries and different configurations, call for info.	\$60.00 ea.
			35190P	JetPlotter software for ThinkJet, QuietJet and QuietJet Plus Printers.	\$99.00 ea.

Three reasons to choose HP JetPaper

1. HP JetPaper produces the sharpest image. HP JetPaper is specially engineered for printing with HP ink-jet print cartridges. When droplets of ink are "fired" from an ink-jet cartridge, the uniformly laid fibers in the HP JetPaper surface absorb the ink evenly in all directions, facilitate fast ink drying, and prevent the printed characters from smudging, running or blotting.

2. Produces cleaner edges. HP JetPaper features ultra-fine microperforated edges to allow you to cleanly separate each sheet of paper.

3. Enhances printer reliability. HP JetPaper is designed to significantly reduce the amount of floating paper dust which can clog ink-jet cartridges.

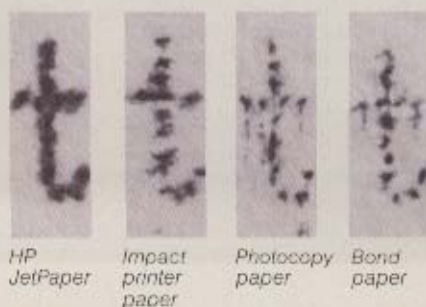

HP JetPaper Impact printer paper Photocopy paper Bond paper

Simplify cut-sheet printing on your HP RuggedWriter 480 Printer (HP 2235 series)

The RuggedWriter 480 Printer lets you print on most any cut-sheet stock, in draft- or letter-quality mode.

Our RuggedWriter 480 sheetfeed accessory makes this versatility easy. The paper cassette holds up to 100 sheets, while the accessory loads and aligns each page into the printer's carriage for you.

Designed to become an integral part of your printer, this accessory snaps easily and securely into the printer frame and requires no additional space. ☑



12239A RuggedWriter 480 Sheetfeeder accessory with US letter-size paper cassette (**922858**) \$250.00 ea.

12239B RuggedWriter 480 Sheetfeeder accessory with European A4-size paper cassette (**922850**) (Available in Europe only.) For extra paper trays, see page 20.

Snap the metal accessory inside, fit the cassette into the rear—takes only moments.



Guide your paper from desktop to printer.

Conserve desktop space— increase printing efficiency!

Use this sturdy, color-coordinated printer/PC stand with your HP RuggedWriter 480 Printer, and you can store up to 250 sheets of continuous-feed paper on your desktop. This stand allows your paper to flow from underneath your printer unhindered by power cords or desktop clutter. The dove gray color is complementary to your printer and *Design Plus* furniture. Dimensions are 201 H x 612 W x 396 D mm (4.0 H x 24.1 W x 15.6 D in.). For Printer paper, see page 45. ☑

92166A RuggedWriter 480 Printer Stand/HP Vectra PC Keyboard Park
 (1-2) \$99.00 ea.
 (3-9) 95.00 ea.
 (10+) 89.00 ea.

Customize your RuggedWriter 480 printing

The RuggedWriter 480 font cartridge expands your printing capabilities, to help your letters and reports stand out in a crowd. Included are Prestige Elite 12, Letter Gothic 12, TmsRmn PS and Helv. It also features 16K bytes of RAM to allow for downloading and customized font printing, or to be used as additional buffer space.



12235A RuggedWriter Font cartridge \$150.00 ea.

Prestige Elite 12

ABC abc 123 !"#%&'()*+*

Letter Gothic 12

ABC abc 123 !"#%&'()*+*

TmsRmn PS

ABC abc 123 !"#%&'()*+*

Helv 10

ABC abc 123 !"#%&'()*+*

Get an HP Daisywheel Printer for professionalism at a sensible price!

Capable of producing superior letter-quality printing at a speed of 48 characters per second, the HP 2603A Daisywheel Printer efficiently handles all your daily business documents. It combines flexibility with outstanding performance to bring you great results every time! And, to top it off, an acoustic sound carpet is included to reduce work-disturbing printer noise.

Effortless installation and use. Daisywheels, ribbons and handling devices can be readily installed and changed within seconds. The clearly-written printer manual makes learning easy. All controls that call up such features as form feed, print pitch, length of form, etc., are conveniently located on the console. The switches that specify communications protocols, baud rate, etc., are easily accessible on the rear panel.

Ease of paper handling. A single-sheet automatic paper feeder (via a front-panel button) allows you to get perfect alignment on your first print line.

Compatibility and low cost. Compatible with the HP 3000, Vectra PC, Touchscreen (HP 150), and many other personal computers (as well as with most software packages), the HP 2603A is priced at a fraction of the cost of other high-performance printers.

2603A Daisywheel Printer \$1495.00 ea.

Triple bin feeder ensures consistent, accurate paper placement and prevents paper jams. Each bin holds 200 sheets of paper from 4 in. (102 mm) to 14 in. (356 mm) wide. Envelope bin holds up to 60 envelopes from 4 x 4 in. (102 x 102 mm) to 14 x 14 in. (356 x 356 mm).

26030E \$999.00 ea.



Print easy with a Daisywheel Printer triple bin feeder on your HP 2603 Printer.

*Quantity, contract, or other discounts do not apply to the special off-the-shelf printer sales.

Enjoy best results with these Daisywheel Printer enhancements.

Four-in-one accessory kit includes a 2603 ribbon cartridge, Prestige Elite 12 printwheel, Mikron 15 printwheel and word processing ruler with 10-, 12- and 15-pitch spacing guides. Buy the kit and save 10%! **922718** \$53.95 ea.



Bidirectional tractor feed mechanism accommodates continuous or multi-part forms from 4 in. (102 mm) to 14 7/8 in. (378 mm) pin to pin for HP 2603 Printers.

26030A \$299.00 ea.

Type Design Ruler helps you create the perfect documents using your word processing system. Specially recommended for use with HPWORD. Design your documents for any size printer up to 132 columns wide (14 7/8-inch forms).

- 10-, 12- and 15-pitch spacing guides (positions/inch)
- 6 and 8 lines/inch spacing scales (reverse side)
- See-through windows for easy reading
- Convenient 15-inch length

5957-8407 \$4.00 ea.

Platen Cleaner Pak™ reduces paperjams and skewed printing by putting papergrit back in your printer. Over time, paper tatters built up on your printer's rubber rollers and platens, cause glazing and paper slippage. Regular cleaning restores their paper grip—and reduces service calls! (10 disposable cleaning pads)

921937

(1 unit) \$16.00 ea.
(2-5) 14.00 ea.
(6-9) 13.00 ea.
(10+) 11.00 ea.



HP 2603A Printwheels††

Made of heavy (dual) plastic, for quieter printing and longer life (average life: 15 million strokes).

Courier 10
92270A* ABC abc 0123456789 &\$
 " ' (_ ^ ") ° ~ + - ½ = | * % ! / : . ; ? ,

Prestige Elite 12
92270C* ABC abc 0123456789 %£
 * _ & ' () ^ ' ^ [" ° @ ½ "/ | ! + ; : £ = - . , ?

Letter Gothic 12
92270D* ABC abc 0123456789 &\$
 " ' (_ ^ ") ° ~ + - ½ = | * % ! / : . ; ? ,

Italics 12
92270E* ABC abc 0123456789 &\$
 " ' (_ ^ ") ° ~ + - ½ = | * % ! / : . ; ? ,

Eletto 12
92270F* ABC abc 0123456789 &\$
 " ' (_ ^ ") ° ~ + - ½ = | * % ! / : . ; ? ,

Mikron 15
92270G* ABC abc 0123456789 £\$
 " ' (_ ^ ") ° ~ + - ½ = | * % ! / : . ; ? ,

Kent PS**
92270H* ABC abc 0123456789 &\$
 " ' (_ ^ ") ° ~ + - * | % ! / : . ; ? ,

Modern PS**
92270J* ABC abc 0123456789 &\$
 " ' (_ ^ ") ° ~ + - * | % ! / : . ; ? ,

Esteem Pica 10*
92270K ABC abc 0123456789 ! " # \$ % & '
 () * + , - . / : ; < = > ? @ [\] ^ _ ` { | } ~

NA Modern PS**
92270Q* ABC abc 0123456789 ! " # \$ % & '
 () * + , - . / : ; < = > ? @ [\] ^ _ ` { | } ~

Prestige Elite 12*
Legal
92270R ABC abc 0123456789 ! " # \$ % & '
 () * + , - . / : ; < = > ? @ [@] © _ \$ % ! ~

Price (1-3) \$19.95 ea.
 (4-10) 17.60 ea.
 (11+) 15.60 ea.

††Call for information on North Atlantic wheels.

*Contains Roman 8 character set.

**PS = Proportional spaced.

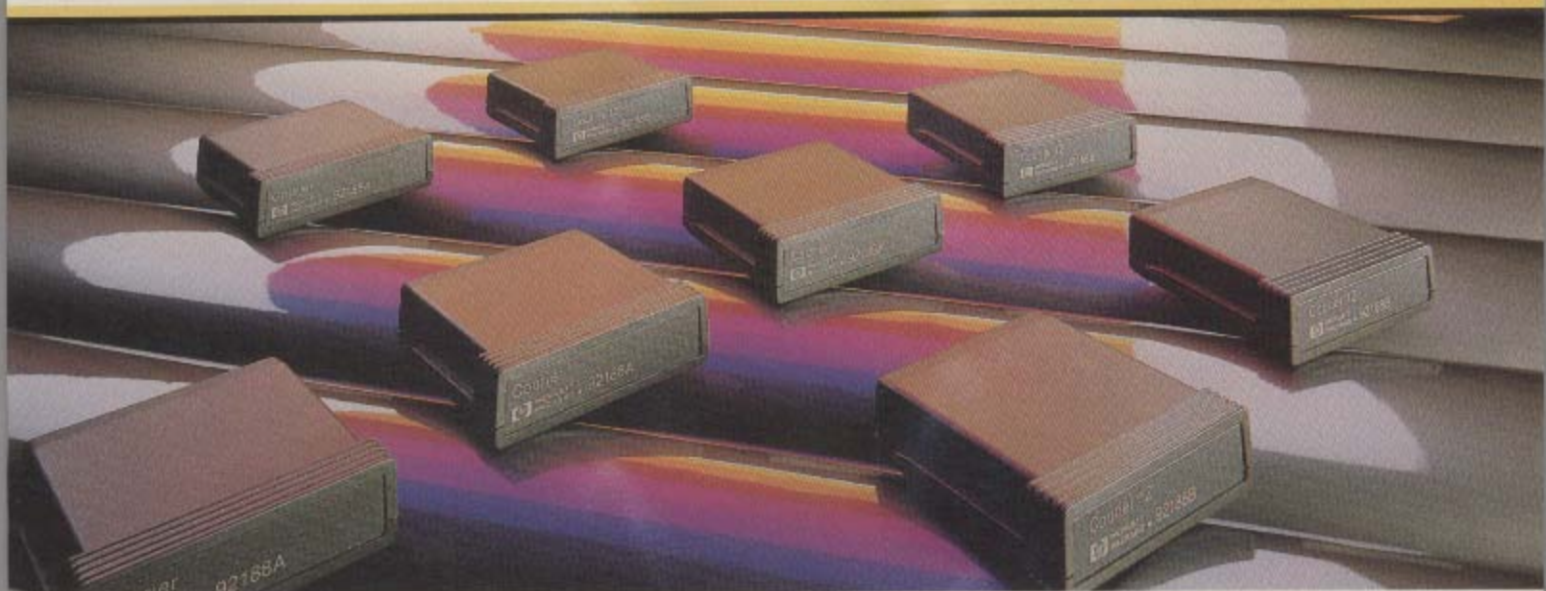

Select a new Plug-in font cartridge to give your reports a new look.

2934A Printer Plug-in character style font cartridges

92188A Courier 10	ABCabc123,-.!"#%&'()*+<=>?!)-#AA&E EEIi'~~~~'00E'ÇçÑñ;¿DEY\$fcâëöüáéóú æöüæöüÁíΘÆáíΘÆÁíΟΥÿÿþ-¼½¾«»±■
92188B Courier 12	ABCabc123,-.!"#%&'()*+<=>?!)-#AA&EEEIi' ~~~~'00E'ÇçÑñ;¿DEY\$fcâëöüáéóúæöüáéóú íΘÆÁíΟΥÿÿþ-¼½¾«»±■
92188E Helv 10	ABCabc123,-.!"#%&'()*+<=>?!)-#AA&E&Ei' ~~~~'00E'ÇçÑñ;¿DEY\$fcâëöüáéóúæöüáéóú ÆáíΘÆÁíΟΥÿÿþ-¼½¾«»±■
92188G OCR A	ABC[\] ^ _ abc 123,-.!"#%&'()*+<=>? : ; } ~
92188H Light Italic 10	ABCabc123,-.!"#%&'()*+<=>?!)-#AA&E EEIi'~~~~'00E'ÇçÑñ;¿DEY\$fcâëöüáéóú æöüáéóúÁíΘÆáíΘÆÁíΟΥÿÿþ-¼½¾«»±■

92188J Italic 12	ABCabc123 !"#%&'()*+,-./:;<=>? @[\]^_` AA&E EEIi'~~~~'00E'ÇçÑñ;¿DEY\$fcâëöüáéóú æöüáéóúÁíΘÆáíΘÆÁíΟΥÿÿþ-¼½¾«»±■
92188K Orator 12	ABC123!"#%&'()*+,-./:;<=>?@_`=ç?†*~
92188M Prestige Pica 10	ABCabc123,-.!"#%&'()*+<=>?!)-#AA&E EEIi'~~~~'00E'ÇçÑñ;¿DEY\$fcâëöüáéóú æöüáéóúÁíΘÆáíΘÆÁíΟΥÿÿþ-¼½¾«»±■
92188N Prestige Elite 12	ABCabc123,-.!"#%&'()*+<=>?AA&E EEIi'~~~~ 00E'ÇçÑñ;¿DEY\$fcâëöüáéóúæöüáéóú íΘÆÁíΟΥÿÿþ-¼½¾«»±■
92188R Letter Gothic 12	ABCabc123,-.!"#%&'()*+<=>?!)-#AA&E EEIi'~~~~'00E'ÇçÑñ;¿DEY\$fcâëöüáéóú æöüáéóúÁíΘÆáíΘÆÁíΟΥÿÿþ-¼½¾«»±■
92188T OCR B	ABC [\] ^ _ abc 123,-.!"#%&'()*+;:<=>?C) ■

Price \$100.00 ea.

Now...your office paper is just a phone call away!

Why make a special trip to buy office paper when we can send it to you? Ours is quality paper, measuring a standard 216 x 279mm (8.5 x 11 in.) It's practical for typing, photocopying, LaserJet printing and general office use. What's more, you don't have to leave the office to get it—just order it by phone when you call for your other supplies!



Our price is competitive with other high-quality brands, and delivery costs are included in the price. 5,000 sheets per package.

92157L Office Paper

(1 unit)	\$59.95 ea.
(2)	53.95 ea.
(3-6)	46.76 ea.
(7-39)	42.56 ea.
(40+)	32.97 ea.



See page 45 for more HP papers

Impact printer ribbons











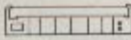
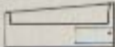
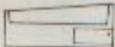

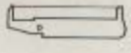
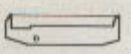

Impact printer model number	Product number	Description	Dimensions & measurements	Unit of measure	Price	Cross-reference to other supplies & accessories	
2235A/B/C/D Ruggedwriter 480 Dot Matrix Printers	92156S	Ribbon cartridges, continuous feed. Black print.		.75 in. (3/4) ribbon, 29.5 yards, 5 million characters	Box of 3	(1-2 boxes) \$45.00 ea.	See: Paper pg. 45 Sheet feeder pg. 40 Font cartridges pg. 40 Desktop stand pg. 40 Floor stand (92214P) . . . pg. 103
		(3-7) 40.00 ea.					
		(8+) 35.00 ea.					
2563A/2563B/2564B Dot Matrix Printers	92158A	Ribbon cartridges, mobius loop construction, continuous feed. Blue/black print.		.75 in. (3/4) ribbon, 100 yards, 30 million characters	Box of 3	(1-2 boxes) \$77.00 ea.	See: Paper pg. 45 Printer stand pg. 103
	92158M	Ribbon cartridges, for optical mark recognition applications. Black print.					
							(3-7) 69.50 ea.
						(8+) 62.00 ea.	
2565A/2566A/2567B High Speed Dot Matrix Printers	9282-0545	Wide nylon ribbon. Blue/black print.		15 in. ribbon, 20 yards, .004 in. thick, 1 million lines	Each	(1-3 ribbons) \$49.00 ea.	See: Paper pg. 45
						(4+) 35.00 ea.	
2601A Daisywheel Printer	92151C	Multistrike, high-capacity, reel-to-reel ribbon cartridges. Black print.		.31 in. (5/16) ribbon, 235,000 characters	Box of 12	(1 box) \$60.00 ea.	See: Paper pg. 45 Printer stand pg. 106 Printwheel cleaning kit pg. 45 Printwheels, plastic & metal pg. 42 Printwheel storage album pg. 46 Sound absorbing mat . . . pg. 107
	92151D	Fabric, continuous cycle feed ribbon cartridges. Black print.					
							(2-3) 57.00 ea.
						(4+) 55.00 ea.	
2602A Daisywheel Printer	92151H	Multistrike, high capacity reel-to-reel ribbon cartridge. Black print.		.31 in. (5/16) ribbon, 450,000 characters	Box of 12	(1 box) \$78.00 ea.	See: Paper pg. 45 Printwheels pg. 42 Printwheel storage album pg. 46
						(2-3) 74.00 ea.	
						(4+) 71.75 ea.	
2603A Daisywheel Printer	92271A	Multistrike, high-capacity, reel-to-reel ribbon cartridges. Black print.		.56 in. (14.3 mm) ribbon, 153 yards, 500,000 characters (500 pages)	Each	(1-2 boxes) \$18.00 ea.	See: Paper feeder pg. 41 Printwheels pg. 41
	92271E	Fabric, continuous cycle feed ribbon cartridges. Black print.					
							(3-9) 16.40 ea.
						(10+) 14.80 ea.	
2607A Dot Matrix Line Printer (Also 9881A Printer and 12987A Subsystem)	9282-0531	Nylon ribbon, reel-to-reel. Black print.		.75 in. (3/4) ribbon, 36 yards, .005 in. thick.	Each	Minimum order 6 ribbons (6-23 ribbons) \$6.70 ea.	See: Paper pg. 45
						(24+) 6.20 ea.	
2608A/S Dot Matrix Printer	92158A	Ribbon cartridges, mobius loop construction, continuous feed. Blue/black print.		.75 in. (3/4) ribbon, 100 yards, 30 million characters	Box of 3	(1-2 boxes) \$77.00 ea.	See: Layout forms pg. 46 Paper pg. 45
	92158M	Ribbon cartridges, for optical mark recognition applications. Blue/black print.					
							(3-7) 69.50 ea.
						(8+) 62.00 ea.	
2611A Line Printer	1535-3914	Wide nylon ribbon for normal print applications. Blue/black print.		14 in. ribbon, 15 yards, .005 in. thick	Each	(1-2 ribbons) \$36.00 ea.	See: Paper pg. 45 VFU tape, prepunched pg. 46
	92230A	Wide nylon ribbon for high-contrast print applications. Black print.					
							(3-11) 30.00 ea.
						(12+) 26.00 ea.	
2613A Line Printer (Also 12975A Subsystem)	9282-0545	Wide nylon ribbon. Blue/black print.		15 in. ribbon, 20 yards, .004 in. thick	Each	(1-3 ribbons) \$49.00 ea.	See: Paper pg. 45 VFU tape, prepunched pg. 46
2617A Line Printer (Also 13053A Subsystem)						(4+) 35.00 ea.	

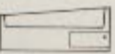
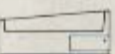
Chart continued next page.

Impact printer ribbons (continued)

Impact printer model number	Product number	Description	Dimensions & measurements	Unit of measure	Price	Cross-reference to other supplies & accessories
2619A Line Printer	1535-3914	Wide nylon ribbon for normal print applications. Blue-black print.	 14 in. ribbon, 15 yards, .005 in. thick 1 million lines	Each	(1-2 ribbons) . . . \$36.00 ea. (3-11) 30.00 ea. (12+) 26.00 ea.	See: Paper see below VFU tape pg. 46 Vacuum bags pg. 46
	92230A	Wide nylon ribbon for high-contrast print applications. Black print.	 14 in. ribbon, 18 yards, .004 in. thick	Each	(1-2 ribbons) . . . \$52.00 ea. (3-11) 43.00 ea. (12+) 38.00 ea.	
2631A/B Dot Matrix Printer	92155A	Ribbon cartridges, molius loop construction, continuous feed. Black print.	 .75 in. (3/4) ribbon, 55 yards, 15 million characters	Box of 3	(1-2 boxes) \$60.00 ea. (3-7) 51.00 ea. (8+) 44.00 ea.	See: Paper see below Print head pg. 46 Print stand pg. 103
2635A/B Printing Terminal						
2639A Printing Terminal						
2631G Graphics Printer	92155B	Ribbon cartridges, used with 2631G, opt. 200 only. Black print.	 .75 in. (3/4) ribbon, 55 yards, 5000 bar code labels (10 characters each)	Box of 3	(1-2 boxes) \$65.00 ea. (3-7) 56.00 ea. (8+) 50.00 ea.	
2767A Line Printer	9300-0427	Wide nylon ribbon. Blue-black print.	 9 in. ribbon, 28 yards, .005 in. thick	Each	(1-3 ribbons) . . . \$36.00 ea. (4-35) 30.00 ea. (36+) 27.00 ea.	
2932/33/34A Dot Matrix Printers	92155L	Ribbon cartridges, continuous feed. Black print.	 .75 in. (3/4) ribbon, 50 yards, 10 million characters	Box of 3	(1-2 boxes) \$72.00 ea. (3-7) 62.00 ea. (8+) 55.00 ea.	See: Paper see below Paper catcher pg. 46 Plug-in font cartridges 2934 only pg. 43 Print head pg. 46 Printer stands pg. 103
2933A/2934A Dot Matrix Printer	92155M	OCR ribbon cartridge (used to print bar code).	 .75 in. (3/4) ribbon, 50 yards, 4000 bar code labels (10 characters each)	Box of 3	(1-2 boxes) \$79.00 ea. (3-7) 69.00 ea. (8+) 59.00 ea.	
44653A for 3065 Board Tester	46295A	Ribbon cartridges, continuous feed. Black print.	.50 in. (1/2) ribbon, 15 yards, 1.5 million characters	Box of 2	(1-2 boxes) \$46.00 ea. (3-7) 44.00 ea. (8+) 36.00 ea.	
82905A/B Dot Matrix Printer	92156A	Ribbon cartridges, continuous feed. Black print.	 .5 in. (1/2) ribbon, 20 yards, 3 million characters	Box of 2	(1-2 boxes) \$22.00 ea. (3-7) 20.00 ea. (8+) 18.00 ea.	See: Paper see below Print head pg. 46 Print stand pg. 103
82906A Dot Matrix Printer						

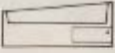
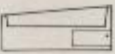
Impact printer paper

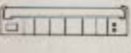
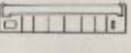
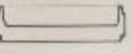



For use with	Product number	Description	Dimensions & measurements	Unit of measure	Price
2235A/B/C/D (Ruggedwriter 480) 2563A/B 2564B 2565A 2566A/B 2567B 2601A 2602A 2603A 2607A 2608A/S 2611A 2613A 2617A 2618A 2619A 2631/35/39 2932A 2933A 2934A 82905A/B 82906A (Must have optional tractor feed mechanism to use 9280-0705 or 9280-0218 papers.) 9871A	92157A	Fanfold, blank printer paper.	 9.5 in. (241 mm) x 11 in. (279 mm) 8.5 in. (216 mm)	Box	(1-2 boxes) \$42.00 ea. (3-5) 37.00 ea. (6-11) 35.00 ea. (12+) 33.00 ea.
	92157B	Fanfold, 3-hole punched, blank printer paper.	see 92157A illustration above.	Box	(1-2 boxes) \$50.00 ea. (3-5) 46.00 ea. (6-11) 44.00 ea. (12+) 42.00 ea.
	92157C	Fanfold, microperforated printer paper for high-quality word processing applications.	see 92157A illustration above.	Box	(1-2 boxes) \$59.00 ea. (3-5) 56.00 ea. (6-11) 54.00 ea. (12+) 52.00 ea.
	92157D	Fanfold, blank printer paper. Available in Europe only.	 9.5 in. (241 mm) x 12 in. (305 mm) 8.5 in. (216 mm)	Box	(1-2 boxes) \$42.00 ea. (3-5) 37.00 ea. (6-11) 35.00 ea. (12+) 33.00 ea.
	9280-0705	72-column blank printer paper.	 8.5 in. (216 mm) x 11 in. (279 mm) 7.5 in. (191 mm)	Box	(1-67 boxes) \$47.00 ea. (68+) 40.00 ea.

Chart continued next page.

Impact printer paper (continued)

	Product number	Description	Dimensions & measurements	Unit of measure	Price
For use with the printers listed on page 45.	9280-0218	80-column green-bar printer paper.	 9.9 in. (251 mm) 11 in. (279 mm)	15 lb. bond green-bar 0.5 in. (1-2) 3200 sheets/box	Box (1-51 boxes) \$52.00 ea. (52+) 44.00 ea.
	9320-1515	132-column blue-bar printer paper.	 14.8 in. (378 mm) 11 in. (279 mm)	18 lb. bond blue-bar 0.5 in. (1-2) 2400 sheets/box	Box (1-2 boxes) \$55.00 ea. (3-5) 47.00 ea. (6-11) 44.00 ea. (12+) 42.00 ea.

Impact printer supplies

Printer	Product number	Description	Price	
2601A	92167W	9.5 × 11.6 in. (241 × 295mm) Printwheel storage album. Bone-colored with black accent. Holds six printwheels.	(1-2 albums) \$13.00 ea. (3-4) 12.00 ea. (5+) 11.00 ea.	
	92177J	Extra paper trays for HP 26010D sheet feeder. (8.5 × 11 inch)	(1-2 trays) \$100.00 ea. (3+) 90.00 ea.	
	92177K	(landscape: 11 × 8.5 inch)		
	92177L	(legal: 8.5 × 14 inch)		
	92177M	(210 × 297mm/A4)		
	92177N	(landscape: 210 × 297mm/A4)		
	92193C	Printwheel clean kit Cleaner box, single element pad, interchangeable wheel holder, and 4 oz. bottle of cleaning solution.	(1 kit) \$22.00 ea. (2-4) 20.00 ea. (5+) 19.00 ea.	
	92193D	Printwheel clean kit refill 4 oz. bottle of cleaning solution, and single element pad.	(1-4 refills) \$17.00 ea. (5+) 15.00 ea.	
	2602A	92167V	305 × 338mm (12 × 13.3 in.) Printwheel storage album. Bone-colored with brown accent. Holds six 98-character printwheels.	(1-2 albums) \$15.00 ea. (3-9) 12.00 ea. (10+) 10.00 ea.
			see page 41 for supplies	
2608A/S	02608-60091	Package of layout forms. Total 250 sheets on 5 pads.	\$17.00 pkg.	
2611A	02613-80001	Individual pre-punched VFU tape. (66 lines/page)	\$8.70 ea.	
2613A	02619-80003	Individual pre-punched VFU tape. (88 lines/page)	\$10.00 ea.	
2617A				
2618A	4114-0371	Blank VFU tape, self adhesive.	(1 pkg) \$41.00 ea.	
2619A		25 blank tapes per package.	(2+) 37.00 ea.	
2619A	9300-0750	Package of 3 vacuum bags (min. order 5 packages).	\$4.10 ea.	
	92230B	Chain train oil, 1 oz. bottle.	\$8.50 ea.	
2631A/B/G 2635/39	92230C	Chain train oil, 1 qt. refill bottle.	\$67.50 ea.	
	92154G	Replacement print head.	(1-2 heads) \$185.00 ea. (3+) 160.00 ea.	
2932/33/34A Dot Matrix Printers	92154B	Replacement print head. Average life is 50 to 100 million characters.	\$140.00 ea.	
	92171G	Printout paper catcher. Wire construction, easy mounting.	(1-2 catchers) \$48.00 ea. (3-9) 42.00 ea. (10+) 38.00 ea.	
82905A/B	92154P	Print head. Reliable and user installable. Average life is 50 to 100 million characters.	\$109.00 ea.	
82906A	92154N	Print head. User installable. Average life is 50 to 100 million characters.	\$141.00 ea.	
Miscellaneous supplies	92231A	12-Channel VFU tape punch. Will punch either six or eight lines-per-inch control tapes. Splicing easy with precision registration pins and hold-down arms on punch. Bidirectional control knob moves tape easily through punch.	\$225.00 ea.	
	92231B	Paper perforator tape. Box of 28 Rolls. (Supersedes 9280-0063.) Oiled gray paper tape, 25.4mm (1 in.) Each roll 305m (1000 ft.) long.	(1 box) \$93.00 ea. (2-4) 81.00 ea. (5-9) 75.00 ea. (10+) 73.00 ea.	
	92193T	Platen Cleaner Pak™ for all impact printers. Reduces service calls and paper jams by eliminating paper slippage.	(1 box of 10) \$16.00 ea. (2-5) 14.00 ea. (6+) 11.00 ea.	

Thermal paper for HP computers (see paper styles below)

	Product number	Description	Measurements	Unit of Measure	Price
COMPUTERS/ CALCULATORS 85	82931A	Continuous roll Blue print	108mm (4.25 in.) width 122m (400 ft.) roll length	Box of 2 rolls	(1-4 boxes) \$30.50 ea. (5+) 26.50 ea.
	82954A	Continuous roll Black print	106mm (4.25 in.) width 122m (400 ft.) roll length	Box of 2 rolls	(1-4 boxes) \$30.50 ea. (5+) 26.50 ea.
125A/B Touchscreen (HP 150)			See 92160A/B thermal paper below.		
9000 Model 520	9270-0640	Fanfold pack Black print U.S. dimensioned	218mm (8.5 in.) width 279mm (11 in.) length 330 sheets per pack	Box of 4 packs	(1 box) \$96.00 ea. (2-5) 67.00 ea. (6+) 84.00 ea.
	9270-0642*	Fanfold pack Black print Metric dimensioned	211mm (8.27 in.) width 297mm (11.69 in.) length 330 sheets per pack	Box of 4 packs	(1 box) \$96.00 ea. (2-5) 87.00 ea. (6+) 84.00 ea.
9810A 9820A 9821A 5150A	9281-0401	Continuous roll Blue print	57mm (2.25 in.) width 76m (250 ft.) roll length	Box of 5 rolls	(1 box) \$24.00 ea. (2-4) 22.00 ea. (5-19) 21.00 ea. (20+) 17.00 ea.
9815A/S 9825A/B/S/T 9835A/B	9270-0479	Continuous roll Blue print	57mm (2.25 in.) width 76m (250 ft.) roll length	Box of 6 rolls	(1 box) \$32.50 ea. (2-4) 30.50 ea. (5-19) 27.50 ea. (20+) 25.50 ea.
	9270-0664	Continuous roll Black print	57mm (2.25 in.) width 76m (250 ft.) roll length	Box of 5 rolls	(1 box) \$32.50 ea. (2-4) 30.50 ea. (5-19) 27.50 ea. (20+) 25.50 ea.
9845A/B/C/S/T	92161E	Page-perforated roll. Black print. High-contrast. U.S. dimensioned.	216mm (8.5 in.) width 279mm (11 in.) length 61m (200 ft.) roll length	Box of 6 rolls	(1 box) \$88.00 ea. (2-5) 94.50 ea. (6+) 91.00 ea.
	92161N*	Continuous roll. Blue print. High-contrast. Metric dimensioned.	216mm (8.27 in.) width 60m (197 ft.) roll length	Box of 6 rolls	(1 box) \$73.50 ea. (2-5) 71.50 ea. (6+) 69.50 ea.
	92161P*	Continuous roll. Black print. High-contrast. Metric dimensioned.	216mm (8.27 in.) width 60m (197 ft.) roll length	Box of 6 rolls	(1 box) \$73.50 ea. (2-5) 71.50 ea. (6+) 69.50 ea.
	92161R*	Page-perforated roll. Black print. High-contrast. Metric dimensioned. Horizontal perforation only	216mm (8.27 in.) width 297mm (11.69 in.) length 60m (197 ft.) roll length	Box of 5 rolls	(1 box) \$98.00 ea. (2-5) 94.50 ea. (6+) 91.00 ea.
PRINTERS/ CALCULATORS 2671A 2671G 2673A 2674A	92160A	Continuous roll Blue print U.S. dimensioned	216mm (8.5 in.) width 50.5m (166 ft.) roll length	Box of 24 rolls	(1-2 boxes) \$131.00 ea. (3-23) 121.00 ea. (24+) 116.00 ea.
	92160B	Continuous roll Black print U.S. dimensioned	216mm (8.5 in.) width 30.5m (100 ft.) roll length	Box of 24 rolls	(1-2 boxes) \$131.00 ea. (3-23) 121.00 ea. (24+) 116.00 ea.
	92160M	Fanfold pack Blue print U.S. dimensioned	216mm (8.5 in.) width 279mm (11 in.) length 330 sheets per pack	Box of 4 packs	(1 box) \$98.00 ea. (2-5) 89.00 ea. (6+) 86.00 ea.
	92160N	Fanfold pack Black print U.S. dimensioned	216mm (8.5 in.) width 279mm (11 in.) length 330 sheets per pack	Box of 4 packs	(1 box) \$98.00 ea. (2-5) 89.00 ea. (6+) 86.00 ea.
7240A 7245B	9270-0607*	Page-perforated roll Black print Metric dimensioned	241mm (9.5 in.) width outside perforation 210mm (8.27 in.) width inside perforation 298.5mm (11.75 in.) length, 61m (200 ft.) roll length	Box of 2 rolls	(1-5 boxes) \$43.00 ea. (6-35) 41.50 ea. (36+) 39.50 ea.
	9270-0605	Page-perforated roll Black print U.S. dimensioned	241mm (9.5 in.) width outside perforation 216mm (8.5 in.) width inside perforation 279mm (11 in.) length, 61m (200 ft.) roll length	Box of 2 rolls	(1-5 boxes) \$43.50 ea. (6-35) 41.50 ea. (36+) 39.50 ea.
7310A	9270-0680*	Continuous roll Black print Metric dimensioned	210mm (8.27 in.) width 75m (246 ft.) roll length	Box of 6 rolls	(1-4 boxes) \$131.00 ea. (5-29) 125.00 ea. (30+) 119.00 ea.
	9270-0682	Continuous roll Black print U.S. dimensioned	216mm (8.5 in.) width 75m (246 ft.) roll length	Box of 5 rolls	(1-4 boxes) \$131.00 ea. (5-29) 125.00 ea. (30+) 119.00 ea.
97A, 82143A, 82162A	82045A	Continuous roll. Blue print	57mm (2.25 in.) width, 24m (80 ft.) roll length	Box of 6 rolls	\$12.00 ea.
82143A, 82162A, 18C	82175A	Continuous roll. Black print	57mm (2.25 in.) width, 24m (80 ft.) roll length	Box of 6 rolls	\$12.00 ea.
9866A/B HP 12996 Subsystem	9270-0488	Continuous roll Black print	222mm (8.75 in.) width 76m (250 ft.) roll length	Box of 6 rolls	(1 box) \$93.00 ea. (2-4) 85.00 ea. (5-19) 76.00 ea. (20+) 70.00 ea.
9876A	See 9270-0640, 9270-0642, and 9270-0643 thermal paper above.				
TERMINALS 262X, 2675A	See 92160A/B thermal paper above.				
3075A, 3076A, 3077A	See 82045A and 82175A thermal paper above.				

*These metric papers are in inventory in our European warehouse. For faster delivery, U.S. customers should order from their local HP Sales Office.

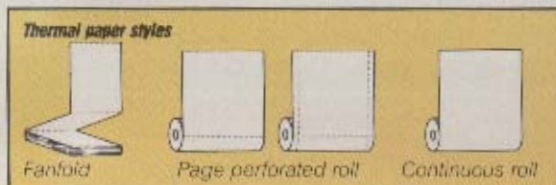

PLOTTERS

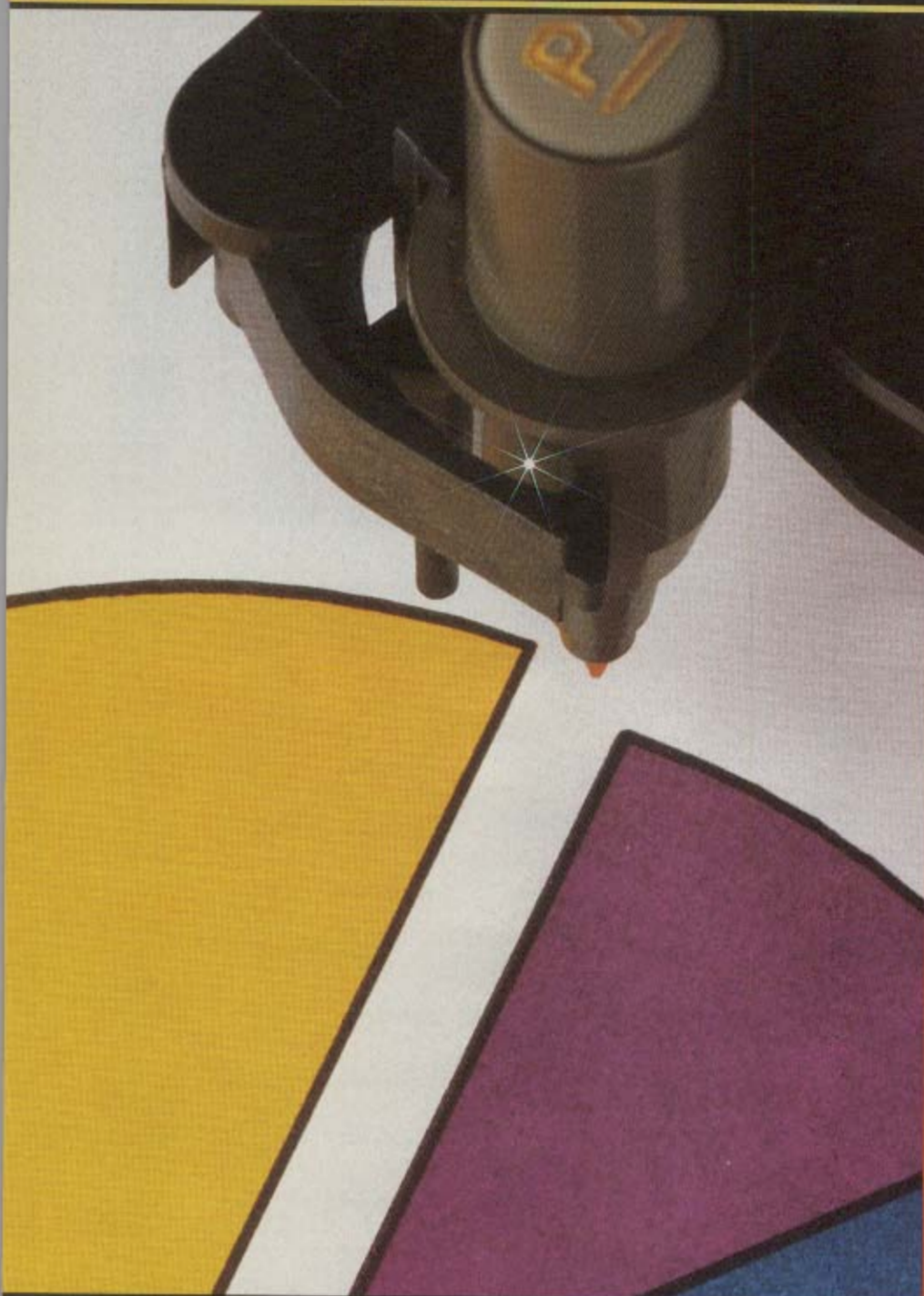

HP graphics plotters—their technological excellence is evident in the color graphics they produce—charts with evenly aligned edges, smooth curves, brilliant colors. These results are possible because HP pens and media are designed to work specifically with HP plotters. Discover our complete line of supplies in this section.

Plotter media	50
Plotter pens	54
Drafting pens	56
Plotter Sound Enclosure ..	59
Plotter organizers, accessories	60
HP ColorPro 7440A Graphics Plotter	62
HP 7475A Graphics Plotter	63

HP supplies make the difference

HP plotters, like other HP equipment, run best when they're supported by genuine HP supplies. From refillable pens to the plotter sound enclosure, each plotter supply goes through a comprehensive development phase with a group of engineers dedicated to producing superior products. The commitment to that kind of

rigorous testing has repeatedly proven itself with a reputation for quality plots for both visual and print presentations. Let HP plotter supplies make the most of your HP plotter. We guarantee you'll see the difference.



You've made a sound investment in an HP plotter—now don't use anything less than HP supplies to get the finest results!

Are your supplies where you want, when you want them?



7475A graphics organizer features an easy-access drawer with convenient slots for carousels, paper, pens and other supplies. (Supplies shown in photo are not included.)

HP plotter users: Say goodbye to desktop plotter clutter with HP's Graphics Organizer.

Space-saving. Using your Graphics Organizer as a stand for your 7550, 7475A, or ColorPro Plotter gives you convenient drawer space underneath, so plotter supplies stay out of sight until needed. Lined with a cushion of high-density foam, the easy-access drawer has specially sized compartments to separate and protect supplies.

Everything in place. The specially designed media compartment keeps your standard paper, glossy plotter paper, and transparency film ready for use. Additional compartments hold your pens and carousels. There's even room for odds and ends—pencils, paper clips, scratch pads, etc.

HP's Graphics Organizer is constructed of tough acrylic plastic, in translucent gray to complement your HP plotter.

92177X 7475A Graphics Organizer. Exterior dimensions: 95 H x 597 W x 375 D mm (3.75 H x 23.5 W x 14.75 D in.) \$179.00 ea.

92177W ColorPro Graphics Organizer. Exterior dimensions: 95 H x 476 W x 349 D mm (3.75 H x 18.75 W x 13.75 D in.) \$119.00 ea.

92177Y 7550A Graphics Organizer. Exterior dimensions: 157 H x 673 W x 456 D mm (6.19 H x 26.50 W x 17.94 D in.) \$229.00 ea.



Choose the right paper and film for your pens

Use HP media for top-quality graphics. Pen life and plot quality are dependent on matching the pens with the media. Therefore, we manufacture our own pens and select our media carefully.

Using HP pens and media assures you of:

- Low abrasion paper matched to our pen tips and ink combinations for increased pen life.
- Smooth surface for consistent lines.

- Paper fiber content and type strictly specified to prevent fibers from pulling ink outside of trace.
- No watermarks on paper to interfere with pen writing.

Whether your application is drafting or business, HP has the solution you need. For your business graphics needs, try our:

- **Plotter Paper** for vivid, professional-looking graphics that will impress your clients and superiors.
- **Transparency Plotter Film** for high quality projected graphics. Excellent for use on overhead projectors at meetings and presentations.
- **Plotter Paper** that's ideal for your everyday graphics needs including preliminary drawings in drafting applications.

For your drafting applications, try our:

- **Polyester Film** for your final-quality, diazo-reproducible, and permanent storage needs.
- **Vellum** for your final-quality, diazo-reproducible needs.
- **Tracing Bond** for your preliminary drawing, and diazo-reproducible review copies.

See the difference HP paper makes

The comparison photos below were made using the American Optical System at 18.75 magnification. The plots were made on a 7470A Plotter at 20 cm/s with a .3mm blue pen. Notice how the HP paper's smooth surface enhances line definition, and minimizes skipping, bleeding and feathering.

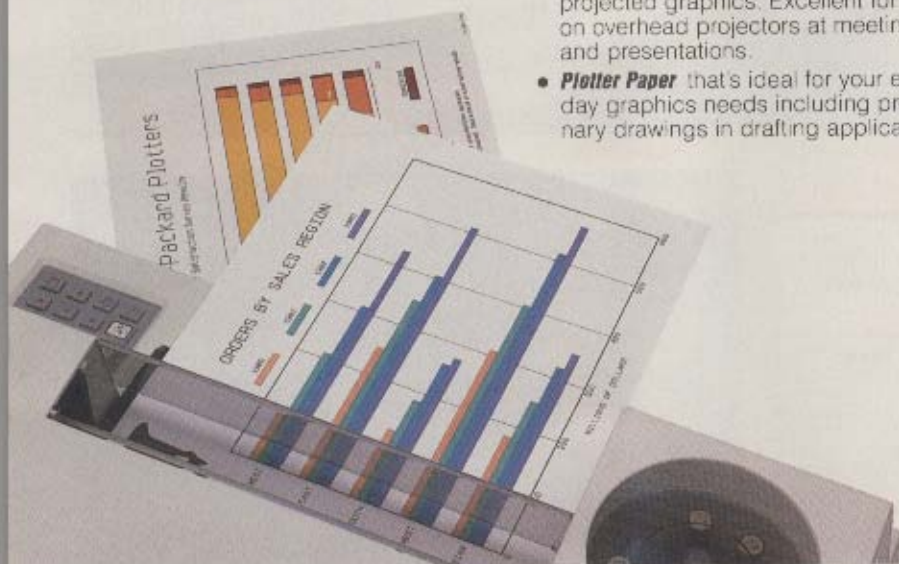

Copier paper



HP paper

Plotter Paper

HP's strict specifications require this paper to be an opaque medium with the correct mixture of wood pulp and rag fibers. This provides the correct smoothness for clear line definition and minimizes skipping, bleeding and feathering. Use with HP paper pens, rollerball pens and disposable drafting pens. It's inexpensive, easy-to-handle and perfect for everyday use.



For automatic sheet-feed plotting, see the HP 7550A media catcher tray on page 60.

Media Size	Qty./pkg.	Product no.	Price	
English A	50 sheets	17800P	(1-4) ... \$ 5.50 ea.	
			(5-30) ... 4.95 ea.	
			(31+) ... 4.40 ea.	
	250 sheets	17801P	(1-) ... 13.00 ea.	
B	50 sheets	17804P	\$ 10.00 ea.	
	250 sheets	17805P	26.00 ea.	
C	250 sheets	9280-0728	\$ 41.00 ea.	
D	200 sheets	9280-0527	\$ 60.00 ea.	
E	150 sheets	9280-0587	\$ 85.00 ea.	
Metric A4	50 sheets	17802P	\$ 5.50 ea.	
		17803P	13.00 ea.	
	A3	50 sheets	17806P	\$ 10.00 ea.
		250 sheets	17807P	26.00 ea.
	A2	250 sheets	9280-0734	\$ 41.00 ea.
	A1	200 sheets	9280-0528	\$ 60.00 ea.
A0	150 sheets	9280-0590	\$ 85.00 ea.	
Roll	24 in. x 150 ft.	1 roll	9280-0638	\$ 26.00 ea.
	36 in. x 150 ft.	1 roll	9280-0637	\$ 36.00 ea.
Architectural	Arch. C	200 sheets	9280-0754	\$ 40.00 ea.
	Arch. D*	200 sheets	9280-0759	\$ 66.00 ea.
	30 in. x 42 in.	200 sheets	9280-0752	\$ 95.00 ea.
	Arch. E	200 sheets	9280-0751	\$124.00 ea.

D-size architectural media is not recommended on the DraftPro plotter with software programs that do scaling.

Great-looking plots that give you the advantage

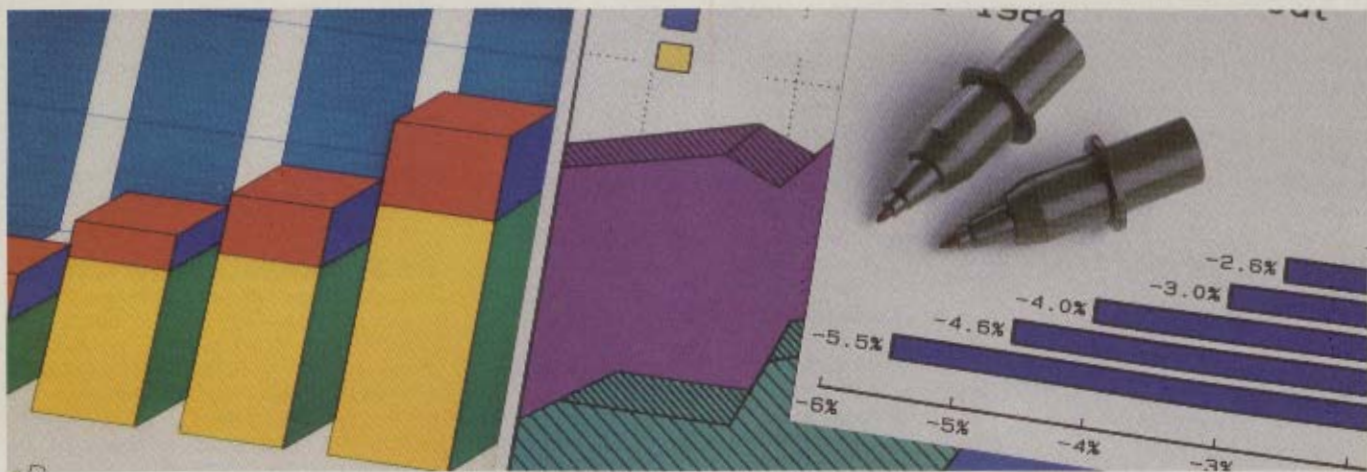

Transparency Plotter Film

Make your presentations stand out from the rest with HP's eye-catching colors and transparency film. Our fast-drying film lets ink dry quickly, minimizing bleeding and smearing. Use with HP transparency plotter pens.

Plotter	Media size*	Qty./pkg.	Product no.	Price
ColorPro (7440), 7470	A English	50 sheets	17700T	(1-9) \$50.00 ea.
				(10-49) 45.00 ea.
				(50-99) 40.00 ea.
				(100-500) 37.50 ea.
				(501+) 32.50 ea.
7475, 7550, DraftMaster, 7090, 7220, 7221, 7225, and 9872	A4 Metric	50 sheets	17701T	(1-9) \$50.00 ea.
				(10-49) 45.00 ea.
				(50-99) 40.00 ea.
				(100-500) 37.50 ea.
				(501+) 32.50 ea.
	A English	50 sheets	17702T	(1-9) \$50.00 ea.
				(10-49) 45.00 ea.
				(50-99) 40.00 ea.
				(100-500) 37.50 ea.
				(501+) 32.50 ea.
	A4 Metric	50 sheets	17703T	(1-9) \$50.00 ea.
				(10-49) 45.00 ea.
				(50-99) 40.00 ea.
				(100-500) 37.50 ea.
				(501+) 32.50 ea.



HELPFUL IDEA!

Visual presentations are always stronger

Whether you're speaking to a small or large audience, overheads take minimal time to prepare. Consider these tips when creating your next visual presentation:



- Make sure your presentation has a clear theme.
- Keep your message simple.
- Use color for special emphasis.
- Use ample slides to illustrate key points.
- Keep your formats consistent.
- Be sure everything can be easily recognized by your audience.

Glossy Plotter Paper

Impress your clients and your boss at your next meeting with reports and handouts containing high quality crisp graphics. HP's heavyweight, gloss-finish plotter paper provides the capability for producing professional looking reports. Use with HP paper pens to produce lighter shades of color and with transparency pens to produce darker shades. Use glossy plotter paper for bar code paper applications.

Media size*	Qty./pkg.	Product no.	Price
English	A	17900G	(1-9) \$16.00 ea.
			(10+) 14.40 ea.
Metric	A4	17901G \$29.00 ea.
			A3

*See media size guide on page 50 for further information.

HP drafting media—quality you can trust!

Tracing Bond

This lightweight Tracing Bond performs at its best when used with rollerball pens.

Tracing Bond is an uncoated, untreated and economical alternative to vellum. Use it when you need:

- Fast plotting capability of rollerballs (60cm/sec)
- Consistent line width
- Diazo-reproducible plots
- Low-abrasion media
- Check plots and preliminary drawings, not for high quality final plots

Media Size	Qty./pkg.	Product no.	Price
English	D	150 sheets	9280-0600 \$100.00 ea.
	E	150 sheets	9280-0598 \$190.00 ea.
Metric	A1	150 sheets	9280-0599 \$100.00 ea.
	A0	150 sheets	9280-0597 \$190.00 ea.

Vellum

This 100% rag vellum provides optimum performance with refillable and disposable drafting-style pens.

HP vellum has a surface coating for increased smoothness and ink receptivity. It is also treated to add strength and transparency. Use this vellum when you need:

- Relatively permanent documents
- Less expensive media than polyester film
- Diazo reproducible media

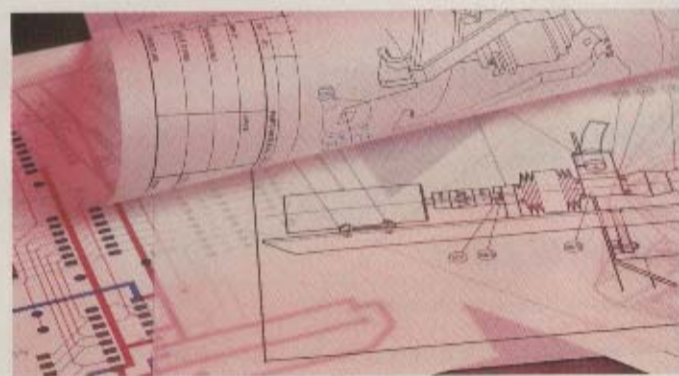

Media Size	Qty./pkg.	Product no.	Price
English	A	150 sheets	9280-0601 \$ 17.00 ea.
	B	150 sheets	9280-0602 \$ 30.00 ea.
	C	250 sheets	9280-0731 \$ 85.00 ea.
	D	150 sheets	9280-0529 \$130.00 ea.
	E	150 sheets	9280-0593 \$200.00 ea.
Metric	A4	150 sheets	9280-0603 \$ 17.00 ea.
	A3	150 sheets	9280-0604 \$ 30.00 ea.
	A2	250 sheets	9280-0733 \$ 85.00 ea.
	A1	150 sheets	9280-0530 \$130.00 ea.
	A0	150 sheets	9280-0594 \$200.00 ea.
	Roll	24in. x 150ft.	1 roll
36in. x 150ft.		1 roll	9280-0636 \$ 75.00 ea.
Architectural	Arch. C	150 sheets	9280-0753 \$ 76.00 ea.
	Arch. D*	150 sheets	9280-0756 \$143.00 ea.
	—	150 sheets	9280-0749 \$190.00 ea.
	Arch. E	150 sheets	9280-0750 \$264.00 ea.

Polyester film

HP's double-matte, 3-mil film was specifically chosen to provide optimum performance when used with HP's refillable and disposable drafting pens.

This finely coated, translucent media minimizes pen and machine wear and maximizes line quality. Use this film when you need:

- Dimensionally stable media
- Close tolerance, high-accuracy plots
- Camera-ready art
- Master copies which will be handled repeatedly
- Media that will not tear, crack, peel or fade under normal use
- Clear and sharp quality reproductions
- Plots with distinct continuous lines and virtually no beading, bleeding or feathering

Media Size	Qty./pkg.	Product no.	Price
English	A	50 sheets	9280-0605 \$ 20.00 ea.
	B	50 sheets	9280-0607 \$ 32.00 ea.
	C	100 sheets	9280-0732 \$110.00 ea.
	D	50 sheets	9280-0526 \$122.00 ea.
	E	50 sheets	9280-0591 \$220.00 ea.
Metric	A4	50 sheets	9280-0608 \$ 20.00 ea.
	A3	50 sheets	9280-0606 \$ 32.00 ea.
	A2	100 sheets	9280-0730 \$110.00 ea.
	A1	50 sheets	9280-0525 \$122.00 ea.
	A0	50 sheets	9280-0592 \$220.00 ea.
Roll	24in. x 150ft	1 roll	9280-0634 \$130.00 ea.
	36in. x 150ft	1 roll	9280-0633 \$182.00 ea.
Architectural	Arch. C	50 sheets	9280-0758 \$ 69.00 ea.
	Arch. D*	50 sheets	9280-0757 \$135.00 ea.
	30 in. x 42 in.	50 sheets	9280-0748 \$200.00 ea.
	Arch. E	50 sheets	9280-0755 \$250.00 ea.

HELPFUL IDEAS!

Reduce static buildup on drafting film. Statically charged film attracts dust particles which clog pen tips and cause ink blots. To reduce the problem, lower the pen speed, increase the humidity around the plotter, or use vellum for your draft copies.

*"D"-size architectural media is not recommended on the DraftPro plotter with software programs that do scaling.

More colors for your graphics

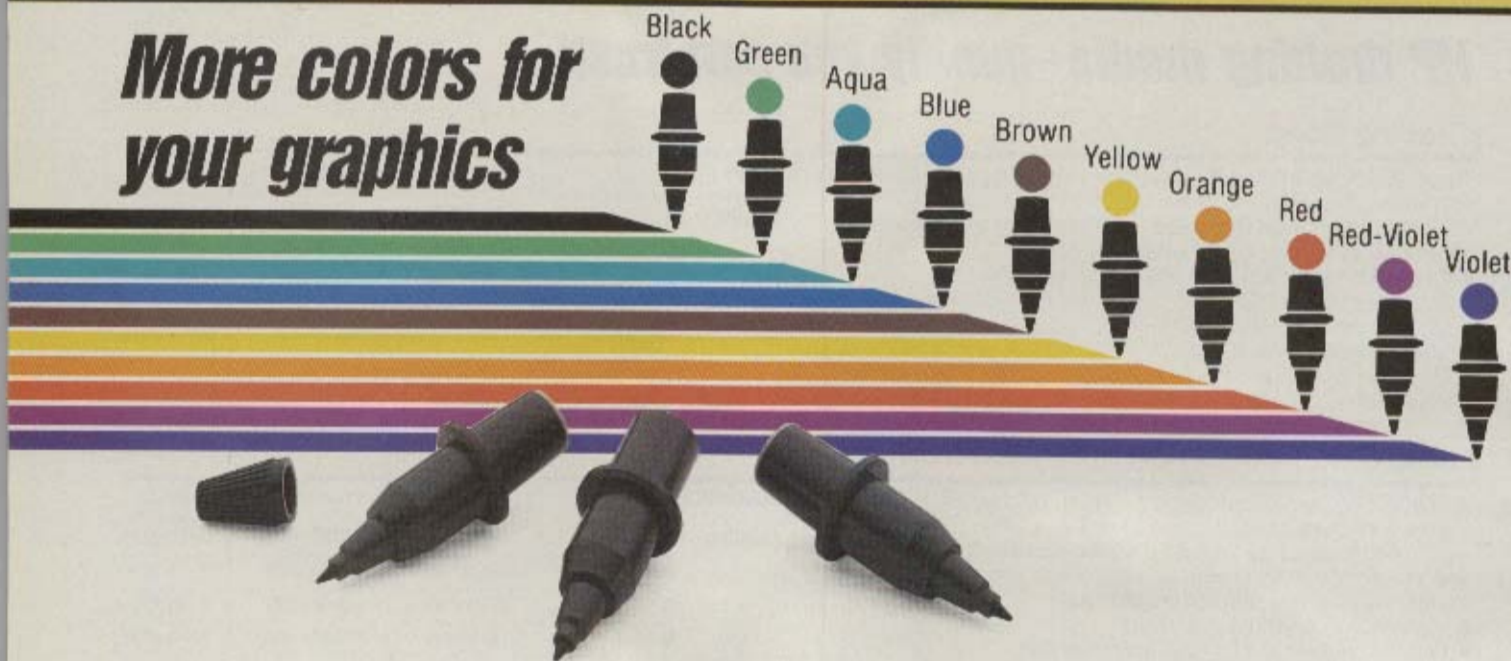

A rainbow of colorful pens and media to match give personality to your presentations!

The vibrance of violet, the brilliance of blue, the radiance of red and many more majestic colors are at your fingertips with HP's variety of plotter pens. Filling your presentations with the polish of color shows creativity, and a conscious effort to make your work stand out.

10 attractive colors

Give your hardcopy graphics that extra professional edge with HP's family of matching paper and transparency pen colors. Carefully chosen to work together harmoniously, all 10 colors are available in both narrow and wide line widths.

High quality ink formulations for long pen life

HP's paper and transparency pens provide optimum density and color consistency, with maximum writing distance.

Customize orders with single color packs

Choose just the colors you want. Select from all 10 colors in narrow-line width and four colors in wide-line width to order single-color packs of your own choice.

Total writing system

HP pens, media and plotters are designed to work together for optimum results. Use our compatibility guides to choose the best complement of supplies for your plotter and application.

HELPFUL IDEA!

Capture them with color!

- **Use color to differentiate.** Be bold and choose colors with high contrast to help your audience make comparisons.
- **Use color to emphasize.** Draw attention to that important statistic or issue with a unique use of color.
- **Use color to identify.** Make your charts easy to understand by using color to visually portray parallel levels of information.
- **Use color wisely.** Too much color can distract your audience from your important message. We recommend to use no more than five colors for charts with graphs. For text only, stick with the attractive simplicity of black plus one other color.

International pen carousel systems

Below you'll find HP's six pen types and their corresponding international pen symbols. A symbol appears on the top of pen carousels, so it's easy for you to make the right match.



Paper Transparency Rollerball Refillable Disposable Veltum Disposable Polyester Film



Steal the show with HP's dazzling pen colors

Make your next presentation shine with HP's family of matching paper and transparency pen colors. Choose from 10 beautiful, professional-looking colors—each guaranteed to give your graphics plenty of audience appeal. These fiber-tip pens are especially suited to area-fill applications.

Fiber-tip paper pens

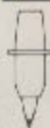

For use with 7090, 7220, 7221, 7225, ColorPro (7440), 7470, 7475, 7550, DraftPro (7570), DraftMaster, 7580, 7585, 7586, and 9872 Graphics Plotters.

Color selection

The fiber-tip paper pens at left and the fiber-tip transparency pens at right are both available in the colors shown below.

Fiber-tip transparency pens

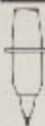

For use with HP 7090, 7220, 7221, 7225, 7470, 7475, 7550, ColorPro (7440), DraftMaster and 9872 Graphics Plotters.

P3 Narrow line (0.3 mm) HP part no.	P7 Wide line (0.7 mm) HP part no.	Single-color packages (5 pens/package)	T.3 Narrow line (0.3 mm) HP part no.	T6 Wide line (0.6 mm) HP part no.
17825P	17826P	Black	17725T	17726T
17827P	17828P	Green	17727T	17728T
17829P	—	Aqua	17729T	—
17831P	17832P	Blue	17731T	17732T
17833P	—	Violet	17733T	—
17835P	—	Brown	17735T	—
17837P	—	Yellow	17737T	—
17839P	—	Orange	17739T	—
17841P	17842P	Red	17741T	17742T
17843P	—	Red-Violet	17743T	—

P3 Narrow line (0.3 mm) HP part no.	P7 Wide line (0.7 mm) HP part no.	Multi-color packages (1 pen in each color, 5 pens/package)	T.3 Narrow line (0.3 mm) HP part no.	T6 Wide line (0.6 mm) HP part no.
17845P	17846P	Black Blue Red Green Yellow	17745T	17746T
17847P	17848P	Black Blue Aqua Violet Green	17747T	17748T
17849P	17850P	Brown Yellow Orange Red Red-Violet	17749T	17750T

(1-4 pkgs) \$7.00 pkg. (25-100) 5.60 pkg. (151+) 4.90 pkg.
 (5-24) 6.30 pkg. (101-150) 5.25 pkg. Price breaks apply to purchase of single part numbers only.

Pen and Plotter compatibility (Use the guide below to select the pens best suited to your plotter.)

Plotter model no.	Fiber-tip pens		Disposable drafting pens	Refillable drafting pens		Rollerball pens
	Paper	Transparency	Long body	Short body	Long body	Long body
7220, 7221, 9872	•	•		•		
7225	•	•				
ColorPro 7220, 7470, 7090	•	•				
7475	•	•		•		
7550, DraftMaster	•	•	•		•	•
DraftPro	•		•		•	
7580, 7585, 7586	•		•		•	•

HP drafting pens— the choice that makes the difference!

Choose from HP's selection of disposable, refillable and rollerball pens. The right pens make all the difference in output quality.

Long body drafting pen comparison guide

Use the guide below to select the long body drafting pen features best suited for your application.

Plotter	Drafting pen	Paper	Media		Recommended plotting speed	Available line widths	Pen cleaning required
			Willum	Polyester Film			
7550/DraftPro	Disposable	•	•	•	20cm/sec	4	No
758X*/DraftMaster	Disposable	•	•	•	30cm/sec	4	No
7550/758X*/DraftPro	Refillable	•	•	•	15cm/sec	6	Yes
DraftMaster	Refillable	•	•	•	30cm/sec	6	Yes

*Includes HP 7560A/B, HP 7586A/B, and HP 7586B Drafting Plotters.

Drafting pen carousels

Let the carousels do the work

There's more to choosing a pen for your plotter than meets the eye. That's why HP has developed drafting pen carousels that automatically determine the proper pen speed and force to meet your various plotting needs. Additionally, if you wish to experiment with different pen speeds and forces, most HP plotters feature a manual setting option. See page 61 for part numbers.

Give your plotter pens the boot

Keep your pens in peak performance, by capping them with HP's rubber boots to prevent dryness of tips. Different boots fit different pens, so refer to the listings to find the proper boot. Once you have your boots, keep them in good condition by cleaning them with a damp cotton swab to remove ink and dust. See page 61 if you need new boots.

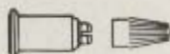

Adopt our adapters

You won't be able to use your refillable or disposable drafting pens without this important part that connects your pen to the plotter's carousel. Our adapters include a pen cap, and are sold separately from drafting pens.

5061-7578 Package of four adapters and pen cap assemblies \$8.00 pkg.

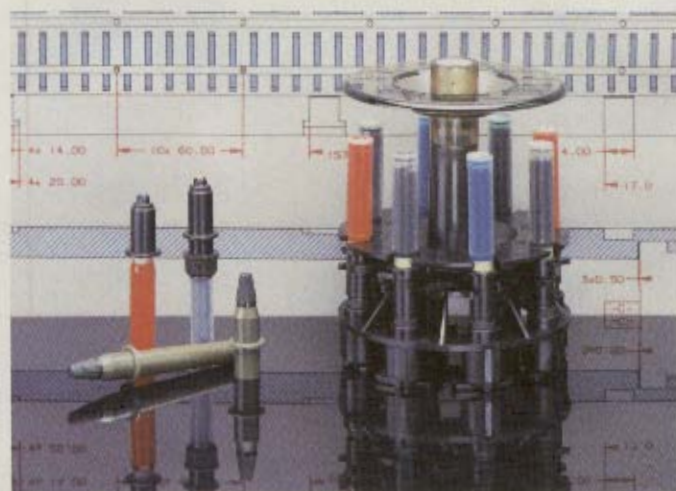

HELPFUL IDEA!

Weather warning

Did you know the climate of your work environment—warm or cold—can affect your plotting paper? To prevent distortions in your plots, remove plotting paper from the package and expose it to air for about 15 minutes before you're ready to plot. You'll have fresh paper that's prepared to receive your plot with no variations.

We ship same day

CALL HP DIRECT
800-538-8787

Call us with your Purchase Orders or



Throw away the fuss and muss with our disposable pens

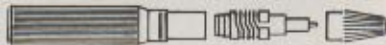





Now it's easy to produce picture-perfect drawings in no time with HP's waterproof and fade-resistant disposable drafting pens. These liquid-ink pens have streamlined plotting by eliminating time-consuming cleaning and refilling. Better yet, they're simple to use. Just insert the pen tip into the pre-filled ink reservoir, screw on an adapter, shake the pens and you're ready to produce plots with quality color and consistent lines. Designed for use on **HP 7550A, DraftPro, DraftMaster** and other **758X** plotters, this line of pens can produce final-quality drawings on polyester film or vellum and preliminary-quality drawings on plotter paper.

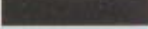

Vellum/Paper Disposable Drafting Pens

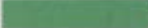
Use HP's disposable drafting pens on vellum to produce final-quality, copier- and diazo-reproducible drawings. Or, use them on plotter paper to produce preliminary-quality drawings.

V.35 Fine line (Point size 0.35mm*) product no.	Single-Color Packages (4 pens/pkg.)* Reusable adapters (5061-7578) are required for operation.	V.70 Broad line (Point size 0.70mm*) product no.
5061-7562	Black 	5061-7572
5061-7563	Blue 	5061-7573
5061-7564	Green 	5061-7574
5061-7565	Red 	5061-7575

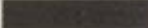
V.25 Extra fine line (Point size 0.25mm*) product no.	Single-Color Packages (4 pens/pkg.)* Reusable adapters (5061-7578) are required for operation.	V.50 Medium line (Point size 0.50mm*) product no.
5061-7619	Black 	5061-7620

(1-4 pkgs.) \$22.00 ea.
(5+)* 19.80 ea.

Multi-Width (Black) Package (4 pens/pkg.)* Reusable Adapters (5061-7578) are required for operation.			
V.25	Extra fine line width	Point size, 0.25mm†	5062-1556
V.35	Fine line width	Point size, 0.35mm†	
V.50	Medium line width	Point size, 0.50mm†	
V.70	Broad line width	Point size, 0.70mm†	

(1-4 pkgs.) \$25.00 ea.
(5+)* 22.50 ea.









*Line width may vary depending on media, ink, and plotting speed.

HELPFUL IDEA!

A tip for your tips

Keep your disposable and refillable drafting pens in tip-top shape by storing them vertically with the tips facing up. The upright position will prevent your tips from clogging and the result will be cleaner, sharper strokes on all your plots.

Choose black in four line widths or, choose from seven other colors. NOTE: These pens are not designed for area-fill applications, or for use on polyester film.

Multi-Color Packages (4 pens/pkg. 1 of each color)* Reusable adapters (5061-7578) are required for operation.			
	Black 		Orange
	Blue 		Brown
	Green 		Yellow
Point size	Red 		Violet
			Product No.

V.25 Extra fine line (Point size 0.25mm*)	Red/Blue/Green/Black Orange/Brown/Yellow/Violet	5062-1557
		5062-1558
V.35 Fine line (Point size 0.35mm*)	Red/Blue/Green/Black Orange/Brown/Yellow/Violet	5061-7566
		5062-1559
V.50 Medium line (Point size 0.50mm*)	Red/Blue/Green/Black Orange/Brown/Yellow/Violet	5062-1571
		5062-1572
V.70 Broad line (Point size 0.70mm*)	Red/Blue/Green/Black Orange/Brown/Yellow/Violet	5061-7576
		5062-1573

(1-4 pkgs.) \$22.00 ea.
(5+)* 19.80 ea.

Polyester Film Disposable Drafting Pens

Use HP's black disposable drafting pens on double-matte polyester film to produce final-quality, archivable, copier- and diazo-reproducible drawings. NOTE: These pens are not designed for area-fill applications.

Single-Color (Black) Packages (2 pens/pkg.)* Reusable adapters (5061-7578) are required for operation.			
F.25	Extra fine line width	Point size, 0.25mm†	5062-1592
F.35	Fine line width	Point size, 0.35mm†	5062-1593
F.50	Medium line width	Point size, 0.50mm†	5062-1594
F.70	Broad line width	Point size, 0.70mm†	5062-1595

(1-4 pkgs.) \$22.00 ea.
(5+)* 19.80 ea.

*Price breaks apply to purchase of single part numbers only.

Plot detailed, precision graphics with refillable pens



Close-up details can only look this sharp and clear by using HP's refillable drafting pens available in short or long body styles.



Refillable drafting pens

Refillable drafting pens—short body

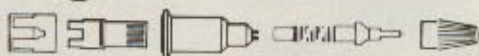

5061-8119 Drafting pen, short body. For use with HP 7220, 7221 and 9872 Plotters with plotter points listed at right. For HP 7475 Plotter, use 9300-0957, 9300-0958, 9300-0959 only. Two pen bodies, adapters, caps per package.

Price \$18.00 pkg.

Plotter points (tungsten), use with short body drafting pen. Line width may vary depending on media, ink, and plotting speed. Fine-line point sizes .18 mm and .25 mm require more cleaning and care than wider point sizes and therefore are not recommended for general use.

Part no.	Point size	Price
9300-0955	.18 mm	\$32.00 ea.
9300-0956	.25 mm	29.00 ea.
9300-0957	.35 mm	25.00 ea.
9300-0958	.50 mm	25.00 ea.
9300-0959	.70 mm	25.00 ea.
9300-0960	1.00 mm	25.00 ea.

Refillable drafting pens—long body

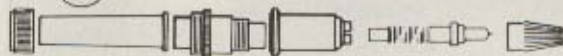

07580-60025 Drafting pen, long body. For use with your HP 7550, DraftPro, DraftMaster, 7580, 7585, and 7586 Graphics Plotters with plotter points listed at right. One pen body, adapter, cap per package.

Price \$10.50 pkg.

Plotter points (tungsten), use with long body drafting pen. Line width may vary depending on media, ink, and plotting speed. Fine line point sizes .18 mm and .25 mm require more cleaning and care than wider point sizes and therefore are not recommended for general use.

Part no.	Point size	Price
9260-0742	.18 mm	\$32.00 ea.
9260-0741	.25 mm	29.00 ea.
9260-0588	.35 mm	25.00 ea.
9260-0744	.50 mm	25.00 ea.
9260-0579	.70 mm	25.00 ea.
9260-0743	1.00 mm	25.00 ea.

Rollerball pens

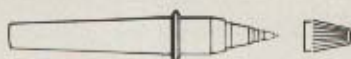

Use these pens with your **HP 7550, DraftMaster, 7580, 7585, and 7586** Plotters when you need the following features:

- fast plotting speed (60 cm/sec.)
- preliminary-drawings or check plot applications
- uniform line widths
- ease of use

We recommend you use these pens on:

- HP's blank plotter paper for single-copy needs.
- HP's tracing bond for diazo-reproducible check plots or preliminary quality drawings.

Single-color pen packages



(4 pens/pkg)



Narrow line width (.3mm)

HP Part no.	Color
5061-5034	(Red)
5061-5036	(Blue)
5061-5035	(Green)
5061-5033	(Black)

Multi-color pen packages



(4 pens/pkg)



Narrow line width (.3mm)

HP Part no.	Color
5061-5037	(Red)
	(Blue)
	(Green)
	(Black)

(1-4 pkgs) \$14.00 pkg.
(5+) 13.00 pkg.

Price breaks apply to purchase of single part numbers only

Plot color presentations from your Macintosh with Plotstart

Start plotting multi-color business presentations, straight from your Apple® Macintosh®! This high-performance disc-based driver works with Macintosh applications and the HP ColorPro, HP 7475A and HP 7550A plotters. Result? You plot drawings, charts and graphs, as easily as you print!

No more bargaining with your art department...no more rush charges from outside graphics services. Now you can have top-rate plotting, without giving up the familiarity of your 128K Mac, 512K Mac, Mac XL or MacPlus!

35184B Plotstart \$125.00 ea.

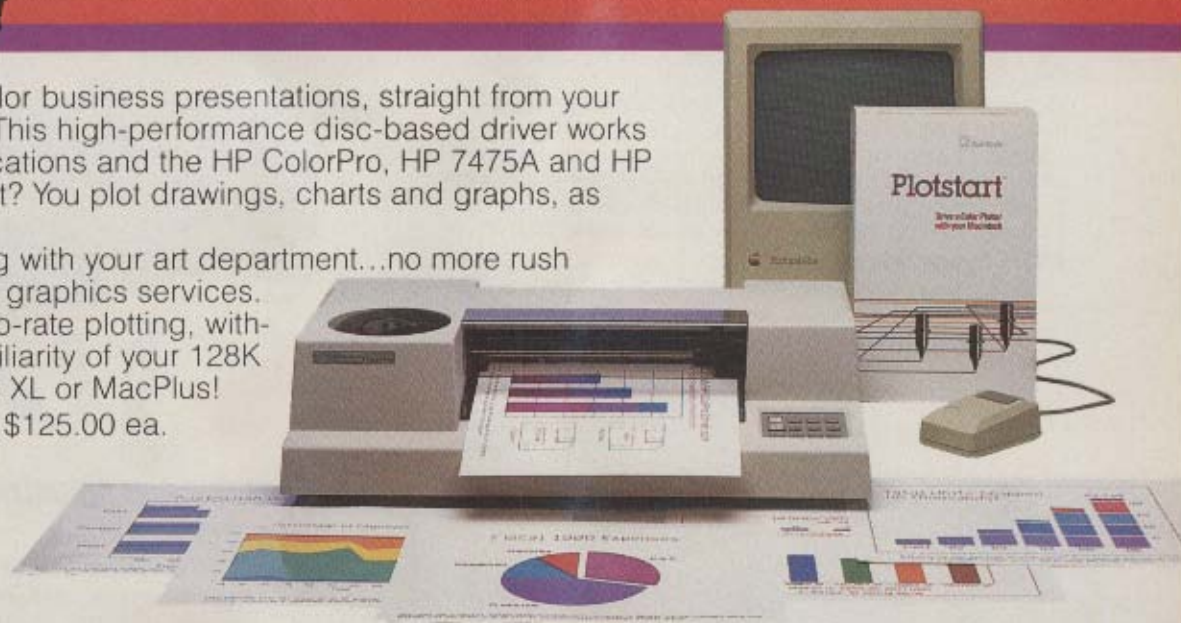

Plotstart lets you:

- MacDraw® that presentation cover, then plot it out in colors that captivate.
- Lotus® Jazz® your monthly report, then plot it out in colors that clarify.
- Microsoft® Chart™ your new organization, then plot it out in colors that correspond.

Available on 3.5-in. disc. Standard ImageWriter I type cable (DB-9 to DB-25) included.* Support provided by Softstyle®.

*In addition, the Macintosh Plus requires a DIN-8 to DB-9 adapter cable (Apple part no. 699-0372), and the HP 7550A plotter requires an RS-232C gender converter (DB-25) (HP part no. 92224F). The Macintosh XL requires a standard RS-232C printer cable instead of the one provided.

Lower the lid on plotter noise!

Do you have sensitive ears? Our all-new Plotter sound enclosure reduces the sound of your HP 7470, 7475 or ColorPro plotter by as much as 90 percent, to as low as 53.4 decibels. Your plotter becomes as quiet as a murmur... less intrusive than the sound of computer keyboarding. It's a wonderful way to improve office productivity.

The most functionality you'll find in a sound enclosure An intelligent design negates the need for an annoying cooling fan. It's constructed of sound-reducing particle board, with foam lining to absorb plotter vibrations. A foam plug can be removed to accommodate B/A3-size plotter paper, then re-inserted for further sound reduction. And the durable acrylic lid is attached by spring-loaded hinges for effortless opening and closing. Dimensions are 12 in. (305 mm) H x 25.8 in. (655 mm) W x 19.5 in. (495 mm) D; stand measures 3.9 in. (100 mm) H.

Extra protection for your plotter This Plotter sound enclosure protects your plotter investment, too. It's a shield against dust, spills and environmental contaminants—just as it shields you from unwanted noise.

Designed to complement your HP equipment This Plotter sound enclosure is designed to coordinate with Design Plus furniture. What's more, its design allows space for our 92177W/X Graphics organizer underneath for additional convenience (see page 49).



92166E Plotter sound enclosure \$249.00

Spend your time plotting, not looking for pens!

Space-saving pen organizer for your desk

Our new personal pen organizer keeps your plotter pens organized and within easy reach. Made of acrylic, this organizer looks attractive on your desk and also fits conveniently in a desk drawer.

Up to 33 paper writing pens, overhead transparency pens or short-body drafting pens are stored vertically for easy identification. Take advantage of our quantity discounts and order a personal pen organizer for every plotter user in your office.

- 92177V Personal pen organizer** (1-2) \$34.75 ea.
 (3-9) \$31.75 ea.
 (10+) \$29.50 ea.

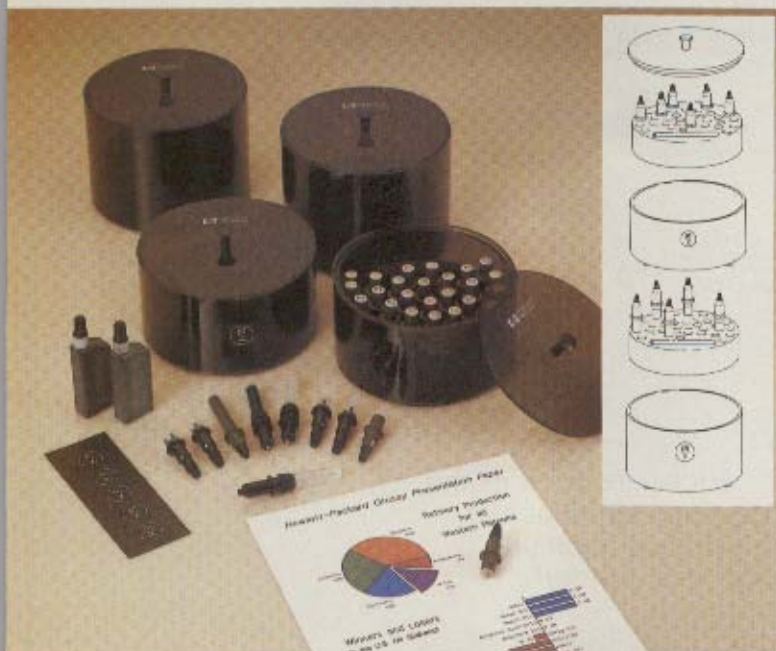

Space-saving pen organizers for your graphics workstation

Now—an elegant, yet practical solution for plotter pen storage. Our 6-inch (15 cm) diameter modular pen organizer stores up to 30 pens—60 when stacked.

As you add pens—fiber-tip, drafting, or rollerball—the modular units can be stacked to save valuable desktop space. And custom labels, with HP's international pen symbols, allow you to quickly identify the contents.

We offer two sizes (for short and long plotter pens), which can be mixed and matched according to your needs.

Pens are stored vertically for easy reach and are held securely by high-density foam. Made of sturdy acrylic plastic, the pen organizers are an attractive addition to any office setting.

- 92177T Short organizer** (1) \$43.75 ea.
 (2-3) 39.75 ea.
 (4+) 37.25 ea.
- 92177U Long organizer** (1) \$46.75 ea.
 (2-3) 43.50 ea.
 (4+) 41.25 ea.

HP's 6-inch diameter modular workstation organizer stores up to 30 plotter pens—60 when stacked!

7550A Media handling accessories

For use with HP's 7550A Graphics Plotter—the automatic sheet feed plotter for unattended operation of cut paper sheets.

Description	HP part no.	Price
A-size media loading tray	17561A	\$100.00
A4-size media loading tray	17562A	\$100.00
A/A4-size media catcher tray	17563A	\$ 32.00
B-size media loading tray	17564A	\$110.00
A3-size media loading tray	17565A	\$110.00
B/A3-size media catcher tray	17566A	\$ 42.00
B-size media handling kit B-size media loading tray B/A3 media catcher tray B-size plotter paper, 50 sheets	17525A	\$160.00
A3-size media handling kit A3-size media loading tray A3/B media catcher tray A3-size plotter paper, 50 sheets	17526A	\$160.00

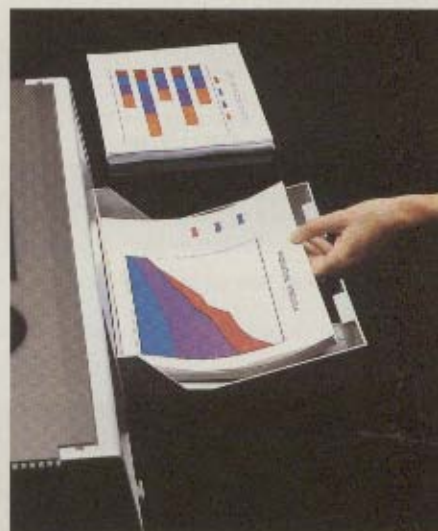

Enhance your graphics workstation with HP plotter accessories

Graphics accessories

Item	Plotter	Description	Part no.	Price
Adapters	7550, DraftPro, DraftMaster, 7580, 7585, 7586	Reusable adapter and pen cap assemblies (4 of each/pkg.)	☐ 5061-7578	\$ 8.00/pkg.
Carousels	7090	Fiber-tip pen carousel (paper and transparency)	5061-5080	\$40.00 ea.
	ColorPro (7440)	Fiber-tip pen carousel (paper and transparency)	☐ 07440-60085	\$24.00 ea.
	7475	Fiber-tip pen carousel (paper and transparency)	☐ 5061-5080	\$40.00 ea.
		Refillable drafting pen carousel	☐ 07475-60030	40.00 ea.
	7550	Fiber-tip transparency pen carousel	☐ 07550-60050	\$55.00 ea.
		Fiber-tip paper pen carousel	☐ 07550-60051	55.00 ea.
		Rollerball pen carousel	☐ 07550-60052	55.00 ea.
		Refillable/disposable drafting pen carousel	☐ 07550-60053	55.00 ea.
	DraftPro	Fiber-tip paper pen carousel	☐ 07570-60050	\$60.00 ea.
		Refillable/disposable drafting pen carousel	☐ 07570-60055	60.00 ea.
	DraftMaster	Adjustable pen carousel	☐ 5062-1576	\$70.00 ea.
		7580, 7585, 7586	Fiber-tip paper pen carousel	☐ 07580-60035
	Refillable/disposable drafting pen carousel		☐ 07580-60081	70.00 ea.
Rollerball pen carousel	☐ 07580-60082		70.00 ea.	
Disposable drafting pen carousel, Serial No. Prefix 2444 or higher	☐ 07580-60240		70.00 ea.	
Cleaning supplies	7475, 7550, DraftPro, DraftMaster, 7580, 7585, 7586	Gritwheel brush	☐ 5062-1515	\$ 6.00 ea.
	For use with refillable drafting pens	Cleaning syringe	☐ 9282-0905	\$12.00 ea.
		Cleaning solution	☐ 9282-0908	6.50 ea.
Digitizing sights	For use with all HP plotters (with the exception of ColorPro) DraftPro, 7580, 7585, 7586	Straight sight	☐ 09872-60066	\$50.00 ea.
		Angled view sight	☐ 07585-60191	80.00 ea.
Drafting ink	7475, 7550, DraftPro, DraftMaster, 7580, 7585, 7586	.75 oz. bottle, black	9260-0596	\$ 2.50 ea.
Media cutter	DraftMaster	Media cutter for roll paper (5/box)	☐ 07596-60008	\$10.50/box
Overlays	17623A Graphics tablet	Overlay	4114-1033	\$ 8.50 ea.
	9111A/T Graphics tablet	Overlays (3/pkg.)	☐ 7121-0988	\$39.00/pkg.
Paper, Blank roll	7220/21, 9872S/T only	297mm x 61m roll (metric)	9280-0619	\$22.00 ea.
		11 in. x 200 ft. roll (english)	9280-0618	22.00 ea.
Paper writing pens	7200-7203, 7210, 9125, 9862	Single color pens, 5 per package Red, Blue, Green, Black	5081-1190	\$ 6.50/pkg.
			5081-1191	6.50/pkg.
			5081-1192	6.50/pkg.
			5091-1193	6.50/pkg.
Print heads	7240, 7245	Thermal print head	07245-60001	\$85.00 ea.
Printer/Plotter power modules	ColorPro (7440), 3630A PaintJet, 2227A/B QuietJet Plus, 2228A QuietJet printers and 2276A DeskJet Printer	External power module, U.S./Canada, 120V/50/60Hz	☐ 17122B	\$60.00 ea.
		External power module, European, 220V/50Hz Call for international versions.	☐ 17222B	60.00 ea.
Replacement boots	7475	Boots for refillable drafting pen carousels (6/pkg.)	☐ 07475-60038	\$ 8.75/pkg.
	7220, 7221, 9872	Boots for short-body drafting pens (2/pkg.)	9300-0967	\$ 6.25/pkg.
	7550, DraftMaster	Boots for fiber-tip and rollerball pen carousels (8/pkg.)	☐ 5061-7635	\$ 9.00/pkg.
		Boots for drafting pen carousels (8/pkg.)	☐ 5061-7636	\$ 9.00/pkg.
	7580, 7585, 7586	Boots for fiber-tip and rollerball pen carousels (8/pkg.)	☐ 5062-0098	\$ 9.00/pkg.
		Boots for drafting pen carousels (8/pkg.)	☐ 5062-0099	9.00/pkg.
DraftPro	Boots for fiber-tip pen carousels (8/pkg.)	☐ 5062-0096	\$ 9.00/pkg.	
	Boots for drafting pen carousels (8/pkg.)	☐ 5062-0097	9.00/pkg.	
Styli	17623A, 9111A/T	Stylus refills (2 inkless, 3 ink cartridges)	09111-68701	\$ 9.50 ea.
Take-up cores	7586, DraftMaster II	609.6mm (24 in.)	☐ 9300-1068	\$ 2.00 ea.
		914.4mm (36 in.)	☐ 9300-1069	3.00 ea.

See pages 120-121
for dust covers and carrying cases.

HP's 92269A Printer Stand saves desktop space and stores plotter paper for your HP ColorPro and 7470A plotters. See page 119 for more details. See page 29 for peripheral sharing devices to allow many users to share one plotter.

Add vivid colors to your business graphics

Hewlett-Packard has combined advanced technology and improved packaging into the HP ColorPro 7440A graphics plotter—at an affordable price.



The HP ColorPro eight-pen plotter combines smooth curves, well-defined diagonals, crisp characters, and vibrant colors to produce effective, high-impact business presentations. And the ColorPro Graphics Organizer acts as a stand for your plotter as well as a handy hideaway for your supplies! For more details, see page 49.

"The plotter graphs are very neat and precise. This is important because if my presentations look good, I look good."

Bill Harwick,
 Business analyst
 Italian Swiss Colony Wine of California, Inc.

Warranty and post-warranty services for HP plotters are available from more than 100 HP sales offices in the U.S. Call (800) 835-4747 for more information.

The HP ColorPro Plotter does not have eavesdrop capability.

*Sorry, but quantity, contract, or other discount do not apply to the special off-the-shelf service.

**Extend pen life. When your plotter is not in use, remove pens from the carousel and store them capped.

HP's 92166E Plotter Sound Enclosure can protect as well as reduce the sound of your HP ColorPro (7440), 7470 or 7475 Plotter. For more details, see page 59.

Media sizes
 • 8½ × 11 in. (ANSI A)
 • 210 × 297 mm (ISO A4)

Media
 • Paper (regular or glossy)
 • Fast-drying transparency plotter film

Pens
 • Number—8, automatic pen changing and capping
 • Type—Fiber-tip (paper or transparency)

Resolution
 • 0.025 mm (0.001 in.)

Pen Acceleration
 • Approximately 1.2 g's

Pen Speed
 • 40 cm/s (15.7 in./s)

Interfaces
 • RS232C/CCITT V24 or HP-IB (IEEE 488-1978)

The eight-pen HP ColorPro allows you to create high-quality color graphics on either paper or transparency film quickly and easily—right at your own personal computer workstation. No more drawing or typing original charts yourself; no more bargaining with the in-house art department; no more rush charges from outside graphics services.

Colors make the mark. Choose from HP's variety of fiber-tip pens for paper and transparency plotter film, each available in two line widths for bold and fine lines. Make your statement with color and HP's ColorPro plotter will create the professional finish that will make you look impressive.

The ColorPro pays attention to detail. You know the value of quality, and the ColorPro plotter is designed and manufactured to give your presentation materials the look of professionalism you demand.

While others may be satisfied with printer output, the ColorPro plotter offers precision and accuracy—right down to the smallest details like smooth circles, straight diagonal lines, and crisp characters.

Versatility. The ColorPro plotter is easy to use and compatible with your personal computer—from the Apple IIe™ to the IBM PC™, the Compaq™ Deskpro to the HP Touchscreen II (HP 150 II) and the HP Vectra PC.

The HP ColorPro plotter for your future needs. As your graphics needs expand, the Graphics Enhancement Cartridge, available as an accessory, will add more advanced capabilities to your ColorPro plotter, such as a larger RS232C buffer (from 60 to at least 1024 bytes) and handshaking similar to the HP 7475A. Also, the Graphics Enhancement Cartridge will let you run virtually any software program written for the HP 7475A—particularly packages for technical applications and mainframe graphics—on your ColorPro plotter! What's more, you will have more than 50 HP-GL (Hewlett-Packard Graphics Language) commands available if you choose to write your own programs.

Be sure to order the correct option, along with any necessary cables.

7440A Opt. 001 ColorPro plotter (RS232C/CCITT V.24) \$1,295.00 ea.*
Opt. 002 (HP-IB) (IEEE 488-1978) \$1,295.00 ea.*
17440A Graphics Enhancement Cartridge \$150.00 ea.*
87440-60085 Additional 8-pen carousel** \$24.00 ea.
92177W ColorPro Graphics Organizer \$119.00 ea.

High quality graphics that boast accuracy and precision

Add the HP 7475A graphics specialist to your technical team and you will find out why businesses around the world use the HP 7475A more than any other plotter on the market.

Whether you work in R & D, design or manufacturing, you can rely on the HP 7475A to give you precise, high-quality reproductions and drawings to meet your technical needs. The HP 7475A can easily handle your most difficult assignments—from architectural designs and mechanical drawings to measurement graphs and organizational charts.

In addition to creating 8½ × 11-inch charts and graphs, the HP 7475A is ideally suited for 11 × 17-inch drawings such as time lines, PERT charts, schematics, engineering drawings, project schedules and flow charts.

Drafting-needs bonus. Our liquid-ink drafting pens are specifically designed for our HP 7475A. Use them with durable, double-matte polyester film for the highest quality drafting results and reproductions.

Software plus. When it comes to software, the HP 7475A is one of the world's most widely supported plotters. Choose from hundreds of packages for a variety of technical and business applications—packages that will run on personal, desktop, mini or mainframe computers.

See your dealer for the right software for your technical or business needs.

A business graphics bonus. The HP 7475A is both a technical and business graphics specialist.

Not only will you be able to produce large scale drawings such as PERT charts, scattergrams or CAD drawings, you'll also be able to create colorful text, pie, bar and line charts. Create your high quality graphics on either paper, glossy paper or transparency film.

In addition, the HP 7475A has an easy-to-use front panel that will allow you to test pen colors, position your media to fit horizontal or vertical formats, scale or digitize points and run a built-in demo plot.

Quality with the technical advantage. The HP 7475A has outstanding accuracy and precision. It draws ruler-straight lines and crisp characters, plus it has the capability of plotting 1000 points per inch. And with no pen change you can command the HP 7475A to return to the same point within 0.1 mm (0.004 in.).

Hardware compatibility. You'll receive the same high-quality plotting results when you link up the HP 7475A to a personal computer, mainframe or smart instrument. You'll be pleased with its team performance.

7475A Opt. 001
(RS232C) \$1895.00 ea.**
(for cables see page 78-79)



The HP 7475A six-pen plotter is an ideal solution for your technical applications. The 92177X Graphics Organizer keeps your plotter supplies organized. For more details, see page 49.

Opt. 002
(HP-IB) \$1895.00 ea.**
(for cables see pages 78-79)

92177X 7475A
Graphics Organizer \$175.00 ea.
See page 49.

Add drafting capability to your HP 7475A Plotter!

Now the HP 7475A plotter can help with many of your design/drafting needs—drafting pens (pages 56-57), a special HP 7475A drafting pen carousel (page 56), and polyester film A/A4 and B/A3 sizes (page 53) are now available for the HP 7475A. The low-cost HP 7475A with drafting capability is the ideal plotter for PC CAD systems and other applications requiring high quality.

Drafting pens and polyester films offer several advantages for your technical applications—superior line quality, translucent media, permanent copies, opaque ink, and a choice of three line widths. Because of these characteristics, you'll want to use drafting pens for:

- engineering diagrams
- overlays
- charts for microfilm reduction
- charts requiring frequent handling
- archival copies
- camera-ready art

"The plot quality is very impressive and professional looking. This reflects positively on my business."

Gary Naylor
President
Engineering Surveys

Media sizes

- 8½ × 11 in. (ANSI A)
210 × 297 mm (ISO A4)
- 11 × 17 in. (ANSI B)
297 × 420 mm (ISO A3)

Media

- Paper (regular or glossy)
- Transparency plotter film
- Double-matte polyester film

Pens

- Number—6. Automatic pen changing and capping
- Types—Fiber-tip (paper or transparency), refillable short-body drafting

Resolution

- 0.025 mm (0.001 in.)

Pen Acceleration

- Approximately 2 g's

Pen Speed

- Approximately 38.1 cm/s (15.0 in./s)

Interfaces

- RS232C/CCITT V.24
- HP-IB (IEEE 488-1978)

*Also available in A4 or A3 sizes.

**Sorry, but quantity, contract, or other discounts do not apply to the special off-the-shelf service.

CABLES



HP-IB cables...an example of Hewlett-Packard's leadership role in developing the world instrumentation interface standard. HP DIRECT offers an extensive range of cables for applications of all types. Check our cable charts in this section—they make ordering easy.

Local area networks	65
Cable accessories	66, 71
Do-it-yourself cabling	70
Gender converters & extenders	72
Extension cables	73
PC cables	74-76
Printer cables	76-78
Plotter cables	78-79
Terminal cables	80

HP LANs— superior performance for high-speed data communications

If your company is like most, local area networks are fast becoming a key part of your plan for productivity in information management. In simple terms, a LAN is a way of connecting multiple systems together in a limited geographic area.

LANs offer significant advantages over the direct connection of systems:

- Flexible topology—a well-designed LAN can accommodate movement and expansion as your organization changes.
- Efficient resource use—sharing of computers, peripherals and software saves expenses.
- Efficient wiring—connecting each computer to one main LAN backbone cable requires less cabling effort and space.

All others



HP AdvanceNet, connecting your HP computers to the rest of the world.

HP AdvanceNet: networking solutions for today and tomorrow.

HP AdvanceNet is Hewlett-Packard's strategy and architecture for data communications and information management.

HP's line of products provides HP computers with a flexible, high-performance, and reliable local communication link to an industry standard IEEE 802.3 local

area network. The LAN itself is based on two cabling schemes.

Workstation to workstation

ThinLAN cabling is a low-cost, easy-to-install cable ideally suited for connecting workstations in a group or department

together. In the office, HP and IBM personal computers connected directly to ThinLAN cabling can share files and peripherals, as well as connect to HP 3000s, as part of an HP OfficeShare network.

In the engineering environment, HP 9000 Unix based workstations can connect to the ThinLAN in order to pass large engineering design files between members of the same design group or to a completely different group such as manufacturing.

The Shared Resource Management system, which is the primary network for HP 9000 BASIC and PASCAL based systems, uses the same ThinLAN cables but utilizes an HP proprietary network protocol. SRM networks cannot be directly connected to an 802.3 network.

Office to office

A thick backbone cable is used to connect multiple ThinLANs together or to connect nodes that are farther than 185 meters apart (maximum ThinLAN segment length). Once the various groups have been integrated into one local area network, every node will be able to directly communicate with every other node on the network via a single connection to the network. The integrated network can support up to 1024 nodes (100 nodes per 500m segment of backbone cabling or 30 nodes per 185m of ThinLAN cabling).

On the following pages, you will find the necessary cable, connectors, tools, and manuals to implement the physical network.

For the latest software, interface controllers, and especially for planning information, please consult your local HP representative.

LANs at a glance

StarLAN	pages 8-9
Reference books	page 66
Attachment Unit Interface (AUI) cables	page 67
Medium Attachment Unit (MAU)	page 67
ThinLAN cables	page 68
ThinMAU	page 68
Tool kits	pages 66-68, 71
LAN/3000-Backbone	pages 66-67
SRM Coax Network	page 69

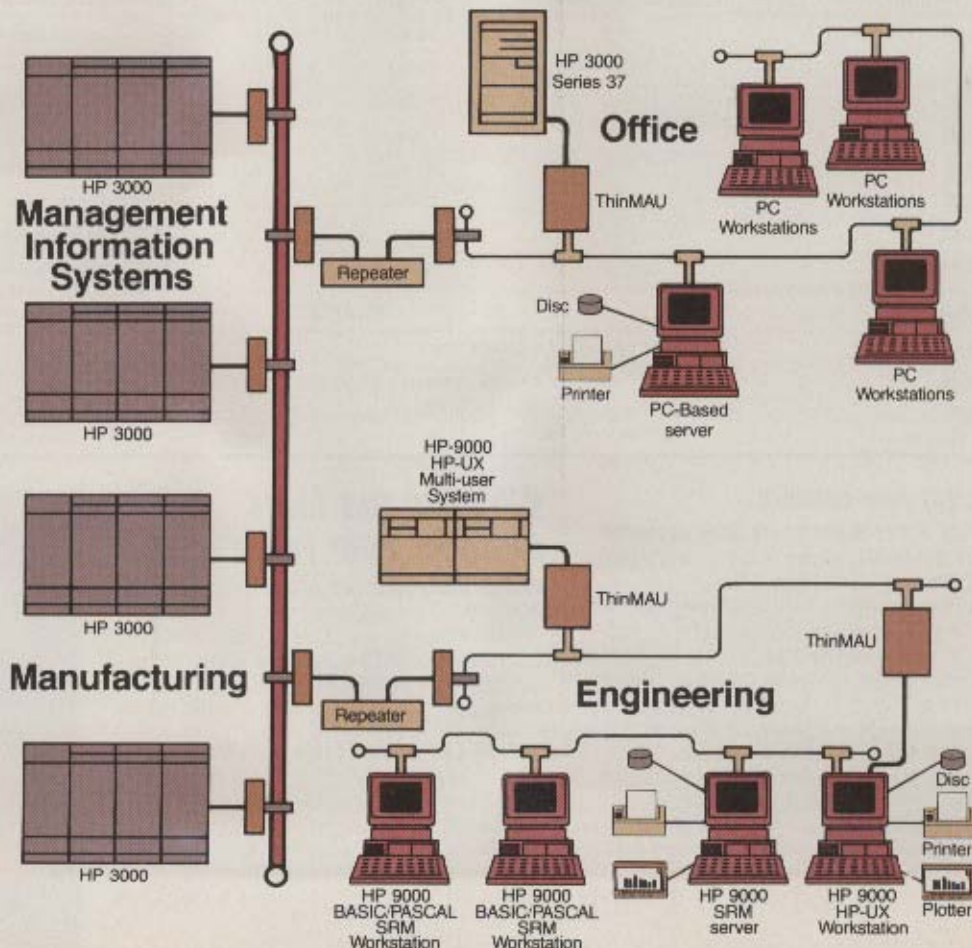

Information please . . .

Guides to understanding & implementing LANs

Making the LAN Connection. A local area network primer covering the basic concepts of LANs and giving some specific information on HP's implementation of the LAN.

5957-4624 \$6.00 ea.

Learn how to set up and utilize your StarLAN1/10 Here's all the information you'll need to install StarLAN1 or StarLAN10 cables and accessories. This informational manual also includes helpful hints on cabling

system-planning, plus documentation for twisted pair installations.

5959-2208 HP SiteWire Twisted-Pair Cabling Installation Guide \$37.00 ea.

Easy-to-follow installation guide

LAN Cable and Accessories Installation Manual. Provides the information necessary to install LAN cable, AUI cables, MAUs, and repeaters.

5955-7680 \$45.00 ea.

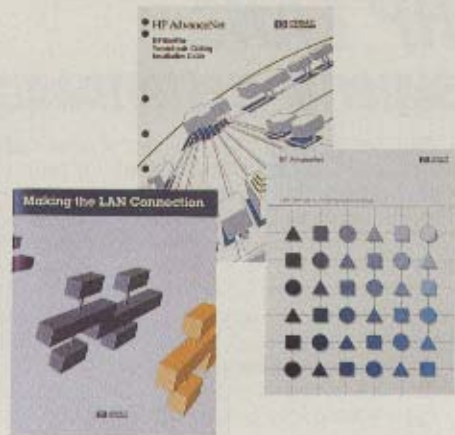

Send, receive data over longer distances with HP's "thick" coaxial cable

Thick backbone coax cable

Thick backbone cables are available with an outer layer of PVC or FEP (Teflon®). Local building codes and placement of the cable determine whether PVC may be used or FEP is required.

This is the standard or thick coaxial cable with a 0.4-inch diameter. It was specifically designed to meet the strict IEEE 802.3 standard and also meets Ethernet specifications.

Standard lengths are provided to avoid excessive signal reflection and distortion.

Each kit contains: two N-connectors; one terminator; one grounded terminator; one terminal insulator; one ground lug; two 1/8-inch nuts; one barrel connector (female to female); and one barrel insulator. The 500m kits provide additional N-connectors (total of 10) and additional barrels with insulators (total of four each). This allows you to segment the cable for easier fault isolation. Extra connectors, barrels and terminators are available below.

Cable kit number	Jacket material	Length	Connected/unconnected	Price
92253A	FEP	23.4m	unconnected	\$ 400.00 ea.
92253B	FEP	23.4m	connected	\$ 425.00 ea.
92253C	FEP	117m	unconnected	\$1500.00 ea.
92253D	FEP	500m	unconnected	\$6000.00 ea.
92253E	PVC	23.4m	unconnected	\$ 200.00 ea.
92253F	PVC	23.4m	connected	\$ 225.00 ea.
92253G	PVC	117m	unconnected	\$ 500.00 ea.
92253H	PVC	500m	unconnected	\$2100.00 ea.

Product no.	Description	Price
92253J	Package of 4 N-connectors	\$60.00 ea.
92253K	Package of 2 barrel connectors and 2 barrel insulators.	\$65.00 ea.
92253L	Package of one non-grounded terminator, one grounded terminator, and one terminal insulator.	\$60.00 ea.

Protect your network

92256E Surge protector for thick backbone cable segments. Does your network plan include segments with different grounds or systems with different power sources? Use the 92256E surge protector to isolate those portions and protect against surges due to lightning or other outside sources.

The 92256E surge protector connects into the coaxial cable by means of N-connectors in the same manner as the barrel connector. A threaded stud is provided for connecting the eight-gauge ground wire. A two-hole mounting plate allows attachment to wall surface.

Price \$90.00 ea.

We have the tools to make your job easier

92229B Crimp tool for backbone coax and AUI cable. Shield ferrel crimping tool for N-connector on backbone coax and D-connector on AUI cable. Requires die in 92256A for N-connector.
Price \$199.00 ea.

92256A LAN coaxial cable installation tool kit for installing N-connectors on thick backbone coaxial cable. Includes:
• Coaxial cable stripper.
• Hex crimp die; requires use of 92229B crimping tool (order separately).
Price \$185.00 ea.



Attachment Unit Interface (AUI) cable

The Attachment Unit Interface or AUI cable interconnects the 30241A MAU and the host system, such as an HP 3000. It may be up to 48 meters in length. This cable meets strict IEEE 802.3 specifications.

AUI cable is available with jacket material of PVC or FEP (Teflon®). Local building codes and placement of the cable determine whether PVC may be used or FEP is required. Each cable is packaged with six wallplate labels with protective tape.

Connected AUI cable	Jacket material	Length	Price
92254A*	FEP	6m	\$135.00 ea.
92254B*	FEP	12m	\$200.00 ea.
92254C*	FEP	24m	\$345.00 ea.
92254D*	FEP	48m	\$635.00 ea.
92254E*	PVC	6m	\$ 85.00 ea.
92254F*	PVC	12m	\$110.00 ea.
92254G*	PVC	24m	\$160.00 ea.
92254H*	PVC	48m	\$250.00 ea.
92254J**	PVC	5m	\$ 45.00 ea.

*For use with 30241A LAN Medium Attachment Unit and LAN coaxial cable tap.
**For use with 28641A ThinMAU.

Cut-to-length AUI cable	Jacket material	Min. order	Max. continuous length	Price
92255A	FEP	15m	500m	\$13.00/mm
92255B	PVC	15m	500m	\$ 4.50/mm

92255C AUI cable connector kit. Provides all parts needed for one male and one female D-connector, plus six labels with protective tape.

Price \$47.00 ea.

92256D AUI wallplate kit. Complete kit for a pair of wallplates for AUI cable. Requires AUI connectors. Includes:

- Two wallplates with labels and protective tape
 - Two shield funnels
 - Two wallplate locking post assemblies
- Price \$33.00 ea.

92257B Loopback hood. Required for operation of node diagnostic for customer isolation of failures to thick backbone cable, AUI cable or MAU.

Price \$140.00 ea.

Need help installing your LAN?

Find the answer to your questions in our easy-to-follow installation guide on page 66. And be sure to see our handy reference books for a closer look at the "how and whys" of local area networking (also on page 66).

Medium Attachment Unit (MAU) and coaxial cable tap

The Medium Attachment Unit, or MAU, contains the electronics which send and receive data over the thick backbone cable and detect collisions. Its mechanical and electrical connection to the coaxial cable is provided by the tap, which may be installed without interrupting communications on the network.

When a MAU is disconnected from the coaxial cable, the tap should be left in place on the cable.

Product number	Description	Price
30241A	LAN Medium Attachment Unit and LAN coaxial cable tap.	\$400.00 ea.
30241B	Additional LAN coaxial cable tap	\$ 45.00 ea.



30241A MAU and tap

Network compatibility guide

Computer	Interface controller card	Backbone LAN connection	ThinLAN connection
HP 150	27208A	Not Directly Accessible	Direct to 27208A
HP Vectra PC, IBM® PC/XT/AT	27210A	Not Directly Accessible	Direct to 27210A
HP 9000, Series 200 & 300	98643A	Via 30241A	Via 28641A (Included in 98643A)
HP 9000, Series 500	27125B	Via 30241A	Via 28641A (Included in 27125B)
HP 3000 Series 37, 39, 4X, 6X	30242A	Via 30241A (Included in 30242A)	Via 28641A
	30240A	Via 30341A	Via 28641A (Included in 30240A)

For interface controller cards, please contact your local HP representative.

Convenient tool kit makes installation easy

92256C LAN MAU and tap installation tool kit for installing tap on coaxial cable and attaching to MAU. Includes:

- Coring tool
- 1/8-inch Allen wrench
- 1/2-inch hex nut driver

Price \$39.00 ea.

Low-cost, easy-to-install cable is ideal for office networking

Connected ThinLAN cables

Ready-to-use ThinLAN cables have PVC jacket material and molded connector strain relief housings for durability. The gray color is attractive in any office environment. Terminators sold separately. See 92227P below.

Product no.	Length	Price
92227A	1 m	\$ 25.00 ea.
92227B	2 m	\$ 27.00 ea.
92227C	4 m	\$ 29.00 ea.
92227D	8 m	\$ 33.00 ea.
92227E	16 m	\$ 39.00 ea.
92227F	32 m	\$ 51.00 ea.
92227G	64 m	\$ 76.00 ea.
92227H	128 m	\$126.00 ea.



Cut-to-length ThinLAN cables

Cut-to-length ThinLAN cable is available for custom installations. Terminators and connectors should be ordered separately.

Product no.	Jacket material	Min. Order	Max. continuous length	Price
92227J	PVC	300 m	3000 m	\$ 0.78 per m
92227K	FEP	100 m	3000 m	\$ 3.35 per m

Crimp-on style BNC connectors for use with cut-to-length cable. Two to a package.
92227L \$22.50/pkg.

ThinLAN tool kit. Precision crimping tool and cable stripper for installing connectors on cable.
92227M \$450.00 ea.

ThinMAU

Similar to the 30241A MAU for interfacing to backbone cabling, the ThinMAU provides the ability to send and receive data over an IEEE type 10 base 2 ThinLAN coax cable segment. The ThinMAU supports connections to HP 9000 engineering workstations, both series 300 and 500, as well as HP 3000

computers. The ThinMAU includes an integrated, 1 meter Attachment Unit Interface cable** to connect the ThinMAU to the computer system, and a BNC Tee connector with insulating cover enabling the ThinMAU to attach to the ThinLAN cable. No tools required for installation.

Product no.	Description	Price
28641A	ThinMAU w/integrated 1m AUI cable and BNC Tee connector with insulating cover	\$350.00 ea.

**Because the ThinLAN cable is very flexible, it easily can be routed directly to the ThinMAU. The integrated AUI cable cannot be extended beyond the given 1 meter length.



Spare parts for ThinLAN networks

- 92227N** ThinLAN Tee connector with insulating cover \$27.50 ea.
- 92227P** ThinLAN terminator pair (no ground wire connection) \$23.00 ea.
- 92227Q** ThinLAN loopback (Tee connector, terminator pair, insulating cover, pre-assembled) \$45.00 ea.
- 92227R** ThinLAN insulating cover for Tee connector. See photo above. \$19.50 ea.

For SRM coaxial links

- 45695A** Terminator pair, one grounded, one non-grounded \$40.00 ea.

"Thank you for adding the Quality touch."

Just a note on HP's Direct-Order-Fast-Ship service. As a customer it's working great. I became a customer of yours shortly after the first of the year. My orders have been for supplies to support the HP110 system that I use on the job, generally on a daily basis.

All orders have been will-calls, using the procedure outlined in the front of your catalog. The operators have always taken my orders in a friendly and courteous manner, and I appreciate the stock check at time of order. I have received the same professional service at the will-call counter. My order has always been ready at the specified time.

To date all items received have been in excellent condition and have performed well in their intended use.

Sincerely,

David M. Retterer

David M. Retterer, Supervisor
Applied Materials
Santa Clara, California

Network alternatives for SRM users

The Shared Resource Management (SRM) system is a dedicated file and printer/plotter server for the HP 9000 engineering workstations. It provides the capability to share resources including printers, plotters, and discs among workstations in a local cluster. SRM combines the advantages of the distributed processing of personal workstations with the centralized resources of multi-user systems.

SRM Coax Network The network utilizes HP 92227x ThinLAN Coax Cable (page 68) and SRM Coax Interface Cards (order through sales office) resulting in a bus configuration. Up to 25 nodes (servers and workstations) can be connected on a network that is up to 1000 meters total length of coax. All HP 9000 workstations are supported on the SRM coax network. However, non-SRM workstations cannot be supported on the same bus as an SRM network.

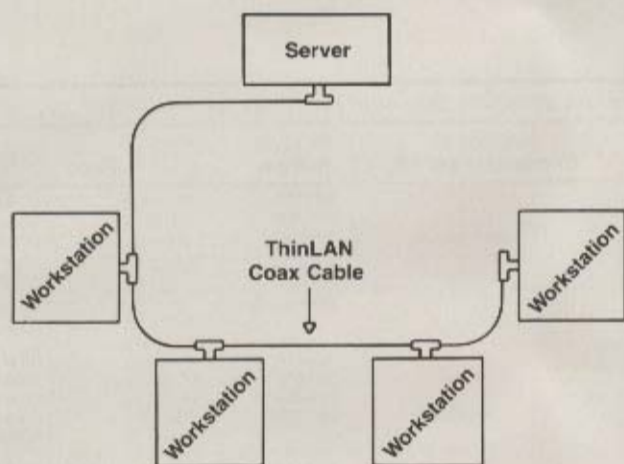

SRM Coax Link

HELPFUL IDEAS!

Cut-to-length cable ordering guide

HP offers unterminated cables and connector kits so you can custom fit your installation (see pages 8-9, 68 and 70). For your convenience, we've put together the guide below to help you step through the process of ordering cut-to-length cables.

1 Determine which cut-to-length cable you need for your installation. You will find cut-to-length cables listed on pages 8-9, 68 and 70.

2 Order HP's cut-to-length cables by the meter. If you know the number of feet of cable required, use the formula below to convert feet to meters*. Your order should exceed our minimum order requirement for that cable:

$$(\text{no. of feet}) \times (0.3048) = (\text{no. of meters})$$

3 Determine the quantity of your order by rounding up the number of required meters to the nearest whole number. For example, if you require 119.5 meters of a particular cut-to-length cable, the quantity of your order will then be 120 meters.

4 Determine the price of your order by multiplying the number of meters of cable by the cost per meter (see the cable chart on pages 8-9, 68 and 70).

$$(\text{no. of meters}) \times (\text{price per meter}) = (\text{price})$$

Be sure to take advantage of our quantity price breaks offered for many of the cut-to-length cables. Find out how much you SAVE with these price breaks listed in the cable charts.

*If you need to convert meters to feet, use the following formula: $(\text{no. of meters}) \times (3.2808) = (\text{no. of feet})$.

SRM Coax Interface Cards

SRM Interface Cards required:

Computer	MuxLink	Coax link
HP Series 200 and 300	98629A	50961A Opt. 200
HP Series 500	27123A	50961A Opt. 500

HP StarLAN Cable—low-cost and easy to install

HP now offers premeasured and connected StarLAN Cable to link your computer system to your StarLAN hub. Via a central StarLAN hub you can exchange data files, share data storage facilities, and pool your printers and plotters.

- HP StarLAN Cable was designed to connect HP computer systems, IBM PCs and peripherals to your StarLAN hub.*
- HP StarLAN Cable consists of four twisted pair cable with an 8-pin RJ-45 connector and installs as easily as telephone cable.
- HP StarLAN Cable conforms to the Ethernet IEEE 802.3 1BASE5 standard.

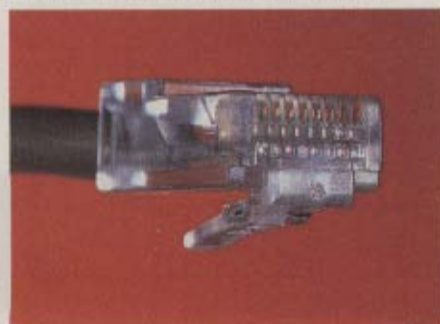

Product no.	Length	Price
92268A	4m (13.1 ft.)	(1-4) ... \$16.00 ea.
		(5-8) ... 14.00 ea.
		(9+) ... 13.00 ea.
92268B	8m (26.2 ft.)	(1-4) ... \$19.00 ea.
		(5-8) ... 17.00 ea.
		(9+) ... 16.00 ea.

Product no.	Length	Price
92268C	16m (52.5 ft.)	(1-4) ... \$22.00 ea.
		(5-8) ... 20.00 ea.
		(9+) ... 19.00 ea.
92268D	32m (105.0 ft.)	(1-4) ... \$27.00 ea.
		(5-8) ... 25.00 ea.
		(9+) ... 24.00 ea.

*Not designed for HP Touchscreen PCs (HP 150 A/B).

See new product section, pages 8-9, for new StarLAN products.

Do-it-yourself cabling—as easy as 1-2-3

1.
**Choose the
cabling system
you need**

Cable systems

Description	Connector kit	Raw cable
Universal 25-pin male RS-232C	92178A/C	92179A/B
Universal 25-pin female RS-232C	92178B/C	92179A/B
Edge connector for 264X Terminal	5061-1340	92179A/B
Multipoint connectors for 264X	5061-2401	92179A/B
For 262X Terminal (port 1) (except 2621B)	5061-2412	92179A/B
HP 3000 ATP (3-pin male RS-232C)	92224A†	92179C
HP 3000 ATP (3-pin female RS-232C)	92224B†	92179C
HP 3000 ATP (5-pin male RS-422)	92225A†	92179D
HP 3000 ATP (5-pin female RS-422)	92225B†	92179D
For HP-IB extenders	92226A	92179G
For 3081 to 92922A or 40253A	5061-3858	92179H

†Requires 92229A crimp tool for assembly.

2.
**Select the
appropriate
connector kit**

Connector kits

Each kit contains all parts necessary for a complete assembly. See examples at top of next page.

Application	Connector Kit Description	Number of Connectors per Kit	Product Number	Price
RS-232C	25-pin male RS-232C	2	92178A	(1-4 kits) ... \$23.00 ea.
	25-pin female RS-232C	2	92178B	(5-9) ... 21.00 ea.
	25-pin male & female RS-232C	2 (1 male/1 female)	92178C	(10+) ... 19.00 ea.
264X Terminal	30-pin female edge connector	1	5061-1340	\$14.00 ea.
262X Terminal	50-pin male RS-232C for port 1 (except 2621B)	1	5061-2412	\$14.00 ea.
HP 3000 ATP	3-pin male RS-232C ATP	4	92224A†	(1 kit) ... \$51.00 ea.
	3-pin female RS-232C ATP	4	92224B†	(2-3) ... 47.00 ea.
	5-pin male RS-422 ATP	4	92225A†	(4-9) ... 45.00 ea.
	5-pin female RS-422 ATP	4	92225B†	(10-49) ... 43.00 ea. (50+) ... 41.00 ea.
HP-IB extender	BNC male (coaxial)	1	92226A	\$ 5.00 ea.
3081 to 92922A or 40253A	9-pin male RS-232C	1	5061-3858	\$67.50 ea.

†Requires 92229A crimp tool for assembly.

3.
**Determine the
length of raw
cable you need**

Cut-to-length cables

Please specify lengths in meters. ** Refer to the "cut-to-length cable ordering guide" on page 69 for details.

Shielded	Unshielded	No. of wires	Gauge	Product Number	Min. order	Max. continuous length*	Price per meter**
	X	12	22	92179A	10m	400m	(10-19m) ... \$2.70/m (20-99m) ... 2.35/m (100+) ... 2.10/m
	X	25	26	92179B	10m	400m	(10-19m) ... \$4.10/m (20-99m) ... 3.65/m (100+) ... 3.25/m
X		3	24	92179C	30m	300m	(30-99m) ... \$1.25/m (100+) ... 0.89/m
X		5	24	92179D	30m	300m	(30-99m) ... \$1.55/m (100+) ... 1.17/m
X		1 (coaxial)	18	92179G	100m	1000m	\$0.79/m
X		4	20/22	92179H	50m	1000m	\$1.00/m

*Longer continuous lengths are available on special order. Delivery time may be increased.

**Price per foot is roughly one-third the price per meter.

Our connector kits make custom cabling simple

To order, follow steps 1-2-3 on the opposite page



92178C 25-pin RS232C connector kit. Kit includes male and female RS232C preassembled 25-pin connectors, strain relief, rubber bushings, plastic housings and all necessary hardware.
Price \$22.00 ea.



92226A HP-IB Extender connector kit. Kit includes BNC connector, conductor, "wrench crimp" nut, and instructions. No special tools required for assembly.
Price \$5.00 ea.



92224A HP 3000 ATP connector kit. Kit includes plastic housing, R.F. pins, pins, connector blocks, all necessary hardware and instructions. Requires special crimp tool 92229A for assembly.
Price \$50.00 ea.



92229A Crimp tool for ATP connectors. This precision-machined hand crimp tool is needed to crimp the RF shield included in 92224A/B and 92225A/B connector kits to the cable shield. Safety release located inside handle.
Price \$290.00 ea.



Cable management kit keeps cables out of sight—out of mind

Tired of tangled cables? Worried about expensive equipment accidentally being pulled to the floor? Frustrated when cables invade your workspace? Then tame your cables with HP's Cable Management Kit.

Each kit contains a 6-foot (1.8 m) flexible plastic tube, which is slit to provide convenient cable entrance and exit. Also included are five snap-together straps that can be used to attach the tube to any clean, nonporous surface. Velcro-like squares allow the straps to be mounted on a wall, desk, under a bookcase or other convenient location.

The tube is 1 inch in diameter so that several cables can be routed together; if data transmission problems occur, remove the power cord(s) and route separately.

92199F \$18.00 ea.



Protect your people and your equipment

Use these handy cable covers to eliminate costly accidents. These covers are made of long-lasting, flexible vinyl and come complete with double-faced adhesive tape for quick installation.

The 15-foot (4.8m) lengths can be trimmed to size with a sharp knife or butted for longer lengths. Beige or brown colors will match your office decor. The pre-slit channel accepts a cable up to .44 in. (7/16 in.) (11mm) diameter.

92199C Beige, 15-foot (4.8m) roll
92199D Brown, 15-foot (4.8m) roll

(1-4)	\$32.00 ea.
(5-9)	30.00 ea.
(10+)	28.00 ea.

Note: HP does not recommend placing a power cord and a data communications cable in the same channel.

Power cords

Part no.	8120-1348 Black \$8.75 8120-1378 Gray \$8.25	8120-1351*	8120-1369*	8120-1689*	8120-2104*
Plug					
Voltage rating	125V	250V	250V	250V	250V

*Order from HP sales office.



Need another HP-IB cable? Call us direct for fast, easy ordering.



HP-IB/IEEE-488 cables can be used to connect two devices (e.g. a personal computer and a disc drive) or can be "daisy-chained" to connect several devices (e.g. printer, plotter, etc.). First, make sure the device uses an HP-IB interface. Then check that the total length (in meters) of all the HP-IB cables

is no greater than twice the number of devices being connected, up to an absolute maximum of 20 meters.

Because HP-IB cables have a large bending radius, right-angle cables are extra convenient wherever HP-IB devices are stacked. Right-angle connectors are available in 1-meter and 2-meter lengths.

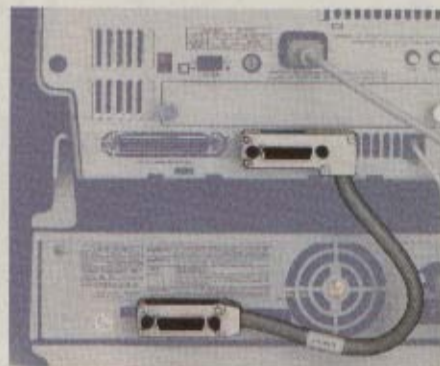

Straight-angle HP-IB cables

Order number	10833D	10833A	10833B	10833C
Length	1.6 ft. (0.5 m)	3.3 ft. (1.0 m)	6.6 ft. (2.0 m)	13.2 ft. (4.0 m)
Price	\$80.00 ea.	\$80.00 ea.	\$90.00 ea.	\$100.00 ea.

Right-angle HP-IB cables

	92220R	82977A*	82977B*
Length	1.0 ft. (0.3 m)	3.3 ft. (1 m)	6.6 ft. (2 m)
Price	\$80.00 ea.	\$101.00 ea.	\$111.00 ea.

*Use with HP 9807A Integral PC.

The HP-IL cables you need are in stock—ready to go!

HP-IL cables

HP-IL The Hewlett-Packard Interface Loop (HP-IL) is a bit-serial interface for low-cost, battery operated systems. Devices are connected by two-wire cables leading from the output port of one device to the input port of the next until all devices form a closed loop. Use with HP 41, Series 70, The PORTABLE and The Portable PLUS.

HP-IL is not intended as a replacement for HP-IB, but rather as a low-cost, low-power alternative below HP-IB in price and performance.

For more HP-IL products, see page 127. Also see the book, *HP-IL System: An Introductory Guide to Hewlett-Packard Interface Loop*, page 135.

HP-IL cable no. (3)	82167A	82167B	82167D
Length	1.65 ft. (.5 m)	3.3 ft. (1 m)	16.7 ft. (5 m)
Price	\$6.00 ea.	\$8.00 ea.	\$10.00 ea.

Cables won't mate? Try the HP connection!

92224F/M Female and male gender converters are designed to provide convenience and therefore, productivity. The male gender converter will allow two female cables to be connected. Conversely, a female gender converter will connect two male cables.

Shielding is 100 percent from metal connector to metal connector and both devices feature all 25 wires wired pin to pin.

92224F RS232C Female shielded gender converter \$25.00 ea.
92224M RS232C Male shielded gender converter \$25.00 ea.



HELPFUL IDEAS!

Extending your RS-232C cables

HP offers RS-232C extension cables that allow you to extend the distance between your computer and peripheral. To determine which extension cable will best fill your need, we offer the following suggestions:



1 Determine the gender you need to mate the extension cable to your present cable. For example, if you want to extend a male connector, order a female-to-male extension cable. If you want to extend a female connector, order a male-to-female extension cable. (A male connector has visible pins, while a female connector has recessed pins.)

2 Check your pin configuration. Extension cables that have pins 1-25 wired end-to-end will accommodate all of your cable extension needs.

3 Select the cable you need. Various configurations are offered in different lengths.

4 RS-232C cables over 50 feet in length are particularly susceptible to high voltage spikes. HP recommends 92165R surge protectors at each end of the linkage. See RS-232C surge protector on page 158.

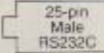
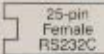
RS-232C Extension cables

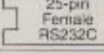
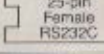
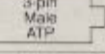
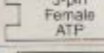
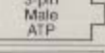
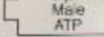
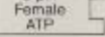
	Description	Connector Description	Length	Original system cable no.	Order cable no.	Price	
Extension cables	Pins 1-25 wired end-to-end. Shielded.	 25-pin Male RS232C	9.9 ft. (3m)		☑ 17355M	\$ 60.00 ea.	
	Pins 1-25 wired end-to-end. Shielded.	 25-pin Female RS232C	16.7 ft. (5m)	(30062C)	31391A	\$ 70.00 ea.	
			33.4 ft. (10m)		31391B	80.00 ea.	
			50 ft. (15m)	(30062C, Opt. 001)	☑ 92215F	109.00 ea.	
				100 ft. (30m)	(30062C, Opt. 002)	☑ 92215T	\$115.00 ea.
	Pins 1-8, 11, 12, 19, 20, 22, 23, 25 wired end-to-end. Shielded.	 25-pin Male RS232C	12.5 ft. (3.8m)		☑ 92219G	\$ 65.00 ea.	
	Hardwire extension; pins 2, 3, 7 wired end-to-end. Shielded.	 25-pin Female RS232C	25 ft. (7.6m)	(30062D)	30062-60018	\$ 70.00 ea.	
			50 ft. (15m)		92215A	94.00 ea.	
	Adapter cable between HP 3000 ATP and existing RS-232C terminal cable.	 25-pin Female RS232C	 3-pin Male ATP	16.7 ft. (5m)	(30152A)	30152-60001	\$180.00 ea.
	Extension cable for HP 3000 ATP RS-232C interface.	 3-pin Female ATP	 3-pin Male ATP	50 ft. (15m)	(30153A)	30153-60001	\$205.00 ea.
Extension cable for HP 3000 ATP RS-422 interface.	 5-pin Male ATP	 5-pin Female ATP	100 ft. (30m)	(30154A)	30154-60001	\$205.00 ea.	





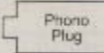
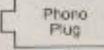

Be sure to see the book, *The RS-232 Solution*, page 135.

Video Extension cables

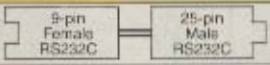
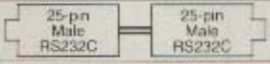
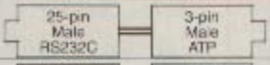
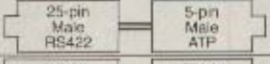
	Description	Connector Description	Length	Original system cable no.	Order cable no.	Price
HP Vectra PC	Monochrome video coaxial cable.	 Phono Plug	9.9 ft. (3m)		☑ 45741A	\$ 12.00 ea.
	Color video coaxial R, B, G cable.	 Phono Plug	9.9 ft. (3m)		☑ 45742A	\$ 35.00 ea.

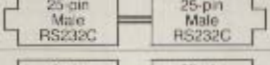
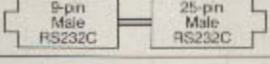
Portable PLUS & Portable Vectra CS cables

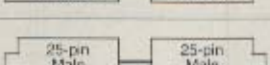
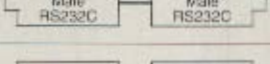
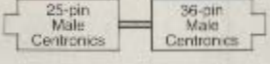
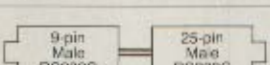
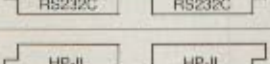
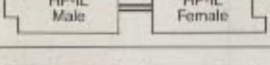
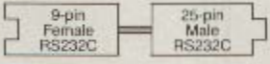
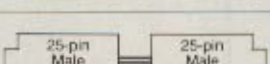
Portable PLUS, Portable Vectra CS, & Portable Vectra CS Model 20 to:

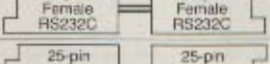
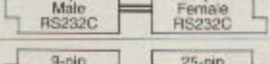
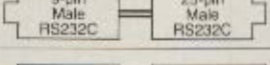
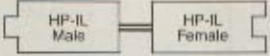
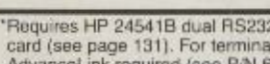
PC to:	Description	Connector Description	Length	Original system cable no.	Order cable no.	Price
HP 3000	HP 3000 systems. Shielded.		9.9 ft. (3.0 m)	24542M	24542M*	\$ 55.00 ea.
	HP 3000 systems. Shielded.		16.7 ft. (5.0 m)	(13242N)	13242-60001**	\$100.00 ea.
	RS232C interface cable for HP 3000 ATP.		16.7 ft. (5.0 m)	(13242X)	92218D**	\$ 72.00 ea.
	RS422 interface cable for HP 3000 ATP.		16.7 ft. (5.0 m)	13242P	13242P**	\$ 79.00 ea.
Modems	US/European modems. Shielded.		9.9 ft. (3.0 m)	24542M	24542M*	\$ 55.00 ea.
	US modems. Shielded.		16.7 ft. (5.0 m)	(13242N)	13242-60001**	\$100.00 ea.
	U.S. Modems, 103A, 212A, Vadic 3400 Modems, European 202C-type Modems. Acoustic Couplers. Shielded.		5.0 ft. (1.5 m)	92221M	92221M	\$ 40.00 ea.
Printers	RS232C printer cable for 2225D, 2601A Opt. 826, 2603A, 2686A, 2686A Opt 300, 2932A, 2934A. Shielded.		9.9 ft. (3.0 m)	24542G	24542G*	\$ 55.00 ea.
	RS232C printer cable for 2225D, 2601A Opt. 826, 2603A, 2686A, 2686A Opt 300, 2932A, 2934A. Shielded.		16.7 ft. (5.0 m)	(13242G)	13242-60010**	\$ 69.00 ea.
	Parallel (Centronics) printer cable for 2225C, 2686A Opt 300, 2932A Opt 042, 2934A Opt 042. Shielded.		6.6 ft. (2.0 m)	24542D	24542D***	\$ 55.00 ea.
	RS232C Interface cable for serial printer requiring male connector such as 2225D, 2601A, 2602A, 2932A, 2934A. Shielded.		5.0 ft. (1.5 m)	92221P	92221P	\$ 42.00 ea.
	HP-IL Interface cable for 2225B, 82905B Opt. 448.		1.6 ft. (0.5 m)		82167A	\$ 6.00 ea.
			3.3 ft. (1.0 m)		82167B	8.00 ea.
		16.7 ft. (5.0 m)		82167D	10.00 ea.	
Plotters	RS232C plotter cable for 7440A Opt 001, 7470A Opt 001, 7475A Opt 001, DraftPro or 758X. Shielded.		9.9 ft. (3.0 m)	24542G	24542G*	\$ 55.00 ea.
	RS232C plotter cable for 7440A Opt 001, 7470A Opt 001, 7475A Opt. 001, DraftPro or 758X. Shielded.		16.7 ft. (5.0 m)	(13242G)	13242-60010**	\$ 69.00 ea.
	RS232 cable for 7510A or 7550A. Shielded.		9.9 ft. (3.0 m)	24542H	24542H*	\$ 55.00 ea.
	RS232 cable for 7510A or 7550A. Shielded.		3.9 ft. (1.2 m)	17255D	17255D**	\$ 40.00 ea.
	RS232C interface cable for 7440A Opt. 001, 7470A Opt. 001 or 7475A Opt. 001. Shielded.		5.0 ft. (1.5 m)	92221P	92221P	\$ 42.00 ea.
	HP-IL Interface cable for 7470A Opt. 003.		1.6 ft. (0.5 m)		82167A	\$ 6.00 ea.
		3.3 ft. (1.0 m)		82167B	8.00 ea.	
		16.7 ft. (5.0 m)		82167D	10.00 ea.	

*Requires built-in serial port, HP 24540B serial/parallel or 24541B dual RS232/422 interface card (see page 131). For terminal emulation, AdvanceLink required (see P/N 68333F).

**Requires HP 24541B dual RS232/422 interface card (see page 131). For terminal emulation, AdvanceLink required (see P/N 68333F).

***Requires built-in parallel port or HP 24540B serial/parallel interface card.

HP Touchscreen (HP 150) PC cables

Touchscreen PC to:	Description	Connector Description	Length	Original system cable no.	Order cable no.	Price
HP 3000	HP 1000, 3000 Systems. Shielded.		16.7 ft. (5.0 m)	(13242N)	13242-60001	100.00 ea.
			50.0 ft. (15.0 m)		92218A	\$110.00 ea.
	3-wire cable with EMP protection for terminals from lightning-induced transients. Shielded.		16.7 ft. (5.0 m)	(13242Y)	13242-60005	\$ 95.00 ea.
			50.0 ft. (15.0 m)		92218C	140.00 ea.

Chart continued next page.

HP Touchscreen (HP 150) PC cables (continued)

Touchscreen PC to:	Description	Connector Description	Length	Original system cable no.	Order cable no.	Price	
HP 3000	RS232C interface cable for HP 3000 ATP.		16.7 ft. (5.0 m)	(13242X)	92218D	\$ 72.00 ea.	
	RS422 interface cable for HP 3000 ATP.		16.7 ft. (5.0 m)	13242P	13242P	\$ 79.00 ea.	
Modems	U.S. modems 103A, 202C/D/S/T, 212A, Vadic 3400 modems; acoustic couplers (signal compatible only). Shielded.		16.7 ft. (5.0 m) 50.0 ft. (15.0 m)	(13242N)	13242-60001 92218A	\$100.00 ea. 110.00 ea.	
	European 202C-type modems. Shielded.		16.7 ft. (5.0 m) 50.0 ft. (15.0 m)	(13242M)	13242-60002 92218B	\$100.00 ea. 122.00 ea.	
Printers	RS232C interface cable for serial printer requiring male connector such as 2225D, 2601A, 2602A, 2603A, 2631, 2686A, 2686A Opt. 300, 2932A, 2933A, 2934A, 82905B. Shielded.		16.7 ft. (5.0 m)	(13242G)	13242-60010	\$ 69.00 ea.	
	RS232C interface cable for serial printer requiring female connectors.		16.7 ft. (5.0 m)	(13242H)	13242-60011	\$ 95.00 ea.	
	Centronics (parallel) cable to connect to 2225C. Requires use of HP 45643A Extended I/O accessory, available separately.		6.6 ft. (2.0 m)	13242D	13242D	\$ 55.00 ea.	
	HP-IB interface cable for 2602A Opt. 046, 2225A, 2932A Opt. 046, 2933A Opt. 046, 2934A Opt. 046, 82906A, Opt. 001-004, 82906A		3.3 ft. (1.0 m) 6.6 ft. (2.0 m) 13.2 ft. (4.0 m)		10833A 10833B 10833C	\$ 80.00 ea. 90.00 ea. 100.00 ea.	
		HP-IL cable for 2225B. Requires HP45643A Extended I/O accessory, available separately.		1.6 ft. (0.5 m) 3.3 ft. (1.0 m)		82167A 82167B	\$ 6.00 ea. 8.00 ea.
				16.7 ft. (5.0 m)		82167D	10.00 ea.
		Plotters	RS232C interface cable for 7440A Opt. 001, 7470A Opt. 001, 7475A Opt. 001, DraftPro or 758X in stand-alone mode.		3.9 ft. (1.2 m) 16.7 ft. (5.0 m)	(13242G)	17255M 13242-60010
	RS232C interface cable for 7510A or 7550A in stand-alone mode.			3.3 ft. (1.0 m)		17255D	\$ 40.00 ea.
	RS232C interface cable for 7470A Opt. 001, 7475A Opt. 001 or DraftPro in terminal mode (eavesdrop).			3.3 ft. (1.0 m)	17455A	17455A*	\$ 75.00 ea.
				16.7 ft. (5.0 m)	(13242N)	13242-60001	100.00 ea.
RS232C interface cable for 7510A or 7550A in terminal mode (eavesdrop).			16.7 ft. (5.0 m)	(13242N)	13242-60001	\$100.00 ea.	
HP-IB interface cable for 7440A Opt. 002, 7470A Opt. 002, 7475A Opt. 002, 7510A, 7550A, DraftPro† or 758X.			3.3 ft. (1.0 m) 6.6 ft. (2.0 m) 13.2 ft. (4.0 m)		10833A 10833B 10833C	\$ 80.00 ea. 90.00 ea. 100.00 ea.	
		1.6 ft. (0.5 m)		10833D	80.00 ea.		
	Discs	Disc drive to monitor for Touchscreen II (HP 150 II) only. Not for general HP-IB use.		2 ft. (0.6 m)	(45847-60002)	92220E	\$ 85.00 ea.

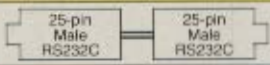
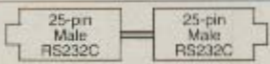
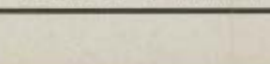
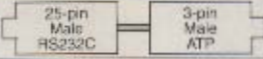
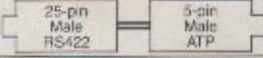
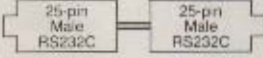
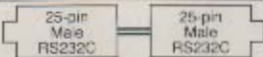
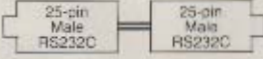
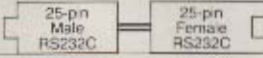
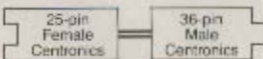
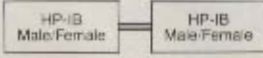
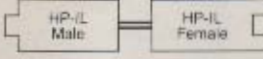
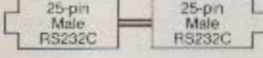
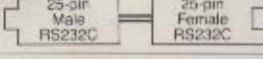
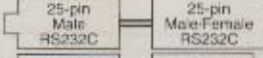
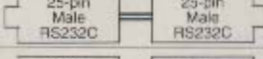
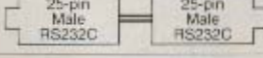
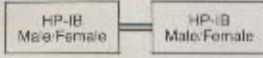
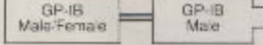

*Piggyback male and female RS232C (Y-cable) supports eavesdrop mode.

**Requires 17570A HP-IB interface, available separately.

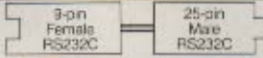
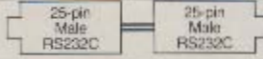
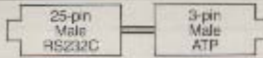
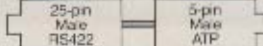
HP Vectra PC & IBM PC/AT cables

Vectra PC and IBM PC/AT to:	Description	Connector Description	Length	Original system cable no.	Order cable no.	Price
HP 3000	HP 3000 systems. Shielded.		9.9 ft. (3.0 m)	24542M	24542M*	\$ 55.00 ea.
	HP 3000 systems. Shielded.		16.7 ft. (5.0 m) 50.0 ft. (15.0 m)	(13242N)	13242-60001** 92218A**	\$100.00 ea. 110.00 ea.
	RS232C interface cable for HP 3000 ATP.		16.7 ft. (5.0 m)	(13242X)	92218D**	\$ 72.00 ea.
	RS422 interface cable for HP 3000 ATP.		16.7 ft. (5.0 m)	13242P	13242P**	\$ 79.00 ea.

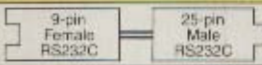
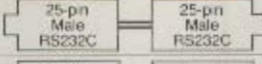
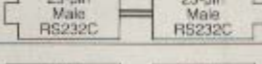
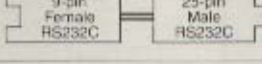
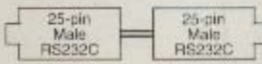
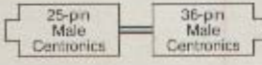
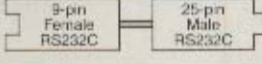
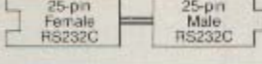
HP Vectra PC & IBM PC/AT cables (continued)

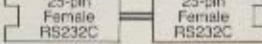
Vectra PC and IBM PC/AT to:	Description	Connector Description	Length	Original system cable no.	Order cable no.	Price
Modems	U.S./European modems. Shielded.		3.0m (9.9 ft.)	24542M	☑ 24542M*	\$ 55.00 ea.
	U.S. modems. Shielded.		5.0m (16.7 ft.) 15.0m (50.0 ft.)	(13242N)	13242-60001** 92218A**	\$100.00 ea. 110.00 ea.
	European modems. Shielded.		5.0m (16.7 ft.) 15.0m (50.0 ft.)	(13242M)	13242-60002** 92218B**	\$100.00 ea. 122.00 ea.
Printers	RS-232C printer cable for 2225D, 2601A Opt. 826, 2603A, 2686A, 2686A Opt. 300, 2932A, 2934A. Shielded.		3.0m (9.9 ft.)	24542G	☑ 24542G*	\$ 55.00 ea.
	RS-232C printer cable for 2225D, 2601A Opt. 826, 2603A, 2686A, 2686A Opt. 300, 2932A, 2934A. Shielded.		5.0m (16.7 ft.)	(13242G)	☑ 13242-60010**	\$ 69.00 ea.
	Parallel (Centronics) printer cable for 2225C, 2686A Opt. 300, 2932A Opt. 042, 2934A Opt. 042. Shielded.		2.0m (6.6 ft.)	24542D	☑ 24542D***	\$ 55.00 ea.
Plotters	RS-232C plotter cable for 7440A Opt. 001, 7470A Opt. 001, 7475A Opt. 001, DraftPro or 758X. Shielded.		3.0m (9.9 ft.)	24542G	☑ 24542G*	\$ 55.00 ea.
	RS-232C plotter cable for 7440A Opt. 001, 7470A Opt. 001, 7475A Opt. 001, DraftPro or 758X. Shielded.		1.2m (3.9 ft.)		☑ 17255D**	\$ 40.00 ea.
	RS-232C cable for 7510A or 7550A. Shielded.		3.0m (9.9 ft.)	24542H	☑ 24542H*	\$ 55.00 ea.
	RS-232C cable for 7510A or 7550A. Shielded.		1.2m (3.9 ft.)	17255F	☑ 17255F**	\$ 40.00 ea.





*Requires built-in serial port. HP 24540A serial/parallel or 24541B dual RS-232/422 interface card (see page 131). For terminal emulation, AdvantusLink required (see P/N 86333F).

**Requires HP 24541B dual RS-232/422 interface card (see page 131). For terminal emulation, AdvantusLink required (see P/N 86333F).

***Requires built-in serial port or HP 24540B serial/parallel interface card.

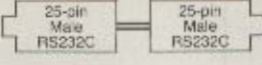
Printer cables

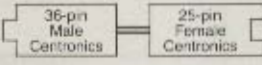
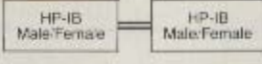
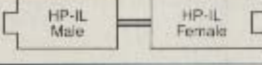
LaserJet, ThinkJet, QuietJet, QuietJet Plus, DeskJet, PaintJet & RuggedWriter 480 Printers

Printers to:	Description	Connector Description	Length	Original system cable no.	Order cable no.	Price
Touchscreen PC (HP 150)	RS-232C interface cable for ThinkJet (2225D), LaserJet family, QuietJet and QuietJet Plus (2227A). Shielded.		1.2m (3.9 ft.) 5.0m (16.7 ft.)	(13242G)	17255M† 13242-60010†	\$ 40.00 ea. 69.00 ea.
	RS-232C interface cable for LaserJet family. Shielded. Supports Xon/Xoff handshake only.		5.0m (16.7 ft.)		92219H	\$ 59.00 ea.
	Centronics (parallel) interface cable for ThinkJet (2225C), LaserJet PLUS (2686A Opt. 300), LaserJet 500 PLUS (2686D), QuietJet and QuietJet Plus (2227A). Shielded.		2m (6.6 ft.)		13242D*	\$ 55.00 ea.
	HP-IB interface cable for ThinkJet (2225A). Shielded.		1.0m (3.3 ft.) 2.0m (6.6 ft.) 4.0m (13.2 ft.) 0.5m (1.6 ft.)		10833A 10833B 10833C 10833D	\$ 80.00 ea. 90.00 ea. 100.00 ea. 80.00 ea.
	HP-IL interface cable for ThinkJet (2225B).		0.5m (1.6 ft.) 1.0m (3.3 ft.) 5.0m (16.7 ft.)		82167A* 82167B* 82167D*	\$ 6.00 ea. 8.00 ea. 10.00 ea.
HP Vectra PC, IBM PC/AT	RS-232C interface cable for ThinkJet (2225D), LaserJet family, QuietJet and QuietJet Plus (2227A). Shielded.		9.9 ft. (3.0 m)	24542G	24542G**	\$ 55.00 ea.



†Requires HP 45643A Extended I/O accessory (see page 133).

*Requires HP 24541B dual RS-232/422 interface card (see page 131).

**Requires built-in serial port, HP 24540B serial/parallel or 24541B dual RS-232/422 interface card.

Printer cables (continued)

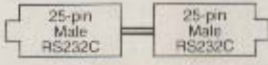
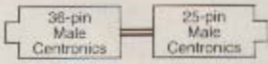
LaserJet, ThinkJet, QuietJet, QuietJet Plus, DeskJet, PaintJet & RuggedWriter 480 Printers

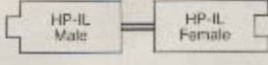
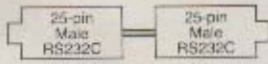
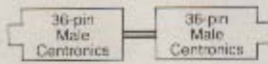
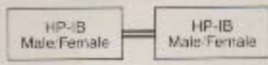
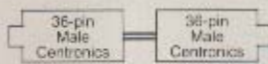
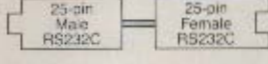
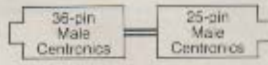
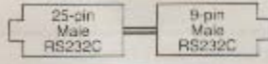
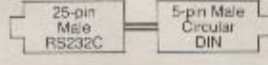
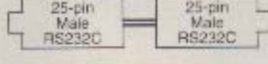
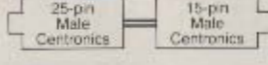
Printer to:	Description	Connector Description	Length	Original system cable no.	Order cable no.	Price
HP Vectra PC, IBM PC/AT	RS232C interface cable for ThinkJet (2225D), LaserJet family, QuietJet and QuietJet Plus (2227A). Shielded.		3.9 ft. (1.2 m) 16.7 ft. (5.0 m)	(13242G)	☐ 17255M* ☐ 13242-60010†	\$ 40.00 ea. 69.00 ea.
	Centronics (parallel) interface cable for ThinkJet (2225C), LaserJet PLUS (2686A Opt 300), LaserJet 500 PLUS (2686D), QuietJet and QuietJet Plus (2227A). Shielded.		6.6 ft. (2.0 m)	24542D	☐ 24542D**	\$ 55.00 ea.
PORTABLE, Portable PLUS	RS232C interface cable for ThinkJet (2225D), LaserJet family, QuietJet and QuietJet Plus (2227A). Shielded.		5.0 ft. (1.5 m)		☐ 92221P	\$ 42.00 ea.
	HP-IL interface cable for ThinkJet (2225B).		1.6 ft. (0.5 m) 3.3 ft. (1.0 m) 16.7 ft. (5.0 m)		☐ 82167A ☐ 82167B ☐ 82167D	\$ 6.00 ea. 8.00 ea. 10.00 ea.
	RS232C interface cable for ThinkJet (2225D), LaserJet family, QuietJet and QuietJet Plus (2227A). Shielded. Terminal requires 40210R interface.		16.7 ft. (5.0 m)	40242G	40242G 40210R	\$ 69.00 ea. 214.00 ea.
239X Terminals	Centronics (parallel) interface cable for ThinkJet (2225C), LaserJet PLUS (2686A Opt 300), LaserJet 500 PLUS (2686D), QuietJet and QuietJet Plus (2227A). Shielded. Terminal requires 40210P interface.		3.3 ft. (1.0 m)	40242D	40242D 40210P	\$ 97.00 ea. 214.00 ea.
	HP-IB interface cable for ThinkJet (2225A). For 2393A and 2397A only. Shielded. Terminal requires 40210H interface.		3.3 ft. (1.0 m) 6.6 ft. (2.0 m) 13.2 ft. (4.0 m) 1.6 ft. (0.5 m)		☐ 10833A ☐ 10833B ☐ 10833C ☐ 10833D 40210H	\$ 80.00 ea. 90.00 ea. 100.00 ea. 80.00 ea. 214.00 ea.
	Centronics (parallel) interface cable for ThinkJet (2225C). Shielded. Requires 82949A printer interface.		4.0 ft. (1.2 m)		☐ 82957A	\$ 60.00 ea.
IBM PC, PC/XT, Compaq, AT&T PC 6300	RS232C interface cable for ThinkJet (2225D), LaserJet family, QuietJet and QuietJet Plus (2227A). Shielded.		3.9 ft. (1.2 m) 16.7 ft. (5.0 m)		☐ 17255D ☐ 92219J	\$ 40.00 ea. 61.00 ea.
	Centronics (parallel) interface cable for ThinkJet (2225C), LaserJet PLUS (2686A Opt 300), LaserJet 500 PLUS (2686D), QuietJet and QuietJet Plus (2227A). Shielded.		9.0 ft. (2.7 m)		☐ 92219K	\$ 52.00 ea.
Apple Macintosh†	RS232C interface cable for ThinkJet (2225D), LaserJet family, QuietJet and QuietJet Plus (2227A). Shielded.		5 ft. (1.5 m)		☐ 92219M**	\$ 45.00 ea.
Apple IIc	RS232C interface cable for ThinkJet (2225D), LaserJet family, QuietJet and QuietJet Plus (2227A). Shielded.		5 ft. (1.5 m)		☐ 92219N	\$ 45.00 ea.
Apple IIe	RS232C interface cable for ThinkJet (2225D), LaserJet family, QuietJet and QuietJet Plus (2227A). Shielded.		9.9 ft. (3.0 m)		☐ 17355M	\$ 60.00 ea.
IBM Convertible, compatible lap tops, Zenith 171/181, Toshiba 1100+	Centronics (parallel) interface cable for ThinkJet (2225P) battery powered. Shielded with thumb screws.		3.3 ft. (1.0 m)		92219Z	\$ 51.00 ea.

*Requires HP 24541B dual RS232/422 interface card (see page 131)

**Macintosh Plus also requires Apple P/N 699-0372 Peripheral Adapter cable.

†ThinkJet and QuietJet Plus require JetStart software, HP 35177M, see page 38. LaserJet family requires Printworks software, HP 35179P, see page 23.

††Requires HP 24540B serial-parallel interface card.

2603A & 293X Printer cables

2603A & 293X to:	Description	Connector Description	Length	Original system cable no.	Order cable no.	Price
HP 3000	RS232C Interface cable for HP 3000 ADCC and ATP modem port. Shielded.		16.7 ft. (5.0 m)	(13242Y)	13242-60005	\$ 95.00 ea.
			50.0 ft. (15.0 m)		92218C	140.00 ea.
	RS232C Interface cable for HP 3000 ATP. Shielded.		16.7 ft. (5.0 m)	(13242X)	92218D	\$ 72.00 ea.
HP Vectra PC, IBM PC/AT	RS232C Interface cable. Shielded.		9.9 ft. (3.0 m)	24542G	24542G*	\$ 55.00 ea.
			16.7 ft. (5.0 m)	(13242G)	13242-60010**	69.00 ea.
	Centronics (parallel) Interface cable for 293X printers with Opt. 042 only. Shielded.		6.6 ft. (2.0 m)	24542D	24542D***	\$ 55.00 ea.
Touchscreen PC (HP 150)	RS232C Interface cable. Shielded.		3.9 ft. (1.2 m)		17255M	\$ 40.00 ea.
			16.7 ft. (5.0 m)	(13242G)	13242-60010	69.00 ea.
	HP-IB Interface cable for 293X printers with Opt. 046 only. Shielded.		3.3 ft. (1.0 m)		10833A	\$ 80.00 ea.
PORTABLE and Portable PLUS	RS232C Interface cable. Shielded.		5.0 ft. (1.5 m)	92221P	92221P	\$ 42.00 ea.
			16.7 ft. (5.0 m)	40242G	40242G	\$ 69.00 ea.
	Centronics (parallel) Interface cable for 293X printers with Opt. 042 only. Shielded. Terminal requires 40210R interface.		3.3 ft. (1.0 m)	40242D	40242D	\$ 97.00 ea.
239X Terminals	RS232C Interface cable. Shielded. Terminal requires 40210R interface.		16.7 ft. (5.0 m)	40242G	40242G	\$ 69.00 ea.
			3.3 ft. (1.0 m)	40242D	40242D	\$ 97.00 ea.
	HP-IB Interface cable for 2393A and 2397A terminals and 293X printers with Opt. 046 only. Shielded. Terminal requires 40210H interface.		3.3 ft. (1.0 m)		10833A	\$ 80.00 ea.
IBM PC, PC/XT, Compaq, AT&T PC 6300	RS232C Interface cable for 2603A printer only. Shielded.		3.9 ft. (1.2 m)		17255D	\$ 40.00 ea.
			16.7 ft. (5.0 m)	(13242N)	13242-60001	100.00 ea.

*Requires built-in serial port, HP 24540B serial-parallel or 24541B dual RS232/422 interface card (see page 131).

**Requires HP 24541B dual RS232/422 interface card (see page 131).

***Requires built-in serial port or HP 24540B serial-parallel interface card.

Plotter cables

ColorPro (7440A), 7470A, 7475A, 7510A, 7550A, DraftPro, DraftMaster & 758X Plotters

Plotter to:	Description	Connector Description	Length	Original system cable no.	Order cable no.	Price
HP 3000	RS422 Interface cable connects 7510A or 7550A to HP 3000 ATP.		16.7 ft. (5.0 m)		17855A	\$200.00 ea.
Touchscreen PC (HP 150)	RS232C Interface cable for ColorPro (7440A Opt. 001), 7470A Opt. 001, 7475A Opt. 001, DraftPro and 758X. Shielded.		3.9 ft. (1.2 m)		17255M	\$ 40.00 ea.
			16.7 ft. (5.0 m)	(13242G)	13242-60010	69.00 ea.
	RS232C Interface cable for 7510A or 7550A. Shielded.		3.9 ft. (1.2 m)		17255D	\$ 40.00 ea.
IBM PC, PC/XT, Compaq, AT&T PC 6300	RS232C Interface cable for 7470A Opt. 001, 7475A Opt. 001 or DraftPro with Touchscreen PC in terminal mode (eavesdrop). Both cables required. Shielded.		3.3 ft. (1.0 m)		17455A† and	\$ 75.00 ea.
			16.7 ft. (5.0 m)	(13242N)	13242-60001	100.00 ea.
	RS232C Interface cable for 7510A, 7550A or 758X with Touchscreen PC in terminal mode (eavesdrop). Shielded.		9.9 ft. (3.0 m)		17355M or	\$ 60.00 ea.
			16.7 ft. (5.0 m)	(13242N)	13242-60001	100.00 ea.

†Piggyback male and female RS232C (Y-cable) supports eavesdrop mode.

ColorPro (7440A), 7470A, 7475A, 7510A, 7550A, DraftPro, DraftMaster & 758X Plotters

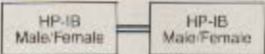
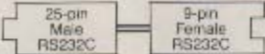
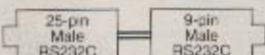
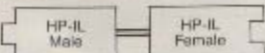
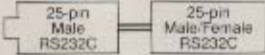
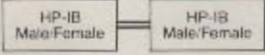
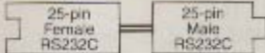
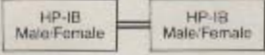
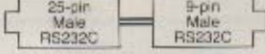
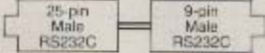
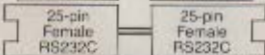
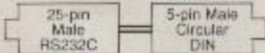
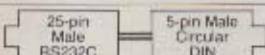
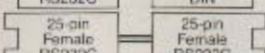
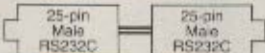
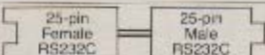
Plotter to:	Description	Connector Description	Length	Original system cable no.	Order cable no.	Price		
Touchscreen PC (HP 150) (continued)	HP-IB Interface cable for ColorPro (7440A Opt. 002), 7470A Opt. 002, 7475A Opt. 002, 7510A, 7550A, DraftPro†† and 758X. Shielded.		3.3 ft. (1.0 m)		☐ 10833A	\$ 80.00 ea.		
			6.6 ft. (2.0 m)		☐ 10833B	90.00 ea.		
			13.2 ft. (4.0 m)		☐ 10833C	100.00 ea.		
			1.6 ft. (0.5 m)		☐ 10833D	80.00 ea.		
HP Vectra PC, IBM PC/AT	RS232C Interface cable for ColorPro (7440A Opt. 001), 7470A Opt. 001, 7475A Opt. 001, DraftPro and 758X. Shielded.		9.9 ft. (3.0 m)	24542G	☐ 24542G*	\$ 55.00 ea.		
			3.9 ft. (1.2 m)		☐ 17255M**	\$ 40.00 ea.		
			16.7 ft. (5.0 m)	(13242G)	☐ 13242-60010**	69.00 ea.		
			9.9 ft. (3.0 m)	24542H	☐ 24542H*	\$ 55.00 ea.		
PORTABLE and Portable PLUS	RS232C Interface cable for ColorPro (7440A Opt. 001), 7470A Opt. 001, 7475A Opt. 001. Shielded.		3.9 ft. (1.2 m)		☐ 17255D**	\$ 40.00 ea.		
			16.7 ft. (5.0 m)		☐ 17255D**	\$ 40.00 ea.		
			5.0 ft. (1.5 m)		☐ 92221P	\$ 42.00 ea.		
			HP-IL Interface cable for 7470A Opt. 003.		1.6 ft. (0.5 m)		☐ 82167A	\$ 6.00 ea.
2393A, 2397A Terminals	RS232C Interface cable for 7470A Opt. 001, 7475A Opt. 001 or DraftPro in terminal mode (eavesdrop). Both cables required. Shielded.		3.3 ft. (1.0 m)		☐ 17455A ¹ and	\$ 75.00 ea.		
			16.7 ft. (5.0 m)	40242M	40242M	69.00 ea.		
			9.9 ft. (3.0 m)		☐ 17355M or	\$ 60.00 ea.		
			16.7 ft. (5.0 m)	40242M	40242M	69.00 ea.		
			HP-IB Interface cable for ColorPro (7440A Opt. 002), 7470A Opt. 002, 7475A Opt. 002, 7510A, 7550A, DraftPro†† and 758X. Shielded. Terminal requires 40210H interface.		3.3 ft. (1.0 m)		☐ 10833A	\$ 80.00 ea.
			6.6 ft. (2.0 m)		☐ 10833B	90.00 ea.		
13.2 ft. (4.0 m)		☐ 10833C	100.00 ea.					
IBM PC, PC/XT, Compaq, AT&T PC 6300	RS232C Interface cable for ColorPro (7440A Opt. 001), 7470A Opt. 001, 7475A Opt. 001, DraftPro DraftMaster and 758X. Shielded.		3.3 ft. (1.0 m)		☐ 17255D	\$ 40.00 ea.		
			3.3 ft. (1.0 m)		☐ 17255F	\$ 40.00 ea.		
			HP-IB Interface cable for ColorPro (7440A Opt. 002), 7470A Opt. 002, 7475A Opt. 002, 7510A, 7550A, DraftPro†† and 758X. Shielded. Terminal requires 40210H interface.		1.6 ft. (0.5 m)		☐ 10833D	80.00 ea.
			40210H	214.00 ea.				
Apple Macintosh[†]	RS232C Interface cable for ColorPro (7440A Opt. 001), 7470A Opt. 001, 7475A Opt. 001, DraftPro DraftMaster and 758X. Shielded.		5 ft. (1.5 m)		☐ 92219M	\$ 45.00 ea.		
			RS232C Interface cable for 7510A or 7550A. Both cables required. Shielded.		5 ft. (1.5 m)		☐ 92219M and	\$ 45.00 ea.
						☐ 92224F	25.00 ea.	
			Apple IIc	RS232C Interface cable for ColorPro (7440A Opt. 001), 7470A Opt. 001, 7475A Opt. 001, DraftPro and 758X. Shielded.		5 ft. (1.5 m)		☐ 92219N
RS232C Interface cable for 7510A or 7550A. Both cables required. Shielded.		5 ft. (1.5 m)					☐ 92219N and	\$ 45.00 ea.
						☐ 92224F	25.00 ea.	
Apple IIe	RS232C Interface cable for ColorPro (7440A Opt. 001), 7470A Opt. 001, 7475A Opt. 001, DraftPro DraftMaster and 758X. Shielded.					9.9 ft. (3.0 m)		☐ 17355M
			RS232C Interface cable for 7510A or 7550A. Shielded.		9.9 ft. (3.0 m)		☐ 17355D	\$ 60.00 ea.

[†]Piggyback male and female RS232C (Y-cable) supports eavesdrop mode.



^{††}Requires 17570A HP-IB interface, available separately.

¹Requires built-in serial port or HP 24540B serial/parallel or 24541B dual RS232C/422 interface card (see page 131).

^{**}Requires HP 24541B dual RS232C/422 interface card (see page 131).

^{†††}Macintosh Plus also requires Apple P/N 699-0372, Peripheral Adaptor cable.

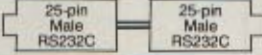
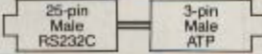
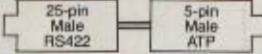
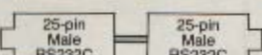
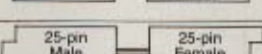
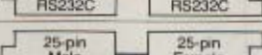
Terminal cables

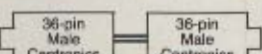
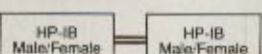
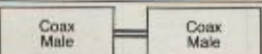
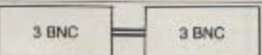
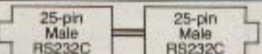
Terminal to:	Description	Connector Description	Length	Original system cable no.	Order cable no.	Price
HP 3000	U.S./European modem cable. Shielded.		16.7 ft. (5.0 m)	40242M	40242M	\$ 69.00 ea.
	RS232C interface cable for direct connect to HP 3000 ATP.		16.7 ft. (5.0 m)	40242X	40242X	\$ 69.00 ea.
	RS422 interface cable for direct connect to HP 3000 ATP.		16.7 ft. (5.0 m)	40242P	40242P	\$ 69.00 ea.
	RS232C interface cable for direct connect to HP 3000, protected against lightning-induced transients. Shielded.		16.7 ft. (5.0 m)	40242Y	40242Y	\$ 97.00 ea.
	RS232C extension cable.		16.7 ft. (5.0 m)	40242C	40242C	\$ 97.00 ea.
	RS232C modem bypass cable used with HP 12966 interface PCA.		16.7 ft. (5.0 m)	40242Z	40242Z	\$ 97.00 ea.
Printers	RS232C interface cable for serial printers such as ThinkJet (2225D) and QuietJet Plus (2227A). Shielded. Requires 40210R interface.		16.7 ft. (5.0 m)	40242G	40242G 40210R	\$ 69.00 ea. 214.00 ea.
	Centronics type (parallel) interface cable for printers such as ThinkJet (2225C) and QuietJet Plus (2227A). Shielded. Requires 40210P interface.		3.3 ft. (1.0 m)	40242D	40242D 40210P	214.00 ea. 214.00 ea.
HP-IB Printers & Plotters (2393A and 2397A only)	HP-IB interface cable for printers such as ThinkJet (2225A) and plotters such as 7475A Opt. 002. Shielded. Terminal requires 40210H interface.		3.3 ft. (1.0 m)		10833A	\$ 80.00 ea.
			6.6 ft. (2.0 m)		10833B	90.00 ea.
			13.2 ft. (4.0 m)		10833C	100.00 ea.
			1.6 ft. (0.5 m)		10833D	80.00 ea.
Video Display	Composite video cable for 2393A.		1.5 ft. (0.4 m)		40242V	\$ 25.00 ea.
	RGB video cable for 2397A.		1.5 ft. (0.4 m)		40242R	\$ 40.00 ea.
Modems	U.S./European modem cable. Shielded.		16.7 ft. (5.0 m)	40242M	40242M	\$ 69.00 ea.



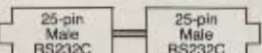

HP 3000 cables

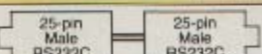
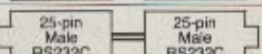
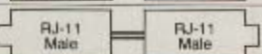
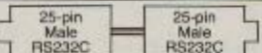
HP 3000 to:	Description	Connector Description	Length	Original system cable no.	Order cable no.	Price
Modems	Connects HP 3000 to modem types 103.212 and 202S. Shielded.		25 ft. (7.6 m)	(30062B)	30062-60022	\$ 72.50 ea.
			50 ft. (15.0 m)	(30062B Opt. 001)	30062-60023	92.50 ea.

Multiplexer cables

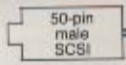
System	Description	Connector Description	Length	Original system cable no.	Order cable no.	Price
98642A Multiplexer	Direct connect cable		50 ft. (15.0 m)		92219R	\$ 55.00 ea.
	Modem cable		16.7 ft. (5.0 m)		92219S	\$ 55.00 ea.
	RJ-11 cable		50 ft. (15.0 m)		92219T	\$ 21.00 ea.
	RJ-11 to RS232C adapter plug. Adapter consists of RJ-11 female and RS232C male.			2 in. x 2.3 in. (5 cm x 6 cm)		92219U
27140A Multiplexer	Modem cable		16.7 ft. (5.0 m)		92219Q	\$ 55.00 ea.

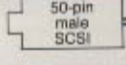
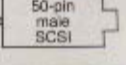
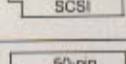
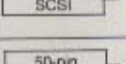
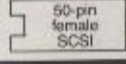
SCSI (Small Computer System Interface) cables

HP 9000 Series 300 CPU to:	Description	Connector Description	Length	Product number	Price
SCSI fixed disc drive	SCSI peripheral interface cable for fixed disc desktop drives (795XS). Shielded.	 — 	0.5m (1.6 ft.)	92222A	\$49.00 ea.
		 — 	1.0m (3.3 ft.)	92222B	55.00 ea.
		 — 	2.0m (6.6 ft.)	92222C	59.00 ea.
	SCSI peripheral interface cable for fixed disc desktop drives (795XS). Shielded.	 — 	1.0m (3.3 ft.)	92222D	\$55.00 ea.

HELPFUL IDEAS!—Use these drawings of connectors to help identify the types you need.

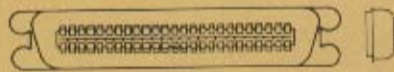

50-pin male (for 262X Terminals).

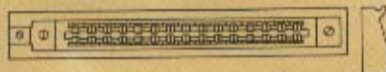

30-pin female (for 264X Terminals)
48-pin female connector, not shown.

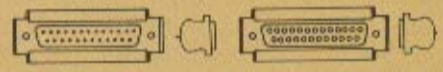

male and female standard 25-pin RS232C connectors.

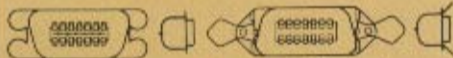

male and female 14-pin multipoint cable connectors.

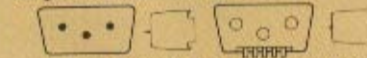

male and female 3-pin connectors for HP 3000 ATP RS232C interface.
male and female 5-pin connectors for HP 3000 ATP RS422 interface.*

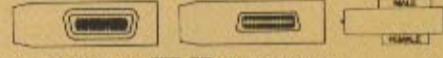

male/female HP-IB connectors.

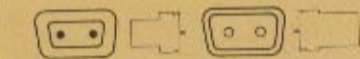

male and female HP-IL connectors.

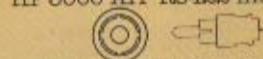

male coaxial (video) connector.

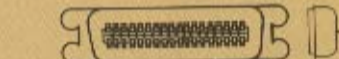

male and female 36-pin Centronics-type connector.

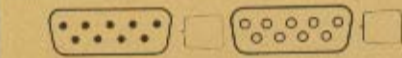

male and female 9-pin sub-miniature D connector.



male 5-position circular DIN.



male RJ-11 plug.

*Same shape as 3-pin ATP connectors but with 5 pins.

We ship same day

CALL HP DIRECT
800-538-8787

You can now get these test & measurement accessories shipped the same day you order:



- Probes
- Rack mounts
- Recorder paper
- Instruments
- Test leads

Check off your instrument interests on the catalog subscription card and we'll send you the latest Test & Measurement Accessories Catalog from HP DIRECT. Available in the U.S. only.

DISC & TAPE PRODUCTS

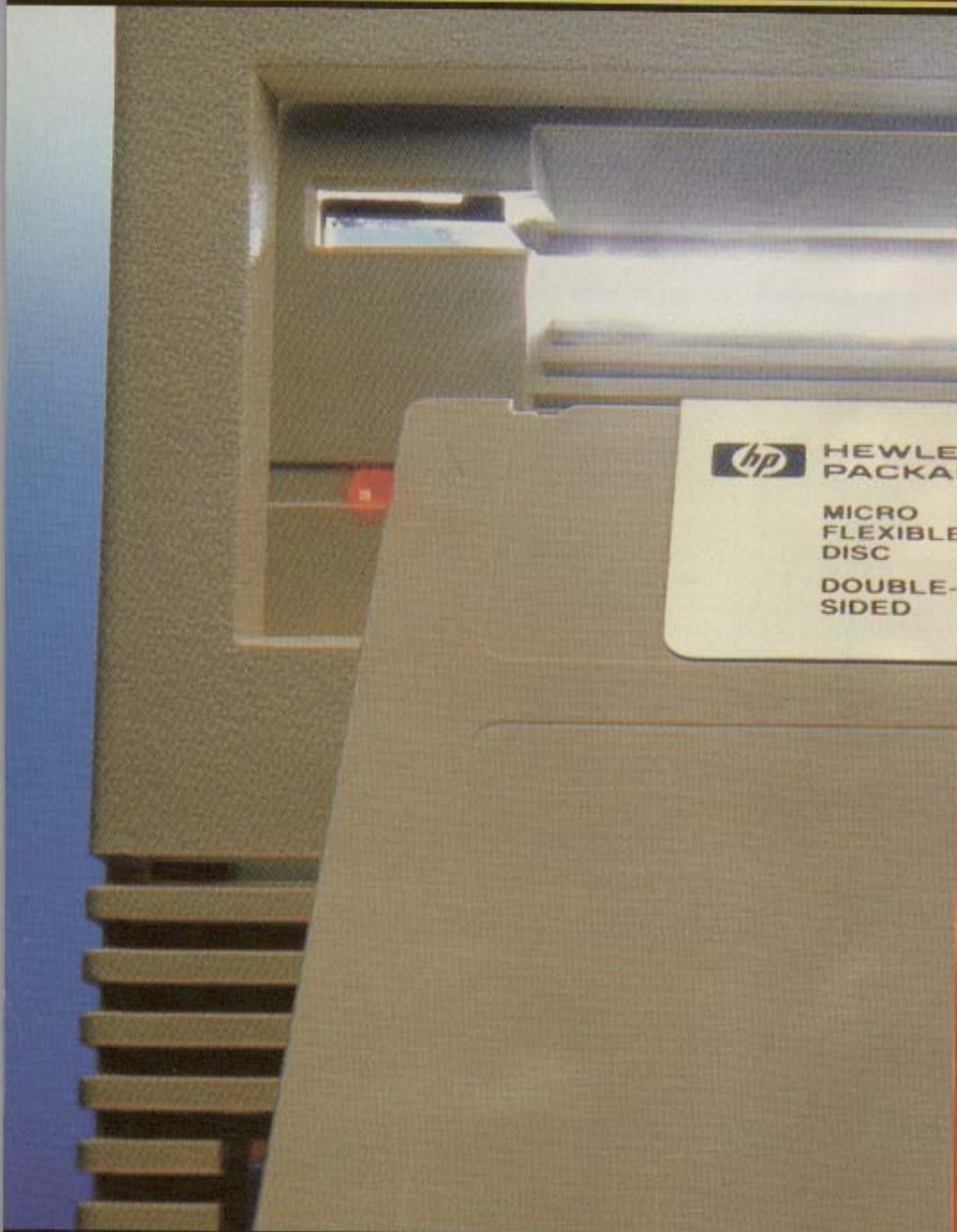

HP 3.5-inch discs...Hewlett-Packard pioneered their broad use more than four years ago. That makes HP's track record with microfloppies one of the longest in the industry. Turn the page to learn more about the only flexible discs tried, tested and approved for use on HP disc drives.

3.5-inch discs	84
5.25-inch discs	84
8-inch discs	85
Disc storage accessories.....	86
Data cartridges.....	89
Cartridge/cassette accessories	91
Rigid discs.....	92
Magnetic tape.....	94
Cleaning accessories	96



"After investing \$50,000 in test equipment and six months of my time, why would I want to scrimp on the discs?"

"As the project engineer, I'm conducting experiments that require me to run aging tests over a six-month period. I gather data from all these tests and at the end of the six months the data is correlated. All the test results end up on three and one-half inch discs. I want to be sure the data is still there when I come back. With HP's quality, I've got the best chance I can get."

Steve Weiss
Steve Weiss, project engineer
Astac USA (HK), Ltd., division of BSR
OEM supplier of high-volume consumer
and industrial electronics

Buy the only flexible discs manufactured, tested and certified to match HP disc drives—HP 3.5-inch and 5.25-inch discs

At HP we're proud of our reputation for quality. It's an image we've earned through years of precision manufacturing to the highest standards. In the case of HP discs, quality starts with exacting specifications: for wear life, error rate, and production consistency. Then the testing begins: in the lab, during manufacturing, and at final certification before shipment. From the oxide coating to the parametrics of temperature and humidity, attention to the smallest detail results in premium discs we warrant to be error-free for five years.

There's another vital consideration. HP discs are precisely engineered to match the unique features of HP drives. To ensure a perfect match, HP research engineers set exacting specifications to define the "optimum" (not merely "compatible") discs for use in HP disc drives.

Behind the HP label is a disc guaranteed to be 100% error free for five years! And that's a promise we put in writing.



"When you buy discs, consider the total cost as well as the price."

"A customer shipped his HP 82901 disc drive back to us for repair. The repair cost is going to be \$460 plus lost time and data. All the damage to the drive was caused by the non-HP flexible disc the customer used. Even though it was a "name brand" disc, it wasn't manufactured to HP specifications for our disc drives. When you buy discs, consider the total cost as well as the price."

Gary Paulson
Gary Paulson
HP field service repair supervisor



HP 3.5-inch micro-floppy discs:

Hewlett-Packard pioneered the development of 3.5-inch microfloppy discs over five years ago. And we've improved them every year since. Microflopies provide maximum performance with HP 3.5-inch disc drives. Available single or double-sided, in 270Kb or 710Kb formatted capacity. Plus high density 1.42/1.44Mb discs for use in 1.42 and 1.44Mb disc drives.



HP 5.25-inch flexible discs:

Order standard 360KB double-sided unformatted discs or the high capacity 1.2MB discs. Use 1.2MB capacity with the HP Vectra PC's high capacity internal disc drive.

See next page for ordering information.

"We have never had a failure with an HP disc"

"Why do I prefer HP discs? First of all, it's easy to order. We pick up the phone and call HP DIRECT. Within one to two days the goods are delivered. So, the convenience is very important to us. And, technically, the assurance of top quality is just as important. A programmer's time is valuable. When you lose a program, you have often lost days of work. The best way to protect against that is to have quality media."

Herb Pardula, v.p. of engineering
SAT, SYSTEMS FOR AUTOMATIC TEST
Supplier of Microwave ATE based on
HP computers and instrumentation.

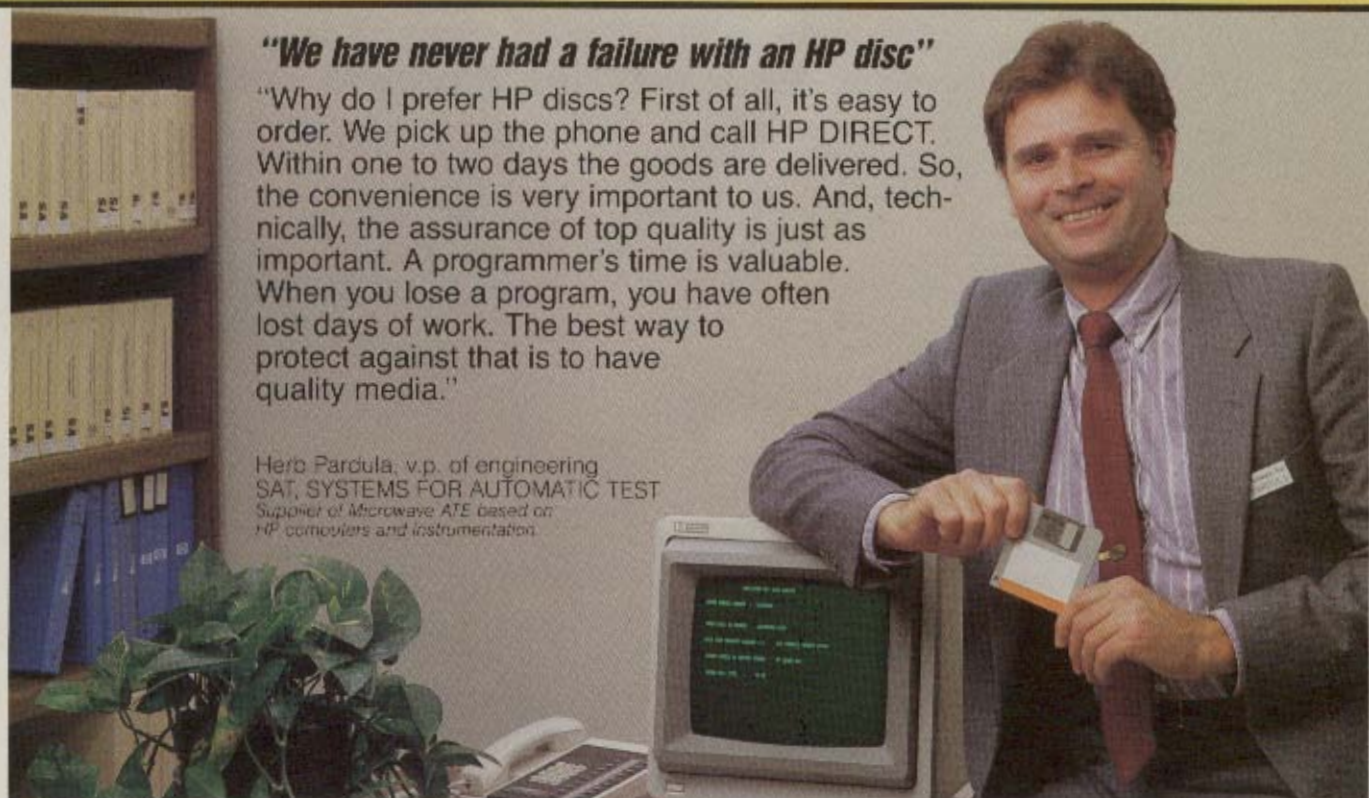

3.5-inch Microfloppy discs

Description	Use with HP disc drives & storage systems	Product number	Price
Box of 10, 3.5-inch, single-sided, auto-shutter, unformatted, 270 KByte (formatted capacity).	HP 9121D/S, 9133A/B, 9133V/XV disc drives.	92191A	(box/10 discs) \$29.00 box (2-4) 25.00 box (5-19) 23.00 box (20+) 21.00 box
Box of 10, 3.5-inch, double-sided, auto-shutter, unformatted, 710/720 KByte (HP formatted capacity).	HP 45813A, 9114A/B, 9122D/S, 9123D, 9133D/H/L, 9153A/B/C disc drives, HP Portable Vectra CS, HP Vectra CS/ES/RS and Touchscreen (HP 150) PCs.	92192A	(box/10 discs) \$39.00 box (2-4) 35.00 box (5-19) 32.00 box (20+) 29.00 box
Box of 100, 3.5-inch, double-sided, auto-shutter, unformatted, 710/720 KByte (HP formatted capacity).	HP 45813A, 9114A/B, 9122D/S, 9123D, 9133D/H/L, 9153A/B/C disc drives, HP Portable Vectra CS, HP Vectra CS/ES/RS and Touchscreen (HP 150) PCs.	92192N	(box/100 discs) \$279.00 box (2-4) Buy 100 pack 249.00 box (5-) & save 16% 229.00 box
Package of 250, multi-colored disc labels for use with 92192N above.		92192R	(per pkg of 250 labels) \$19.95 pkg.
Box of 10, 3.5-inch, high-density, double-sided, auto-shutter, unformatted, 1.42/1.44 MByte (formatted capacity). NOTE: For use with 1.42/1.44 MByte disc drives only.	HP 45813A, 9122C and 9153C disc drive, HP Portable Vectra CS and HP Vectra CS/RS/ES PCs.	92192X	(box/10 discs) \$79.00 box (2-4) 73.00 box (5-19) High density 68.00 box (20+) 63.00 box

5.25-inch Flexible discs

Description	Use with HP disc drives & storage systems	Product number	Price
Box of 10, 5.25-inch, double-sided, unformatted, 360 KByte (formatted capacity).	HP 45811A, 82901M, 82902M, 9125S, 9127A, 9135A disc drives, 9826, 9836 computers and HP Vectra CS/ES/RS PCs.	92190A	(box/10 discs) \$25.00 box (2-4) 22.00 box (5-19) 20.00 box (20+) 18.00 box
Package of 50 in 5 FlexFiles, 10 discs per FlexFile, 5.25-inch, double-sided, unformatted, 360 KByte (formatted capacity).	HP 45811A, 82901M, 82902M, 9125S, 9127A, 9135A disc drives, 9826, 9836 computers and HP Vectra CS/ES/RS PCs.	92190L	(pkg/50 discs) \$99.00 pkg. (2-4) 94.00 pkg. (5-) 89.00 pkg.
Box of 100, 5.25-inch, double-sided, unformatted, 360K-byte (formatted capacity).	HP 45811A, 82901M, 82902M, 9125S, 9127A, 9135A disc drives, 9826, 9836 computers and HP Vectra CS/ES/RS PCs.	92190N	(box/100 discs) \$166.00 box (2-4) 153.00 box (5+) 142.00 box
Box of 10, 5.25-inch, high-capacity, double-sided, unformatted, 1.2 MByte (formatted capacity).	HP 45812A, Vectra PC's high-capacity 1.2 MByte internal drive and HP Vectra ES/RS PCs.	92190X	(box/10 discs) \$49.00 box (2-4) Buy 100 pack 44.00 box (5-19) & save 15% 40.00 box (20+) 36.00 box
Box of 100, 5.25-inch, high-capacity, double-sided, unformatted, 1.2 MByte (formatted capacity).	HP 45812A, HP Vectra PC's high-capacity 1.2 MByte internal drive and HP Vectra ES/RS PCs.	92190Z <i>new!</i>	(box/100 discs) \$340.00 box (2-4) High-capacity 306.00 box (5-19) High-capacity 272.00 box (20-99) 238.00 box

Rely on HP 8-inch flexible discs for error-free performance



Five year warranty

HP flexible discs make a difference

When you buy HP flexible discs, you are assured they are carefully matched to your HP disc drives for optimum performance. We select flexible discs for the HP label only after rigorous qualification tests based on three key characteristics—disc wear life, error rate, and the disc manufacturer's ability to consistently meet our specifications without batch-to-batch variations.

Added value

HP discs are tested over the entire disc surface, not just the tracks, to ensure a 100 percent error-free surface. To provide you with precision performance time after time, each track and the space in-between tracks is tested with micro-processor-controlled certifiers that ensure each disc meets HP's high standards of excellence. An advanced burnishing method is used to polish the surface for the smoothest, most uniform result to assure you optimum signal quality and direct, easy-to-obtain data. A unique lubricant is applied to the disc which ensures totally error-free performance while minimizing your drive head wear... even after millions of passes.

HP flexible discs may be used on non-HP products where reliable, high performance discs are desired.

Five-year warranty

HP flexible discs are warranted to be free from defects in material and workmanship for five years after shipment or HP will replace the disc absolutely free. Any damage sustained to the heads or media, or any consequential damage resulting from the use of non-HP media or cleaned disc media in HP equipment is excluded from warranty or service contract coverage, but will be repaired subject to HP's standard time and material charges. Use of non-HP media or cleaned disc media, however, does not affect warranty or service contract coverage of other components of the disc drive not associated with the head-media interface.

8-inch Flexible discs

Each package contains 10 flexible discs in protective envelopes and includes write-protect, jacket and storage box labels.

Product number	Description	Use with HP disc drives & storage systems	Price
92195A	Box of 10, 8-inch, double-sided, unformatted, 1.2M-byte (formatted capacity).	HP 9895A	(1 box of 10 discs) \$61.00 box
			(2-4) 57.00 box
			(5-19) 53.00 box
			(20+) 49.00 box
9164-0105	Box of 10, 8-inch, single-sided, unformatted, 500K-byte (formatted capacity).	HP 9885M/S, HP 1000 Models 20 and 25 (2174A/B and 2175A/B subsystems)	(1 box of 10 discs) \$44.00 box
			(2-4) 41.00 box
			(5-19) 38.00 box
			(20+) 35.00 box
09885-90045	One 8-inch, single-sided, HP 9885/9825 formatted, 500K-byte capacity.	HP 9885M/S drives used with 9825A/S computers.	Single disc \$15.00 ea.

Select your favorite filing system for your 3.5-inch, 5.25-inch and 8-inch discs!

No more frantic searching for misplaced discs! Save yourself time and minimize disc damage with an HP disc storage system that keeps your discs organized, easy to locate, clean and protected. For your convenience, all 3.5-inch, 5.25-inch and 8-inch disc storage systems are listed together in this section, organized by desktop, shelf, drawer, and portable storage.

Roll-top files add a touch of class to your desktop

Enhance your office decor with these handsome roll-top files for storing your personal discs. The genuine rosewood cover lends richness to the file and also slides back and out of the way for easy access. Constructed of durable plastic to ensure long-lasting protection with elegant styling. Also features rubber anti-skid feet and built-in disc dividers.

92191R Roll-top file for 3.5-inch discs.
Capacity: 50 discs.
(1 unit) \$39.00 ea.
(2-4) 36.00 ea.
(5+) 33.00 ea.

92194N Roll-top file for 5.25-inch discs.
Capacity: 120 discs.
(1 unit) \$49.00 ea.
(2-4) 46.00 ea.
(5+) 43.00 ea.



Flip-top file offers instant access

Just flip up the hinged lid. The discs inside this practical desktop file are clearly displayed and readily accessible. Tabbed dividers and index labels are included to make it simple to organize your discs. Made of durable plastic, these files offer protection from office hazards such as dust, debris and moisture.

92191Q Compact file for 3.5-inch discs.
Capacity: 40 discs.
(1 unit) \$22.00 ea.
(2-4) 20.00 ea.
(5+) 18.00 ea.

92194A Compact file for 5.25-inch discs.
Capacity: 60 discs.
(1 unit) \$39.00 ea.
(2-4) 36.00 ea.
(5+) 33.00 ea.

Keep your 3.5-inch discs safe

Protect your microfloppy discs in this compact desktop file. Stores up to 60 discs in a durable acrylic case. Index dividers make it easy to organize your discs for easy retrieval. Also features a flip-up lid for easy access.

92191D Desktop file for 3.5-inch discs.
Capacity: 60 discs.
(1 unit) \$39.00 ea.
(2-4) 35.00 ea.
(5+) 30.00 ea.



Micro carrying case tucks compactly in a briefcase

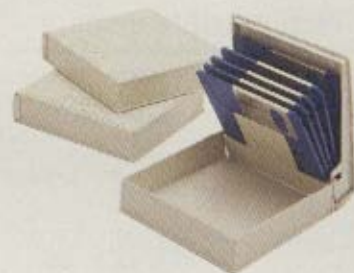

One of these micro carrying cases takes up so little space it's easy to safely transport up to five 3.5-inch discs in a briefcase. Pop-open case has self-locking lid for extra safety.

92191M Micro carrying case pack for 3.5-inch discs. Capacity: 5 discs each case.
(1 pkg. of 3 cases) \$10.50 pkg.

Interlocking units expand to fit your space.

Flexibility is built into this disc storage system. FlexFile units interlock on the sides, top or bottom, so you can stack units like building blocks—either vertically or horizontally. Just add new units as your needs expand and make the most of any work space. Your discs automatically flip forward for easy access when the FlexFile drawer opens. And when you need to transport discs, simply separate out a modular unit and take it with you. FlexFiles are constructed of tough polystyrene, for sturdy, dust-free protection. Includes adhesive index labels and instructions. Discs not included.



92191E FlexFiles for 3.5-inch discs. Package of five FlexFiles. Each FlexFile unit holds up to 10 discs.

(1 pkg.)	\$37.00 pkg.
(2-4)	34.00 pkg.
(5+)	29.00 pkg.

92194E FlexFiles for 5.25-inch discs. Package of five FlexFiles. Each FlexFile unit holds up to 10 discs.

(1 pkg.)	\$37.00 pkg.
(2-4)	34.00 pkg.
(5+)	29.00 pkg.

92194F FlexFiles for 8-inch flexible discs. Package of five FlexFiles. Each FlexFile unit holds up to 10 discs.

(1 pkg.)	\$37.00 pkg.
(2-4)	34.00 pkg.
(5+)	29.00 pkg.

Cushion your discs for safe transport.

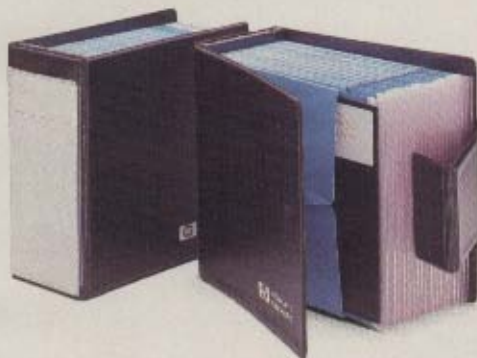

Fragile discs are protected whenever they must be carried from one place to another because of the unique features of this portable filing system. Crimped pockets cushion each disc to prevent wrinkles or bends. And finding the disc you need is easy with the aid of color-coded index stripes on each pocket. File organization is simplified by an index on outside spine for listing discs. The floating axle design eliminates additional stress if the binder is dropped. A Velcro fastener ensures that the vinyl cover stays securely closed.

92191F Portable album file for 3.5-inch discs. Capacity: 20 discs.

(1 unit)	\$43.00 ea.
(2-4)	40.00 ea.
(5+)	37.00 ea.

92194G Portable album file for 5.25-inch discs. Capacity: 20 discs.

(1 unit)	\$43.00 ea.
(2-4)	40.00 ea.
(5+)	37.00 ea.

92194H Portable album file for 8-in discs. Capacity: 20 discs.

(1 unit)	\$56.00 ea.
(2-4)	52.00 ea.
(5+)	49.00 ea.

Reduce visual clutter with matching designs.



Shelve your discs in library album books designed to duplicate the size, color and style of your boxed software manuals. Your 3.5-inch discs slide into vinyl album pages; the album fits inside a cloth-covered box. Complete with 10 static-resistant vinyl pages.

92191H Library album book for 3.5-inch discs. Capacity: 20 discs.

(1-4 books)	\$26.00 ea.
(5+)	19.00 ea.

Increase capacity by adding album pages

Expand the capacity of your 92191H library album book by adding more static-resistant vinyl pages. File cards are included to help identify each disc.

92191L Package of 20 pages for 3.5-inch discs. For use with 92191H. Capacity: 40 discs.

(1 pkg.)	\$26.00 pkg.
(2-4)	23.00 pkg.
(5+)	21.00 pkg.



Hanging file pages suspend discs in drawers or filing cabinets

Gain safety and convenience by hanging your discs in sturdy, vinyl pockets suspended from the rails of your filing cabinet. Available in either U.S. or European suspension frame sizes—U.S. 12.25-inch (311 mm) standard width and European 330 mm (13-inch) standard width. File cards are included to identify each disc.

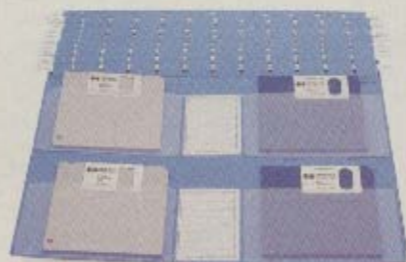

Hanging file pages for 5.25-inch discs.
Package of 10. Capacity: 20 discs.

- 92194P** (U.S.)
92195P (European)
(Discs not included.)
(1 pkg.) \$26.00 pkg.
(2-4) 23.00 pkg.
(5+) 20.00 pkg.



Hanging file pages for 3.5-inch discs.
Package of 10. Capacity: 40 discs.

- 92191P** (U.S.)
92191B (European)
(Discs not included.)
(1 pkg.) \$29.00 pkg.
(2-4) 26.00 pkg.
(5+) 23.00 pkg.

Micro disc case saves space and money

This durable plastic 3.5-inch micro disc case holds 10 microfloppy discs in library-like fashion for easy fingertip retrieval. The disc holder slides open to reveal your discs with step filing. Slide it closed and file snaps shut for library storage or for convenient transport. Disc identification and spine labels included.

- 92191T Micro disc case** for 3.5-inch discs.
Capacity: 10 discs.
(1 case) \$7.00 ea.



HELPFUL IDEAS!

Take your choice. Store discs on your desk, shelf, or cabinet.

HP Disc Storage	Style	Disc storage capacity						Product number	Page no.
		10	15	20	40	60	120		
On your desktop	3.5" flip top				•			92191Q	86
	3.5" flip top					•		92191D	86
	3.5" roll top					•		92191R	86
	5.25" flip top					•		92194A	86
	5.25" roll top						•	92194W	86
On your shelf	3.5" album			•				92191F	87
	3.5" album			•				92191H	87
	3.5" FlexFiles					•		92191E	87
	5.25" album			•				92194G	87
	5.25" FlexFiles					•		92194E	87
	8.0" album			•				92194H	87
	8.0" FlexFiles					•		92194F	87
In your desk drawer	3.5" hanging file				•			92191P (U.S.) 92191G (European)	88
	5.25" hanging file			•				92194F (U.S.) 92195P (European)	88
Portable storage	3.5" micro case	•						92191T	88
	3.5" micro case		•					92191M	86

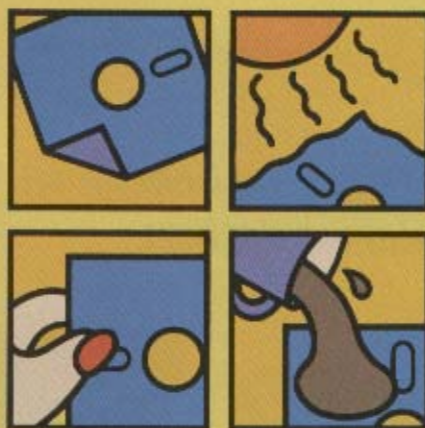

Handle with care. If left exposed, discs are easily damaged by dust, heat, fingerprints, bending and accidental spills. The critical data on your discs deserves to be protected from these hazards. To help you select the system that is best for you, refer to the chart on the left.

Certified, high-density data cartridges offer reliable backup



For use with HP 7908/11/12/14, 9144A, 7942A, 7946A and 35401A tape drives.

Don't take a chance with anything less than the best for your valuable backup files. These high-density, formatted and certified HP data cartridges provide dependable backup with the HP drives listed above. Secondary uses are data exchange among HP systems, software distribution and data/transaction logging. Because these data cartridges are already certified, you save up to 15 minutes per 150-foot tape and up to 75 minutes per 600-foot tape. Formatted into 1K user data blocks.

NOTE: Be sure to order the correct tape cartridge for your tape drive. The 88140LC/SC data cartridges shown here and the 92242L/S data cartridges below cannot be used interchangeably.

88140LC Box of five formatted and certified cartridges. 600-foot, 67 MByte, 16-track, 1/4 inch wide tape, each with own protective plastic box and labels.

(1 box of 5 cartridges)	\$219.00 box
(2-4)	207.00 box
(5-19)	192.00 box
(20-99)	185.00 box
(100+)	178.00 box

88140SC Box of five formatted and certified cartridges. 150-foot, 16 MByte, 16-track, 1/4 inch wide tape, each with own protective plastic box and labels.

(1 box of 5 cartridges)	\$169.00 box
(2-4)	159.00 box
(5-19)	149.00 box
(20+)	142.00 box

Certify off-line with HP 9142 drives

For use with 9142A tape drives only.

These data cartridges are designed and tested to work expressly with the unique features of the HP 9142A tape drive. You can format, initialize and certify these data cartridges off-line without tying up your host Touchscreen (HP 150), Vectra or IBM PC/XT/AT. These 1/4-inch, 16 track data cartridges are available in 150-foot and 600-foot lengths. They are unformatted and uncertified.

NOTE: 92242L/S data cartridges can only be used with HP 9142A tape drives.



92242L Box of five data cartridges, 600-foot length, each in plastic box. Touchscreen (HP 150) 52M-bytes formatted storage, HP Vectra and IBM PC/XT/AT 60M-bytes formatted storage.

(1 box of five cartridges) ...	\$189.00 box
(2-4)	175.00 box
(5-19)	165.00 box
(20+)	155.00 box

92242S Box of five data cartridges, 150-foot length, each in plastic box. Touchscreen (HP 150) 13M-bytes formatted storage, HP Vectra and IBM PC/XT/AT 15M-bytes formatted storage.

(1 box of five cartridges) ...	\$139.00 box
(2-4)	127.00 box
(5-19)	120.00 box
(20+)	113.00 box

Simplify backup routines and save time

The HP 35401A 1/4-inch Cartridge Auto-changer Tape Drive helps simplify operations by providing unattended backup storage. With the addition of several 92192C tape cartridge magazines, each with its own set of cartridges, you can rotate through the sets of cartridges and make backup simple for your operators. Loading and unloading of cartridges is easy and the potential for operator error is reduced. Holds up to eight standard 1/4-inch cartridges (up to 536 Mb of storage).

92192C Tape cartridge magazine

(1-2)	\$65.00 ea.
(3-5)	55.00 ea.
(6+)	45.00 ea.



HELPFUL IDEAS!

How to choose the right HP data cartridges, cassettes and storage accessories for your equipment

1. Look for your HP tape drive in column 1 below.
2. Select the compatible data cartridge or cassette from column 2.
3. Choose the storage accessories for each product from column 3.

1	HP tape drive	2	Cartridge/cassette product number	Page number	3	Storage accessories	Page number
	35401A, 7908/11/12/14, 7942A, 7946A, 9144A, 7946A, 9144A		88140LC and 88140SC	89		92167F and 92167L	91
			92242L and 92242S	89		92167F and 92167L	91
	9142A		98200A for all drives at left	90		92167M, 92167N, and 92192Q	91
	264X terminals, HP 85A, 9815, 9825, 9831, 9835, 9845, 9875A, 9877A, 9915		82176A	90			
	82161A		9162-0050	90			

NOTE: The 88140LC/SC and 92242L/S data cartridges are incompatible and cannot be used interchangeably. The 92242 L/S works only with the 9142A tape drive.

Choose HP digital tape cassettes for reliability

Individual digital cassette with HP label and index card comes sealed in plastic storage box. Use with HP 9821A Calculator, 9830A/B Desktop Computer, 9865A Cassette Memory and non-HP products requiring high-quality digital cassettes.

9162-0050 Individual digital cassettes

- (1-9 cassettes) \$11.00 ea.
- (10-99) 8.50 ea.
- (100+) 7.50 ea.

Mini data cassette stores up to 128K bytes on each cassette. For use on HP 82161A Digital Cassette Drive. Comes in package of 10 cassettes.

82176A Mini data cassettes

- (1 package of 10) \$95.00 pkg.



Superior manufacturing means longer life

Through HP's well-engineered manufacturing process, our HP 98200A mini data cartridges offer better turn-on (start-up) and longer operating life—a minimum of 6000 cycles in most general use applications.

These rugged storage devices are each 100 percent tested mechanically (for proper tape tension and drive force requirements) and electromagnetically for error-free data recording. Metal backplate construction helps ensure accurate alignment of tape guides and other inter-

nal parts while providing a grounding surface to protect the mini cartridge from effects of static electricity.

Use HP 98200A mini data cartridges with HP Series 1000 and 3000 Computer Systems; HP Series 264X Display Termi-

nals; HP 85A, 9815A/S, 9825A/S, 9831A/B (System 35) and 9845A/B/C/S/T (System 45) Desktop Computers; HP 9915A option 001 Modular Computer, and 9875A, 9877A Tape Units.

98200A Mini data cartridges

- (1 box of 5 cartridges) \$95.00 box
- (2-4) 85.00 box
- (5-19) 76.00 box
- (20+) 67.00 box

NOTE: All mini cartridges work best when "conditioned" before use (by making one total forward/rewind cycle) and rewound after each use.



Compact storage that's easy to expand

Store six 98200A mini data cartridges in the front cover of this padded vinyl storage binder. Then add insert pages as needed to increase storage capacity to 12-18 cartridges. Each cartridge, enclosed in its protective plastic box, is held securely in a molded compartment. Related documentation can be inserted in the center three rings or the back cover pocket.

92167M Storage Binder for use with 98200A mini data cartridges.
 (1 binder) \$21.00 ea.
 (2-4) 19.00 ea.
 (5+) 17.00 ea.

Add to the storage capacity of the 92167M binder with a package of three insert pages. Each insert page holds six 98200A mini data cartridges. Sturdy brass-ringed eyelets and molded storage compartments are the same high quality design and construction as the 92167M binder.

92167N Storage Binder Inserts for 92167M storage binder. For use with 98200A mini data cartridges.
 (1 pkg. of 3 inserts) \$21.00 pkg.
 (2-4) 19.00 pkg.
 (5+) 17.00 pkg.

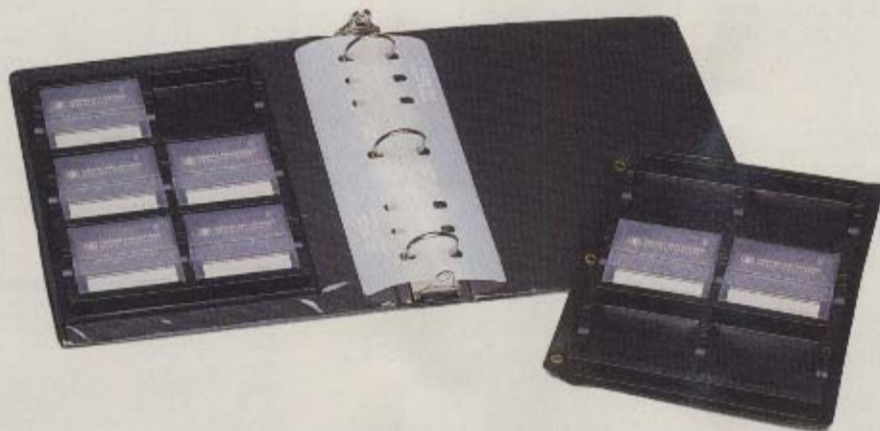

Secure data cartridges in a locked tray



Keep your 88140LC/SC and 92242L/S data cartridges safe and organized in this handsome new storage tray. Features a key-locking, removable lid, which nests under the base when not in use. Constructed of durable high-impact plastic with transparent anti-static acrylic lid. Cream-colored base with molded slots holds up to 10 data cartridges securely in place.

92167F Data Cartridge Tray for use with 88140LC/SC and 92242L/S data cartridges.
 (1-2 units) \$45.00 ea.
 (3-6) 42.00 ea.
 (7+) 39.00 ea.



Albums make data cartridges easy to store, easy to carry.

Now you can store and transport your 88140LC/SC and 92242L/S data cartridges in a dust-free album that helps eliminate the mishandling and misplacing of individual cartridges. The albums are constructed of sturdy vinyl and hinged for easy access. Each album holds four cartridges.

92167L Storage Album for use with 88140LC/SC or 92242L/S data cartridges.
 (1 pkg. of 5 albums) \$34.00 pkg.
 (2-4) 31.00 pkg.
 (5+) 29.00 pkg.

Organize up to 18 mini data cartridges under lock and key.

Here's a convenient way to organize your 98200A or 92192T mini data cartridges, while protecting them from dust, spills and "casual borrowing." This locking tray includes tabbed dividers and labels for quick identification and access, and a back-up key in case you misplace the original. A detachable hinge lets you nest the clear acrylic, anti-static lid under the cream-colored, high-impact plastic base, cutting desk-top clutter so you have room to get down to business.

92192Q Data Cartridge Tray for use with 98200A or 92192T mini data cartridges.
 (1-2 units) \$45.00 ea.
 (3-6) 42.00 ea.
 (7+) 39.00 ea.



People with a lot on the line depend on HP rigid media. Here's why you should, too.

You've already invested in a top-quality HP computer. You can help assure its smooth performance by using HP rigid discs exclusively.

HP discs are matched precisely to HP drives for smooth performance. In fact, we develop our drives and media at the same time. We make sure our discs' flatness, thickness, magnetic distribution, and thermal properties match the critical specs of our drives.

Your data's safe when you use HP rigid media. The accuracy of the HP 7925 drive is an example why so much precision testing is essential for your data's safety.

This drive detects as many as 7.5 million data bits each second and flies 27 millionths of an inch off the media surface at over 100 miles per hour.

For an idea of the exactness required for smooth operation, see Figure 1. When you see how tight the tolerance is, you'll understand why your media and drive should be as closely matched as possible.

You can trust because we test. Here's how we test our rigid discs so you can trust them with your data:

- visually inspect raw disc platters for imperfections

- mechanically analyze them for flatness and smoothness
- electronically evaluate their magnetic properties
- balance them for vibration-free rotation
- mechanically analyze them again for flatness and smoothness
- burnish the disc surfaces
- magnetically purify all the surfaces

For precise read/write head positioning, we also write permanent servo code bands for HP drives in each pack. And because we control the manufacturing and testing, we can assure the accurate head positioning of HP media.

You'd never torture media like we do. We put our media through exhaustive electro-magnetic data transfer testing under "worst case" conditions. We use a marginal head, well under spec, and we write a problematic data pattern over its entire surface. If the inferior head can pick up the complex electrical transitions, the disc has proven its strength and we know you can rely on it.

We also guarantee that our discs have spare tracks on every surface so you can always count on getting sufficient memory.

Keep your system running smoothly by using only HP rigid discs. Find your drive in the chart on the following page and order your HP discs.

Store your rigid media in our multi-purpose rack. See pg. 115 for details.



You can trust your valuable data with HP rigid discs.

We've had disc drive customers who used non-HP media and developed problems. When they returned to HP rigid media, their problems cleared up.

You may find cheaper media but you won't find better or more reliable media.

The difference between our media and non-HP media is—we stand behind ours. We support the customer after the sale. We sell a product we're proud of.

Gene Williams

Gene Williams
Support Engineer
Disk Memory Division, HP

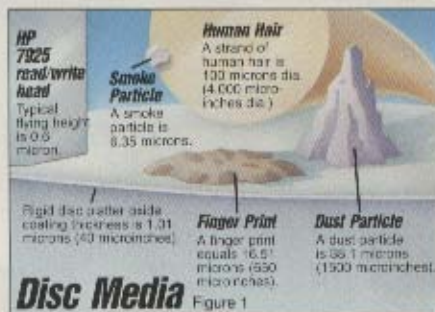

Minute substances like smoke and dust, drawn to scale, illustrate how smooth your disc must be to be properly read at a flying height of 27 millionth of an inch.



HP rigid discs are 100% tested

Rigid discs

Description	Systems	Product number	Price
2.5 MByte Disc Cartridge formatted front loading	HP 7900A, 7901A, 9880B, 12960A, 12961A, 30110A Disc Drives and Subsystems	12869A	(1-3 units) \$135.00 ea.
			(4-41) 115.00 ea.
			(42+) 105.00 ea.
9.8 MByte Disc Cartridge formatted front loading	HP 7905A, 7906H/M/S, 12962C/D, 13180A/B Disc Drives and Subsystems	12940A	(1-3 units) \$179.00 ea.
			(4-41) 162.00 ea.
			(42-99) 150.00 ea.
			(100+) 135.00 ea.
50 MByte Disc Pack removable formatted	HP 7920 H/M/S Disc Drives	13394A	(1-5 packs) \$560.00 ea.
			(6-19) 510.00 ea.
			(20+) 475.00 ea.
120 MByte Disc Pack removable formatted	HP 7925 H/M/S Disc Drives	13356A	(1-5 packs) \$905.00 ea.
			(6-19) 850.00 ea.
			(20+) 815.00 ea.
404 MByte Disc Pack removable formatted	HP 7935 Disc Drives	97935A	(1-4 modules) \$1250.00 ea.
			(5-19) 1210.00 ea.
			(20+) 1170.00 ea.

Rack organizes nine rigid discs.

Keep your rigid disc cartridges in order and easy to access. Our light-weight storage rack holds nine discs and makes retrieval of crucial data and programs quick and easy.

Our sturdy rack is constructed of heavy-gauge steel wire with nickel-chrome plating. Rubber non-skid feet secure your discs and protect your furniture.

922060 Rigid disc rack for 12869A and 12940A disc cartridges
(1-2 units) \$26.00 ea.
(3+) 20.00 ea.



"I actually enjoy phoning in an order for supplies from the catalog." The HP employees who help us are friendly and informed, and it's more like being helped by an old friend than dealing with a large company."

Joel Nossoff, Director
California State University,
Los Angeles
Los Angeles, California

Removable disc is compact and compatible with the HP 1000/9000.



20.5Mbyte removable disc cartridge can be used with the HP 7907A Fixed/Removable Mass Storage Subsystem. Now you can interchange large volumes of data quickly and conveniently. In fact, with this 8-inch removable disc, you can copy data from the fixed disc in less than three minutes!

When security is essential, the removable disc can be taken off line and stored in a safe place. Its protective jacket provides additional storage safety.

The HP 7907A drive is compatible with CS/80 and HP-IB. It's also available in an optional version that emulates the 7906M drive. The disc cartridge must be formatted before use.

97907A
(1 cartridge) \$225.00 ea.
(2-5) 210.00 ea.
(6+) 190.00 ea.

"How can I be so sure our new one-half-inch magnetic tape works best on HP tape drives?"

"We spent the time and money to find out. HP invested in a six-month test at our Greeley Tape Operation to compare the performance of every major one-half-inch tape on the market.

Why did we go to all the trouble? Because, while we'd all like to believe that any ANSI spec tape will work properly with any ANSI spec tape drive, it doesn't always happen. A tape may work perfectly on one drive but not on another because of differences in the head, tape path and/or electronics.

We tested 26 tapes in the same way on the same HP tape drive for 220 full reel passes. Those that performed well in the first phase were then further tested for wear, environmental and magnetic properties. When all the results were in, we picked the winner. And that's the magnetic tape that now bears the HP logo."

Will Carleton

Will Carleton
HP DIRECT



"We start with a first-class product"

"Tape quality is of strategic importance to us here at the HP Software Distribution Center where we copy thousands of magnetic tapes a month. Our customers expect defect-free products, and that's what we've promised to deliver. So, we make sure we start with a first-class product—the same HP one-half inch magnetic tape that won the testing competition.



Working with a premium tape also saves time. Inferior tape wastes time when the system encounters an error and goes through a series of attempts to write to the tape. With HP's error-free tape, the 'skip and rewrite' routine is a thing of the past."

Deb Jungkind
Deb Jungkind
Process engineer
HP Software Distribution Center

**5
YEAR
WARRANTY**

Same tape selected by NASA

This magnetic tape sets new standards for signal quality, tape cleanliness and durability. In fact, it's the same tape NASA selected for the space program. It's inspected over every inch to insure it's totally error-free, certified end-to-end for use through 6250 CPI and warranted by HP against defects for five years.

Magnetic tapes

Product no.	Description	Systems	Price
92150D	Box of 10 600-ft. (183m) tapes on reels, in seals 0.5 in. (12.7 mm) wide	HP 7970, 7971, 7974, 7976, 7978, 7979, 7980 Tape Drives and subsystems	1 box of 10 tapes ... \$135.00 box
			2-5 125.00 box
			6+ 115.00 box
92150E	Box of 10 1200-ft. (366m) tapes on reels, in seals 0.5 in. (12.7 mm) wide	HP 7970, 7971, 7974, 7976, 7978, 7979, 7980 Tape Drives and subsystems	1 box of 10 tapes ... \$175.00 box
			2-5 165.00 box
			6+ 155.00 box
92150F	Box of 10 2400-ft. (732m) tapes on reels, in seals 0.5 in. (12.7 mm) wide	HP 7970, 7971, 7974, 7976, 7978, 7979, 7980 Tape Drives and subsystems	1 box of 10 tapes ... \$240.00 box
			2-5 225.00 box
			6+ 210.00 box
92150P	Box of 10 2400-ft. (732m) tapes on reels, in Easy Load II cartridges 0.5 in. (12.7 mm) wide	HP 7976 Tape Drive only	1 box of 10 tapes ... \$260.00 box
			2-5 245.00 box
			6+ 230.00 box

Mag tape care is easy with the right accessories.

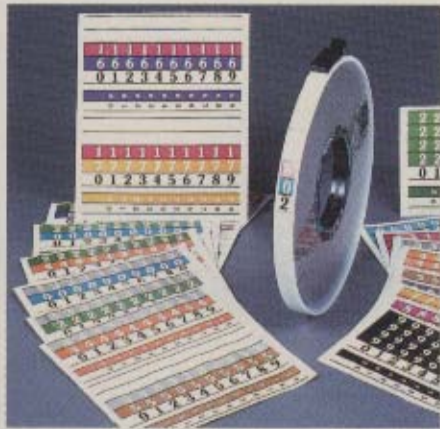

92150L Mag tape color/numbering kit. Prevent misfiling! Our simple color-coded numbering system will help you eliminate misfiles in your magnetic tape library. 1000 labels (numbered 0-999).

- Designed with pressure-sensitive labels, which are inserted into label area of Tape-in-Seal cartridges.
- Each label is provided with location tabs which can be used on library tape racks or cabinets to quickly identify filing spot.

Price \$98.00 ea.

92150K Magnetic Tape reel labels.

Blank white adhesive labels. For quick identification and indexing of your tapes and other items. Roll of 1000 labels.
 (1-4 rolls) \$78.00 ea.
 (5+) 74.00 ea.

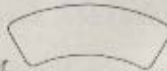

92150X Box of magnetic tape take-up reels.

Replace broken reels and keep extras on hand. Five 10.5-inch reels to a box. Clear plastic front. HP blue-colored back.
 (1 box of 5) \$30.00 box

92206T Magnetic tape rack.

Organization means time savings! Our mobile 15-reel capacity storage rack will help you and your people stay organized. Chrome-finished steel rack designed for use with 600-foot, 1200-foot, or 2400-foot tapes in seals. Order today and transform your desk or shelf into an organized data library. Buy three and save.
 (1-2 racks) \$26.00 ea.
 (3+) 20.00 ea.

9162-0027 Head alignment tape.

Has tracks, recorded at 800 BPI, precisely located on its 600-foot (183m) length. Used during testing or adjustment of 7- and 9-track head alignment on 0.5-inch (12.7mm) tape units. In protective canister.
 Price \$245.00 ea.

92150M Mag tape sense markers.

These reflective, pressure-sensitive markers offer convenient tape beginnings and ending indicators. 250 markers to a card.
 (1-9 cards) \$10.50 ea.
 (10+) 9.50 ea.

92150Q box of 10 ring seals for Easy Load II self-threading cartridges.

To be used on 2400-foot tapes (10.5-inch reels) when using the auto-load feature on HP 7976 Tape Drives.
 (1 box of 10) \$46.00 box
 (2-5) 43.00 box
 (6+) 40.00 box

Mag tape storage solutions—portable or permanent



92150T Transport/carrying case

for 2400-foot magnetic tapes. Holds up to four reels in either tape seals or Easy Load Cartridges. This case combines durable impact-resistant polyethylene construction on the outside with shock absorbing foam on the inside to ensure reliable protection when carrying or shipping your valuable data and software. Built-in hasp for your personal padlock. Dimensions: 15.8 x 17 x 6.5 inches (40 x 43.2 x 16.5 cm) Weight: 7.5 pounds (3.4 kg)

(1-2 cases) \$79.00 ea.
 (3+) 69.00 ea.

92272F Library tape storage rack. To match our new cabinet line, we have added a companion library tape rack. It helps you utilize wall and floor space for high density tape storage at minimum cost. Up to 300 tape reels in seals may be stored in any combination of 600-foot, 1200-foot or 2400-foot reels. Some assembly is required. Construction is of welded steel with open base design. Color is cream-gray, matches other 92272-series cabinets and complements other HP furniture. Exterior dimensions: height 79.5 in. (200 cm); width 48.5 in. (123 cm); depth 13.2 in. (33 cm).

(1 rack) \$335.00 ea.
 (2+) 308.00 ea.

Be sure to see pages 98-110 for our complete line of cabinets and furniture.



92272F Library tape storage rack

Here's how easy it is to prevent errors, downtime and permanent damage.

Let's face it, the average work environment's a jungle for computer equipment. Even as you read, smoke, dust and other contaminants are attacking your media and drives, causing errors and possible permanent damage.

Plus, oxide from the tape itself chips off and sticks to heads, capstans and guides. This also causes read/write errors and reduces the life of your head and media.

You can't always see the dirt. A clear film of oxide or binder may form on your tape head without being visible. But you'll find out it's there when you lose data or your drives don't work!

Regular cleaning with the correct materials eliminates this invisible enemy. And cleaning is fast and easy. Just a few minutes each week will help keep your HP drives running smoothly for years to come.

Clean your drive with confidence. Incorrect cleaning materials can actually cause more problems than they solve. Eliminate the worry—use the supplies and accessories that have been rigorously tested on HP drives so you can trust them on yours.

Regular cleaning will not only protect your data and drives, it will save you the expense of downtime and damaged equipment. Follow our Helpful Ideas on this page and protect your investment the fast and easy way.

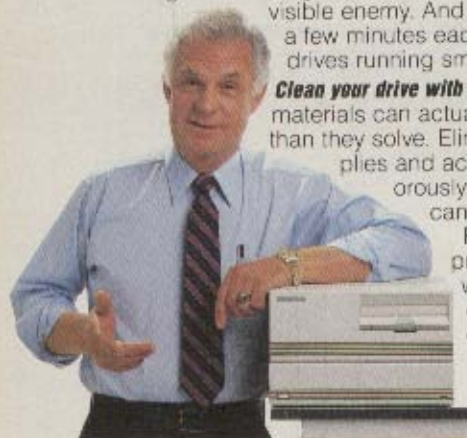

HELPFUL IDEAS!

By cleaning your drive's read/write head on a regular basis, you can prevent problems. Cleaning takes just a few minutes and will decrease the likelihood of downtime, lost data and damaged equipment.

When to clean under normal conditions—

- after every 10 reels of tape (about every 1.5 hours of continuous running).

Also clean if—

- tapes from outside your computer center are being read.
- new tapes with only one or two uses are being used. (New tapes pick up debris during manufacturing.)
- extended periods (days) of tape drive inactivity before use.
- there's an abnormal dust level in your computer center because of a delivery or equipment being moved.

How to clean your heads.



◀ If you use magnetic tape drives, apply the correct magnetic head cleaning solution to the head with a swab. Then clean all visible parts with a blower cleaning solution and swabs.

If your system has an 8-inch or a 5.25-inch drive, use a cleaning disc ▶



◀ If your system has a 1/4" tape drive, use a cleaning cartridge.



Expertly clean your magnetic tape heads with this kit.

All you need for swabbing your heads. Use these supplies regularly and minimize read/write errors while prolonging head and media life. Routine cleaning also reduces dust and oxide build-up. Kit includes two 4-ounce bottles of cleaning solution, 50 lint-free wipes, 10 plastic swabs with urethane foam tips and one easy-pour dispensing cap.

92193H Magnetic head clean kit	
(1 kit)	\$35.00 ea.
(2-4)	33.00 ea.
(5+)	30.00 ea.



Here's all you need to clean magnetic tape systems.

Clean heads, guides, capstans, screens, printers and equipment surfaces. Our Master kit includes 4-ounce bottles of mag head cleaning, anti-static and screen-cleaning solutions, 10 plastic swabs with urethane foam tips, 16 screen-clean wipes, 50 lint-free wipes, two pump spray tops, gloves and instructions.

92193M Master clean kit	
(1 kit)	\$44.00 ea.
(2-4)	42.00 ea.
(5+)	40.00 ea.

Prevent drive contamination with our magnetic head cleaning solution.

Apply it to drive heads with cleaning swabs to clean magnetic tape drives. It's 100% Freon TF, the safest solvent for your tape path. Freon TF cuts oil and grease and evaporates quickly. Use compressed air to dry it thoroughly so it doesn't touch the tape, which could cause sticking problems. Be sure not to use alcohol, aerosol cleaners or Freon TA, which contain an acetone that could dissolve the epoxy holding the head together. The 12-ounce bottle has a flip top that releases drops so you don't contaminate the solution by dipping a dirty swab into it.



92193F Magnetic head cleaning solution	
(1-4 bottles)	\$16.00 ea.
(5+)	14.00 ea.

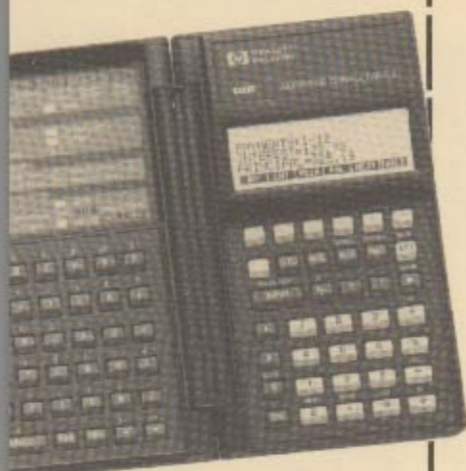

Stay informed! Keep HP DIRECT bi-annual catalogs coming!

ADD DELETE or KEEP my name and address on your mailing list.

PLACE YOUR MAILING LABEL FROM BACK COVER HERE

Label corrections? No label? Please fill out this section:

Send me:

- the current Computer Users Catalog the current Test and Measurement Accessories Catalog

Mr./Ms./Dr. _____
(Circle one) First M.I. Last

Company _____ Dept./Bldg./Mail Stop _____

Street Address _____

City _____ State _____ Zip _____

Telephone: Area Code (_____) _____ Extension _____

Please send a Computer Users Catalog to another person at my business location.

Mr./Ms./Dr. _____
(Circle one) First M.I. Last

Dept./Bldg./Mailstop _____

Tell us about yourself.

- 09 I both purchase and use supplies
 00 I am the user of supplies
 04 I purchase supplies for others

Number of people at your business location:

- 01 1-49 500-999
 02 50-249 1000+
 03 250-499

Check the department AND title which closest describe your position:

Department	Title
90 <input type="checkbox"/> Data Processing	01 <input type="checkbox"/> Admin. Staff
80 <input type="checkbox"/> Personnel	02 <input type="checkbox"/> Professional Staff
70 <input type="checkbox"/> Sales	03 <input type="checkbox"/> Middle Manager
60 <input type="checkbox"/> Finance/Accounting	04 <input type="checkbox"/> Purchasing/Buyer
50 <input type="checkbox"/> Customer Service	05 <input type="checkbox"/> Top Manager
40 <input type="checkbox"/> Purchasing	06 <input type="checkbox"/> Owner/Principal
30 <input type="checkbox"/> Marketing	07 <input type="checkbox"/> Technician
20 <input type="checkbox"/> R&D	08 <input type="checkbox"/> Engineer
20 <input type="checkbox"/> Engineering	09 <input type="checkbox"/> Other _____
10 <input type="checkbox"/> Manufacturing	
00 <input type="checkbox"/> Management	
00 <input type="checkbox"/> Administration	
Other _____	

Which equipment do you own/use?

Personal Computer Systems

- 0150 HP Touchscreen I/II (HP 150)
 0199 HP Vectra PC
 0299 HP Portable Vectra CS
 0110 HP PORTABLE-PLUS (HP 110)
 0700 IBM or compatible PC
 0600 Apple or compatible PC

Calculators

- 0010 HP Series 10 calculators
 0050 HP Series 18/28 calculators
 0007 HP Series 40/70 calculators

Printers/Plotters

- 2010 ThinkJet/QuietJet Printers
 2015 PaintJet Printer
 2016 DeskJet Printer
 2020 LaserJet Printers
 2021 LaserJet Series II
 2022 LaserJet 2000
 2030 Small HP dot matrix printers (263X, 293X, RuggedWriter)
 2035 Large HP System Printer (2563, 2564, 2608)
 2040 HP daisywheel printers (2601A, 2602A, 2603A)
 2050 Large HP laser printers (2680, 2687, 2688, 2689)
 2000 Other HP printers
 7010 Commercial plotters (ColorPro 7440, 7470, 7475, 7550)
 7020 Technical plotters (7550, 758X, DraftPro, DraftMaster, 9872)
 7040 Electrostatic Plotters (Series 7600)
 7000 Other HP plotters

Technical Computer Systems

- 0200 HP 9000/Series 200 or Integral PC
 0300 HP 9000/Series 300
 0500 HP 9000/Series 500
 0640 HP 3000/Series 840
 0080 HP Series 80
 1000 HP 1000
 2300 Series 2300 graphics terminal

Commercial Computer Systems

- 3000 HP 3000/Series 40-70, 930, 950
 3037 HP 3000/Series 37, Micro3000
 4000 IBM
 4100 DEC
 4200 Wang

Electronic Test Instruments

- 0001 Basic Test Instruments
 0012 ATE
 0003 RF and Microwave
 0004 Transducer Based Measurements
 0005 Data/Telecommunications Test
 0013 Component Test
 0014 Mechanical Test
 0008 Logic Analyzers/Microprocessor Development Systems

Win an HP-19B Business Consultant II calculator—just fill out the card at right!

It's yours for the asking: the latest information about HP DIRECT products, plus a chance to win an HP-19B Business Consultant II calculator—the hot new calculator that offers customized and built-in formulas for solving business problems.

All we ask is that you complete the card below and return it to us. We'll select two lucky winners at random each month between October 1, 1988 and June 30, 1989. You'll be eligible for an HP-19B Business Consultant II calculator from the time we get your card until the contest ends.

We use the information you submit to better serve your changing needs. Say the word, and we'll continue sending our catalog or remove your name from our list—but we need to hear from you.

If you've already filled out one of our cards over the past six months, just return another with your name and address you can qualify to win again!

Eligibility and rules

- No previous or current purchase of HP equipment is necessary for eligibility.
- Only original entry cards will be accepted. Limit one entry per person per contest. To obtain a replacement for a damaged card, write to: HP DIRECT, P.O. Box 3640, Sunnyvale, CA 94088-3640, ATTN: Marketing Communications.
- HP DIRECT will award two calculators each month beginning November 1. Contest ends June 30, 1989. All entries must be received prior to June 30, 1989.
- Entries must be received at HP DIRECT by the last day of each month to be eligible for that month's drawing.
- The only information needed for entry is name, address and telephone number.
- Hewlett-Packard employees and their families are not eligible. Void where prohibited or restricted by law. Only Continental U.S. entries are valid. Odds of winning depend on total entries received.
- All entries become the property of Hewlett-Packard.

C386

Valid until 10/89

CATALOG SUBSCRIPTION CARD

Don't miss the next issue!

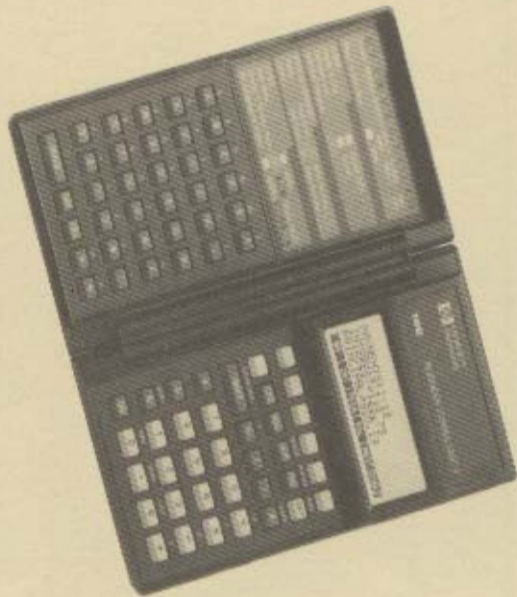

HEWLETT
PACKARD



Attention, engineering professionals

In the market for electronic test accessories and basic measurement products? Look to our Test & Measurement Accessories catalog! It's from HP DIRECT, so every product in it can be shipped to you the same day, when you phone in your order before 4 p.m. For your copy, just check the appropriate box and send us the card at left.

To: Hewlett-Packard

HP Direct

P.O. Box 3640

Sunnyvale, California 94088-3640

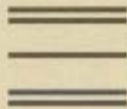

Place
stamp
here

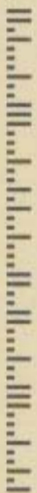



Protect your hands from dirt and solvents.

Keep your hands clean while cleaning your equipment. Each bag contains twenty-five pairs of plastic gloves.

- 92193G** Cleaning gloves
(1-4 bags) \$29.00 bag
(5+) 25.00 bag

Clean safely with non-abrasive lint-free wipes.



Because our lint-free wipes won't bring abrasives into your tape's path, they're safe for all HP equipment surfaces. One bag includes 100 4 x 4-inch (10.2 x 10.2 cm) thermal-bonded polyester wipes.

- 92193W** Lint-free wipes
(1-4 bags) \$12.00 bag
(5+) 10.00 bag



Compressed air cleaner speeds evaporation.

Cut cleaning time by using this compressed air cleaner to dry the cleaning solution on your head and tape path. It's also great for blowing dirt and dust out of hard-to-reach spots, and the extension spray tube makes it safe and easy to use. One box includes two 12-ounce cans.

- 92193Y** Compressed air cleaner
(1-4 boxes) \$21.00 ea.
(5+) 19.00 ea.



Soft, urethane foam-tipped swabs clean equipment gently but firmly.

Use our wooden swabs for cleaning your high density 1/4" data cartridge transports with our 92193F cleaning solution. These swabs are non-abrasive and safe for your system. 50 swabs/box.

- 9300-0468** Lint-free wooden swabs
(1-2 boxes) \$15.00 ea.
(3+) 12.00 ea.

Use these plastic swabs with our 92193F magnetic head cleaning solution to clean the tape head and capstans in your HP 7908/11/12/14 tape transports. Non-abrasive swabs won't harm your tape path. 50 swabs/box.

- 9300-0767** Lint-free plastic swabs \$27.00 box

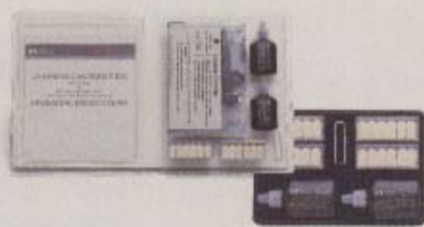

Clean your 1/4" tape drive in a flash.

Cleaning the head on your HP 9144A, 9142A or 35401A tape drive is as easy as inserting a media cartridge. Our kit includes a cleaning cartridge, two bottles of cleaning solution, 13 foam pads, plastic tweezers, a cleaning maintenance record, plus instructions for each type of drive.

- 92193E** Cleaning cartridge kit for 1/4" tape drives
(1 kit) \$52.50 ea.

When supplies run low in your 92193E kit, order this to replenish it. Includes two bottles of cleaning fluid, 24 foam pads, tweezers and a maintenance record. Just keep the cleaning cartridge from the original kit.

- 92193P** Replenishment Kit
(1 kit) \$26.00 ea.

5.25-inch Kit



8-inch Kit



Clean your 8-inch or 5.25-inch drives with these easy-to-use kits.

Clean your drive in less than two minutes without messy liquids! Just insert our cleaning disc in your drive and activate your system's initialize command or cleaning utility, which moves the head across the cleaning surface of the disc. Both kits include two double-sided cleaning discs good for 26 cleanings each, instructions and a storage case.

- 92193L** Kit for 8-inch disc drives
(1 kit) \$36.00 kit
(2-4) 33.00 kit
(5+) 30.00 kit
92193K Kit for 5.25-inch disc drives (except the HP Vectra PC drives)
(1 kit) \$32.00 kit
(2-4) 30.00 kit
(5+) 28.00 kit

"Your personnel have always been courteous, patient, and most helpful."

I would like to express my sincere appreciation for the way you have handled my account. I have ordered numerous computer support products over the phone. These orders have ranged from as small as \$8 to more than \$300. Yet, the service has always been the same—exemplary.

Also, I am repeatedly amazed at how fast my order arrives. Such promptness is to be commended, and is certainly remembered by me, one of your customers.

None of this would matter if the products were inferior. Happily, this is not the case. The quality of your products is unsurpassed. I cannot recall another company that has maintained such a consistently high image of its products and personnel.

In closing, I wish you and your company all the success you so richly deserve!

Sincerely yours,

Thomas Bradford
Thomas Bradford
McCall, Idaho



FURNITURE



HP furniture...intelligently designed for the work you do and the computers you use to do it. One such example is our *Design Plus* CAD workstation, developed specifically for optimal space utilization. Peruse the section ahead to learn more.

Office & workstation	99
Sound enclosures	107
Ergonomic chairs	108
Files & binders	112
Cabinets	114
Workstation accessories	118
Anti-static accessories ...	122

Design Plus

Developed with your HP computer system—and you—in mind. This furniture's clean, utilitarian design matches your equipment perfectly, giving your workstations an appealingly coordinated look. Because components work together, workstations are easily re-configured to suit changing system needs.

What's the "Plus?" There are several. Like infinitely expandable storage space. Intelligent cable management. Generous desktop space and dimensions sized to fit the human body,

allowing for enormous working convenience and comfort.

Expect quality "plus," too, because **Design Plus** is constructed of the highest grade of materials. Attractive matte surfaces resist scratches and stains, while protecting your eyes from the glare of overhead lighting. And solidly die-cast legs withstand the weight of your equipment—and the pressures of normal office moves—without danger of buckling or breaking.



Fits your Hewlett-Packard system like a glove

Our **System Tables** conform to stringent ergonomic standards for your optimal working comfort.

Our cabinetry is similarly well-conceived. The **Mini-Rack Cabinet**, designed to hold the CPU and disc drive of your HP 9000 Series 200, 300 or 500 computer, is the cabinet that encases the HP 3000 Series 37, HP 260 or MICRO 3000. Not only does it match the height and depth of our tables, it can be locked into place. Result? Additional work surface, flush-fitted and uninterrupted by troublesome gaps or height discrepancies.

Depend on our **Mobile Drawer Units** to store files, documentation and other valuables. Like the Mini-Rack Cabinets, they match the height of our tables exactly. You can slip hard-disc drives and tape back-up systems into **Mobile Support Cabinets**, and tuck them conveniently under our tables.

We offer printer stands that combine fit with durability and mobility. Look to the new **Mobile LaserJet Printer Cabinet** for an abundance of work- and storage space. Choose a **Mobile Sound Enclo-**

sure Cabinet for HP serial impact dot matrix printers. Or the **Universal Support Stand** for other printers and small plotters. All roll easily on self-locking casters.



Tabletops slide on and lock into position in just seconds to form a sturdy, secure working surface. It's as easy as drop, slide, lock.



A durable wire cable management system neatly routes cables along the back side of tables, allowing for equipment connection at the point most convenient to you.



L-configuration lays large expanses of desk before you.

Design Plus One was designed with your comfort and convenience in mind. It offers ample desktop space for you to spread out and work, as well as for your terminal, keyboard and laser printer.

Included are two roomy drawers for your office supplies and documentation, plus a deeper one for hanging files and records.

And because the cabinet of your HP 3000 Series 37, MICRO 3000, MICRO 3000 XE or HP 260 computer is perfectly flush with your system table, you get bonus workspace.

- This system includes:
 92214A Terminal support table
 92214B Medium system table
 92214J Corner turn
 92211N Mobile drawer unit

92214AA

Design Plus One \$1680.00 ea.

Save \$150!

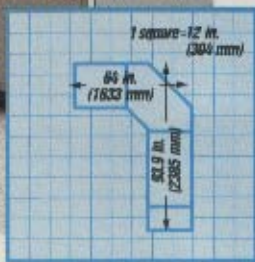

Basic system packs maximum utility into minimal space.

Design Plus Two makes the most of compact work spaces, and is well-suited for use with HP 9000 technical computers and personal computers.

It offers enough desktop space for a monitor, keyboard and printer. Place its Mobile drawer unit at either end of its System table for your files and supplies. And its Mobile support cabinet keeps your CPU and mass storage device handy without taking up valuable desktop space. The cabinet even comes with a shelf for software, manuals or additional office supply storage.

- This system includes:
 92214C Large system table
 92211N Mobile drawer unit
 92211L Mobile support cabinet

92214BB *Design Plus Two* . . . \$1315.00 ea.

Save \$125!

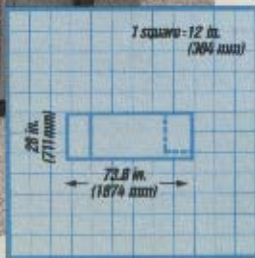

See our ergonomically designed, economically priced chairs on page 108.

Expanded L offers desktop space to meet DTP demands.

This conveniently "L"-shaped configuration offers space for your computer equipment, and for you. One end easily accommodates your PC, LaserJet Printer and ScanJet optical scanner. Mass storage devices can be handily stored in a Design Plus Mini-rack.

Devote the other end of the "L" to your research materials, PC-generated text and layouts, and the tools of your trade. The three-drawer Mobile drawer unit keeps background materials and office supplies close. You'll have room to work productively and creatively, and to share work-in-progress with others.

This configuration incorporates:

- 92214B** Medium system table (two)
- 92214J** Corner turn
- 92211N** Mobile drawer unit
- 92211R** Mini-rack
- 92211B** Mobile LaserJet Printer Cabinet

Choose the components that suit your current needs from the chart on page 103.

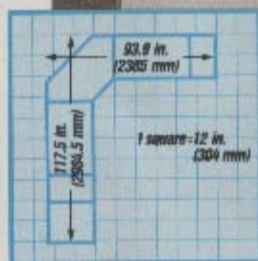

U-shaped configuration keeps CAD needs within easy reach.

This is the optimum workstation for those who recognize the value of an HP 9000 Series 300/500 for electrical- and mechanical design.

There's space for drawings, blueprints, diagrams, schematics, and a computer. Two mini-racks store CPU and mass storage devices, while a platform raises the monitor for better visibility. A drawer slides your keyboard out-of-sight until you need it, or to the left or right end of your main work surface.

The main work surface extends to accommodate expansive drawings in front of your computer's monitor—you can view work on your desk and your screen at the same time. A large drawing holder offers further convenience, as do spacious System Tables and Corner turns. Roomy drawers keep files at your fingertips.

This configuration requires:

- 92214B** Medium system table
 - 92214J** Corner turn (two)
 - 92213B** CAD Mini-workstation
 - 92211R** Mini-rack (two)
 - 92211N** Mobile drawer unit
 - 922130** "C" Sized drawing holder
- See the chart on page 103 for the components you need.

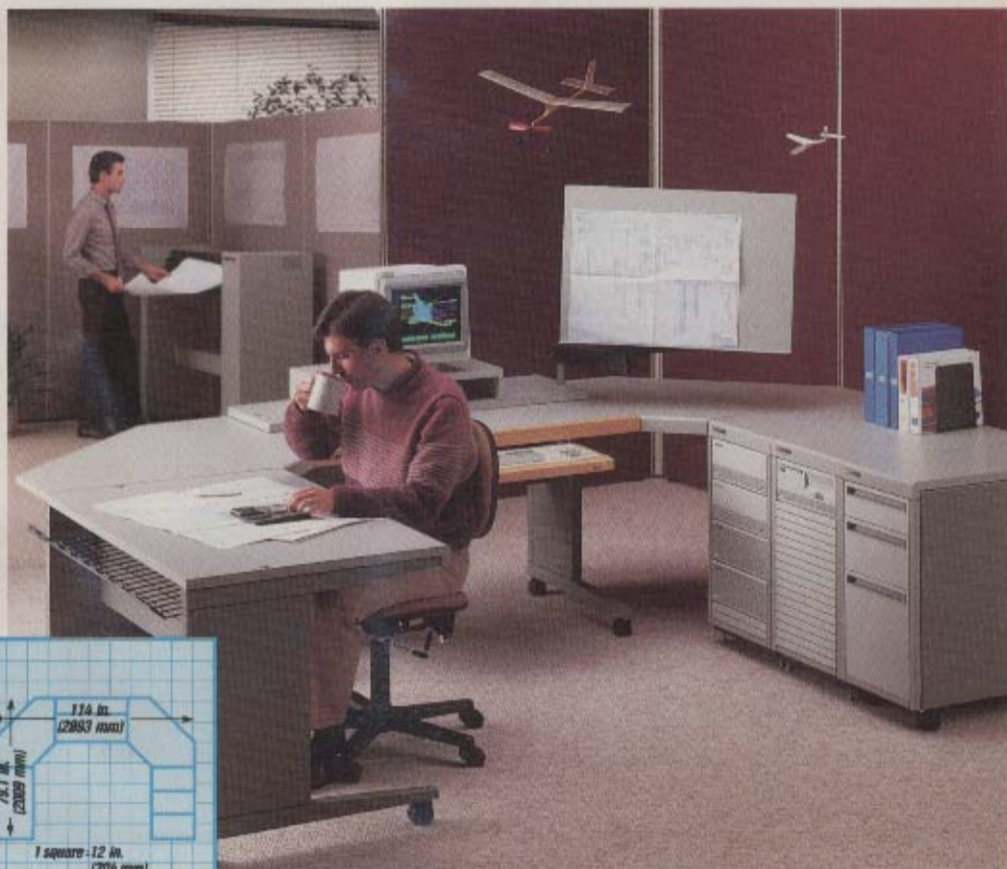
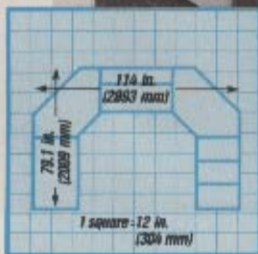

Cut clutter, promote productivity with our Mobile LaserJet Printer cabinet

Here's a single piece of furniture to fill most every laser printing need! This roomy cabinet features a wide drawer for fonts and manuals, with customized slots to keep everything tidy. It has expansive shelves for printer paper, paper trays and toner cartridges. And a shelf slides out from either side for additional workspace. It's a highly functional, attractive stand for the entire HP LaserJet family of printers. In fact, everything you need for months of printing can be right where you need it most! ☺

92211B Mobile LaserJet Printer Cabinet \$585.00 ea.

Comes unassembled.

- Handy **slide-out shelf** keeps paper and printing necessities within easy reach.

- A **perfect fit** for all LaserJet Printers—and Design Plus furniture too! Measures 720 H x 600 W x 711 D mm (28.3 H x 23.6 W x 28.0 D in.).

- Drawer has a **customized foam insert** for font cartridges and 3.5-in. soft fonts, and a **movable divider** to keep 5.25-in. soft fonts and manuals well-organized.

- **Two large shelves** let you stock up to three paper trays and several reams of paper on top, and at least two toner cartridges below—supplies for months!

- **Heavy-duty, self-locking casters** give this cabinet mobility when you need to share printing resources, and perfect stability while printing.



Turn empty space into useful space

These easy-to-install drawer units provide additional storage space in your HP Mobile mini-rack cabinet (92211R).

Mount your equipment in the cabinet, then add one, two or all three drawer units. It's perfect for documents, manuals, office supplies, tools or cables.

These attractive, sturdy metal drawers are available in 102mm, 152mm and 305mm (4-in., 6-in. and 12-in.) sizes, with key lock.

92211E 102mm (4 in.) Mobile Mini-rack Drawer Unit \$129.00 ea.

92211F 152mm (6 in.) Mobile Mini-rack Drawer Unit \$139.00 ea.

92211G 305mm (12 in.) Mobile Mini-rack Drawer Unit \$149.00 ea.



Design Plus furniture compatibility guide

Equipment	Recommended cabinet
HP 9000 Series 300/500, HP 260	92211R Mini-rack system cabinet.
HP 3000 Series 37, MICRO 3000, MICRO 3000 XE	Comes mounted in 92211R cabinet. For larger configurations of disc and tape support, order an additional 92211R cabinet.
HP 9000 model 217, Series 300/550	92211L Mobile support cabinet. Computers mount in cabinet. Has space for two additional disc or tape peripherals.
HP 9000 model 237, Series 300	92211M Small mobile support cabinet. Computer sits on top of cabinet. Two additional disc or tape peripherals will mount in cabinet.
HP 7941A, 7942A, 7945A, 7946A, 9122D, 9125S, 9133D, 9133V, 9133XV, 9134D, 9134XV, 9144A mass storage devices	92211L Mobile support cabinet, 92211M small mobile support cabinet and 92211R mobile mini-rack. NOTE: These cabinets can accommodate peripheral devices up to 325mm (12.8 in.) wide.

















Our prices include the cost of shipment. See back of catalog for details.

We ship same day

**CALL HP DIRECT
800-538-8787**

See pages 10 and 11 for new Design Plus Furniture.

Design Plus furniture (see pages 10 and 11 for our new Design Plus items)

Part number	Description	Height	Width	Depth	Price
 92214A	<i>Design Plus</i> Mobile terminal support and transport system table. Designed to safely move terminals and small systems. Comes with cable management, locking casters, and is same height as 92211R mobile rack system cabinet.	28.4 in. (720 mm)	29.5 in. (750 mm)	28.0 in. (711 mm)	(1-2 tables) \$445.00 ea. (3+) 415.00 ea.
 92214B	Medium <i>Design Plus</i> System table. Comes with cable management, locking casters, and is same height as 92211R mobile rack system cabinet.	28.4 in. (720 mm)	44.3 in. (1125 mm)	28.0 in. (711 mm)	(1-2 tables) \$495.00 ea. (3+) 465.00 ea.
 92214C	Large <i>Design Plus</i> System table. Comes with cable management, adjustable leveling glides, and is same height as 92211R mobile rack system cabinet.	28.4 in. (720 mm)	59.0 in. (1500 mm)	28.0 in. (711 mm)	(1-2 tables) \$545.00 ea. (3+) 520.00 ea.
 92213B	<i>Design Plus</i> CAD Mini-workstation. For use with the HP 9000 Series 300/500 computers. Comes with 14.25-in. (362 mm) wide raised monitor platform, pull-out work surface that extends to 36-in. (914 mm) deep, pull-out keyboard drawer and cable management. Same height as 92211R mobile mini-rack; 92211LM fits underneath.	28.4 in. (720 mm)	44.3 in. (1125 mm)	28.0 in. (711 mm)	(1-2 units) \$799.00 ea. (3+) 759.00 ea.
92213D	"C" and "D" sized drawing holder. Mounts to the monitor platform of the 92213B CAD table. Two-section arm for height and tilt position extends from 13.0 in. (330 mm) to 22.25 in. (565 mm). (See page 101 for photo.)	20.0 in. (508 mm)	30.0 in. (762 mm)	2.6 in. (6 mm)	(1-2 units) \$199.00 ea. (3+) 189.00 ea.
 92214J	90-degree <i>Design Plus</i> Corner turn. Used for joining two system tables together for a larger work area. NOTE: not intended to support CAD monitors.	Each side	28.0 in. (711 mm)		(1-2 units) \$245.00 ea. (3+) 225.00 ea.
 92211C	<i>Design Plus</i> Mobile sound enclosure cabinet. For use with all 293X serial impact dot matrix printers. Rolls easily and sits level with all <i>Design Plus</i> tables. Features gas cylinder door lifts, locking casters, paper storage, paper catcher tray and print monitoring window. Designed for rear paper exit. Comes fully assembled.	28.4 in. (720 mm)	29.5 in. (750 mm)	19.7 in. (500 mm)	(1 unit) \$675.00 ea. (2-9) 640.00 ea. (3+) 620.00 ea.
 92211L	<i>Design Plus</i> Mobile support cabinet. Rolls easily under the 92214B/C <i>Design Plus</i> system tables. Can be used as a stand-alone system cabinet for the HP 9000 Series 200/300/500, has open back. Comes with two sets of mounting rails, a cable routing kit (92199F), and a storage shelf. Internal dimensions are 12.8 in. (325 mm) wide x 20.40 in. (520 mm) high.	24.4 in. (620 mm)	16.7 in. (425 mm)	20.7 in. (525 mm)	(1-2 units) \$250.00 ea. (3-9) 235.00 ea. (10+) 220.00 ea.
 92211M	<i>Design Plus</i> small Mobile support cabinet. Rolls easily under the 92214B/C <i>Design Plus</i> system tables. Can be used as a stand-alone system cabinet for the Series 200, Model 237 or 300. Comes with one set of mounting rails, a cable routing kit (922199F), and a pad to put under the Model 237. Internal dimensions are 12.8 in. (325 mm) wide x 13.26 in. (338 mm) high.	17.1 in. (435 mm)	16.7 in. (425 mm)	16.7 in. (425 mm)	(1-2 units) \$190.00 ea. (3-9) 185.00 ea. (10+) 175.00 ea.
 92211N	<i>Design Plus</i> Mobile drawer unit. Rolls easily and sits next to all <i>Design Plus</i> system tables (also same height as tables). Comes with three drawers, 4 in., 6 in. and 12 in. (104 mm, 156 mm, and 312 mm).	28.4 in. (720 mm)	14.8 in. (375 mm)	28.0 in. (711 mm)	(1-2 units) \$645.00 ea. (3-9) 610.00 ea. (10+) 575.00 ea.
 92211R	<i>Design Plus</i> Mobile mini-rack system cabinet for HP modular peripherals and systems. Comes fully assembled with casters. Back opens for easy access. Accessories available are the 92211S mounting rail and module lock kit, 92211T filler panel kit, and 92199B power strip. Internal dimensions are 12.8 in. (325 mm) wide x 22.44 in. (572 mm) high.	28.4 in. (720 mm)	14.8 in. (375 mm)	28.0 in. (711 mm)	(1-2 racks) \$585.00 ea. (3-9) 550.00 ea. (10+) 515.00 ea.
 92211G	Large (12 inch) drawer unit for 92211R Mobile mini-rack system cabinet. Designed for easy installation and constructed of sturdy metal. Comes with its own key lock.			outside dimensions: 12 in. 12.75 in. 18.62 in. (305 mm) (324 mm) (473 mm) inside dimensions: 11.62 in. 11.25 in. 18.54 in. (173 mm) (286 mm) (471 mm)	(1-2 units) \$149.00 ea. (3-9) 139.00 ea. (10+) 129.00 ea.
 92211F	Medium (6 inch) drawer unit for 92211R Mobile mini-rack system cabinet. Designed for easy installation and constructed of sturdy metal. Comes with its own key lock.			outside dimensions: 6 in. 12.75 in. 18.62 in. (152 mm) (324 mm) (473 mm) inside dimensions: 5.62 in. 11.25 in. 18.54 in. (143 mm) (286 mm) (471 mm)	(1-2 units) \$139.00 ea. (3-9) 129.00 ea. (10+) 119.00 ea.
 92211E	Small (4 inch) drawer unit for 92211R Mobile mini-rack system cabinet. Designed for easy installation and constructed of sturdy metal. Comes with its own key lock.			outside dimensions: 4 in. 12.75 in. 18.62 in. (102 mm) (324 mm) (473 mm) inside dimensions: 3.62 in. 11.25 in. 18.54 in. (92 mm) (286 mm) (471 mm)	(1-2 units) \$129.00 ea. (3-9) 119.00 ea. (10+) 101.00 ea.
 92211S	Rail kit for 92211R Mobile mini-rack cabinet. Comes with four sets of rails and module locks. Used to mount up to four HP computer and peripheral equipment modules.			Rail length—25.1 in. (638mm)	(1-2 kits) \$50.00 ea. (3-9) 45.00 ea. (10+) 40.00 ea.
 92211T	Filler panel kit for 92211R mobile mini-rack cabinet. Kit contains 20 snap-in panels used to fill empty space not occupied by computer equipment modules.	0.9 in. (23 mm)	12.8 in. (325 mm)	0.9 in. (23 mm)	(1-2 kits) \$40.00 ea. (3-9) 35.00 ea. (10+) 30.00 ea.
 92214P	<i>Design Plus</i> Universal support stand. For use with HP LaserJet, HP 2932/33/34, HP 2563A printers and small HP plotters. Comes with printout catcher shelf, casters and leveling glides. Has slot in top for bottom feeding and slot in door top for front feeding. Also has sound control pad on door and two interior walls.	28.4 in. (720 mm)	23.6 in. (600 mm)	17.7 in. (450 mm)	(1-2 units) \$295.00 ea. (3+) 265.00 ea.
 92211B	<i>Design Plus</i> Mobile LaserJet Printer cabinet. Features a drawer designed to hold fonts and manuals, a deep cabinet with a shelf, and an exterior shelf that slides out from either side. Rolls easily and sits level with System tables.	28.3 in. (720 mm)	23.6 in. (600 mm)	28.0 in. (711 mm)	(1-2 units) \$585.00 ea. (3-9) 545.00 ea. (10+) 525.00 ea.

Our prices include the cost of shipment. See back of catalog for details.

HP Standard Furniture: solid, expandable and economical

HP Standard furniture is solidly built to handle personal computers, terminals, printers, plotters and disc drives. You can put together the workstation you initially need on a modest scale and easily add accessory pieces as your needs grow. Every piece is color-coordinated to match HP computers and peripheral products. Durability and convenience are yours, at economical prices!

Buy a bundle and save up to \$100

The Professional Workstation

For maximum work and storage space. It features a large, glare-free work surface area, 90-degree turn for PC or terminal, cable management, drawer unit to mount on either side of the table, a desktop storage unit and space for optional suspended drawers. Included are:

- 92210A Compact table
- 92210B Standard table
- 92210G Desktop storage shelf
- 92210Q Suspended drawer unit
- 92210V 90-degree tabletop connector

92210AA Professional Workstation \$1135.00 ea.

Save \$100!



The Administrative Support Workstation

For compact areas this space-saving workstation has an extension (return) that can be mounted on either side of its table, suspended drawers you can mount on either the table or the return and cable management. All surfaces are glare-free.

- Included are:
- 92210B Standard table
 - 92210Q Suspended drawer unit
 - 92210E Workstation extension (return)

92210BB Administrative Support Workstation \$705.00 ea.

Save \$55!



For information on our ergonomic chairs, just turn to page 108. And remember...our prices include the cost of shipment to you. See back of catalog for details.

The Team Workstation

For sharing computers and peripherals within your department. This economical workstation includes an adjustable keyboard surface, storage module for equipment or documentation, cable management and glare-free work surfaces. Included are:

- 92210C Standard table with right-hand adjustable keyboard section
- 92210R Storage module







92210CC Team Workstation \$455.00 ea.

Save \$45!

NOTE: The cabinet at right in photo is not included in bundle. See page 115 for information.



HP Standard furniture

Part no.	Description	Height	Width	Depth	Price
 92210A	Compact workstation table, with leg levelers and modesty panel. 7-in. (178 mm) shelf standard. See 92210L casters next page to adapt table height to 28.4 in. (720 mm).	27.0 in. (686 mm)	48.0 in. (1220 mm)	30.0 in. (762 mm)	(1-2 units) ... \$305.00 ea. (3+) 285.00 ea.
 92210B	Standard workstation table, with leg levelers and modesty panel. 7-in. (178 mm) shelf standard. See 92210L casters next page to adapt table height to 28.4 in. (720 mm).	27.0 in. (686 mm)	60.0 in. (1524 mm)	30.0 in. (762 mm)	(1-2 units) ... \$360.00 ea. (3+) 340.00 ea.
 92210C	Workstation table with right-hand adjustable keyboard section. Leg levelers, modesty panel and 7-in. (178 mm) shelf standard. Keyboard section starts 3 in. (76 mm) from the right side, adjusts down a total of 2.1 in. (53 mm) from table top and can be tilted 10 degrees from the horizontal. Manual adjustments. See 92210L casters next page to adapt table height to 28.4 in. (720 mm).	29.0 in. (736 mm)	60.0 in. (1524 mm)	30.0 in. (762 mm)	(1-2 units) ... \$405.00 ea. (3+) 375.00 ea.
	Adjustable keyboard dimensions	1.2 in. (30 mm)	24.0 in. (610 mm)	10.0 in. (254 mm)	
 92210D	Workstation table with left-hand adjustable keyboard section. Leg levelers, modesty panel and 7-in. (178 mm) shelf standard. Keyboard section starts 3 in. (76 mm) from the left side, adjusts down a total of 2.1 in. (53 mm) from the table top and can be tilted 10 degrees from the horizontal. Manual adjustments. See 92210L casters next page to adapt table height to 28.4 in. (720 mm).	29.0 in. (736 mm)	60.0 in. (1524 mm)	30.0 in. (762 mm)	1-2 units) ... \$390.00 ea. (3+) 350.00 ea.
	Adjustable keyboard dimensions	1.2 in. (30 mm)	24.0 in. (610 mm)	10.0 in. (254 mm)	
 92210E	Work surface extension (return), with leg levelers and modesty panel. Fits right or left side of 92210C, right side of 92210D. Requires use of 'Z' bracket (included) when mounting on 92210C/D. Not for 92210A.	27.0 in. (686 mm)	40.0 in. (1016 mm)	24.0 in. (610 mm)	(1-2 units) ... \$185.00 ea. (3+) 170.00 ea.
 92210W	Task light unit. Screws into place underneath the 92210F/G/Z desktop storage units. Includes 20-watt fluorescent bulb, lens and power cord wire management clips. UL listed and CSA approved.	2.0 in. (50.8 mm)	24.0 in. (610 mm)	6.6 in. (168 mm)	(1-2 units) ... \$99.00 ea. (3+) 89.00 ea.

EASY ASSEMBLY! A Phillips screwdriver is the only tool needed to assemble HP Standard Furniture. All mounting holes are pre-drilled/tapped, and all hardware and brackets are included.

Remember! Our prices include the cost of shipment to you (see back of catalog for details).



▲ 92210T Mobile workstation table









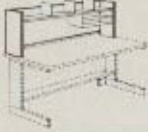

92210P Printer stand ▶

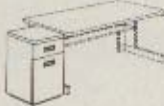
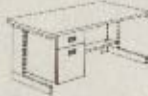
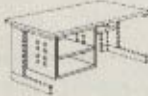

▲ 92210H Stand-up printer/terminal stand

HP Standard furniture (continued)

Product number	Description	Height	Width	Depth	Price
 92210F	Desktop storage shelf for 92210A workstation table. Includes two book supports and back-wall message board. 11 in. (279 mm) storage shelf adjusts from 15 in. (381 mm) to 19 in. (483 mm) above work surface of table. Convenient paper/storage shelf included.	23.0 in. (584 mm)	47.0 in. (1194 mm)	12.0 in. (305 mm)	(1-2 units) .. \$215.00 ea. (3+) 195.00 ea.
 92210G	Desktop storage shelf for 92210B/C/D workstation table. Includes three book supports and back-wall message board. 11 in. (279 mm) storage shelf adjusts from 15 in. (381 mm) to 21 in. (533 mm) above work surface of table. Convenient paper/storage shelf included.	23.0 in. (584 mm)	59.0 in. (1499 mm)	12.0 in. (305 mm)	(1-2 units) .. \$235.00 ea. (3+) 215.00 ea.
 92210Z	Desktop storage unit with wide-flipper door for 92210B/C/D workstation table. Includes lockable flipper door, back-wall fabric-covered message board and hanging paper/storage shelf. Space from table top to shelf bottom is 19.5 in. (495 mm).	34.0 in. (864 mm)	59.0 in. (1499 mm)	14.0 in. (356 mm)	(1-2 units) .. \$475.00 ea. (3+) 440.00 ea.
 92210N	Mobile drawer unit, on casters. Two drawers, with identical key lock units. Deep bottom drawer like 92210Q below. Unit rolls easily to any workstation; top same height as 92210A/B .	27.0 in. (686 mm)	15.4 in. (391 mm)	20.0 in. (508 mm)	(1-2 units) .. \$295.00 ea. (3+) 280.00 ea.
 92210Q	Suspended drawer unit. Two drawers, with identical key lock units. Deep bottom drawer can store three types of hanging files: letter-size, legal-size, and computer printout binders. Fits right or left side of 92210A/B/C/D tables.	21.0 in. (533 mm)	14.8 in. (375 mm)	19.4 in. (493 mm)	(1-2 units) .. \$215.00 ea. (3+) 195.00 ea.
 92210R	Storage module unit, with three-position adjustable shelf. Rear of module is open for ventilation and access to 92210A/B/C/D cable management system, when module used to hold electronic equipment. Fits right or left side of 92210A/B/C/D tables.	19.0 in. (483 mm)	21.0 in. (534 mm)	19.4 in. (493 mm)	(1-2 units) ... \$95.00 ea. (3+) 87.00 ea.
 92210U	CAD corner workstation table, with leg levelers, modesty panel, and shelf. Also includes a pull-out keyboard shelf.	29.0 in. (737 mm)	45.0 in. (1143 mm)	30.0 in. (762 mm)	(1-2 units) .. \$569.00 ea. (3+) 539.00 ea.
 92210V	Workstation tabletop connector. 90-degree triangle. Joins two 92210A/B/C/D tables together.	Each side	30.0 in. (763 mm)		(1-2 units) .. \$120.00 ea. (3+) 110.00 ea.
 92210L	Set of four heavy-duty, double-wheel casters. Use in place of leg levelers on 92210A/B/C/D tables or 92210P stand where mobility is desired. Caster height 1.75 in. (45 mm). Adapts height of tables to 28.4 in. (720 mm).				(1-2 units) ... \$26.00 set (3+) 21.00 set
 92210H (see photo previous page)	Standup printer/terminal stand. Design matches HP 92210-series workstation system. Same slotted top and rear printout catcher as 92210P (see below). Height is 38 in. (965 mm), ideal for walk up operation of equipment. Cable management slots, 7-in. (178 mm) shelf standard.	38 in. (965 mm)	30 in. (762 mm)	24 in. (610 mm)	(1-2 units) .. \$265.00 ea. (3+) 250.00 ea.
 92210P (see photo previous page)	Printer stand. Design matches HP 92210 series workstation system. Convenient paper feed slot (4 x 19 in., 102 x 483 mm) in top allows bottom paper feed. Also features rear printout catcher with 1.5-in. (38 mm) slot to allow paper transport to rear feed printers. Cable management slots, 7-in. (178 mm) shelf standard.	27 in. (686 mm)	30 in. (762 mm)	24 in. (610 mm)	(1-2 units) .. \$265.00 ea. (3+) 245.00 ea.
 92210T (see photo previous page)	Mobile workstation table for terminals. Design matches HP 92210 series workstation system. Features a dropped, pull-out keyboard surface. Cable management slots, locking casters and 7-in. (178 mm) shelf standard.	28.3 in. (720 mm)	30 in. (762 mm)	28 in. (712 mm)	(1-2 units) .. \$310.00 ea. (3+) 290.00 ea.
		26.4 in. (670 mm)	23.5 in. (597 mm)	12 in. (305 mm)	

Lower the lid on plotter noise!

Do you have sensitive ears? Our all-new Plotter sound enclosure reduces the sound of your HP 7470, 7475 or ColorPro plotter by as much as 90 percent, to as low as 53.4 decibels. Your plotter becomes as quiet as a murmur... less intrusive than the sound of computer keyboarding. It's a wonderful way to improve office productivity.

The most functionality you'll find in a sound enclosure An intelligent design negates the need for an annoying cooling fan. It's constructed of sound-reducing particle board, with foam lining to absorb plotter vibrations. A foam plug can be removed to accommodate B/A3-size plotter paper, then re-inserted for further sound reduction. And the durable acrylic lid is attached by spring-loaded hinges for effortless opening and closing. Dimensions are 12 in. (305 mm) H x 25.8 in. (655 mm) W x 19.5 in. (495 mm) D; stand measures 3.9 in. (100 mm) H.

Extra protection for your plotter This Plotter sound enclosure protects your plotter investment, too. It's a shield against dust, spills and environmental contaminants—just as it shields you from unwanted noise.

Designed to complement your HP equipment This Plotter sound enclosure is designed to coordinate with Design Plus furniture. What's more, its design allows space for our 92177W/X Graphics organizer underneath for additional convenience (see page 49).



92166E Plotter sound enclosure \$249.00

Muffle printer clatter!

Our Mobile sound enclosure cabinet is designed to make the HP 293X Serial Impact Dot Matrix Printer easy on your ears. This cabinet totally encases your printer, acting as a shield against dust and moisture while it absorbs noise.

Inside, there's a sturdy shelf for your printer and ample storage for continuous-feed paper. The wide front door has a handy finger-pull opener, and the top swings up on gas-cylinder lifts.

Monitor your printing through the attractive acrylic top panel; printed copies exit from the rear of your printer into a convenient paper catcher tray at the cabinet's rear.

The Mobile cabinet is the perfect height for Design Plus tables, rolls smoothly on self-locking casters and comes fully assembled. Exterior dimensions are 28.4 in. (720 mm) H; 29.5 in. (750 mm) W; 19.7 in. (500 mm) D.

92211C Design Plus Mobile sound enclosure cabinet
(1-2 units) \$675.00 ea.
(3-9) 640.00 ea.
(10+) 620.00 ea.



Absorb printer sound!

Help quiet your HP 2601A/2602A or other printers. Distracting printer noise and vibrations are minimized when this sound absorbing pad is placed under your printer. Sound and vibrations first penetrate through the pad's nylon surface, then further are absorbed into the sponge-like layers of natural rubber. This sound absorbing pad will provide firm support for your printer and is highly resistant to indenting and sliding. Size is 18 in. (457 mm) x 21 in. (559 mm). Order several and save!

92177B Sound absorbing pad
(1 pad) \$31.00 ea.
(2-4) 25.00 ea.
(5+) 21.00 ea.





HP Ergonomic Workstation/Managerial Chair tilts forward to support the position your body takes at a keyboard. Optional armrests install two ways to let you pull close to your work or rest your hands.

HP Ergonomic Executive Chair provides top-to-bottom back support, rocks freely or locks in any of three positions. Takes the discomfort out of long meetings and calls. Armrests are standard.

HP Ergonomic Workbench Chair provides full support and independently adjustable foot support. Ideal for CAD, drafting and work that requires elevated work surfaces.

HP ergonomic chairs: From the bottom up, they redefine your entire concept of comfort

Any ergonomic chair can look pretty. But for a chair that's built to feel good and work better for years to come, take a close look at an HP ergonomic chair.

Our chairs look good, but that's only the beginning. These remarkable "comfort machines" are built to last. Just sit in one—you feel the difference *immediately*. It's more than firm support. Amazing adjustability. Or even top-notch quality. Our chairs offer *security*. Here's how:

They adjust to fit you...and your job If you work at a keyboard, you'll love the way our Workstation Chair leans forward when you do. Lift a lever and the seat tilts, while the backrest moves in close.

The Workbench Chair does the same. It also lets you set its footing where you want it, independent of seat height. And if you spend a lot of time on the phone, you'll appreciate the way our Executive Chair lets you rock freely or lock your chair in virtually any tilting position.

All three styles cradle your body in a most comforting way. The curved backrest hugs your back, with gentle indentations to accommodate your shoulder blades and a raised area to support your lower back.

On the seat bottom, a raised back and waterfall front-edge balances your spine while allowing free circulation in your

thighs. Its high-density foam padding is thicker than in most chairs, yet resilient enough to stay firm when too-soft foams "bottom out."

Quality from the casters up Many other ergonomic chairs are strong on style but short on substance. HP chairs give you both.

In fact, we've built in features found in chairs that cost as much as a thousand dollars. Like a sturdier-than-normal gas cylinder that meets strict European standards. Armrest brackets with the strength of motor mounts. And thoughtfully placed levers and knobs that let you make as many as five individual adjustments without leaving your seat.

Tested without mercy No chair—no matter how adjustable—is comfortable when it's broken. So we tested the design of our chairs in ways that would make most manufacturers shudder.

We gave the arms 200 pounds of downward pressure and 100 pounds of outward pressure. We stressed the backrest and seat front thousands of times. The base had to stand up to 2,500 pounds!

We didn't have to but, we had our chairs built to meet all BIFMA* standards for safety, performance and durability. Few others can make that claim. And ours are covered by Hewlett-Packard's well-known money-back guarantee.

*Business & Institutional Furniture Manufacturers Association

Deeply contoured foam backrest comforts your upper back and shoulder blades, while offering lumbar support where it counts most.

State-of-the-art molded base is stronger than steel bases. And because the color's molded in, it can't scratch like the paint on steel.

Molded metal five-star base offers maximum stability—keeps your feet on solid ground no matter how active your day.

Self-locking casters roll when you need to move about freely, hold steady when you need stability.



Fabric is tightly woven for strength, yet breathes so you stay cool. Won't pill, resists stains and acids, won't discolor like nylon.

Individual controls let you adjust seat height, backrest tension, backrest support and more, while remaining comfortably seated in your chair.

German-made pneumatic cylinder adjusts seat height securely, absorbs shock when you sit, it's wider than the cylinder on most chairs, and meets the most stringent European standards for durability.

Look at the range of adjustment you get with each chair:



Raise or lower your seat up to 152.4mm (6 in.)—your legs are angled comfortably whether you're tall or petite.



Move your backrest as much as 127mm (5 in.) up or down, to suit your posture or working preference.



Tilt your seat upward or downward—great for close keyboarding or casual meetings at your desk.



Lock your chair back into virtually any position.



Move the Workbench Chair's footrest upward or downward 177.8mm (7 in.)—hook your heels in and lean forward with confidence.



Angle the armsets of your Workstation/Managerial Chair and Executive Chair in either direction—rest your hands or get up close to your desk.

HP Ergonomic Chairs and accessories

	Description/Specifications	Color	Product number	Price
HP Ergonomic Executive Chair	Seat specifications Height 413-483mm (16.25-19 in.) Width 483mm (19 in.) Depth 457mm (18 in.) Adjustment 413-483mm (16.25-19 in.)	Chair back specifications Height 457mm (18 in.) Width 445mm (17.5 in.) Adjustment 457-514mm (18-20 in.)	Gray	92208M (1-2) \$475.00 ea.
			Blue	92208N (3+) 440.00 ea.
			Beige	92208P
HP Ergonomic Workstation/Managerial Chair	Seat specifications Height 413-527mm (16.25-20.75 in.) Width 470mm (18.5 in.) Depth 457mm (18 in.) Adjustment 413-527mm (16.25-23 in.)	Chair back specifications Height 267mm (10.5 in.) Width 406mm (16 in.) Adjustment 267-394mm (10.5-15.5 in.)	Gray	92208E (1-2) \$245.00 ea.
			Blue	92208F (3+) 225.00 ea.
			Beige	92208G
HP Ergonomic Workbench Chair	Seat specifications Height 483-648mm (19-25.5 in.) Width 470mm (18.5 in.) Depth 457mm (18 in.) Adjustment 483-648mm (19-25.4 in.)	Blue	92208S (1-2) \$365.00 ea. (3+) 340.00 ea.	
Cylinder (MNP)	Replacement cylinder for 92208M/N/P HP Ergonomic Executive Chair		92208Q (1-2) \$40.00 ea. (3+) 37.00 ea.	
Cylinder (EFG)	Replacement cylinder for 92208E/F/G HP Ergonomic Workstation/Managerial Chair		92208H (1-2) \$40.00 ea. (3+) 37.00 ea.	
Cylinder (S)	Replacement cylinder for 92208S HP Ergonomic Workbench Chair		92208U (1-2) \$55.00 ea. (3+) 51.00 ea.	
Black Armset	Optional, reversible armset for 92208E/F/G HP Ergonomic Workstation/Managerial Chair		92208K (1-2) \$79.00 ea. (3+) 69.00 ea.	
Caster Set	Replacement sets for all the above HP Ergonomic Chairs		92208L (1-2) \$39.00 ea. (3+) 35.00 ea.	

Snap together your own custom workstation

Be creative—The MicroManager™ System introduces a practical alternative to custom designed workstations. You can mix and match the snap-together stacking modules into a peripheral stand, monitor cabinet, PC workstation, or whatever your working needs demand. The configurations are practically endless. Expand your workstation to meet your growing needs.

Each module conceals unsightly cables to give you a clean, cable-free appearance. Cable channels run vertically and horizontally throughout the frame of each module. Simply snap off the cable covers to route your cables along the channel system. Snap the cable covers back into place to conceal the cable path. With cables safely hidden, you won't have to worry about tripping over dangling cables when you move the MicroManager around your office.



Channels along each module conceal unsightly cables

Starting with the basics

The base floor unit (92299A) consists of two standard modules stacked together, mounted on a four-wheel base. Mobile and sturdy, it forms a convenient platform for your HP ColorPro (7440) or 7470 Plotter, printers and disc drives.

Store modems, switches and other devices by simply adding on the standard module (92299B) to the base floor unit. You gain a taller mobile unit and more storage space.

Add versatility Mount the pull-out shelf (92299C) between your base floor unit and standard module (92299B) and gain easy access to your printers, plotters and disc drives.

Add the keyboard drawer module (92299D) to your base floor unit (92299A) and standard module (92299B) and you get a built-in roll-out drawer. The keyboard drawer locks into place to give you solid support for data entry.





Save with PC workstation kits Save time and money—take advantage of our two computer workstation kits. Use the 92299E compact PC workstation for your HP Touchscreen I/II (HP 150 Personal Computers) and Model 16 computers, as well as for your terminals. Use the 92299F compact workstation for your HP Vectra PC. The packaged price will save you money over the cost of modules when purchased individually.

Order what you need now. Later on, add to your workstation as your needs grow. The MicroManager System puts you in control of your budget. See the latest additions to HP's MicroManager™ system on the next page.

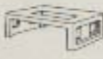

Constructed of high-impact styrene, the modules are easily assembled with a screwdriver.

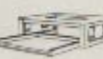
HP MicroManager™ system*

Part No.	Description	Price
 92299A	Floor Unit. Two standard modules on a locking caster base. 18 in. (457 mm) H x 24.25 in. (616 mm) W x 17.5 in. (445 mm) D.	(1-2 units) ... \$109.00 ea. (3-5) ... 103.00 ea. (6-9) ... 98.00 ea. (10+) ... 93.00 ea.
 92299B	Standard module. Can be stacked on 92299A or used on desktop as a printer stand. 7.25 in. (184 mm) H x 24.25 in. (616 mm) W x 17.5 in. (445 mm) D.	(1-2 units) ... \$41.00 ea. (3-5) ... 38.00 ea. (6-9) ... 36.00 ea. (10+) ... 33.00 ea.
 92299C	Pull-Out shelf module. Mounted between two 92299B modules. 1.5 in. (38 mm) H x 24.25 in. (616 mm) W x 17.5 in. (445 mm) D. Shelf: .75 in. (19 mm) H x 20.75 in. (527 mm) W x 15.5 in. (394 mm) D.	(1-2 units) ... \$49.00 ea. (3-5) ... 45.00 ea. (6-9) ... 41.00 ea. (10+) ... 39.00 ea.
 92299D	Keyboard drawer module. Can be stacked on standard modules or used on desktop. 4.5 in. (114 mm) H x 24.25 in. (616 mm) W x 17.5 in. (445 mm) D. Drawer: 2.6 in. (66 mm) H x 20.4 in. (518 mm) W x 10 in. (254 mm) D.	(1-2 units) ... \$95.00 ea. (3-5) ... 90.00 ea. (6-9) ... 87.00 ea. (10+) ... 83.00 ea.
 92299E	Compact PC workstation kit for HP Touchscreen I, II, Model 16 computers. Combination of 92299A,B,C/D. 30.5 in. (775 mm) H x 24.25 in. (616 mm) W x 17.5 in. (445 mm) D. Simple assembly required.	(1-2 units) ... \$270.00 ea. (3-5) ... 260.00 ea. (6-9) ... 250.00 ea. (10+) ... 240.00 ea.
 92299F	Compact workstation kit for Vectra PC. Combination of 92299A, 92299B, a special 1/2 height module, and 92299C (two each). 31.75 in. (806 mm) H x 24.25 in. (616 mm) W x 17.5 in. (445 mm) D. Simple assembly required.	(1-2 units) ... \$260.00 ea. (3-5) ... 250.00 ea. (6-9) ... 240.00 ea. (10+) ... 230.00 ea.

*All modules come in cream-gray color.

Workstations that grow along with your needs

With the help of the MicroManager™ System your office can be quickly organized. These compact units can be set up in almost endless configurations to make customized desktop stands, peripheral stations, or mobile work areas. Later, when you add new equipment or rearrange the office, you can interchange the modules or add new modules in a snap.

The stands are sturdy enough to hold CRT monitors, CPU's, printers or plotters. Each standard module contains concealed channels through which cables can be routed to reduce wire clutter. See previous page for the basic line of MicroManager components.



Place your work at the right angle Free up more space by attaching a copy holder (92299K) to the corner of any standard unit. This handy snap-on device is a must when data entry and word processing are your main activities. The viewing angle revolves 360 degrees so that documents can be positioned right where the operator can comfortably see and work with them. Combine the copy holder with a keyboard drawer unit (92299D) or your PC workstation (92299E/F) to form a complete data entry workstation.





Add to your work space Attach the side tray (92299J), shown in photo at left, to any standard module and gain extra surface area to spread out your work. It conveniently holds documents, flexible disk boxes, and other small accessories. The tray mounts on the front and rear corner channels. Two "snap-on" brackets are included to support up to 10 pounds of weight (4.5 kg).

Store plotter supplies in one place—right with the plotter

With a mobile plotter station (92299G) your HP plotter and all the pens, paper, and film used with it are conveniently organized in one compact unit. And it easily rolls into place wherever it's needed in the office. The plotter station consists of a floor unit (92299A), a custom plotter drawer that extends and retracts on ball bearing slides, and a standard module (92299B). Inside the plotter drawer are three storage bins, an organizer for 20 pens, space for two plotter pen carousels, a tray for paper and a tray for packaged pens. Extra paper and transparency film store on bottom shelves.

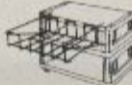

HP MicroManager™ accessories

Part no.	Description	Price
 92299G	Mobile Plotter Station* for HP ColorPro, 7470A, and 7475A plotters. Floor unit and standard module (92299A/B) combined with special plotter drawer. 26.25 in. (667 mm) H x 24.25 in. (616 mm) W x 17.5 in. (445 mm) D.	(1-2 units) ... \$249.00 ea. (3-5) 239.00 ea. (6-9) 225.00 ea. (10+) 210.00 ea.
 92299J	Side Tray.* Can be mounted on 92299G or 92299E/F, or any standard module. 1/2 in. (12.7 mm) H x 9 1/4 in. (251 mm) W x 17.5 in. (445 mm) D.	(1-2 units) ... \$17.00 ea. (3-5) 16.00 ea. (6-9) 15.00 ea. (10+) 14.00 ea.
 92299K	Copy Holder.* Mounts into corner of 92299G or 92299E/F, or any standard module. 9.5 in. (241 mm) W x 12.5 in. (318 mm) H.	(1-2 units) ... \$34.00 ea. (3-5) 32.00 ea. (6-9) 29.00 ea. (10+) 27.00 ea.
 92299L	Paper Refold Guide. Wire guide hooks onto back of module. 7.5 in. (191 mm) H x 18 in. (457 mm) W x 2 in. (51 mm) D.	(1-2 units) ... \$17.00 ea. (3-5) 16.00 ea. (6-9) 15.00 ea. (10+) 14.00 ea.
 92299M	Paper Catcher Basket. Wire basket hooks onto back of module. 4.5 in. (114 mm) H x 18 in. (457 mm) W x 16 in. (406 mm) D.	(1-2 units) ... \$34.00 ea. (3-5) 32.00 ea. (6-9) 29.00 ea. (10+) 27.00 ea.

*Constructed of high-impact styrene, in cream-gray color.



Paper refold guide (92299L) hooks onto the rear of any module to direct printouts into the module shelf below. The guide allows you to feed, print, and smoothly refeed a stack of paper 5 1/2-inches (140

mm) high, yet only increases the depth of the unit by 2-inches (51 mm).

The paper catcher basket

(92299M) hooks to the rear of standard modules to catch lengthy printouts. Paper is neatly stacked and smoothly stacked outside the module, freeing the unit shelves below for equipment. Leave it in place permanently or add when needed.



Locking mobile PC Centre saves space, adds security

HP's Mobile PC Centre—space efficient in dimension and spacious in design. It stands 4½ feet (1.31 m) high and takes up a minimum of floor space. Yet it has lots of room for your computer/terminal, disc drive and printer as well as your software, diskette holder, printer paper and other supplies. With no computer clutter on your desk you gain more work surface and more space for your other office needs.

You can easily maneuver this PC Centre behind, or next to, your desk, or anywhere you want your computer system to be. And when you're through for the day, simply slide in the roll-out shelves, close the doors and lock your PC Centre. No need to worry about the security of your computer equipment and invaluable data!

Top shelf accommodates any of the following HP computers and terminals: HP Vectra PC, Touchscreen/Touchscreen II (HP 150 Personal Computers), the Model 16 Technical Computer, and the 239X Series Terminals. Middle shelf will support either one of the HP InkJet Series Printers or 2603A Daisywheel Printer. Dimensions: 48.5 in. H x 25.9 in. W x 23.7 in. D (1,232 mm x 658 mm x 602 mm).

92208A Mobile PC Centre

(1-2 units) \$659.00 ea.
(3-9) 629.00 ea.
(10+) 595.00 ea.

The PC Centre is shipped unassembled and requires assembly with simple tools.

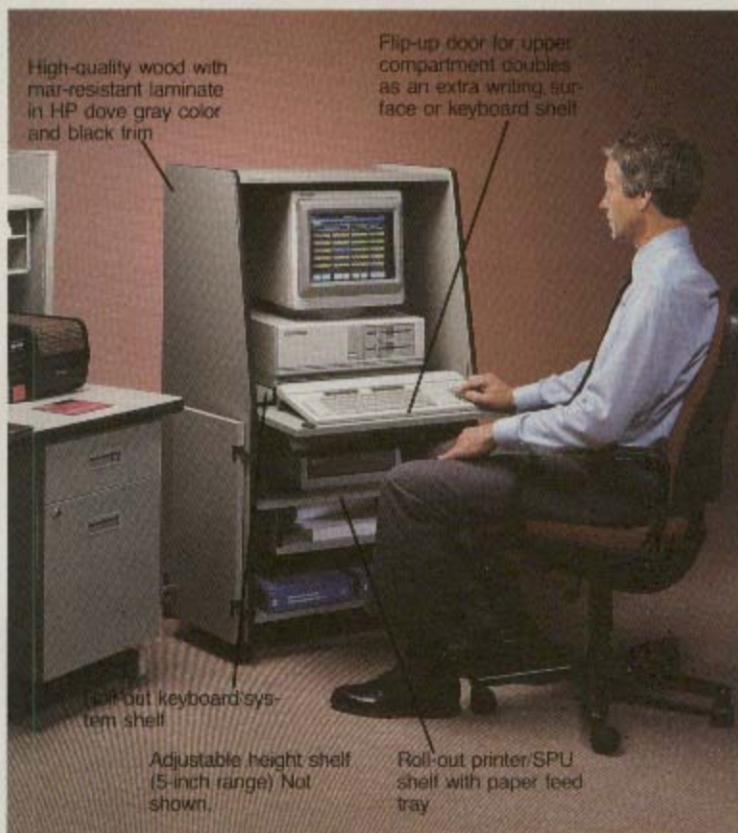
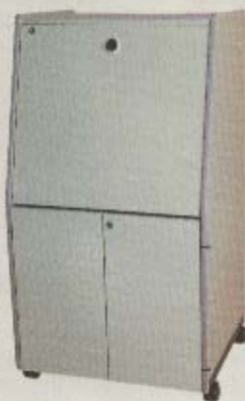

HP's mobile PC Centre keeps your computer/terminal, disc drive, printer, software, and other supplies all in one secure place.

HP mobile files store data out-of-sight until needed

Do you have stacks of files, printouts, or magnetic media that are taking up valuable work space, but are too important to throw away? With HP's mobile file units, you can store materials in a convenient corner or under a desk, rolling them out only when needed. And they're great for sharing reference material with co-workers. Smooth-gliding casters make it easy to move files from one area to another.

These practical drop-filing systems are available in both a compact and large size. The compact file is designed to fit under almost any desk or workstation, yet still offer a full 13.5-inches (343 mm) of horizontal filing capacity.

The larger file has an even greater horizontal filing capacity of 24 inches (610 mm), so you can move reams of data wherever needed. And while you're seated, its convenient chair-level height keeps files within easy reach.

Both files are all steel construction and cream gray in color. Casters are black. Simple assembly is required.

See next page for HP data binders and page 88 for magnetic media hanging files.

92272N Compact mobile file unit: 18.75 in. H x 16.5 in. L x 14.75 in. D (476 x 419 x 375 mm). Depth is adjustable up to 16.75 in. (424 mm).

(1-2 units) \$67.00 ea.
(3+) 59.00 ea.

92272M Mobile file unit: 24 in. H x 27 in. L x 20 in. D (610 x 686 x 508 mm). Depth is adjustable up to 17.5 in. (446 mm).

(1-2 units) \$139.00 ea.
(3+) 129.00 ea.



Store, protect laser and standard printouts in HP binders

Laser printout binders are made specifically to accommodate your 12- by 8.5-inch (305 mm x 216 mm) 2680 laser printouts. Their compact design will keep your frequently used printouts intact, neatly organized and protected from rips, tears and rough handling. See chart below.

Features:

- Loading from the top or bottom for easy updating.
- Special slide-out suspension hooks for easy adaptation to drop filing.
- Specially coated 20-point pressboard covers which provide more resistance to moisture, stain and wear than regular pressboard.
- Unbreakable plastic-coated steel posts that hold up to 6 inches of unburst printouts.

Standard printout binders. The same sturdy binders described above are also available in additional sizes to house your standard 14.8- x 11-inch (376 mm x 279 mm) printouts and 9.5 x 11-inch (241 mm x 279 mm) fanfold documents. See chart below.



Data binder handles convert binders which do not have slide-out suspension hooks to single point suspension featured in the 92272 storage cabinets. Both handles have the additional capability of center point suspension which will help increase space in your 92272 cabinets.

These handles are made of tough, durable plastic, have a hand slot for easy carrying and can be used in a drop filing situation. They also can be used with the 92174-series binders to serve as convenient carrying handles for larger printouts.

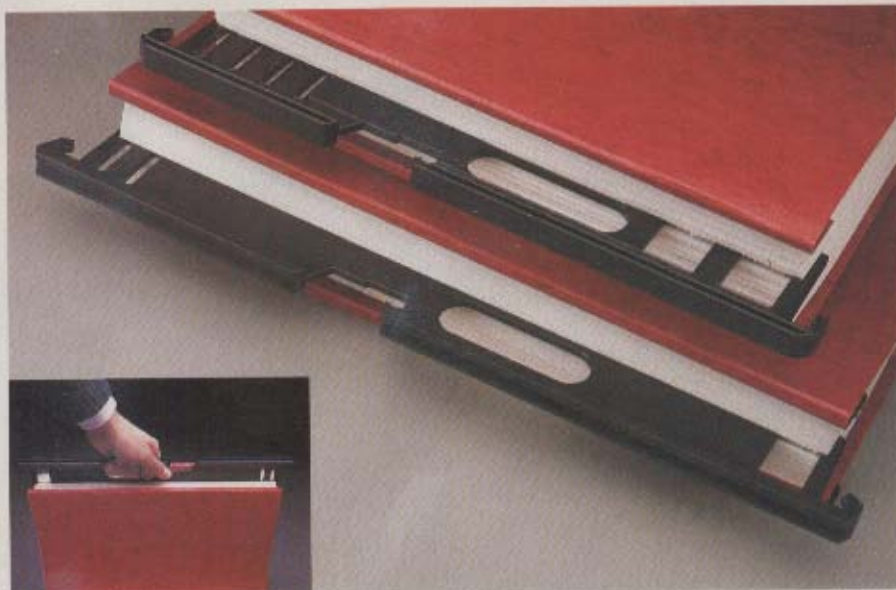

HP Data binders

Part no.	Color	Description (10 binders per box)	Price
92174A	red	14.8 x 11-in. (376 x 279 mm) binder. Holds up to 6 in. of unburst forms.	(1-4 boxes) . . . \$34.00 ea.
92174B	gray		(5-9) 32.00 ea.
92174C	light blue		(10+) 30.00 ea.
92174D	dark blue		
92174E	red	12 x 8.5-in. (305 x 216 mm) binder. Holds up to 6 in. of unburst forms.	
92174F	gray		
92174G	light blue		
92174H	dark blue		
92174J	red	9.5 x 11-in. (241 x 279 mm) binder. Holds up to 6 in. of unburst forms.	
92174K	dark blue		

Quantity discounts apply to purchase of single color only.

HP Data binder handles

Part no.	Color	Description (10 handles per box)	Price
92272K	Black	14-in. data binder handle. Converts 12 x 8.5-in (305 x 216 mm) data binders <i>not</i> having slide-out suspension hooks to single point suspension.	(1 box) \$42.00 ea.
			(2+) 36.00 ea.
92272L	Black	17-in. data binder handle. Converts 14.8 x 11-in. (376 x 279 mm) data binders <i>not</i> having slide-out suspension hooks to single point suspension.	(1 box) \$42.00 ea.
			(2+) 36.00 ea.

Quantity discounts apply to purchase of single product only.

*"Remember—Our listed prices
include shipment to you!"*



**HP storage cabinets . . .
pre-assembled and space-efficient**



92272A Workstation storage cabinet.*

Comes with one fixed shelf and two installed roll-out shelves. See next page for dimension details.

(1 cabinet) \$825.00 ea.
(2+) 780.00 ea.



92272B Medium storage cabinet.* Comes with one fixed shelf, two roll-out shelves and one installed hanger bar. See next page for dimension details.

(1 cabinet) \$990.00 ea.
(2+) 940.00 ea.



92272C Printout/documentation storage cabinet.* Comes with one fixed shelf and two installed hanger bars. See next page for dimension details.

(1 cabinet) \$825.00 ea.
(2+) 785.00 ea.

*Shown with optional 92272J oak top



92272D Mag tape storage cabinet. Comes with five installed hanger bars. Holds 170 tapes-in-seals. See next page for dimension details.

(1 cabinet) \$900.00 ea.
(2+) 855.00 ea.



92272E Large storage cabinet. Comes with one fixed shelf, two roll-out shelves, and two hanger bars. See next page for dimension details.

(1 cabinet) \$1125.00 ea.
(2+) 1050.00 ea.



92272F Library tape storage rack for high-density tape storage at minimum cost. Up to 300 tape reels in seals may be stored in any combination of 600-foot, 1200-foot or 2400-foot reels. Some assembly is required.

(1 rack) \$335.00 ea.
(2+) 308.00 ea.

Remember! Our listed prices include shipment to you (see back of catalog for details).

HP storage cabinets offer versatility and convenience plus!

Our line of cabinets offers you a more versatile, preconfigured system that will help save time and better organize your filing and storage needs.

They come pre-assembled in five common configurations so you don't have to build them—they arrive ready to use.

Another outstanding feature is the side-opening tambour door. No more bending or reaching to open and close your cabinet door. It glides open easily and when closed, locks to protect your stored data and media.

Other standard features:

- All steel construction
- Three cabinet heights to fit your storage needs
- Fixed and roll-out shelves for three-ring binders, disc cartridges and packs
- Hanger bars for data binders and mag tape in seals

- Optional oak woodgrain top for small and medium height cabinet tops

- Extra accessories for special storage requirements

With an attractive cream-grey finish, these cabinets are a perfect complement to HP *Design Plus* and HP Standard furniture, or any other office environment.

Also available are small and large data binder handles that convert standard data binders to single point suspension units. All hanger bars in the 92272 Series cabinets require a single or center point suspension capability for data binders. HP data binders, 92174A-H and J-K (page 113) already support single point suspension.

Finally, we pay the freight! That's right, we pay the freight to your location. No freight bill surprise when your cabinet arrives. Call and order today. Do allow extra time for delivery as these cabinets are shipped by truck.

Media and documentation storage cabinet guide (ordering information page 115)

Product no.	Cabinet description	Dimensions			Weight	Installed components			
		Height	Width	Depth		Fixed shelf	Hanger bars	Roll-out shelves	
92272A	Workstation storage	Outer:	98cm (38.5 in.)	93cm (36.5 in.)	53cm (21.0 in.)	67.3kg (148 lbs.)	1		2
		Inner:	84cm (33.0 in.)	79cm (31.0 in.)	47cm (18.6 in.)				
92272B	Medium storage	Outer:	152cm (60.0 in.)	93cm (36.5 in.)	53cm (21.0 in.)	103.2kg (227 lbs.)	1	1*	2
		Inner:	139cm (54.8 in.)	79cm (31.0 in.)	47cm (18.6 in.)				
92272C	Printout/documentation storage*	Same as 92272B above			90.0kg (198 lbs.)	1	2*		
92272D	Mag tape storage	Outer:	213cm (84.0 in.)	93cm (36.5 in.)	53cm (21.0 in.)	113.2kg (249 lbs.)			5*
		Inner:	199cm (78.5 in.)	79cm (31.0 in.)	47cm (18.6 in.)				
92272E	Large storage	Same as 92272D above			132.7kg (292 lbs.)	1	2*	2	
92272F	Library storage rack	200cm (79.5 in.)	123cm (48.5 in.)	33cm (13.2 in.)			6*		

*Mag tape-in-seals hang directly on bars. Printout documentation requires 92174-Series HP data binders or 92272K-L data binder handles to hang on bars.

Cabinet accessories

92272G Hanger Bar for data binders and mag tape. Holds 34 tapes-in-seals.

(1 bar) \$43.00 ea.
(2+) 38.00 ea.

92272H Fixed Shelf for documentation binders and miscellaneous items.

(1 shelf) \$55.00 ea.
(2+) 49.00 ea.

92272J Oak Top for 92272A/B/C cabinets. (Top is simulated oak woodgrain.)

(1 top) \$65.00 ea.
(2+) 55.00 ea.

92272K Data Binder Handles. Converts 30cm x 21cm (12 x 8.5 inch) data binders to single-point or center-point suspension for hanging on hanger bars. Handle

length is 35cm (14 inches). Not needed if using HP data binders unless you want to convert to center-point suspension. Comes in box of 10.

(1 box) \$42.00 ea.
(2+) 36.00 ea.

92272L Data Binder Handles. Converts 37cm x 28cm (14.8 x 11 inch) data binders to single point or center point suspension for hanging on hanger bars. Handle length is 43cm (17 inches). Not needed if using HP data binders unless you want to convert to center point suspension. Comes in box of 10.

(1 box) \$42.00 ea.
(2+) 36.00 ea.

Remember! Our prices include the cost of shipment to you (see back of catalog for details).

You can see the difference!

Today's computer terminals are operating where the work is—often where the lighting is less than perfect. Glare on the screen is annoying and, over time, it can reduce operator productivity.

HP offers you a high-quality solution—an optically-coated glass filter that cuts 94 percent of reflected glare.

Rugged construction HP Anti-glare filters use distortion-free safety glass. And the tough optical coating was selected by NASA for use on the windows of the Space Shuttle.

Low maintenance Taking care of the anti-glare filter is easy—just use ordinary household strength glass cleaner to remove fingerprints.

Easy installation Press-on/pull-off Velcro® strips make it easy to install. Just place the adhesive-backed strips on your terminal and press the filter into place.

Improved contrast User tests show that the anti-reflective optical coating actually enhances screen readability and improves character contrast.*



*Robert J. Beaton and Harry L. Snyder, Department of Industrial Engineering and Operator's Research, Virginia Polytechnic Institute and State University. "The Display Quality of Glare Filters for CRT Terminals."

Optically coated filters reduce annoying glare—increase productivity

HP's anti-glare filters put nothing between you and your data except a distortion-free, optically coated safety glass which actually increases contrast. There is no blurring of the image, nothing to obstruct your view.

Each filter is easily mounted in seconds with Velcro® strips. No tooling is required.

These filters will fit other terminals and computers, as well. The Velcro® mounting requires a .75-inch (2 cm) wide, flat surface on at least two sides. The accompanying illustrations will help you select the correct size.

Includes one 1 oz. bottle of screen-cleaning solution and lint-free wipes.

92193V Video clean kit. Clean your CRT terminal screens and other glass surfaces with two 4-ounce bottles of screen-cleaning solution, fifty 3 x 5-inch (8 x 13 cm) lint-free wipes and one easy-pour dispensing cap.

- (1 kit) \$17.00 ea.
- (2-4) 16.00 ea.
- (5+) 15.00 ea.



92207A Anti-glare filter.
For use with 262X-series terminals and the HP 125 Personal Computer.

- 92207A**
- a. 12.71 in. 32.28cm
 - b. 10.45 in. 26.49cm
 - c. 12.93 in. 32.84cm
 - d. 10.82 in. 27.48cm
 - x. 11.66 in. 29.61cm
 - y. 8.70 in. 22.09cm



92207C Anti-glare filter.
For use with the HP 86 Personal Computer.

- 92207C**
- a. 12.00 in. 30.48cm
 - b. 9.50 in. 24.13cm
 - x. 10.53 in. 26.74cm
 - y. 7.83 in. 19.88cm

92207A/C Anti-glare filters

- (1-2 units) \$115.00 ea.
- (3-6) 104.00 ea.
- (7+) 99.00 ea.

We ship same day

CALL HP DIRECT
800-538-8787

Call us with your Purchase Orders or



Build up—not out—with our desktop spacesavers



Keyboard park features a low profile for flat keyboard storage—only 65mm (2.6 in.) high—and will support HP 700 Series Terminals (except C1005 Opt. 500, 502 and 503), HP 2392 and 2394 Terminals as well as HP Touchscreen (HP 150) personal computers. Constructed of sturdy formed and bonded acrylic plastic. Exterior dimensions are: 65 H x 505 W x 285 D mm (2.6 H x 20.0 W x 11.2 D in.). ☺

92171J Keyboard Park	
(1–2 units)	\$75.00 ea.
(3–9)	66.00 ea.
(10+)	60.00 ea.



HP Vectra PC rack-mount shell kit. Now you can mount your HP Vectra PC processing unit in any standard 19 in. EIA rack cabinet with a shelf kit specifically designed to fit the Vectra footprint. Note: A rail kit is required to complete installation. For HP EIA racks, order 12679B Rail kit.

35199A Vectra PC Rack-mount Shelf	
(1–9 units)	\$79.00 ea.
(10–24)	72.00 ea.
12679B Rail kit	\$60.00 ea.

HP Vectra PC keyboard park. When you're through with your keyboard, slide it into its keyboard park. You'll gain valuable desktop space and protect your keyboard from accidental spills. Constructed of wood with mar-resistant laminate, this park will easily support your HP 700 Series Terminal, HP Vectra PC, monitor and other small items. Dimensions are 21 H x 612 W x 396 D mm (4.0 H x 24.1 W x 15.6 D in.). ☺

92166A HP Vectra PC Keyboard Park	
(1–2 units)	\$99.00 ea.
(3–9)	95.00 ea.
(10+)	89.00 ea.



Keyboard drawer park. Is your work surface too narrow to accommodate both a computer or terminal and its keyboard? We have the perfect solution for HP 700 Series Terminals, HP 262X, 2393, and 2397 Terminals, HP 120/125, Touchscreen (HP 150A/B), Touchscreen II (HP 150 II), HP Vectra PC and Model 16 computers. The 92171C park features a drawer mounted on industrial strength ball bearing glides that can be pulled out a full 11 in. from the support stand. Constructed of 14-gauge steel, the drawer will support up to 45kg (100 lbs.) and can be locked in the open position for stability. Also features a built-in palm rest. Color is pearl grey. Support platform dimensions are: 127 H x 584 W x 457 D mm (5.0 H x 23.0 W x 18.0 D in.). Keyboard drawer size is 559 W x 245 D mm (22.0 W x 9.75 D in.). ☺

92171C Keyboard Drawer Park	
(1–2 units)	\$95.00 ea.
(3–9)	87.00 ea.
(10+)	82.00 ea.

92171T Display turntable for properly positioning and sharing terminals. Turns 360 degrees on a strong, positive-position ball-bearing mechanism (limited by cabling). Color matches HP's standard workstation furniture (92210). Exterior dimensions: height 1.25 inches (32mm); width 20 inches (508mm); depth 24 inches (610mm). ☐

(1-2 turntables) \$67.00 ea.
 (3+) 64.00 ea.



92171T Display turntable



Left-92171A, Right-92171B

92171A Clamp-on copy holder is easily adjusted; you can position it where you need it to most conveniently reference your copy.

It clamps to vertical or horizontal surfaces up to 1.25 inches (32mm) thick, and has a maximum reach of 30 inches (762mm). The line guide is movable, and friction locks securely hold the position you have selected. ☐

(1-2 holders) \$53.00 ea.
 (3+) 48.00 ea.

92171B Easel copy holder. Placing this copy holder between detached keyboard and display means less eye strain for your data entry operators. The holder will tilt at the push of a button from zero to 90 degrees. The line guide mechanism is fingertip adjustable and can be used either on the left or right side of the holder, or may be completely removed.

This sturdy plastic copy holder is designed for page sizes up to 14.87 x 11 inches (378 x 279 mm) Cream-gray color. ☐

(1-2 holders) \$59.00 ea.
 (3+) 53.00 ea.

Angled footrest lets you work in comfort

92171E Footrest. Reduce lower back fatigue and circulation-restricting lower thigh pressure—raise your feet off the ground and onto our angled footrest. This is especially helpful for those who sit all day and do data entry or other desk work. Constructed of steel, these footrests also have ribbed rubber facings and non-slip rubber feet. Order several and help others take a load off their feet.

(1-2) \$43.00 ea.
 (3+) 36.00 ea.



92171E Footrest

Exclusively Ergo

Almost all chairs are designed to accommodate the physical dimensions of only 90% of the population (the 15th to 95th percentile). With a footrest, those under the 15th percentile can be just as comfortable as tall people in any particular chair. See the 92171E footrest at left.

Here's a stand that's great for your printer or your plotter!



Rear edge is curved and beveled to keep cables out of paper path and enhance paper flow.

This streamlined acrylic desktop stand increases desktop space and provides handy storage for printer paper or plotter media.

It's expressly designed to control fan-fold paper flow efficiently and route cables away from the paper path.

Great for your HP ColorPro 7440A graphics plotter (see page 62) or small dot matrix printer, including the HP PaintJet Printer. For your HP Printer, our paper catcher (see page 37) easily attaches to this printer stand to neatly refold and stack your printer output. Exterior dimensions are 4.9 in. (124 mm) H x 18.4 in. (467 mm) W x 13.25 in. (337 mm) D. ☐

92269A Desktop printer/plotter stand
 (1-2 units) \$79.00 ea.
 (3-9) 71.00 ea.
 (10+) 64.00 ea.

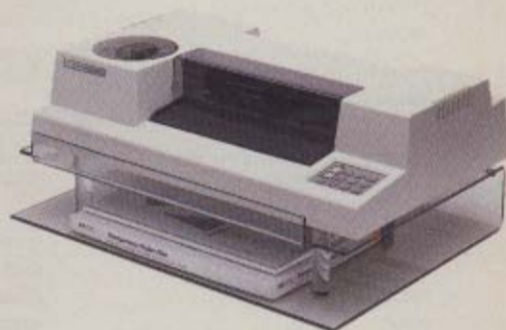

Turn the Desktop printer/plotter stand around for a convenient place to store plotter media.

Protect your HP equipment in the office

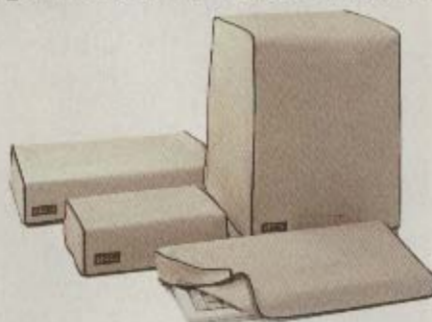

These attractive 100 percent cotton dust covers shield your valuable hardware from dust, spills and contaminants, while preventing harmful moisture from being trapped inside.

Designed expressly for HP PCs, printers and plotters, they offer a smooth fit without bulk or tightness.

Each cover folds easily for storage without excessive wrinkling. Seams are bound or double-stitched to ensure years of steady use.

It's optimal protection, to help your equipment last longer—and to help your office look tidier, too!



Heavy-gauge cotton and sturdy seam binding stand up to years of handling.

Terminal and computer covers

HP product model no.	Product number	Price
HP 125 ¹	92250B	\$30.00 ea.
Touchscreen PC (HP 150 A/B) ¹	92250F	\$20.00 ea.
Touchscreen II PC (HP 150 II) ¹	92250K	\$29.00 ea.
Touchscreen PC "stacked" (150A/B, 9121, 92240A/B) ¹	92251P	\$35.00 ea.
Vectra PC		
Monochrome monitor ²	92259A	\$30.00 ea.
Color/EGA monitor ²	92259B	30.00 ea.
Vectra CS/ES/ES12/RS PC		
Monochrome monitor ³	92259K	\$35.00 ea.
EGA monitor ⁴	92259L	35.00 ea.
VGA Monochrome monitor ⁴	92259M	35.00 ea.
VGA Color monitor ⁴	92259L	35.00 ea.
HP 700 Series Terminals		
102-key keyboard	92251Q	\$35.00 ea.
122-key keyboard	92251R	35.00 ea.
2392A ¹ , 2394A ¹	92251E	\$25.00 ea.
262X ¹	92250B	\$30.00 ea.
264X ¹	92250C	\$25.00 ea.
Integral Personal Computer (9807A)	92251F	\$59.00 ea.
9816 ¹ (Series 200 Model 16)	92250P	\$20.00 ea.

¹Includes covers for keyboard and CRT.

²Includes covers for CRT and 46030A keyboard.

³Includes covers for 35731A/D monitor and C1405A/B keyboard.

⁴Includes covers for D1182A/B or 35743A monitor and C1405A/B keyboard.

⁵Includes covers for D1181A/G/W monitor and C1405A/B keyboard.

Plotter, printer and disc drive covers

HP product model no.	Product number	Price
ThinkJet Printer	92250V	\$19.00 ea.
QuietJet Plus Printer	92250W	(1-2) ... \$27.00 ea. (3-4) ... 25.00 ea. (5+) ... 23.00 ea.
QuietJet Printer	92250X	(1-2) ... \$20.00 ea. (3-4) ... 18.00 ea. (5+) ... 16.00 ea.
2631	92251C	\$20.00 ea.
LaserJet Printer	92259C	\$30.00 ea.
LaserJet Series II Printer	92259G	\$30.00 ea.
7090A	92259D	\$25.00 ea.
ColorPro Plotter	07440-60006	\$12.00 ea.
7470A	92250N	\$25.00 ea.
7475A	07475-60010	\$15.00 ea.
7550A	07550-60210	\$18.00 ea.
82901M	92251A	\$15.00 ea.
82902M	92251B	\$15.00 ea.
82905A/B	92250T	\$15.00 ea.
9121S/D	92251D	\$12.00 ea.
PaintJet Printer	92250Z	\$22.00 ea.

Protect your HP equipment on the road



They're attractively fashioned from scuff-free vinyl, durable cordura, or elegant Italian leather, with ample storage space for paper and adapters.



Double-stitching and zippers (left) offer security for your equipment.

Transport your HP equipment safely and easily with these tailored-to-fit carrying cases.

Lightweight plastic base inserts hold equipment in place, while thick, cellular foam padding absorbs the shock of bumps and jars. And adjustable, nonslip shoulder straps lessen the possibility of slippage.

Openings are secured by long-lasting metal zippers or handy velcro, with wide, comfortable straps attached by metal rivets or double-stitching.



Terminal and computer cases

HP product model no.	Product no.	Exterior	Price
The PORTABLE (HP 110)			
Vinyl replacement carrying case	13269K	Vinyl	\$ 29.00
Soft leather briefcase	13269Z	Leather	89.00
System	13269V	Cordura	110.00
Touchscreen PC (150A/B) and 9121S/D	13269C	Vinyl	\$140.00
Touchscreen II PC (150 II)-2-piece case (monitor/disc drive & keyboard)	13269BB	Cordura	\$190.00
Vectra Portable	35178D	Cordura	\$ 89.00
Vectra PC 3-piece case (monochrome or color monitor, SPU & keyboard)	35178A	Cordura	\$190.00
Integral Personal Computer (9807A)	13269Y	Cordura	\$110.00

Plotter, printer and disc drive cases

HP product model no.	Product no.	Exterior	Price
7470A	07470-60001	Vinyl <i>Reduced price!</i>	\$150.00
ColorPro Plotter	07440-60001	Vinyl	\$280.00
7475A	07475-60001	Vinyl	\$225.00
9121S/D	13269T	Vinyl	\$65.00
ThinkJet Printer & 9114A/B	35178C	Cordura	\$59.00

NOTE: Cases are not intended for shipment or checked airline luggage.

For more information on carrying cases for The PORTABLE & Portable PLUS see page 133.

Static control—a key part of the computing environment

Sensitive components used in electronic equipment can be damaged by electrical discharges of just a few volts. Although the discharge path provided by proper grounding of electrical equipment provides significant protection, it is not a complete solution.

Static electricity is generated when two different materials come into contact and then are separated. Common actions, such as walking (shoes leaving floor), sitting (clothes rubbing against upholstery), and standing (clothes rubbing against the body), cause static energy buildup. The simple motions of a person working at a desk can develop a charge of 500 volts or more.

Consequently, controlling static is a must for getting the most out of your electronic equipment. Hewlett-Packard offers a complete line of anti-static products to help you do just that:

Tabletop mat—Just touch it before touching your electronic equipment.

Floor mats

- Hard-surface for use under chairs.
- Soft-surface for comfort at stand-up work stations.
- Carpet for comfort and appearance.

Staticide™ Spray and Wipes—For surfaces not protected by grounding devices.



Use Staticide Spray and Wipes on areas not protected by anti-static carpets and mats.

HELPFUL IDEAS!

Static facts

Static damage is described in two ways:

- Catastrophic—when the component is dead; the board/unit will not work.
- Degrading—when a discharge weakens a component, possibly causing premature failures within days, weeks or months after the incident, or characteristic changes such as intermittent failures (usually with temperature shifts, vibrations, or load variations).

	Most common static reading	Highest static reading
Walking across carpet	12,000 volts	39,000 volts
Walking across vinyl tile floor	4,000 volts	13,000 volts
Working at desk	500 volts	3,000 volts

*Institute of Electrical and Electronics Engineers Inc. (IEEE) from 15th Annual Proceedings of IEEE Reliability Physics.

The static charge level is:

3,500 volts
15,000 volts

When you:

feel
see

Staticide™ Spray and Wipes complete the protection your equipment deserves.

Non-toxic, non-flammable, biodegradable Staticide™ from ACL is the only EPA-registered anti-static solution and is now available in convenient spray bottles and handy wipes.

Use the spray on large areas, such as walls and floors, and the wipes on CRTs and keyboards. Since static attracts dust, you will be delighted with the wipes' cleaning ability, as well.

92176S Spray 1-quart (0.95 l) bottle with spray trigger	
(1-11)	\$10.95 ea.
(12+)	9.95 ea.
92176W Wipes 24 individually packaged wipes per box	
(1-11)	\$6.50 ea.
(12+)	6.00 ea.

HELPFUL IDEAS!

Controlling static facilitates LaserJet paper flow

If you live in a dry climate, static buildup may be causing your LaserJet pages to stick to your forward collator or to one another. This in turn may cause your printer to jam. Although the problem is serious, the solution is very simple. Just spray or wipe the forward collator with our easy-to-use anti-static spray and wipes. See above.

"I am looking forward to hearing many more of your smiles over the phone line."

I want to let you know how very well your Direct Marketing group is performing. Each time I call the (800) order line, I am greeted by someone who seems to enjoy working for HP, and continuing HP's tradition of excellence.

Being able to order all the supplies I need over a toll-free line is an invaluable aid to my business, and saves me much time and frustration. I have never reached a busy line, and a well-informed telemarketing sales person has always been able to answer my questions on the spot.

I just want to say thanks.

Very truly yours,

Paul Karkeck

Paul Karkeck
Owner, Wilderness Trading Posts
Sequim, Washington



(grounding wire included)

Static control mats*

1 92175A Black hard-surface mat

- For sit-down applications—castered chairs will roll easily on mat
- Shaped to fit most desks/workstations
- 10-foot (3.05m) ground wire

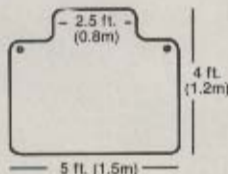

NOTE: Shipped by truck.
(1-2 mats) \$195.00 ea.
(3+) 175.00 ea.

2 92175B Chocolate brown soft-surface mat

- For stand-up application
- Cut-to-fit space requirements
- 10-foot (3.05 m) ground wire

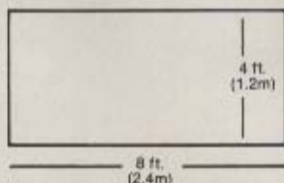

- Foam backing has both anti-skid and anti-fatigue characteristics

NOTE: Shipped by truck.
(1-2 mats) \$285.00 ea.
(3+) 255.00 ea.

3 92175C Small black hard-surface mat

- For sit-down applications—castered chairs will roll easily on mat
- Ideal for terminal and processing data entry
- 10-foot (3.05m) ground wire

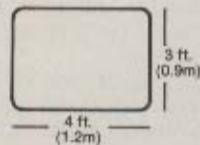

NOTE: Shipped by truck.
(1-2 mats) \$100.00 ea.
(3+) 91.00 ea.

Tabletop anti-static mat*

4 Now an alternative to floor mats is here! 92175T Tabletop mat

When anti-static carpets and floor mats are impractical or aesthetically unappealing, tabletop mats are the answer to static protection. Simply touch the mat before using your equipment and any charge you have generated will drain via the 10-foot ground wire.

For peripheral equipment positioned off the mat, the procedure is the same. Just touch the mat before handling the equipment and static charge is dissipated.

Our desktop mats are cushioned, skid-resistant and easily cleaned with deter-

gent and warm water. For a custom fit, they can be cut to size with heavy scissors.

Size: 23 x 30 inches (58 x 76 cm)
(1-2) \$59.00 ea.
(3+) 53.00 ea.

Anti-static carpets*

5 Carbon-impregnated filaments woven into the carpet automatically drain off static. This protection remains even after washing. Our exclusive non-skid backing prevents the mat from shifting or curling. And to complement all types of workstation furniture, our nubby-weave mats are offered in two warm hues. Grounding wire included.

Size: 4 x 6 foot (1.2 x 1.8m)

92176A Natural color
92176C Russet color
(1-2 mats) \$106.00 ea.
(3+) 98.00 ea.

Size: 4 x 8 foot (1.2 x 2.4m) shown in photo above

92176B Natural color
92176D Russet color
(1-2 mats) \$138.00 ea.
(3+) 129.00 ea.

*Recommended for HP computer installations by HP's Customer Engineers.

Prevent unauthorized equipment removal!

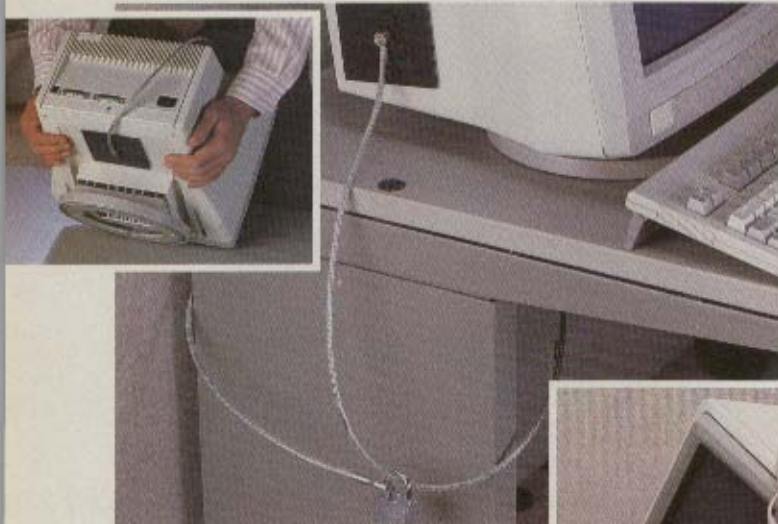

Safeguard property without drills or bolts.

The Plate lock security kit (left) protects your PC, terminal or peripheral equipment with reinforced steel cable, an aluminum plate secured by industrial-strength adhesive, and a sturdy padlock—a sure deterrent to unauthorized users!

Installation is simple: adhere the plate to a flat area of your equipment (use the kit's rubber feet if you place the plate underneath equipment). Loop the cable around your desk or a secured table leg. Then lock the cable. You can link several kits together to safeguard more than one piece of equipment, or use it in tandem with our 92172H Screw lock kit. To move secured equipment, you simply unlock the padlock.

Each Plate lock kit includes a 2-foot and 5-foot steel cable, rubber feet and a keylock, plus cleaning pads for installation preparation.



Protect equipment without additional drilling.

Using our Screw lock security kit (right) is as easy as swapping a screw from your equipment with a screw from our kit, and it protects up to three pieces of equipment.

Specially designed housings and socket-cap screws provide links for sturdy steel cables. Loop the cable through the links, then around a secured desk or table leg. Once installed, it becomes an integral part of your equipment; a keylock secures your property until you choose to move it. And this kit can be used in conjunction with the 92172G Plate lock security kit for an extra measure of precaution.

The Screw lock kit includes one 10-foot steel cable, a key padlock, five housings, five spacers, five washers, five #6 and #8 screws, and five #7 metric screws.

92172H Screw lock security kit	
(1-2 units)	\$49.00 ea.
(3-9)	46.00 ea.
(10+)	43.00 ea.

92172G Plate lock security kit	
(1-2 units)	\$29.00 ea.
(3-9)	26.00 ea.
(10+)	23.00 ea.

Don't let equipment disappear from your desk! Use a Plate lock security kit (left) for property without exposed screws, or a Screw lock security kit (below) if your property has exposed screws.



Foil data thieves, secure confidential files, satisfy internal auditors!

Securing valuable information is a growing concern of internal auditors. Our Data Lock dispels those concerns.

This tiny device piggy-backs on the HP-IB interface of your PC or HP 1000, 3000 or 9000 computer system. Data transmission from disc drive to screen is effectively halted with the turn of a key—until you unlock it!

Your application software, test statistics, business data and personal information is secured. What's more, unwanted computer use is prevented, and your HP-IB peripherals have an extra measure of protection. Installation takes minutes, and requires only a small screwdriver (included).

92172F Data Lock	\$102.00 ea.
-------------------------------	--------------

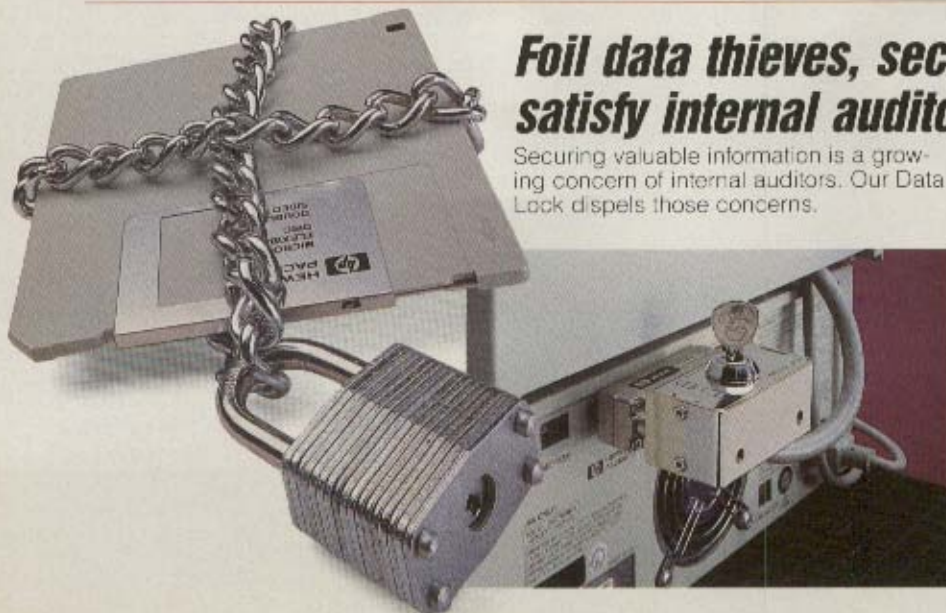

CALCULATORS, & PC SUPPLIES



HP calculators...continuing a tradition of technological innovation and user convenience with the HP 17B Business Calculator, HP 19B Business Consultant, HP 27S Scientific Calculator and HP 28S Advanced Scientific Calculator. To learn more, see page 128, or see your HP dealer.

- Infrared printer 126
- Calculator accessories 126-129
- Advanced programmable calculators 127
- Professional calculators 128
- Application software..... 130
- HP Vectra PC accessories 131
- Touchscreen PC (HP 150) accessories 132
- PORTABLE/Portable PLUS (HP 110) accessories 133
- Books 134
- Manuals 140
- Documentation storage .. 143



Print directly from your calculator—no cable connection required!

The battery-powered HP Infrared Printer is a revolutionary companion for your new HP-17B, 19B, 27S or 28S calculator, as well as the HP-18C or HP-28C. With the Infrared Printer Interface Module, you can also print from your HP-41C/CV or CX calculator.

Since it operates with an invisible infrared beam, no cord connection is necessary. Simply aim your calculator at the printer and send print directions. Producing hard copies—in a car, in the field, in your office—couldn't be easier. Print out a complete record of your work, or select and print only what you need.

Use four AA alkaline batteries for go-anywhere portability or extend battery life by plugging in the optional AC adapter.

- 82240A** HP Infrared Printer \$135.00 ea.
- 82175A** Black Thermal Printing Paper (6 rolls) 12.00 box
- 82241A** Infrared Printer Adapter 15.00 ea.
- 82242A** Infrared Printer Interface Module 65.00 ea.

See page 159 for replacement batteries

Protection for your Infrared Printer

Transport your HP Infrared Printer easily and elegantly with our custom-fitted cowhide case. It has a sturdy hand-carrying strap, a convenient flap closing and pigskin lining for additional durability. And it's styled to match the case of your HP calculator perfectly.

- 92169G** Black Infrared Printer Case \$25.00 ea.
- 92169H** Brown Infrared Printer Case \$25.00 ea.
- 92169J** Burgundy Infrared Printer Case \$25.00 ea.



Go to the head of the class with an HP-12C Programmable Calculator



HP-12C Programmable Financial Calculator

Perfect for professionals and students in business, finance and real estate. \$79.95 ea.

Solution Handbooks for the HP-12C

- 92233F** HP-12C Quick Reference Guide \$ 6.95 ea.
- 00012-90009** HP-12C Solutions Handbook 15.00 ea.
- 00012-90015** HP-12C Real Estate Handbook 15.00 ea.
- 00012-90021** HP-12C Leasing Applications Handbook 15.00 ea.

Keep your calculator handy

Desktop Calculator Stand. This sturdy acrylic stand holds your Series 10 professional calculator at just the right angle for easy display reading and efficient data entry. It measures 140mm (5.5 in.) wide by 114mm (4.5 in.) deep, and has rubber feet for firm footing on most any work surface.

- 92177S** Desktop Calculator Stand
- (1-3) \$15.00 ea.
- (4-9) 14.00 ea.
- (10+) 12.50 ea.



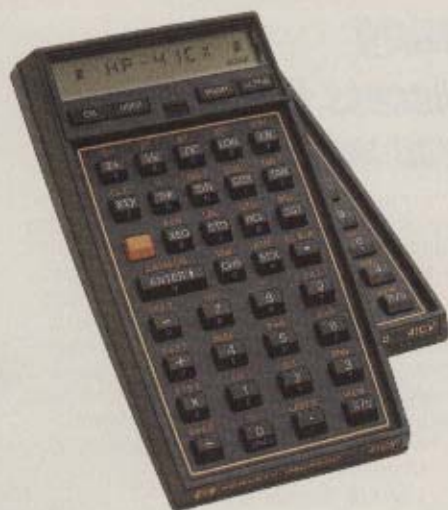

Calculate, analyze, monitor and control with HP-41 Advanced Programmable Calculators

Choose the HP-41 Advanced Programmable Calculator that best suits your needs. The HP-41CV has 2,233 bytes of built-in main memory and the HP-41CX has 3,101 bytes of built-in main and extended memory. The HP-41CX also has a text file editor, time module and 19 additional functions built in. Either model can be extended to 6,433 bytes with additional memory modules. Both have input/output capability and lots of available software.

HP-41CV Advanced Programmable Calculator	\$175.00 ea.
HP-41CX Advanced Programmable Calculator	249.00 ea.

Accessories:

82104A Magnetic card reader. Stores your programs and information on small magnetic cards.	\$195.00 ea.
82153A Optical barcode reader. Plugs into the HP-41, the wand reads bar codes.	\$125.00 ea.
82160A HP-IL interface module. Allows you to use the HP-IL devices listed below.	\$125.00 ea.
82180A Extended functions/memory module. Adds 889 bytes extended memory (functions in 41CX).	\$ 75.00 ea.
82181A Extended memory module. Adds 1,666 bytes on 238 data registers; use up to two of these modules. 82180A is required when using an HP-41C/CV.	\$ 75.00 ea.
82182A Time module. Clock functions exist in 41CX.	\$ 75.00 ea.
82183A Extended I/O module. Adds flexibility for accessing mass memory device. Requires 82160A HP-IL interface module.	\$ 75.00 ea.
00097-13143 120 Blank cards (no holders) for 82104A.	\$ 50.00 ea.
00097-13142 Three program card holders for 82104A.	\$ 15.00 ea.
82044A Security cable for 82143A, 82161A, 82162A.	\$25.00 ea.
82045A Blue-printing thermal paper. (6 rolls)	\$ 12.00 bx.
82175A Black-printing thermal paper for 82143A, 82162A and 82240A printers. (6 rolls)	\$ 12.00 bx.
82172A 50 Blank overlays.	\$ 55.00 ea.
82200A HP-41 touchpad.	\$ 20.00 ea.
82111A Soft case for HP-41 and 82104A card reader.	\$ 10.00 ea.
82120A Multipurpose rechargeable battery pack. Requires the 82059D (U.S.) or 82066B (European) AC adapter/recharger.	\$ 35.00 ea.
82059D AC adapter/recharger. For 2225B/P, 82120A, 82143A, 82161A, 82162A, 82163A, 82164A, 82165A, 82168A, 82169A 110 Vac.	\$ 20.00 ea.

82066B AC adapter/recharger. For 2225B/P, 82120A, 82143A, 82161A, 82162A, 82163A, 82164A, 82165A, 82168A, 82169A Euro, 220 Vac.	\$ 25.00 ea.
82176A Box of 10 mini cassettes. Each cassette can hold up to 128K bytes of information.	\$ 95.00 ea.
82033A Battery pack for 82162A.	\$ 25.00 ea.
82037A Reserve power pack for 82162A.	\$ 60.00 ea.

HP-IL Accessories:

82166C HP-IL interface kit.	\$395.00 ea.
82167A HP-IL cable (0.5m).	\$ 6.00 ea.
82167B HP-IL cable (1m).	\$ 8.00 ea.
82167D HP-IL cable (5m).	\$ 10.00 ea.
82160A HP-IL Series 40.	\$125.00 ea.
82161A Digital cassette drive.	\$550.00 ea.
82162A HP-IL thermal printer/plotter.	\$450.00 ea.
82164A HP-IL/RS-232C interface.	\$295.00 ea.
82165A HP-IL/GPI/O interface.	\$295.00 ea.
82169A HP-IL/HP-IB interface.	\$395.00 ea.

Software:

00041-15042 Auto-start duplication ROM.	\$40.00 ea.
00041-15006 Circuit analysis.	\$40.00 ea.
00041-15004 Financial decisions.	\$40.00 ea.
00041-15030 Financial decisions (Spanish).	\$40.00 ea.
00041-15022 Games.	\$40.00 ea.
00041-15020 Machine design.	\$40.00 ea.
00041-15001 Standard applications.	\$40.00 ea.
00041-15027 Stress analysis.	\$40.00 ea.
00041-15005 Surveying.	\$40.00 ea.
00041-15019 Thermal & transport science.	\$40.00 ea.
00041-15049 Math/Stat Pac.	\$45.00 ea.
00041-15016 Real estate.	\$45.00 ea.
00041-15021 Structural analysis.	\$45.00 ea.
00041-15055 HP-41 Advantage Pac.	\$49.00 ea.

00041-15043 HP-IL development module.	\$49.00 ea.
00041-15039 Petroleum fluids.	\$75.00 ea.

Solution Handbooks:

00041-90093 Antennas.	\$15.00 ea.
00041-90094 Business statistics/marketing/sales.	\$15.00 ea.
00041-90100 Chemical engineering.	\$15.00 ea.
00041-90102 Chemical.	\$15.00 ea.
00041-90089 Civil engineering.	\$15.00 ea.
00041-90092 Control systems.	\$15.00 ea.
00041-90088 Electrical engineering.	\$15.00 ea.
00041-90139 Fluid dynamics & hydraulics.	\$15.00 ea.
00041-90099 Games I.	\$15.00 ea.
00041-90443 Games II.	\$15.00 ea.
00041-90084 Geometry.	\$15.00 ea.
00041-90140 Heating ventilation & air condition.	\$15.00 ea.
00041-90083 High-level mathematics.	\$15.00 ea.
00041-90096 Home construction estimating.	\$15.00 ea.
00041-90086 Lending, savings & leasing.	\$15.00 ea.
00041-90090 Mechanical engineering.	\$15.00 ea.
00041-90142 Physics.	\$15.00 ea.
00041-90136 Real estate.	\$15.00 ea.
00041-90137 Small business.	\$15.00 ea.
00041-90138 Solar engineering.	\$15.00 ea.
00041-90141 Surveying.	\$15.00 ea.
00041-90082 Test statistics.	\$15.00 ea.
00041-90395 Time module solutions I.	\$15.00 ea.
00041-90441 Structural design (includes cassette).	\$35.00 ea.

Solution Handbooks—

For the HP-17B, HP-19B & HP-27S:

00017-90019 Real estate, banking & leasing.	\$9.95 ea.
00017-90020 Business finance & accounting.	\$9.95 ea.
00017-90021 Marketing & sales.	\$9.95 ea.
00017-90022 Personal investment & tax planning.	\$9.95 ea.

For the HP-19B & HP-27S:

00027-90044 Technical applications.	\$9.95 ea.
---	------------

For the HP-28S & HP-28C:

00028-90101 Algebra & college math.	\$9.95 ea.
00028-90102 Calculus.	\$9.95 ea.
00028-90104 Probability & statistics.	\$9.95 ea.
00028-90105 Vectors & matrices.	\$9.95 ea.
00028-90111 Mathematical applications.	\$9.95 ea.

We ship same day

**CALL HP DIRECT
800-538-8787**

Solve custom equations without programming

The HP Business Consultant II is the ultimate calculator for the business professional or student who wants only the best. It performs sophisticated analysis and handles diverse business problems, offering the most comprehensive set of business and financial functions found in any calculator. Plus, the HP Business Consultant II contains business graphics to plot histograms, scatter diagrams, curve fits for statistics and forecasting, and cash flow graphics. It performs net present value vs. interest rate; text application for names/addresses; currency and unit of measurement conversions;

list-based entries, mean standard deviation, custom labels and list copying, 6500 bytes of RAM, a 4-line by 23-character display; separate keyboards for numbers and letters; built-in ROM to allow messages and prompts to be displayed in German, Spanish, French, Italian and Portuguese.

HP Business Consultant II \$175.00 ea.

Access the functions you need most often

Powerful, easy to use and customizable, the HP-17B Business Calculator performs specialized and advanced business and financial computations. For the business professional or student, it provides more than 250 functions, including price and cost markups, percent change, percent total, interest rate conversions, list-based cash flow and statistics, and number lists with running totals. The HP-17B has 6500 bytes of RAM and a 2-line by 22-character display.

HP-17B Business Calculator \$110.00 ea.

Standard in both the HP Business Consultant II and the HP-17B are such innovative features as menus and softkeys for quick function selection; HP Solve for solving custom equations without programming; multiple-line displays; and an infrared interface for convenient, cordless operation with HP's 82240A Infrared Printer.



Tackle complex problems never before solved on a calculator

The HP-28S Advanced Scientific Calculator is the undisputed leader when it comes to power, functionality and state-of-the-art technology. With it, the technical professional or student can now easily tackle algebra, calculus and matrix problems never before solved on a handheld calculator. The HP-28S performs 1,500 functions and boasts 32K of RAM for creating and storing complex calculations, menus, formulas and programs; memory management for organized and logical sequence of stored items; symbolic algebra and calculus, matrix and vector arithmetic, and advanced statistics with multiple variables; an advanced graphics package to create, store and recall equation plots and graphs; ad-

vanced programmability; and a 4-line by 23-character display.

HP-28S Advanced Scientific Calculator \$235.00 ea.

Get two powerful calculators in one

The HP-27S Scientific Calculator is the perfect tool for the technical professional or student who needs both scientific and business solutions. This two-in-one powerhouse has more than 250 functions, including math capabilities such as logarithms, exponentials, trigonometry, hyperbolics, angle conversions and base

conversions; financial computations for time value of money, amortization and percent changes; number lists with running totals that can easily be edited, sorted and stored for statistics and forecasting; 6.7 bytes of RAM; and a 2-line by 22-character display.

HP-27S Scientific Calculator \$110.00 ea.

The HP-27S and HP-28S combine power and ease-of-use with innovative features including menus and softkeys to get you to the functions you want quickly; HP Solve for fast equation solving without programming; multiple-line displays; and an infrared interface for communication with HP's 82240A Infrared Printer via infrared light beam.

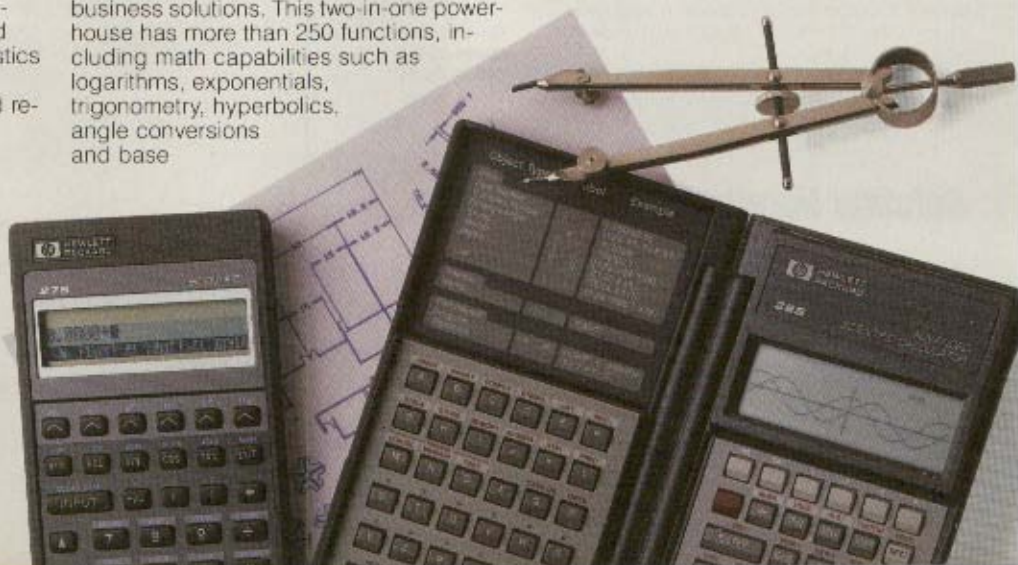

Simplify complex scientific problems

Whether you're a scientist or engineer, or studying to become one, you can expect unparalleled performance from an HP-22S or HP-32S Scientific Calculator.

The HP-22S helps students spend study time mastering coursework instead of their calculator. There's no programming to learn, cryptic keycodes to decipher or complex formulas to rearrange.

The formulas you need most are already programmed in: Ideal Gas Law, kinetic energy, roots of a quadratic equation and more. A library of 16 equations—66 variables in all!—makes easy

work of the calculations your courses require. No need to rearrange or re-enter equations to solve for different variables!

Use the HP-22S to uncomplicate statistics, linear regression, hyperbolics, unit and base conversions and polar/rectangular coordinate conversion. Its display is easy to read, with messages and prompts spelled out in English for easy identification and editing.

HP-22S Scientific Calculator .. \$59.95 ea.

Professionals use the HP-32S to transform raw data into meaningful results. It's built around the Reverse-Polish Notation (RPN) entry system, so you calculate without entering parentheses, or making extra keystrokes.

Prompts, menu labels and short messages help you every step of the way, and single-key macros simplify repetitive problems. Play out "what if" situations by setting your equation to zero, then solve for any variable—when the situation changes, simply enter the new values for your variables.

The HP-32S also features two-variable statistics with linear regression. Arithmetic can be performed in decimal, hexadecimal, octal or binary.

HP-32S Scientific Calculator .. \$69.95 ea.

Science and engineering professionals will appreciate the HP-32S calculator's RPN entry system, while students will love the algebraic HP-22S.



Protect that calculator

Leather calculator cases. You and your Series 10 professional calculator deserve the finest in leather calculator cases. Crafted of rich cowhide, each of these cases has a soft leather lining and is designed to fit easily into your pocket or briefcase.

92169A Black Leather Case .. \$12.00 ea.

92169B Brown Leather Case .. 12.00 ea.

82174A Soft Vinyl Replacement Case 5.00 ea.



Encase your calculator in elegant leather

Slip your HP-17B, 22S, 27S, or 32S calculator into our genuine leather case. It has a cowhide exterior; the interior is lined with pigskin, with padding between for additional protection. Available in three colors to match your HP Infrared Printer case.

92169K Black Leather Calculator Case \$19.00 ea.

92169L Brown Leather Calculator Case \$19.00 ea.

92169M Burgundy Leather Calculator Case \$19.00 ea.

Fine leather for your 18C, 19B, 28C and 28S

You will appreciate this fine leather protection for your HP 19B/18C Business Consultant or HP 28S/28C Scientific Professional calculator. Affordably priced, they're made of top-quality cowhide and are lined with calfskin and a second layer of pigskin for extra protection and style. Available in three colors.

92169D Black Leather Calculator Case \$19.00 ea.

92169E Brown Leather Calculator Case \$19.00 ea.

92169F Burgundy Leather Calculator Case \$19.00 ea.



Software for the HP Vectra PC™ and IBM PC™/IBM XT™/AT™

Software package name	Product no. 5.25 in. media	Price
AdvanceLink ¹	68333F	\$325.00 ea.
AdvanceWrite PLUS ^{2,3}	27546F	\$710.00 ea.
Charting Gallery ¹	Mouse 68350F	\$295.00 ea.
Drawing Gallery ¹	Mouse 68351F	\$395.00 ea.
Executive CardManager ⁴	Mouse 68331F	\$300.00 ea.
Executive MemoMaker ^{2,4}	68330F	\$295.00 ea.
Gallery Collection ^{1,6}	Mouse 68352F	\$695.00 ea.
LaserJet Printer Utility Software		
Font Load (download software fonts, see page 22)	33407B	\$ 20.00 ea.
iPrint (form generator) (see page 23)	35188D	\$349.95 ea.
LaserControl (see page 23)	35190J	\$150.00 ea.
LaserPlotter (see page 22)	35188A	\$150.00 ea.
PCLPak (see page 22)	33406B	\$ 79.00 ea.
ThinkJet/QuietJet/PaintJet Printer Utility Software		
JetPlotter (see pages 31, 38)	35190P	\$ 99.00 ea.
PaintJet Utility Software		
HP PaintJet Printer Soft fonts for Microsoft® Windows (see page 2)	new! 17301A	\$ 49.00 ea.
DeskJet Utility Software DeskPlotter (see page 34)	35184E	\$129.00 ea.
LaserControl (access fonts, see page 34)	35190J	\$150.00 ea.
RuggedWriter Utility Software		
MatrixPlotter (see page 2)	new! 35190R	\$ 99.00 ea.

¹Requires 384K memory
²Requires MS DOS 2.0 or above and dual-flexible or hard drive, 256K memory minimum for text only, 384K memory minimum for text plus graphics
³Requires 512K memory minimum
⁴Requires a dual-DS or hard disc system with 384K memory minimum
⁵Requires a dual-DS or hard disc system with 384K memory minimum for text only and 512K memory minimum for text plus graphics
⁶3.5-in. versions of these software packages are available through authorized HP dealers and sales offices.

Software for the HP Touchscreen/ Touchscreen II (HP 150 PCs)

Software package name	Product no. 3.5 in. media	Price
AdvanceLink	Touch 45431A	\$300.00 ea.
ChartingGallery ¹	Mouse Touch 45513A	\$295.00 ea.
DrawingGallery ¹	Mouse Touch 45411A	\$395.00 ea.
ExecutiveCardManager	Mouse Touch 45421A	\$300.00 ea.
ExecutiveMemoMaker ²	Touch 45418A	\$295.00 ea.
GalleryCollection ¹	Mouse Touch 45437A	\$695.00 ea.
PCLPak (see page 22)	33406A	\$ 79.00 ea.
SIDEWAYS		
WordPerfect 4.2 for single-sided discs 4	new! 35190L	(1-4) ... \$389.00 ea. (5-9) ... 369.00 ea. (10+) ... 359.00 ea.
WordPerfect 4.2 for double-sided discs 4	new! 35190K	(1-4) ... \$389.00 ea. (5-9) ... 369.00 ea. (10+) ... 359.00 ea.

Software for Apple Macintosh™

Software package name	Product no. 3.5 in. media	Price
LaserJet Printer Compatibility Software Printworks (see page 23)	35179P	\$145.00 ea.
Plotter Compatibility Software Plotstart (see page 59)	35184B	\$125.00 ea.
ThinkJet/QuietJet Printer Compatibility Software JetStart (see page 38)	35177M	\$ 45.00 ea.

How to upgrade or replace your HP software media

North American customers: If your software disc is damaged or discontinued or you wish to upgrade your software program to the latest revision, send in your original disc with a check or credit card number to:

Hewlett-Packard
Mail Order Dept.
P.O. Box 60008
Sunnyvale, CA 94088

Or send in a software update order form which can be obtained from the *HP PC Communicator* magazine, or call: 800-538-8787

Customers outside North America: Customers who have either damaged their software media or who wish to upgrade their software to the latest revision should take their original media to their local HP sales

office. The sales office will in turn order the replacements or upgrades.

Canadian customers: Please send in your original disc with preferred method of payment to:

HP Canada Limited
3710 Nashua Dr. Units A-E
Mississauga, Ontario
Canada
L4V 1M5



If you like WordPerfect, you'll love HP DIRECT

That's because we now offer this best-selling word processor for the HP Touchscreen PC (HP 150). It's the full-blown Version 4.2, complete with comprehensive thesaurus and 115,000-word spelling checker. And WordPerfect® is available

on single-sided or double-sided, 3.5-in. disc.

35190L WordPerfect on single-sided disc	
35190K WordPerfect on double-sided disc	
(1-4)	\$389.00 ea.
(5-9)	369.00 ea.
(10+)	359.00 ea.

HP-IL Interface card lets Vectra PCs talk and share information with the Portable PLUS, for convenience and productivity. Includes software and manuals.

82973A HP-IL Interface card \$155.00 ea.

Memory expansion cards. Expand your Vectra PC's memory from 640K bytes to 3.64M bytes by installing a combination of a 0.5M byte and 1M byte memory expansion card. The Vectra PC's Virtual Disc utility allows memory to be used as an "electronic disc" for storing large data files and accessing programs and data quickly. NOTE: These cards do not meet the Lotus™/Intel®/Microsoft® expanded memory specification. MS-DOS 3.1 can directly address a maximum of 640K byte memory. Additional memory may be configured as a high-speed RAM disc.

45973A 0.5M byte memory expansion card \$595.00 ea.
45974A 1M byte memory expansion card \$995.00 ea.

See the new product section for new accessories for your HP Vectra PC.

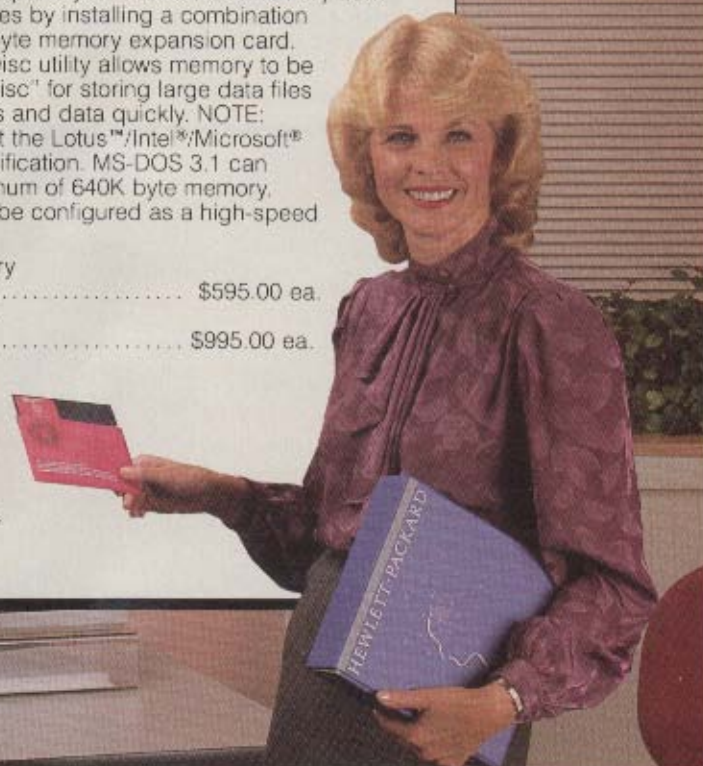

Enhancements for your HP Vectra Personal Computer

Disc/tape interface. Increase the external storage capacity of your Vectra PC, IBM® PC, PC/AT or PC/XT, or Compaq Portable.™ This low-cost disc/tape interface lets you daisy-chain as many as seven stand-alone disc drives and one tape backup system to a PC. It also allows you to access files without complicated DOS commands. Use it with HP's 9134H 20M byte stand-alone hard disc drive, 9134L 40M byte stand-alone hard disc drive, 9142A low-cost tape backup system and 9122D/S 710K byte stand alone micro disc drive (the latter is for the Vectra PC only). Includes interface card, cable, manual and software utilities.

88500A Disc/tape interface .. \$410.00 ea.

Dual RS-232 interface has a nine-pin male industry-standard (RS-232) serial port for asynchronous communications, plus a 25-pin female RS-232/HP422 port for full-duplex asynchronous communication up to 19.2K baud, and connection to HP 3000 computers as far away as 1200 meters. (Note: HP422 is HP's implementation of RS-422.)

24541B Dual RS-232/422 interface \$220.00 ea.

HP Graphics tablet. Use this high-performance, low-cost input device for menu selection, graphics placement, drawing and tracing. It works with HP Drawing Gallery, Microsoft® Windows for the HP Vectra PC and AutoCAD 2.52. You get a highly accurate 1200+ line-per-inch resolution that captures the most minute detail. Includes tablet, stylus with attached wand, two overlays and HP-HIL cable.

45911A HP Graphics tablet .. \$499.00 ea.

HP-HIL extension module. Position your CPU up three meters from your keyboard, and free up your desktop.

46080A HP-HIL extension module \$89.00 ea.

HP Mouse. This easy-to-install, Microsoft compatible device is great for applications that require precise cursor positioning. It has two buttons, tactile feedback and 200 pixel-per-inch resolution. Works with: Executive Card Manager, Executive Card Manager: Templates, Executive Spreadsheet, Drawing Gallery, Charting Gallery and The Gallery Collection.

46060A HP Mouse \$148.00 ea.

HP Touch facilitates one of the most natural means of communicating with a computer—pointing! Works with: Executive Memomaker, Executive Card Manager, Executive Card Manager: Templates and Executive spreadsheet. Requires the 46020-60001 or 92241A HP-HIL cable.

35723A HP Touch \$530.00 ea.

46020-60001 (92241A) HP-HIL cable 28.00 ea.

Security lock. Prevent unauthorized access to your Vectra PC with this key-lock security switch. Install it on the pop-out front panel of your PC, and you can protect your accessory cards, or guard accessory cards and files stored on hard disc. Just switch it off to access to data and internal workings.

45986A Security lock \$50.00 ea.

We ship same day

**CALL HP DIRECT
800-538-8787**

*Check with your local HP dealer or software manufacturer for software written to take advantage of the numeric 80287 Co-processor.

384K byte RAM board. It's easy to increase the memory of your Touchscreen (HP 150 A/B) or Touchscreen II (HP 150 II). Just install this 384K byte RAM board in one of its expansion slots, and you can utilize powerful business applications and graphics with speed and ease.

45632A 384K byte RAM board \$375.00 ea.

HP-HIL/384K byte RAM board. This board lets you increase the memory of your Touchscreen (HP 150 A/B) to 640K bytes, and add HP-HIL interface devices besides. It's all-new convenience for your Touchscreen! (NOTE: the Touchscreen II (HP 150 II) has a built-in HP-HIL interface and does not require this board.)

45915A HP-HIL/384K byte RAM board \$450.00 ea.



Enhancements for the Touchscreen Personal Computer (HP 150)

IBM 3278 Emulation accessory. Now your Touchscreen or Touchscreen II (HP 150 A/B or HP 150 II) can tap into data bases on your IBM system as if it were an IBM terminal. Enjoy easy access to departmental files—augment your PC applications with those on your company mainframe. Your IBM connection is maintained even while you use your Touchscreen as a PC. Just touch the screen to switch applications.

45641B IBM 3278 Emulation accessory \$1225.00 ea.

Extended I/O Accessory card. Your Touchscreen or Touchscreen II (HP 150 A/B or HP 150 II) can talk and share data files with The PORTABLE and Portable PLUS. With the Extended I/O Accessory card, you can download data compiled on HP portable computers in the field to Touchscreen PCs in the office...or vice versa. You can even send information from a Portable to the printer or disc drive of a Touchscreen. Save time, save energy, get more done! Includes HP-IL and Centron-

ics interfaces, software and manuals. Requires 82167A or 82167B cable.

45643A Extended I/O Accessory card \$181.00 ea.

82167A 0.5m HP-IL cable 6.00 ea.

82167B 1m HP-IL cable 8.00 ea.

HP Graphics tablet. Use this high-performance, low-cost input device for menu selection, graphics placement, drawing and tracing. It works with HP Painter, HP Drawing Gallery and Microsoft® Windows for the HP Touchscreen PC. You get a highly accurate 1200+ line-per-inch resolution that captures the most minute detail. Includes tablet, stylus with attached wand, two overlays and HP-HIL cable.

45911A HP Graphics tablet \$499.00 ea.

Bar code reader. This keyboard alternative is perfect for order entry applications such as material flow, item tracking and warehousing, on your Touchscreen or Touchscreen II (HP 150 A/B or HP 150 II).

The keyboard remains active while you're using the bar code reader, so you can mix bar code and keyboard entries in the same applications.

92915A Bar code reader for the Touchscreen (HP 150 A/B) \$600.00 ea.

92916A Bar code reader for the Touchscreen II (HP 150 II) \$600.00 ea.

HP Mouse makes moving around mouse-supported applications a breeze. It features two buttons, tactile feedback and 200 pixel-per-inch resolution. You'll find it an excellent tool for graphics applications. Touchscreen (HP 150 A/B) PCs require an HP-HIL accessory card.

46860A HP Mouse \$148.00 ea.

45914A HP-HIL accessory card 158.00 ea.

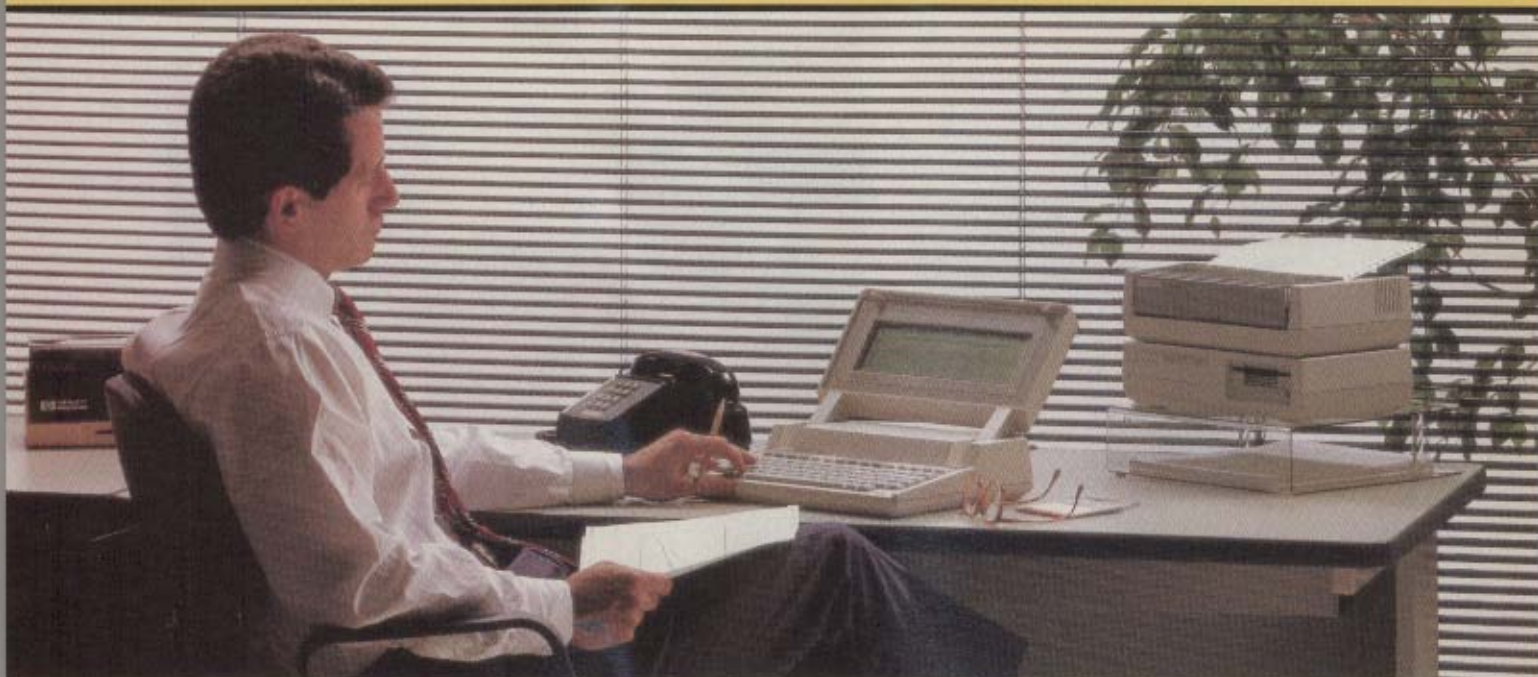

Enhancements for The PORTABLE and Portable PLUS



Software drawer. Add our Software drawer to your Portable PLUS, and you can plug in as many as 12 ROMs, of 32K or 128K byte capacity. Because typical ROM-based applications use one or two ROMs, you'll be able to access more applications, more quickly. Installation's as easy as plugging the drawer into one of your Portable PLUS' two expansion slots.

82982A Software drawer \$160.00 ea.

128K byte Memory drawer. Get 128K bytes of additional random-access memory that you slide easily into a Portable PLUS, and use more powerful applications with ease.

82981A 128K Memory drawer \$415.00 ea.

128K byte Memory card. You can add two additional 128K byte memory cards to a Memory drawer, for a total of 384K bytes of memory. More power for your Portable PLUS...more convenience for you!

82984A 128K Memory card . \$260.00 ea.



Extended I/O Accessory card. Now you can use The PORTABLE or Portable PLUS to talk and share data files with the Touchscreen or Touchscreen II (HP 150 A/B or HP 150 II). The Extended I/O card also lets HP portable computers use Touchscreen PC printers or disc drives as output devices. It's a must for sales force automation. Includes software.

45643A Extended I/O Accessory card ☐ \$195.00 ea.

HP-IL Interface card. With this interface card, you can use your Portable PLUS to talk and share data files with the Vectra PC or IBM PC, PC/XT or PC/AT, or output data to those PC's printers and disc drives. Turn your Portable PLUS into a great communicator! Includes software.

82973A HP-IL Interface card ☐ \$165.00 ea.

Replacement battery for The PORTABLE and Portable PLUS disc drives. ☐

88014B \$65.00 ea.



The System SLIMLINE

(above) holds your PORTABLE or Portable PLUS, micro drive and ThinkJet Printer, plenty of discs, a rechargeable battery or two, and some printer paper. Light padding separates each component and protects your valuable equipment against the scrapes and bangs of normal travel. Custom styled at only 7 1/4 in. wide, 18 in. long, and 12 in. high (184.15 mm x 457.20 mm x 304.80 mm), the SLIMLINE easily fits under an airline seat.

13269V The System SLIMLINE ☐ \$110.00 ea.

Plush leather briefcase (left) has three large pockets for as many as six file folders and two small pockets for your calculator, pens and pencils. It also features two carrying handles and a removable shoulder strap. Dimensions are 3.50 in. (88.90 mm) W x 17.25 in. (438.15 mm) L x 10.25 in. (260.35 mm) D.

13269Z Plush Leather briefcase ☐ \$89.00 ea.

Handheld calculators

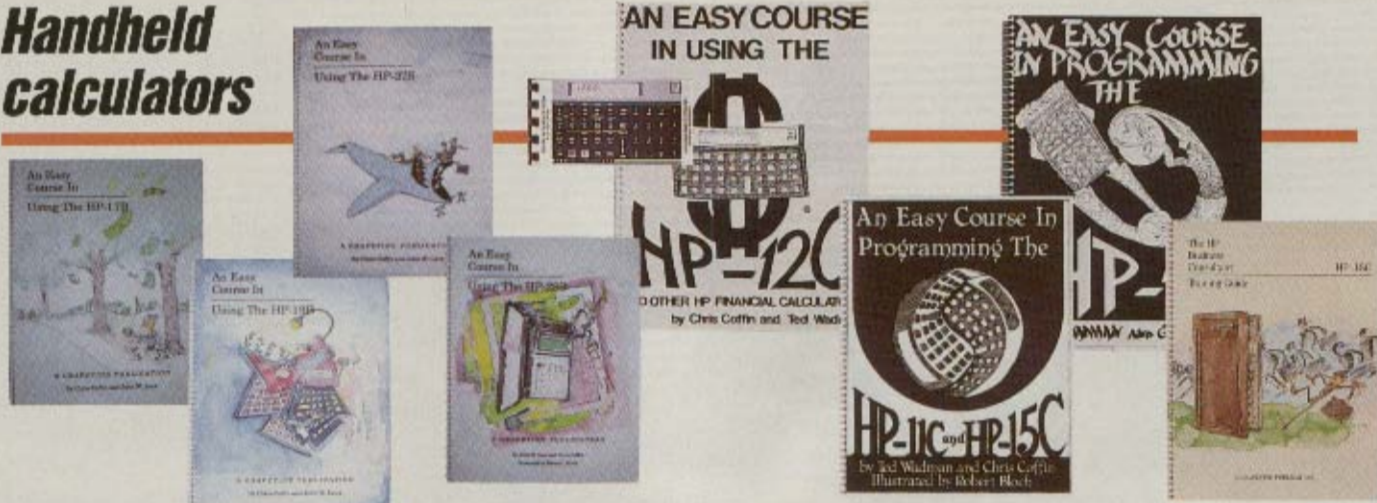

Special books for special interests

We are pleased to offer for your convenience a selection of computer-related books, which can be ordered without leaving your desk. These books have been carefully selected for excellence in their subject areas and also provide a selection

of topics that should interest many people in different parts of any organization. For easy reference, titles are organized into major subject areas. Browse through the list and remember — these books are only a phone call away!

Handheld calculators

An Easy Course in Using the HP-17B Chris Coffin and John W. Loux/Grapevine Publications 1987

This book presents the workings of your HP-17B calculator to you in a uniquely understandable fashion. It shows you how to work with menus, lists and arithmetic, and how to develop a personal list of equations. There's also information on built-in financial equations, the "hows and whys" of loans, mortgages and investments, and how the Time Value of Money (TVM) keys make sense out of it all.

92236A \$22.00 ea.

An Easy Course in Using the HP-19B Chris Coffin and John W. Loux/Grapevine Publications 1987

This book shows you how to work with menus, lists, arithmetic, and how to develop a personal list of equations. It also helps you use your calculator's built-in financial equations and Time Value of Money (TVM) keys, and tells you all about NPV, NFV, IRR and MIRR. Clear diagrams and explicit examples are included.

92236B \$22.00 ea.

An Easy Course in Using the HP-27S Chris Coffin and John W. Loux/Grapevine Publications 1987

This book guides you through keyboard operation, arithmetic and menu use. It offers a close look at the built-in equation SOLVER, including its "smart" features, such as conditional tests, multiple solutions and list functions. You get a series of commonly encountered problems in science, math and engineering. And as an added bonus, you get an extensive look at personal finance, using the TVM (Time Value of Money) menu, where you'll learn all about the concepts and methods of financial analysis and problem solving.

92236C \$22.00 ea.

An Easy Course in Using the HP-28S Chris Coffin and John W. Loux/Grapevine Publications 1987

This book first brings you up to speed on the mechanics of operation: what keys to press to control and command the display, the stack, and the menus. It then helps you explore the different information "objects" and how you can manipulate them, combine them, name them and (best of all) think about them. Brief separate discussions also touch upon specialized topics like symbolic algebra and calculus, plotting and programming.

92236D \$22.00 ea.

Quick Reference Book for the HP-12C Evan Gost 1984

Take this handy reference book with you—it fits right in the HP-12C carrying case along with your calculator. Inside you'll find easy-to-follow examples for almost all of the popular HP-12C functions. Loan amortization, annuity value, blended rate mortgages, depreciation, future value, internal rate of return, leases, variable rate mortgages, and weighted averages are just a few of the topics discussed. 

92233F \$6.95 ea.

An Easy Course in Using the HP-12C C. Coffin and T. Wadman/Grapevine Publications 1984

A self-paced, easy-to-follow course book for your HP-12C Financial Calculator. Devoid of highly technical and confusing jargon, its rich conversational style and classic illustrations make learning about the HP-12C easy and fun. Filled with examples, explanations, self tests, and solutions, this text introduces you to the "Hows and Whys" of loans, mortgages, investments, NPR and IRR calculations, and much more. Take your time, set your own pace, and enjoy learning to use your HP-12C.

92234S \$22.00 ea.

An Easy Course in Programming the HP-11C and HP-15C T. Wadman and C. Coffin/Grapevine Publications 1984

Learn to master the capabilities of your HP-11C or HP-15C calculator. In a conversant and jargon-free style, this self-paced course will help you get the most out of your calculator. Humor, graphics, examples and review questions make reading enjoyable and learning fun. Discover how to use features like data registers, stacks, decision-making, branching, indirect addressing and more. Set your own pace, and in no time you'll be using your HP-11C or HP-15C like an expert.

92234W \$22.00 ea.

An Easy Course in Programming the HP-41 T. Wadman and C. Coffin/Grapevine Publications 1984

Get to know your HP-41 Advanced Programmable Calculator. In understandable and friendly terms, this self-paced course leads you on an enjoyable learning excursion, complete with review questions, explanations, self tests, and lots of examples. Learn about data, stack and alpha registers, the keyboard, its functions and arithmetic, program memory, labels, flags and conditional tests; indirect addressing and alphanumerics; and much more. Soon you will be programming like an expert. Applicable to the HP-41C, HP-41CV, and HP-41CX.

92234T \$22.00 ea.

The HP Business Consultant Training Guide C. Coffin and T. Wadman/Grapevine Publications 1986

In everyday English, this friendly guide explains how you can use your HP-18C Business Consultant Calculator to develop a personal list of equations and work with menus, lists, and arithmetic. Learn to use built-in financial equations, NPV, NFV, IRR, loan, lease, mortgage, and investment functions with ease.

92235T \$21.95 ea.

Programming languages



Programming languages

Turbo Pascal Programs for Scientists and Engineers Alan R. Miller/Sybex 1987

The author develops commonly-needed algorithms for science and engineering, then programs them in Turbo Pascal. Includes algorithms for statistics, simultaneous solution, curve fitting, integration and non-linear equations.

92220K \$20.95 ea.

Turbo Pascal Tips, Tricks and Traps Tom Rugg and Phil Feldman/Que Corporation 1987

This book helps you get the most out of your Pascal programming. You'll learn new ways to use Turbo Pascal's unique features and ways to avoid problem areas, plus techniques for designing subprograms, passing parameters, using recursion and creating procedures and functions.

92220L \$20.95 ea.

Structured FORTRAN 77 Programming with Hewlett-Packard Computers Seymour V. Pollack/Boyd & Fraser 1983

Learn structured FORTRAN 77 programming from the ground up. This book is an effective introductory text for beginners. For those with experience, it provides an orderly presentation of FORTRAN 77 and its effective use. And numerous well-structured examples illustrate the use of key features of this language. All examples and programs have been tested on the HP 1000/9000.

92836-90005 \$40.00 ea.

Programming in Pascal with Hewlett-Packard Pascal Peter Grogono/Hewlett-Packard 1984

Programming in Pascal is a revised version of Programming in Pascal with Pascal/1000. It explains the computer programming language Pascal, as described by the DRAFT ANSI Standard, and the enhancements to standard Pascal provided by HP Pascal/1000 and Pascal/9000 compilers. Throughout the 10 chapters, each extension to standard Pascal is identified, and a separate appendix section summarizes the differences between standard Pascal and HP Pascal/1000 and Pascal/9000. The book assumes no prior knowledge of other programming languages and is intended for people who want to write programs in Pascal.

97082-90002 \$50.00 ea.

An Introduction to Programming & Problem Solving in Pascal M. Schneider, S. Weingard and D. Perlman/Wiley & Sons 1978

An excellent general introductory book that teaches

Data communications



Pascal by using it as a vehicle to illustrate the fundamentals of programming and good style. Appendices contain the complete syntax of Pascal and a list of all standard Pascal identifiers, along with a description of all functions and operators. A recommended reference tool for the HP 9000 Series 200 Pascal users.

09826-90072 \$40.00 ea.

Data communications

Touring Datacomm: A Data Communications Primer Hewlett-Packard 1983

The Data Communications Primer introduces you to the basic concepts of data communications, beginning with a discussion of simple communications concepts and gradually moving toward more complex topics. Covers hardware and software, transmissions methods and channels, line configurations and interfaces, signal conversion, multiplexing, common carrier services, network structures and capabilities, protocols, and architectures. Designed for readers with little or no previous knowledge of data communications.

5957-4622 \$9.00 ea.

Communicating with IBM: An HP-to-IBM Communications Primer Hewlett-Packard 1984

Communicating with IBM is one of a series of HP primers on data communications. The first book in the series, Touring Datacomm, presented a broad overview of computers and data communications. This primer builds on that base and focuses on the world of HP-to-IBM communications. An overview of HP-to-IBM networks is discussed, followed by an introduction to each of the main components of those networks. Topics include: IBM mainframes, IBM operating systems, job entry subsystems, communications access methods, communications controllers, basic SNA concepts, emulation, IBM remote devices, and HP-to-IBM data communications products. As you progress through this primer, you will read about HP products that run on various systems, including the HP Touchscreen, 250, 1000, 3000, and 9000. This book provides a valuable introduction to IBM and HP-to-IBM data communications. Written for individuals who have a general background in computers and data communications, but little or no previous experience with IBM systems or with HP-to-IBM products.

5957-4623 \$6.00 ea.

Making the LAN Connection: A Local Area Network Primer Hewlett-Packard 1984

Another in the HP series on data communications, this primer presents a generic overview of local area networks (LANs) and gives some specific information on HP's LAN implementation. Topics discussed include the characteristics and advantages of

LANs, some of the criteria for evaluating a LAN, common applications and options that must be considered for a LAN, industry standards and HP's LAN implementation, and a glossary which contains brief descriptions of terms used in the text. Written for those who have some familiarity with the concepts covered in Touring Datacomm. A Data Communications Primer, the first in the series of data communications primers.

5957-4624 \$6.00 ea.

The HP-IL System: An Introductory Guide to the Hewlett-Packard Interface Loop G. Kane, S. Harper, and D. Ushijima/Osborne/McGraw-Hill 1982

Use this definitive guide to learn about the Hewlett-Packard Interface Loop (HP-IL), an eight-bit serial interface designed for portable battery-operable systems. HP-IL makes a new generation of portable systems and peripherals possible by linking the HP Series 40 Programmable Calculators, Series 70 Handheld Computers, Series 80 Personal Computers, and The PORTABLE (HP 110) Computer to low-power, low-cost peripheral devices and test equipment. The first third of this book is an overview of HP-IL and the remainder presents an in-depth discussion of HP-IL and its inner workings.

92233A \$22.00 ea.

The RS-232 Solution Joe Campbell/SYBEX 1984

This is both a "how it works" and "how to work it" book on the popular, and often misunderstood RS-232C interface. A working methodology is presented to help the reader build an interface between any two "RS-232C compatible" devices. Knowledge of electronics or circuitry isn't necessary, although some knowledge of computer concepts is assumed. Topics discussed include basic RS-232C interfacing concepts, hardware and software handshaking, print buffers, pin names and numbers, device control, and testing procedures. Several case studies are presented along with a discussion of how software can dramatically alter the personality of the RS-232C interface.

92234X \$18.95 ea.

Computer Networks A. Tanenbaum/Prentice Hall 1981

A comprehensive introduction to the expanding field of computer networks. Discusses network architectures and protocols from the physical layer to the application layer, and from local networks to satellite networks. No prior background in computer networks is assumed, though a general familiarity with computer systems and programming is desirable.

92233V \$44.00 ea.

Operating systems

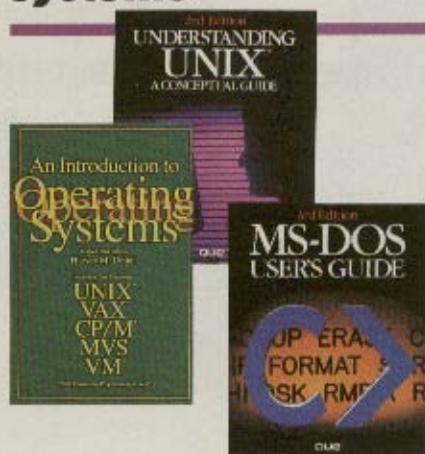

Operating systems

An Introduction to Operating Systems
H. Deitel/Addison-Wesley 1983

An up-to-date professional reference covering all the fundamental concepts of operating systems. Major topics include: an introduction and history of operating systems, process management, storage management, processor management, auxiliary software management, system performance, networking and security issues. A final section presents five detailed case studies of major operating systems including UNIX™

92234K \$40.00 ea.

Understanding UNIX: A Conceptual Guide, 2nd edition Paul N. Weinberg and James R. Groff/Que Corporation 1988

For technical and nontechnical readers alike, this book offers a superb introduction to the UNIX operating system. It discusses UNIX's standing in the world of computing, describes major UNIX features and benefits, and explains the structure of UNIX.

5954-9907 new! \$22.95 ea.

MS-DOS™ User's Guide, 3rd edition
Chris DeVoney/QUE Corporation 1988

An excellent source of essential information about one of your computer's most important software programs, the Operating System. This tutorial explains the simple tasks you need to know as you begin to use MS-DOS™ such as disc formatting and file copying. This book also offers a wealth of information on more advanced topics, including the MS-DOS™ hierarchical directory and I/O redirection. Particularly useful are the many hands-on learning sessions that guide you step-by-step through important procedures. The final section explains each of the MS-DOS™ commands, including examples of command syntax. An exceptional generic MS-DOS™ tutorial.

92234Q new! \$19.95 ea.

Graphics



Graphics

Steps to Effective Business Graphics
B. Matkowski/Hewlett-Packard 1983

A well-illustrated guide to the production of professional business graphics for information, presentation or publications. Clearly written instructions and full color examples lead the reader through all the steps involved in the preparation of effective 35 mm slides, flip charts, overhead transparencies and report graphics. Other topics include audience analysis, effective graphics techniques and selecting a computer graphics system to do the job you need. ☺

5957-6979 \$12.00 ea.

Fundamentals of Interactive Computer Graphics
J. Foley and A. Van Dam/Addison-Wesley 1982

An excellent presentation of basic graphics concepts and recent advances in graphics hardware and software. A graphics applications program is developed in Pascal, using the new Core System of standard graphics subroutines. The sequence of subjects presented allows you to quickly begin programming projects and then study hardware and software issues in parallel.

- Topics include:
- Systems organization, and device technology of raster and vector devices
 - Core system-like subroutine package including 2D and 3D viewing, clipping segmentation, interaction handling and device driver structure
 - 3D geometrical transformers, projections and b-cubic surfaces
 - Hierarchical data structures for graphics
 - The first comprehensive treatment of color theory practice for computer graphics

92233X \$42.00 ea.

Professional reference

Art of Computer Programming—Volumes I, II & III
Donald Knuth/Addison-Wesley 1973, 1981 and 1973

These books are known worldwide as "classic" technical references in their subject areas by programmers, system analysts and software developers. They may be purchased as a set or individually to complete your collection.

Professional reference



Volume I: Fundamental Algorithms, 2nd edition

A unified, readable and theoretically sound summary of computer programming techniques for information structures. Discusses representation of information inside the computer and structural interrelationships between data elements and how to deal with them efficiently. Also covers applications to simulation, numerical methods, software design and other factors.

92233S \$42.00 ea.

Volume II: Seminumerical Algorithms, 2nd edition

Readable, coherent and up-to-date summaries of the major paradigms and basic theory of seminumerical algorithms.

- Topics:
- Random Numbers: generation, statistical tests, other random quantities, and random sequence
 - Arithmetic: positional number systems, floating point arithmetic, multiple precision arithmetic, radix conversion, rational arithmetic, polynomial arithmetic, and manipulation of power series

92233T \$42.00 ea.

Volume III: Sorting and Searching

Though largely self-contained, this is a logical sequel to Volume I. It includes a comprehensive survey of computer techniques for sorting and searching and extends the treatment of data structures, considering both internal and external memories and both large and small databases.

92233U \$42.00 ea.

Managing a Programming Project P. Metzger/Prentice Hall 1981

Learn practical approaches to managing a typical, modern computer programming job of any size and complexity. Everything needed to successfully organize and manage a project is discussed as you are guided through a project from start to finish. Topics include the cycle, definition, design, programming, testing, acceptance, installation, and operation. Also, how to construct plans for: outlining, introduction, organization, testing, change control, documentation training, reviewing, installation and operation.

92233P \$42.00 ea.

Data base & spreadsheets



Data base & spreadsheets

Using 1-2-3, Special Edition Que Corporation 1987

This new Special Edition has more than 900 pages of up-to-date information and features, including comprehensive Command Reference and Troubleshooting sections, hands-on practice sessions, and information on Lotus HAL and other add-in/add-on programs.

92220F \$25.95 ea.

1-2-3 Macro Library, 2nd Edition David P. Ewing/Que Corporation 1987

This easy-to-use reference shows how to create more than 100 macros for 1-2-3 spreadsheet, data management and graphics applications. Learn to apply macros to your own worksheets, create sophisticated models controlled by 1-2-3 macros, and modify macros for your own needs.

92220H \$20.95 ea.

1-2-3 Tips, Tricks, and Traps, 2nd Edition Dick Andersen and Douglas Cobb/Que Corporation 1987

This quick reference offers valuable tips on using 1-2-3 for specific applications, while teaching you timesaving tricks and helping you avoid hazardous spreadsheet traps.

92220G \$20.95 ea.

1-2-3 for Scientists and Engineers William J. Orvis/Sybx 1987

Fast, elegant solutions to common problems in science and engineering, using Lotus 1-2-3. It offers information on tables and plotting, curve fitting, statistics, derivatives, integrals and differentials, solving systems of equations and more.

92220J \$25.95 ea.

dBASE III PLUS Programmer's Reference Guide Alan Simpson/Sybx 1987

Programmers will save untold hours and effort using this comprehensive, well-organized dBASE encyclopedia. Complete technical details on commands and functions, plus scores of often-needed algorithms.

92220P \$25.95 ea.

Understanding dBASE III PLUS Alan Simpson/Sybx 1987

A solid sourcebook of training and on-going support. Everything from creating a first database to command file programming is presented in working examples, with tips and techniques you won't find anywhere else.

92220Q \$20.95 ea.

An Introduction to Database Systems—Vol. 1, 4th edition C. Date/Addison-Wesley 1986

A best seller in the field of relational, hierarchical and network databases. This comprehensive "basic" course is intended as an advanced text or professional reference book. Reasonable knowledge of a modern computer system's capabilities and file-handling features is assumed.

92233W \$38.95 ea.

An Introduction to Database Systems—Vol. II C. Date/Addison-Wesley 1982

Volume II ties together eight loosely related database topics omitted from Volume I. Included are the following system aspects: recovery, integrity, concurrency and security. Also covered are data models, RMI, distributed databases and database machines. The reader is expected to have a general knowledge of database system structures, concepts and objectives. Familiarity with the major aspects of the relational model discussed in depth in Volume I is also expected.

92233K \$32.95 ea.

Guide to Using Lotus 1-2-3™ Edward Baras/Osborne/McGraw-Hill 1984

Harness the vast capabilities of the Lotus 1-2-3™ software package with this fast-moving tutorial, featuring instructions for both beginning and experienced users. You'll learn how to implement practical application models that take full advantage of Lotus 1-2-3™'s integration of spreadsheet, data base, and graphics functions. Financial forecasting, consolidating business statements, simulating dynamic processes and many more topics are included.

92234N \$19.95 ea.

"HP DIRECT reps are really helpful"

"I call in for all types of products, requisitioned from employees all over my company. HP DIRECT reps are really helpful—even when I don't have complete ordering information, or product numbers."

Becky Reesor
State Farm Insurance
Bloomington, Illinois

"I'm more than happy with the turn-around"

"I've been ordering from HP DIRECT for years now, and I'm more than happy with the turn-around and service. In fact, we once ran out of a ribbon we needed to print payroll vouchers. My HP DIRECT rep jumped through hoops to get me one the next day."

Terry Reffner
General Electric
Erie, Pennsylvania

Word processing



Word processing

Mastering WordPerfect Susan Baake Kelly/
Sybex 1987

Step-by-step training from startup to mastery featuring practical uses (form letters, newsletters and more), plus advanced topics such as macro creation, sorting and columnar math. Includes Version 4.2

92220V \$20.95 ea.

WordPerfect Desktop Companion Greg Harvey and Kay Yarborough Nelson/
Sybex 1987

This compact encyclopedia for Version 4.2 offers detailed, cross-referenced entries on every software feature, organized for fast, convenient on-the-job help. Includes self-contained enrichment material with tips, techniques and macros. Special information is included about laser printing using WordPerfect that is not available elsewhere.

92220S \$23.95 ea.

WordPerfect Tips, Tricks, and Traps, 2nd edition Charles O. Stewart III and Daniel J. Rosenbaum/Que Corporation 1988

This book offers hundreds of practical tips that help you avoid problems when designing, creating, editing, formatting and printing a variety of documents. Based on WordPerfect Version 4.2, this quick reference covers tips for using the WordPerfect Library, creating and using macros, importing data from other programs and more.

92220T *new!* \$20.95 ea.

PCs & peripherals



PCs & Peripherals

Managing Your Hard Disk, 2nd edition Don Berliner/Que Corporation 1988

This book introduces innovative techniques to bring your hard disk to peak performance, such as storing and retrieving "libraries" of information, proper backup procedures, ways to activate menu programs, and strategies for using programs that won't normally run on hard disk.

92220N *new!* \$19.95 ea.

The HP 110 Portable: Power to Go! D. Flanagan/Que Corp. 1985

Designed to be an introduction for the novice, this book gives a review of hardware and software features of The PORTABLE. Screen replicas and diagrams help the user operate. The PORTABLE's built-in programs: Lotus 1-2-3, MemoMaker, the terminal program, and the Personal Applications Manager (P.A.M.), Data communication between The PORTABLE and larger PCs such as the Touchscreen (HP 150 Personal Computer) is also discussed. Most topics apply to The Portable PLUS as well as The PORTABLE.

92235N \$17.95 ea.

Unlocking the LaserJet Howard and Janelle Gluckman/WizzyWags Publishing 1988

This book makes easy work of the most difficult spreadsheet. You produce informational business graphics from Lotus® 1-2-3® or Symphony®...even add logos, shadow boxes and vary typestyles within them! ☺

92176E *new!* \$19.95 ea.

Looking Good in Print: A Guide to Basic Design for Desktop Publishing Roger Parker/
Ventana Press 1988

Here's a book that offers everything the title implies, and more! It shows you how to integrate type, graphics and photos through your desktop publishing applications, to produce truly eye-catching newsletters, reports and other documents. ☺

92220W *new!* \$23.95 ea.

LaserJet Unlimited, 2nd edition Ted Nace and Michael Gardner/Peachpit Press 1988

This updated edition offers concise, authoritative information and hands-on advice to most every aspect of laser printing, with special emphasis on the HP LaserJet Series II Printer. It discusses all applications, as well as Printer Command Language and setup utilities. ☺

92235U *new!* \$25.00 ea.

We ship same day

CALL HP DIRECT
800-538-8787

Call us with your Purchase Orders or



HP PC Communicator—reference guide for HP PC users



HP PC Communicator is Hewlett-Packard's support magazine for HP 150/Touchscreen, HP Vectra, HP Portable/Portable PLUS Personal Computers, and HP 12x users. The magazine contains articles on major hardware and software products, answers to frequently asked questions, programming techniques, software updates, corrections to manuals, and notes on using applications. The Current Information Section gives up-to-date information on user groups, training courses, software support, and software updates. The Master Index contains a listing of all major articles from previous issues.

Individual copies: Present and past issues are available individually by calling HP DIRECT 800-538-8787. Consult an issue of the *HP PC Communicator* for part numbers.

Subscriptions: Effective November 1, 1988, a one year subscription of six issues can be ordered by any of the following methods:

- call (415) 372-6002 in the U.S.
- write to HP PC Communicator, P.O. Box 2678, Martinez, CA 94553
- mail in the Mail Order Form found at the back of the Communicator

One year subscription	
U.S.	\$36.00 U.S.
Canada or Mexico	49.00 U.S.
Outside North America	59.00 U.S.

Subscriptions are not available through your HP sales office.

HP computer users groups—your worldwide connection*

Interex, the International Association of Hewlett-Packard Computer Users

Dedicated to helping HP computer users get the most from their systems, Interex keeps you in touch with other HP computer users through publications, conferences, a library of current programs, and up-to-date information about the HP computing world. Interex is a professional association offering a comprehensive range of services and activities. Serving over 9000 users in over 40 countries around the world, Interex is proud of its global representation.

HP 3000 User Support Services at \$500 offer an annual release of the Contributed Software Library; *Interact*, the industry's leading publication for the HP 3000 community; *Interrupt*, the monthly newsletter; voting privileges; software discounts, training seminars, documentation, and more!

HP 1000 Full Users Support Services at \$500 each offer a Contributed Software Library start-up tape and annual release; *TC Interface* magazine for technical computer users; *Interrupt*, the association newsletter; group support; voting privileges; discounts and special services.

Standard Users Support Services, available for HP personal computer users at \$70, include *Interact* magazine, *Interrupt* newsletter, one free diskette from the Personal Computer Contributed Software Library, and discounts on other Interex activities and services. All payments should be in U.S. funds.

HP 9000 users are now offered a choice of two User Support Services. For more information please call or write for a FREE information packet: Interex, 680 Almanor Ave, Sunnyvale, CA 94086, USA, (408) 738-4848.

Trade publications—your window into the world of HP computers*

The HP Chronicle: Each issue provides the latest information and product announcements of HP products for the HP 3000, Touchscreen (HP 150), 110, Series 100, 250 or HP Vectra systems. Reader Service, a quarterly software directory, and handy retail information are also included. Yearly subscriptions are \$38 in the U.S. and \$72 elsewhere.** Call or write: *THE HP CHRONICLE*, Wilson Publications, Inc., 12416 Hymeadow Drive, Austin Texas 78750, (512) 250-9023.

HP Design & Automation: The independent monthly journal for HP 1000, 9000 Series 200/300/500, Series 80 and Vectra technical computer users. Each issue presents helpful programming tips, scientific and engineering applications, software/hardware review, hard-driving news, and new product updates. The writers strive to answer your questions, and columnists lead you deep into the recesses of various operating systems. Yearly subscriptions are \$42 in the U.S. and \$78 elsewhere.** Call or write: *HP Design & Automation*, 12416 Hymeadow Drive, Austin Texas 78750, (512) 250-9023.

SUPERGROUP ASSOCIATION functions as an open forum for all Hewlett-Packard computer users to share knowledge, news, opinions and information on products and services. SuperGroup Magazine, the Association's monthly publication, reaches over 25,000 HP computer users every issue. Other benefits include Instant Update, an on-line news and bulletin board service, discounts on SuperGroup Users Conference registration, selected discounts on advertising and SuperGroup Solution privileges, a problem-solving hotline for SuperGroup

members only. Yearly membership is \$48.** Call or write: *SuperGroup Association*, 348 E. South Temple, Salt Lake City, UT 84111-9959, (800) 356-3434.

HP PROFESSIONAL is dedicated to providing coverage of Hewlett-Packard's universe of computing and automation technology, systems, products, and applications. Articles are directed to technical and non-technical professional users and managers of business systems. Editorials include new product announcements, hardware and software reviews, programming and system management tutorials and tips, application stories, business news and industry analysis. Audited by the Business Publications Audit of Circulation, Inc. (BPA). Yearly subscriptions are \$38 in the U.S. and Canada; \$60 elsewhere.** Write: *HP PROFESSIONAL*, P.O. Box 445, Spring House, PA 19477, (215) 542-7008.

The Portable Paper is the only publication exclusively for users of HP Portable computers (HP 110, Portable Plus and Portable Vectra). For the beginner as well as the expert, each bimonthly issue contains over 40 pages of powerful knowledge on how to get the most out of your HP Portable. The Portable Paper gives you step by step tutorials and tips from HP Portable experts, a question and answer forum, correspondence from all over the world, and in-depth reviews of the latest products that will run on HP Portables. A must for any HP Portable user. Published since 1986 with back issues available at a discount. Subscriptions are \$55 for one year, \$99 for two in the U.S., \$61/\$105 in Canada, and \$73/\$117 elsewhere.** Call or write: *Personalized Software*, P.O. Box 869, Fairfield, IA 52556, (515) 472-6330.

** All payments should be made in U.S. funds.

*The independent organizations and publications listed here are offered as a service to our readers. Space limitations make it necessary to list only those organizations that are international in scope.

Learning COBOL II/3000

This is an entry-level course to teach beginning programmers or programmers who have experience with other languages to write COBOL II programs interactively on the HP 3000 Computer. It has no formal prerequisites but familiarity with basic computer concepts is desirable.

Course Content:

- Simple COBOL programming
- Program variations
- The structure and syntax of COBOL
- Simple arithmetic statements, comments, diagnostics
- Advanced arithmetic and control statements
- Additional data concepts
- All about files
- Applied interactive COBOL

22832A Learning COBOL II/3000. Course materials include: Set of nine audio cassettes (playable on any standard cassette player) with storage binder, one student workbook, one "COBOL II/3000 Reference Manual" and one "Using the HP 3000 Manual." Course completion time is approximately 25 hours.

Price \$475.00 ea.

22832-93001 Learning COBOL II/3000 Student Workbook. Extra workbook for course.

Price \$200.00 ea.



Using Dictionary/3000



This self-paced course is an introduction to Dictionary/3000, HP's data dictionary facility. It does not teach database design but leads you through the steps of defining entries in the data dictionary and of creating and maintaining IMAGE/3000 databases. This course is designed for the non-technical user and is intended for a database administrator or for a programmer acting as a database administrator. Prerequisites for this course are the course "HP 3000, A Guided Tour" (See 22835B) or general knowledge of the HP 3000 gained through experience. Knowledge of IMAGE/3000 is helpful but not necessary for those who will not be designing new databases. Course content:

- Presenting Dictionary/3000
- IMAGE data structures

- Interactive data basics
- Commanding your files
- File security
- Dictionary/3000 utilities

There are system prerequisites for the course. Hardware needed: HP 3000, character or block mode terminal. Software needed: MPE III, IV, or V, IMAGE/3000 and Dictionary/3000.

22843B Using Dictionary/3000. Course materials include a 1600 BPI tape (for data cartridge format, specify option 022), one set of self-paced booklets containing reading material, practice exercises, answers to exercises, and one copy of "Dictionary/3000 Reference Manual." Complete instructions are included for the system manager to install the course on your 3000. Course completion time is approximately 12 hours.

Price \$500.00 ea.

Specify Opt. 022 for data cartridge format.

22843-60001 Self-Paced Booklets. Extra set of booklets for Using Dictionary/3000.

Price \$115.00 set

HP 3000: A Guided Tour



22835B HP 3000 Guided Tour Kit

"A Guided Tour" is a self-paced learning course that acquaints you with the range of information handling tools that are directly available on your HP 3000. It is designed for all non-programmers, administrative, clerical, professional people who want to know about and use the HP 3000 Computer System.

Course Content:

- General concepts—Operating the terminal, logging on and off, executing a program
- Issuing commands—Commonly used commands discussed, HELP facility and user commands
- File system—Files on the HP 3000; what they are, how they are used and how to access them
- Account structure—Discussion of security/user structure
- Entering data—Application program used to explain data entry functions
- Databases—Discussion of how data is stored after entry and how QUERY can be used to access the data

- Entering text—A brief lesson in EDIT/3000. Introduces you to the idea of using the computer for such common tasks as report generation

There are system prerequisites for the course.

Hardware needed: HP 3000, HP terminal which supports V/3000 (block mode). Software needed: MPE data coded 2011 or later, Editor, IMAGE/3000, QUERY/3000 and V/3000.

22835B HP 3000: A Guided Tour. Course materials include a 1600 BPI magnetic tape (for data cartridge format, specify option 022), three sets of self-paced booklets (one terminal per user is required), and complete instructions for the systems manager to install the course on your HP 3000. Course time is approximately seven hours.

Price \$375.00 ea.

Specify Opt. 022 for data cartridge format.

22835-60001 Self-Paced Booklets. Extra set of booklets for "A Guided Tour."

Price \$41.00 set

Programming in Transact/3000

This self-paced course is for experienced programmers. It introduces the HP Transact/3000 programming language. You learn at your own pace effective programming techniques through exercises and numerous examples. The course assumes a knowledge of the HP 3000, plus a knowledge of IMAGE/3000 databases and of VPLUS/3000 forms (FORMSPEC) for the last two content modules.

Course Content:

- Getting started—An introduction to Transact/3000
- Using data items
- Rounding out Transact
- Data management overview
- Using IMAGE with Transact
- Using VPLUS with Transact

There are system prerequisites for this course. Hardware: HP 3000, character or block mode terminal for content modules 1 through 5 and a

terminal that supports VPLUS/3000 for content module 5. Software: MPE III, IV, or V, Transact/3000, IMAGE 3000 and VPLUS/3000.

22842A Programming in Transact/3000. Course materials include a 1600 BPI tape (for data cartridge format, specify option 022), one set of self-paced booklets containing reading material, practice exercises, answers to the exercises, and one copy of the "Transact/3000 Reference Manual." Complete instructions are included for the system manager to install the course on your HP 3000. Course completion time is approximately 32 hours.

Price \$750.00 ea.

Specify Option 022 for data cartridge format.

22842-60001 Self-Paced Booklets. Extra set of booklets for programming in Transact/3000.

Price \$77.50 set

Other courses

22833B Using HP Decision Support Graphics/3000. Includes Reference Manual, Quick Reference Guide, and two self-paced course booklets.

Price \$490.00 set

22846B Using HPDRAW. Includes Reference Manual and two self-paced course booklets.

Price \$420.00 set

32120-90020 Learning HPWORD Part 1.

Price \$60.00 ea.

32120-90021 Learning HPWORD Part 2.

Price \$60.00 ea.

HP Documentation Index—free!

Find the answers to your documentation inquiries and questions with the HP DIRECT Documentation Index. The index provides quick reference to over 10,000 computer and instrument manuals. Computer manuals can be found using either an equipment reference or product number approach. Instrument manuals are listed in product number order.

Listings for each manual include product number, title, print date, and latest update (if any). The U.S. edition lists U.S. prices current at the index publication date.

How to find a computer and peripheral manual

- If the manual product number is not known, the first and third sections list manuals by computer and peripheral product.
- The fourth section lists all manuals in numerical order (by product number) for quick referencing.

How to find an instrument manual

- Instrument manuals are listed by product number only. If you don't know your

manual number, check with your local sales office.

Or, add a 0 to the instrument model number and check the Documentation Index for a possible product number fitting this pattern: 0XXXX-900XX.

Ordering the Documentation Index

Call your local sales office and ask for the Documentation Index. The publication number is **5953-2460D** in the U.S. and 5953-2460 outside of the U.S.



Popular reference manuals

For your convenience, a listing of the most frequently ordered Hewlett-Packard computer reference manuals appears below.

If you have technical questions concerning computer reference manuals in general, please contact your local HP sales office. For a listing of these offices, refer to sales region index in the back of the catalog.

Computer peripheral reference manuals

Tape drives

7970 Series Operating Manual	07970-90885
7970B/E Service Manual	07970-90887

Disc drives

5 1/4" Winchester Disc Drive Service Manual	09134-90032
Using Your 9153A/9154A Disc Drive	09153-90000

Printers

2225A ThinkJet Owner's Manual	02225-90031
2225B ThinkJet Owner's Manual	02225-90032
2225C ThinkJet Owner's Manual	02225-90033
2225D ThinkJet Owner's Manual	02225-90034
2225 Series ThinkJet Service Manual	02225-90079
PaintJet Color Graphics Printer User's Guide	03630-90001
PaintJet Color Graphics Hardware Support Manual	03630-90001
LaserJet Family Technical Reference Manual	02686-90912

LaserJet Service Manual	02686-90920
2930 Series Owner's Manual	02932-90001
LaserJet Series II User's Manual	33440-90901
LaserJet Series II Service Manual	33440-90904
LaserJet Series II Technical Reference Manual	33440-90905
Getting Started with LaserJet Series II	33440-90908
LaserJet 2000 Operator's Manual	02684-90901
LaserJet 2000 Service Manual	02684-90903
LaserJet 2000 Technical Reference Manual	02684-90904
LaserJet 500+ Operator Reference Manual	02686-90911

Plotters

ColorPro Graphics Plotter Programming Manual	07440-90001
ColorPro Graphics Plotter Operating Manual	07440-90002
7475A Graphics Plotter Interfacing & Programming Manual	07475-90001

7550A Graphics Plotter Interfacing and Programming Manual	07550-90001
7595A/7596A Drafting Plotters Hardware Support Manual	07595-90000
DraftMaster Reference Manual	07595-90001
HP DraftMaster Plotter User's Guide	07595-90002
HP DraftMaster Plotter Pocket Guide	07595-90003

Terminals

Manual kit for 2392A/2394A	5957-9969
2392A/2394A Service Manual	02394-90003
2621 Interactive Terminal Owner's Manual	02620-90062
HP 700/92, HP 700/94 User Manual	5957-9971
HP 700/92, HP 700/94 Reference Manual	5957-9982
HP 700/41 User's Manual	5957-9984
HP 700/41 Reference Manual	5957-9990
Model 700 Series Service Manual	5957-9991

Personal/desktop computer reference manuals

Series 100

HP 150/MS-DOS User's Guide	45624A
MS-DOS User's Guide for HP 150 (Touchscreen PC)	45849-60202
HP 150 Technical Reference Manual	45625A

HP 150 Internal Modem User's Manual	45640-90002
Setting Up Vectra Manual	45934-90001
Connecting Peripherals to Vectra Manual	45934-90002
Vectra Service Manual	45935-90002

HP 260 reference manuals

Operating/Managing your HP 260	45261-90001
HP 260 Syntax Reference Manual	45621-90063

HP 1000 reference manuals

Operating system

Getting Acquainted with RTE-IVB Manual	92068-90001
RTE-IVB Terminal User's Manual	92068-90002
RTE-IVB Quick Reference Guide	92068-90003
RTE-IVB Programming Reference Manual	92068-90004
RTE-IVB Batch & Spool Reference Manual	92068-90005
RTE-IVB Systems Manager Manual	92068-90006
RTE-IVB On-Line Generator Manual	92068-90007
RTE-IVB Utility Program Reference Manual	92068-90010
RTE-A User's Manual	92077-90002
RTE-A Quick Reference Guide	92077-90020

RTE-6/VM Quick Reference Guide	92084-90003
RTE-6/VM Terminal User's Reference Manual	92084-90004
RTE-6/VM Programming Reference Manual	92084-90005

Subsystem/applications

OS/1000-IV User's Manual	91750-90002
IMAGE/1000 Reference Manual	92069-90001
IMAGE/1000 Database Management Manual	92069-90005
EDIT/1000 User's Guide	92074-90001

Language

RTE FORTRAN IV Reference Manual	92060-90023
PASCAL/1000 Reference Manual	92832-90001

Programming in PASCAL	97082-90002
RTE FORTRAN 4X Reference Manual	92834-90001
FORTRAN 77 RTE-6/VM and RTE-A Reference Manual	92836-90001

General information

Site Preparation & Planning Workbook	02170-90016
Data Systems Customer Support Handbook (2114/15/16, 2100, 21MX-M & E Series)	5950-3767
HP 1000 M/E/F Technical Reference Handbook	5955-0282
HPWORD IV Reference Guide—Part 1	32120-90030
HPWORD IV Reference Guide—Part 2	32120-90031
LAN Link Hardware Troubleshooting Manual	5955-7681

HP 3000 reference manuals

Operating system

MPE Commands Reference Manual	30000-90009
MPE Intrinsic Reference Manual	30000-90010
MPE Segmenter Reference Manual	30000-90011
MPE IV System Manager Reference Manual	30000-90014
MPE IV System Utilities Reference Manual	30000-90044
Software Pocket Guide	30000-90049
Computer Systems Console Operator's Guide	32002-90004
MPE V Systems Operating and Resource Management Reference Manual	32033-90005
MPE V Commands Manual	32033-90006
MPE V Intrinsic Manual	32033-90007
MPE V Utilities Reference Manual	32033-90008
MPE V Guide for the New User (HP 3000 Guide for the New User)	32033-90009
MPE V Quick Reference Guide	32033-90023

Subsystem/utility

EDIT Reference Manual	03000-90012
FCOPY Reference Manual	03000-90064
QUERY Reference Manual	30000-90042

KSAM Reference Manual	30000-90079
V/3000 Reference Manual	32209-90001
IMAGE/3000 Reference Manual	32215-90003
TURBO IMAGE Reference Manual	32215-90050

Languages

BASIC/3000 for Beginners	03000-90025
BASIC/3000 Pocket Guide	03000-90050
Using the HP 3000: An Introduction to Interactive Programming	03000-90121
SPL/3000 Reference Manual	30000-90024
SPL/3000 Textbook	30000-90025
BASIC/3000 Interpreter Manual	30000-90026
FORTRAN/3000 Reference Manual	30000-90040
Using COBOL: A Guide for New Users of HP 3000 Computer Systems	32213-90003
COBOL II/3000 Reference Manual	32233-90001

Data communications

Fundamental Data Communications Handbook	5957-4634
Data Communications Guide Book	5955-1715

Information systems

HP Draw Reference Manual	32108-90001
--------------------------	-------------

HP Easy Chart Reference Manual	32109-90001
HPWORD IV Quick Reference Guide	32120-90002
Getting Started with HPWORD V	32120-90032
HPWORD V Quick Reference Guide	32120-90033
Printing with HPWORD V Manual	32120-90034
Using HPWORD V Manual	32120-90035
Deluxe VISICALC 3000 Manual	32133-90010
DICTIONARY/3000 Reference Manual	32244-90001
REPORT/3000 User's Guide	32245-90001
INFORM/3000 User's Guide	32246-90001
TRANSACT/3000 Reference Manual	32247-90001
DSG/3000 Manual	32250-90001
HPDESKMANAGER Administration Manual	36570-90004
Using HPDESKMANAGER III Manual	36570-90038
Using HPPLATE Manual	36576-90030
TDP/3000 Quick Reference Guide	36578-90003
TDP/3000 Reference Manual	36578-90004

General information

3000 Series 64 Site Preparation Set	30140-60085
LAN Link Hardware Troubleshooting Manual	5955-7681

HP 9000 reference manuals

Series 200/300

BASIC 2.0 Programming Techniques Manual (with BASIC 2.1 Extension)	98612-90011
BASIC 2.0 Language Reference Manual (with BASIC 2.2 Extension)	98612-90056
BASIC 4.0 Manual Kit	98613-87904
BASIC 4.0 Condensed Reference Manual	98613-90061

HPL 2.1 Condensed Reference Manual	98614-90020
HP-UX Manual Kit	98680-87901
PASCAL 3.1 Manual Kit	98615-87903

Series 500

BASIC Manual Package	97050-80020
BASIC Programming Techniques Manual	97050-90000

BASIC Graphics Programming Techniques Manual	97052-90000
IMAGE Database Programming Techniques Manual	97053-90000
HP-UX Reference Manual	09000-90008
Local Area Network User's Guide	97059-90000
Preparing for Your HP9000	09000-90041

We ship same day

**CALL HP DIRECT
800-538-8787**

Call us with your Purchase Orders or



Protect and organize your documentation in durable HP binders



HP binders come in an array of colors and styles to fit unique system documentation as well as standard size pages.

If you've been looking for convenient storage for your HP documentation, look no more! We offer binders in an assortment of sizes, designed to fit your HP documentation needs as well as sales literature, manuals and instruction books. Strongly constructed with reinforced vinyl covers and metal rings, these binders are made to last. All binders are snap open three-ring design with open/close boosters.



new! Blue binders, shown at left, hold HP Precision Architecture documentation. For 8.5 x 11-inch (216 x 279 mm) paper:
9282-1085 1.5-inch \$23.00 ea.*
9282-1086 2-inch 24.00 ea.*
 For 7 x 8.5-inch (178 x 216 mm) paper:
9282-1087 1.5-inch \$21.00 ea.*



new! Gray binders, shown at left, hold HP 9000 System documentation. For 8.5 x 11-inch (216 x 279 mm) paper:
9282-1077 1-inch \$12.00 ea.*
9282-1078 1.5-inch 16.00 ea.*
9282-1079 2-inch 16.00 ea.*
9282-1080 3-inch 16.00 ea.*
 For 7 x 8.5-inch (178 x 216 mm) paper:
9282-1081 1-inch \$12.00 ea.*
9282-1082 1.5-inch 12.00 ea.*
9282-1083 2-inch 12.00 ea.*

Blue binders with HP logo, shown above, hold 8.5 x 11-inch (216 x 279 mm) paper:
9940-4192 1-inch \$8.00 ea.*
9940-4196 1.5-inch 9.50 ea.*
9940-4622 2-inch 12.00 ea.*

White binder, shown above, has clear plastic sleeve, holds HP 3000 System documentation. For 8.5 x 11-inch (216 x 279 mm) paper:
9282-0069 2-inch \$11.00 ea.*
9282-0520 2.5-inch 14.00 ea.*

*Quantity discounts available

Keep important reference manuals at your fingertips

HP Touchscreen/Integral PC documentation binder and slip cover—the ideal replacement for lost or damaged HP Touchscreen or Integral PC binders. Holds up to 1.25 inches of 7 x 8.5-inch (178 x 216 mm) three-ring documentation. ☑

5958-0210 Binder and slip cover \$15.00 ea.*



*Quantity discounts available.

Documentation storage rack

- Unique binder channels allow:
 - Easy loading
 - Quick additions, deletions and updates
 - Easy page turning
 - Viewing the entire page—even the margins
- Strong support wings let the pages lie open and flat
- Adjustable for user comfort—30 or 40 degrees for stand-up or sit-down comfort
- Holds up to 6 inches of standard three-hole-punched documentation (8.5 x 11 inches)
- Expandable—racks may be coupled to build larger storage systems

92171M Storage rack
 (1-2) \$60.00 ea.
 (3+) 56.00 ea.



Locking bar for documentation storage rack.

This metal security bar with lock set prevents unauthorized removal of your reference documents. For use with product number 92171M.

92171L Locking bar \$20.00 ea.

TERMINALS



HP terminals...rated #1 in Datapro Users' Surveys four years in a row! These terminals offer advanced features and conveniences to help you work more expediently and effectively. And perhaps best of all, the terminals you need are only a phone call away.

ASCII computer terminals	146
DEC computer terminals	147
IBM computer terminals..	147
HP computer terminals ...	148
Terminal accessories	149

High quality meets low price: Hewlett-Packard's new display terminals for ASCII, DEC, IBM and HP systems

Now you can get technologically advanced display terminals for your company's computer systems—and at wonderfully affordable prices!

These new-generation terminals have been designed, engineered and exhaustively tested for guaranteed durability and years of service.

Quality. Customers prefer HP display terminals. In fact, our terminals captured Datapro Users' Surveys top ratings *four years in a row.* And Hewlett-Packard has been voted number one in overall support satisfaction for the past *five years.***

Commitment. Our terminals come with a comprehensive one-year warranty, and we offer worldwide support as well. That's because you're not just buying terminals. You're buying HP's 40-year tradition of innovation, quality and service.

And available today. The terminals you need are as close as your phone! Our telemarketing professionals are ready to take your order, and HP DIRECT can ship your terminals the day you telephone.



Crisp, clean characters are displayed on 14-inch, glare resistant screens. Your eyes will see the difference! Choose ever-popular green, easy-viewing amber, or black characters on a softwhite background for best hardcopy-to-screen transition. And a handy programmable screen-saver function automatically dims your screen when you leave it unattended.



These terminals help you work easier. For example, you can pull up this configuration screen to change the way your keyboard functions. You'll handle more tasks with less effort and minimal rework.

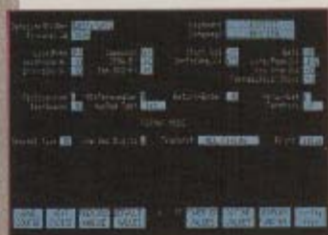

Tilt-and-swivel is standard on every terminal. From a straight vertical position, the screen can be tilted five degrees upward or 20 degrees downward, or swiveled 180 degrees around. Less light reflecting, neck craning and back bending!



Detached keyboards adjust to your best workspace and working angle. The keys themselves are ergonomically spaced and molded to fit the spread and tips of your fingers. The keys respond to your touch instantly. Your hands—and arms and back—will feel the difference!

**User ratings of Display Terminals and IVDTs: Datapro Report, 1983-86. **U.S. Datapro Survey Results, 1983-87.

Combine HP quality and ASCII compatibility.

Now you can get outstanding Hewlett-Packard functionality in an entry-level ASCII terminal—and at an incredible low price.

Accent on compatibility. HP 700/41 terminals feature nine terminal compatibility modes, so you can work with a wide variety of computer systems and software.

Because it's compatible with applications designed for a variety of systems, your options are wide open. It can work with Wyse WY-30, TeleVideo 905/910+/925E, ADDS Viewpoint A2, Lear Siegler ADM3A/ADM5, Qume QVT-101 or Hazeltine 1500 terminal applications, with no additional effort.

State-of-the-art ergonomics, naturally. This terminal features variable screen scrolling and split-screen capability, to let you work the way you work best. The HP 700/41 also offers:

- A detached, adjustable keyboard for your working comfort
- Tactile feedback for super-responsive keyboarding
- 14-inch glare-resistant green or amber screen
- Front-panel user controls

In addition, this terminal features 16 function keys, 58 programmable keys total, for user ease. Two RS-232C ports are standard. And to position the screen, tilt-and-swivel is built right in.

HP 700/41 Display Terminal

C1003A Opt. ABA Amber with U.S. keyboard

C1003G Opt. ABA Green with U.S. keyboard

(1 unit)	\$375.00 ea.
(2-9)	330.00 ea.
(10-19)	312.00 ea.
(20-49)	300.00 ea.
(50-99)	289.00 ea.



Use the full-page set-up screen to easily configure your terminal for a variety of computer systems.

Handle complex ASCII applications with ease.

You can depend on an HP 700/43 terminal to handle your complex ASCII applications—it's the perfect WY-50 alternative.

Enhanced capabilities. This terminal lets you select between 80- and 132-column modes, so you can view the widest applications in legibly-compressed type. No keying to the next screen, no scrolling back and forth—your data is there when you need it.

What's more, you get up to four pages of memory. That's more than enough for detailed word processing, data entry or technical applications, without drawing from your main computer system.

HP 700/43 terminal also features:

- Green, amber or softwhite phosphor displays
- Split-screen capability
- 58 programmable keys, including 16 function keys
- Two standard bi-directional RS-232C ports

Compatibility plus. HP 700/43 terminal lets you work with the systems you know best. How? By offering not nine but 12 terminal compatibility modes: Wyse WY-50, TeleVideo 950 and Lear Siegler ADM 31 system applications, as well as for Wyse WY-30, TeleVideo 905/910+/925E, ADDS Viewpoint A2, Lear Siegler ADM3A/ADM5, Qume QVT-101 or Hazeltine 1500.

HP 700/43 Display Terminal:

C1006A Opt. ABA Amber with U.S. keyboard

C1006G Opt. ABA Green with U.S. keyboard

C1006W Opt. ABA Softwhite with U.S. keyboard

(1 unit)	\$475.00 ea.
(2-9)	418.00 ea.
(10-19)	394.00 ea.
(20-49)	380.00 ea.
(50-99)	366.00 ea.



This terminal stores as many as four pages of memory. It also lets you view applications up to 132 columns wide.

Connect and protect your HP Terminal! For cables, see page 80; for dust covers, see page 120; and for keyboard parks, see page 118.

Get HP technology with DEC VT220 compatibility.

The HP 700/22 display terminal is the definitive choice for your ANSI applications, combining high-quality HP engineering with DEC VT220 terminal compatibility.

The HP 700/22 works with programs designed for DEC VT220 7- and 8-bit controls, as well as VT100 and VT52 terminals and applications that speak ANSI X3.64 protocol. An easy setup menu and DEC-style VT220 106-layout keyboard gets you up and running within minutes.

Unsurpassed functions mean your work just got easier. The HP 700/22 gives you:

- Four pages of memory—three more than you'd get with a DEC terminal!
- 80- and 132-column display modes, to let you view work conveniently
- 30 programmable function keys to cut repetition in VT220 mode
- An RS-232C and 20mA current loop interface for systems, plus a 9-pin RS-232C printer port

User engineered—in fact, every feature is designed for your maximum working comfort. The generous anti-glare screen affords exceptionally sharp character resolution. 50, 60 or 72Hz refresh rate further enhances readability. A responsive tactile keyboard (detached and adjustable) and tilt-and-swivel are standard, and all controls are conveniently located on the front panel.

HP 700/22 Display Terminal

C1004A Opt. ABA Amber with U.S. keyboard

C1004G Opt. ABA Green with U.S. keyboard

C1004W Opt. ABA Softwhite with U.S. keyboard

(1 unit)	\$499.00 ea.
(2-9)	439.00 ea.
(10-19)	415.00 ea.
(20-49)	399.00 ea.
(50-99)	385.00 ea.



Enjoy HP value and IBM 3191 compatibility.

The HP 700/71 is your best choice for applications that require IBM 3191 Models A and B emulation—and a great option when you're shopping for best price/performance.

Designed for the IBM user. These terminals are easily connected to IBM information Display Systems via coaxial cable. Their features are designed with the most demanding user in mind:

- a choice of four different detached, adjustable keyboards, ranging from the standard 122-key layout to the space-saving 102-key version (see page 149 for details)
- 24 function keys help you handle applications easier
- a non-volatile memory saves setup information in a snap

Ergonomics extraordinaire means this terminal was engineered for the human body. The HP 700/71 features crisp characters on a large, glare-resistant screen. User controls, including a security keylock, are located on the front panel for easy access. And tilt-and-swivel is standard.

- C1005A Opt. 500** amber with 122-key typewriter U.S. keyboard
- C1005A Opt. 501** amber with 102-key typewriter U.S. keyboard
- C1005A Opt. 502** amber with 122-key data-entry U.S. keyboard
- C1005A Opt. 503** amber with 122-key ASCII U.S. keyboard
- C1005G Opt. 500** green with 122-key typewriter U.S. keyboard
- C1005G Opt. 501** green with 102-key typewriter U.S. keyboard
- C1005G Opt. 502** green with 122-key data-entry U.S. keyboard
- C1005G Opt. 503** green with 122-key ASCII U.S. keyboard
- C1005W Opt. 500** softwhite with 122-key typewriter U.S. keyboard
- C1005W Opt. 501** softwhite with 102-key typewriter U.S. keyboard
- C1005W Opt. 502** softwhite with 122-key data-entry U.S. keyboard
- C1005W Opt. 503** softwhite with 122-key ASCII U.S. keyboard

HP 700/71 Display Terminal

(1 unit)	\$695.00 ea.
(2-9)	612.00 ea.
(10-19)	577.00 ea.
(20-49)	556.00 ea.
(50-99)	535.00 ea.



See page 149 for more details on HP 700/71 keyboards.

Designed by Hewlett-Packard engineers, expressly for your HP computer system

Handle your HP applications with ease

The HP 700/92 increases staff productivity *immediately*. Not only are these terminals totally compatible with HP business and technical applications, they have enhanced capabilities that take advantage of block mode communications in software packages like the popular VPLUS/3000.

New, sophisticated display. Our 14-inch screen is refreshingly easy to read and easy on the eye, with sharper display quality than any comparable terminal. Provided are eight pages of memory, with smooth or jump scrolling, plus selectable 80- and 132-column display modes.

Designed to fit your needs. User controls are located on the front panels. Two built-in RS-232C ports are on the back. And an adjustable tactile-feedback keyboard responds to your lightest touch. A number of other standard features help efficiency along, including:

- DEC VT52, VT100 and VT220 terminal compatibility
- Compatibility with the HP 2392A terminal
- Insert- or delete-character keys with automatic character wrap.

HP 700/92 Display Terminal \$895.00 ea.

C1001A Opt. ABA Amber with U.S. keyboard

C1001G Opt. ABA Green with U.S. keyboard

C1001W Opt. ABA Softwhite with U.S. keyboard

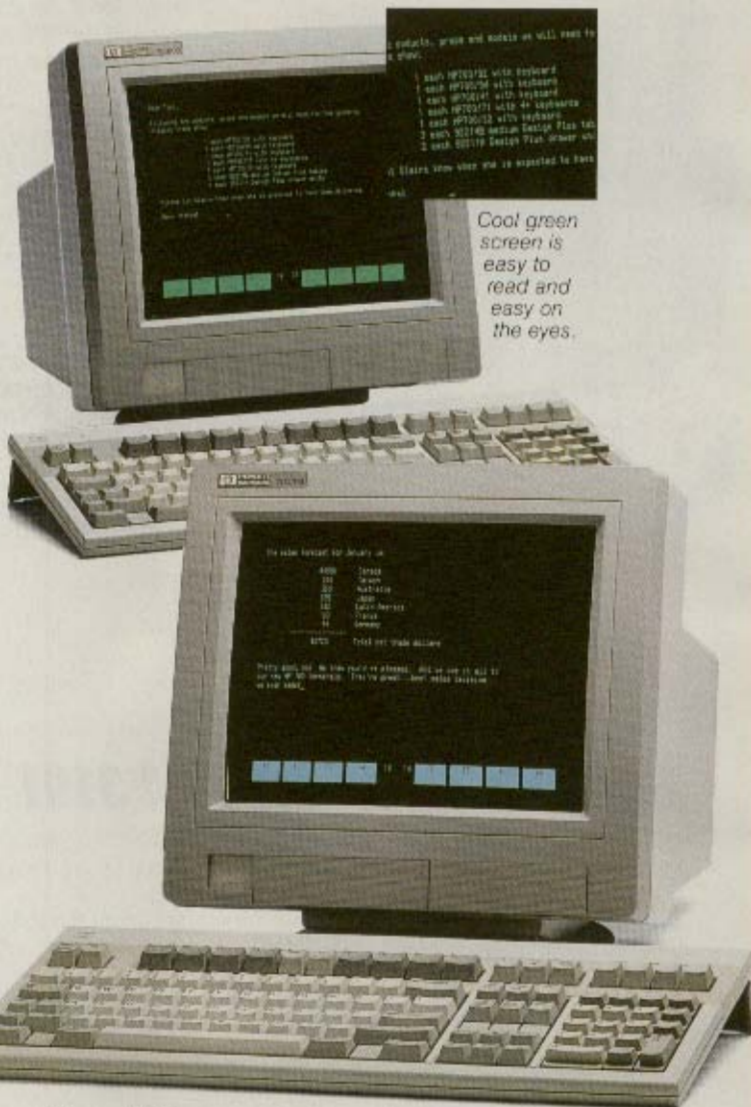

Cool green screen is easy to read and easy on the eyes.

Simplify repetitive data entry tasks

The HP 700/94 offers advanced capabilities to help you make the most of HP computer applications. It provides forms cache and local edit checks, optimized to work with VPLUS/3000 software.

Simplified data entry. The HP 700/94 lets you build files up to 130 blocks of 256K bytes each—an average of 25 forms locally—saving users the time and hassle of having to download from the host computer.

This terminal also reduces costly host communication traffic with local edit checks, modified data tag and up to 16 pages of memory. And you can download up to 94 user defined characters from the host computer.

Other features? Look for:

- Two RS-232C ports are standard

- 80- and 132-column display modes—view it your way!
- HP 2394A compatibility
- VT52, VT100 and VT220 compatibility modes
- Automatic character wrap keys to insert or delete characters.

Top-of-the-line ergonomics. The HP 700/94 terminal has user controls, as well as a detached, adjustable keyboard with responsive tactile feedback, and tilt-and-swivel.

It also has a 14-inch, anti-glare screen with up to 72Hz refresh rate for improved screen readability—especially important when viewing black characters on a softwhite screen.

HP 700/94 Display Terminal \$1095.00 ea.

C1002A Opt. ABA Amber with U.S. keyboard

C1002G Opt. ABA Green with U.S. keyboard

C1002W Opt. ABA Softwhite with U.S. keyboard

HP 700 Series Terminals Quick Selection Guide

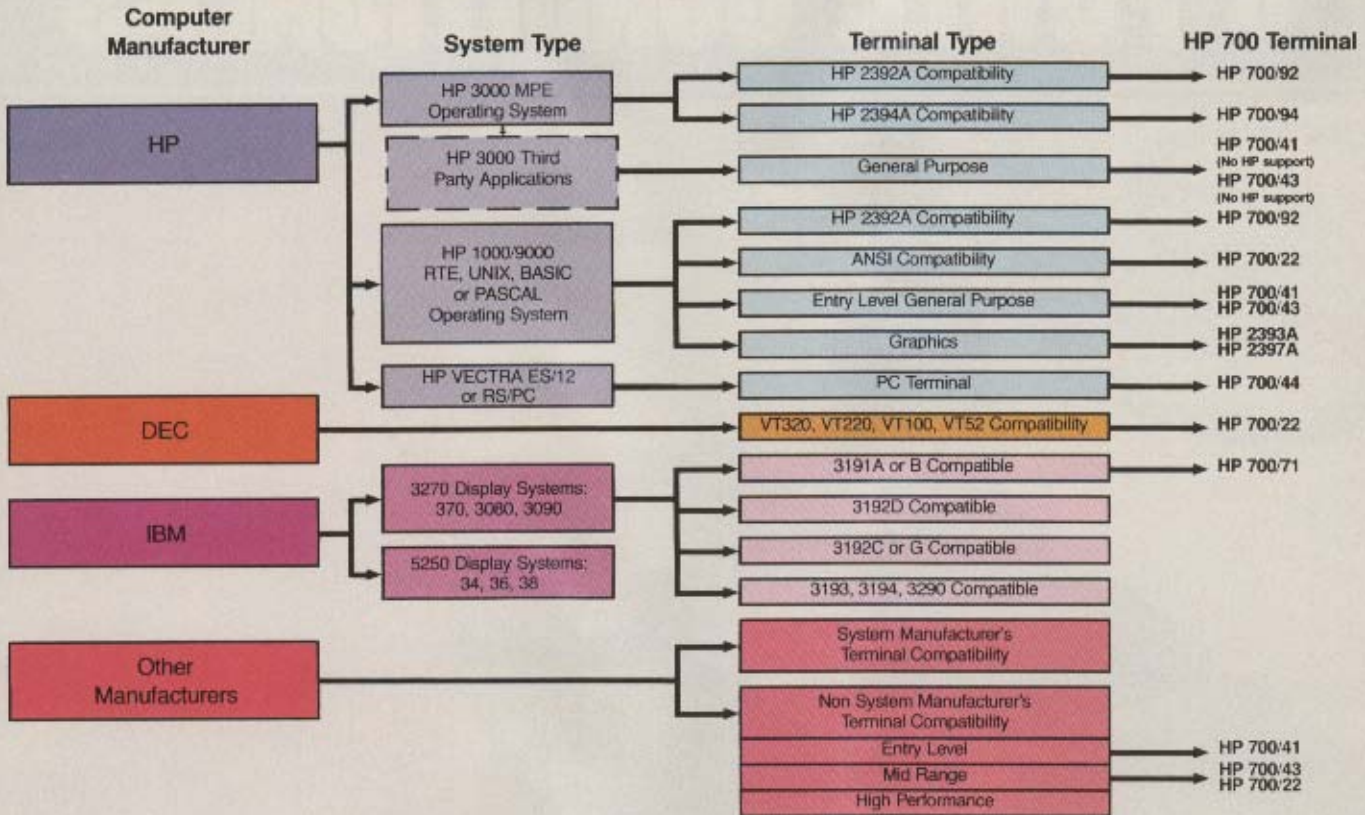

Select the right keyboard for your HP 700/71 Terminal

The HP 700/71 offers four keyboard layouts to meet your specific needs.

Opt. 500 Our most popular keyboard with a 122-key typewriter layout. It is compatible with older IBM terminals.



Opt. 502 For high volume data entry, this 122-key typewriter layout is appropriate. The keyboard has numeric keys embedded in the typewriter keypad just like old key punch machines.



Opt. 501 A more compact keyboard with a 102-key typewriter layout similar to an IBM PC keyboard.



Opt. 503 Use this 122-key ASCII layout when ASCII applications are used. This keyboard has a 122-key typewriter layout with ASCII characters included.



Connect and protect your HP Terminal! For cables, see page 80; for dust covers, see page 120; and for keyboard parks, see page 118.

DATA COMMUNICATIONS & POWER CONDITIONERS



HP power line conditioners...engineered specifically to match the power requirements of Hewlett-Packard computer systems. To provide protection against power problems that can create computer problems, select from the surge suppressors/isolation regulators in this section.

Test devices	151
Modems	152
Peripheral enhancers	154
Power line conditioners ..	155
Multiple outlet power strips	159
Back-up Power Supply ...	160

Eliminate the guesswork in RS232 testing!



"The Datatracker has cut my interfacing time from hours to minutes. Before I purchased the Datatracker, I would quiver in my boots when a customer came up with an RS232 interfacing problem. Breakout boxes could not monitor all lines available, and LEDs could neither distinguish high and low voltages accurately, nor make multiple ties to a single lead. Troubleshooting was an impossible chore! The Datatracker, however, gives me red and green lights on all 25 leads on each side, and its 1/4-inch turret pins let me clip on as many leads as I will ever need. Using this fine tool has helped me to discern whether serial transmission problems lie in the interface or in the equipment. The instruction manual is also very helpful in covering all aspects of RS232 communications. Its interfacing and troubleshooting guides are a virtual guarantee that no data interface problem will ever beat me again."

Michael R. Eisen

Mike Eisen, President
 Beacon Systems
 Palm Springs, California

Datatracker quickly troubleshoots datacom problems!

Datatracker is both a breakout box and a cable tester. It monitors high, low, off, and clocking signals on all 50 lines of a cable interface. The complete interface is shown on all the lines, which means no patching is necessary, and cable configuration can be tested in a matter of seconds.

Included are a padded carrying case,

interfacing guide and an easy to use 55 page instruction manual which guides both beginning and advanced users step by step through the process of cable testing.

92204N Datatracker
 (1-2 units) \$239.95 ea.
 (5+ units) 219.95 ea.

92204U Additional mini clip leads
 (1 pkg. of 4) \$19.95 ea.

Universal cable for Datatracker

Extension cable has both male and female 25-pin connectors on each end.

92204S Universal cable (4-ft. or 1.2 m) \$49.95 ea.

Pulse Tracker detects activity on two lines at one time

The Pulse Tracker is a pocket-sized, in-line device that detects pulse or data activity on any two signal lines simultaneously. It requires no batteries and can be used independently or in conjunction with the Datatracker. Instruction manual included.



92204T Pulse Tracker
 (1-4 units) \$49.95 ea.
 (5+ units) 46.95 ea.

Cable Test Adapter great for single-ended cable testing!

The Cable Test Adapter is an optional accessory used for single-ended cable testing. To determine open circuits, short circuits, or single-sided connections, simply connect one end of the suspect cable to the DataTracker and the other end to the Cable Test Adapter. Reverse the procedure to test both sides. Package includes male and female DB-25 connectors.

92204P Cable Test Adapter
 (1-4 units) \$29.95 ea.
 (5+ units) 27.95 ea.

Micropatch makes your custom interfacing a snap!

The Micropatch is an RS232 adapter that can be used to make a custom interface in just minutes without stripping, cutting, crimping or soldering, and without custom cables. It's designed with pins 1 and 7 wired straight through. All other pins allow plug-in patching. For a temporary fix or permanent connection, reusable patch wires can be inserted through a thin, self-healing silicone rubber. Plastic hood seals the wiring. Hardware is included for secure installation.

92204J Micropatch (male to male)
92204K Micropatch (male to female)
92204L Micropatch (female to female)
 (1-4 units) \$29.95 ea.
 (5+ units) 27.95 ea.



Minitracker/Minitracker Plus detects communication between two devices

If you simply need to determine whether or not two devices are communicating, either the Minitracker or the Minitracker Plus can get the job done. The Minitracker monitors the eight most commonly used RS232 (V.24) lines (2, 3, 4, 5, 6, 8, 11, 20). The Minitracker Plus monitors all 24 lines (1-6, 8-25) simultaneously with line 7 functioning as the signal ground. A red LED on indicates a high voltage (+3V to +25V) while a green LED on indicates a low voltage. Both LEDs flashing indicates data is transmitting. Both monitors are pocket-sized and require no batteries. Instructions included.

92204Q Minitracker
 (1-4 units) \$29.95 ea.
 (5+ units) 27.95 ea.
92204R Minitracker Plus
 (1-4 units) \$49.95 ea.
 (5+ units) 46.95 ea.

See page 72 for shielded RS232C gender converters.

Transfer data quickly with easy-to-use Hayes Smartmodems™

Hayes Smartmodem 2400™ will allow you to reduce the time and cost of your data transmissions while communicating with more capability. It's twice as fast as the Smartmodem 1200 and makes micro, mini and mainframe computer communications possible.

Great flexibility With this versatile modem, you can download from the mainframe at the office in synchronous mode. And you can send data to the mini at another location or connect with any of the information services in asynchronous mode.

More speeds, more compatibility Capable of operating at several speeds, the Smartmodem 2400™ can transmit at 2400 bps for economical high-volume communications. It also can automatically adjust to 300, 600, 1200 and 2400 bps to accommodate modems with varying speeds.

Features

- Synchronous and asynchronous mode operation at 2400 bps
- Automatic adjustment to 2400, 1200, 600 and 300 bps
- Speaker volume control via keyboard
- Voice/data capabilities
- High speed indicator
- Fully compatible with Hayes Smartmodem 1200™
- Call progress monitoring
- Programmable non-volatile memory
- Meets CCITT V.22 and V.22 bis, Bell 212A, and Bell 103 requirements
- Auto dial/auto answer

Complete on-line support is available through Hayes Microcomputer Products, Inc.

92205B

(1 unit)	\$599.00 ea.
(2-4)	585.00 ea.
(5+)	570.00 ea.

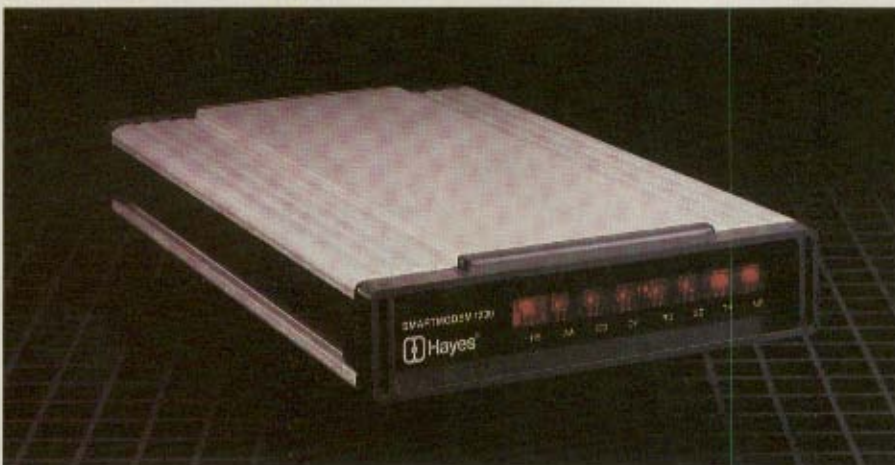

Hayes Smartmodem 1200™ combines speed with ease of use to make transferring large volumes of data over long distances economical and worry free. Connect the Smartmodem 1200™ to your computer's RS232 port, plug it into your telephone jack and you're ready to communicate with other computers, databases, information services and bulletin boards over dial-up phone lines. Since the Smartmodem 1200™ operates at up to 300 bps and 1200 bps, it's like getting two modems in one. The modem automatically adjusts to the speed of incoming data and works at both full or half duplex. A speaker provides audio monitoring of your call's progress and the modem operates with Touch-Tone® or pulse dialing.

Features

- Ease of use—Simple, fast direct connection to phone lines. Monitor call progress with indicator lights and speaker.

- Optional speeds—Operates at 1200 bps or 300 bps for varied speed requirements.
- Adjusts automatically to incoming data speed.
- Auto dial/auto answer—Unattended operation frees you to perform other activities and take advantage of lower nighttime phone rates.
- Convenient redialing—Redials last number called with either Touch-Tone or pulse capability.

Complete on-line support is available through Hayes Microcomputer Products, Inc.

92205A

(1 unit)	\$399.00 ea.
(2-4)	385.00 ea.
(5+)	370.00 ea.

For cables, see pages 73-81.

HP Express SERVICE "the quick fix" for Hayes Smartmodems

If a Hayes Smartmodem purchased from HP becomes defective, use our 92203X Express Service to receive a replacement within 24 hours.

How Express Service works

It's simple. If your modem needs to be replaced, call us direct (800) 538-8787, Monday through Friday. No advance contractual commitment or monthly charge is required. Order part number 92203X Express Service and the product number of the modem to be replaced.

It's fast. To ensure overnight delivery place your order before noon each weekday, Pacific Time. A sales consultant will arrange for overnight air shipment.

It's inexpensive. If your modem is in warranty when you call, you will be charged \$10 plus the cost for overnight shipping.

You will also receive a bill for the cost of a new modem. However, when you send us (by regular carrier, shipping prepaid) your original, complete unit within 10 days of your call, you'll receive full credit for the new unit. Your actual payment will be only for HP Express Service (\$10) and the shipping charges.

Out-of-warranty fixed-price repair charges

If Express Service is performed after HP's standard 90-day warranty has expired, you will be billed the fixed-price repair charge (92203R).

92203X HP Express Service ... \$10.00

92203R Fixed-price repair charge for modem not in warranty (includes 92203X HP Express Service) . . . \$95.00

Overnight shipping (depends on product and customer location)

Available in U.S. only

HelpLine Call Certificates—fast, personalized, technical advice



Speedy, convenient and expert help with your HP personal computer software questions and hardware configuration problems is just a phone call away.

HP HelpLine, our per-call service, provides you with fast response time; (your call will be returned within two hours); technical support by a representative specializing in your specific application area; and expanded hours of telephone assistance (7 a.m.—9 p.m. Monday through Friday Eastern Standard Time).

A prepaid HP HelpLine Call Certificate entitles you to one HP HelpLine call at a cost savings. A "call" consists of an in-

depth discussion of a single topic and related information with an HP support specialist. Whether your question or problem takes five or 30 minutes to answer or resolve, you will not incur additional charges for additional time. If the solution you are given does not work, you can call HP HelpLine back at no extra charge. HP HelpLine Call Certificates are sold in packs of five certificates. Valid for a minimum of one year after purchase.

35159A HelpLine Call Certificates

(1 pack)	\$220.00 ea.
(2-3 packs)	210.00 ea.
(4 and more packs)	200.00 ea.

On-the-road telecommunications capability

A portable modular jack, the Black Jack™ ensures superior telecommunications capability over ordinary telephone lines while you're on the road. Especially handy in hotels and offices that lack modular jacks, this direct-connect device for either the PORTABLE or The Portable PLUS, transmits at 0-1200 baud flawlessly. Unlike acoustic couplers, it prevents distortion of your data transmission by environmental noise. The Black Jack™ can be used with any telephone with a removable mouthpiece. ☺

92204F Black Jack™ \$59.00 ea.



HP Vectra 1200 baud internal modem

Plug the internal 1200 baud modem into a slot in your HP Vectra PC. Then connect this space-saving modem to a telephone line, load your communications software and your PC is ready to talk with the rest of the world.

The modem is programmable, using the industry standard "AT" command set and is fully compatible with the Bell 212A standard at 1200 and 300 bps. It runs practically all communications software or integrated packages with communications capabilities. Included with your modem is industry standard software (CROSSTALK XVI™) with easy-to-understand instruction screens and update commands. ☺

Features

- Auto-dial
- Auto-answer
- Auto-speed selection
- Software has built-in help functions, status indications and error messages

24550A Internal 1200 baud modem \$400.00 ea.

Touchscreen (HP 150) 1200 baud internal modem

Powerful telecommunications capabilities are yours when you add the 1200 baud internal modem to your Touchscreen or Touchscreen II. Installed in one of your PC's expansion slots, this space-saving modem allows you to connect to on-line information services and transfer data between Touchscreens, mainframes and other personal computers. Fully compatible with the Bell 212A standard, this modem runs with practically all communications software. It comes with all necessary cables and documentation. ☺

Features

- Auto-dial
- Auto-answer
- Auto-speed selection
- Selectable tone or pulse dialing

45640A Internal modem \$510.00 ea.

Speed data on its way with 9600 baud modem



92205H MICOM® 9600 bps synchronous modem is the ideal choice to use in applications requiring fast synchronous data transmission.

The 92205H can operate in multi-point or point-to-point configurations at full speed over unconditioned leased telephone lines. Two-wire, half-duplex and four-wire, full- or half-duplex modes are supported. The 92205H has a powerful adaptive equalizer that enables it to tolerate changing line conditions, ensuring 9600 bps operation under conditions that would cause many other modems to fail. The 92205H can also fall back to 7200 bps and 4800 bps.

Simple installation

The 92205H is user-installable and only requires that you set the configuration switches, plug in cables, and turn on the power.

Troubleshooting is a "do-it-yourself" matter. From the host site, the user can initiate remote loopbacks. Integral testing capabilities include both analog and digital loopbacks, plus a pattern generator for use with loopback tests. Front panel indicators also provide status of the modem.

92205H

(1-2 units)	\$2,450.00 ea.
(3-4)	2,425.00 ea.
(5+)	2,400.00 ea.

Save money, time and space!

Use the chart below to find out how you can get the most from your personal computer for less money by sharing peripherals, or, by using peripherals that speed up your data transmission.

	92205F Surge protected RS232C Dual ABC switch. Page 29	92205E Surge protected RS232C ABC switch. Page 29	92205Y HP-IB ABC switch. Page 29	92205V Microspooler™ 64.* See below	92205W Microspooler™ 128.* See below.
No. of users	Up to 6	Up to 3	Up to 3	1	1
Peripheral types	Printers Plotters Modems	Printers Plotters Modems	Printers Plotters	Printers	Printers
No. of peripherals	Up to 6	Up to 3	Up to 8	1	1
Peripheral sharing	Yes	Yes	Yes	No	No
Port expansion	Yes	Yes	No	No	No
Buffer size	None	None	None	64K-bytes.	128K-bytes
Interface	RS232C	RS232C	HP-IB	RS232C	RS232C

*Available in U.S. only.

No more waiting while you're printing

You can save time and increase your productivity. With the MicroSpooler™ 64 and the MicroSpooler™ 128, you can print without having to wait. Each MicroSpooler™ accepts data from your computer at up to 5800 characters per second and stores it until your printer is ready. It then relays the data at the fastest pace the printer will accept, which means while the MicroSpooler™ is sending your data to a printer, you can start on the next job.

Applications With 64K bytes of buffer memory, MicroSpooler™ 64 is perfect for correspondence and short text tasks. MicroSpooler™ 128 has 128K bytes of buffer memory and is ideal for transmission of more complex and advanced documents as well as scientific and business processing applications.

Features Easy-to-operate controls allow user to interrupt and resume operations or clear the buffer memory. Internal switches let user set, and then forget, baud rates, protocols and handshaking parameters.

Easy-to-understand digital readout continually updates and displays the amount of memory in use and indicates system status. (One initial command allows user to print or transmit up to 256 duplicate copies.)**

Easy to install using existing standard printer cable and a 31391A (RS232C 25-pin end-to-end) cable.

Both MicroSpoolers™ are compatible with RS232C printers and are fully supported by the manufacturer. Conso-link® Corp. Available in the U.S. only. ☺

92205V MicroSpooler™ 64 ... \$395.00 ea.

92205W MicroSpooler™ 128 ... 495.00 ea.

31391A RS232C cable 70.00 ea.

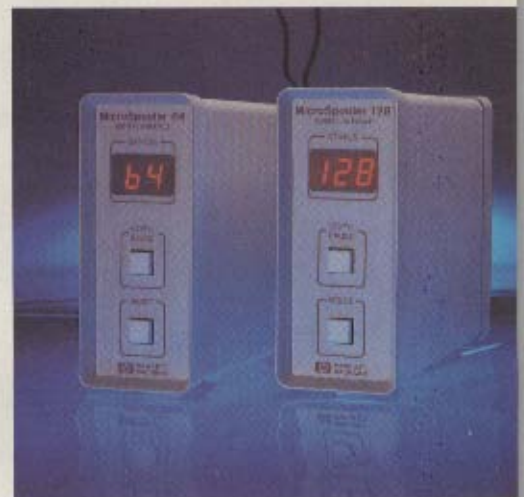

Printing

Without MicroSpooler™ 21 minutes
(CPU time for 20 pgs.: 80 CPS Bidirectional)



With MicroSpooler™ 8 seconds**
(CPU time for 20 pgs.: 80 CPS Bidirectional)



**If the length of your document exceeds your Microspoolers' memory capacity, additional CPU time will be required to print and only the last portion can be duplicated.

Call us with your Purchase Orders or

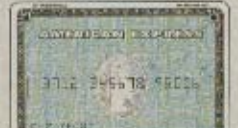

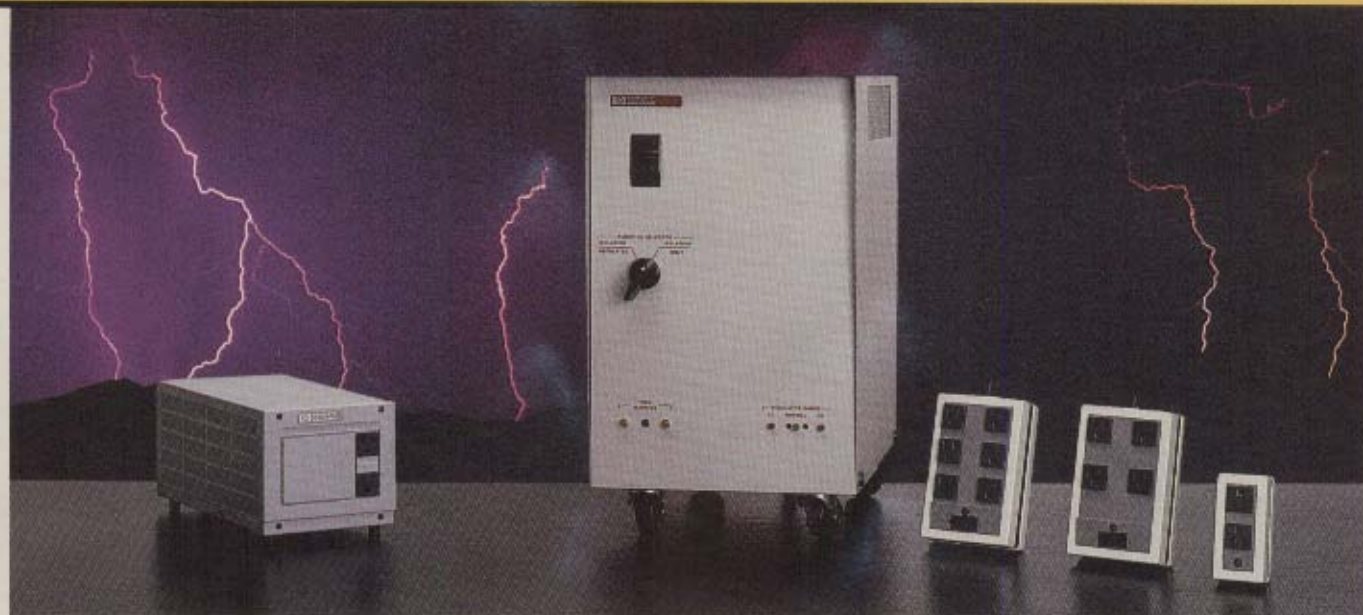

Power conditioners—Insurance for HP computer systems

Modern MIS managers use power conditioning to get the most out of their computer systems every day. They know that power problems create computer problems:

- Disc errors
 - Lost data
 - Garbled printouts
 - Overheating of internal power supplies
- Why should you wait until problems like these occur?

Dirty power Electrical noise, sags, and surges are the most common electrical disturbances your system encounters. Noise can be created by electric motors inside your building, such as copy machines, or by outside forces like lightning. Start-up of heavy equipment, like a hard disc drive, requires start-up currents well in excess of normal operating levels. And in some locales, brownouts or power reductions have become a fact of life.

What can you do?

Cleaning up and regulating the power that drives computer systems is the job of power conditioners. HP engineers have matched the power requirements of HP systems with a set of tough performance standards for power conditioners. The result is a family of products that will help you get optimum reliability and performance from your system.

HP offers three types of power conditioning devices. Use the table at the right to determine what power conditioner is best for you.

Power conditioning comparison guide

Major types of power disturbances	Common power-line problems	Recommended solutions		
		Surge Suppressor	Small Isolation/Regulators	Large Isolation/Regulators
Electrical noise	High-voltage transients caused by lightning	✓	✓	✓
	Spikes caused by utility network switching	✓	✓	✓
	Ringing disturbances caused by power-factor correction capacitor switching by the utility		✓	✓
	Transients caused by the operation of electrical devices such as machine tools, air conditioners, lighting systems and office equipment	✓	✓	✓
Voltage fluctuations	Brownouts		✓	✓
	Undervoltages and overvoltages caused by power-line faults and fault clearing devices		✓	✓
	Voltage fluctuations caused by start-up of heavy equipment such as elevators		✓	✓
	Chronic low voltage due to overburdened distribution networks		✓	✓
	Voltage fluctuations caused by user-owned generators		✓	✓
Other types of power problems	Ground not dedicated or isolated		✓	✓
	Shock hazard		✓	✓
Features				
Regulation and Isolation			✓	✓
Output voltage		120V	120V	120V/240V
Number of different receptacles offered		1	2	4
Number of different output receptacle configurations		3	2	14
kVA Range			1-2	3-10
Regulation/Isolation Switch				✓
Regulator Range Indicator				✓
Fuse Indicator				✓

Which power conditioner is right for your HP computer system?

Power conditioner/HP computer system compatibility

Use the guide below to choose the power conditioner best suited to protect your HP computer system. The darkest shading indicates optimum compatibility.

HP computer system	Surge Suppressor	Small Isolation/Regulator	Large Isolation/Regulator
HP 3000			
Series 58			
Series 40			
Series 44			
Series 42			
Series 39			
Series 37			
HP 1000			
HP 9000			
HP Vectra			
HP Touchscreen (150)			

Note: The correct power line conditioner for your computer system also depends on what peripherals are configured in your system.

How to calculate what kVA size power conditioner your computer system needs

- 1 Read the MAXIMUM CURRENT RATING on the back label of each component in your system.
- 2 Multiply the MAXIMUM CURRENT by the VOLTAGE being used (i.e. 120 volts or 240 volts). Divide by 1000 to get kVA size of each component.
- 3 Add the kVA calculations of each component to get a total system kVA.
- 4 Select an HP power conditioner with a rating larger than the system kVA rating.

Example:

HP Equipment	On label	Conversion	kVA
Computer	3A	3A x 120V* = 360VA	0.36
Disc Drive	2A	2A x 120V* = 240VA	0.24
Printer	2A	2A x 120V* = 240VA	0.24
Total kVA			0.84

*These are 120V, 60 Hz single phase units.

In this case, a 1 kVA-unit best fits your current needs. If you have plans to expand your system by either adding peripherals or changing CPUs, a 2 kVA-power conditioner will allow for that expansion.

Specifications

The following specifications are the minimum requirements that line conditioning devices must meet to be recommended for use with Hewlett-Packard computer systems.

Forward transfer impedance (at 1 kHz)

Nominal input - 120 VAC
Transfer impedance (ohms) - 5.3 + kVA rating
Nominal input - 208 VAC
Transfer impedance (ohms) - 16.0 + kVA rating

Output impedance

5 ohms from 5 kHz to 1 MHz

Inrush current

1000% of nominal for one-half cycle

Surge current rating

300% of nominal for one second

Static voltage response (regulating devices only)

Load power factor—

Device operates over power factor range of 0.7 lag to 0.7 lead

Input range:

Nominal input 120V
Actual input 94 to 135V
208V 162 to 233V

Output range:

Nominal output 208V
Actual output 191 to 216V

Static voltage response (isolation transformers only)

Input/output voltage response—

Output voltage tracks input voltage to $\pm 2\%$

Noise

Device cannot add more than 2% to the source or load at full resistive load

Ground to neutral bond

Transformer-based devices must have the neutral and ground bonded together at the secondary.

Noise rejection

Devices are tested using the IEEE 587A-80 waveform. The device is resistive loaded from 75% up to the maximum rating of the device. Specifications to be met are:

Pulse applied at input

Normal mode

L-N

Common mode

L, N-G, L-G, N-G

Peak voltage at output

< 20 V Normal mode L-N

< 0.5 V Common mode N-G

< 20 V Normal mode L-N

< 0.5 V Common mode N-G

50 ohm RF Attenuation

> 30 db attenuation of conducted EMI from 30 kHz to 30 MHz

Line reduction response time (regulating devices only)

Regulate input voltage changes to required output within one cycle

Recovery response time

Output will stabilize within 1.25 cycles from a one cycle input dropout

Efficiency

Device is greater than 90% efficient at full resistive load

Operating frequency

60-Hz \pm 5% to 63-Hz Range

Operating temperature

Operates from 0-50 C



Receptacle: 5-15R
Plug: 5-15P



Receptacle: 5-20R
Plug: 5-20P



Receptacle: L5-30R
Plug: L5-30P



Receptacle: 5-50R
Plug: 5-50P



Receptacle: 6-30R
Plug: 6-30P



Receptacle: L6-30R
Plug: L6-30P



Receptacle: 6-50R
Plug: 6-50P



Receptacle: L14-20R
Plug: L14-20P

Large Isolation/Regulators— For maximum computer system protection

If your computer installation includes a hard disc, is exposed to brownouts, or competes with heavy electrical equipment for power, an HP Isolation/Regulator may be the solution.

HP Isolation/Regulators are made up of two distinct parts—an Isolation Transformer and a regulating mechanism. The Isolation Transformer eliminates noise on the line while the Regulator ensures that, as input voltage varies within broad limits, your computer system sees a constant power level.

HP's large Isolation/Regulators feature an isolation/regulator switch so you have backup protection in case of regulation problems. Other features include output voltage of 120V or 240V, 14 different configurations of output receptacles, regulation range and fuse indicators.

For more details, see the technical specifications on opposite page. For further assistance, please consult your local HP service engineer. These units are UL and CSA approved and are backed with a 90-day warranty.



Large Isolation/Regulators (shipped within six days)

Product number	Input voltage	Output voltage	kVA	Dimensions (inches)	Shipping weight	Input connector*	Output receptacles	Price
92277A	120V	120/240V	3	20 H x 12 W x 16 D	91 lbs.	5-50P	L14-20, 8(5-20R2)	\$3880.00 ea.
92277B	208V	120/240V	3	20 H x 12 W x 16 D	91 lbs.	6-30P	L14-20, 1(6-30), 6(5-20R2)	\$3880.00 ea.
92277Q	120V	120/240V	3	20 H x 12 W x 16 D	91 lbs.	5-50P	L6-20, 1(6-30), 3(5-20R2)	\$3880.00 ea.
92277C	208V	120/240V	5	20 H x 12 W x 16 D	121 lbs.	6-50P	L14-20, 1(6-30), 6(5-20R2)	\$4375.00 ea.
92277R	208V	120/240V	5	20 H x 12 W x 16 D	121 lbs.	6-50P	L6-20, 2(6-30), 2(5-20R2)	\$4375.00 ea.
92277G	208V	120/240V	8	20 H x 12 W x 16 D	137 lbs.	APPLETON ADR 6023BC	L14-20, 1(6-30), 6(5-20R2)	\$4755.00 ea.
92277H	208V	120/240V	8	20 H x 12 W x 16 D	137 lbs.	APPLETON** AEE 36 RECEPTACLE MOUNTING BOX	L6-30, 1(6-30), 5(5-20R2)	\$4755.00 ea.
92277S	208V	120/240V	8	20 H x 12 W x 16 D	137 lbs.	APPLETON** AEE 36 RECEPTACLE MOUNTING BOX	L6-20, 2(6-30), 2(5-20R2)	\$4755.00 ea.
92277L	208V	120/240V	10	20 H x 12 W x 16 D	161 lbs.	APPLETON ADR 1023CD	L6-30, 1(6-30), 5(5-20R2)	\$5285.00 ea.
92277T	208V	120/240V	10	20 H x 12 W x 16 D	161 lbs.	APPLETON** AJA 410 RECEPTACLE MOUNTING BOX	L6-20, 2(6-30), 2(5-20R2)	\$5285.00 ea.

*Receptacle provided with unit for customer installation. (Voltage regulators only.)

**This must be provided by the user.



Small Isolation/Regulators— For protection of small computer systems

Use HP's small Isolation/Regulators to protect your small computer system from electrical noise transients and voltage fluctuations. These small Isolation/Regulators:

- comply with the IEEE 587A-1980 standard
- are UL and CSA-approved

Small Isolation/Regulators

Product number	Input voltage	Output voltage	kVA	Dimensions mm (inches)	Shipping weight	Output receptacles ¹	Input connector	Price
92164A	120V	120V	1	152 H x 178 W x 356 D mm (6 H x 7 W x 14 D in.)	38 lbs.	5-15R2	5-15P	\$ 839.00 ea.
92164B	120V	120V	2	254 H x 254 W x 483 D mm (10 H x 10 W x 19 D in.)	96 lbs.	L5-20R, 2(5-15R2)	L5-30P	\$1399.00 ea.

¹R2 - Duplex

Protect your personal computers and peripherals with surge suppressors

Use HP's Surge Suppressors to protect your personal computer and peripherals against electrical surges/transients. HP Surge Suppressors also have EMI/RFI noise filtering. These units feature three-stage circuitry to detect and dissipate dangerous electrical surges on your power line. All HP Surge Suppressors comply with IEEE 587-1980 standards and are UL and CSA-approved. Find out how to determine what power conditioner to use with your computer system on page 156.



Surge Suppressors

Description	Number of 5-15R Receptacles	Dimensions Inches (mm)	Product Number	Price
Surge Suppressor	2 (no cord)	2W x 4.5D x 2H (51 x 114 x 51)	92165A	(1 unit) .. \$69.00 ea. (2-4) ... 64.00 ea. (5+) 59.00 ea.
Surge Suppressor	4 (6 ft. cord)	5W x 7D x 2H (127 x 179 x 51)	92165B	(1 unit) .. 89.00 ea. (2-4) ... 84.00 ea. (5+) 79.00 ea.
Surge Suppressor	6 (6 ft. cord)	5W x 7D x 2H (127 x 179 x 51)	92165C	(1 unit) .. \$99.00 ea. (2-4) ... 94.00 ea. (5+) 89.00 ea.

Surge Protection Specifications

Applicable line voltage: 120V_{RMS} nominal, 15 Amp Capacity
Temperature: -25 to +75°C operating; -50 to +100°C storage
Operating humidity: less than 95% noncondensing
Standby current: less than 1 milliamp

Characteristics	Stage 1	Stage 2	Stage 3
Component clamping response (seconds)	5 x 10 ⁻¹² (5 psec)	5 x 10 ⁻⁹ (5 nsec)	1 x 10 ⁻⁶ (1 usec)
Power dissipation in 100 micro-seconds (watts)	4,500	500,000	1,000,000
Rated energy absorption (joules)	1.5	55	100
Clamping level (volts peak) 120 V	200 ± 5%	200 ± 10%	230 ± 15%
Dynamic impedance (Ω) 120 V	10	less than 1	10

Protection mode: Transverse and Common (3-stage models)

Protection status indicator: Circuit Integrity Lamp shows that protection circuit is functional. If lamp is out, unprotected power is usually still supplied. (If lamp is out, unit should be replaced.)

RFI & EMI noise protection filtration

Noise attenuation range: -5 dB to -40 dB
Frequency: 100 kHz to 30 MHz

If your equipment has RS-232 data ports, you need surge protectors!

Protect your valuable data and equipment. Install a pair of HP surge protectors—one at each end of a link—to shield data communication ports from burnout.

Why? Because when a fluorescent light switches on, a motor starts or lightning strikes, electrical surges hit the data lines of your RS-232 cables.

Overvoltage surge or static spike cause slow deterioration to the communications interface of your computers and peripherals. The result can be scrambled data transmission or total failure in communication.



Small size and advanced all-metal design offers superior RFI shielding.

Protection of pins 2-8 and 20 ensures compatibility with all HP and most non-HP devices.

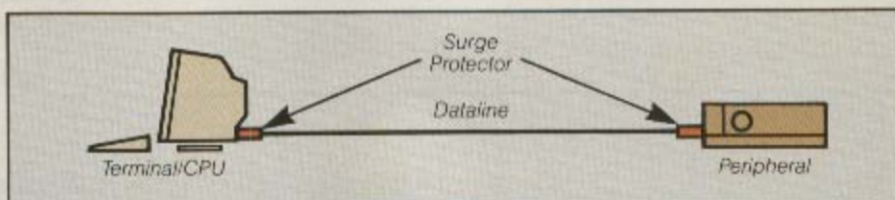

RS-232 Surge Protection Specifications

Characteristics:

Low capacitance steering diodes with high speed TransZorbs. Adds negligible line impedance.

Pins 2-8 and 20 protected. Referenced to pin 1—chassis ground.

Size: 0.495"H x 2.1"W x 1.92"D (13 mm x 53 mm x 49 mm D)

Weight: 1.3 oz. (36 g)

Enclosure: All metal for extra RFI protection.

Clamp voltage: ±26 volts typical; ±40 volts maximum.

Clamping response: 60 ns

Power dissipation:
4k watts (100 μs)
9k watts (20 μs)

Line capacitance: 30-60pF

The cost of protection is small compared to expensive repairs, particularly if you have RS-232 cable longer than 50 feet.* For a minimal investment, you can safeguard your sensitive equipment and eliminate worry over excessive downtime.

***NOTE:** HP warranties and/or service contracts do not cover damage if RS-232 cable exceeds the 50-foot limit of the RS-232 standard.

92165R Surge protector	
(1 unit)	\$49.00 ea.
(2-9)	45.00 ea.
(10-24)	41.00 ea.
(25-99)	35.00 ea.

Organize power cords for convenience and safety

For your convenience, HP now offers two U.S. power strips. Both cases are made of seamless steel with a baked-on finish for durability.

Mounting hardware is provided with both, and each features a 6-foot (1.8m) power cord with molded U.S. connector.

Electrical rating: 15A, 125 VAC, 60 Hz, 1875 W. continuous duty.

Price	92199A*	92199B
(1-4)	\$35.00 ea.	\$36.00 ea.
(5-9)	32.00 ea.	33.00 ea.
(10+)	30.00 ea.	31.00 ea.

*Not approved for use in Canada.



92199A Multiple outlet strip



92199B Multiple outlet strip

Multiple outlet strip comparison

	92199A*	92199B
Suggested use	Office/Home	92211R or other system rack
Electrical approval	UL	UL/CSA
Master switch	Yes	No
Color	Beige	HP Pearl Gray
Length	12 in. (305 mm)	8.75 in. (222 mm)
Width	2.5 in. (64 mm)	2 in. (61 mm)
Height	1 in. (25 mm)	1.5 in. (38 mm)

Choose the right battery for your HP system

Whatever your application, you need the right battery to keep your system up and running. Here's a chart to help you select the battery for your HP equipment. HP calculator batteries are readily available in several brands through your local dealer, photo store or drug store. For batteries that are not customer-installable, please consult your local dealer. Note: Silver oxide batteries should last twice as long as Alkaline batteries. A set of three fresh silver oxide batteries will provide 180 hours of continuous program running, as opposed to 80 hours provided by three fresh Alkaline batteries.

HP Equipment	Battery	Availability	HP Equipment	Battery	Availability
HP Vectra PC	45935-60008	☞ not customer installable	HP 10C, 11C, 12C, 15C,	Alkaline	Drug store
Touchscreen II (HP 150 II)	1420-0338	☞ not customer installable	16C, 17B, and 27S calculators	VCAAR A76	
Touchscreen (HP 150A/B)	N cell	☞ Drug store	HP 01 Wristwatch	Eveready A76	
The PORTABLE	1420-0329	☞ not customer installable		RAY-O-VAC RW82	
The Portable PLUS	1420-0346	☞ not customer installable		National or	
HP 120	1420-0255	☞ not customer installable		Panasonic LR44	
HP 125	45701-63003	☞ not customer installable		OR	
HP 2225B	82199A	☞ not customer installable		Silver Oxide	Drug store
9114A/B Disc Drive	88014B			VCAAR 357	
262X/2675A	1420-0259			Eveready 357	
HP35/45/55/67, Series 70	82001B			RAY-O-VAC RS76	
HP71	AAA	☞ Drug store		or FW42	
82161A, 82162A, 82168A, 97A	82033A or 82037A			Duracell MS 76	
82240A	AA				
HP41C/CV/CX	N cell	☞ Drug store			
HP31E/32E/33E/33C/34C/37C/38C	82109A		HP 18C, 19B, 28C and 28S	N cell	☞ Drug Store
HP21A/22A/25A/27A/29C	82019B		calculators		
HP10A/19C	82052A				

Call us with your Purchase Orders or



We ship same day

CALL HP DIRECT
800-538-8787

Gambling your data against a power failure? You are if you don't have a backup power supply...or if you use the wrong one.

With no warning, a power failure could turn today into your worst nightmare.

Hours of hard work—wiped from your computer's memory without a trace.

Or worse. If it hit while you were saving, your disk could be permanently damaged. Payroll, databases, CAD files, accounts receivable—reconstructing them could take months.

Standby power: your safety net There is something you can do—now. Get an HP Back-up Power Supply (BPS). If AC power goes, it provides back-up power until you can save your file and shut down.

Using it for your Vectra or Technical Workstation could mean the difference between a brief delay and a major disaster.

But using anything less than this one could be like using none at all. Because this is the first BPS that meets Vectra's and HP's Technical Workstations' strict requirements for a standby device.

Why slow backup equals no backup Most BPS's take 10-30 milliseconds to switch on (transfer) in a blackout. While that seems fast, computers can lose memory faster. The Vectra needs power within 8 ms. Our BPS provides it in under 2.

Also critical is the type of power a BPS provides. Most yield a square wave or



Losing data to a power failure is agony. Losing it when you thought you were covered is worse. Get the HP BPS...the first back-up power supply to deliver what your Vectra & Technical workstation need.

variations that carry troublesome "noise."

Almost none produce a sine wave—the "perfect power" HP and most other computers expect...and that our BPS delivers.

And, unlike most other back-up power supplies, the HP BPS is UL listed for safety.

Don't find out too late what false security can cost you. Get the right BPS: the HP Back-up Power Supply.

46296A HP Back-up Power Supply \$795.00 ea.

Specifications

- Output Voltage (vac):** 115V
- Output Power:** 500 watts
- Run time:** 9-25 minutes
- Distortion:** <5% (linear load)
- Switching:** Transistorized
- Output:** Sine wave
- Batteries:** Sealed lead-acid (3 year average life)
- Transfer time (includes detection time):** <2 milliseconds
- Synchronized transfer**
- UL listed**
- Not for use in Canada

Sine wave ("clean" power)



Square wave



Pulse-width modulation wave



Most computers require sine wave input, but few BPS's provide it, opting for easier-to-generate square waves. These carry too much power, plus harmonics

which can cause overheating. The modulated waveform tempers the square wave's energy, but still carries its distortion.

We ship same day

**CALL HP DIRECT
800-538-8787**

You can now get these test & measurement accessories shipped the same day you order:



- Probes
- Instruments
- Rack mounts
- Test leads
- Recorder paper



Check off your instrument interests on the catalog subscription card and we'll send you the latest Test & Measurement Accessories Catalog from HP DIRECT. Available in the U.S. only.

Three ways to order:

1 Call HP DIRECT at 800-538-8787...toll free!

Ordering by phone is fast and easy. Just call us any weekday between 6 a.m. and 5 p.m., Pacific Time. One of our sales consultants will be pleased to serve you. This phone order service is available in all 50 U.S. states (see ordering details below). *There is no minimum order amount.* And if you phone in your order before 4 p.m., it will be shipped to you the same day!

2 Order from your local authorized HP dealer.

Many of our products are available at your authorized HP dealer. These products are identified throughout this catalog with the dealer symbol, . It's our way of letting you know that a product can be purchased from either an authorized dealer or HP DIRECT. If every product on a page is carried by our dealers, the  will appear at the top of that page. For the name and location of your closest HP dealer, call 1-800-752-0900.

3 Order from your nearby HP office.

If you must order by mail, please direct it to your local HP Sales office. See the list of regional offices in this blue section for the one nearest you. *A minimum of \$20 per order applies.*

Stay informed! Return enclosed Catalog Subscription Card today.

HP's catalog selection of supplies, equipment and accessories is expanding! We need to know more about your interests, so we can keep you informed of our latest products and services.

To ensure you regularly receive our catalogs and special offers on a continuing basis, please complete and send us a Catalog Subscription Card (located in the center of the catalog). This is especially important if you've not returned a Card within the past 12 months. Thank you!

When you order from HP DIRECT by phone

Have the following information handy:

1 Your HP DIRECT **Account number** (see your mailing label), plus your company's **Purchase Order number** so we may reference it in our shipment to you.

If someone else orders for you, help your buyer by including your HP DIRECT **Account number** and **Priority Code number** on your purchase requisitions.

If you are ordering with a credit card, please have your VISA, MasterCard or American Express card number and expiration date ready.

2 Our **Priority Code number**, from your mailing label or this catalog's back cover. This Code helps us know which of our publications are most useful to you.

3 For each item ordered, please tell us:
First, the **exact quantity** of the product. (some items are packaged in multiples per box.)
Then, the **catalog product number** for the item.

If you're only calling to check prices or product availability, save yourself a phone call. Ninety-nine percent of our products are available off the shelf, plus our net prices, effective October 1, 1988 through May 31, 1989, are usually valid as stated in the catalog. You can place your order with confidence using these prices.

If you have any questions about your order *after* you've placed it, please call HP DIRECT (800-538-8787).

Open an HP DIRECT Account!

It's easy. When you first order, all we need is your company billing and shipping addresses, plus your purchase order number.

Within a few minutes we will assign your HP DIRECT Account number for your use on all future orders.

We are required to collect all state and local sales/use taxes, unless we have a tax exempt certificate on file at HP DIRECT's order center.

HP DIRECT offers these benefits:

Free surface delivery. HP DIRECT prices include regular surface freight of HP's choosing to your street address. *Your order will be shipped the same day if placed by 4:00 p.m. (your local time), and almost always within 24 hours.* Depending on your location, your order will typically reach you within one to seven working days.

Overnight delivery available. When you need even faster service, HP DIRECT can ship via air carrier provided your credit-approved order is received by 4 p.m. Pacific Time. This is an extra-charge service, and you will be billed the total cost of premium air express service to your area.

Quantity discounts may apply. HP offers per product quantity discounts on many products provided the entire quantity is shipped at one time, to one address. Most of our discounts are listed in the catalog. Please call us for discounts on quantity orders larger than those published in the catalog. **Order quantities may be limited on certain products.**

HP DIRECT continuously seeks to provide the very best phone service. To assist in training our sales consultants, HP DIRECT supervisors randomly monitor phone conversations with customers.

Terms of sale

Inside the USA

Terms are net 30 days from invoice date if credit has already been established with HP. Otherwise, shipments are made on receipt of cash in advance or with an approved credit card.

No minimum order size when ordering by phone. Minimum of \$20 per order when ordering through HP sales office.

A company purchase order may be used against an HP DIRECT Account number when you order by phone. For more information on obtaining an HP DIRECT Account number, see "Three ways to order" on previous page. However, please contact your local HP sales office for processing of company purchase orders by mail.

Puerto Rico Order through your local HP sales office.

Outside the USA Terms are determined by the HP international sales subsidiary or authorized representative/distributor.

Billing questions

If you ordered via our HP DIRECT Phone service (the "HP Order Number" shown on your invoice, etc. is 10XXXXXX or 20XXXXXX), and you have received the products ordered but have a question regarding your billing, please call 408-720-2537 and ask for the "collections department." This number is for billing questions only.

If you ordered via your local HP Sales Office (the "HP Order Number" is 24XXXXXXX, 26XXXXXXX, 31XXXXXXX, or 44XXXXXXX), please contact that sales office regarding any billing questions.

Prices

Prices include regular surface freight of HP's choosing to your USA location and any inside delivery or special handling required. Extra-cost carrier charges such as air express are not included in our price. You will be charged when such extra services are requested. However, these costs can be minimized by allowing HP to select a carrier with whom we have corporate discounted rates. These charges will be separately itemized on your invoice. Our prices are F.O.B. USA destination.

Prices are net, effective October 1, 1988. HP reserves the right to correct printing errors and to change prices. Only those prices officially listed on the HP Corporate Price List and prevailing at the time an order is received will apply.

Per-product quantity discount prices only apply if the entire quantity of that product is shipped at one time and to one address. Order quantities of some products may be limited.

Shipping methods

All shipments are F.O.B. destination, and are made via HP choice of surface carrier with regular freight costs included in the HP price.

If you need faster service, we'll be pleased to ship your order the same day via HP approved air carrier serving your area. However, we must have your credit-approved order by 4 p.m. (Pacific Time) to ship that day. You will be billed HP's corporate discount rate in addition to the price of the HP product when premium shipment is requested. Credit is not issued for unused surface freight.

We make every effort to accommodate special requests, but we cannot guarantee price or delivery for these requests.

Damages in shipment

Occasionally, items will be damaged in transit. If this happens, please follow the instructions below:

1. If a shipment is visibly damaged on arrival, do not accept it until the person making the delivery has endorsed the bill of lading with a statement for the extent of damage.
2. If any damage is found after unpacking, retain all cartons and inner packaging at the address to which the shipment was made and immediately request that the carrier arrange for an inspection.
3. Notify HP DIRECT (800-538-8787) immediately of the damaged shipment in order for us to make the proper sales adjustment and/or provide you with return instructions. Please provide us with the sales order number, product number and quantity damaged.
4. If instructed to return the damaged product to HP DIRECT, please include copies of the bill of lading (with carrier's statement of damage) and the inspection report.

Returns

If there is a problem with your order, we want to correct it as soon as possible. Please call us for return instructions:

- If you ordered via HP DIRECT Phone Service (the "HP Order Number" is 10XXXXXX or 20XXXXXX), call 800-538-8787.
- If you ordered via your local HP sales office (the "HP Order Number" is 24XXXXXXX, 26XXXXXXX, 31XXXXXXX, or 44XXXXXXX), contact that office.

For items returned for your convenience or due to your error, there is a restocking fee. There may also be an additional refurbishment charge for hardware products.

Limitations to Returns Policy

- Software may only be returned under warranty (see below) or if it is sealed and unused.
- Operating Manuals and other documentation may not be returned for credit.
- If a printer, terminal, plotter, or other peripheral has a problem while under warranty or needs repair, contact your local HP sales office (turn opposite page for listing) for instructions. Do not return warranty/repair add-on hardware to the HP Direct Distribution Center.

Warranty

HP blank floppy disc media and HP supplies: Blank floppy disc media listed in this catalog are warranted against defects in materials and workmanship for five years from date of shipment; all other HP supplies as listed in this catalog for use with HP computer products are warranted against defects in materials and workmanship for 90 days from date of shipment. During the warranty period, HP will replace any such floppy disc media and HP supplies which prove to be defective.

HP software products listed in this catalog are warranted against defective media for a period of 90 days. During the warranty period, HP will replace defective software media.

HP hardware products listed in this catalog are warranted against defects in materials and workmanship for a period of 90 days (specific products have a one-year warranty). If HP receives notice of such defects during the warranty period, HP will, at its option, either repair or replace hardware products which prove to be defective. Warranty service includes parts and labor; travel is not included. Return the product to the nearest HP office for warranty service.

These warranties do not cover damage resulting from misuse.

THESE WARRANTIES ARE EXCLUSIVE AND NO OTHER WARRANTY IS EXPRESSED OR IMPLIED. HP SPECIFICALLY DISCLAIMS THE IMPLIED WARRANTIES OF MERCHANTABILITY AND FITNESS FOR A PARTICULAR PURPOSE. HP SHALL NOT BE LIABLE FOR ANY DIRECT, INDIRECT, SPECIAL, INCIDENTAL OR CONSEQUENTIAL DAMAGES.

Limited one-year warranty for HP handheld calculators

What we will do—HP handheld calculators are warranted by Hewlett-Packard against defects in materials and workmanship for one year from the date of original purchase. If you sell your unit or give it as a gift, the warranty is automatically transferred to the new owner and remains in effect for the original one-year period. During the warranty period, we will repair or, at our option, replace at no charge a product that proves to be defective, provided you return the product, shipping prepaid, to an HP service center.

What is not covered—This warranty does not apply if the product has been damaged by accident or misuse or as the result of service or modification by other than an authorized Hewlett-Packard service center.

No other express warranty is given. The repair or replacement of a product is your exclusive remedy. ANY OTHER IMPLIED WARRANTY OR MERCHANTABILITY OR FITNESS IS LIMITED TO THE ONE YEAR DURATION OF THIS WRITTEN WARRANTY. Some states, provinces, or countries do not allow limitations on how long an implied warranty lasts, so the above limitation may not apply to you. IN NO EVENT SHALL HEWLETT-PACKARD COMPANY BE LIABLE FOR CONSEQUENTIAL DAMAGES. Some states, provinces, or countries do not allow the exclusion or limitation of incidental or consequential damages, so the above limitation or exclusion may not apply to you.

This warranty gives you specific legal rights, and you may also have other rights which vary from state to state, province to province, or country to country.

Sales office and trademark listings

Sales Office Listing

Procedure for mailing purchase orders: Calling HP DIRECT at 800-538-8787 is the fastest way to order products in this catalog. However, if it is your preference or your company's requirement to order by mail, please send orders to the nearest HP sales office listed below. Orders will be electronically transmitted to HP DIRECT for shipment.

ALABAMA

BIRMINGHAM
2100 Riverchase Cir., #118
Birmingham, AL 35244
(205) 988-0547

HUNTSVILLE
420 Wynn Dr. N.W.
Huntsville, AL 35805
(205) 830-2000

ARIZONA

PHOENIX
8080 Pointe Parkway West
Phoenix, AZ 85044
(602) 273-8000

CALIFORNIA

CALABASAS
26701 W. Agoura Blvd.
Calabasas, CA 91302
(818) 880-3400

FULLERTON
1421 So. Manhattan Ave.
Fullerton, CA 92631
(714) 999-6700

LOS ANGELES
5651 West Manchester Ave.
Los Angeles, CA 90045
(213) 337-8000

MOUNTAIN VIEW
321 E. Evelyn Ave.
Mountain View, CA 94043
(415) 694-2000

COLORADO

ENGLEWOOD
24 Inverness Place East
Englewood, CO 80112
(303) 649-5000

FLORIDA

FORT LAUDERDALE
2901 N.W. 62nd St.
Fort Lauderdale, FL 33309
(305) 973-2600

ORLANDO

6177 Lake Ellenor Dr.
Orlando, FL 32809
(305) 859-2900

PENSACOLA
4700 Bayou Blvd., Bldg. 5
Pensacola, FL 32503
(904) 476-8422

TAMPA
5550 W. Idliewild Ave., #150
Tampa, FL 33634
(813) 884-3282

GEORGIA

ATLANTA
2000 S. Park Pl.
Atlanta, GA 30339
(404) 955-1500

HAWAII

HONOLULU
Pacific Tower, Suite 2400
1001 Bishop St.
Honolulu, HI 96813
(808) 526-1555

ILLINOIS

NAPERVILLE
1200 E. Diehl Rd.
Naperville, IL 60566
(312) 357-8800

ROLLING MEADOWS
5201 Tolliver Dr.
Rolling Meadows, IL 60008
(312) 255-9800

INDIANA

INDIANAPOLIS
11911 N. Meridian St.
Carmel, IN 46032
(317) 844-4100

LOUISIANA

NEW ORLEANS
160 James Dr. East
St. Rose, LA 70087
(504) 467-4100

MARYLAND

ROCKVILLE
2 Choke Cherry Rd.
Rockville, MD 20850
(301) 948-6370

MASSACHUSETTS

ANDOVER
1775 Minuteman Rd.
Andover, MA 01810
(617) 682-1500

MICHIGAN

NOVI
39550 Orchard Hill Pl.
Novi, MI 48050
(313) 349-9200

MINNESOTA

ST. PAUL
2025 W. Larpenteur Ave.
St. Paul, MN 55113
(612) 644-1100

MISSOURI

ST. LOUIS
1301 Hollenberg Dr.
Bridgeton, MO 63044
(314) 344-5100

NEW JERSEY

PARAMUS
W. 120 Century
Paramus, NJ 07653
(201) 265-5000

NEW YORK

PURCHASE
2975 Westchester Ave.
Purchase, NY 10577
(914) 935-6300

ROCHESTER

200 Cross Keys Office Park
Fairport, NY 14450
(716) 223-9950

NORTH CAROLINA

GREENSBORO
5605 Roanne Way
Greensboro, NC 27409
(919) 852-1800

RALEIGH

305 Gregson Dr.
Cary, NC 27511
(919) 467-6600

OHIO

CLEVELAND
15885 Sprague Rd.
Strongsville, OH 44136
(216) 243-7300

DAYTON

9080 Springboro Pike
Miamisburg, OH 45342
(513) 433-2223

OKLAHOMA

OKLAHOMA CITY
3525 N.W. 56th, #C100
Oklahoma City, OK 73112
(405) 946-9499

TULSA

6655 S. Lewis, Suite 105
Tulsa, OK 74136
(918) 481-6700

OREGON

WILSONVILLE
9255 Pioneer Court
Wilsonville, OR 97070
(503) 682-8000

PENNSYLVANIA

PITTSBURGH
111 Zeta Dr.
Pittsburgh, PA 15238
(412) 782-0400

VALLEY FORGE
2750 Monroe Blvd.
Valley Forge, PA 19482
(215) 666-9000

SOUTH CAROLINA

COLUMBIA
Brookside Park
1 Harbison Way, #122
Columbia, SC 29210
(803) 732-0400

TENNESSEE

KNOXVILLE
1 Energy Cir., #200
Pellissippi Pkwy.
Knoxville, TN 37932
(615) 966-4747

MEMPHIS

3070 Directors Row
Memphis, TN 38131
(901) 346-8370

TEXAS

AUSTIN
1826-P Kramer Ln.
Austin, TX 78758
(512) 835-6771

DALLAS

930 E. Campbell Rd.
Richardson, TX 75081
(214) 231-6101

HOUSTON

10535 Harwin Dr.
Houston, TX 77036
(713) 776-6400

LAS COLINAS

3301 Royal Ln.
Irving, TX 75063
(214) 869-3377

SAN ANTONIO

14100 San Pedro Ave.
Suites 102, 202
San Antonio, TX 78232
(512) 494-9336

UTAH

SALT LAKE CITY
3530 West 2100 South
Salt Lake City, UT 84119
(801) 974-1700

VIRGINIA

NORFOLK
840 Greenbriar Circle, #101
Armada/Hoffler Business Ctr.
Chesapeake, VA 23320
(804) 424-7105

RICHMOND

4305 Cox Rd.
Glen Allen, VA 23060
(804) 747-7750

ROANOKE

2800 Electric Rd., Suite 100
Roanoke, VA 24018
(703) 774-3444

ROSSLYN

1550 Wilson Blvd., #600
Rosslyn, VA 22209
(703) 284-2600

WASHINGTON

BELLEVUE
15815 S.E. 37th
Bellevue, WA 98006
(206) 643-4000

The sales offices in this listing can process your large quantity hardware, contract or special order needs.

Trademark listing

AutoCAD™ is a trademark of Autodesk, Inc.

Bauer Bodoni is a U.S. registered trademark of Fundacion Typographica Neufville SA.

Century Schoolbook®, **Broadway®** and **Cooper Black®** are registered trademarks of Kingsley-ATF Type Corp.

Compaq™ is a trademark of Compaq Computer Corp.

CONTEXT MBA™ is a trademark of Context Management Systems Inc.

CorrectStar®, **StarIndex**, **WordStar®**, **WordStar Professional™**, **WordStar Professional Options™**, **Mailmerge®**, and **SpellStar™** are trademarks of MicroPro International Corp.

CP/M® is a registered trademark of Digital Research Inc.

Crosstalk® XVI is a trademark of Microstuf, Inc.

Datebook® and **Personal Datebook®** are trademarks of Organic Software Inc.

dBASE II® is a registered trademark of Ashton-Tate.

Diagraph™ is a trademark of Computer Support Corp.

GW™-Basic MS®-DOS, **MicroSoft®**, **MicroSoft Word®**, and **MultiPlan®** are registered trademarks of Graftek Inc.

ITC Garamond is a U.S. registered trademark of International Typeface Corp.

Lattice® C Compiler is a registered trademark of Lattice Inc.

1-2-3®, Symphony® and **Lotus®** are registered trademarks of Lotus Development Corp.

Mastering Framework™ is a trademark of Ashton-Tate.

MicroSoft® Word/Window is a U.S. registered trademark of Microsoft Corp.

MILESTONE® is a registered trademark of PDA Engineering Inc.

MultiMate® and **MultiMate Advantage™** are trademarks of MultiMate International Corporation, an Ashton-Tate company.

Peach Level 3® is a registered trademark of Relational Systems International.

R:BASE™ 5000, **Programmer's Interface™** and **R:Base V™** are trademarks of Micromin, Inc.

Serifa® is a registered trademark of Fundacion Typographica Neufville SA.

REFLECTION 1™ is a trademark of Walker, Richer & Quinn, Inc.

TKISolver™ is a trademark of Software Arts™.

Unix™ is a trademark of AT&T in the U.S.A. and other countries.

VisiCalc® is a registered trademark of Lotus Development Corp.

Zapl Humanist™ is a U.S. trademark of Bitstream, Inc.

The trademark information listed above is to the best of our knowledge, accurate and complete.

Alphabetical listing of catalog items

- A.**
Album file
Data cartridge 91
Flexible discs 87
Anti-glare filters 117
Antistatic protection 122-123
- B.**
Bar code readers
& accessories 127, 132
Batteries 159
Binders
Data 113
Data binder handles 113
Data cartridge 91
Documentation 143
Flexible discs 87-88
Books
Calculators 134
Data base &
spreadsheets 137
Data base management 137
Data communications 135
Graphics 136
Local Area Networks 66
Operating Systems 136
Personal computers
..... 25, 131-133, 138
Professional
reference 133, 137
Programming languages 135
Software 136-137
Word processing 136
- C.**
Cabinets
Accessories 101, 113, 116
Design Plus system 103
High density storage 95, 115
Magnetic tape
storage 95, 115
Printout/documentation
storage 115
Cables (for specific computer
cables, use the Computer
Equipment Reference Index)
Accessories 66, 71
Books 66
Cable management kit 71
Centronics-type 74-77, 80
Connector kits 70, 71
Covers 71
Gender converters 72
HP-IB 72
HP-IL 72
Local area networks 65-68
MicroSpooler™ 154
Modem 74-80
Multiplexer 80
Multi. outlet strips 158
Cut-to-length ordiaring
guide 69
Personal computer 73-74
Plotter 69-79
Power cords 71
Power strips 158
Printer 74-78
RS232C extension 73
RS422 74-75
Starlan 8-9
Terminal 80
ThinLAN 68
ThinMAU 68
Unterminated 70
Video extension 73
- Calculators
HP-12C & supplies 126, 129
HP 17B & supplies
..... 128-129, 134
HP-18C supplies 129
HP 19B & supplies
..... 128-129, 134
HP 22S & supplies 13, 129
HP 27S & supplies
..... 128-129, 134
HP-28C supplies 127, 129
HP 28S &
supplies 128, 129, 134
HP 32S & supplies 13, 129
Series 10 (HP 11C/12C/15C/
16C)
Accessories 126
Books 126
Series 40
HP 41CV, HP 41CX 127
Accessories 127
Peripherals 126-127
- Cards
Magnetic 127
Carpet, antistatic 123
Carrying cases 121
Cartridges
Data 7, 89-90
Disc 93
Easy load mag tape 94
High-density data 89
Mini-data 90
PC data 90
Cartridge storage 7, 90
Cassette drive 127
Casters, table 106
Chairs, ergonomic 108
Character fonts, plug-in 17-19
Cleaning kits 41, 46, 96, 122
Cleaning supplies
Cartridges, mag tape
drives 96
Flexible disc drive 96
Printer 41, 46
Color graphics printer
Supplies &
accessories 30-31
Computer
Accessories & supplies
PORTABLE/Portable
PLUS 133
Series 40 127
Series 70 127
Touchscreen 132
HP Vectra PC 131
Cables
LaserJet Printers 76-77
PORTABLE/Portable
PLUS 73-74
Touchscreen 73-74
HP Vectra PC 75-76
Carrying cases 121, 126, 133
Subscriptions 139
Cover, dust 120
Display turntables 119
Emulation accessories 132
Firmware 127
Series 40 127
HP Vectra PC 131
Handheld computers 127
Accessories & supplies 127
Software 127
Modems (see modems)
Peripherals
HP-IL 127
PORTABLE/Portable
PLUS 133
Series 40 127
- Series 100/200 62-63
Touchscreen 62-63
HP Vectra PC 62-63, 131
Software
HP Touchscreen 3, 130
PORTABLE/Portable
PLUS 133
Series 40 127
Series 70 127
Vectra PC 3, 130
Terminals
700/22 147
700/41 146
700/43 146
700/71 147, 149
700/92 148
700/94 148
- D.**
Daisywheel printer
Accessories 41
HP 2603A 41
HP 2603A supplies 41
Supplies 42
Data cartridge
Desktop storage rack 91
High-density (formatted) 90
Mini 90
PC 90
Storage binder 91
Storage tray 91
Datacomm
Modems 152-153
Peripheral-sharing 154
Test devices 151
Digital cassettes 90
Disc cartridges 92-93
Desktop storage rack 92-93
20.5 Mbyte cartridge 92-93
Disc, flexible 5, 84-85
Cleaning supplies 96
Easel binder kit 87
Hanging files 88
Storage & accessories 86
Disc, microfloppy 5, 84
Cleaning supplies 96
Hanging files 88
Storage & accessories 86
Disc packs 92-93
Storage cabinets 115
Disc/tape cleaning supplies 97
Documentation
Binders 143
Index 141
Storage rack 143
Drafting plotter 63
Accessories 56-57
Media 53
DraftPro Plotter
Accessories 49, 61
Media 53
Pens 55-56
Drum kit, laser page printer 28
Dust covers 6, 120
- E.**
Enclosure, sound 107
Ergonomic
accessories 118-119
Ergonomic chairs 108-109
Extending I/O card 132
- F.**
Filters, anti-glare 117
Flexible discs 69-70, 84-85
Accessories 86-87
- Cleaning supplies 96
High-capacity 84
Fonts
DeskJet 33
Impact printer 43
LaserJet/LaserJet Plus 17-21
LaserJet Series II 17-21
LaserJet 2000 17-21
RuggedWriter 40
Footrest 119
Forms
Printer layout 46
Furniture
Bracket kit 10
Cabinets 114-116
Chairs 108-109
Design Plus 10-11, 99-103
Lamp 10
Standard 10, 104-106
Workstations 10-11, 99-118
- G.**
Gloves, cleaning 97
Graphic supplies 49, 54, 60-61
- H.**
Head alignment tape 95
Head cleaner, mag tape 96
Helpline Call Certificates 153
HP Express Service 152
HP-IB cables 72
HP-HIL devices
HP Mouse 131-132
HP-HIL extension
module 131
HP-IL accessories 127
HP-IL cables 72
HP-IL peripherals 127
- I.**
IBM emulation accessory 132
Impact printer 40-41
Accessories 40-41
InkJet printer 35
Supplies 36-39
Index, computer
documentation 141
Interface cards
PORTABLE & Portable
PLUS 133
Touchscreen 132
Vectra PC 131
Interface modules 132
Isolation/Regulators 157
- K.**
Keyboard parks 118
- L.**
LaserJet 2000 Printer
Font organizer 25
Fonts, plug-in 17-20
Fonts, soft 20-21
Paper cassette trays 28
Software 22-23, 31-39, 130
Spent toner disposal
boxes 28
Toner 28
LaserJet/LaserJet Plus Printers
Books 25, 137
Cables 76-77
Fonts, plug-in 17-20
Fonts, soft 20-21
Mobile printer stand/
cabinet 27, 102

Alphabetical listing of catalog items (continued)

Paper trays 26
Software 22-23, 31-39, 130
Toner 15
Vacuum cleaner 9, 27
LaserJet Series II Printer
Books 25, 137
Cables 77
Dust cover 25
Envelope feeder 25
Font organizer 25
Fonts, soft 20-21
Memory expansion boards 23
Mobile printer cabinet 27
Paper trays 26
Sharing devices 3, 4
Software 22-23, 31-39, 130
Toner 15
Vacuum cleaner 9, 27
Laser page printers
Carriers 28
Character fonts 28
Continuous paper 28
Developer 28
Disposal containers 28
Drum kit 28
Toner 28
Vacuum cleaner 27
Learning courses, self-paced 140
Local Area Networks
Accessories 66-67
Cables 66-67

M.
Magazines
HP PC Communicator 139
Interex 139
Trade publications 139
Magnetic card reader 127
Magnetic tape 94
Auto load cartridges 94
Reels 95
Carrying case 95
Cleaning supplies 96
Desktop wire rack 95
Head alignment tape 95
Identification system 95
Labels 95
Sense markers 95
Manuals
Computer 141-142
Local Area Network 66
Mats
Antistatic 123
Sound absorbing 107
Media handling accessories 60
Memory
Boards/cards 132
Expansion boards,
LaserJet Series 23
Expansion kit 131
Modules 127
Memory (ROM)
Portable PLUS 133
Series 70 127
Microfloppy discs 84
Accessories 85-86
Cleaning supplies 96
MicroSpooler™ 154
Modems 152
Cables (see cables)
Internal 153
MICOM 9600 153
PORTABLE/Portable
PLUS 153
Touchscreen 153
Vectra PC 153

Mult. outlet strip 159
Multiplexers
Cables 79-80

O.
Optical wand 127
Organizers
DeskJet 34
ColorPro Plotter 49, 62
Plotter Pen 49, 60
7475A Plotter 50, 63
7550A Plotter 25, 49
Outlet strips 158
Overhead transparency
Accessories 26, 50, 56
Film 52

P.
Paper
Architectural plotter 53
Blank roll 51, 53
Glossy plotter 52
Impact printer 45
LaserJet printer 28
Non-glossy plotter 51
PaintJet printer 30
Thermal 47
ThinkJet printer 39
QuietJet printer 32
Paper tape 46
Paper trays for
LaserJet 2000 28
LaserJet/LaserJet 500/
LaserJet 500 Plus 26
LaserJet Series II 26
PC network 69
PC support
products 139, 152-153
Pens, plotter 54-58
Peripherals
Series 40 127
HP-IL 127
PORTABLE/Portable
PLUS 133
Series 100/200 35, 41, 62-63
Touchscreen 35, 41, 62-63
Vectra PC 35, 41, 62-63, 131
Personal Computer
(see Computer)
Plotter
HP 7440A 62
HP 7475A 63
HP 7550A supplies 49-61
HP 7600 supplies 12-13
Driver 51
Media 25, 51-53
Pen organizers 49, 60
Plotter
organizers 25, 49, 62-63
Supplies &
accessories 50-61
Plotter pens 55
Plotter sound enclosure 107
Plotter
stands 34, 49, 62-63, 119
Polyester film, drafting
plotter 53
Portable computer 127
Bar code 127
Portable PLUS-Desktop
Link 133
Power line conditioners 155
Power strips 158
Printers
2225 ThinkJet printers &
accessories 35-39

2227A QuietJet Plus &
supplies 36-39
2228A QuietJet &
supplies 36-39
2276A DeskJet printer
supplies 3, 32-34, 75
3630A PaintJet printer
supplies 2, 30-31
2603A Daisywheel &
supplies 41
82143A Thermal 113, 127
82162A Thermal 127
Ruggedwriter supplies 40, 43
Printer stands
. 5, 37-38, 40, 106, 119
Printer starter kits 36, 41
Print heads
DeskJet 32
Impact printer 46
InkJet Series Printers 32, 39
PaintJet Printer 30
Printout storage cabinets
Printwheels 46
Printwheel cleaning kit 42
Printwheel storage album 46
Programmable
calculators 126
Punch, VFU tape 46

Q.
QuietJet/QuietJet Plus
Printers (see printers)

R.
Rack, documentation
storage 143
Racks, wire
Disc cartridges 92-93
Magnetic tape 94
Ribbons 41, 44-45
ROMs
Portable PLUS 133
Ruler (wordprocessing) 41

S.
Security kits 124
Security locks 124
Self-paced courses 140
Services
Computer users groups 139
Helpline Call Certificates 153
HP Express 152
Software upgrade/
replacement 130, 139
Sheetfeeder accessory 40
Sheetfeeder paper tray 33, 46
Software (see Computer)
Software upgrades 130, 139
Solution books
Series 10 126
Series 40 127
Series 70 127
Sound enclosures 107
Stand, printer/plotter 119
Stand, printer/terminal 5, 38
Stand, Vectra 6
Static protection 122-123
Storage
Cabinets 114-116
Printout/Documentation 120
Rack, mag tape 95
Support programs
Helpline Call certificates 153

Switches (RS232)
ABC 3, 29, 154
Dual ABC 3, 29, 154
HP-IB ABC 29

T.
Tables
Design Plus System 100-103
Mobile 106
Workstation 99-115
Tape
Color/numbering kit 95
Digital cassettes 90
High-density data
cartridges 89
Mini data cartridges 90
Paper perforator 46
Reels, auto load magnetic 94
Reels, regular magnetic 94
Tape storage 95
Terminals & accessories
HP 700/22 147
HP 700/41 146
HP 700/43 146
HP 700/71 147, 149
HP 700/92 148
HP 700/94 148
Terminal bar code reader 132
Terminal furniture 5, 100-106
Test devices 151
Thermal paper 47
Thermal Printer 126
ThinkJet printers (see printers)
Tracing bond, plotter 53
Toner
Laser page printers 28
LaserJet 2000 28
LaserJet/LaserJet Plus 15
LaserJet Series II 15
Transporters
Flexible/microfloppy discs 88
Turntables
Display 119
Type font
Cartridge fonts (LaserJet
type) 17-20
DeskJet 33
Plug-in character style
(2934A) 43
Ruggedwriter 40
Soft fonts 20-21

V.
Vacuum cleaner 27
Vacuum cleaner bags 27
Vellum, drafting 53
VFU tape, punch/splicer 46

W.
Workstation furniture
CAD workstations
. 10-11, 99-115
Caster set 106, 109
Chairs 108-109
Copyholder 119
Mobile drawer unit 106
Mobile file unit 112
Mobile PC centre 112
PC workstation kit 110
Returns 105
Storage cabinets 114-116
Suspended drawer unit 106
Tables 104-105
Tasklight 105
Work surface extension 105

HP Series 10 Calculators

Accessories	129
HP-12C	
Calculators	126
Books	126
Accessories	126, 129
Manuals	134

HP 17B Calculator	
Books	134
Carrying case	129
Infrared printer	126
Printer case	126

HP 19B Calculator	
Books	134
Carrying case	129
Infrared printer	126
Printer case	126

HP 22S Calculator	
Accessories	129
Infrared printer	126
Printer case	126

HP 27S Calculator	
Books	134
Carrying case	126
Infrared printer	126
Printer case	126

HP 28S Calculator	
Books	134
Carrying case	128
Infrared printer	126
Printer case	126

HP 32S Calculator	
Accessories	129
Infrared printer	126
Printer case	126

HP 41CV/CX Advanced Programmable Calculator	
Accessories	127
Digital cassette drive	127
Extended memory module	127
HP-IL accessories and supplies	127
Infrared printer	126
Magnetic card reader	127
Manuals	127, 134
Optical wand	127
Peripherals	127
Software	127
Solution books	127
Thermal printer/plotter	127
ThinkJet printer	35

HP-97A Calculator	
Accessories	127
Thermal paper	47, 127

The PORTABLE (HP 110 Computer)/The Portable PLUS	
Accessories	133
Books	137
Cables	73-74
Carrying cases	121, 133
Extended I/O card	133
HP-IL Interface card (for Portable PLUS only)	133
HP PC Communicator	139
HP users' group	139
Manuals	141
Memory card (for Portable PLUS only)	133

Memory drawer (for Portable PLUS only)	133
Microfloppy discs & accessories	84, 86-88
Modems	152-153
Software upgrades	130
Software drawer (for Portable PLUS only)	133
ThinkJet printer	35

HP 120 Computer	
Books	135-137
Carrying case	121
HP users' group	139
Keyboard park	118
Microfloppy discs & accessories	84, 86-88

HP 125 Computer	
Anti-Glare Filter	117
Bar code reader	127
Books	135-137
Dust cover	120
HP users' group	139
Keyboard park	118
Microfloppy discs and accessories	84, 86-88
Thermal paper	47
ThinkJet printer	35

Touchscreen (HP 150 Computer)/Touchscreen II	
Accessories	132
Bar code reader	132
Books	135-137
Cables	8-9, 74
Carrying Case	121
Data cartridge	90
Dust covers	120
HP-HIL devices	132
HP users' group	139
IBM 3278 emulation accessory	132
Internal modem	153
Keyboard park	118
LAN cables	65-68
Manuals	141
Microfloppy discs & accessories	84, 86-88
Modems	152-153
Peripheral sharing	3, 29, 154
Plotters	62-63
RAM memory boards	132
Software	130
Software upgrades	130
Surge suppressors	158
Thermal paper	47
ThinkJet printer	35
Touchscreen-PORTABLE Link (Extended I/O accessory card)	132

Series 200 Model 16	
Books	135-137
Keyboard parks	118
Microfloppy discs & accessories	84, 86-88
Modems	152-153
Software upgrades	130
ThinkJet printer	35

Series 200 Models 217 & 237	
Cabinet	102
Modems	152-153
Software upgrades	130

Series 200 HP-UX Models 217, 220 & 236	
Modems	152-153
Software upgrades	130

HP 250 Computer	
Flexible discs & accessories	85-88
Modems	152-153
ThinkJet printer	35

HP 700 Series Terminals	
Cables	80
Dust covers	120
Stands	5, 118
Terminal-top printer stand	5

HP 1000 Computer	
Cables	8-9, 74
Flexible discs & accessories	85-88
Manuals	140
Mini-data cartridges	90
Modems	152-153
Power line conditioning	157

2225A/B/C/D/P ThinkJet Printer	
Accessories	37-39
Accessory kit	36
Cables	75
Carrying case	37, 121
Desktop stand	37
Dust cover	39, 120
Ink cartridges	36, 39
Mailing labels	38-39
Manual	141
Paper	39
Paper catcher	37, 39
Peripheral sharing	3, 29, 154
Printer stand	37, 39
Software	31, 35-39

2227A QuietJet Plus Printer	
Accessories	37, 39
Accessory kit	37
Cables	75
Dust cover	39, 120
Ink cartridges	36, 39
Paper	39
Paper catcher	37, 39
Peripheral sharing	3, 29, 154
Printer stand	37, 39
Software	31, 37-40, 137

2228A QuietJet Printer	
Accessories	37, 39
Cables	75
Dust cover	39, 120
Ink cartridges	6, 30-32, 36, 39
Paper	36
Paper catcher	39
Peripheral sharing	3, 29, 154
Printer stand	39
Software	31, 37-40, 137

2235 RuggedWriter 480 Printer	
Extra paper cassette trays	25
Font cartridge	40
Paper	45
Peripheral sharing	3, 29, 154

Printer stand/keyboard park	40
Ribbon	45
Sheetfeeder accessory	40
Software	23, 130

2276A DeskJet Printer	
Accessories	32-34
Cables	30
Dust cover	32
Ink cartridge	32
Organizer	34
Peripheral sharing	3, 29, 154
Plug-in fonts	3, 33
RAM cartridges	32
Soft font	32
Software	34, 130

2382A Terminal	
Cables	79, 80
Carrying case	121
Dust cover	120

2392A/94A Terminals	
Accessories	118-121
Peripheral sharing	3, 29, 154

2393A/97A Terminals	
Accessories	118-121

2563A/B Printer	
Paper	45
Ribbons	44

2601A/2602A Printer	
Cables	74-75
Paper	45
Paper tray	46
Peripheral sharing	3, 29, 154
Platen Cleaner Pak™	41, 46
Printwheels	42
Printwheel clean kit	42
Ribbons	44
Sound absorbing pad	107

2603A Daisywheel printer	
Cables	74-75
Printwheels	41
Ribbons	41
Start-up kit	41

2607A Printer	
Paper	45
Ribbons	44

2608A/S Printer	
Layout forms	46
Paper	45
Ribbons	44

2611A Printer	
Paper	45
Ribbons	44

2613A Printer	
Paper	45
Ribbons	44
Vacuum bags	46
VFU tape	46

2617A Printer	
Paper	45
Ribbons	44
VFU tape	46

2618A Printer	
Paper	45
Ribbons	44
VFU tape	46

Computer equipment reference (continued)

- 2619A Printer**
 - Paper 45
 - Ribbons 44
 - Vacuum bags 46
 - VFU tape 46
- 262X Terminal**
 - Anti-Glare Filter 117
 - Bar code reader 127
 - Cables 79-80
 - Connector kits 70
 - Dust cover 120
 - Keyboard park 118
 - Manuals 141
 - Thermal paper 47
- 2631A/B/G Printer**
 - Cables 74
 - Dust cover 120
 - Manuals 141
 - Paper 45
 - Replacement print head 46
 - Ribbons 45
 - Sound absorbing pad 107
- 2635A/B Printing Terminal**
 - Paper 45
 - Replacement print head 46
 - Ribbon 45
- 2639A Terminal**
 - Ribbon 45
- 264X Terminal**
 - Connector kit 70
 - Dust cover 120
 - Flexible discs & accessories 84, 86-88
 - Mini-data cartridges 89
 - Mini-data cartridge storage tray 7
- 2671A/G Printers**
 - Thermal paper 47
- 2673A/2674A Printers**
 - Thermal paper 47
- 2675A Terminal**
 - Thermal paper 47
- 2680A/2685A/2689A Printer**
 - Carrier 28
 - Continuous fanfold paper 28
 - Developer 28
 - Disposal containers 28
 - Drum kit 28
 - Paper 28
 - Splicing tape 28
 - Toner 28
 - Vacuum cleaner 27
- 2684 LaserJet 2000**
 - Font cartridges 17-19
 - Font organizer 25, 28
 - Paper cassette trays 28
 - Platen cleaner 41, 46
 - Soft fonts 20
 - Software 23, 130
 - Toner 28
 - Toner disposal boxes 28
- 2686 LaserJet Printer Family**
 - Accessories 21-26
 - Books 25, 132
 - Cables 75-77
 - Character font cartridges (for LaserJet only) 17-19
 - Font organizer 25, 28
 - Forward collator tray 26
 - Manuals 145
 - Paper trays 26
 - Peripheral sharing 29
- Platen cleaner 41, 46
- Printer driver 22-23
- Printer stand/cabinet 27
- Soft fonts 20-21
- Software 22-23, 130
- Toner 15
- 2687A Laser Printer**
 - Data binders 113
 - Accessories 28
- 2688A Laser Printer**
 - Data binders 113
 - HP-IB extenders 72
 - Accessories 28
- 2767A Printer**
 - Ribbons 45
- 2932/33/34A Dot matrix printers**
 - Paper 38
 - Plug-in character style cartridges 43
 - Print head 46
 - Ribbon cartridge 45
 - Software 2
- HP 3000 Computer**
 - Cables 73-80
 - Cabinet 102-103
 - Flexible discs & accessories 85-88, 97
 - HP users' group 139
 - Learning aids 140
 - Manuals 142
 - Mini-data cartridges 89
 - Modems 152-153
 - Power line conditioning 157
- 3075/76/77A Terminals**
 - Thermal paper 47
- 33440 LaserJet Series II**
 - Dust cover 120
 - Font cartridges 17-19
 - Font organizer 25, 28
 - Furniture 95-97, 101-103
 - Memory expansion boards 22
 - Paper trays 25
 - Sharing devices 3, 4
 - Soft fonts 20-21
 - Toner 15
 - Platen cleaner 41, 46
 - Software 22-23, 59, 130
- 35401A Tape Drive**
 - Data cartridge 89
 - Data cartridge tray 91
 - Magazine (cartridge) 89
- 3630A PaintJet Color Graphics Printer**
 - Desktop stand 31
 - Dust cover 31
 - Media 30
 - Print cartridges 30
- 45811A Vectra disc drive**
 - Flexible discs & accessories 84, 86-88
- 45812A Vectra disc drive**
 - Flexible discs & accessories 84, 86-88
- 48713A Vectra disc drive**
 - Flexible discs & accessories 84, 86-88
- 700 Series Terminals**
 - Cables 80
- Dust covers 120
- Stands 5, 118
- Terminal printer stand 5
- 7090A Plotter**
 - Carousel 61
 - Dust cover 120
 - Transparency plotter film 52
 - Transparency film kits 49
 - Paper 51-52
 - Paper and pen kit 49
 - Pen organizers 60
 - Pens 55-56
- 7220A/B/C/S/T Plotter**
 - Digitizing sight 61
 - Drafting pen boots 61
 - Dust cover 120
 - Media 53
 - Transparency film kits 49
 - Pen organizers 60
 - Pens 55, 58
 - Plotter points 58
- 7221A/B/C/S/T Plotter**
 - Digitizing sight 61
 - Drafting pen boots 61
 - Dust cover 120
 - Media 51-53
 - Transparency film kits 49
 - Paper and pen kit 49
 - Pen organizers 60
 - Pens 55, 58
 - Plotter points 58
- 7225A/B Plotter**
 - Carrying case 121
 - Digitizing sight 61
 - Media 51-53
 - Transparency film kits 49
 - Paper and pen kits 49
 - Pen organizers 60
 - Pens 55
- 7240A Plotter/Printer**
 - Carrying case 121
 - Digitizing sight 61
 - Thermal paper 47
 - Thermal print head 61
- 7245A/B Plotter/Printer**
 - Digitizing sight 61
 - Carrying case 121
 - Thermal paper 47
 - Thermal print head 61
- 7310A Printer**
 - Thermal paper 47
- 7440A/7475A Plotters**
 - Cables 74-79
 - Carrying cases 121
 - Cleaning supplies 61
 - Digitizing sight 61
 - Dust cover 120
 - Graphics organizers 49
 - Manuals 141
 - Media 48-49, 52-53
 - Paper and pen kits 49
 - Pen boots 61
 - Pen carousels 61
 - Pen organizers 60
 - Pens 55, 58
 - Peripheral sharing 29
 - Plotter driver 59
 - Plotter points (7475A only) 58
 - Sound enclosure 107
 - Transparency film kits 49
- 7470A Plotter**
 - Cables 74-79
 - Carrying case 121
 - Digitizing sight 61
 - Dust cover 120
 - Manuals 141
 - Media 53
 - Paper and pen kits 49
 - Pen organizers 60
 - Pens 55
 - Peripheral sharing 29
 - Sound enclosure 107
 - Transparency film kits 49
- 7550A Plotter**
 - Cables 69-75, 78-79
 - Catcher tray 60
 - Cleaning supplies 61
 - Digitizing sight 61
 - Dust covers 120
 - Graphics organizer 126
 - Loading tray 55
 - Manuals 141
 - Media 51-53
 - Media handling kit 60
 - Paper and pen kits 49
 - Pen carousel 58, 61
 - Pen organizers 60
 - Pens 55-58
 - Peripheral sharing 29
 - Plotter driver 59
 - Plotter points 58
 - Transparency film kit 49
- 7570A DraftPro Plotter**
 - Cables 74-79
 - Carousels 61
 - Pen organizers 60
 - Pens 55-58
 - Media 51-53
- 7580A Plotter**
 - Adapter 61
 - Cleaning supplies 61
 - Digitizing sights 61
 - Manuals 141
 - Media 51-52
 - Paper 51-52
 - Paper and pen kit 49
 - Pen boots 61
 - Pen carousel 61
 - Pen organizers 60
 - Pens 55-58
 - Plotter points 58
- 7585A Plotter**
 - Adapter 61
 - Cleaning Supplies 61
 - Digitizing sight 61
 - Manuals 141
 - Media 51-52
 - Paper and pen kits 49
 - Pen boots 61
 - Pen carousel 61
 - Pen organizers 60
 - Pens 55-58
 - Plotter points 58
- 7586 Plotter**
 - Adapter 61
 - Cleaning supplies 61
 - Digitizing sights 61
 - Media 47-49, 51-52
 - Paper and pen kit 49
 - Pen boots 61
 - Pen carousel 61
 - Pen organizers 60
 - Pens 55-58
 - Plotter points 58
 - Take-up cores 61

Computer equipment reference (continued)

7595/7596 DraftMaster I/II	Reel labels 94	9142A Tape drive	9877A Tape unit
Media 51-52	Tape storage 95	Data cartridges 89	Mini data cartridges 89
Media cutter 61	7978/79/80 Tape drives	Data cartridge tray 91	9885M/S Disc Drive
Pen boots 61	Cleaning accessories 97	9144A Tape drive	Flexible discs &
Pen carousel 61	Magnetic tape 94	Data cartridges 89	accessories 85-88
Pen organizers 60	Reel labels 94	Data cartridge tray 91	9895 Flex Disc Drive
Pens 55-58	Tape storage 95	9145A Disc drive	Flexible discs &
7600 Plotter	82143A Printer	Data cartridges 7	accessories 85-88
Accessories 12-13	Thermal paper 47	Data cartridge	9915A Computer
Media 12-13	82161A Digital cassette	accessories 7, 91	Mini data cartridges 90
Toner 12-13	drive	9153A/B Disc drive	HP Portable Vectra CS
Cleaning supplies 12-13	Mini-data cassettes 89	Microfloppy discs &	Personal Computer
7900A Disc drive	82162A Printer/Plotter	accessories 84, 86-88	1.44 Mb 3.5-in. disc 84
Disc cartridge 92-93	110 adapter/recharger 127	9807A Integral computer	Carrying Case 121
Disc rack 92-93	Battery pack 127	Carrying case 121	Vectra PC
7901A Disc drive	Power pack 127	Dust cover 120	Cables 8-9, 53, 69
Disc cartridge 92-93	Security cable 127	9810A Calculator	Carrying case 121
Disc rack 92-93	Thermal paper 47	Thermal paper 47	Disk/Tape interface
7905A Disc drive	8290X Disc drives	9815A/S Computer	accessory 131
Disc cartridge 92-93	Cleaning kit 96	Mini data cartridge 90	Dust cover 6, 120
Disc rack 92-93	Dust cover 120	Thermal paper 47	Flexible discs &
7906H/M/S Disc drive	Flexible discs &	9816A Computer	accessories 84-88
Disc cartridge 92-93	accessories 84, 86-88	(See Series 200)	HP-HIL Extension
Disc cartridge rack 92-93	82905A/B Printer	9820A Calculator	module 131
Service Manual 141	Desktop printer stand 119	Thermal paper 47	HP Mouse 131
7907A Disc drive	Dust cover 120	9821A Calculator	HP Touch 131
Removable disc	Paper 45	Tape cassette 90	Interface accessories 131
cartridge 92-93	Peripheral sharing 29	Thermal paper 47	Internal modem 153
7908A Winchester drive	Print head 46	9825A/B/S/T Computers	Keyboard parks 118
Data cartridges 89	Ribbons 45	Flexible discs &	Memory expansion
7911A Winchester drive	82906A Printer	accessories 85-88	cards 131
Data cartridges 89	Cables 74	Mini data cartridges 90	Memory expansion kit 131
7912A Winchester drive	Paper 45	Thermal paper 47	Modems 152-153
Data cartridges 89	Peripheral sharing 29	9830A/B Computers	Numeric co-processor 131
7914A Winchester drive	Print head 46	Digital cassette 90	Peripheral sharing
Data cartridges 89	Ribbons 45	9835A/B Computers	devices 29
7920H/M/S Disc drive	HP 9000 Computer	Cables 69	Plotters 62-63
Disc pack 92-93	Cables 8-9, 69	Mini data cartridges 90	Printers 35, 41
7925H/M/S Disc drive	CAD workstations 10, 11,	Thermal paper 47	Rack mount shelf kit 118
Disc pack 92-93	106	9836A Computer	Security lock 131
7935H Disc drive	Flexible discs &	Flexible discs &	Software 130
Removable media	accessories 84, 86-88	accessories 84, 86-88	Stand 5
module 92-93	Local area network	9845A/B/C/S/T Computer	Surge suppressors 158
7942A drive	cables 65-68	Cables 69	Tape cartridge 89
Data cartridges 89	Power line conditioning 157	Mini data cartridges 90	Workstation Furniture and
Data cartridge tray 89	Reference Manuals 142	Thermal paper 47	Accessories
7946A drive	Thermal paper 47	985A/B/C/S/T Computer	Cabinets 114-115
Data cartridges 89	9111A Graphics tablet	Cables 69	CAD mini-workstation
Data cartridge tray 89	Key overlays 61	Mini data cartridges 90 10-11, 103
7970 Tape drive	Stylus refills 61	Thermal paper 47	Casters 106
Cleaning accessories 89	9114A/B Disc drive	9865A Cassette drive	Corner turn 103, 106
Magnetic tape 94	Carry case 121	Digital cassette 90	Desktop door storage
Manuals 141	Dust cover 120	9866A/B Printer	unit 106
Reel labels 94	Microfloppy discs &	Thermal paper 47	Drawer units 103, 106
Tape storage 95	accessories 84, 86-88	9871A Printer	Ergonomic chairs 108-109
7971 Tape drive	Replacement battery 133	Paper 45	Filler panel kit 103
Cleaning accessories 96	9121S/D Dual disc drive	9872A/B/C/S/T Plotter	LaserJet Printer
Magnetic tape 94	Carry case 121	Digitizing sight 61	cabinet 22, 95, 101, 103
Reel labels 94	Dust cover 120	Dust cover 120	Library tape rack 115
Tape storage 95	Microfloppy discs &	Media 51-53	Mobile drawer units 103,
7974 Tape drive	accessories 84, 86-88	Transparency film kits 49	106
Cleaning accessories 96	9122S/D Disc drive	Paper and pen kit 49	PC Centre 112
Magnetic tape 94	MicroFloppy discs &	Pen organizers 60	Printer/terminal stand 106
Reel labels 94	accessories 84, 86-88	Pens 55, 58	Rail kit 103
Tape storage 95	9123D Disc drive	Plotter points 58	Stacking modules 110-111
7976 Tape drive	MicroFloppy discs &	Replacement boot 61	Storage module unit 106
Cleaning accessories 96	accessories 84, 86-88	9874A Digitizer	Storage shelves 106
Magnetic tape 94	9125/27A/35A Disc drive	Overlay 61	Tabletop connectors
Manuals 141	Flexible discs &	9875A Tape unit 103, 106
9133D/H/L Disc drive	accessories 84, 86-88	Mini data cartridges 90	Task light unit 105
Microfloppy discs &	9133D/H/L Disc drive	9876A Printer	Workstation
accessories 84, 86-88	Microfloppy discs &	Thermal paper 47	accessories 118-119
	accessories 84, 86-88		Workstation
			tables 103, 105-106

Product number listing of catalog items (continued)

17745T Multi-color fiber-tip transparency pens55	22707E HP Epson FX-80 emulation cartridge32	33411AC LaserJet soft font21	4114-0371 Blank VFU tape46
17746T Multi-color fiber-tip transparency pens55	22707K/L DeskJet cartridge fonts3	33411AD LaserJet soft font21	4114-1033 Overlay61
17747T Multi-color fiber-tip transparency pens55	22708A DeskJet soft font32	33411AE LaserJet soft font21	41CV Advanced programmable calculator127
17748T Multi-color fiber-tip transparency pens55	22832A Learning COBOL II/3000140	33411AF LaserJet soft font21	41CX Advanced programmable calculator127
17749T Multi-color fiber-tip transparency pens55	22832-93001 Learning COBOL II/3000 Student Workbook140	33411EA LaserJet soft font20	45411A Drawing Gallery130
17750T Multi-color fiber-tip transparency pens55	22833B Using HP Decision Support Graphics/3000140	33412AC LaserJet soft font21	45418A Executive MemoMaker130
17800P Non-glossy plotter paper51	22835B HP 3000: A Guided Tour140	33412AD LaserJet soft font21	45421A Executive CardManager/150130
17801P Non-glossy plotter paper51	22835-60001 Self-Paced Booklets140	33412AE LaserJet soft font21	45431A AdvanceLink130
17802P Non-glossy plotter paper51	22840B Using HPDRAW140	33412AF LaserJet soft font21	45437A Gallery Collection130
17803P Non-glossy plotter paper51	22842A Programming in Transact/3000140	33412AG LaserJet soft font21	45513A Charting Gallery130
17804P Non-glossy plotter paper51	22842-60001 Self-Paced Booklets140	33412DC LaserJet soft font20	
17805P Non-glossy plotter paper51	22843B Using Dictionary/3000140	33412EA LaserJet soft font20	
17806P Non-glossy plotter paper51	22843-60001 Self-Paced Booklets140	33412FA LaserJet soft font21	
17807P Non-glossy plotter paper51	22S Scientific calculator13	33412RB LaserJet soft font21	
17825P Fiber-tip paper pens55	22S Scientific calculator129	33412SA LaserJet soft font21	
17826P Fiber-tip paper pens55	24541B Dual RS-232/422 interface131	33412SB LaserJet soft font21	
17827P Fiber-tip paper pens55	24542D Centronics interface cable74-78	33412TA LaserJet soft font21	
17828P Fiber-tip paper pens55	24542G RS232C interface cable74-79	33412TB LaserJet soft font21	
17829P Fiber-tip paper pens55	24542H RS232C interface cable74-79	33412UA LaserJet soft font21	
17831P Fiber-tip paper pens55	24542M U.S./Euro modem cable74-76	33412UB LaserJet soft font21	
17832P Fiber-tip paper pens55	24550A Internal 1200 baud modem153	33413DC LaserJet soft font20	
17833P Fiber-tip paper pens55	26030A Bidirectional tractor feed mechanism41	33443B 1 Mb Memory Board22	
17835P Fiber-tip paper pens55	26030E Triple bin feeder41	33444B 2 Mb Memory Board22	
17837P Fiber-tip paper pens55	27546F AdvanceWrite PLUS130	33445B 4 Mb Memory Board22	
17839P Fiber-tip paper pens55	27S Scientific calculator128	35159A HelpLine call certificates153	
17841P Fiber-tip paper pens55	28641A ThinMAU cable68	35177M JetStart38, 130	
17842P Fiber-tip paper pens55	28S Advanced Scientific calculator128	35178A Carrying case121	
17843P Fiber-tip paper pens55		35178C ThinkJet carrying case39, 121	
17845P Multi-color fiber-tip paper pens55		35178D Carrying case121	
17846P Multi-color fiber-tip paper pens55		35179P Printworks23, 130	
17847P Multi-color fiber-tip paper pens55		35184A SIDEWAYS130	
17848P Multi-color fiber-tip paper pens55		35184B Plotstart130	
17849P Multi-color fiber-tip paper pens55		35184E DeskPlotter34, 130	
17850P Multi-color fiber-tip paper pens55		35188A LaserPlotter22, 130	
17855A RS422 interface cable78		35188D iPrint23, 130	
17900G Glossy plotter paper52		35190J LaserControl23, 130	
17901G Glossy plotter paper52		35190K/L WordPerfect3	
17902G Glossy plotter paper52		35190P JetPlotter31, 38-39, 130	
17903G Glossy plotter paper52		35190R MatrixPlotter2, 130	
17B Business calculator128		35199A HP Vectra PC rack-mount shelf118	
19B Business Consultant II calculator128		35723A HP Touch131	
2			
2225A/B/C/D/P ThinkJet printers35			
2227A/B QuietJet Plus printer35			
2228A QuietJet printer35			
22706A/B/C/D DeskJet cartridge fonts33			
22706E/F/G/H DeskJet cartridge fonts33			
22706J/M/P/Q DeskJet cartridge fonts33			
22707A DeskJet ram memory cartridge32			
22707E HP Epson FX-80 emulation cartridge32			
22707K/L DeskJet cartridge fonts3			
22708A DeskJet soft font32			
22832A Learning COBOL II/3000140			
22832-93001 Learning COBOL II/3000 Student Workbook140			
22833B Using HP Decision Support Graphics/3000140			
22835B HP 3000: A Guided Tour140			
22835-60001 Self-Paced Booklets140			
22840B Using HPDRAW140			
22842A Programming in Transact/3000140			
22842-60001 Self-Paced Booklets140			
22843B Using Dictionary/3000140			
22843-60001 Self-Paced Booklets140			
22S Scientific calculator13			
22S Scientific calculator129			
24541B Dual RS-232/422 interface131			
24542D Centronics interface cable74-78			
24542G RS232C interface cable74-79			
24542H RS232C interface cable74-79			
24542M U.S./Euro modem cable74-76			
24550A Internal 1200 baud modem153			
26030A Bidirectional tractor feed mechanism41			
26030E Triple bin feeder41			
27546F AdvanceWrite PLUS130			
27S Scientific calculator128			
28641A ThinMAU cable68			
28S Advanced Scientific calculator128			
3			
30062-60018 RS232C extension cable73			
30062-60022 HP 3000 cable80			
30062-60023 HP 3000 cable80			
30152-60001 RS232C extension cable73			
30241A LAN MAU & LAN coaxial cable tap67			
30241B Additional LAN coaxial cable tap67			
31391A RS232C extension cable73			
31391B RS232C extension cable73			
32120-90020 Learning HPWORD Part 1140			
32120-90021 Learning HPWORD Part 2140			
32S Scientific calculator13, 129			
33406A PCLPak22, 130			
33406B PCLPak22, 130			
33407B FontLoad22, 130			
33411AC LaserJet soft font21			
33411AD LaserJet soft font21			
33411AE LaserJet soft font21			
33411AF LaserJet soft font21			
33411EA LaserJet soft font20			
33412AC LaserJet soft font21			
33412AD LaserJet soft font21			
33412AE LaserJet soft font21			
33412AF LaserJet soft font21			
33412AG LaserJet soft font21			
33412DC LaserJet soft font20			
33412EA LaserJet soft font20			
33412FA LaserJet soft font21			
33412RB LaserJet soft font21			
33412SA LaserJet soft font21			
33412SB LaserJet soft font21			
33412TA LaserJet soft font21			
33412TB LaserJet soft font21			
33412UA LaserJet soft font21			
33412UB LaserJet soft font21			
33413DC LaserJet soft font20			
33443B 1 Mb Memory Board22			
33444B 2 Mb Memory Board22			
33445B 4 Mb Memory Board22			
35159A HelpLine call certificates153			
35177M JetStart38, 130			
35178A Carrying case121			
35178C ThinkJet carrying case39, 121			
35178D Carrying case121			
35179P Printworks23, 130			
35184A SIDEWAYS130			
35184B Plotstart130			
35184E DeskPlotter34, 130			
35188A LaserPlotter22, 130			
35188D iPrint23, 130			
35190J LaserControl23, 130			
35190K/L WordPerfect3			
35190P JetPlotter31, 38-39, 130			
35190R MatrixPlotter2, 130			
35199A HP Vectra PC rack-mount shelf118			
35723A HP Touch131			
4			
40210H HP-IB interface cable77-80			
40210P Centronics interface cable77-80			
40210R RS232C interface cable77-80			
40242C RS232C extension cable80			
40242D Centronics interface cable77-80			
40242G RS232C interface cable77-80			
40242M RS232C interface cable79-80			
40242P RS422 interface cable80			
40242R RGB video cable80			
40242V Composite video cable80			
40242X RS232C direct connect cable80			
40242Y RS232C interface cable80			
40242Z RS232C modem bypass cable80			
4114-0371 Blank VFU tape46			
4114-1033 Overlay61			
41CV Advanced programmable calculator127			
41CX Advanced programmable calculator127			
45411A Drawing Gallery130			
45418A Executive MemoMaker130			
45421A Executive CardManager/150130			
45431A AdvanceLink130			
45437A Gallery Collection130			
45513A Charting Gallery130			
45632A 384Kb RAM board132			
45640A Internal modem153			
45641B IBM 3278 emulation accessory132			
45643A Extended I/O Accessory card132-133			
45695A Terminator pair68			
45741A Video extension cable73			
45742A Video extension cable73			
45911A HP Graphics tablet131-132			
45914A HP-HIL Accessory card132			
45915A HP-HIL/384K RAM memory board132			
45973A 0.5M byte memory expansion card131			
45974A 1M byte memory expansion card131			
45986A Security lock131			
45989A Vectra floorstand6			
46020-60001 HP-HIL cable (92241A)131			
46060A HP Mouse131-132			
46080A HP-HIL extension module131			
46295A Ribbon cartridges45			
46296A Back-up power supply160			
46297A Office toolkit6			
5			
5061-1340 264X terminal connector kit70			
5061-2412 262X terminal connector kit70			
5061-3858 9-pin male RS232C connector kit70			
5061-5033 Rollerball drafting pens58			
5061-5034 Rollerball drafting pens58			
5061-5035 Rollerball drafting pens58			
5061-5036 Rollerball drafting pens58			
5061-5037 Multi-color rollerball drafting pens58			
5061-5080 Fiber-tip pen carousel61			
5061-7562 Vellum/paper disposable drafting pens57			
5061-7563 Vellum/paper disposable drafting pens57			
5061-7564 Vellum/paper disposable drafting pens57			

Product number listing of catalog items (continued)

5061-7565 Vellum/paper disposable drafting pens	57	51606C PaintJet color print cartridge	30	82037A Reserve power pack for 82162A	127	88014B Replacement battery	133
5061-7566 Multi-color disposable drafting pens	57	51608A DeskJet black print cartridge	32	82044A Security cable	127	88140LC Certified cartridges (16-track, 600-ft)	89
5061-7572 Vellum/paper disposable drafting pens	57	51630A Z-fold JetPaper	39	82045A Continuous roll thermal paper	47, 127	88140SC Certified cartridges (16-track, 150-ft)	89
5061-7573 Vellum/paper disposable drafting pens	57	51630B Z-fold wide JetPaper	39	82059D AC adapter/recharger	39, 127	88500A Disc/tape interface	131
5061-7574 Vellum/paper disposable drafting pens	57	51630C Z-fold JetPaper	39	82066B AC adapter/recharger (2225P)	39, 127	9	
5061-7575 Vellum/paper disposable drafting pens	57	51630D Z-fold wide JetPaper	39	82067B AC adapter/recharger (Euro 2225B)	39	9162-0027 Head alignment tape	95
5061-7576 Multi-color disposable drafting pens	57	51630E Z-fold wide JetPaper (Euro)	39	82068B AC adapter/recharger (Euro 2225P)	39	9162-0050 Individual digital cassettes	90
5061-7578 Reusable adapter pen cap assemblies	56, 61	51630H Z-fold wide JetPaper	39	82104A Magnetic card reader	127	9164-0105 Single-sided 8-in. discs	85
5061-7619 Vellum/paper disposable drafting pens	57	51630J Cut sheet JetPaper	39	82111A Soft case for card reader	127	92150D/E/F/P Magnetic tapes (on reels)	94
5061-7620 Vellum/paper disposable drafting pens	57	51630K Cut Sheet A4 size JetPaper	39	82120A Rechargeable battery pack	127	92150K Magnetic tape reel labels	95
5061-7635 Boots for fiber-tip & rollerball pen carousels	61	51630L InkJet labels	38-39	82153A Optical barcode reader	127	92150L Magnetic tape color/numbering kit	95
5061-7636 Boots for drafting pen carousels	61	51630P Z-fold PaintJet paper	30	82160A HP-IL interface module	127	92150M Magnetic tape sense markers	95
5062-0096 Boots for fiber-tip pen carousels	61	51630Q PaintJet transparency film	30	82161A Digital cassette drive	127	92150Q Ring seals for Easy Load II	95
5062-0097 Boots for drafting pen carousels	61	51630R Z-fold PaintJet paper A4	30	82162A HP-IL thermal printer/plotter	127	92150T Transport/carrying case	95
5062-0098 Boots for fiber-tip & rollerball pen carousels	61	51630S PaintJet transparency film A4	30	82164A HP-IL/RS 232C interface	127	92150X Magnetic tape take-up reels	95
5062-0099 Boots for drafting pen carousels	61	51630Y Cut sheet PaintJet paper A4	30	82165A HP-IL/GPIO interface	127	92151C/D/H Ribbon cartridges	44
5062-1515 Gritwheel brush	61	51630Z Cut sheet PaintJet paper A4	30	82166C HP-IL interface kit	127	92153A/B/C/D/E Metalized 2601A printwheels	42
5062-1556 Multi-width disposable drafting pens	57	5954-9907 Understanding UNIX	136	82167A HP-IL interface cable	72-79, 132	92153U/V/W Metalized 2601A printwheels	42
5062-1557 Multi-color disposable drafting pens	57	5955-7680 LAN Cable Installation manual	66	82167B HP-IL interface cable	72-79, 132	92154B Replacement print head	46
5062-1558 Multi-color disposable drafting pens	57	5955-7681 LAN Troubleshooting manual	66	82167D HP-IL interface cable	72-79, 132	92154G Replacement print head	46
5062-1559 Multi-color disposable drafting pens	57	5957-4622 Datacommunications	135	82169A HP-IL/HP-IB interface	127	92154N Print head	46
5062-1571 Multi-color disposable drafting pens	57	5957-4623 HP-to-IBM Communications	135	82172A Blank overlays	127	92154P Print head	46
5062-1572 Multi-color disposable drafting pens	57	5957-4624 LAN Connection	66, 135	82174A Vinyl replacement case	129	92155A/B Wide nylon ribbon	45
5062-1573 Multi-color disposable drafting pens	57	5957-6979 Steps to Effective Business Graphics	136	82175A Continuous roll thermal paper	47, 126-127	92155L Ribbon cartridges	45
5062-1576 Adjustable pen carousel	61	5957-8407 Word processing ruler	41	82176A Mini data cassettes	90, 127	92155M OCR ribbon cartridges	45
5062-1592 Polyester film disposable drafting pens	57	5958-0210 Binder and slip cover	143	82180A Extended functions/memory module	127	92156A Ribbon cartridges	45
5062-1593 Polyester film disposable drafting pens	57	5959-2208 HP Site Wire Twisted-Pair Cabling installation guide	9	82181A Extended memory module	127	92156S Continuous feed ribbon cartridge	44
5062-1594 Polyester film disposable drafting pens	57	6		82182A Time module	127	92157A Fanfold printer paper	45
5062-1595 Polyester film disposable drafting pens	57	68330F Executive MemoMaker	130	82183A Extended I/O module	127	92157B Fanfold 3-hole punched printer paper	45
5081-1191 Paper writing pens	61	68331F Executive CardManager	130	82199A Battery pack (2225B/P)	39	92157C Fanfold micro perforated printer paper	45
5081-1192 Paper writing pens	61	68333F AdvanceLink	130	82200A HP-41 touchpad	127	92157D Fanfold printer paper (Euro only)	45
5081-1193 Paper writing pens	61	68350F Charting Gallery	130	82240A Infrared printer	126	92157K/N/P LaserJet labels	24
51604A Jet series plain paper black print cartridge	36, 39	68351F Drawing Gallery	130	82241A AC adapter/recharger	39, 126	92157L Office paper	43
51605B/G/R Jet series color print cartridges	36, 39	68352F Gallery Collection	130	82241AB AC adapter/recharger (Euro 2225C)	39	92158A/M Impact printer ribbon cartridge	44
51606A PaintJet black print cartridge	30	7		82242A Infrared printer interface module	126	92160A/B Continuous roll thermal paper	47
		70210H HP-IB interface cable	78	82931A Continuous roll thermal paper	47	92160M/N Fanfold thermal paper pack	47
		7121-0988 Overlay	61	82954A Continuous roll thermal paper	47	92161E Page-perforated thermal paper	47
		7440A Graphics plotter (Opt 001/002)	62	82957A Centronics interface cable	77	92161N Continuous roll thermal paper	47
		7475A Graphics plotter (Opt 001/002)	63	82973A HP-IL Interface card	131, 133	92161P Continuous roll thermal paper	47
		8		82977A/B HP-IB right-angle cables	72	92161R Page-perforated thermal paper roll	47
		8120-1348 Power cord	71	82981A, 128K Memory drawer	133	92164A/B Small isolation regulators	157
		8120-1351 Power cord	71	82982A Software drawer	133	92165A/B/C Surge suppressor	158
		8120-1369 Power cord	71	82984A 128K Memory card	133		
		8120-1378 Power cord	71				
		8120-1689 Power cord	71				
		8120-2104 Power cord	71				
		82033A Battery pack for 82162A	127				

Product number listing of catalog items (continued)

92165R Surge protector	158	92177S Desktop calculator stand	126	92192X Double-sided 1.44 Mb 3.5-in. discs	84	92205W MicroSpooler 128	154
92166A HP Vectra PC keyboard park/printer stand	40, 118	92177T Short pen organizer	60	92193C Printwheel clean kit	46	92205Y HP-IB ABC switch	29, 154
92166C Swivel stand for HP 700 terminals	5	92177U Long pen organizer	60	92193D Printwheel clean kit refill	46	92206D Rigid disc rack	93
92166E Plotter sound enclosure	59, 107	92177V Personal pen organizer	60	92193E Disc head cleaning kit (1/4-in.)	97	92206T Magnetic tape rack	95
92167F Data cartridge storage tray	91	92177W Graphics organizer for ColorPro	49, 62	92193F Magnetic head cleaning solution	13, 96	92207A/C Anti-glare filters	117
92167L Data cartridge storage album	91	92177X Graphics organizer for 7475A	49, 63	92193G Cleaning gloves	13, 97	92208A Mobile PC Centre	112
92167M Storage binder for 98200A mini data cartridges	91	92177Z DeskJet organizer	34	92193H Magnetic head clean kit	96	92208E/F/G Ergonomic workstation/managerial chairs	109
92167N Binder inserts for 92167M storage binder	91	92178C 25-pin RS232C connector kit	70-71	92193I Disc head cleaning kit (5.25-in.)	97	92208H Replacement cylinder for 92208E/F/G chairs	109
92167V Printwheel storage album	46	92179A/B/C Cut-to-length cables	70	92193L Disc head cleaning kit (8-in.)	97	92208K Black armset for 92208E/F/G chairs	109
92167W Printwheel storage album	46	92179D/G/H Cut-to-length cables	70	92193M Master clean kit	96	92208L Caster set for chairs	109
92169A/B Leather cases for Series 10 calculators	129	92180A Toner for 2680/2689A	28	92193P Replenishment kit for 92193E tape clean kit	97	92208M/N/P Ergonomic executive chairs	109
92169D/E/F Leather cases for calculators	129	92180D Drum kit	28	92193T Platen cleaner pak	41, 46	92208Q Replacement cylinder for 92208M/N/P chairs	109
92169G/H/J Carrying case for infrared printer	126	92181A Disposal containers	28	92193V Video clean kit	117	92208S Ergonomic workbench chair	109
92169K/L/M Leather cases for 17B/27S calculators	129	92182A Bottle, carrier	28	92193W Lint-free wipes	13, 97	92208U Replacement cylinder for 92208S chair	109
92171A Clamp-on copy holder	119	92182D Developer	28	92193Y Compressed air cleaner	97	92210A Compact workstation table	105
92171B Easel copy holder	119	92183A Splicing tape	28	92194A Compact file for 5.25-in. discs	86	92210B Standard workstation table	105
92171C Keyboard drawer park	118	92184A Continuous fanfold paper	28	92194E FlexFiles for 5.25-in. discs	87	92210C Workstation table	105
92171E Footrest	119	92185A Toner for 2687A/2688A	28	92194F FlexFiles for 8-in. discs	87	92210CC Team workstation	104
92171G Printout paper catcher	46	92185D Ozone filters	28	92194G Portable album for 5.25-in. discs	87	92210D Workstation table	105
92171J Keyboard park	118	92185E OPC belts	28	92194H Portable album for 8-in. discs	87	92210E Work surface extension	105
92171L Locking bar (documentation storage rack)	143	92185T Input tray	28	92194I Roll-top file for 5.25-in. discs	86	92210F Desktop storage shelf	106
92171M Documentation storage rack	143	92188A/B/E/G/H/J/K/M/N/R/T 2934A software fonts	43	92194P Hanging file pages for 5.25-in. discs (U.S.)	88	92210H Printer/terminal stand	106
92171T Display turntable	119	92190A/L/N Double-sided 5.25-in. discs	84	92194Q Hanging file pages for 5.25-in. discs (Euro)	88	92210L Heavy-duty casters	106
92171X Terminal top ThinkJet stand	38-39	92190X High-capacity double-sided 5.25-in. discs	84	92195A Double-sided 8-in. discs	85	92210M Mobile drawer unit	106
92172F Data lock	124	92190Z Double-sided 5.25-in. discs	5, 84	92195P Hanging file pages for 5.25-in. discs (Euro)	88	92210P Printer stand	106
92172G Plate lock security kit	124	92191A Single-sided 3.5-in. discs	84	92199A/B Power cords	169	92210Q Suspended drawer unit	106
92172H Screw lock security kit	124	92191D Desktop file for 3.5-in. discs	86	92199C/D Cable covers	71	92210R Storage module unit	106
92174A/B/C/D Data binders	113	92191E FlexFiles for 3.5-in. discs	87	92199F Cable management kit	71	92210T Mobile workstation table	106
92174E/F/G/H/J/K Data binders	113	92191F Portable album for 3.5-in. discs	87	92203R Fixed-price repair charge (modern)	152	92210U CAD standard corner workstation	10, 106
92175A/B/C Static control mats	123	92191G Hanging file pages for 3.5-in. discs (Euro)	88	92203X HP Express Service	152	92210V Tabletop connector	106
92175E Vacuum bags/filter for 92175V	9, 127	92191H Library album for 3.5-in. discs	87	92204F Black Jack	163	92210W Task light unit	105
92175F Replacement stretch hose	9, 27	92191I Library album pages for 3.5-in. discs	87	92204J Micropatch (male to male)	151	92210Z Desktop storage unit	106
92175G Replacement cord	9, 27	92191L Library album pages for 3.5-in. discs	87	92204K Micropatch (male to female)	151	92211B Mobile LaserJet printer cabinet	27, 101-103
92175H Replacement crevice tool/brush	9, 27	92191M Micro carrying case for 3.5-in. discs	86	92204L Micropatch (female to female)	151	92211C Design Plus sound enclosure	103, 107
92175K Replacement rubber gooseneck	9, 27	92191P Hanging file pages for 3.5-in. discs (U.S.)	88	92204M Dalatracker	151	92211E Design Plus mobile mini-rack drawer unit	102-103
92175T Tabletop anti-static mat	123	92191Q Compact file for 3.5-in. discs	86	92204P Cable test adapter	151	92211F Design Plus mobile mini-rack drawer unit	102-103
92175V HP PM VAC	9, 27	92191R Roll-top file for 3.5-in. discs	86	92204Q Minitracker	151	92211G Design Plus mobile mini-rack drawer unit	102-103
92175W Filter for 92175V	9, 27	92191T Micro disc case for 3.5-in. discs	88	92204R Minitracker Plus	151	92211H Design Plus support cabinet	103
92176A/B/C/D Anti-static carpets	123	92192A Double-sided 3.5-in. discs	84	92204S Universal cable	151	92211I Design Plus small support cabinet	103
92176E Unlocking the LaserJet	25, 138	92192B Double-sided 3.5-in. discs	84	92204T Pulse tracker	151	92211N Design Plus drawer unit	101-103
92176S Anti-static spray	122	92192C Data cartridge storage tray	7, 91	92204U Additional miniclip leads	151	92211R Design Plus mini-rack system cabinet	101-103
92176W Anti-static wipes	122	92192R Labels for 92192N	84	92204X/Y/Z Adapters for LaserJet sharespool	4	92211S Rail kit (92211R)	103
92177B Sound absorbing pad	107	92192T Box of five pre-formatted, certified cartridges	7	92205A Hayes Smartmodem 1200	152	92211T Filler panel kit (92211R)	103
92177J Paper trays for 26010D	46			92205B Hayes Smartmodem 2400	152	92211U Bracket Kit	10
92177K/L/M/N Extra paper tray for 26010D	46			92205E/F ABC switches	3, 29, 154	92213B Design Plus CAD mini-workstation	101-103

Product number listing of catalog items (continued)

92213D "C and D" sized drawing holder	101-103	92220V Mastering WordPerfect	138	92235T 18C Training Guide	134	92261P QuietJet Accessory kit	37
92213F Design Plus CAD workstation	11	92220W Looking Good in Print	25, 138	92235U LaserJet Unlimited	25, 138	92261R Paper catcher for ThinkJet	37
92213Q Design Plus Desklamp	10	92221M U.S. modem cable	74	92236A 17B Easy Course	134	92261S Printer stand for ThinkJet	38-39
92213R Lamp clamp	10	92221P RS232C interface cable	74-79	92236B 19B Easy Course	134	92261T Printer stand for QuietJet Plus	39
92214A Design Plus table	103	92222A/B/C/D SCSI interface cables	81	92236C 27S Easy Course	134	92261U Printer stand for QuietJet	39
92214AA Design Plus One table	101-103	92224A HP 3000 ATP connector kit	70-71	92236D 28S Easy Course	134	92261X QuietJet Plus Accessory kit	37
92214BB Design Plus Two table	103	92224B HP 3000 ATP connector kit	70	92250R DeskJet dust cover	32	92262A/B/D ASCII printwheels	42
92214C Large Design Plus table	103	92224F/M Gender converters	72, 29	92250S Dust cover for ThinkJet	39	92262E/F/G ASCII printwheels	42
92214J Design Plus corner turn stand	101-103	92225A/B HP 3000 ATP connector kits	70	92250V Dust cover for QuietJet Plus printer	39, 120	92263A/B/C/D StarLAN cables	8, 69
92214K Design Plus CAD corner workstation	101-103	92226A HP-IB extender connector kit	70-71	92250W Dust cover for QuietJet printer	39, 120	92263J Modular wallplate for StarLAN 1/10	9
92214P Design Plus support stand	103	92227A/B/C/D Connected ThinLAN cable	68	92250Z PaintJet dust cover	31	92268M/N Unterminated StarLAN cables	8
92215A RS232C extension cable	73	92227E/F/G/H Connected ThinLAN cable	68	92251A/B/C/D Dust covers	120	92268P 6-pin modular plugs	8
92215F RS232C extension cable	73	92227J/K Cut-to-length ThinLAN cables	68	92251E/F Dust covers	120	92268S 6- to 8-pin cable adapter	8
92215T RS232C extension cable	73	92227L Crimp-on style BNC connectors	68	92251P/Q/R Dust covers	120	92268T StarLAN connector crimper tool	8
92218A RS232C interface cable	74-76	92227M ThinLAN tool kit	68	92252A/B/C/F/G Plastic 2601A printwheels	42	92269A Desktop printer/plotter stand	31, 119
92218B Euro modem cable	75-76	92227N ThinLAN tee connector insulating cover	68	92252H/J/K/L Plastic 2601A printwheels	42	92269B ThinkJet printer stand for HP 700 terminals	5
92218C RS232C interface cable	74, 78	92227P ThinLAN terminator pair (non-grounded)	68	92253A/B/C/D Thick backbone coax cable kits	66	92270A/C/D/E Printwheels for HP 2603A	41
92218D RS232C interface cable	74-75, 78	92227Q ThinLAN loopback	68	92253E/F/G/H Thick backbone coax cable kits	66	92270F/G/H/J Printwheels for HP 2603A	41
92219G RS232C extension cable	73	92227R ThinLAN insulating cover for tee connector	68	92253J N-connectors	66	92270K/Q/R Printwheels for HP 2603A	41
92219H RS232C interface cable	76	92229A Crimp tool for ATP connectors	71	92253K Barrel connectors & insulators	66	92271A Multistrike ribbon cartridge	44
92219J RS232C interface cable	77	92229B Crimp tool	66	92253L Terminators & insulators	66	92271B 2603 printer accessory kit	41
92219K Centronics interface cable	77	92229C Disc drive cable	75	92254A/B/C/D Cut-to-length AUI cables	67	92271E Continuous feed fabric ribbon cartridge	44
92219M RS232C interface cable	38, 77, 79	92230A Wide nylon ribbon	44-45	92254E/F/G/H Cut-to-length AUI cables	67	92272A/B/C Workstation storage cabinets	115-116
92219N RS232C interface cable	77, 79	92230B Chain train oil	46	92255A/B Cut-to-length AUI cables	67	92272D/E/F Workstation storage cabinets	115-116
92219Q Multiplexer modem	80	92230C Chain train oil refill	46	92255C AUI cable connector kit	67	92272G Hanger bar	116
92219R Multiplexer direct connect cable	80	92231A 12-channel VFU tape punch	46	92256A LAN coaxial cable installation kit	66	92272H Fixed shelf	116
92219S Multiplexer modem cable	80	92231B Paper perforator tape	46	92256C LAN MAU & tap installation tool kit	67	92272J Oak top for 92272A/B/C cabinets	116
92219T Multiplexer RJ-11 cable	80	92233A The HP-IL System	135	92256D AUI wallplate kit	67	92272K/L Data binder handles	113, 116
92219U RJ-11 to RS232C adapter plug	80	92233F HP-12C Quick Reference Guide	126, 134	92256E Surge protector	66	92272M/N Mobile file units	112
92219Z Centronics interface cable	35, 77	92233K Database Systems	137	92257B Loopback hood	67	92277A/B/C Power line conditioners	157
92220F Using 1-2-3	137	92233P Managing a Programming Project	136	92259A/B/C/D Dust covers	120	92277G/H/L Power line conditioners	157
92220G 1-2-3 Tips, Tricks and Traps	137	92233S Art of Programming Vol. I	136	92259C Dust cover for LaserJet/LaserJet Plus	25	92277Q/R/S/T Power line conditioners	157
92220H 1-2-3 Macro Library	137	92233T Art of Programming Vol. II	136	92259G Dust cover for LaserJet Series II	25, 120	92282A Toner for LaserJet 2000	28
92220J 1-2-3 for Scientists & Engineers	137	92233U Art of Programming—Vol. III	136	92259K Dust cover for the monochrome Vectra	6, 120	92282B Standard paper tray	28
92220K Pascal	135	92233V Computer Networks	135	92259L Dust cover for the EGA Vectra	6, 120	92282C Legal paper tray	28
92220L Pascal	135	92233W Database Systems	137	92259M Dust cover for the Vectra	120	92282D Ledger paper tray	28
92220N Managing Your Hard Disk	138	92234K Operating Systems	136	92261A Jet series black print cartridge	36, 39	92282E Executive paper tray	28
92220P dBase III PLUS Programmer's Reference Guide	137	92234N Lotus 1-2-3	137	92261D ThinkJet Accessory kit	36	92282F Metric A4 paper tray	28
92220Q Understanding dBase III PLUS	137	92234Q MS-DOS User's Guide	136	92261G Paper catcher for 92269A stand	31, 37, 39	92282G Metric A3 paper tray	28
92220R HP-IB right-angle cable	72	92234S 12C Easy Course	134	92261K Z-fold JetPaper	39	92282P Toner disposal boxes	28
92220S WordPerfect Desktop Companion	138	92234T 41C Easy Course	134	92261N Z-fold JetPaper	39	92285A Toner EP cartridge	15
92220T WordPerfect Tips, Tricks and Traps	138	92234W 11C/15C Easy Course	134			92285B/C/D/E Paper trays	26
		92234X The RS-232C Solution	135			92285F Forward collator	26
		92235N The HP 110 Portable: Power to Go!	138			92285G Toner EP cartridge	15

Product number listing of catalog items (continued)

92285J Overhead transparency film	24	9260-0742 Plotter point for refillable drafting pens	58	9280-0733 Vellum	53	9300-0767 Lint-free plastic swabs	97
92285K/L/M/W LaserJet labels	24	9260-0743 Plotter point for refillable drafting pens	58	9280-0734 Non-glossy plotter paper	51	9300-0955 Plotter point for refillable drafting pens	58
92285P Font organizer	25, 28	9260-0744 Plotter point for refillable drafting pens	58	9280-0748 Architectural plotter media	53	9300-0956 Plotter point for refillable drafting pens	58
92285Q Output tray	26	9270-0479 Continuous roll thermal paper	47	9280-0749 Architectural plotter media	53	9300-0957 Plotter point for refillable drafting pens	58
92285R Auxiliary tray	26	9270-0488 Continuous roll thermal paper	47	9280-0750 Architectural plotter media	53	9300-0958 Plotter point for refillable drafting pens	58
92285S Manual input tray	26	9270-0605 Page-perforated thermal paper	47	9280-0751 Architectural plotter media	51	9300-0959 Plotter point for refillable drafting pens	58
92285T Service kit	26	9270-0607 Page-perforated thermal paper	47	9280-0752 Architectural plotter media	51	9300-0960 Plotter point for refillable drafting pens	58
92286A/C/E LaserJet cartridge font	17	9270-0640 Fanfold thermal paper	47	9280-0753 Architectural plotter media	53	9300-0967 Boots for short-body drafting pens	61
92286B LaserJet cartridge font	18	9270-0642 Fanfold thermal pack	47	9280-0754 Architectural plotter media	51	9300-1068 Take-up core 24"	61
92286D LaserJet cartridge font	18	9270-0664 Continuous roll thermal paper	47	9280-0755 Architectural plotter media	53	9300-1069 Take-up core 36"	61
92286F LaserJet cartridge font	18-19	9270-0680 Continuous roll thermal paper (metric)	47	9280-0756 Architectural plotter media	53	9320-1515 132-column printer paper	46
92286G LaserJet cartridge font	19	9270-0682 Continuous roll thermal paper (U.S.)	47	9280-0757 Architectural plotter media	53	97082-90002 Pascal	135
92286H LaserJet cartridge font	19	9280-0218 80-column printer paper	46	9280-0758 Architectural plotter media	53	97907A 20.5 Mb removable disc cartridge	93
92286J LaserJet cartridge font	20	9280-0525 Polyester film	53	9280-0759 Architectural plotter media	51	97935A 404 Mb disc pack	93
92286K LaserJet cartridge font	20	9280-0526 Polyester film	53	9281-0401 Continuous roll thermal paper	47	98200A Mini data cartridges	90
92286L/N/Q LaserJet cartridge fonts	17	9280-0527 Non-glossy plotter paper	51	9282-0069 Documentation binder	143	9940-4192 Documentation binder	143
92286M LaserJet cartridge font	18	9280-0528 Non-glossy plotter paper	51	9282-0520 Documentation binder	143	9940-4196 Documentation binder	143
92286P LaserJet cartridge font	18	9280-0529 Vellum	53	9282-0531 Nylon ribbon	44	9940-4622 Documentation binder	143
92286R LaserJet cartridge font	19	9280-0530 Vellum	53	9282-0545 Wide nylon ribbon	44		
92286S2 LaserJet cartridge font	18	9280-0587 Non-glossy plotter paper	51	9282-0905 Cleaning syringe	61		
92286T LaserJet cartridge font	20	9280-0590 Non-glossy plotter paper	51	9282-0908 Cleaning solution	61		
92286U LaserJet cartridge font	19	9280-0591 Polyester film	53	9282-1077 Documentation binder	143		
92286V LaserJet cartridge font	19	9280-0592 Polyester film	53	9282-1078 Documentation binder	143		
92286W1 LaserJet cartridge font	18	9280-0593 Vellum	53	9282-1079 Documentation binder	143		
92286X LaserJet cartridge font	19	9280-0594 Vellum	53	9282-1080 Documentation binder	143		
92286Y LaserJet cartridge font	17	9280-0597 Tracing bond	53	9282-1081 Documentation binder	143		
92286Z LaserJet Microsoft font	16, 18	9280-0598 Tracing bond	53	9282-1082 Documentation binder	143		
92287B/C/D/E Paper trays	26	9280-0599 Tracing bond	53	9282-1083 Documentation binder	143		
92290S1 LaserJet cartridge font	17	9280-0600 Tracing bond	53	9282-1085 Documentation binder	143		
92295A Toner EP cartridge	15	9280-0601 Vellum	53	9282-1086 Documentation binder	143		
92295B/C/D/E Paper trays	26	9280-0602 Vellum	53	9282-1087 Documentation binder	143		
92295F LaserJet Series II tray	25	9280-0603 Vellum	53	92836-90005 Fortran	135		
92295R Replacement top cover for 92295B/E	26	9280-0604 Vellum	53	92915A Barcode reader for Touchscreen	132		
92295S Replacement top cover for 92295C	26	9280-0605 Polyester film	53	92916A Barcode reader for Touchscreen II	132		
92299A MicroManager floor unit	110	9280-0606 Polyester film	53	9300-0427 Wide nylon ribbon swabs	97		
92299B MicroManager standard module	110	9280-0607 Polyester film	53	9300-0750 Package of 3 vacuum bags	46		
92299C MicroManager pull-out shelf module	110	9280-0608 Polyester film	53				
92299D MicroManager keyboard drawer module	110	9280-0618 Blank roll paper	61				
92299E MicroManager compact PC workstation kit	110	9280-0619 Blank roll paper	61				
92299F MicroManager workstation kit	110	9280-0633 Polyester film	53				
92299G MicroManager mobile plotter station	111	9280-0634 Polyester film	53				
92299J MicroManager side tray	111	9280-0635 Vellum	53				
92299K MicroManager copy holder	111	9280-0636 Vellum	53				
92299L MicroManager paper refold guide	111	9280-0637 Blank roll paper	51				
92299M MicroManager paper catcher basket	111	9280-0638 Blank roll paper	51				
9260-0579 Plotter point for refillable drafting pens	58	9280-0705 72-column printer paper	45				
9260-0588 Plotter point for refillable drafting pens	58	9280-0728 Non-glossy plotter paper	51				
9260-0596 Black drafting ink	61	9280-0730 Polyester film	53				
9260-0741 Plotter point for refillable drafting pens	58	9280-0731 Vellum	53				
		9280-0732 Polyester film	53				

C

C1001A HP 700/92 amber display terminal (Opt ABA)	148
C1001G HP 700/92 green display terminal (Opt ABA)	148
C1001W HP 700/92 white display terminal (Opt ABA)	148
C1002A HP 700/94 amber display terminal (Opt ABA)	148
C1002G HP 700/94 green display terminal (Opt ABA)	148
C1002W HP 700/94 white display terminal (Opt ABA)	148
C1003A HP 700/41 amber terminal (Opt ABA)	146
C1003G HP 700/41 green terminal (Opt ABA)	146
C1004A HP 700/22 amber terminal (Opt ABA)	147
C1004G HP 700/22 green terminal (Opt ABA)	147
C1004W HP 700/22 white terminal (Opt ABA)	147
C1005A HP 700/71 amber display terminals (Opt 500-503)	147
C1005G HP 700/71 green display terminals (Opt 500-503)	147
C1005W HP 700/71 white display terminal	147
C1006A HP 700/43 amber terminal (opt ABA)	146
C1006G HP 700/43 green terminal (opt ABA)	146
C1006W HP 700/43 white terminal (opt ABA)	146

You could win an HP-19B Business Consultant II calculator just by filling out a card!

You could win two ways!

1

You immediately qualify to win an HP-19B Business Consultant II calculator—the hot new calculator that offers built-in formulas for solving business problems.

2

You're automatically put on a mailing list that will keep you informed about the latest products and services from HP DIRECT. The information you provide on the card helps us to serve you better.

It's that simple! Winners are drawn monthly from all cards received until June 30, 1989. The sooner you send us the card, the better your chances of winning an HP-19B Business Consultant II are—but we need to hear from you!

Don't wait another minute! Fill out the subscription card between pages 96 and 97, and mail it today!

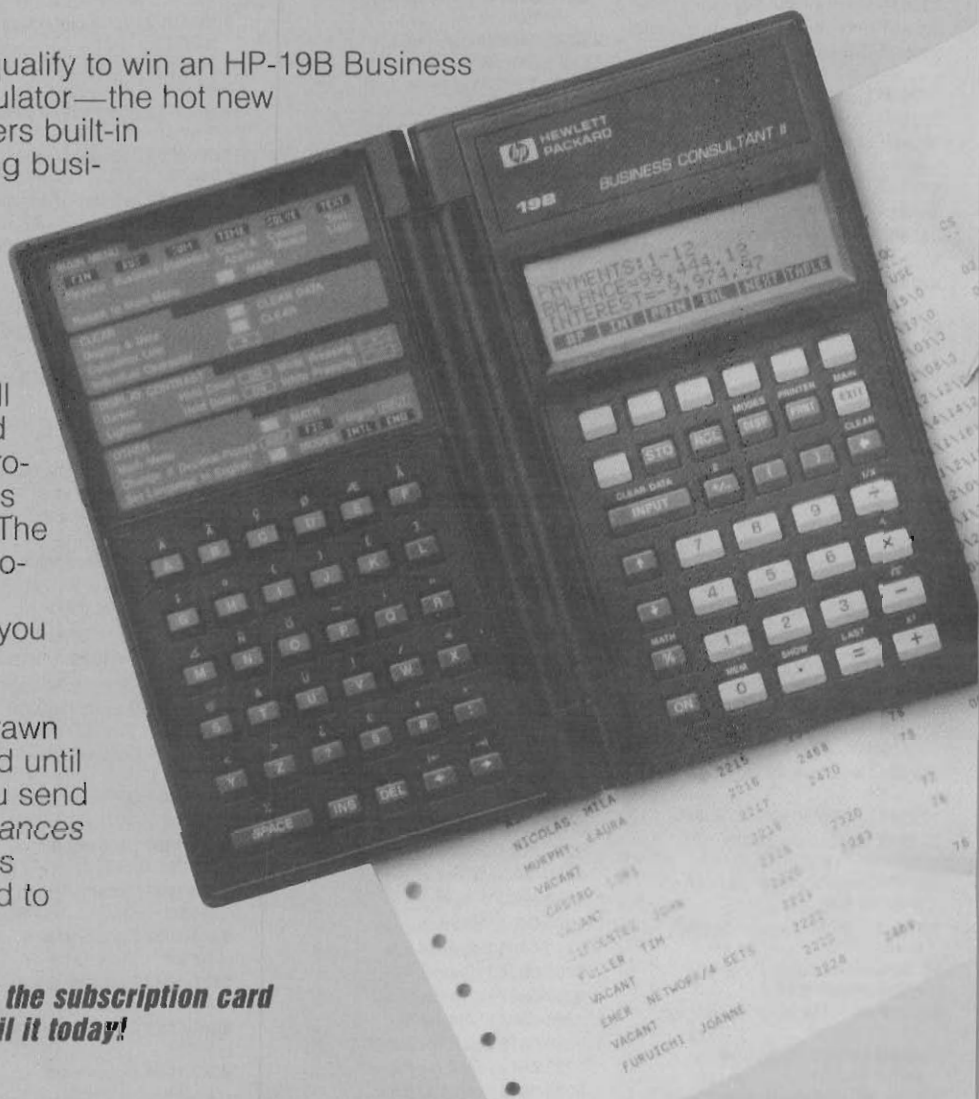

The HP-19B Consultant II Calculator

The edge you need in business or the classroom to solve custom equations without programming.

Sophisticated analysis and diverse business problems are a breeze with the HP Business Consultant II. It's the ultimate calculator for the business professional or student. The HP-19B possesses the most comprehensive set of business and financial functions and graphics found in any calculator. Histograms, scatter diagrams, curve fits for statistics, forecasting

and cash flow graphics were never easier to access. And to top it off you receive all the classic features of HP calculators like menus, softkeys for quick function selection for convenient cordless operation with HP's 82240A Infrared Printer. See page 128 for more details!

HP Business Consultant II \$175.00 ea.

Q:

How are smart people using their LaserJet printer?

A:

Every way they can.

On the screen in business presentations

With HP LaserJet Film, words or graphics generated from your word-processing, spreadsheet or graphics applications are ready for overhead projection in seconds. This film was designed expressly for the operating temperature of your LaserJet, so it won't jam, melt or yellow.



In their valuable Rolodexes

The Rolodex is everyone's business bible of important contacts used everyday. HP LaserJet Labels print up crisp and dark and affix easily to Rolodex cards. And when it's time to update those addresses and phone numbers just input the new information and run a new batch of labels. It's that simple to keep your Rolodex neat, orderly and easy-to-read.



On envelopes for mass mailings

Mass mailings used to mean hours of typing...or worse yet, hours of addressing envelopes by hand. No more! With HP LaserJet Labels, you print hundreds of addresses in moments, for pressure-sensitive application to envelopes of any size.



On important packages from Peru to Princeton

The last thing anyone wants to worry about when mailing a package is whether the label will fall off. That's why HP LaserJet labels are made to withstand the high-heat or moisture of any weather condition. There's no danger of glue melting so there's no danger of losing your label.



Are your supplies where you want, when you want them?



7475A graphics organizer features an easy-access drawer with convenient slots for carousels, paper, pens and other supplies. (Supplies shown in photo are not included.)

HP plotter users: Say goodbye to desktop plotter clutter with HP's Graphics Organizer.

Space-saving. Using your Graphics Organizer as a stand for your 7550, 7475A, or ColorPro Plotter gives you convenient drawer space underneath, so plotter supplies stay out of sight until needed. Lined with a cushion of high-density foam, the easy-access drawer has specially sized compartments to separate and protect supplies.

Everything in place. The specially designed media compartment keeps your standard paper, glossy plotter paper, and transparency film ready for use. Additional compartments hold your pens and carousels. There's even room for odds and ends—pencils, paper clips, scratch pads, etc.

HP's Graphics Organizer is constructed of tough acrylic plastic, in translucent gray to complement your HP plotter.

92177X 7475A Graphics Organizer. Exterior dimensions: 95 H x 597 W x 375 D mm (3.75 H x 23.5 W x 14.75 D in.) \$179.00 ea.

92177W ColorPro Graphics Organizer. Exterior dimensions: 95 H x 476 W x 349 D mm (3.75 H x 18.75 W x 13.75 D in.) \$119.00 ea.

92177Y 7550A Graphics Organizer. Exterior dimensions: 157 H x 673 W x 456 D mm (6.19 H x 26.50 W x 17.94 D in.) \$229.00 ea.



See our whole host of
plotter supplies on pages 48-63.



“Through our relationship with Hewlett-Packard, the San Francisco Symphony is now able to perform a computerized performing arts administration. Our HP systems provide us with capabilities which were only dreams and fantasies a few years ago.”

D. Zumbach

IMPORTANT! Please reference
this priority number for quick service.

hp HEWLETT
PACKARD
P.O. Box 3640
Sunnyvale, California
94088-3640

ADDRESS CORRECTION REQUESTED

BULK RATE
U.S. POSTAGE
PAID
HEWLETT-PACKAR

C380