

Service Handbook

**HP Apollo 9000 Series 700
Model 735 Workstations**

This is an unreleased, corrected version of
Order No. A2095-90602,
produced for online access.
O0893

[Click to go to the Table of Contents](#)



Hewlett-Packard Company
300 Apollo Dr., Chelmsford, MA 01824

NOTICE

The information contained in this document is subject to change without notice.

HEWLETT-PACKARD MAKES NO WARRANTY OF ANY KIND WITH REGARD TO THIS MANUAL, INCLUDING, BUT NOT LIMITED TO, THE IMPLIED WARRANTIES OF MERCHANTABILITY AND FITNESS FOR A PARTICULAR PURPOSE. Hewlett-Packard shall not be liable for errors contained herein or direct, indirect, special, incidental or consequential damages in connection with the furnishing performance or use of this material.

WARRANTY

A copy of the specific warranty terms applicable to your Hewlett-Packard product and replacement parts can be obtained from your local Sales and Service Office.

Copyright © Hewlett-Packard Company 1992

This document contains information which is protected by copyright. All rights are reserved. Reproduction, adaptation, or translation without prior written permission is prohibited, except as allowed under the copyright laws.

Restricted Right Legend

Use, duplication or disclosure by the U.S. Government Department of Defense is subject to restrictions as set forth in paragraph (b)(3)(ii) of the Rights in Technical Data and Software clause in FAR 52.227-7013.

Copyright © AT & T, Inc. 1980, 1984

Copyright © The Regents of the University of California 1979, 1980, 1983

This software and documentation is based in part on the Fourth Berkeley Software Distribution under licence from the Regents of the University of California.

Printing History

New Editions of this manual incorporate all material updated since the previous edition. Update packages may be issued between editions and contain replacement and additional pages to be merged into the manual by the user.

The manual printing date and part number indicate its current edition. The printing date changes when a new edition is printed. (Minor corrections and updates which are incorporated at reprint do not cause the date to change.) The manual part number changes when extensive technical changes are incorporated.

Edition 1 Original service handbook for Model 735

Emissions Regulations

Federal Communications Commission (FCC)

The Federal Communications Commission of the U.S. government regulates the radio frequency energy emanated by computing devices through published regulations. These regulations specify the limits of radio frequency emission to protect radio and television reception. All HP Apollo nodes and peripherals have been tested and comply with these limits. The FCC regulations also require that computing devices used in the U.S. display the agency's label and that the related documentation include the following statement:

WARNING: This equipment has been tested and found to comply with the limits for a Class A digital device, pursuant to part 15 of the FCC rules. These limits are designed to provide reasonable protection against harmful interference when the equipment is operated in a commercial environment. This equipment generates, uses, and can radiate radio frequency energy and, if not installed and used in accordance with the instruction manual, may cause harmful interference to radio communications. Operation of this equipment in a residential area is likely to cause harmful interference in which case the user will be required to correct the interference at his own expense.

Compliance to these regulations requires the use of shielded cables.

Canadian Department of Communications (DOC)

This digital apparatus does not exceed the Class A limits for radio noise emissions from digital apparatus as set out in the Radio Interference Requirements of the Canadian Department of Communications.

Compliance to these regulations requires the use of shielded cables.

Emissions Regulations Compliance

Any third-party I/O device installed in HP Apollo system(s) must be in accordance with the requirements set forth in the preceding Emissions Regulations statements. In the event that a third-party noncompliant I/O device is installed, the customer assumes all responsibility and liability arising therefrom.

Compliance to these regulations requires the use of shielded cables.

DECLARATION OF CONFORMITY
according to ISO/IEC Guide 22 and EN 45014

Manufacturer's Name:
Manufacturer's Addresses:

Hewlett-Packard
100 Domain Drive
Exeter, N.H. U.S.A.

declares, that the product

Product : Computer Workstation

Model Number: 735

Product Number: A1946A

conforms to the following Product Specifications:

Safety: IEC 950:1986 / EN60950 (1988)

EMC: CISPR 22:1985 / EN 55022 (1988) Class A

IEC 801-2:1991 / pr EN55101-2 (1990): 3 kV CD, 8 kV AD

IEC 801-3:1984 / pr EN55024-3 (1991): 3 V/m

Supplementary Information: The product was tested in a typical Hewlett-Packard Workstation configuration.

Exeter, Date Nov. 12, 1992



James H. Kelly
Division Quality Manager

European Contact: Your local Hewlett-Packard Sales and Service Office or Hewlett-Packard GmbH, Department ZQ/Standards Europe, Herrenberger 130, D-7030 Boeblingen (FAX: +49-7031-141623)

This is a Class A product. In a domestic environment this product may cause radio interference in which case the user may be required to take adequate measures.

VCCI Class 1 ITE Equipment

この装置は、第一種情報装置（商工業地域において使用されるべき情報装置）で商工業地域での電波障害防止を目的とした情報処理装置等電波障害自主規制協議会（VCCI）基準に適合しております。

従って、住宅地域またはその隣接した地域で使用すると、ラジオ、テレビジョン受信機等に受信障害を与えることがあります。

取扱説明書に従って正しい取り扱いをして下さい。

VCCI基準に適合する為に、シールドされたケーブルをご使用下さい。

Electrostatic Discharge (ESD) Precautions

Electrostatic charges can damage the integrated circuits on printed circuit boards. To prevent such damage from occurring, observe the following precautions when unpacking and installing the board.

- Stand on a static-free mat.
- Wear a static strap to ensure that any accumulated electrostatic charge discharges from your body to ground.
- Connect all equipment together, including the static-free mat, static straps, routing nodes, and peripheral units.
- Keep uninstalled printed circuit boards in their protective antistatic bags.
- Once you have removed the printed circuit boards from their protective antistatic bags, handle them by their edges.

Table of Contents

Product Information	1
Product Description	1-2
System Unit Controls	1-3
Power Switch	1-4
Power LED	1-4
TOC Switch	1-4
Service/Normal Mode Switch	1-4
Understanding the LEDs	1-5
System Unit Rear Panel Connectors	1-7
System I/O Connectors	1-8
HP-HIL connector	1-8
HP Parallel I/O connector	1-8
Network connectors	1-8
RS-232 Serial Input/Output connectors	1-9
Audio connectors	1-10
SCSI I/O Connectors	1-11
Graphic I/O Connector	1-12
EISA I/O Connector	1-12
Monitor Controls, Connectors, and Indicators	1-13
Environmental/Installation/PM	2
Environmental Specifications	2-1
Regulatory Requirements	2-2
Installation	2-2
Preventive Maintenance	2-2
Configuration	3
Workstation and System Unit Configurations	3-1
FRU Configurations	3-1
Mass Storage Configurations	3-1
Installing Additional Memory	3-12

Troubleshooting	4
LED Error Codes	4-2
Dealing with a Boot Failure	4-12
Boot Administration Environment	4-13
Stable Storage	4-14
Boot Command Notations	4-15
Supported Boot Paths	4-15
Invoking the ISL Environment from a SCSI Device ...	4-15
ISL Environment	4-17
ISL User Commands	4-17
Running the Disk-Based ISL Diagnostics	4-18
Verifying the System Operation with SupportWave	4-19
Field Replaceable Units	5
Pedestal Feet	5-4
Top Cover	5-5
Power Supply	5-7
Backplane/Fan Assembly	5-8
Disk Drives	5-10
Core I/O and Processor Board	5-12
System EEPROM	5-13
Memory	5-14
Calendar Battery	5-16
LAN Slider Module	5-17
Graphics Board	5-18
Front Control Panel	5-19
Diagrams	6
Reference	7
Installation Manual	7-1
Service Manuals	7-1
Reference Manuals	7-1
Service Notes	8

Figures

1-1	Power Switch Location	1-3
1-2	TOC and Service/Normal Mode Switch Locations ..	1-4
1-3	System LEDs	1-5
1-4	Troubleshooting System LEDs	1-6
1-5	Model 735 Rear Panel Connectors	1-7
1-6	Audio Connectors	1-10
1-7	19-Inch, Color Monitor (Model A2094)	1-14
1-8	19-Inch, Grayscale Monitor (Model A2088A) ...	1-15
3-1	Default SCSI IDs	3-2
3-2	Quantum 210-MB Winchester Drive Jumpers	3-3
3-3	Hewlett-Packard 420-MB Winchester Drive Jumpers (Early Model)	3-4
3-4	Hewlett-Packard 420-MB Winchester Drive Jumpers (Late Model)	3-5
3-5	Quantum 525-MB Winchester Drive Jumpers	3-6
3-6	Seagate 525-MB Winchester Drive Jumpers	3-7
3-7	Hewlett-Packard 1-GB Winchester Drive Jumpers (Single-Ended)	3-8
3-8	Micropolis 1-GB Winchester Drive Jumpers (Single-Ended)	3-9
3-9	Hewlett-Packard 1-GB Winchester Drive Jumpers (Fast/Wide)	3-10
3-10	Floppy Address Jumper Settings	3-11
3-11	Installing Memory Cards	3-13
4-1	Front Panel LEDs	4-2
5-1	Removing Pedestal Feet	5-4
5-2	Removing Top Cover Screws	5-5
5-3	Lifting Top Cover	5-6
5-4	Removing the Power Supply	5-7
5-5	Backplane/Fan Removal	5-8
5-6	Removing the Fans and Backplane Assembly	5-9
5-7	Removing the First Disk Drive	5-10
5-8	Mounting the Disk Drive Assembly on the Disk Tray	5-11
5-9	Connecting Cables to the Disk	5-11
5-10	Removing the Core I/O and Processor Boards	5-12
5-11	Component Locations	5-13
5-12	Removing Memory Boards	5-14

5-13	Removing the Calendar Battery	5-16
5-14	LAN Slider Module Removal	5-17
5-15	Removing the Front Control Panel	5-19
6-1	System Unit Functional Block Diagram	6-2

Tables

1-1	LED Display During Normal System Activity	1-6
1-2	Serial I/O Pins	1-9
2-1	Environmental Specifications for Model 735 SPU ..	2-1
4-1	Selftest LED Codes	4-3
4-2	PDC LED Codes	4-7
4-3	ISL LED Codes	4-9
4-4	HP-UX Kernel LED Codes	4-11
5-1	FRU List	5-2

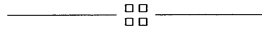

Product Information

1

This chapter introduces the HP Apollo 9000 Series 700 Model 735 workstation. Its purpose is to familiarize you with the workstation and its controls and indicators. Included in this chapter are the following topics:

- Product description
- System unit controls
- Understanding the LEDs
- System unit rear panel connectors
- Monitor controls, connectors, and indicators

Product Description

The Model 735 is a high-performance, PA-RISC-based workstation that is designed to run the HP-UX operating system.

The Model 735 workstation houses up to two internal mass storage devices connected to one of two internal SCSI interfaces: *single-ended* or *fast/wide*. With the single-ended interface, the workstations have their first hard disk drive bay fitted with either a 525-MB or 1-GB hard disk drive. The second disk bay may be fitted with either a 3.5-inch floppy drive or a 525-MB or 1-GB hard disk drive. With the fast/wide interface, the workstations have their hard disk drive bays fitted with either one or two 1-GB hard disk drives. Hard disk drives are pre-formatted. (The 1-GB drives are not interchangeable between single-ended and fast/wide interfaces.)

The Model 735 workstation contain the following key features:

- Operating Systems Native HP-UX
- Compatibility Source and binary code compatible with Series 700 product family
- Graphics Options 19-inch 1280 x 1024 8-plane color
19-inch 1280 x 1024 24-plane color
Dual 19-inch 1280 x 1024 24-plane color
19-inch 1280 x 1024 24-plane Z-buffered color
19-inch 1280 x 1024 48-plane Z-buffered color
19-inch 1280 x 1024 8-bit grayscale
- Main Memory 32 MB (16 MB on-board CPU; non-removable)
Up to 400 MB; removable memory cards
- Mass Storage, single ended SCSI 3.5-inch SCSI hard disk drive
Optional second hard disk drive or
Optional 3.5-inch flexible disk drive
or,
Mass Storage, fast/wide SCSI 3.5-inch SCSI hard disk drive
Optional second hard disk drive
- Network Thin LAN, or
LAN AUI, or
FDDI
- I/O Two 9-pin RS-232 ports
One 25-pin HP parallel port
8-bit, single-ended SCSI-2 interface
16-bit, fast, wide, SCSI-2 interface
HP-HIL port for HP-UX keyboards and other
HP-HIL devices
CD-quality audio and speaker output
CD-quality microphone and audio input

System Unit Controls

Before powering on the system, you should become familiar with the system unit controls.

This chapter introduces the HP Apollo 9000 Series 700 Model 735 workstations. Its purpose is to familiarize you with the workstation and its controls and indicators. Included in this chapter are the following topics:

- Product description
- System unit controls
- Understanding the LEDs
- System unit rear panel connectors
- Monitor controls, connectors, and indicators

Figure 1-1 shows the Power switch and the Power LED.

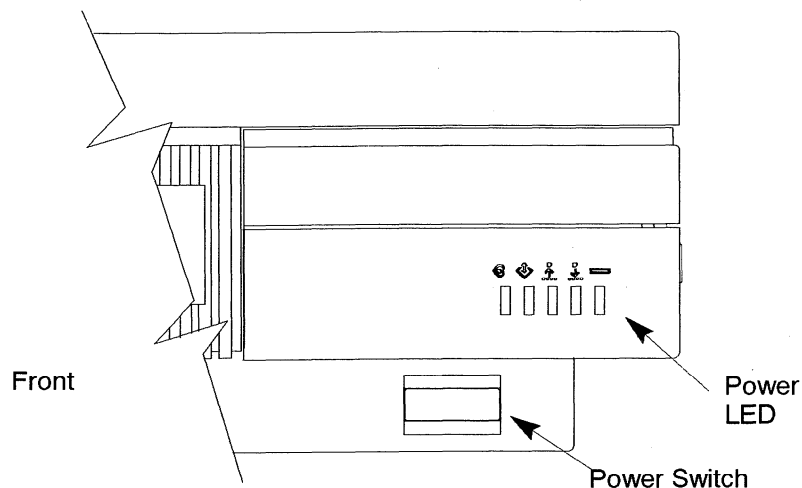
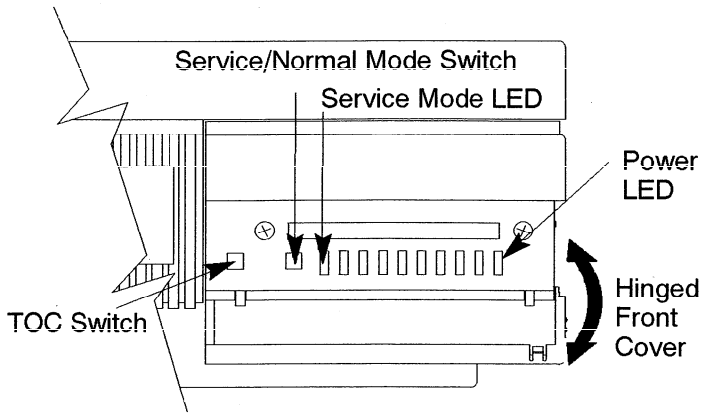

Figure 1-1. Power Switch Location

Figure 1-2 shows the location of the TOC (Transfer Of Control) and Service/Normal Mode switches. These switches are located behind a hinged cover on the front of the system unit.



Front (Hinged Cover Opened)

Figure 1–2. TOC and Service/Normal Mode Switch Locations

Power Switch

Use the power switch to power the system unit on and off.

Power LED

The power LED lights green when the system unit is powered on.

TOC Switch

Use the TOC switch to reset the operating system. Do not push the TOC switch unless you have first shutdown the system.

Service/Normal Mode Switch

The Service/Normal mode switch is by default in the Normal position. Service mode is used only during manufacturing.

Understanding the LEDs

There are 9 light-Emitting Diodes (LEDs) on the system. Five are visible from the front of the system unit when the hinged door is closed, as shown in Figure 1-3. The green LED on the far right is the Power LED. It lights when the system unit power is on. The remaining four amber LEDs show that the system is running the operating system and communicating over the network.

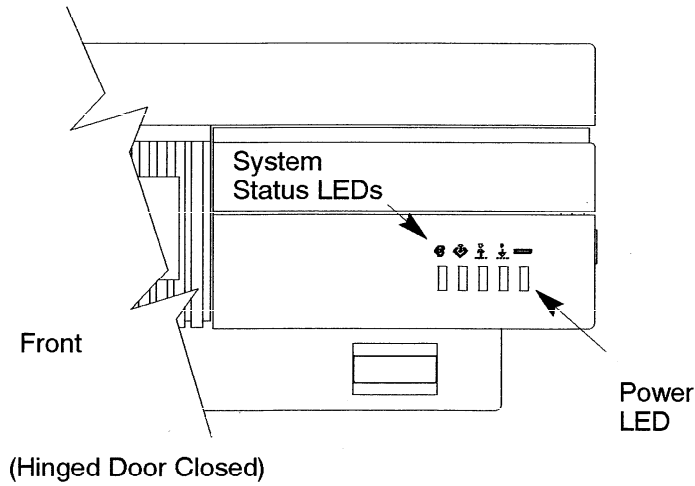
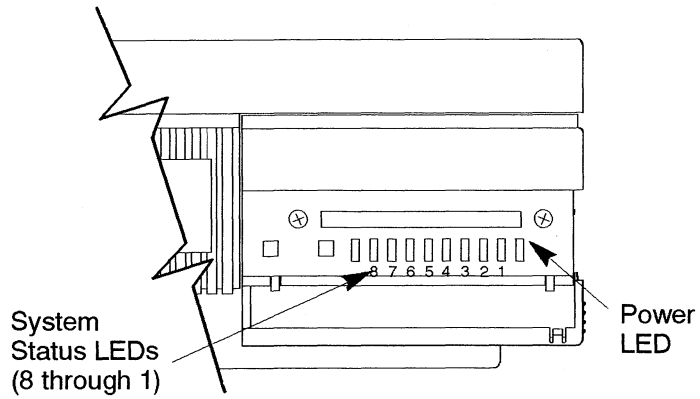

Figure 1-3. System LEDs

If you open the hinged door, there are four additional amber LEDs (as shown in Figure 1-4). These LEDs help you to troubleshoot the workstation by coming on in certain patterns during system failures (see Chapter 6).



Front (Hinged Door Opened)

Figure 1-4. Troubleshooting System LEDs

Table 1-1 lists how the four system LEDs report during normal HP-UX system activity. The green Power LED remains lit while the system is powered on.

Table 1-1. LED Display During Normal System Activity

LED Display	Symbol	Meaning
<p>8 7 6 5 4 3 2 1</p> <p>□ □ □ □ ■ □ □ □</p>		Operating System Running
<p>□ □ □ □ □ ■ □ □</p>		Disk Access In Progress
<p>□ □ □ □ □ □ □ ■</p>		Network Receive In Progress
<p>□ □ □ □ □ □ □ ■</p>		Network Transmit In Progress
<p>■ = LED On or Flashing</p>		

System Unit Rear Panel Connectors

This section describes the four main I/O subsystems on the system unit's rear panel:

- System I/O Connectors
- Graphic I/O Connectors
- Disk I/O Connectors
- EISA I/O Connectors

Figure 1-5 shows the location of the connectors as well as the ac power connector on the system's rear panel.

NOTICE: To maintain FCC/EMI compliance, verify that all cables are fully seated and properly fastened.

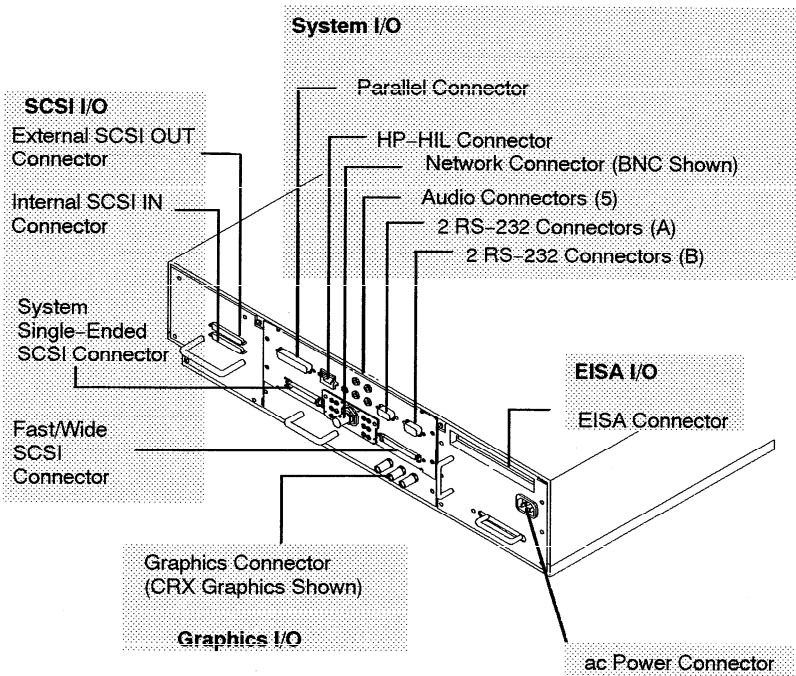

Figure 1-5. Model 735 Rear Panel Connectors

System I/O Connectors

- HP–HIL connector
- HP parallel I/O connector
- 802.3 network connectors
- RS–232 serial input/output connectors

HP–HIL connector

The onboard Hewlett–Packard Human Interface Link (HP–Hil) port provides support for 2 standard and 5 optional HP–Hil devices. The (two–dot) HP–HIL connector on the bulkhead supports the standard HP–HIL keyboard. The keyboard provides an HP–HIL connector for the standard HP–HIL 3–button mouse. Consult the documentation that accompanies each input device for specific information concerning its use.

HP Parallel I/O connector

The 25–pin HP Parallel I/O interface port is provided for use with peripheral devices using the Centronics interface protocols such as printers and plotters. Consult the documentation that accompanies each peripheral device for specific information concerning its use.

Network connectors

The system provides a connector for LAN through a removable daughter card of the system I/O board. Three LAN options are available: a BNC connector for a ThinLAN IEEE 802.3 network, an AUI external connector for a MAU to an IEEE 802.3 network, or a connector for an FDDI network.

RS-232 Serial Input/Output connectors

You can attach a variety of peripheral devices to the two RS-232 Serial Input/Output (SIO) ports on the workstation. These peripheral devices include printers, plotters, modems, and scanners. Consult the documentation that accompanies each peripheral device for specific information concerning its use.

Both SIO ports are programmable. You can set functions such as bit rate, character length, parity, and stop bits. SIO Ports 1 and 2 are used as interfaces for serial asynchronous devices to the CPU. Both ports operate at up to a 19.2K baud rate. The interface to SIO1 and 2 is by way of RS-232 drivers and receivers.

Table Table 1-2 shows the SIO connector pin listings. The serial connectors are 9-pin D-sub connectors. Signal names are those specified in the EIA RS-232 standard.

Table 1-2. Serial I/O Pins

Pin No.	Signal	Description
1	DCD	Data Carrier Detect
2	RXD	Receive Data
3	TXD	Transmit Data
4	DTR	Data Terminal Ready
5	GND	Ground
6	DSR	Data Set Ready
7	RTS	Request To Send
8	CTS	Clear To Send
9	RI	Ring Indicator

Audio connectors

The workstation has audio input and output capability through external input and output connectors and an internal speaker. A microphone for audio input is not supplied with the workstation. The audio connectors are standard audio mini-jacks. Hewlett-Packard recommends that for best quality recording and playback of audio through the external connectors, that you use gold-plated plugs available through audio retailers. For more information on the audio capability of the workstation see the *Audio Users Guide* manual. Figure 1-6 shows the audio connectors on the rear of the workstation.

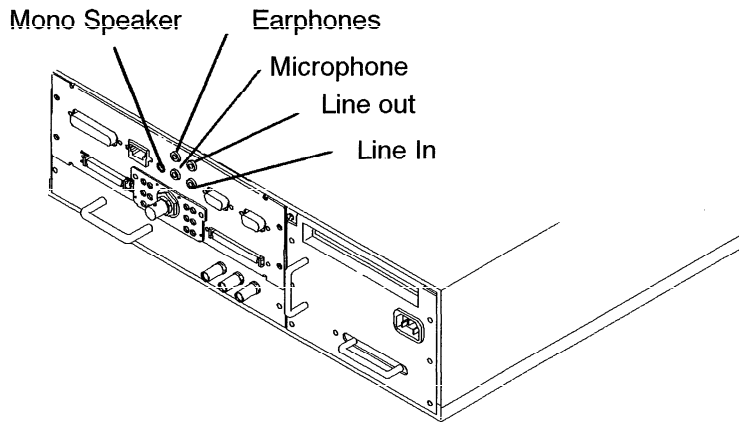

Figure 1-6. Audio Connectors

SCSI I/O Connectors

The system contains four (4) SCSI connectors:

- External SCSI OUT Connector
- Internal SCSI IN Connector
- System Single-Ended SCSI Connector
- System Fast/Wide SCSI Connector

NOTICES: When attaching external SCSI devices, be sure to terminate the last device on the external SCSI bus. If no external SCSI devices are attached, the SCSI terminator that was shipped with the workstation should be connected to the external SCSI connector.

HP does not provide maintenance for SCSI devices not sold by HP. For a list of SCSI devices that are sold by HP, contact the sales representative.

Graphic I/O Connector

If the computer system includes a bitmapped display, you will find the bulkhead for a graphic device just below the I/O bulkhead. If the system is a server, it will not have a graphic device at this location.

The system has one of the following three types of graphic devices:

- **Color graphic card** This type of device has three BNC connectors (one each for red, blue, and green). These are connected by a cable to three similar connectors on the color monitor.
- **Grayscale graphic card** This type of device has one BNC connector. This is connected by a cable to a similar connector on a grayscale monitor.
- **Graphic interface card** This type of device has a special connector. It is connected to an external graphic processor, which in turn is connected to a video display monitor.

EISA I/O Connector

The one slot EISA (Extended Industry Standard Architecture) I/O port is a superset of ISA (Industry Standard Architecture). It extends the capabilities of that standard while maintaining compatibility with ISA expansion boards. EISA provides 32-bit memory addressing and 32-bit data transfers. The EISA slot allows quick and easy integration in heterogeneous networks as well as simple connections of high-speed, low-cost disks and other peripherals. Consult the documentation that accompanies each device for specific information concerning its use.

Monitor Controls, Connectors, and Indicators

Before using the monitor, you should become familiar with its controls, connectors, and indicators.

The Power-On LED, when lit, indicates that the monitor has ac power applied. Use the following controls to adjust the monitor:

- The Power-on button turns the monitor's power on and off.
- The Brightness control adjusts the brightness of the display.
- The Contrast control adjusts the light-to-dark and dark-to-light contrast of the display.
- The Degauss control demagnetizes the monitor. Degaussing disperses any accumulated magnetic charge from the face of the monitor. Magnetic disturbances such as picture distortion or color impurity can be caused by either moving the monitor from one place to another or swiveling the monitor on its base.

The following figures illustrate the monitors for the workstation.

Figure 1-6 shows the 19-inch, color monitor.

Figure 1-7 shows the 19-inch, grayscale monitor.

- 1 V-STAT
- 2 H-STAT
- 3 V-CENT
- 4 Brightness
- 5 Contrast
- 6 Power-On LED
- 7 Power ON/OFF Button

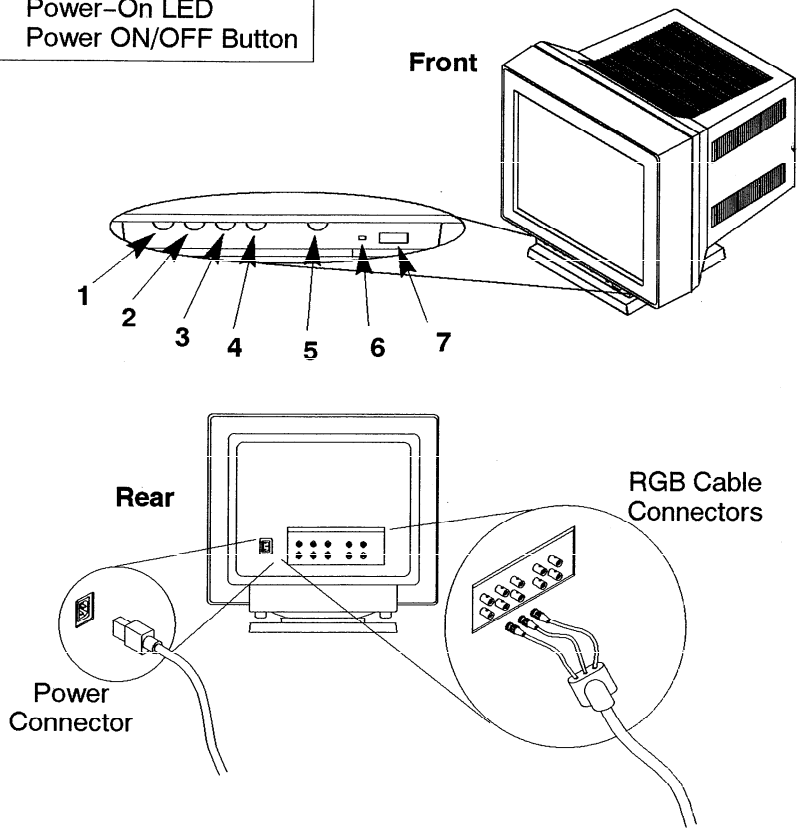

Figure 1-7. 19-Inch, Color Monitor (Model A2094)

- 1 Brightness
- 2 Contrast
- 3 Power-On LED
- 4 Power ON/OFF Button

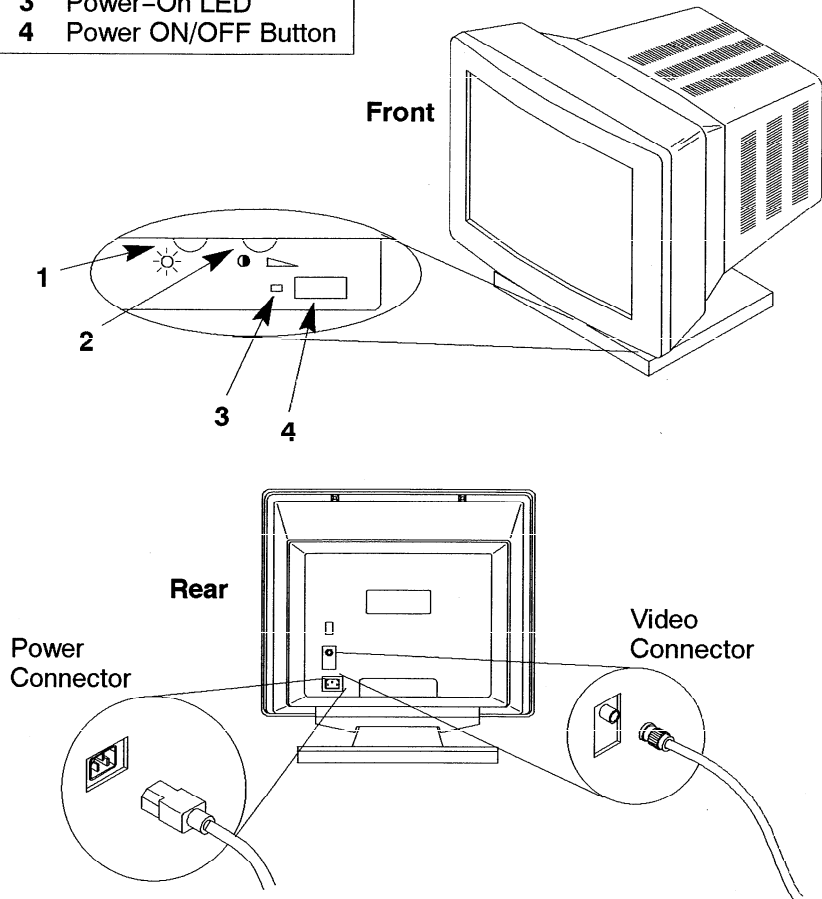
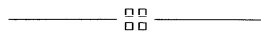

Figure 1-8. 19-Inch, Grayscale Monitor (Model A2088)



Environmental/ Installation/PM

2

This chapter lists the environmental specifications for the system and lists the regulatory requirements. Installation and preventive maintenance information, if applicable, is also provided.

Environmental Specifications

Table 2-1 lists the environmental specifications.

Table 2-1. Environmental Specifications for Model 735 SPU

Type	Specification
Operating Temperature	5-40° C
Non-Operating Temperature	-30-70° C
Humidity	15-80% maximum operating @ 40° C 90% maximum nonoperating @ 65° C (for 12 hours)
Operating Altitude	3100 m @ 40° C
Storage Altitude	4600 m @ 70° C
Acoustic	Less than 5.0 BELS @ 40° C
Electrical Input	90 - 132 Vac or 180 - 264 Vac, 47 - 66 Hz 540 Watts max. 1843 BTU/hour 465 Kcal/hour

Regulatory Requirements

The following regulatory requirements are met:

- FCC Class A
- CSA C22.2 No. 950M
- VCCI Class 1
- EN 55022 Class A / CISPR 22 Class A
- UL1950
- TUV/GS Mark
 - IEC 950/EN60950
 - ZH1/618

Installation

Refer to the installation and users manuals:

Preventive Maintenance

There is no preventive maintenance for the system unit. Removable media storage devices may require operator preventive maintenance. Refer to the respective manual.

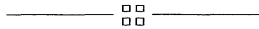

Configuration

3

This chapter provides details on setting up and changing the system configuration.

Workstation and System Unit Configurations

Refer to the HP Apollo 9000 Series 700 Configuration Guide for a complete list of supported accessories, peripherals, and operating systems.

FRU Configurations

This section provides information for setting up or changing the configuration of the system Field Replaceable Units (FRUs).

Mass Storage Configurations

Figures 3–1 through 3–10 show the SCSI ID settings for mass storage devices.

NOTICE: The SCSI terminators must be removed from all internal SCSI devices.

Internal System Drives:

System SCSI Drive(s)

- 1st Winchester Drive (if present, uses ID No.6)
- 2nd Winchester Drive (if present, uses ID No. 5)
- Floppy Disk Drive (if present, uses ID No. 0)

External Device Drives:

External SCSI HP 6000 Series: 660A Disk Sub-System.
The SCSI addresses of the devices of this sub-system must not conflict with other devices. These also are not necessarily the default settings as shipped from stock.)

- 1st Winchester Drive (ID. No. 4)
- 2nd Winchester Drive (ID No. 3)
- 3rd Winchester Drive (ID No. 0)
- 4mm DDS Tape Drive (ID No. 3)
- Magnet-Optical Drive (ID No. 0)
- 600MB CD-ROM (ID No. 2)

External SCSI HP Standalone

- Magneto-Optical Drive (C1701A) (ID No. 0)
- CD-ROM Drive (A1999A) (ID No. 2)
- 20 GB Magneto-Optical Autochanger (C1700A)
 - 1st (ID No. 3)
 - 2nd (ID No. 4)
 - 3rd (ID No. 5)

Figure 3-1. Default SCSI IDs

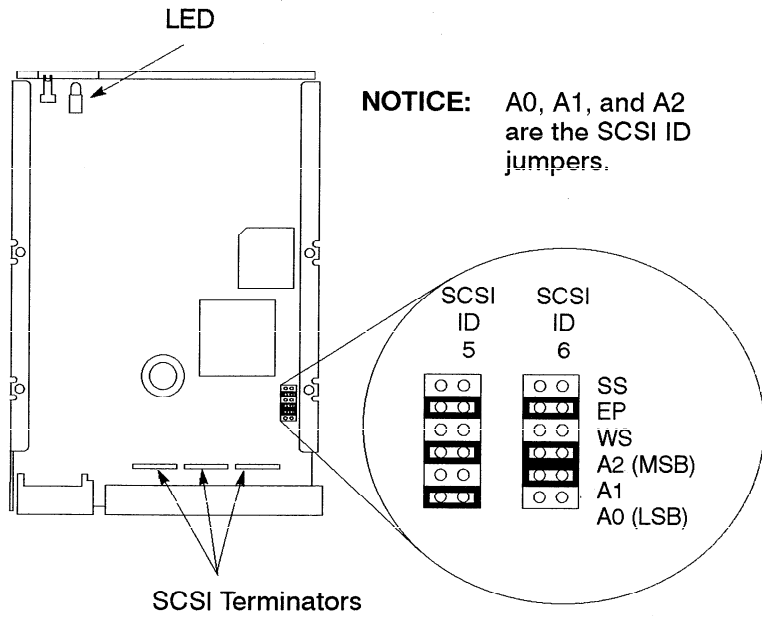

Figure 3-2. Quantum 210-MB Winchester Drive Jumpers

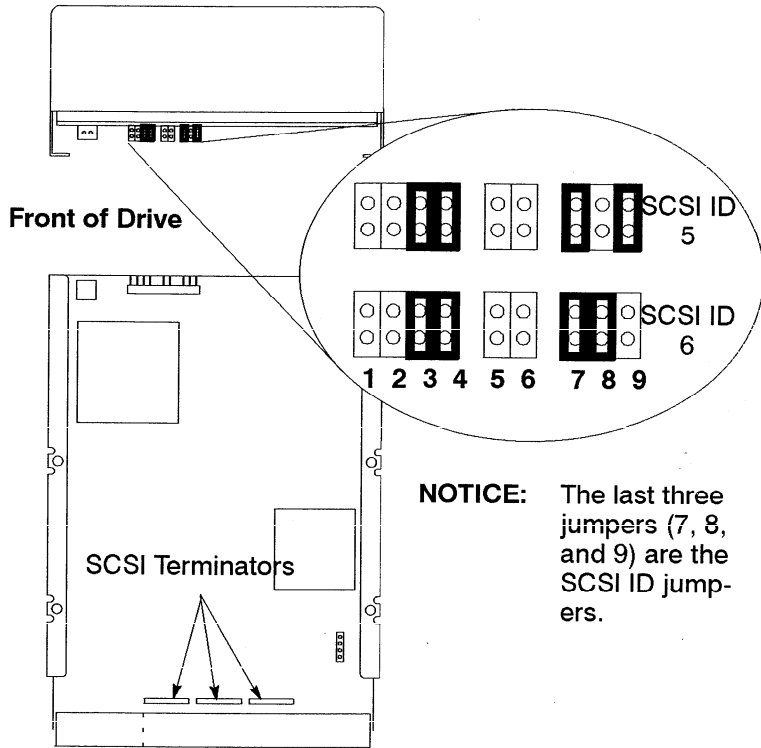

Figure 3-3. Hewlett-Packard 420-MB Winchester Drive Jumpers (Early Model)

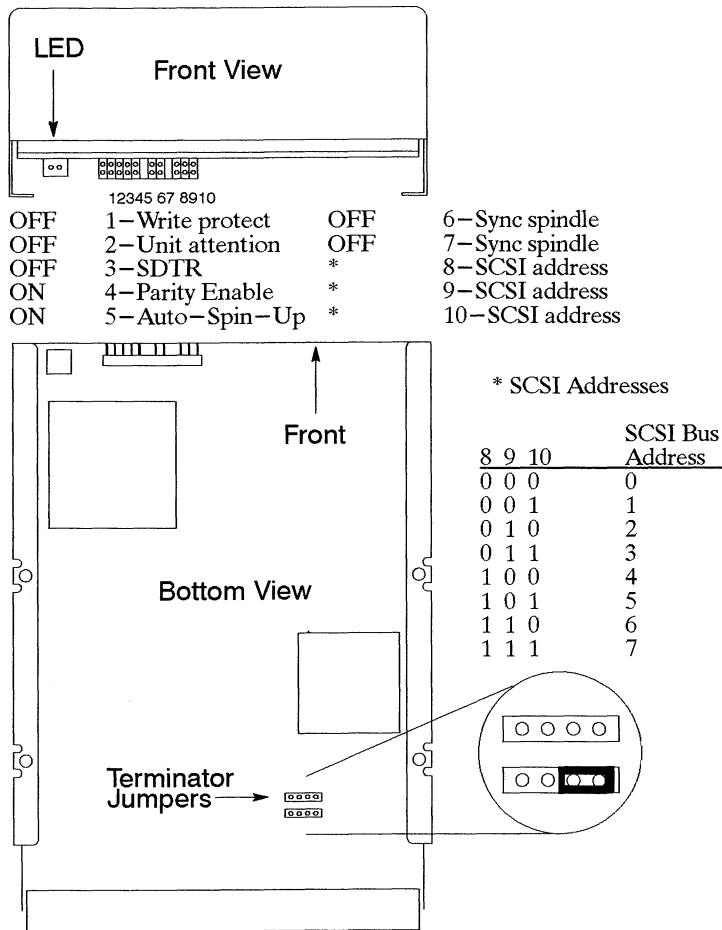

Figure 3-4. Hewlett-Packard 420-MB Winchester Drive Jumpers (Late Model)

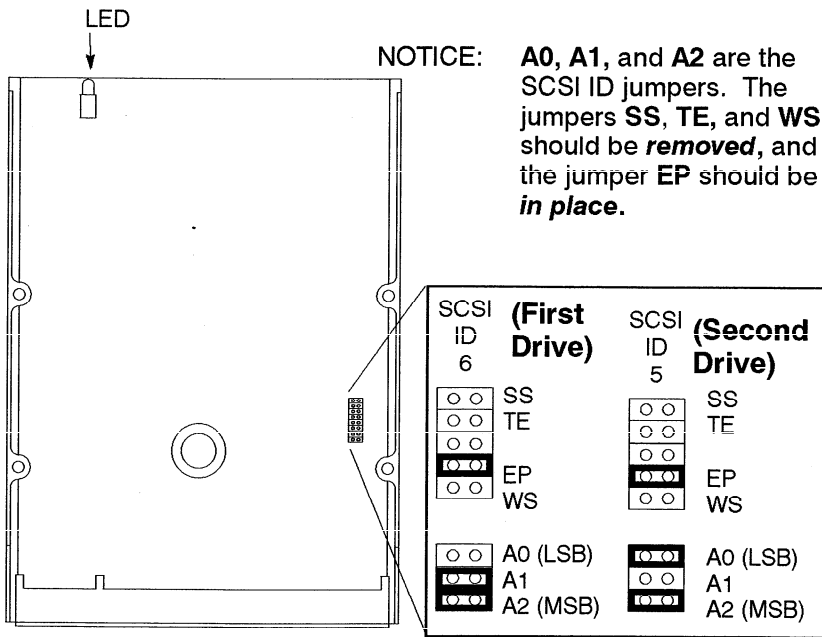

Figure 3-5. Quantum 525-MB Winchester Drive Jumpers

NOTICE: The first three jumpers (1, 2, and 3) should be **removed**, and the SCSI ID jumpers are jumpers 4, 5, and 6.

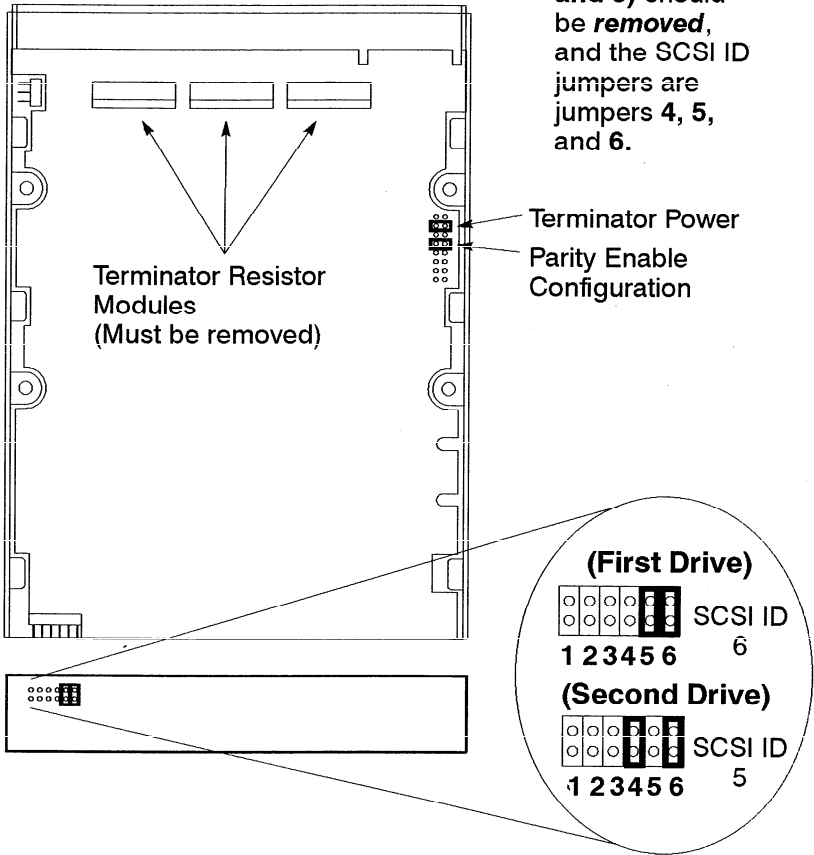
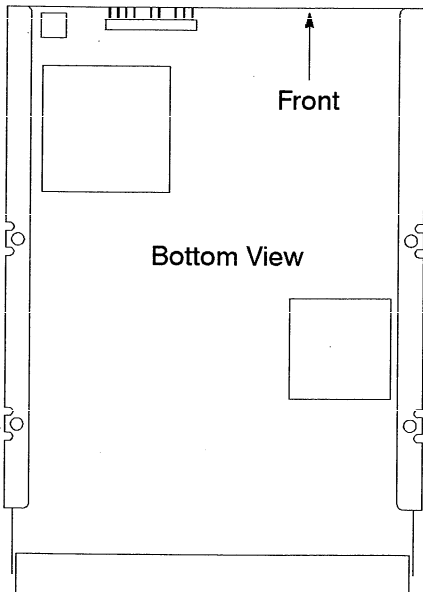
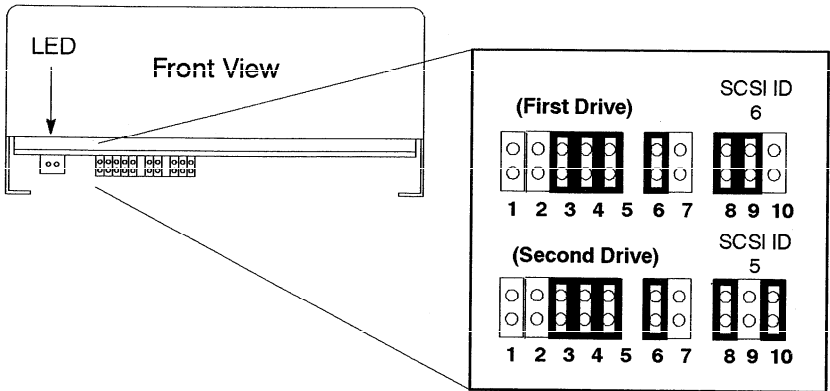

Figure 3-6. Seagate 525-MB and 1-GB Winchester Drive Jumpers



NOTICE: The last three jumpers (**8, 9, and 10**) are the SCSI ID jumpers. Jumpers **1, 2, and 7** should be **removed**, and jumpers **3, 4, 5, and 6** should be **in place**.

Figure 3-7. Hewlett-Packard 1-GB Winchester Drive Jumpers (Single-Ended)

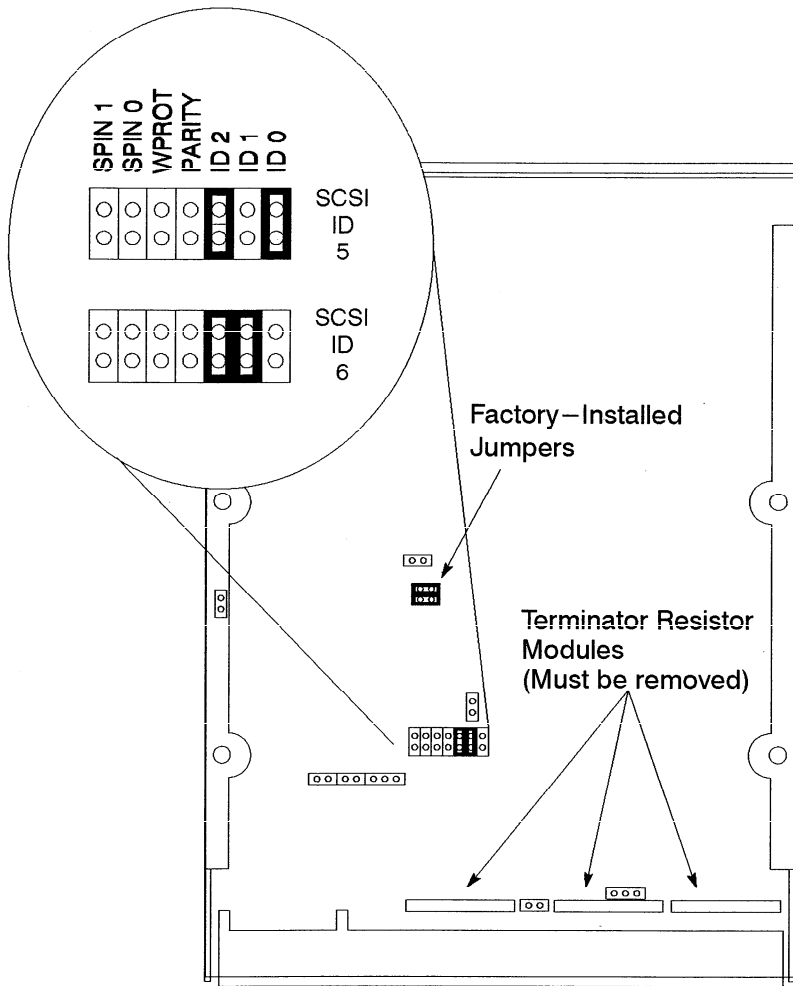

Figure 3-8. Micropolis 1-GB Winchester Drive Jumpers
(Single-Ended)

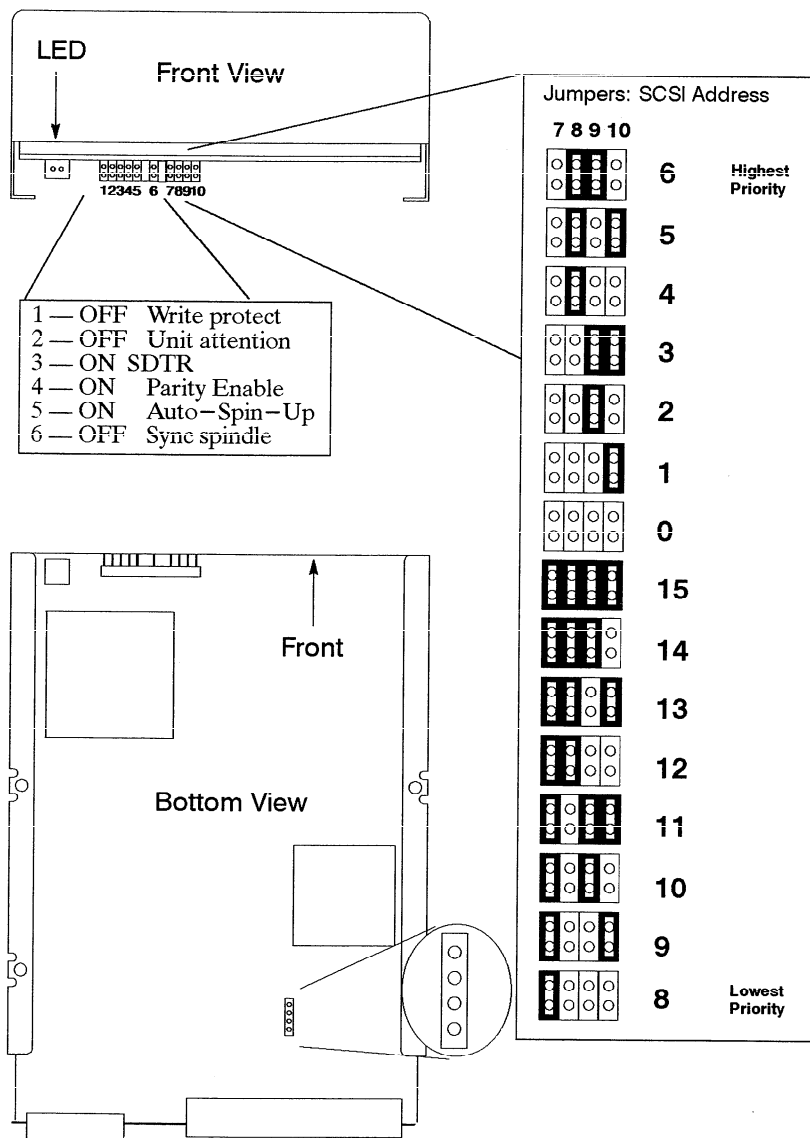
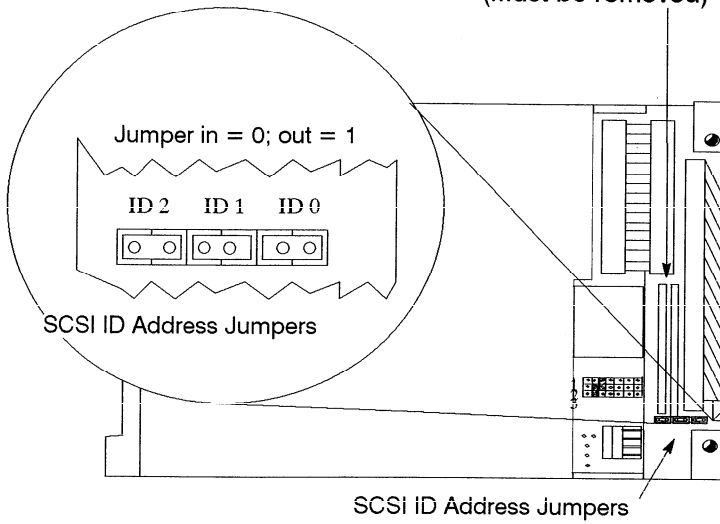

Figure 3-9. Hewlett-Packard 1-GB Winchester Drive Jumpers (Fast/Wide)

early model floppy

Top View of Floppy Disk Drive

Terminator Resistor Modules
(Must be removed)



late model floppy

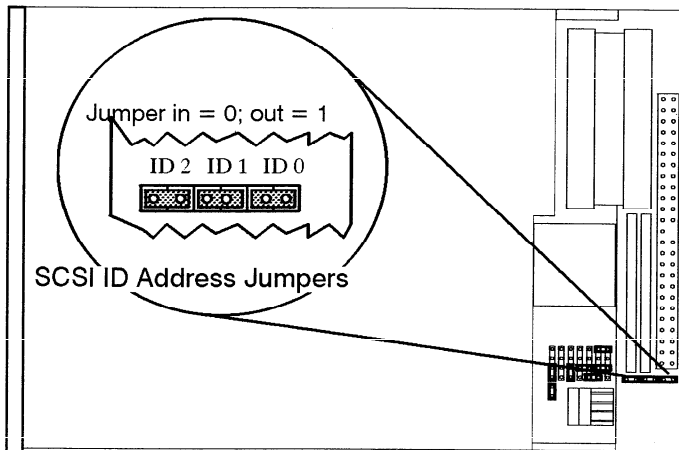

Figure 3-10. Floppy Address Jumper Settings

Installing Additional Memory

Figure 3–11 shows the memory SIMM locations. Be sure to follow these guidelines:

- The Model 735 processor board has 16-MB main memory resident (unremoveable).
- The SIMMs must be installed as pairs (two cards of the same capacity).
- The Model 735 has six pairs of slots (numbered 1 through 6).
- The slot pairs on the Model 735 processor board are arranged in two connector blocks, labeled **H**(igh) and **L**(ow). *The pair numbering starts in the middle of the board, one in each connector block.*
- You load the boards left to right when the board is positioned as shown in Figure 3–11. Start with the highest number **H** slot *that will be occupied* when installing the memory cards in the new processor board (if you are installing four pairs of cards, slot **4H** is the highest number **H** slot). You must then fill the lower number slots in the **H** block. You then fill the lower numbers in the **L** block, working toward the highest number **L** slot that will be filled.
- If you need to add SIMM cards to existing SIMMs, you will need to remove the cards already installed in the **H** block, and start installing the cards at the highest number slot to be used. The cards already installed in the **L** block may remain installed; just add the new cards to the higher numbered slots. Be sure that the SIMMs remain paired properly (two cards of the same capacity occupying the same slot number in the **H** and **L** blocks) when you add new cards.

NOTE: This illustration assumes four pairs of cards are to be installed.

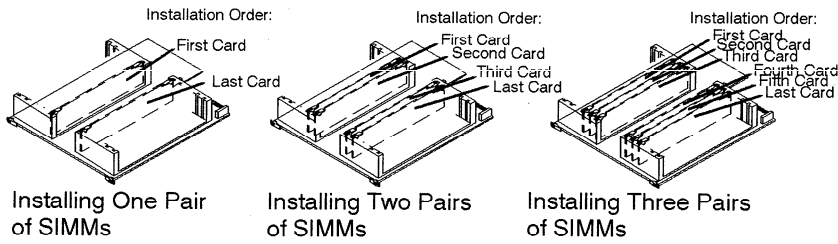
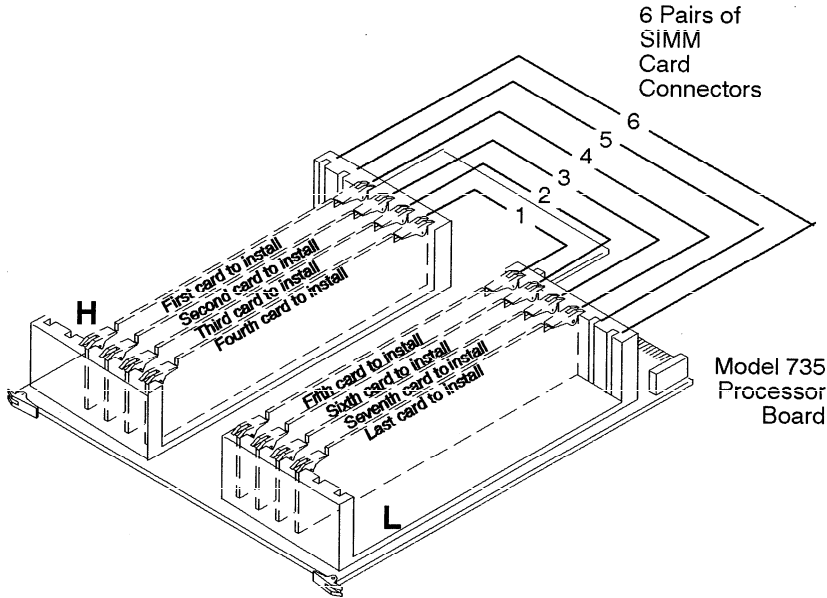
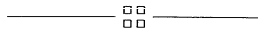

Figure 3-11. Installing Memory Cards



Troubleshooting

4

This chapter provides information about isolating a failing Field Replaceable Unit (FRU).

To troubleshoot HP Apollo workstations, you must be familiar with the HP-UX operating system. You must be able to start and stop processes. You should also be familiar with the Boot ROM Test Mode, ISL diagnostics, and the SupportWave online tests.

For Series 700 systems, you note any error or status messages, and then run the power-up boot ROM diagnostics, known as Self Test. If the Self Test diagnostics fail, replace the FRU that is indicated. If the tests pass but you still suspect a problem, run the ISL diagnostics and the SupportWave online tests. Refer to the following sections for more information about Self Test.

For a complete description on using ISL diagnostics and SupportWave, see the *Precision Architecture RISC HP Apollo 9000 Series 700 Diagnostics Manual*.

LED Error Codes

This section contains information about the error codes displayed by the LEDs on the system's front panel.

If an error occurs during the power-up diagnostics tests, the diagnostics use the front panel LEDs to display a code for the failing component.

Figure 4-1 shows the location of the system unit's front panel LEDs. There are nine LEDs on the front panel. The green LED on the far right indicates that the system is powered up. The amber LEDs labeled 1 through 8, right to left, indicate system status and error codes.

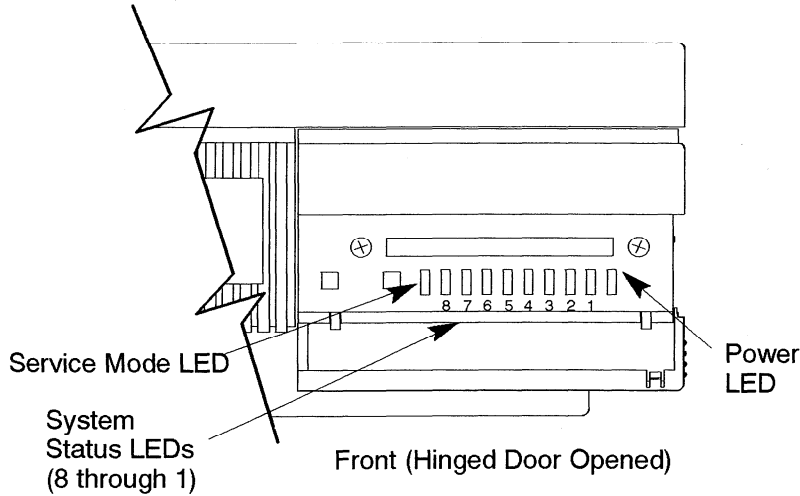



















































































Figure 4-1. Front Panel LEDs

Table 4-1 through Table 4-4 show the LED codes as they appear on the panel display. Use these LED codes to determine the failing component.

Table 4-1. Selftest LED Codes

LED Display	FRU	Error
8 7 6 5 4 3 2 1    	Processor Board	CPU Diagnose Register
   		CPU Basic Functions
   		CPU ALU & Branch
   		CPU Arithmetic Conditions
   		CPU Bit Operations
   		CPU Arithmetic Side Effects
   		CPU Control Registers
   		CPU External Interrupts
   		CPU Shadow Registers
   		TLB Initialization
   		Cache Data Line
   		Cache Address Line
   		Instruction Cache RAM
   		Data Cache RAM
   		Cache Tag Compare
   		Cache Errors
   		Cache Configuration
   		Cache Flush
   		Cache Byte Transaction
   		Instruction Cache Miss

 = LED On or Flashing































































































































(Continued)

Table 4-1. Selftest LED Codes (Continued)

LED Display	FRU	Error	
8 7 6 5 4 3 2 1			
	Processor Board	Data Cache Miss	
		Cache Done	
		Memory Interface EIR	
		Memory Interface HPMC	
		Memory Interface	
		Memory Interface Invalid Address	
		Memory Interface Single Bit Error	
		Memory Interface Double Bit Error	
		Memory Interface Diagnose Register	
		Floating Point Registers	
		Floating Point Instructions	
		Floating point Traps	
		EISA Interface Controller	EISA Init
			EISA ADDR Test
	ADDR Test Failure		
	EISA Pattern Test		
	EISA Pattern Test Failure		
		ROM Checksum Failure	
= LED On or Flashing			

(Continued)

Table 4-1. Selftest LED Codes (Continued)

LED Display	FRU	Error
8 7 6 5 4 3 2 1       	Memory	Onboard RAM (0H) Error
      		RAM Slot 1H Error
      		RAM Slot 2H Error
      		RAM Slot 3H Error
      		RAM Slot 4H Error
      		RAM Slot 5H Error
      		RAM Slot 6H Error
      		Onboard RAM (0L) Error
      		RAM Slot 1L Error
      		RAM Slot 2L Error
      		RAM Slot 3L Error
      		RAM Slot 4L Error
      		RAM Slot 5L Error
      		RAM Slot 6L Error
      		RAM Configuration & Test In Progress
      		No RAM Found
      		Non-Destructive RAM Test
      		RAM Configuration & Test

 = LED On or Flashing

(Continued)

Table 4-1. Selftest LED Codes (Continued)

LED Display	FRU	Error																
<table style="border-collapse: collapse; margin: auto;"> <tr> <td style="text-align: center;">8</td> <td style="text-align: center;">7</td> <td style="text-align: center;">6</td> <td style="text-align: center;">5</td> <td style="text-align: center;">4</td> <td style="text-align: center;">3</td> <td style="text-align: center;">2</td> <td style="text-align: center;">1</td> </tr> <tr> <td style="text-align: center;">█</td> <td style="text-align: center;">□</td> <td style="text-align: center;">□</td> <td style="text-align: center;">□</td> <td style="text-align: center;">□</td> <td style="text-align: center;">□</td> <td style="text-align: center;">□</td> <td style="text-align: center;">□</td> </tr> </table>	8	7	6	5	4	3	2	1	█	□	□	□	□	□	□	□	System I/O	Unknown I/O Device
8	7	6	5	4	3	2	1											
█	□	□	□	□	□	□	□											
<table style="border-collapse: collapse; margin: auto;"> <tr> <td style="text-align: center;">█</td> <td style="text-align: center;">□</td> <td style="text-align: center;">□</td> <td style="text-align: center;">□</td> <td style="text-align: center;">□</td> <td style="text-align: center;">□</td> <td style="text-align: center;">□</td> <td style="text-align: center;">█</td> </tr> </table>	█	□	□	□	□	□	□	█	Single-Ended SCSI Init									
█	□	□	□	□	□	□	█											
<table style="border-collapse: collapse; margin: auto;"> <tr> <td style="text-align: center;">█</td> <td style="text-align: center;">□</td> <td style="text-align: center;">□</td> <td style="text-align: center;">□</td> <td style="text-align: center;">□</td> <td style="text-align: center;">□</td> <td style="text-align: center;">█</td> <td style="text-align: center;">□</td> </tr> </table>	█	□	□	□	□	□	█	□	LAN Init									
█	□	□	□	□	□	█	□											
<table style="border-collapse: collapse; margin: auto;"> <tr> <td style="text-align: center;">█</td> <td style="text-align: center;">□</td> <td style="text-align: center;">□</td> <td style="text-align: center;">□</td> <td style="text-align: center;">□</td> <td style="text-align: center;">□</td> <td style="text-align: center;">█</td> <td style="text-align: center;">█</td> </tr> </table>	█	□	□	□	□	□	█	█	HIL Init									
█	□	□	□	□	□	█	█											
<table style="border-collapse: collapse; margin: auto;"> <tr> <td style="text-align: center;">█</td> <td style="text-align: center;">□</td> <td style="text-align: center;">□</td> <td style="text-align: center;">□</td> <td style="text-align: center;">□</td> <td style="text-align: center;">█</td> <td style="text-align: center;">□</td> <td style="text-align: center;">□</td> </tr> </table>	█	□	□	□	□	█	□	□	RS232 Port A Init									
█	□	□	□	□	█	□	□											
<table style="border-collapse: collapse; margin: auto;"> <tr> <td style="text-align: center;">█</td> <td style="text-align: center;">□</td> <td style="text-align: center;">□</td> <td style="text-align: center;">□</td> <td style="text-align: center;">□</td> <td style="text-align: center;">█</td> <td style="text-align: center;">□</td> <td style="text-align: center;">█</td> </tr> </table>	█	□	□	□	□	█	□	█	RS232 Port B Init									
█	□	□	□	□	█	□	█											
<table style="border-collapse: collapse; margin: auto;"> <tr> <td style="text-align: center;">█</td> <td style="text-align: center;">□</td> <td style="text-align: center;">□</td> <td style="text-align: center;">□</td> <td style="text-align: center;">□</td> <td style="text-align: center;">█</td> <td style="text-align: center;">█</td> <td style="text-align: center;">□</td> </tr> </table>	█	□	□	□	□	█	█	□	Parallel Port Init									
█	□	□	□	□	█	█	□											
<table style="border-collapse: collapse; margin: auto;"> <tr> <td style="text-align: center;">█</td> <td style="text-align: center;">□</td> <td style="text-align: center;">□</td> <td style="text-align: center;">□</td> <td style="text-align: center;">█</td> <td style="text-align: center;">□</td> <td style="text-align: center;">□</td> <td style="text-align: center;">□</td> </tr> </table>	█	□	□	□	█	□	□	□	Graphics Init									
█	□	□	□	█	□	□	□											
<table style="border-collapse: collapse; margin: auto;"> <tr> <td style="text-align: center;">█</td> <td style="text-align: center;">□</td> <td style="text-align: center;">□</td> <td style="text-align: center;">□</td> <td style="text-align: center;">█</td> <td style="text-align: center;">□</td> <td style="text-align: center;">□</td> <td style="text-align: center;">█</td> </tr> </table>	█	□	□	□	█	□	□	█	EISA Slot Init									
█	□	□	□	█	□	□	█											
<table style="border-collapse: collapse; margin: auto;"> <tr> <td style="text-align: center;">█</td> <td style="text-align: center;">□</td> <td style="text-align: center;">□</td> <td style="text-align: center;">█</td> <td style="text-align: center;">█</td> <td style="text-align: center;">□</td> <td style="text-align: center;">□</td> <td style="text-align: center;">□</td> </tr> </table>	█	□	□	█	█	□	□	□	FDDI Init									
█	□	□	█	█	□	□	□											
<table style="border-collapse: collapse; margin: auto;"> <tr> <td style="text-align: center;">█</td> <td style="text-align: center;">□</td> <td style="text-align: center;">□</td> <td style="text-align: center;">█</td> <td style="text-align: center;">█</td> <td style="text-align: center;">□</td> <td style="text-align: center;">□</td> <td style="text-align: center;">█</td> </tr> </table>	█	□	□	█	█	□	□	█	Fast Wide SCSI Init									
█	□	□	█	█	□	□	█											
<table style="border-collapse: collapse; margin: auto;"> <tr> <td style="text-align: center;">█</td> <td style="text-align: center;">= LED On or Flashing</td> </tr> </table>			█	= LED On or Flashing														
█	= LED On or Flashing																	

Table 4-2. PDC LED Codes

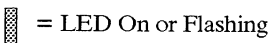
LED Display								Status
8	7	6	5	4	3	2	1	
█	□	█	□	□	□	□	█	Destructive Memory Init
█	□	█	□	□	□	█	□	Non-Destructive Memory Init
█	□	█	□	□	□	█	█	Console Selection
█	□	█	□	□	█	□	□	Boot Device Selection
█	□	█	□	□	█	□	█	Autoselection Failure to Find Boot Device
█	□	█	□	□	█	█	□	Launching IPL
█	□	█	□	□	█	█	█	TOC Handler Entered
█	□	█	□	█	□	□	□	Branching to OS TOC Handler
█	□	█	□	█	□	□	█	Branching to OS HPMC Handler
█	□	█	□	█	□	█	□	EISA Subsystem Init
█	□	█	□	█	□	█	█	Setting Up Default EISA Config
█	□	█	□	█	█	□	█	At Least One Selftest Failed (Service Mode)
█	□	█	█	□	□	□	█	Error Reading EEPROM
█	□	█	█	□	□	█	□	Unexpected Interrupt
█	□	█	█	□	□	█	█	No Console Located
█	□	█	█	□	█	□	□	HPMC Handling Init
█	□	█	█	□	█	□	█	HPMC Due to Cache Error
█	□	█	█	□	█	█	□	HPMC Due to Memory Error
█	□	█	█	□	█	█	█	HPMC Due to Bus Error
█	□	█	█	□	□	□	□	Nested HPMC Detected
								

(Continued)

Table 4-2. PDC LED Codes (Continued)









































LED Display								Status
8	7	6	5	4	3	2	1	
								Error Writing EEPROM
								Unable to Determine Valid Processor Speed
								Processor Speed Sensing
								Problem Calculating Memory Control Values
								Bad Memory Hardware
 = LED On or Flashing								

Table 4-3. ISL LED Codes

LED Display	Status
8 7 6 5 4 3 2 1 □ □ □ □ □ □ □ □	ISL Executing.
□ □ □ □ □ □ ■ □	ISL is Autobooting from the Autoexec file.
□ □ □ □ □ □ ■ □	ISL Cannot Find Autoexecute file.
□ □ □ □ □ □ ■ ■	No Console Found. ISL Autobooting.
□ □ □ □ □ ■ □ ■	Directory of utilities is too large.
□ □ □ □ □ ■ ■ □	Autoexec File is Inconsistent.
□ □ □ ■ □ □ ■ □	Error Reading Autoexec File.
□ □ □ ■ □ □ ■ ■	Error Reading from Console.
□ □ □ ■ □ ■ □ □	Error Writing to Console.
□ □ □ ■ □ ■ ■ ■	Not an ISL Command or Utility.
□ □ □ ■ □ ■ ■ □	Utility File Header Inconsistent: Invalid System ID.
□ □ □ ■ □ ■ ■ ■	Error Reading Utility File Header.
□ □ □ ■ ■ □ □ □	Utility File Header Inconsistent: Bad Magic Number.
□ □ □ ■ ■ □ □ ■	Utility Would Overlay ISL in Memory.
□ □ □ ■ ■ □ ■ □	Utility Requires More Memory Than Is Configured.
□ □ □ ■ ■ □ ■ ■	Error Reading Utility Into Memory.
□ □ □ ■ ■ ■ □ □	Incorrect Checksum: Reading Utility Into Memory.
□ □ □ ■ ■ ■ □ ■	System Console Needed.
□ □ □ ■ ■ ■ ■ □	Internal Inconsistency: Invalid Boot Device Class.
□ □ ■ □ □ □ □ ■	Destination Memory Address of Utility is Invalid.
■ = LED On or Flashing	

(Continued)

Table 4-3. ISL LED Codes (Continued)

LED Display								Status
8	7	6	5	4	3	2	1	
□	□	▣	□	□	□	▣	□	Internal Inconsistency: pdc_cache entry
□	□	▣	□	□	□	▣	▣	Internal Inconsistency: IODC ENTRY_INIT
□	□	▣	□	□	▣	□	□	Internal Inconsistency: IODC ENTRY_INIT Console
□	□	▣	□	□	▣	□	▣	Internal Inconsistency: IODC ENTRY_INIT Boot Device
□	□	▣	□	□	▣	▣	□	Utility File Header Inconsistent: Bad aux_id
□	□	▣	□	□	▣	▣	▣	Bad Utility File Type
 = LED On or Flashing								

Table 4-4. HP-UX Kernel LED Codes

LED Display	Status
<p>8 7 6 5 4 3 2 1</p> <p>█ █ █ █ █ █ █ █</p>	Kernel Loaded and Initialization Begun.
<p>█ █ █ █ █ █ █ █</p>	Kernel Has Entered main().
<p>█ █ █ █ █ █ █ █</p>	Kernel Is About to Configure I/O System.
<p>█ █ █ █ █ █ █ █</p>	Kernel Is About to Mount Root File System.
<p>█ █ █ █ █ █ █ █</p>	Kernel Is About to Set Up Page-Out Daemon.
<p>█ █ █ █ █ █ █ █</p>	Kernel is About to Start the "INIT" Process.
<p>█ █ █ █ █ █ █ █</p>	Shutdown In Process.
<p>█ █ █ █ █ █ █ █</p>	TOC Dump.
<p>█ █ █ █ █ █ █ █</p>	HPMC Dump.
<p>█ █ █ █ █ █ █ █</p>	Operating System Executing with Load Indicator X.
<p>█ = LED On or Flashing</p>	

Dealing with a Boot Failure

If your usual boot device (typically a disk) is not responding as it should, you must attempt to boot from the disk (or another boot device) by selecting it manually.

To boot a device manually, follow these steps:

1. Turn off the power to the workstation, wait a few seconds, then turn the power back on.
2. Press **ESC**.

In a few seconds, this message appears:

```
Terminating selection process.
```

A short time later, this message appears:

```
Searching for potential boot devices.  
To terminate search, press and hold the ESCAPE key.
```

```
Device Selection Device Path Device Type and Utilities  
-----
```

Your workstation is now searching for devices that may hold file systems from which it can boot HP-UX. As they are found, they appear in a list, similar to the following sample list:

```
P0          scsi.6.0          QUANTUM PD425S  
P1          scsi.5.0          Quantum PD425S  
P2          scsi.2.0          TOSHIBA CD-ROM DRIVE  
P3          lan.123456-789abc  homebase
```

This process may take several minutes. You can terminate the search at any time by pressing **ESC**.

When the search ends, the following list of actions appears:

- b) Boot from specified device
- s) Search for bootable devices
- a) Enter boot administration mode
- x) Exit and continue boot sequence
- ?) Help

Select from menu:

If no disk devices are listed, then your workstation is failing to communicate with its disks. Recheck the SCSI connections and try again.

If no devices are listed at all, alternative methods for booting should be tried, such as connecting an external CD-ROM drive.

3. If the search locates a disk, attempt to boot from it by entering the **b** (boot) command and a device selection number from the list. For example, if a SCSI disk is listed as item **P0** (as in the example list above), enter the following:

Select from menu: **b P0** 

After a few seconds, the boot messages begin to appear on the screen. You may hear sounds coming from the disk drive and see a sequence of changing patterns on the LED display.

4. If your workstation still fails to boot, there is either something wrong with the file system or with the hardware.

Boot Administration Environment

The Boot Console User Interface provides an “interactive” environment after the power-on sequence. The Boot Console User Interface must be invoked before the Initial Program Loader (IPL) routine. Users do not have to interact with the interface when the AUTOSELECT mode is enabled.

The Boot Console User Interface executes user-entered commands that perform the following functions:

- Display the state of Autoselect mode using the **AUTO** command.
- Set the state of the Autoselect mode using the **AUTOSELECT** command with either the **ON / OFF** option.
- Boot from the primary or alternate boot path or any specified path using the **BOOT** command.
- Set or display the real-time clock value using the **DATE** command.

- Return to previous menu using the **EXIT** command.
- Set or display the Fastsize value (amount of memory initialized during boot) using the **FASTSIZE** command.
- Display a menu of commands using the **HELP** command or a description of any command as an option to the **HELP** command.
- Display the model number, version numbers, and jumper settings on the System card using the **INFO** command.
- Display the current LAN STATION ADDRESS value in stable storage using the **LAN_ADDR** command. Must use **SS_CONFIG** to set this value.
- Display the current FDDI STATION ADDRESS value in stable storage using the **FDDI_ADDR** command. Must use **SS_CONFIG** to set this value.
- Select an operating system for the next boot attempt using the **OS** command.
- Set or display the current values for the console, keyboard, primary, or alternate boot paths using the **PATH** command.
- Display the most recent HPMC or TOC error information logged into Stable Storage using the **PIM_INFO** command.
- Reset the System Unit using the **RESET** command.
- Search for possible boot devices using the **SEARCH** command.
- Display/Set secure boot mode or the ability to interact with the console device within the first 10 seconds before boot device selection is disabled using the **SECURE** command.
- Display the results of the previous search command using the **SHOW** command.

Syntax checking is performed for any supported commands. Error status is displayed on the console along with any relevant information.

Stable Storage

Stable Storage is non-volatile memory associated with each PA-RISC processor module. Stable storage is used by the processor (CPU) to store device path information, the state of the boot flags, HPMC error information, and operating system initialization data.

Boot Command Notations

The **BOOT** command supports the following three notations:

- Mnemonic
- PA-RISC I/O
- Path number

Type **help scsi** or **help lan** for more information on the boot path parameters.

Here are examples of mnemonic notation:

- **BOOT** **RETURN** with “no parameters” selects the primary boot path in stable storage.
- **BOOT** with the **ALTERNATE** or **ALT** parameter selects the alternate boot path in stable storage.

Here is an example of path number notation:

- **BOOT P1** **RETURN** attempts to boot from the second path indicated by the **SEARCH** command.

Supported Boot Paths

SCSI devices are bootable when connected to the SCSI port on the System card. Diskless workstations can only boot from the LAN port on the System card.

Invoking the ISL Environment from a SCSI Device

1. Power-on (or cycle the power) the System Unit and press **ESC** to stop the boot process and then press **ESC** to stop the selection process and invoke the Boot Administration mode (environment). The following screen appears:
b) Boot from specified device
s) Search for bootable devices
a) Enter Boot Administration mode
x) Exit and continue boot sequence
?) Help

Select from menu: _

2. Type `s` to search for devices with the ISL program and `hpux` (loader) utility in their LIF directory. The following screen appears:

```
Searching for bootable devices.
To terminate search, press and hold the ESCAPE key.
```

Device Selection	Device Path	Device Type
P0	scsi.6.0	QUANTUM PD425S

```
b) Boot from specified device
s) Search for bootable devices
a) Enter Boot Administration mode
x) Exit and continue boot sequence
?) Help
```

```
Select from menu: _
```

3. Type `b p0 ipl` to invoke the ISL environment from the 210 MB Quantum disk. The following messages, the ISL banner, and the ISL prompt are displayed:

```
Trying scsi.6.0
Boot path initialized.
Attempting to load IPL.
```

```
Hard booted.
```

```
ISL Revision A.00.09 March 27, 1990
```

```
ISL> _
```

4. Type `ls` or `listf` to review the state of the ISL boot flags, the ISL commands, and the files in the LIF directory on the `scsi` device.
5. Type `hpux boot disc(0)/hp-ux` to load the HP-UX environment from the `scsi` device.

ISL Environment

The ISL environment provides the means to load the operating system (HP–UX) environment. The ISL environment also provides an offline platform to execute diagnostic and utility programs from a boot device when HP–UX does not load.

The ISL program is the first program loaded into main memory from an external media (LAN, disk, or tape) and launched by the initial program loader (IPL) routine during the Boot Administration environment.

The ISL environment provides the following capabilities:

- Execute user–entered commands to modify boot device paths and boot options in stable storage.
- Run off–line diagnostic programs (MULTIDIAG, IOMAP).
- Provide automatic booting of the HP–UX O/S after power–on or reset.

The ISL program provides a standalone environment for loading offline diagnostic and utility programs from the LIF directory. The ISL program also provides user commands to configure the boot parameters into Stable Storage.

ISL User Commands

There are several commands available in the ISL environment that allow a user to obtain information about the boot characteristics of the system or to modify these characteristics.

- **display** – displays the boot and console paths in Stable Storage and to determine the current setting of the ISL Boot Flags.
- **primpath** – modifies the primary boot path entry in Stable Storage. The entry in Stable Storage for the primary boot device begins at byte address 0 and ends at byte address 31.
- **altpath** – modifies the alternate boot path entry in Stable Storage. The entry for the alternate boot device begins at byte address 128 and ends at 159.
- **conspath** – modifies the console path entry in Stable Storage. The entry in Stable Storage for the console device begins at byte address 96 and ends at byte address 127. The entry for the keyboard and mouse devices begins at byte address 160 and ends at 191.
- **listautofl** or **lsautofl** – lists the contents of the (HP–UX) autoboot file.
- **support** – boots the Support Tape from the boot device.
- **readss** – displays 4 bytes (one word) from Stable Storage. The **readss** command requires a decimal number between 0 and 255 to address four bytes in Stable Storage.

Running the Disk–Based ISL Diagnostics

To run the ISL–based diagnostics in the LIF directory on the System Disk:

1. Invoke the ISL environment from the System Disk.
2. Type **ls** (or **listf**) **RETURN** after the ISL prompt to list the ISL diagnostics and utilities available in the LIF directory.
3. Type **multidiag** **RETURN** after the ISL prompt to invoke the multidiag test from the System Disk. (This test takes several minutes to complete and appears to be in a loop when a graphics monitor is the system console.)

NOTICE: **multidiag** contains a loopback test for audio testing. To run the loopback test, you need to attach the audio test cable (part number 46081–61601) to the audio input and audio output connectors.

4. Type **iomap** **RETURN** after the ISL prompt to invoke the IOMAP test from the System Disk.

CSTM>Message from (0/0/0):

This graphics test displays a number of graphics images on the screen of the graphics device being tested. If an X server is not currently running on that display, X Windows will be started and run for the duration of the test. The Starbase shared library (/usr/lib/libsb.sl) should be present to run this test.

CAUTION: This test will fail if any portion of the test window is modified or overlaid in any way.

NOTE: If a VUE login screen is currently displayed on the monitor, the test will wait until someone logs in the HP VUE on the graphics monitor to release the lock. The test stops if the Screen Saver times out, it runs again once the Screen is activated.

WARNING: Do not run this exerciser with any other operation.

(Type 'R' for Ready, Type 'S' for Skip) [R] >>

When you see the prompt shown above, type r .

Verification of (2/0/1.5.0) complete. Result status - (Success).

Verification of (2/0/1.6.0) complete. Result status - (Success).

Verification of (CPU) complete. Result status - (Success).

Verification of (FPU) complete. Result status - (Success).

Verification of (2/0/2) complete. Result status - (Success).

Verification of (0/0/0) complete. Result status - (Success).

Typing at this point returns the CSTM> prompt. Now type the following:

CSTM> exit

If any tests fail, further diagnosis is necessary.

————— —————

Field Replaceable Units 5

This chapter provides a list of the Field replaceable units (FRUs) and illustrations for the FRU removal and replacement.

The tools required for FRU removal and replacement are as follows:

- #1 Phillips screwdriver with 100–mm (4–in.) blade
- Light–duty, flat–tipped screwdriver with 150–mm (6–in.) blade
- Needlenose pliers

WARNING: For each of the removal procedures in this chapter, you **must** shut down the operating system, power off the system, and unplug the power cord from the wall.

NOTICE: To maintain FCC/EMI compliance, verify that all covers are replaced and that all screws are properly seated.

Table 5-1 lists all the FRUs for the Model 735.

Table 5-1. FRU List

EXCHANGE PARTS	
Part Number	Part Description
A2095-69510	Model 735 Processor Board
A2095-69033	Core I/O Board
A2084-69001	525-MB Single-Ended SCSI Disk Drive
A2084-69002	1.0-GB Single-Ended SCSI Disk Drive
A1094-69012	420-MB Single-Ended SCSI Disk Drive
A1094-69011	210-MB Single-Ended SCSI Disk Drive
A2095-69001	1.0-GB Fast/Wide SCSI Disk Drive
A1094-69521	8-MB SIMM Card
A2512-69001	16-MB SIMM Card
A2517-69001	32-MB SIMM Card
A1094-69531	EISA Interface Card
25525-69001	EISA SCSI Fast, Differential Controller
25567-69001	EISA LAN Adapter
25560-69001	EISA HP-IB Adapter
A1094-69007	Floppy Drive (1.44 MB)
A1659-69001	CRX Color Graphics Controller
A1436-69571	CRX-24 Color Graphics Controller
A1924-69001	GRX Grayscale Graphics Controller
A2094-69001	19-in. Color Monitor (A2094A-SONY) N. Hem.
A1097-69003	19-in. Color Monitor (A1097A,C-Hitachi) N. Hem.
A1097-69004	19-in. Color Monitor (A1097B,D-Hitachi) S. Hem.
A2088-69001	19-in. Grayscale Monitor (A2088A)
NON-EXCHANGE PARTS	
Part Number	Part Description
A1454-69571	CRX-24Z Color Graphics Daughter Card
A2095-66584	LAN AUI Slider Module
A2095-66586	ThinLAN BNC Slider Module
A2095-66580	FDDI LAN Slider Module
A2095-62016	Fast, Wide SCSI Cable (Internal)

(Continued)

Table 5-1. FRU List (Cont.)

NON-EXCHANGE PARTS	
Part Number	Part Description
A1094-60010	Single-Ended SCSI Disk Tray
A2095-00016	Fast/Wide SCSI Disk Tray
A1658-62018	Fast/Wide SCSI Cable (External)
A1658-62024	SCSI Terminator for Fast/Wide
A1094-61604	Single-Ended SCSI Cable (Internal)
A1094-61606	SCSI Floppy Extender Cable (Internal)
A1094-61601	Single-Ended SCSI Cable (External)
A1094-61605	SCSI Device Tray Power Cable
1420-0314	Calendar Battery
1252-3932	SCSI Terminator for Single-Ended
2110-0520	LAN AUI Fuse
A2095-84002	Model 735 Front Label
A1094-60001	Chassis Assembly (Less plastic covers)
5041-2452	Plastic Top Cover
A1094-60003	Bezel for Floppy Drive
A1094-60002	Blank Bezel
0950-2081	Power Supply
A1094-66500	Backplane Assembly
A1094-62022	Deskside Pedestal
5061-6572	Large Cooling Fan
5061-6573	Small Cooling Fan
A1094-66540	LED Display Card
A1094-61062	LED Cable
A1094-66541	Switch Card
A1094-61603	Backplane Cable
2090-0315	19-in. Color Monitor (A2094B) S. Hem.
C1429B #Axx	Keyboard, PC-style (must supply localized option)
46021B #Axx	Keyboard, HP-UX (must supply localized option)
46060-60202	Mouse

For service information and part numbers for the CRX-48Z graphics option, see *HP A2091A Graphics Processor CE Handbook (A2091-90039)*.

Figure 5-1 through Figure 5-15 illustrate how to remove the individual FRUs. Observe the notices and prerequisites for removing each FRU. Replacement is the reverse of removal, unless noted.

Pedestal Feet

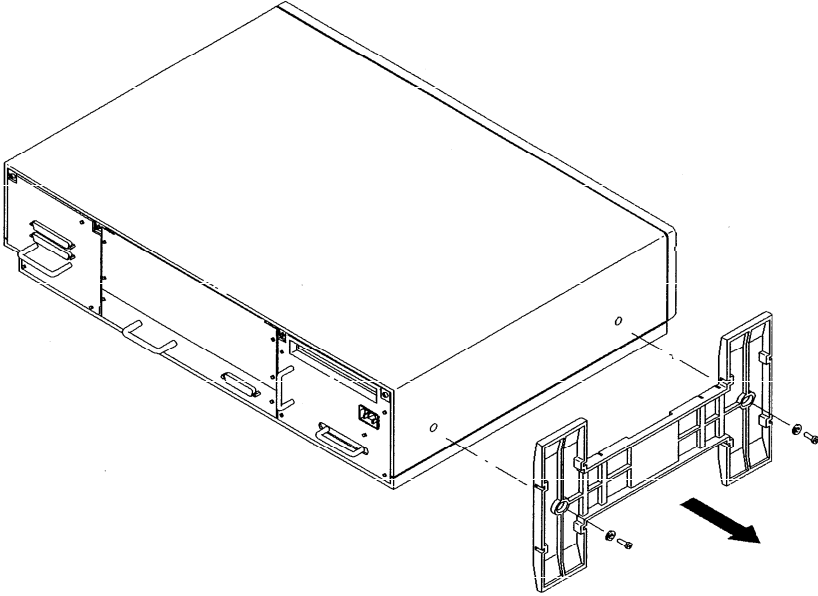

Figure 5-1. Removing Pedestal Feet

Top Cover

Before removing the top cover, remove the pedestal feet (if installed).

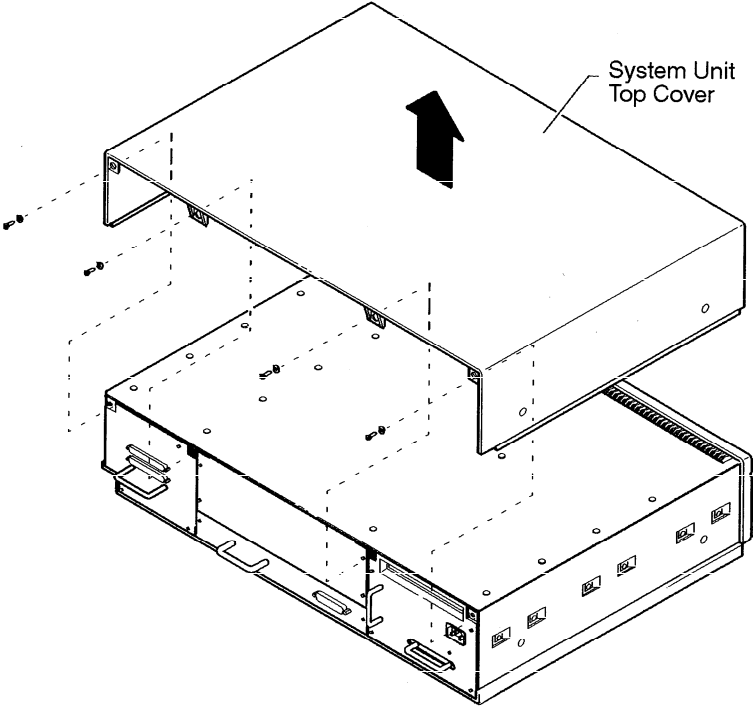

Figure 5-2. Removing Top Cover Screws

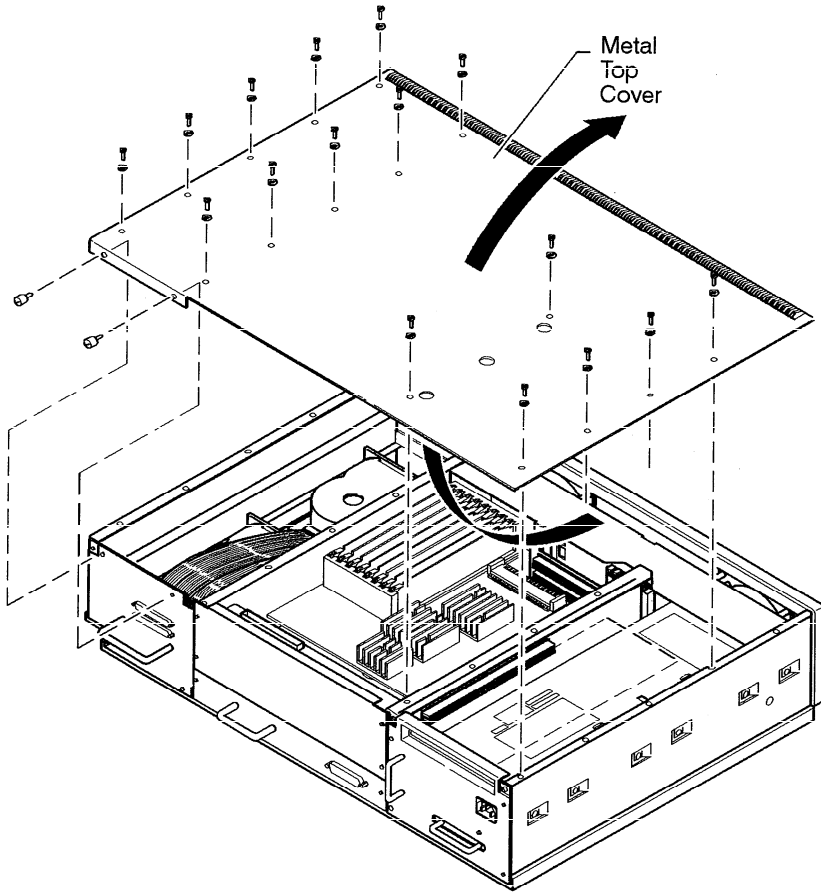

Figure 5-3. Lifting Top Cover

Power Supply

Before removing the power supply remove the EISA card adapter assembly.

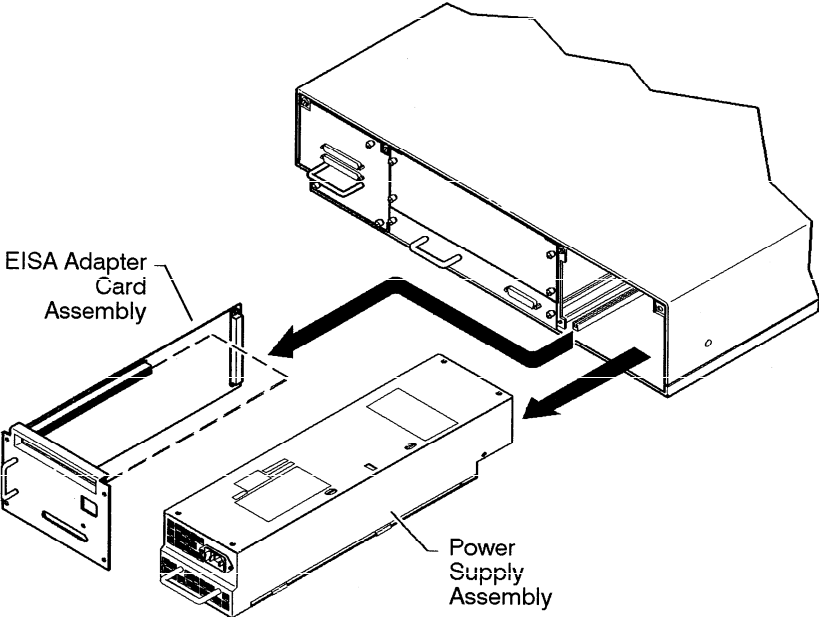

Figure 5-4. Removing the Power Supply

Backplane/Fan Assembly

Before removing the backplane/fan assembly, perform the following steps:

- Remove the pedestal feet.
- Remove the top cover.
- Remove the power supply.
- Remove the graphics card.
- Remove the core I/O card.
- Remove the processor cad.

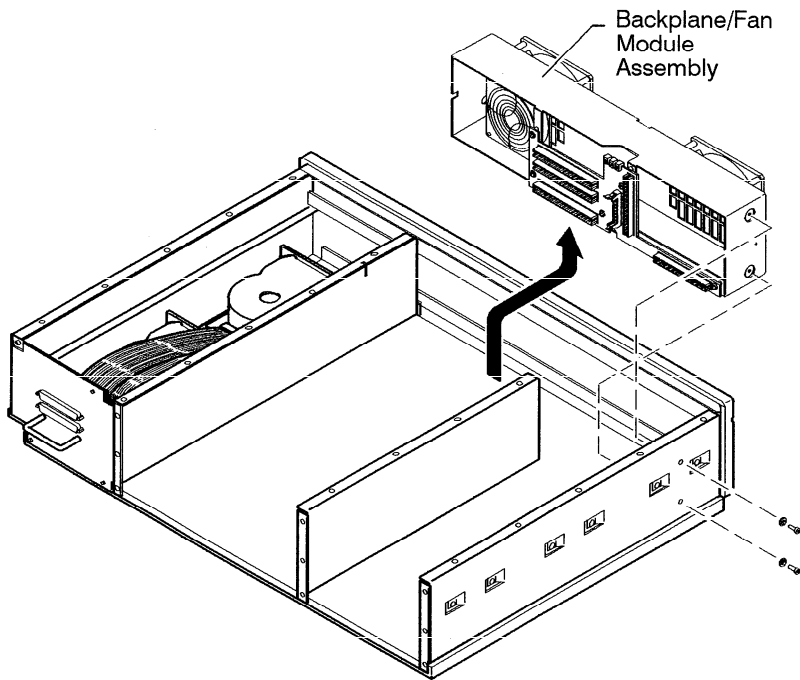

Figure 5-5. Backplane/Fan Removal

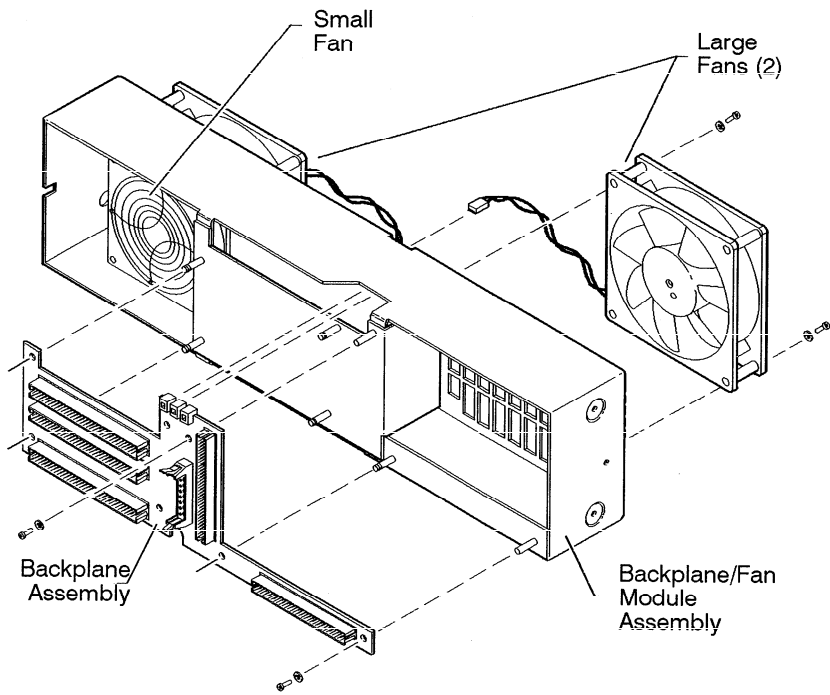

Figure 5-6. Removing the Fans and Backplane Assembly

Disk Drives

Before removing the disk drives disconnect external SCSI cable.

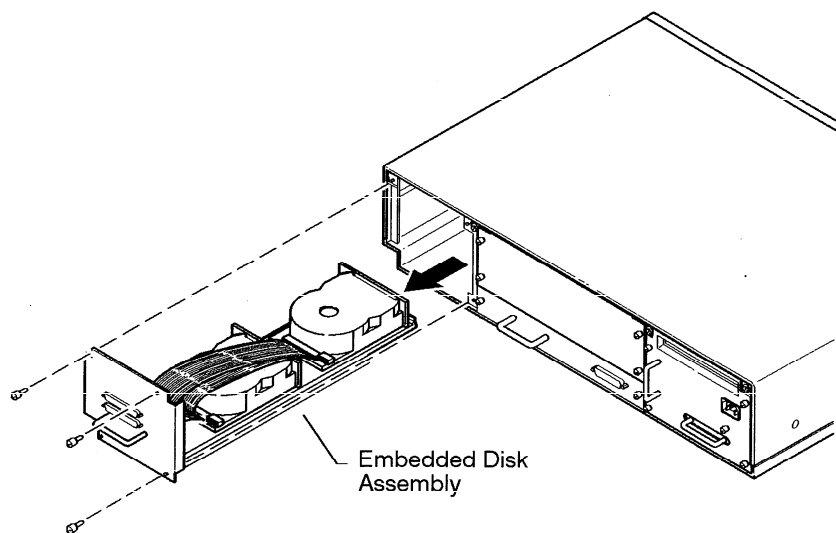

Figure 5-7. Removing the First Disk Drive

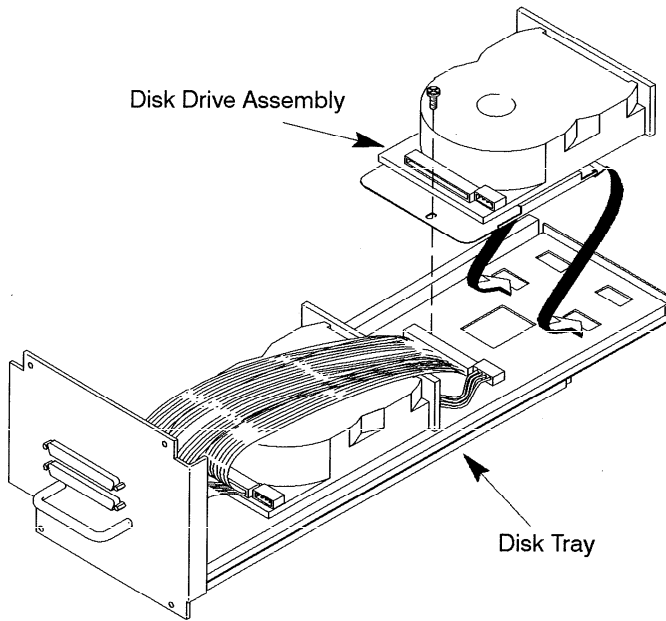

Figure 5-8. Mounting the Disk Drive Assembly on the Disk Tray

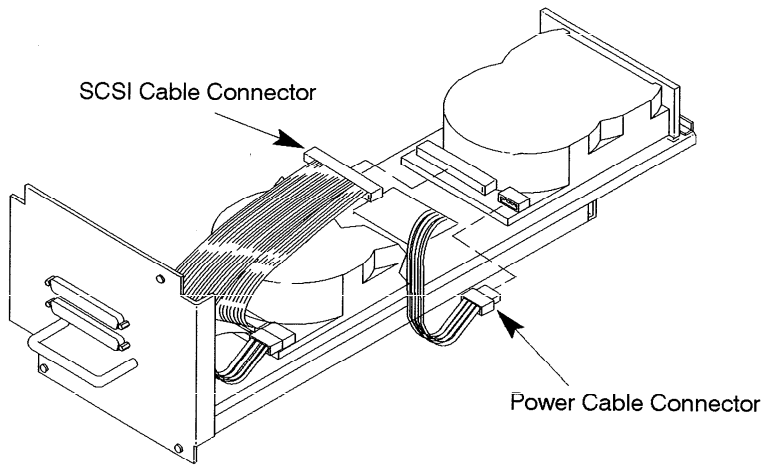

Figure 5-9. Connecting Cables to the Disk

Core I/O and Processor Board

Before removing the Core I/O and Processor Boards, disconnect all internal and external cables.

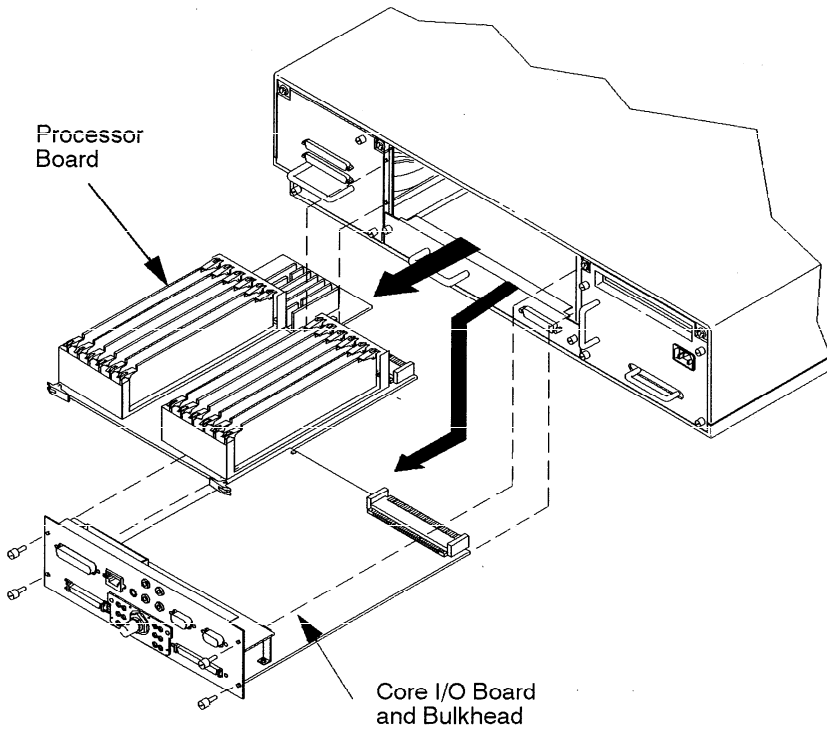

Figure 5–10. Removing the Core I/O and Processor Boards

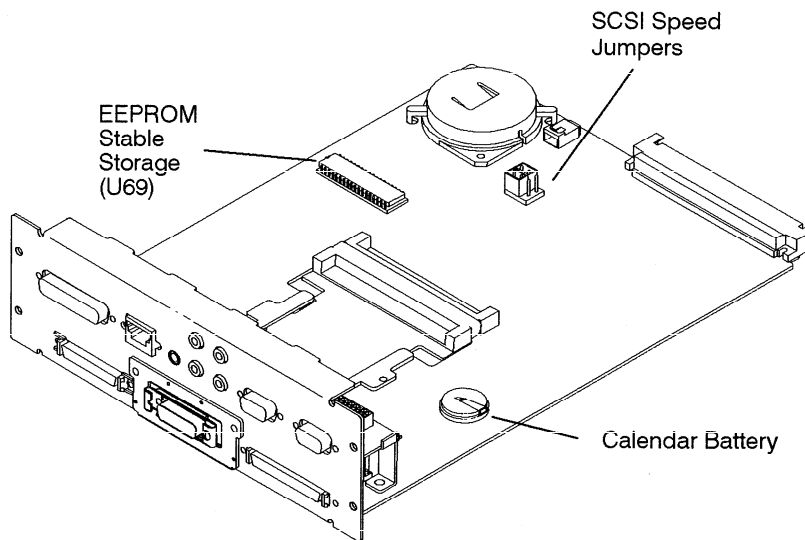

Figure 5-11. Component Locations

System EEPROM

When replacing a processor board, remove the EEPROM from the failed processor board and install it in the new/exchange processor board, as shown in Figure 5-11. Remove the EEPROM from the new processor and place it into the defective processor. (This is required for the board test/repair process.)

NOTICE: The EEPROM on the processor board stores the I/O configuration information. To retain this information when you replace a processor board, move the original EEPROM to the new processor board.

CAUTION: Use an anti-static strap to prevent electrostatic damage to the EEPROM. Electrostatic damage can destroy the EEPROM or erase configuration information from the EEPROM.

Memory

Before removing the memory, perform the following steps:

- Remove the Core I/O Board.
- Remove the Processor Board.

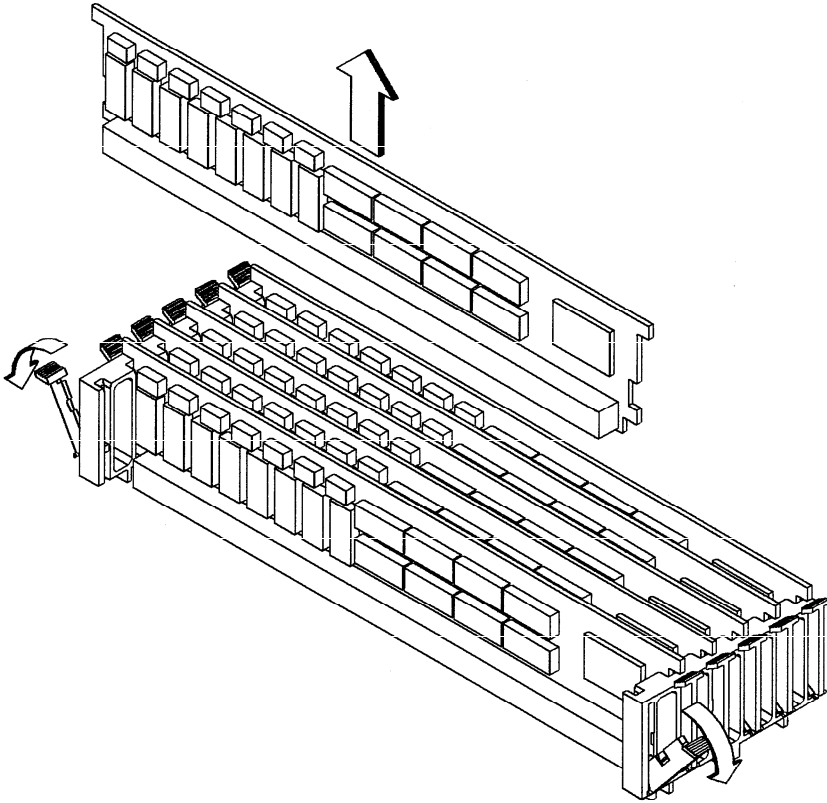

Figure 5–12. Removing Memory Boards

- The Model 735 processor board has 16-MB main memory resident (unremovable). Therefore, the upgraded system will have 16 MB more main memory than the original system.
- The SIMMs must be installed as pairs (two cards of the same capacity).
- The Model 735 has six pairs of slots (numbered 1 through 6).
- The slot pairs on the Model 735 processor board are arranged in two connector blocks, labeled **H**(igh) and **L**(ow). *The pair numbering starts in the middle of the board, one in each connector block.*
- You load the boards left to right when the board is positioned as shown in Chapter 3. Start with the highest number **H** slot *that will be occupied* when installing the memory cards in the new processor board (if you are installing four pairs of cards, slot **4H** is the highest number **H** slot). You must then fill the lower number slots in the **H** block. You then fill the lower numbers in the **L** block, working toward the highest number **L** slot that will be filled.
- If you later need to add more SIMM cards, you will need to remove the cards already installed in the **H** block, and start installing the cards at the highest number slot to be used. The cards already installed in the **L** block may remain installed; just add the new cards to the higher numbered slots. Be sure that the SIMMs remain paired properly (two cards of the same capacity occupying the same slot number in the **H** and **L** blocks) when you add new cards.

Calendar Battery

Before removing the calendar battery, remove the Core I/O Board.

CAUTION: Discard battery according to manufacturer's instructions.

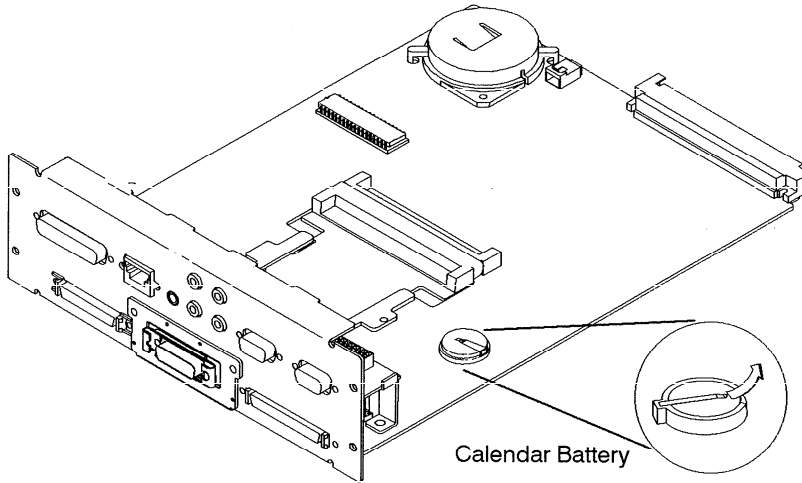

Figure 5-13. Removing the Calendar Battery

LAN Slider Module

Before removing the LAN slider module, remove the Core I/O Board.

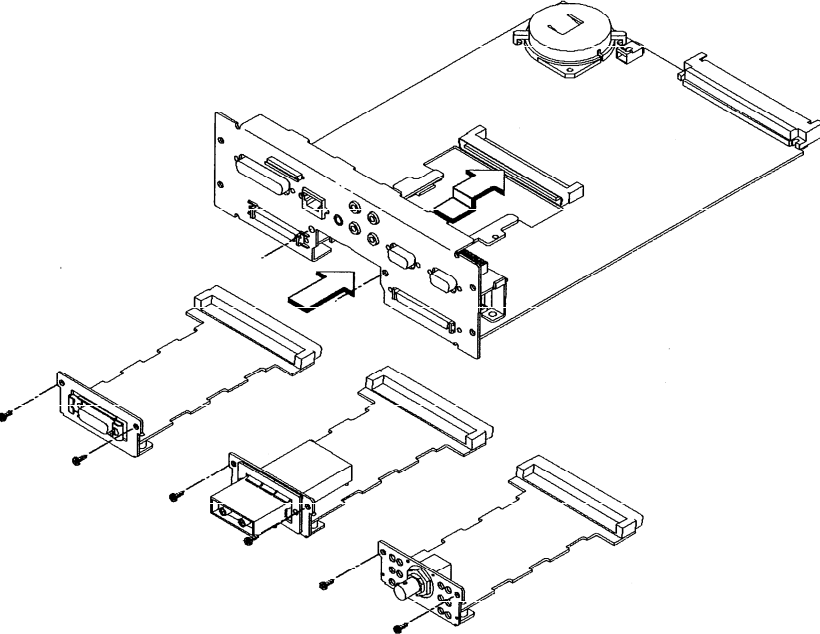
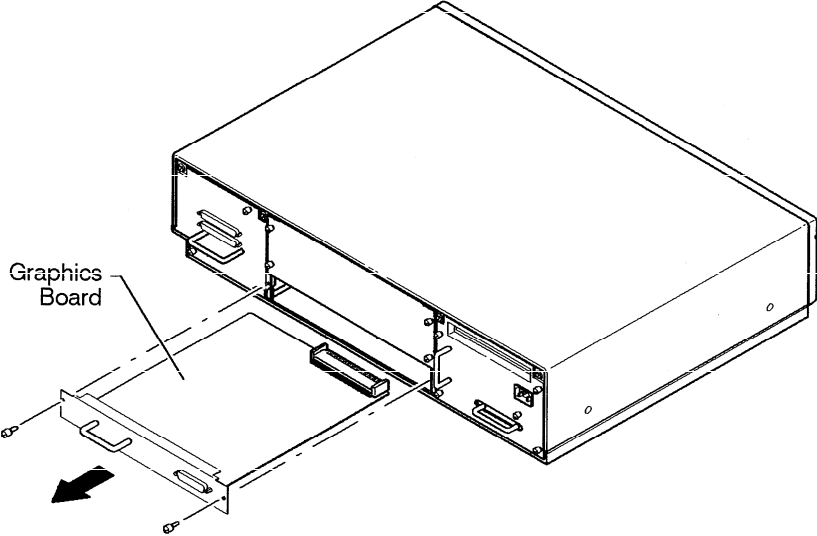

Figure 5-14. LAN Slider Module Removal

Graphics Board

Before removing the Graphics Board, disconnect cables.



Front Control Panel

Before removing the front control panel, perform the following steps:

- Remove the pedestal feet.
- Remove the top cover.
- Remove the disk tray.

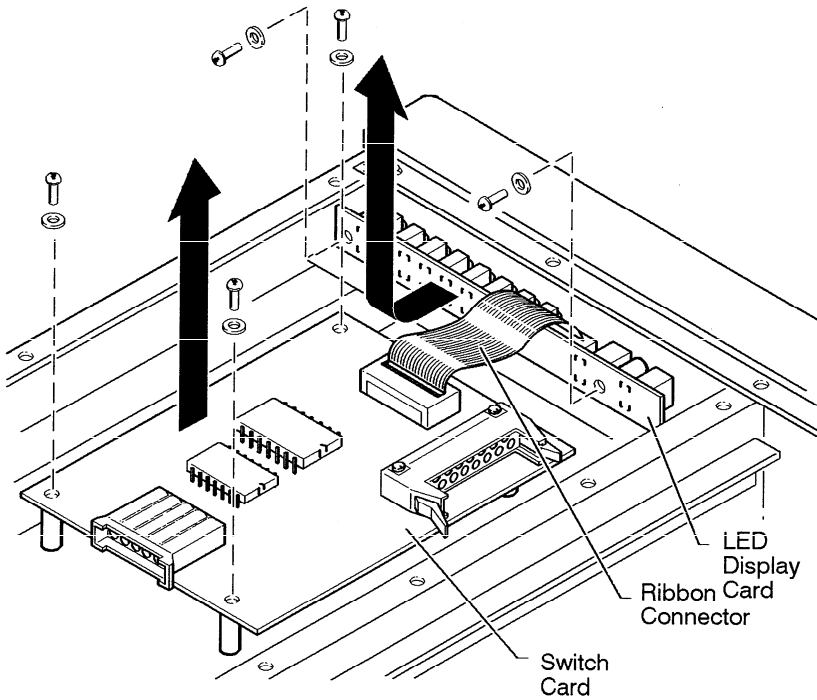

Figure 5-15. Removing the Front Control Panel



Diagrams

6

Figure 6-1 shows the system block diagram.

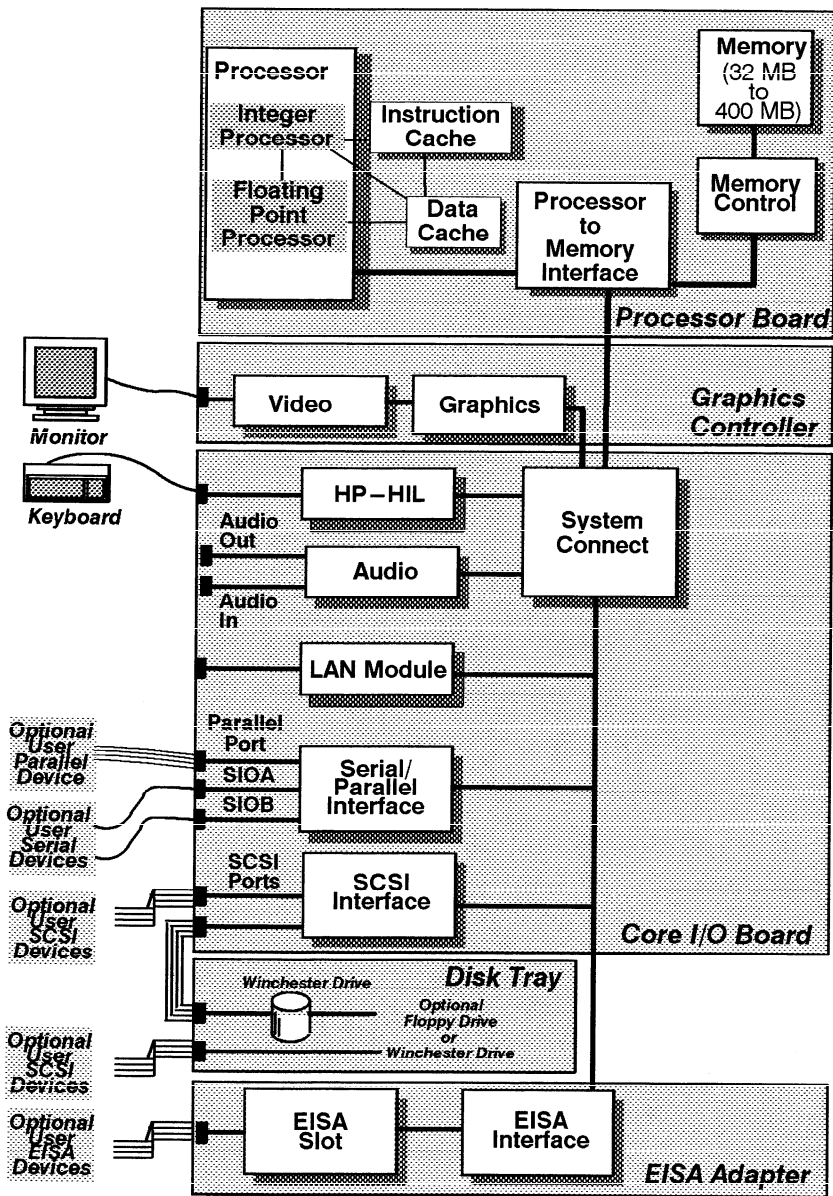

Figure 6-1. System Unit Functional Block Diagram



Reference

7

This chapter provides part numbers and titles to documents which can be used for reference.

Installation Manual

A2095-90000 HP Apollo 9000 Series 700 Model 735
Hardware Installation Guide

Service Manuals

A2095-90002 HP Apollo 9000 Series 700 Model 735
Customer Eng. Service Handbook
A2091-90039 HP A2091A Graphics Processor CE Handbook
09704-90041 Precision Architecture RISC: HP Apollo 9000 Series 700
Diagnostic Manual
B2355-9003 System Administrator's Task Manual HP Apollo 9000 Series 700
5960-1511 Servicing Hewlett-Packard Workstation Monitors

Reference Manuals

A2095-90001 HP Apollo 9000 Series 700 Model 735 Owner's Guide
A2512-60000 Installing Additional Memory in the HP Apollo 9000 Series 700
Model 735
A2563-90000 SCSI Disk Drive Installation Guide
A1984-90001 SCSI Floppy Disk Drive Installation Guide
A2665-90000 FDDI Upgrade Instructions



Service Notes

8

Place service notes here.

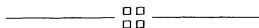

Index

B

- block diagram, 6-2
- boot admin mode, 4-13
- boot command notations, 4-15
- boot failure, 4-12
- boot paths, 4-15
- boot ROM diagnostics, 4-1

C

- calendar battery removal, 5-16
- configuration
 - FRU, 3-1
 - mass storage, 3-1
 - memory, 3-12
- connectors
 - monitor, 1-13
 - system unit, 1-7
 - ac, 1-7
 - audio, 1-10
 - graphics, 1-12
 - HP-HIL, 1-8
 - network, 1-8
 - parallel, 1-8
 - RS-232, 1-9
 - serial, 1-9
- Controls
 - monitor, 1-13
 - system unit, 1-3
- CPU components locations, 5-13

CPU removal, 5-12

D

- diagnostics, 4-1
 - boot ROM, 4-1
- diagrams, block diagram, 6-2
- documentation, reference, 7-1

E

- EEPROM, data storage, 5-13
- environmental specifications, 2-1

F

- fan removal, 5-9
- first disk removal, 5-10
- front control panel removal, 5-19
- FRU configuration, 3-1
- FRU parts list, 5-2
- FRU removal
 - calendar battery, 5-16
 - CPU, 5-12
 - fan, 5-9
 - first disk, 5-10
 - front control panel, 5-19
 - memory, 5-14
 - pedestal feet, 5-4
 - power supply, 5-7

top cover, 5-5

I

installing memory cards, 3-13

ISL commands, 4-17

ISL diagnostics, 4-18

ISL environment, 4-15

J

jumpers, SCSI ID

HP Winchester drive, 3-8,
3-10

Micropolis drive, 3-9

Quantum drive, 3-6

Seagate drive, 3-7

L

LED error codes, 4-2

LEDs, 4-2

system unit, 1-5

M

mass storage configuration, 3-1

memory configuration, 3-12

memory removal, 5-14

monitor

connectors, 1-13

controls, 1-13

Index-2

N

network, connector, 1-8

P

part numbers, 5-2

pedestal feet removal, 5-4

power supply removal, 5-7

preventive maintenance, 2-2

R

reference documentation, 7-1

regulatory requirements, 2-2

RS-232

connector, 1-9

pinout, 1-9

S

SCSI devices

default IDs, 3-2

terminators, 3-1

SCSI IDs, 3-2

jumpers

floppy drive, 3-11

HP Winchester drive, 3-4,
3-5, 3-8, 3-10

Micropolis drive, 3-9

Quantum drive, 3-3, 3-6

Seagate drive, 3-7

serial

connector, 1-9

pinout, 1-9

service notes, 8-1

specifications, environmental,
2-1

stable storage, 4-14
SupportWave diagnostics, 4-19

T

terminators, 3-1
top cover removal, 5-5

troubleshooting, boot failure,
4-12

troubleshooting, 4-1
ISL commands, 4-17
ISL diagnostics, 4-18
ISL environment, 4-15
LED codes, 4-2
SupportWave diagnostics,
4-19

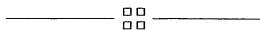

Documents for this printer should have 1/4" margins on all sides.
The following items are outside the printable region and may cause the printer
to print the page incorrectly:

Rule(s) on page 0 of job.

Character(s) on page 84 of job.

Character(s) on page 86 of job.