



9895A Flexible Disc Memory User's Manual



Hewlett-Packard Desktop Computer Division
3404 East Harmony Road, Fort Collins, Colorado 80525
(For World-wide Sales and Service Offices see back of manual.)
Copyright by Hewlett-Packard Company 1978

HP Computer Museum
www.hpmuseum.net

For research and education purposes only.

Table of Contents

Chapter 1: Introduction

General Description	5
Technical Specifications	6
Accessories	7
Discs Memory Options	7
Field kits and Accessories	7
Flexible Disc Media	8
Operating Cleanliness	8
Handling Discs	9

Chapter 2: Installation

Unpacking and Inspection	13
Moving the Disc Memory	13
Power Connections	14
Power Requirements	14
Fuses	14
Power Cords	15
Interface Connections	15
Device Address	16
Unit Code	16
Power-On and Testing	17

Chapter 3: Operation

Front Panel Controls	19
Disc Installation	20
Write Protection	21
Disc Structure	21

Chapter 4: Self Test Procedures

Electronics Self Test Procedure	23
Write/Read Self Test Procedure	24
Read Only Self Test Procedure	24



Chapter 1

Introduction

General Description

The HP 9895A Disc Memory is a random-access data storage device utilizing a standard flexible disc medium. Option 010 contains one flexible disc drive. When no option is specified the 9895A contains two disc drives. Either disc memory is capable of controlling one additional 9895A memory.

The disc memory is connected to a controlling device via the HP Interface Bus (HP-IB) system.¹ Many HP computers provide a high-level language subsystem to control the disc memory. After installing and testing the disc memory as described in this manual, refer to the computer's disc programming or subsystem reference manual for details on controlling the disc memory. The specifiers used to refer to the 9895A in several systems are listed in the table below.

System Controller	9895A Identifier (with Default Parameters)
HP 85	D700
HP-9835	H7,0,0
HP 9845	H7,0,0

Note: there are no commas in the HP 85 specifier. D is used for all discs, and the HP 85 automatically determines the type of disc being used.

For information on operating a 9895 with a 1000 series system, consult the 1000 series documentation. The 98228A Mass Storage ROM Manual for the 9825T describes the disc access commands to use the 9895.

¹ The HP-IB is Hewlett-Packard's implementation of IEEE standard 488-1978.

Technical Specifications

Except where noted, all specifications apply to either 9895A or a 9895A Opt. 010.

	9895A Opt. 010	9895A
Number of Drives	1	2
Formatted Storage Capacities:		
HP (double-sided, double density)	1.18 Mbytes	2.36 Mbytes
*IBM (single-sided single density)	256 Kbytes	512 Kbytes
Interface	HP-IB	
Average Access Time	174 msec	
Maximum Access Time	410 msec	
Data Transfer Rates:		
HP format:		
Read Burst	190 kbytes/sec	
Write Burst	190 kbytes/sec	
Buffered ¹	23 kbytes/sec avg.	
IBM format: ²		
Buffered ¹	10 kbytes/sec avg.	
Rotational Speed	360 RPM \pm 3.5%	
Power Source Requirements	100 Vac } 120 Vac } \pm 10% 220 Vac } 240 Vac }	
Line Frequency	50 Hz } \pm 2% 60 Hz }	
Environmental Specs:		
Operating Temperature	10°C to 40°C (50°F to 104°F)	
Relative Humidity	20% to 80% with maximum wet bulb temperature not to exceed (non-condensing) 25.5°C (77.9°F)	
Operating Altitude	0 m to 4572 m (0 ft to 15,000 ft)	
Storage Temperature	-40°C to 60°C (-40°F to 140°F)	
Storage Altitude	-304.8 m to 15,240 m (-1000 ft. to 50,000 ft)	

9895 Current Requirements (In Milliamps)

Voltage Switch Setting	9895A (Dual Drive Master)		9895A Opt. 012 (Dual Drive Slave)		9895A Opt. 010 (Single Drive Master)		9895A Opt. 011 (Single Drive Slave)	
	50 Hz	60 Hz	50 Hz	60 Hz	50 Hz	60 Hz	50 Hz	60 Hz
100 Vac	2080	1880	1800	1620	1400	1260	1090	980
120 Vac	1730	1580	1480	1360	1160	1060	890	820
220 Vac	920	870	800	750	600	570	470	440
240 Vac	800	770	680	650	530	510	400	380

¹ Interleave parameter dependent - best case every other sector.

² Since tolerances on IBM 3740 compatible media are not fully specified by vendors and do vary, HP can't guarantee that IBM 3740 media can be read by the 9895 in every case.

Accessories

The following accessories are supplied with each disc memory.

Description	Quantity	HP Part Number
Slave Cable	1 (option 011 and 012 only)	09895-61606
Power Cord	1	(see page 11)
Flexible Disc	1	(see below)
User's Manual	1	09895-90000
Drive Protector	2	09895-90010

A package of 10 double-sided, double-density discs can be ordered under part number 92195A.

Disc Memory Options

The disc memory can be ordered with any of the following options. To upgrade an existing disc memory, specify the corresponding field installation kit or accessory described in the next section.

Option 001 – 50 Hz Option – The Disc Memory is set up for operation on 50 Hz Line Frequency.

Option 002 – Rack Mount Option – The Disc Memory is equipped for mounting in a 19 inch Instrument Cabinet. (For use with HP rack system also order 30 inch racking support rails — part number 12679B)

Option 010 (Single Drive with Control Board) – Deletes one drive from the 9895A assembly.

Option 011 (Single Drive Slave) – Deletes the controller board and one drive for the 9895A assembly.

Option 012 (Dual Drive Slave) – Deletes the controller board from the 9895A assembly.

Field Kits and Accessories

The following kits are available to convert an existing disc memory. Each must be installed by qualified technical personnel such as an HP Customer Engineer.

HP 9895A Drive Accessory (98952A) – Provides an additional drive and the hardware to convert a 9895A Option 010 to a full 9895A or an Option 011 to Option 012.

HP 98951A Controller Accessory (98951A) – Provides the hardware to convert a slave drive (Option 011 or 012) to a master.

Rack Mount Kit (09895-88022) – Provides the hardware for mounting a disc memory in a 19-inch instrument cabinet. (For use with HP rack system also order 30 inch racking support rails — part number 12679B)

Flexible Disc Media

The storage medium used in the HP 9895A is a flexible disc, commonly called a diskette. The flexible disc is 200mm (7.9 inches) in diameter and has a 38mm (1.5 inch) hole for alignment on the disc drive spindle. The disc is enclosed in a protective plastic jacket with a slot for head access to the recording surface. Both sides of the flexible disc are used for data storage.

By using flexible discs identified as "double-sided", up to 1.2 megabytes of data can be stored on each disc. Double-sided, double-density discs (HP part number 92195A, package of ten) are available from HP's computer supplies catalog. Phone orders may be placed by calling the toll free order number 800-538-8787. The disc memory can also handle single-sided flexible discs, allowing slightly over ¼ megabytes of storage using single density recording and ½ megabytes using double-density recording. Since some storage is used in subsystem overhead, the exact amount available for user storage depends upon the controller subsystem. Refer to the appropriate mainframe programming or reference manual for details.

Each flexible disc must be initialized before it can be used for data storage. The initialization procedure marks each disc track, checks for defective tracks, and may establish file directories. Refer to the mainframe programming or reference manual for the correct procedure.

CAUTION

USE ONLY HP APPROVED MEDIA SINCE THE USE OF NON-APPROVED MEDIA CAN RESULT IN PREMATURE DISC FAILURE OR DAMAGE TO THE 9895A. (CONTACT YOU LOCAL HP SALES AND SERVICE OFFICE FOR A LIST OF APPROVED MEDIA.)

USING NON-HP APPROVED MEDIA FOR ONE TIME ONLY APPLICATIONS SUCH AS DATA INTERCHANGE WILL NOT DAMAGE THE DRIVE OR DESTROY THE MEDIA, BUT IF EXTENDED USAGE IS ANTICIPATED, THE DATA SHOULD BE TRANSFERRED TO MEDIA APPROVED FOR THE 9895A.

For your convenience, HP offers a package of 10 discs for the 9895 (HP part number 92195A).

Operating Cleanliness

To prevent potential damage or data loss, it's extremely important to maintain the cleanliness of the disc and air within the disc drive. The disc drive should not be operated in an environment in which dust, smoke, moisture, oil or chemical vapor, or other foreign matter are present. Also, be sure to strictly follow the disc handling guidelines.

The critical elements involved in the read/write process are shown below. The read/write heads must maintain contact with the disc during read and write operations. Also shown are various types of contaminants and their size relationships. A contaminant particle hard enough and of the right size may scratch either the oxide coating or the head surface. Even if not hard enough to scratch, it may be large enough to lift the head from the surface, causing data errors.

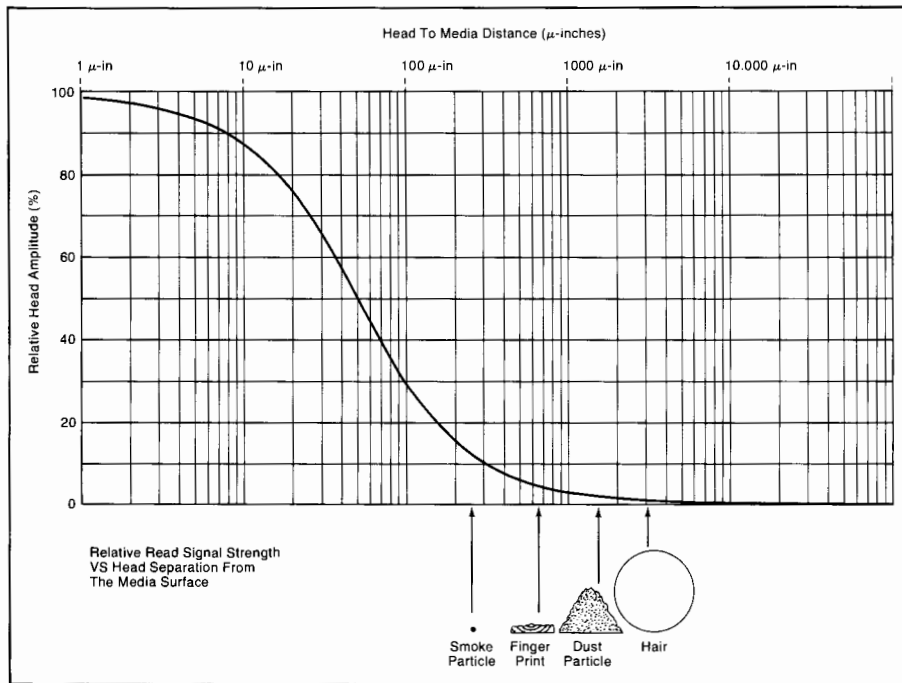

Head/Media Critical Requirements

Data integrity cannot be assured with relative head amplitudes below 50%.

Handling Discs

The flexible disc is basically maintenance free, but it is delicate and **MUST BE HANDLED CAREFULLY**. Remember, the disc contains your valuable data and programs and should be treated accordingly. A good rule of thumb is to treat your disc as you would a valuable record album. Here are some specific Do's and Don'ts to avoid loss of data or damage to your discs.

EVEN A LITTLE CARELESSNESS IN DISC HANDLING CAN DRAMATICALLY REDUCE THE LIFE OF THE DISC.

DO

Backup Discs Frequently

There is always a chance of losing data when mass storage devices are accessed. There are many causes in any computer system — a programming bug, operator error, power failure, or hardware failure. In the case of flexible discs, another mode is possible — media failure from contamination or wearout. **YOUR ONLY PROTECTION AGAINST DATA LOSS IS FREQUENT BACKUP OF YOUR FILES.**

DO

Return Disc To Storage Envelope When Not In Use

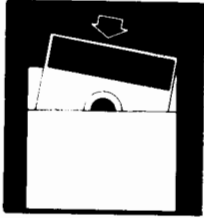

This is the single most important thing to remember about handling your disc because it prolongs disc life by protecting it from dust and scratches. Between uses discs should be stored upright in a dust free container. The box the discs are shipped in, or a similar container, is a good choice.

Operate Your System In A Clean Environment



Airborne contaminants and particles accidentally dropped onto the disc will cause your disc to wear out prematurely and may cause unreliable data storage and retrieval operations. Some of the most common contaminants are DUST, SMOKE, ASHES, ERASER CRUMBS, and BREADCRUMBS. Chemical vapors may also cause premature wearout.

Maintain Proper Temperature And Humidity

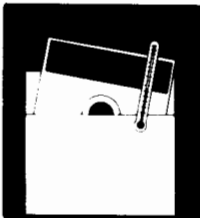

The proper operating range is 10 C (50 F) to 40 C (104 F) and 20% to 80% relative humidity. While temperature is usually easy to control, it may be necessary to make special provisions to keep the humidity in the proper range. Although the disc will continue to operate outside the normal humidity range, it will wear out more quickly and will have a higher error rate.

Avoid Magnetic Fields



Since the data is stored as a pattern of magnetic fields on the disc, it can be erased by an external magnetic field. Avoid placing a disc near power transformers, magnets or large disc memories. Additionally, while HP goes to great lengths to confine the magnetic fields produced by its CRT deflection shields (so well that some of our disc drives are mounted in the same cabinet as the display) CRT's with magnetic deflection systems have been known to wipe out discs, and it is a good idea to avoid placing discs on top of CRT's.

Remove Disc From Drive When Not In Use

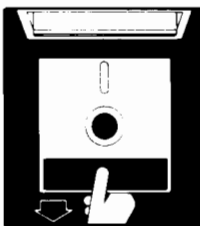

Remove the disc completely from the drive when access is not needed for an extended period of time. The disc continues to rotate as long as it is in a drive which is turned on, even if it is not accessed. This rotation will eventually wear the disc out over long periods of time.

Use A Felt Tip Pen To Label Your Disc

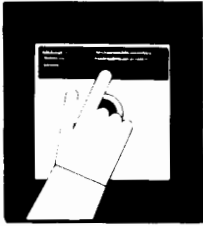

Use a soft felt tip pen to label your disc, and be careful to write only in the label area. Avoid the exposed media while labeling the disc. If possible, write on the large labels provided BEFORE applying them to the disc.

Replace Discs Frequently

Although discs are designed to provide several million revolutions of useful life, they will eventually wear out. The life of a disc is VERY dependent on how carefully it is handled and how much it is used. A disc used sparingly (less than 20 minutes a day) should last over a year. A disc that is used heavily (more than 2 hours a day) should not be expected to last more than 3 months. To be safe, you should copy your data to a new disc and discard the old disc every 3 months for a heavily used disc or at least once a year, even for lightly used discs. If you ever see visible signs of abrasion on the disc, do an immediate backup and discard the worn disc.

DON'T

Do Not Touch The Surface Of The Disc



The thickness of a fingerprint is enough to lift the head off the disc and cause errors (See figure on page 9). The oils in a fingerprint will also collect dust which can cause a disc to wear out sooner than it normally would.

Do Not Bend or Fold the Disc



The disc is flexible but will not operate if it is creased. Using ball point pens, rubber bands, paper clips, etc. can crease the disc.

Do Not Try To Clean A Disc

The inside surface of the disc jacket is covered with a special material that cleans the disc as it rotates. Any other method of cleaning may cause solvent damage to the media or scratch the disc, causing loss of data. If a disc becomes dirty or scratched, immediately transfer the data to a new disc and dispose of the old disc.

CAUTION

IF YOU EVER DESTROY MEDIA (IF IT LOOKS ANYTHING LIKE THE PHOTO BELOW) IN YOUR 9895 STOP USING THE DRIVE UNTIL IT CAN BE SERVICED. THIS IS EXCEPTIONALLY IMPORTANT, AS CONTINUED USE OF THE DRIVE WILL DESTROY MORE MEDIA. IMMEDIATELY CALL YOUR NEAREST HP SALES AND SERVICE OFFICE (SEE THE LIST IN THE BACK OF THIS MANUAL FOR THE NEAREST OFFICE.)

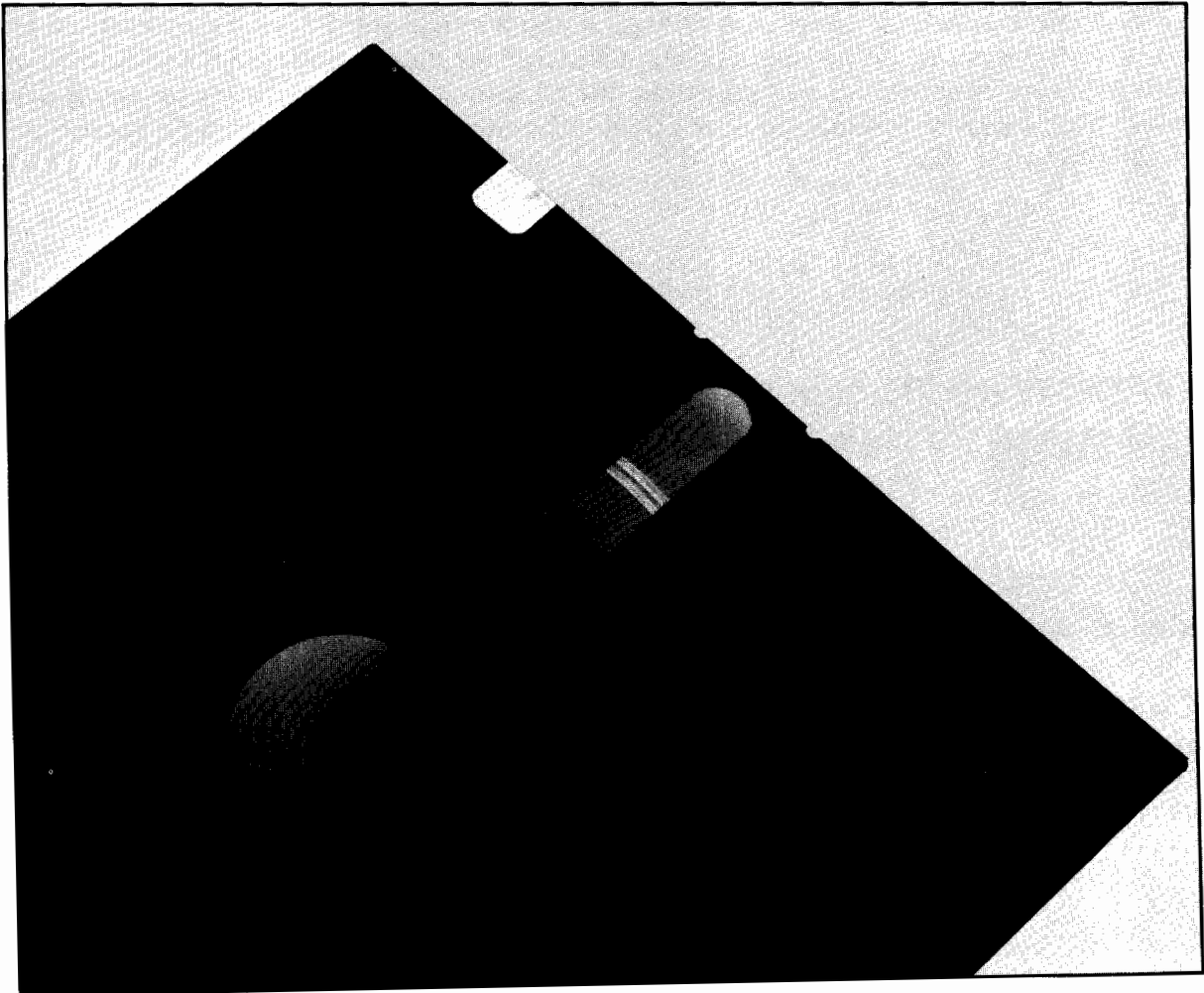



Chapter 2

Installation

Unpacking and Inspection

Your 9895A Disc Memory was carefully inspected, both electrically and mechanically, before shipment. It should be free of scratches and in perfect electrical order upon receipt. Carefully inspect the memory for any physical damage caused in transit. Notify HP and file a claim with the carrier if there is any damage.

Please check to ensure that you have received all of the items which you ordered and that any options specified on your order have been installed. Refer to the Standard Accessories list and Options described on the previous pages.

If you have any difficulties with your system, if it is not operating properly, or if any items are missing, please contact your nearest HP Sales and Service Office; addresses are supplied at the back of this manual.

Moving the Disc Memory

If the disc memory must be moved to a new location, be sure to handle it with care:

- Insert a Drive Protector Card or a scratch disc in each drive and close the door to prevent the read/write heads from contacting each other.
- Be careful when picking up and setting down the disc memory.
- Repack the disc memory in its original shipping carton before transporting it to another site.

CAUTION

THE DISC MEMORY IS A PRECISION INSTRUMENT. A SUDDEN JAR COULD MISALIGN THE READ/WRITE HEADS, RESULTING IN READ ERRORS AND/OR DAMAGED DISCS.

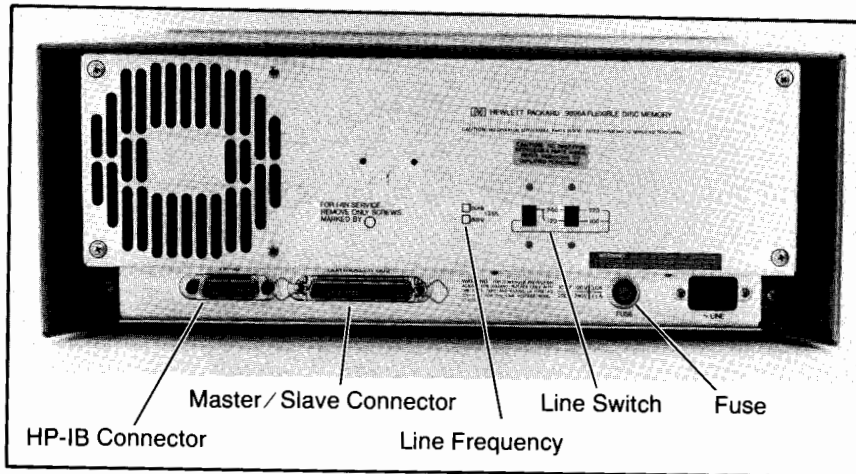

Power Connections

Power Requirements

The disc memory has the following power requirements:

- **Line Voltage:** The disc memory operates from nominal powerline voltages of 100, 120, 220 and 240 Vac. The range of operation is from $\pm 10\%$ of each nominal voltage.
- **Line Frequency:** The disc memory may be modified internally for operation on nominal 50Hz and 60Hz line frequency.
- **Power Consumption:** The disc memory requires a maximum of 180 watts.

The disc memory should already be set to operate on the power line voltage in your area. The setting is indicated on the rear panel (see below). If it is not correct for your local power system, set it according to the switch diagram below. If it is not set for the correct line frequency, as indicated on the rear panel, contact your nearest HP Sales and Service Office, addresses are provided in the back of this manual.

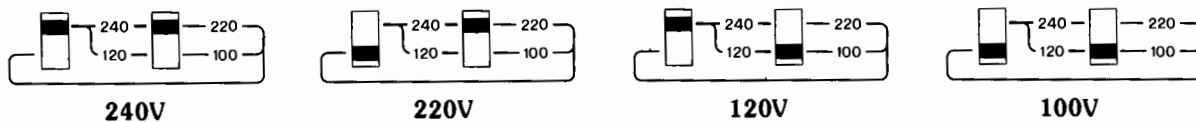

Fuses

Always be sure that the correct fuse is installed. Failure to follow this precaution may result in damage to the disc memory. A different fuse is required for each of the two voltage ranges of 100-120 Vac and 220-240 Vac. Be sure that the fuse on the rear panel is the proper type and rating, as shown below.

Voltage Setting	Fuse Rating	HP Part No.
100,120	3.0 amp (NB)	2110-0003
220,240	1.5 amp (NB)	2110-0043

WARNING

ALWAYS DISCONNECT THE DISC MEMORY FROM ANY AC POWER SOURCE BEFORE CHANGING FUSES.

Power Cords

Power cords with different plugs are available for the equipment; the part number of each cord is shown below. The cord packaged with the equipment depends upon where the equipment is to be delivered. If your equipment has the wrong power cord for your area, please contact your local HP Sales and Service Office.

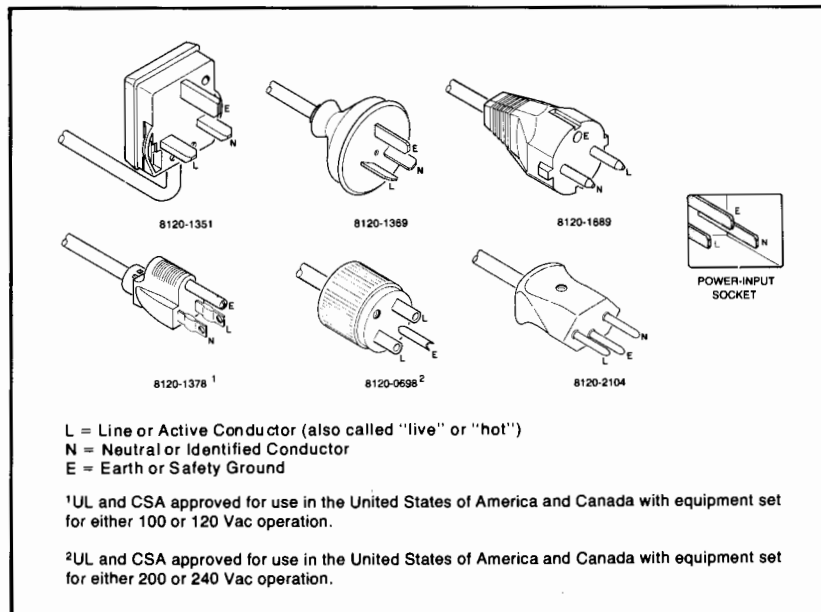

Available Power Cords

WARNING

IF IT IS NECESSARY TO REPLACE THE POWER CORD, THE REPLACEMENT CORD MUST HAVE THE SAME POLARITY AS THE ORIGINAL. OTHERWISE A SAFETY HAZARD MIGHT EXIST IF AN INTERNAL FAILURE OCCURS.

Interface Connections

The disc memory is connected to the controller via an HP-IB Interface Card. The HP-IB cable supplied is connected to the disc memory. Be sure to follow HP-IB cabling guidelines when connecting the system, as described in the interface manual supplied with the controlling device.

To connect a slave disc memory (Option 011 or 012) to the master disc memory, connect the 09895-61606 interface cable supplied with the slave to each disc memory.

NOTE

The HP-IB connector on the slave drive is not usable.

Device Address

Each device in an HP-IB system must be set to a unique device address. The disc memory can be set to any one of eight addresses, ranging from decimal values 0 thru 7. The address is selected via a switch located under the front panel. The switch is preset to device address 0 at the factory. The front cover is removed by pulling out on the lower outside corner of each drive access opening.

Unit Code

Each disc memory controller can handle up to four drives in two disc memories. Since all drives respond to the same device address, each must be set to a unique unit code. The unit codes are factory set to 0 and 1 for a Master Unit and 2 and 3 for a Slave Unit. The unit code is affixed to the front panel under its respective drive.

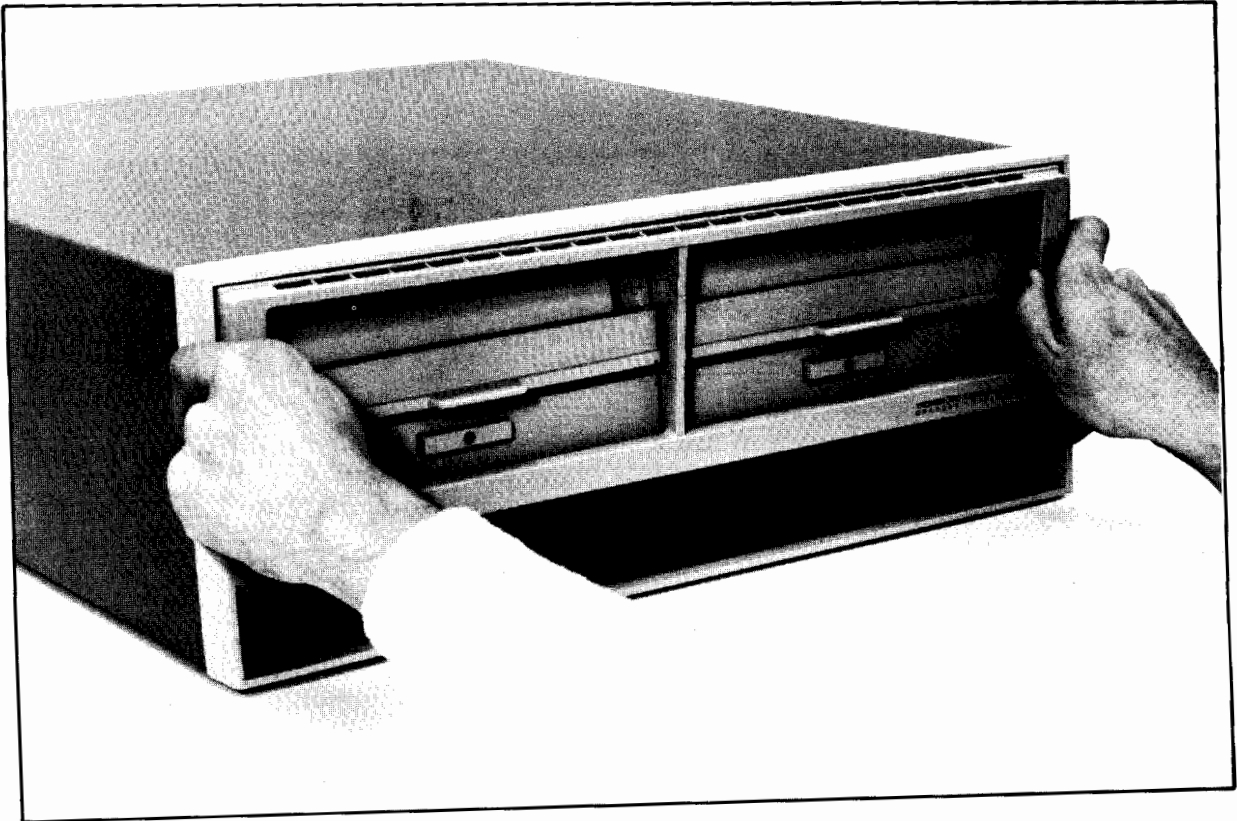

Removing Front Panel

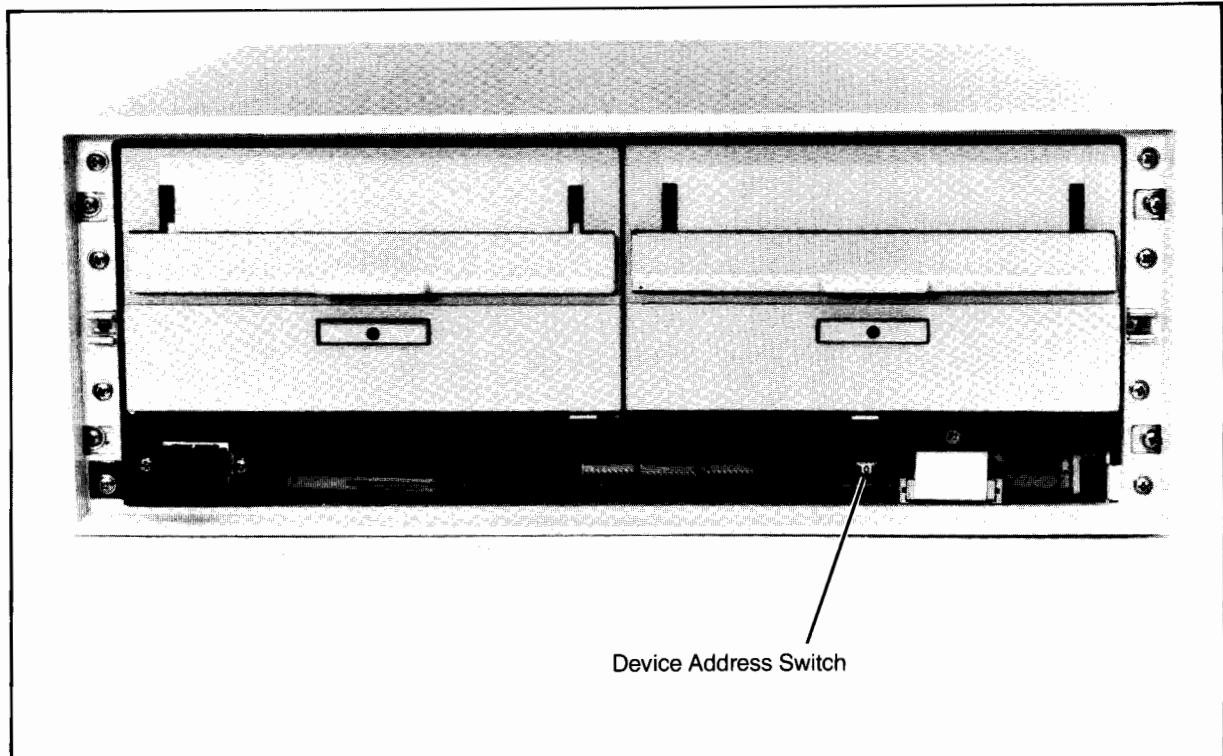

Device Address

Power On and Testing

Once the power and interface connections are complete, switch the disc memory on using the power switch at the left. All HP-IB devices in the system must be switched on before the system can operate. You will hear drive access sounds from the memory. This is part of the self test. The disc memory automatically performs a self test on each drive at power-up. Self tests can also be run manually, as described in Chapter 4.

Chapter 3

Operation

This chapter shows how to handle flexible discs and provides a brief overview of disc structure for the programmer. Since each disc drive is completely controlled by the computer, refer to your computer's programming or subsystem reference manual for details on its disc-control language.

Front Panel Controls

Be sure that each disc drive in the system is switched on before running a program. There is no warm-up period.

There is an indicator on the disc eject button. The light being on indicates that the heads are loaded and the door is locked.

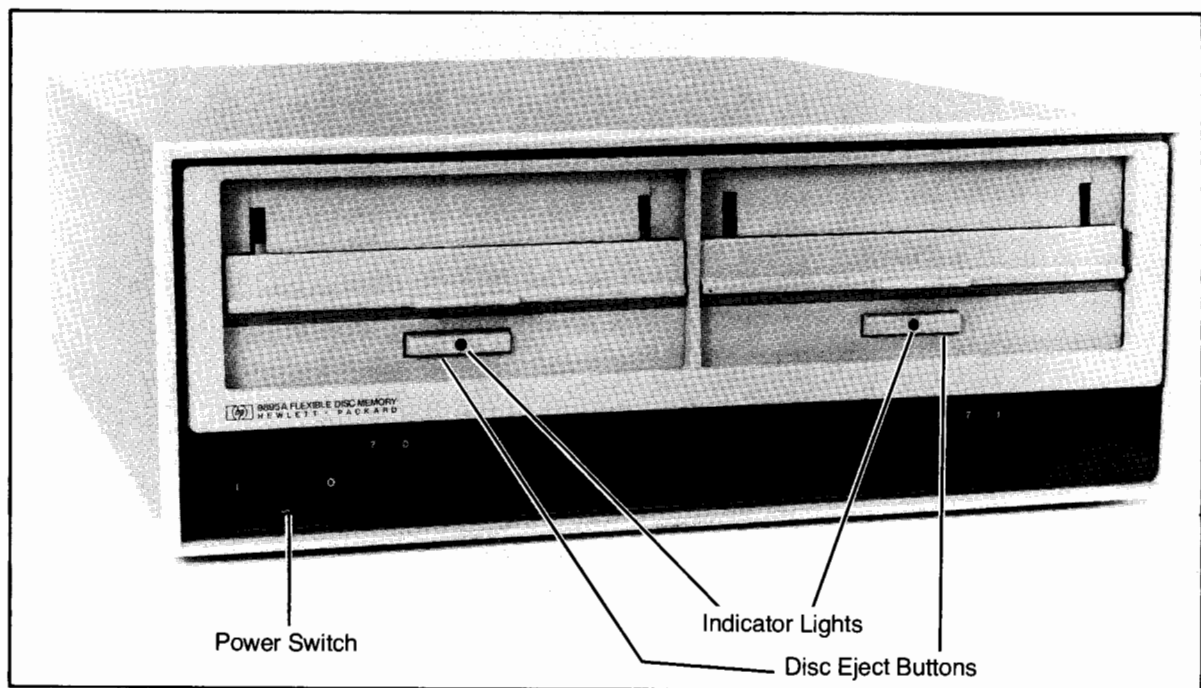

Front Panel Controls

Disc Installation

CAUTION

USE ONLY HP APPROVED MEDIA SINCE THE USE OF NON-APPROVED MEDIA CAN RESULT IN PREMATURE DISC FAILURE OR DAMAGE TO THE 9895A. (CONTACT YOUR LOCAL HP SALES AND SERVICE OFFICE FOR A LIST OF APPROVED MEDIA.)

USING NON-HP APPROVED MEDIA FOR ONE TIME ONLY APPLICATIONS SUCH AS DATA INTERCHANGE WILL NOT DAMAGE THE DRIVE OR DESTROY THE MEDIA, BUT IF EXTENDED USAGE IS ANTICIPATED, THE DATA SHOULD BE TRANSFERRED TO MEDIA APPROVED FOR THE 9895A.

For your convenience, HP offers a package of 10 discs for the 9895 under part number 92195A.

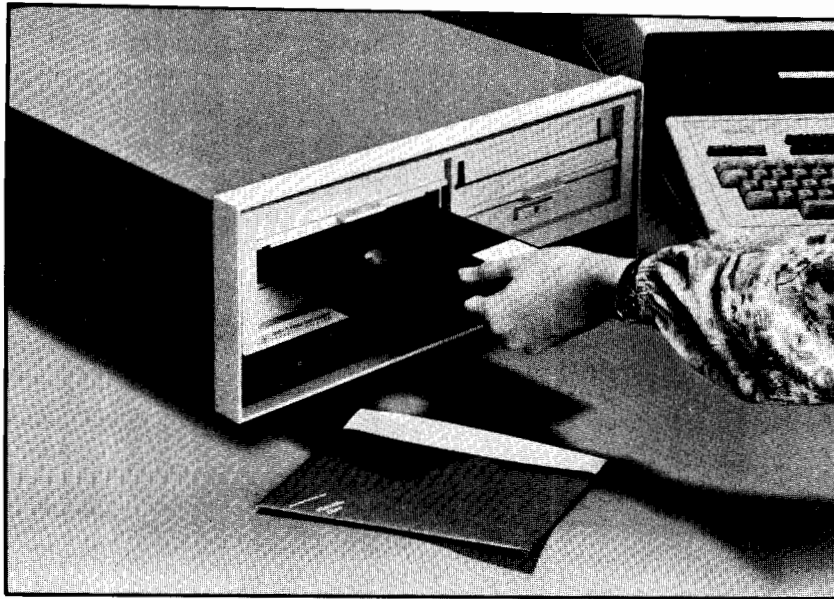

Follow these steps to install a disc:

1. Open the door of the drive by pushing in on the small button on the front of the drive (below the door).
2. Remove the disc from its protective envelope and carefully slide it into the drive, label-side up and nearest you, until you hear a click.
3. Close the door by pressing down firmly on the bar until the door locks. The disc can be installed with power on without harming the disc.
4. Remove the disc by pressing the button on the front of the drive. Always remove each disc and store it in the protective envelope to ensure prolonged disc life.



Write Protection

Data and programs stored on a flexible disc can be protected from being written over. The disc is “write-protected” by uncovering a notch in the sealed protective jacket. When the notch is covered, as shown below, writing is allowed. HP discs are supplied with the notch covered, enabling you to write on the disc. Any opaque tape, can also be used. **Remember, fingerprints can be disastrous to your data, so be careful not to touch the surface of the disc.**

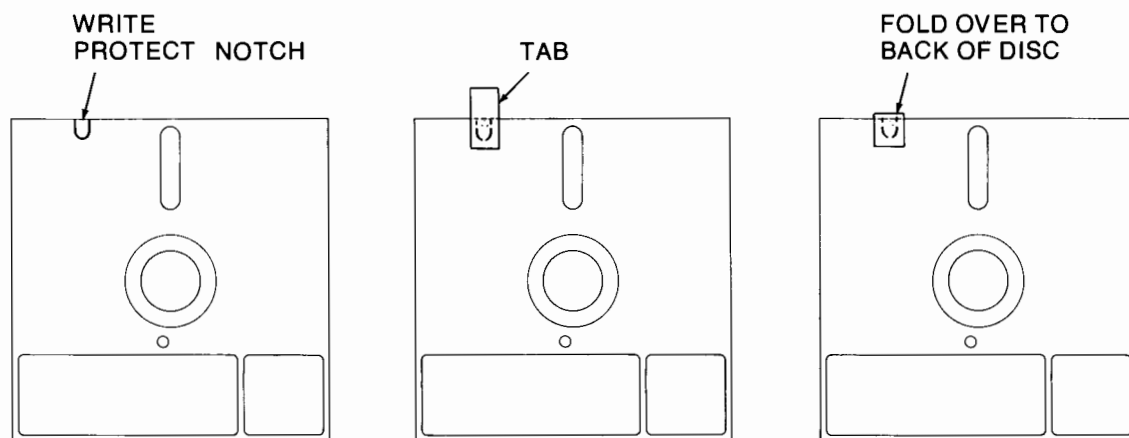

Disc Structure

The flexible disc is a circle of plastic 200 mm (7.9 inches) in diameter, enclosed in a sealed black plastic jacket. Bonded into the surface of the disc is a ferromagnetic iron oxide with characteristics similar to magnetic tape. Data is stored in the form of binary digits represented by magnetized spots on the disc. Information is stored and retrieved by read / write heads that come in contact with the disc's upper and lower surfaces.

Data is stored in concentric tracks on each side of the disc. Each disc has 77 circular tracks, numbered 0 thru 76. Each track is subdivided into either 30 sectors using HP format or 26 sectors using IBM format. Each sector contains either 256 bytes of data using HP format or 128 bytes using IBM format. The data contained in one sector is the smallest amount of information that can be written at a time. The disc is soft sectored, that is, there is no hardware indication of where each sector starts. Instead, the beginning of each sector is indicated by information recorded on the disc.

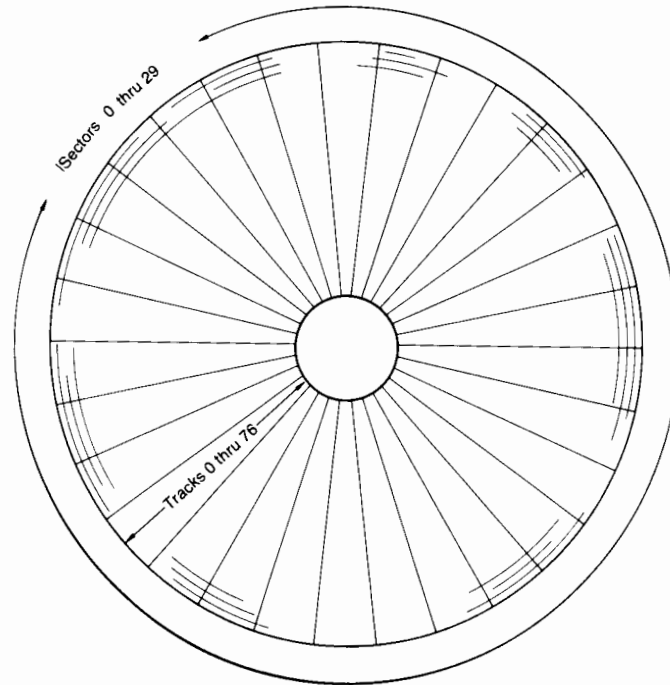

The file structure and available data-access methods depend on the computer language. Most computers require add-on language enhancements to enable disc control. Some computers have built-in mass storage commands for fundamental data and program storage. For advanced mass storage control, however, a Mass Storage ROM or disc subsystem is needed. For complete information on file structure and data-access methods, refer to the mass storage programming or subsystem reference manual supplied with your system.

Chapter 4

Self Test Procedures

The disc memory automatically performs an electronics self test on each drive at power-up. This causes the drive access sounds you hear when the machine is powered up. Manual access to the electronics self test, along with two other tests is described below.

NOTE

The LED patterns discussed in this chapter may be disturbed by an external controller. Therefore, **always disconnect the HP-IB Cable from the 9895A before performing the self tests.**

Electronics Self Test Procedure

Remove the front cover by pulling out on the lower outside corner of each disc access opening (see page 12). Beneath the drive unit you will see the front edge of a printed circuit board. On the board are two switches and a group of five light emitting diodes (LED's). The LED's indicate the status of the self-test. If they are blinking, self-test is being run. If they stop blinking and display a pattern, self-test has failed, with the failed test number displayed on the four left-most LED's. If only the right-most LED is lit, then self-test has completed successfully.

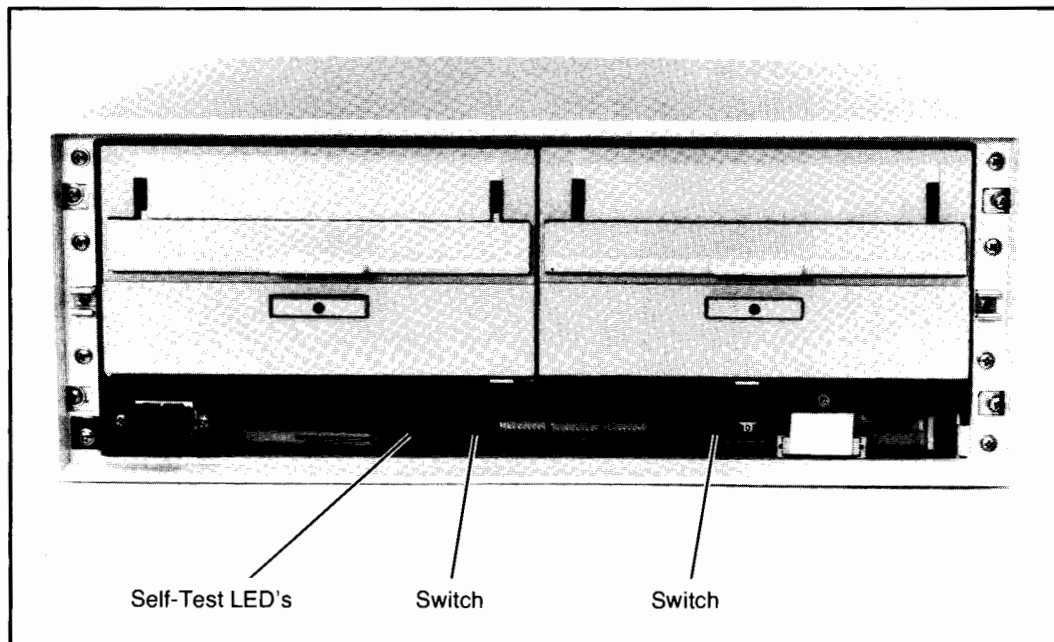

To repeat the self test, press and release the right-most switch. The LED's should blink as the self test routine progresses, then stop, with the right-most LED lit.

Passed all tests

OOOO●

If any other pattern appears, try rerunning the test. If the 9895 fails the test again, call your local HP Sales and Service Office.

Write / Read Self Test Procedure

CAUTION

USE ONLY A SCRATCH DISC WHEN RUNNING THIS SELF TEST SINCE THE TEST ERASES DATA ON THE DISC. THE DISC SHOULD NOT CONTAIN USEFUL DATA.

A more elaborate test, the write / read self test is run using the following procedure:

1. Install a non-write protected disc in each drive. (This disc must **not** contain any valuable information, as the test will alter the contents of the disc.)
2. Press and hold the left-most switch.
3. While holding the left-most switch, press the right-most switch.
4. Release the right-most switch, and then the left-most switch. The self test should start.

This test will check everything in the preceding test, and in addition will write on the disc and then read back, comparing what is read with what it wrote. This process checks the write / read circuitry and the CRC generator / checker.

Read Only Self Test Procedure

NOTE

The disc used in this self test **must** be formatted, but need not contain any other information.

A read only self test is also provided. To perform the self test insert a formatted disc in each drive in your system. Next depress and hold the righthand self test switch. A soft clicking will be heard at approximately two second intervals, and the LED's will flicker. If a test is failed, the clicking will stop with the LED's indicating the test failed. Otherwise, the clicking will continue for approximately 1½ minutes per drive in your system, and the LED's will end up in the all tests passed configuration (rightmost LED lit). After the test has been completed, or has been terminated due to failure, release the switch.



HEWLETT PACKARD

SALES OFFICES

AFRICA, ASIA, AUSTRALIA

ANGOLA

Telectra
Empresa Técnica de Equipamentos
Eléctricos, S.A.R.L.
R. Barbosa Rodrigues, 41-1° DT. °
Caixa Postal, 6487

Luanda

Tel: 35515/6
Cable: TELECTRA Luanda

AUSTRALIA

Hewlett-Packard Australia Pty. Ltd.
31-41 Joseph Street
Blackburn, Victoria 3130
P.O. Box 36

Doncaster East,

Victoria 3109

Tel: 896351

Cable: 31-024

Cable: HEWPARD Melbourne

Hewlett-Packard Australia Pty. Ltd.

31 Bridge Street

Pymble

New South Wales, 2073

Tel: 4496566

Telex: 21561

Cable: HEWPARD Sydney

Hewlett-Packard Australia Pty. Ltd.

153 Greenhill Road

Parkside, S.A., 5063

Tel: 2725911

Telex: 82536

Cable: HEWPARD Adelaide

Hewlett-Packard Australia Pty. Ltd.

141 Stirling Highway

Nedlands, W.A. 6009

Tel: 3865455

Telex: 93859

Cable: HEWPARD Perth

Hewlett-Packard Australia Pty. Ltd.

121 Wollongong Street

Fyshwick, A.C.T. 2609

Tel: 804244

Telex: 62650

Cable: HEWPARD Canberra

Hewlett-Packard Australia Pty. Ltd.

5th Floor

Teachers Union Building

495-499 Boundary Street

Spring Hill, Queensland

4000

Tel: 2291544

Cable: HEWPARD Brisbane

BANGLADESH

The General Electric Co. of

Bangladesh Ltd.

Magnet House 72

Dilkusha Commercial Area

Motijheel, Dacca 2

Tel: 252415, 252419

Telex: 734

Cable: GECDAC Dacca

ETHIOPIA

Abdella Abdulmaik

P.O. Box 2635

Addis Ababa

Tel: 11 93 40

GUAM

Guam Medical Supply, Inc.

Suite C, Airport Plaza

P.O. Box 8947

Tamuning 96911

Tel: 646-4513

Cable: EARMED Guam

HONG KONG

Hewlett-Packard Hong Kong Ltd.

Room 105, Austin Centre

1st Floor

21 Austin Avenue

TST P.O. Box 98524

Kowloon

Tel: 3-697446 (5 lines)

Telex: 36678 HX

Cable: HEWPACK Hong Kong

Medical/Analytical Only

Schmidt & Co. (Hong Kong) Ltd.

Wing On Centre, 28th Floor

Connaught Road, C.

Hong Kong

Tel: 5-455644

Telex: 74766 SCHMX HX

INDIA

Blue Star Ltd.

Sahas

414/2 Vir Savarkar Marg

Prabhadevi

Bombay 400 025

Tel: 45 78 87

Telex: 011-4093

Cable: FROSTBLUE

Blue Star Ltd.

Band Box House

Prabhadevi

Bombay 400 025

Tel: 45 73 01

Telex: 011-3751

Cable: BLUESTAR

Blue Star Ltd.

Bhavdeep

Stadium Road

Ahmedabad 380 014

Tel: 43922

Telex: 012-234

Cable: BLUEFROST

Blue Star Ltd.

7 Hare Street

Calcutta 700 001

Tel: 23-0131

Telex: 021-7655

Cable: BLUESTAR

Blue Star Ltd.

Bhandari House

91 Nehru Place

New Delhi 110 024

Tel: 682547

Telex: 031-2463

Cable: BLUESTAR

Blue Star Ltd.

11 Magarath Road

Bangalore 560 025

Tel: 55668

Telex: 0845-430

Cable: BLUESTAR

Blue Star Ltd.

Meeakshi Mandiram

XXXXV / 1379-2 Mahatma

Gandhi Rd.

Cochin 682 016

Tel: 32069

Telex: 085-514

Cable: BLUESTAR

Blue Star Ltd.

1-1-117/1 Sarojini Devi Road

Secunderabad 500 033

Tel: 70126

Telex: 0155-459

Cable: BLUESTAR

Blue Star Ltd.

133 Kodambakkam High Road

Madras 600 034

Tel: 82057

Telex: 041-379

Cable: BLUESTAR

INDONESIA

BERCA Indonesia P.T.

P.O. Box 496/Jkt.

Jln. Abdul Muis 62

Jakarta

Tel: 349255, 349886

Telex: 46748 BERSIL IA

Cable: BERSAL

BERCA Indonesia P.T.

P.O. Box 174/Sby.

23 Jln. Jimerto

Surabaya

Tel: 42027

Cable: BERCACON

JAPAN

Yokogawa-Hewlett-Packard Ltd.

29-21, Takaido-Higashi 3-chome

Suginami-ku, **Tokyo** 168

Tel: 03-331-6111

Telex: 232-2024 YHP-Tokyo

Cable: YHPMARKET TOK 23 724

Yokogawa-Hewlett-Packard Ltd.

Chuo Bldg., 4th Floor

4-20, Nishinakajima 5-chome

Yodogawa-ku, **Osaka**-shi

Osaka, 532

Tel: 06-304-6021

Telex: 523-3624

Yokogawa-Hewlett-Packard Ltd.

Sunitomo Seimei Nagaya Bldg.

11-2 Shimosasajima-cho,

Nakamura-ku, **Nagoya**, 450

Tel: 052 571-5171

Yokogawa-Hewlett-Packard Ltd.

Tamagawa Building

2-24-1 Tsuruya-cho

Kanagawa-ku

Yokohama, 221

Tel: 045-312-1252

Telex: 382-3204 YHP YOK

Yokogawa-Hewlett-Packard Ltd.

Mito Mitsui Building

105, 1-chome, San-no-maru

Mito, Ibaragi 310

Tel: 0292-25-7470

Yokogawa-Hewlett-Packard Ltd.

Inoue Building

1348-3, Asahi-cho, 1-chome

Atsugi, Kanagawa 243

Tel: 0462-24-0452

Yokogawa-Hewlett-Packard Ltd.

Kumagaya Asahi

Hachijuni Building

4th Floor

3-4, Tsukuba

Kumagaya, Saitama 360

Tel: 0485-24-6563

KENYA

ADCOM Ltd., Inc.

P.O. Box 30070

Nairobi

Tel: 331955

Telex: 22639

Medical Only

International Aeradio (E.A.) Ltd.

P.O. Box 19012

Nairobi Airport

Nairobi

Tel: 336055/56

Telex: 22201/22301

Cable: INTAERIO Nairobi

Medical Only

International Aeradio (E.A.) Ltd.

P.O. Box 95221

Mombasa

KOREA

Samsung Electronics Co., Ltd.

22nd Floor Dongbang Bldg.,

250, 2-KA, Taepyeong-Ro

Chung-Ku,

Seoul

Tel: 777-4886

Telex: SAMSAN 27364

MALAYSIA

Hewlett-Packard Sales

(Malaysia) Sdn. Bhd.

Suite 2.21/2.22

Bangunan Angkasa Raya

Jalan Ampang

Kuala Lumpur

Tel: 483680, 485653

Protel Engineering

P.O. Box 1917

Lot 259, Satok Road

Kuching, **Sarawak**

Tel: 53544

Cable: PROTELENG

MOZAMBIQUE

A.N. Goncalves, Ltd.

162, 1° Apt. 14 Av. D. Luis

Caixa Postal 107

Maputo

Tel: 27091, 27114

Telex: 6-203 NEGON Mo

Cable: NEGON

NEW GUINEA

Hewlett-Packard Australia Pty. Ltd.

Development Bank Building

Ground Floor

Ward Strip

Port Moresby, Papua

Tel: 258933

NEW ZEALAND

Hewlett-Packard (N.Z.) Ltd.

4-12 Cruickshank Street

Kilbirnie, Wellington 3

P.O. Box 9443

Courtney Place

Wellington

Tel: 877-199

Cable: HEWPACK Wellington

Hewlett-Packard (N.Z.) Ltd.

P.O. Box 26-189

169 Manukau Road

Epsom, **Auckland**

Tel: 687-159

Cable: HEWPACK Auckland

Analytical/Medical Only

Northrup Instruments &

Systems Ltd.,

Sturdee House

85-87 Ghuznee Street

P.O. Box 2406

Wellington

Tel: 850-091

Telex: NZ 31291

Northrup Instruments &

Systems Ltd.

Eden House, 44 Khyber Pass Rd.

P.O. Box 9682, Newmarket

Auckland 1

Tel: 794-091

Northrup Instruments &

Systems Ltd.



CANADA

ALBERTA

Hewlett-Packard (Canada) Ltd.
11620A - 168th Street
Edmonton T5M 3T9
Tel: (403) 452-3670
TWX: 610-831-2431

Hewlett-Packard (Canada) Ltd.
210, 7220 Fisher St. S.E.

Calgary T2H 2H8
Tel: (403) 253-2713
TWX: 610-821-6141

BRITISH COLUMBIA

Hewlett-Packard (Canada) Ltd.
10891 Shellbridge Way
Richmond V6X 2W7
Tel: (604) 270-2277
TWX: 610-925-5059

MANITOBA

Hewlett-Packard (Canada) Ltd.
380-550 Century St.
St. James,
Winnipeg R3H 0Y1
Tel: (204) 786-6701
TWX: 610-671-3531

NOVA SCOTIA

Hewlett-Packard (Canada) Ltd.
P.O. Box 931
800 Windmill Road
Dartmouth B3B 1L1
Tel: (902) 469-7820
TWX: 610-271-4482

ONTARIO

Hewlett-Packard (Canada) Ltd.
1020 Morrison Dr.
Ottawa K2H 8K7
Tel: (613) 820-6483
TWX: 610-563-1636

Hewlett-Packard (Canada) Ltd.
6877 Goreway Drive

Mississauga L4V 1M8
Tel: (416) 678-9430
TWX: 610-492-4246

Hewlett-Packard (Canada) Ltd.
552 Newbold Street

London N6E 2S5
Tel: (519) 686-9181
TWX: 610-352-1201

QUEBEC

Hewlett-Packard (Canada) Ltd.
275 Hymus Blvd.

Pointe Claire H9R 1G7
Tel: (514) 697-4232
TWX: 610-422-3022

FOR CANADIAN

AREAS NOT

LISTED:

Contact Hewlett-Packard (Canada)
Ltd. in Mississauga.

CENTRAL, SOUTH AMERICA

ARGENTINA

Hewlett-Packard Argentina S.A.
Santa Fe 2035, Martinez
6140 **Buenos Aires**
Tel: 792-1239, 798-6086
Telex: 122443 AR CIGY
Cable: HEWPACKARG

Biotron S.A.C.I. y M.

Avda. Paseo Colon 221

9 piso

1399 **Buenos Aires**

Tel: 30-4846/1851/8384

34-9356/0460/4551

Telex: (33) 17595 BIO AR

Cable: BIOTRON Argentina

BRAZIL

Hewlett-Packard do Brasil
I.e.C. Ltda.

Alameda Rio Negro, 750

Alphaville

06400 **Barueri** SP

Tel: 429-3222

Cable: HEWPACK São Paulo

Hewlett-Packard do Brasil

I.e.C. Ltda.

Rua Padre Chagas, 32

90000-**Pôrto Alegre**-RS

Tel: 22-2998, 22-5621

Cable: HEWPACK Pôrto Alegre

Hewlett-Packard do Brasil

I.e.C. Ltda.

Av. Epitacio Pessoa, 4664

22471-**Rio de Janeiro**-RJ

Tel: 286-0237

Telex: 02-21905 HPBR-BR

Cable: HEWPACK Rio de Janeiro

CHILE

Jorge Calcagni y Cia. Ltda.

Arturo Burtle 085

Casilla 16475

Correo 9, **Santiago**

Tel: 220222

Telex: JCALCAGNI

COLOMBIA

Instrumentación

Henrik A. Langebaek & Kier S.A.

Carrera 7 No. 48-75

Apartado Aéreo 6287

Bogotá, 1 D.E.

Tel: 269-8877

Telex: 44400

Cable: AARIS Bogotá

Instrumentación

H.A. Langebaek & Kier S.A.

Carrera 63 No. 49-A-31

Apartado 54098

Medellin

Tel: 304475

COSTA RICA

Científica Costarricense S.A.

Avenida 2, Calle 5

San Pedro de Montes de Oca

Apartado 10159

San José

Tel: 24-38-20, 24-08-19

Telex: 2367 GALGUR CR

Cable: GALGUR

ECUADOR

CYEDE Cia. Ltda.

P.O. Box 6423 CCI

Av. Eloy Alfaro 1749

Quito

Tel: 450-975, 243-052

Telex: 2548 CYEDE ED

Cable: CYEDE-Quito

Medical Only

Hospitalar S.A.

Casilla 3590

Robles 625

Quito

Tel: 545-250

Cable: HOSPITALAR-Quito

EL SALVADOR

IPESA

Bulevar de los Heroes 11-48

Edificio Sarah 1148

San Salvador

Tel: 252787

GUATEMALA

IPESA

Avenida Reforma 3-48

Zona 9

Guatemala City

Tel: 316627, 314786, 66471-5,

ext. 9

Telex: 4192 Teletro Gu

MEXICO

Hewlett-Packard Mexicana,

S.A. de C.V.

Av. Periferico Sur No. 6501

Tepepan, Xochimilco

Mexico 23, D.F.

Tel: 905-676-4600

Telex: 017-74-507

Hewlett-Packard Mexicana,

S.A. de C.V.

Ave. Constitución No. 2184

Monterrey, N.L.

Tel: 48-71-32, 48-71-84

Telex: 038-410

PANAMA

Electrónico Balboa, S.A.

Aparatado 4929

Panama 5

Calle Samuel Lewis

Edificio "Alfa," No. 2

Ciudad de Panama

Tel: 64-2700

Telex: 3483103 Curundu,

Canal Zone

Cable: ELECTRON Panama

PERU

Compañía Electro Médica S.A.

Los Flamencos 145

San Isidro Casilla 1030

Lima 1

Tel: 41-4325

Telex: Pub. Booth 25424 SISIDRO

Cable: ELMED Lima

SURINAM

Surtel Radio Holland N.V.

Grote Hofstr. 3-5

P.O. Box 155

Paramaribo

Tel: 72118, 77880

Cable: Surtel

TRINIDAD & TOBAGO

CARTEL

Caribbean Telecoms Ltd.

P.O. Box 732

69 Frederick Street

Port-of-Spain

Tel: 62-53068

URUGUAY

Pablo Ferrando S.A.C.eI.

Avenida Italia 2877

Casilla de Correo 370

Montevideo

Tel: 40-3102

Telex: 702 Public Booth

Para Pablo Ferrando

Cable: RADIUM Montevideo

VENEZUELA

Hewlett-Packard de Venezuela C.A.

P.O. Box 50933

Caracas 105

Los Ruices Norte

3a Transversal

Edificio Segre

Caracas 107

Tel: 239-4133 (20 lines)

Telex: 25146 HEWPACK

Cable: HEWPACK Caracas

FOR AREAS NOT

LISTED,

CONTACT:

Hewlett-Packard International

3495 Deer Creek Road

Palo Alto, California 94304

Tel: (415) 856-1501

Telex: 910-373-1260

Cable: HEWPACK Palo Alto

Telex: 034-8300, 034-8493

EUROPE, NORTH AFRICA, MIDDLE EAST

AUSTRIA

Hewlett-Packard Ges.m.b.H.

Wehlstrasse 29

P.O. Box 7

A-1205 **Vienna**

Tel: 35-16-21-0

Cable: HEWPACK Vienna

Telex: 13582/135066

Hewlett-Packard Ges.m.b.H.

Wehlstrasse, 29

A-1205 **Wien**

Tel: 35-16-21

Telex: 135066

BAHRAIN

Medical Only

Wael Pharmacy

P.O. Box 648

Bahrain

Tel: 54886, 56123

Telex: 8550 WAEI GJ

Cable: WAEI PHARM

Al Hamidiya Trading and

Contracting

P.O. Box 20074

Manama

Tel: 259978, 259958

Telex: 8895 KALDIA GJ

BELGIUM

Hewlett-Packard Benelux S.A./N.V.

Avenue du Col-Vert, 1,

(Groenkraaglaan)

B-1170 **Brussels**

Tel: (02) 660 50 50

Cable: PALOBEN Brussels

Telex: 23-494 paloben bru

CYPRUS

Kypronic

19 Gregorios Xenopoulos Street

P.O. Box 1152

Nicosia

Tel: 45628/29

Cable: Kypronic Pandehis

Telex: 3018

CZECHOSLOVAKIA

Hewlett-Packard

Obchodni zastupitelstvi v CSSR

Pisemny styk

Post. schranka 27

CS 118 01 **Praha** 011

CSSR

Vyvojova a Provozni Zakladna

Vyzkumnych Ustavu v Bechovicich

CSSR-25097 **Bechovice u**

Prahy

Tel: 89 93 41

Telex: 12133

Institute of Medical Bionics

Vyskumny Ustav Lekarskej Bioniky

Jedlova 6

CS-88346 **Bratislava-**

Kramare

Tel: 44-551

Telex: 93229

DENMARK

Hewlett-Packard A/S

Datavej 52

DK-3460 **Birkeroed**

Tel: (02) 81 66 40

Cable: HEWPACK AS

Telex: 37409 hpas dk

Hewlett-Packard A/S

Navervej 1

DK-8600 **Sikeborg**

Tel: (06) 82 71 66

Telex: 37409 hpas dk

Cable: HEWPACK AS

EGYPT

I.E.A.

International Engineering

Associates

24 Hussein Hegazy Street

Kasr-el-Aini

Cairo

Tel: 23 829

Telex: 93830

Cable: INTENGASSO

SAMITRO

Sami Amin Trading Office

SALES OFFICES (cont.)

EUROPE, NORTH AFRICA, MIDDLE EAST

Hewlett-Packard GmbH
Technisches Büro München
Eschenstrasse 5
D-8021 Taufkirchen
Tel: (089) 6117-1
Telex: 0524985

Hewlett-Packard GmbH
Technisches Büro Berlin
Kathstrasse 2-4
D-1000 Berlin 30
Tel: (030) 24 90 86
Telex: 018 3405 hpbin d

GREECE
Kostas Karayannis
8 Omirou Street
Athens 133
Tel: 32 30 303/32/37 371
Telex: 21 59 62 RKAR GR
Cable: RAKAR ATHENS

ICELAND
Medical Only
Elding Trading Company Inc.
Hafnarvöli - Tryggvagötu
P.O. Box 895
IS-Reykjavik
Tel: 1 58 20/1 63 03
Cable: ELDING Reykjavik

IRELAND
Hewlett-Packard Ltd.
King Street Lane
Winnersh, Wokingham
Berkshire, RG11 5AR
GB-England
Tel: (0734) 78 47 74
Telex: 847178
Cable: Hewpie London

Hewlett-Packard Ltd.
Kestrel House
Cianwilliam Place
Lower Mount Street
Dublin 2, Eire

Hewlett-Packard Ltd.
2C Avonberg Ind. Est.
Long Mile Road
Dublin 12
Tel: 514322/514224
Telex: 30439

Medical Only
Cardiac Services (Ireland) Ltd.
Kilmore Road
Artane
Dublin 5, Eire
Tel: (01) 315820

Medical Only
Cardiac Services Co.
95A Finaghy Rd. South
Belfast BT10 0BY
GB-Northern Ireland
Tel: (0232) 625566
Telex: 747626

ISRAEL
Electronics Engineering Div.
of Motorola Israel Ltd.
16, Kremenetski Street
P.O. Box 25016
Tel-Aviv
Tel: 39973
Telex: 33569, 34164
Cable: BASTEL Tel-Aviv

ITALY

Hewlett-Packard Italiana S.p.A.
Via G. Di Vittorio, 9
20063 **Cernusco Sul Naviglio** (MI)
Tel: (2) 903691
Telex: 334632 HEWPACKIT

Hewlett-Packard Italiana S.p.A.
Via Turazza, 14
35100 **Padova**
Tel: (49) 664888
Telex: 430315 HEWPACKI

Hewlett-Packard Italiana S.p.A.
Via G. Armellini 10
I-00143 **Roma**
Tel: (06) 54 69 61
Telex: 610514
Cable: HEWPACKIT Roma

Hewlett-Packard Italiana S.p.A.
Corso Giovanni Lanza 94
I-10133 **Torino**
Tel: (011) 659308
Telex: 221079

Hewlett-Packard Italiana S.p.A.
Via Principe Nicola 43 G/C
I-95126 **Catania**
Tel: (095) 37 05 04
Telex: 970291

Hewlett-Packard Italiana S.p.A.
Via Nuova san Rocco A
Capadimonte, 62A
80131 **Napoli**
Tel: (081) 710698

Hewlett-Packard Italiana S.p.A.
Via Martin Luther King, 38/111
I-40132 **Bologna**
Tel: (051) 402394
Telex: 511630

JORDAN

Mouasher Cousins Co.
P.O. Box 1587
Amman
Tel: 24907/39907
Telex: SABCO JO 1456
Cable: MOUASHERCO

KUWAIT

Al-Khaldiya Trading & Contracting
P.O. Box 830-Salat
Kuwait
Tel: 42 4910/41 1726
Telex: 2481 Areeg kt
Cable: VISCOUNT

LUXEMBURG

Hewlett-Packard Benelux S.A./N.V.
Avenue du Col-Vert, 1
(Groenraaglaan)
B-1170 **Brussels**
Tel: (02) 660 5050
Cable: PALOBEN Brussels
Telex: 23 494

MOROCCO

Dolbeau
81 rue Karatchi
Casablanca
Tel: 3041 82
Telex: 23051/22622
Cable: MATERIO

GEREP

2, rue d'Agadir
Boite Postal 156
Casablanca
Tel: 272093/5
Telex: 23 739
Cable: GEREP-CASA

NETHERLANDS

Hewlett-Packard Benelux N.V.
Van Heuven Goedhartlaan 121
P.O. Box 667
1181KK **Amstelveen**
Tel: (20) 47 20 21
Cable: PALOBEN Amsterdam
Telex: 13 216

NORWAY

Hewlett-Packard Norge A/S
Ostendalen 18
P.O. Box 34
1345 **Osteraas**
Tel: (02) 1711 80
Telex: 16621 hpnas n

Hewlett-Packard Norge A/S
Nygaardsgaten 114
P.O. Box 4210
5013 Nygaardsgaten,
Bergen
Tel: (05) 21 97 33

POLAND

Biuro Informacji Technicznej
Hewlett-Packard
Ul Stawki 2, 6P
PL00-950 **Warszawa**
Tel: 39 59 62, 39 51 87
Telex: 81 24 63

PORTUGAL

Telectra-Empresa Técnica de
Equipamentos Eléctricos S.a.r.l.
Rua Rodrigo da Fonseca 103
P.O. Box 2531

P-Lisbon

Tel: (19) 68 60 72
Cable: TELETRA Lisbon
Telex: 12598

Medical Only

Mundinter
Intercambio Mundial de Comercio
S.a.r.l.
P.O. Box 2761
Avenida Antonio Augusto
de Aguiar 138
P-Lisbon
Tel: (19) 53 21 31/7
Telex: 16691 munter p
Cable: INTERCAMBIO Lisbon

QATAR

Nasser Trading & Contracting
P.O. Box 1563
Doha
Tel: 22170
Telex: 4439 NASSER
Cable: NASSER

ROMANIA

Hewlett-Packard Reprezentanta
Bd.n. Balcescu 16
Bucuresti
Tel: 15 80 23/13 88 85
Telex: 10440

SAUDI ARABIA

Modern Electronic Establishment
(Head Office)
P.O. Box 1228, Baghdadiyah Street
Jeddah
Tel: 27 798
Telex: 40035
Cable: ELECTA JEDDAH

Modern Electronic Establishment
(Branch)
P.O. Box 2728
Riyadh
Tel: 62596/66232
Telex: 202049

Modern Electronic Establishment
(Branch)
P.O. Box 193
Al-Khobar
Tel: 44678-44813
Telex: 670136
Cable: ELECTA AL-KHOBAR

SPAIN

Hewlett-Packard Española, S.A.
Calle Jerez 3
E-Madrid 16
Tel: (1) 458 26 00 (10 lines)
Telex: 23515 hpe

Hewlett-Packard Española S.A.
Colonia Mirasierra
Edificio Juban
c/o Costa Brava, 13
Madrid 34

Hewlett-Packard Española, S.A.
Milanesado 21-23
E-Barcelona 17
Tel: (3) 203 6200 (5 lines)
Telex: 52603 hpbe e

Hewlett-Packard Española, S.A.
Av Ramon y Cajal, 1
Edificio Sevilla, planta 9°
E-Sevilla 5
Tel: 64 44 54/58

Hewlett-Packard Española S.A.
Edificio Albia II 7° B
E-Bilbao 1
Tel: 23 83 06/23 82 06

Hewlett-Packard Española S.A.
C/Ramon Gordillo 1
(Enllo.)
E-Valencia 10
Tel: 96-361.13.54/361.13.58

SWEDEN

Hewlett-Packard Sverige AB
Enighetsvägen 3, Fack
S-161 **Bromma** 20
Tel: (08) 730 05 50
Telex: 10721
Cable: MEASUREMENTS
Stockholm

Hewlett-Packard Sverige AB
Frötallsgatan 30
S-421 32 **Västra Frölunda**
Tel: (031) 49 09 50
Telex: 10721 via Bromma office

SWITZERLAND

Hewlett-Packard (Schweiz) AG
Zürcherstrasse 20
P.O. Box 307
CH-8952 **Schlieren-Zürich**
Tel: (01) 7305240
Telex: 53933 hpag ch
Cable: HPAG CH

Hewlett-Packard (Schweiz) AG
Château Bloc 19
CH-1219 **Le Lignon-Geneva**
Tel: (022) 96 03 22
Telex: 27333 hpag ch
Cable: HEWPACKAG Geneva

SYRIA

Commercial Electronic Inc.
Nuri Basha-Ahmal Ebn Kays Street
P.O. Box 5781
Damascus
Tel: 33 24 87
Telex: 11215 ITIKAL
Cable: ELECTROBOR DAMASCUS

Medical only
Sawah & Co.
Place Azmé
B.P. 2308
Damascus
Tel: 16 367-19 697-14 268
Telex: 11304 SATACO SY
Cable: SAWAH, DAMASCUS

Suleiman Hilal El Mawi
P.O. Box 2528
Mamoun Bitar Street, 56-58
Damascus
Tel: 11 46 63
Telex: 11270
Cable: HALAL DAMASCUS

TUNISIA

Tunisie Electronique
31 Avenue de la Liberté
Tunis
Tel: 280 144

Corema

1 ter. Av. de Carthage
Tunis
Tel: 253 821
Telex: 12319 CABAM TN

TURKEY

TEKNIM Company Ltd.
Riza Sah Pehlevi
Caddesi No. 7
Kavaklidere, **Ankara**
Tel: 275800
Telex: 42155

Teknim Com., Ltd.
Barbaros Bulvari 55/12
Besikyas, **Istanbul**
Tel: 613 546
Telex: 23540

E.M.A.
Muhendislik Kollektif Sirketi
Mediha Eldem Sokak 41/6
Yüksel Caddesi
Ankara
Tel: 17 56 22
Cable: EMATRADE/Ankara

Yilmaz Ozyurek
Milli Mufataa Cad 16/6
Kizilay
Ankara
Tel: 25 03 09 - 17 80 26
Telex: 42576 OZEK TR
Cable: OZYUREK ANKARA

UNITED ARAB EMIRATES
Emitac Ltd. (Head Office)
P.O. Box 1641
Sharjah
Tel: 354121/3
Telex: 8136
Emitac Ltd. (Branch Office)
P.O. Box 2711

Abu Dhabi
Tel: 331370/1

UNITED KINGDOM
Hewlett-Packard Ltd.
King Street Lane
Winnersh, Wokingham
Berkshire RG11 5AR
GB-England
Tel: (0734) 784774
Telex: 84 71 78/9

Hewlett-Packard Ltd.
Fourier House,
257-263 High Street
London Colney
St. Albans, Herts
GB-England
Tel: (0727) 24400
Telex: 1-895276

Hewlett-Packard Ltd.
Trafalgar House
Navigation Road
Altrincham
Cheshire WA14 1NU
GB-England
Tel: (061) 928 6422
Telex: 668068

Hewlett-Packard Ltd.
Lygon Court
Hereward Rise
Dudley Road
Halesowen,
West Midlands, B62 8SD
GB-England
Tel: (021) 501 1221
Telex: 339105

Hewlett-Packard Ltd.
Wedgeway House
799, London Road
Thornton Heath
Surrey, CR4 6XL
GB-England
Tel: (01) 684-0103/8
Telex: 946825

Hewlett-Packard Ltd.
14 Wesley St
Castleford
Yorks WF10 1AE
Tel: (0977) 550016
TWX: 5557335

Hewlett-Packard Ltd.
Tradax House
St. Mary's Walk
Maidenhead
Berkshire, SL6 1ST
GB-England

Hewlett-Packard Ltd.
Morley Road
Staplehill
Bristol, BS16 4QT
GB-England

Hewlett-Packard Ltd.
West Lothian, EH30 9TG
GB-Scotland
Tel: (031) 331 1188
Telex: 72682

Hewlett-Packard Ltd.
Kestrel House
Cianwilliam Place
Lower Mount Street
Dublin 2, Eire

Hewlett-Packard Ltd.
2C Avonberg Ind. Est.
Long Mile Road
Dublin 12
Tel: 514322/514224
Telex: 30439

USSR
Hewlett-Packard
Representative Office
USSR
Pokrovsky Boulevard 4/17-kw 12
Moscow 101000
Tel: 294.20.24
Telex: 7825 hewpak su

YUGOSLAVIA
Iskra Commerce, n.sol.o.
Zastopstvo Hewlett-Packard
Obilicev Venac 26
YU 11000 **Beograd**
Tel: 636-955
Telex: 11530

Iskra Commerce, n.sol.o.
Zastopstvo Hewlett-Packard
Miklosiceva 38/VII
YU-61000 **Ljubljana**
Tel: 321-674, 315-879
Telex: 31583