

9810A/9820A
CALCULATOR

SERVICE MANUAL

HEWLETT  PACKARD



09800-90015-



Manual Changes

MODEL 9810A/9820A CALCULATOR

Service Manual

Part No. 09820-90015

On the parts list and schematic for the 09810-66582 PC assembly, R10 has been changed to a .82 OHM resistor part no. 0811-2868.

The safety ground attached to the chassis by mounting hardware for the fan, was changed to prevent the possibility of the ground being left unconnected if the fan was serviced. The safety ground was rerouted to a solder lug connected directly to the chassis so the connection would remain undisturbed in the event of a component replacement. The safety ground change is effective on 9810A serial number 1128A05651 and on 9820A serial number 1144A02646.

The following change is being incorporated into the 9810A and 9820A Calculators to provide a discharge path for the line filter capacitors when the calculator is switched OFF and the ac power cord is removed:

1. Add a 1 megohm resistor (R1) 0683-1055 to the two contacts not previously used on the power switch S1 (see drawing below).
2. Update the primary power schematic (shown with the A82 schematic) and add R1 to the parts list on page 6-36 and 6-39. R1 0683-1055 R:Fxd, 1m 1/4W 5 %

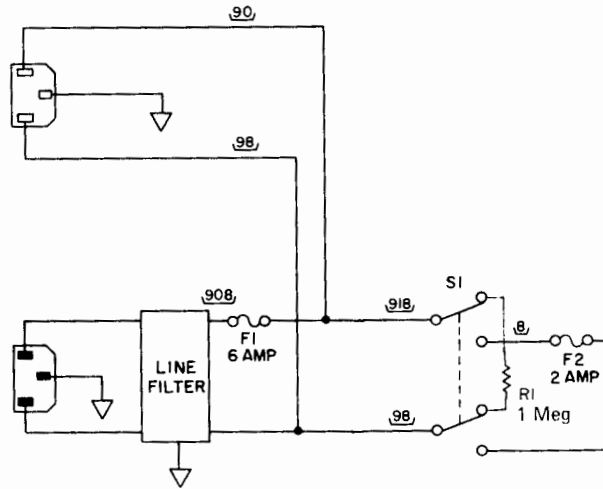

July 1974

Supplement B for 09820-90015

HP Computer Museum
www.hpmuseum.net

For research and education purposes only.



9810A/9820A CALCULATOR

SERVICE MANUAL

-hp- Part Number 09820-90015

TABLE OF CONTENTS

	page
CHAPTER 1 INTRODUCTION	
Purpose of the Manual	1-1
Service Concept	1-2
The 9800 System	1-2
A Brief Description of the 9810A	1-3
A Brief Description of the 9820A	1-5
The 9810A and 9820A Service Kits	1-6
CHAPTER 2 INSTALLATION	
Power Requirements	2-1
Grounding Requirements	2-3
Fuses	2-3
Initial Turn-ON Procedure	2-4
Electrical Inspection	2-5
9810A Printer Installation (Opt 4)	2-7
9820A Printer Installation	2-13
9810A Memory Option Installation	2-14
9820A Memory Option Installation	2-19
CHAPTER 3 INSTRUMENT MAINTENANCE	
Cleaning the Calculator Fan-Filter	3-1
Cleaning the Magnetic-Card Reader	3-1
Printer Checkout	3-2
CHAPTER 4 PSEUDO-HARDWARE	
9810A Pseudo-Hardware Index	4-1
9820A Pseudo-Hardware Index	4-2
9810A Idiosyncrasies	4-3
9810A ROM Block Idiosyncrasies	4-8
9820A Idiosyncrasies	4-10
CHAPTER 5 ASSEMBLY ACCESS	
9810A/9820A Assembly Removal	5-1
CHAPTER 6 TROUBLESHOOTING & REPAIR	
9810A/9820A General Information	6-1
Calculator Principles of Operation	6-4
Theory of Operation	6-10
Troubleshooting	6-16
Troubleshooting Trees	6-21
Servicing the Magnetic-Card Reader	6-26
9810A/9820A	6-30
9810A Replaceable Parts List	6-33
9820A Replaceable Parts List	6-37

TABLE OF ILLUSTRATIONS

Description	page
Model 10 Options	1-4
The 9820A Keyboard	1-5
Line-Voltage Switch Settings	2-1
The Rear Panel	2-2
Installing the Printer	2-9
Adjusting the Printer	2-10
Installing the Printer Window	2-10
Examples of Printer Alignment Errors	2-11
Proper Printer Alignment	2-11
The 9810A Memory	2-15
Exchanging 9810A Memory Assemblies	2-16
9820A Memory Configurations	2-20
Exchanging 9820A Memory Assemblies	2-21
Removing the Calculator Top Cover	5-2
Exchanging the Memory Assemblies	5-5
Removing the Calculator Keys	5-6
Keyboard Access Screws	5-7
The Keyboard in the Access Position	5-7
Removing the Printer	5-10
The Calculator Chassis	5-11
9810A/9820A Block Diagram	6-2
+5V Simplified Schematic	6-12
+5V Waveforms	6-12
+12V Power Supply	6-13
-12V Power Supply	6-14
9810A Troubleshooting Tree	6-21
9810A Assembly Exchange Tree	6-22
9820A Troubleshooting Tree	6-23
9820A Assembly Exchange Tree	6-24
9810A & 9820A Back Panel & Chassis Parts	6-25
Magnetic-Card Reader Lamp Replacement	6-27
Magnetic-Card Reader Ground Strap Installation	6-29

SERVICE CONCEPT

With the exception of two power supply assemblies, the 9810A and 9820A Calculators should be field maintained using the -hp- Blue Stripe Exchange Program. The 9810A and 9820A Blue Stripe Program is supported by the use of the 11209B (9810A), 11229B (9820A), or 11495A (9820A Opt. 002) service repair kits. Each of these service kits, with the exception of the 11495A, provides one complete set of exchange, power supply, and chassis assemblies for the associated calculator. The 11495A kit only contains the additional assemblies to maintain Opt 002 of a 9820A Calculator.

An additional service kit, the 11227B, is available to provide the assemblies necessary to enable the 11209B (9810A) service kit to be used to repair 9820A Calculators. Each of the four service kits is available from either Loveland Calculator Division or Parts Center Europe (PCE), depending upon your location.

The Power supply assemblies A82 and A83 in the Calculator should be repaired in the field. The repair may be accomplished either at the customer's location, or, if more convenient, at the service office. If the repair of either of these assemblies cannot be accomplished, the defective assembly may be replaced with the associated kit assembly and a new kit replacement assembly ordered from either CSC or PCE. However, the new assembly will be priced at factory list price. Repair of the A81 (+5V) assembly (Blue Stripe) may also be accomplished in the field using the information supplied in the manual.

THE 9800 SYSTEM

The 9800 Calculator System consists of a calculator and one or more Read-Only-Memories (ROMs) and peripherals. The calculator peripherals usually require the use of a ROM which enables calculator/peripheral communication; some ROMs may be used with more than one peripheral. Some ROMs are also available which enable the calculator to perform specialized functions such as solving special mathematical problems.

Generally, ROM's which are plugged into ROM slot I only define the half-keys directly in front of that slot, and are not used to

THE 9800 SYSTEM (cont'd)

control peripherals. ROM's which are plugged into slots II and/or III usually provide the calculator with peripheral control, and define the use of the associated half-keys and sometimes other portions of the calculator keyboard. Operation of the 9800-Series ROM's and peripherals is described in the associated Operating Manuals.

◆◆◆◆◆ A BRIEF DESCRIPTION OF THE 9810A ◆◆◆◆◆

The basic Model 10 Calculator is fully programmable; both data and program steps can be stored in the calculator memory. Programming is simple because the various keyboard operations become the program instructions: no special language need be learned. Standard programming features include separate data and program memories, conditional and unconditional branching, direct and indirect data storage and register arithmetic, relocatable programs, subroutines, and the ability to automatically load magnetic cards containing either program steps or data. An additional feature is program editing, which enables programs to be easily debugged and corrected, even though they are already stored in the memory.

Options

The basic Model 10 consists of a 500 program step and 51 data register R/W memory, with no internal printer. The main calculator can be expanded by various additions which are classified into two groups: Options which require that the calculator be modified and which must, therefore, be installed by qualified HP personnel; and products, such as read-only-memories (ROM's), which can be easily plugged into the calculator, and removed, by the user. (A third group of additions, the peripheral devices, are additions to the system rather than to the basic calculator.) Table 1-2 lists the calculator options which are available at the time of this printing.

Table 1-2. Field Installable Options.

Installation of these options is fully described elsewhere in this manual.

Option 001: Total of 111 data-storage registers (product number -hp- 11216A).

Option 002:* Total of 1012 program steps (product number -hp- 11217A).

Option 003:* Total of 2036 program steps (product number -hp- 11218A).

Option 004: Printer (Product number -hp- 11219A).

Option 015: Carrying handle (-hp- part number 5060-5992).

* (Options 002 and 003 are mutually exclusive.)

Option 100: Special line filter for use in European countries.

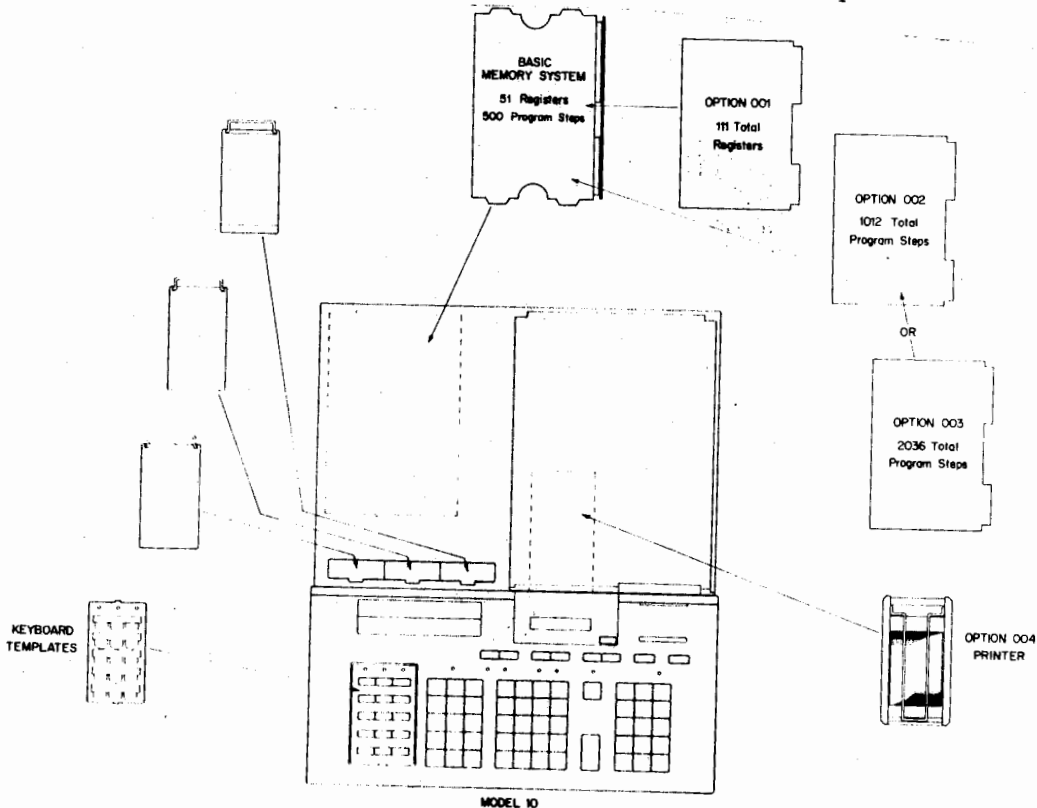

A BRIEF DESCRIPTION OF THE 9820A

The Model 20 is an easy to use programmable calculator. The Model 20 language is algebraic and easy to learn, making use of the calculator quite straight-forward.

A built-in magnetic card reader and printer add to the convenience of the Model 20. Both the printer and the large, easy-to-read display have full alphameric capability.

Programs and data are stored in the same general memory, so that memory not used for programming can be used for data storage. The basic Model 20 has 173 registers (with no programs stores or plug-in ROM's installed). If the machine is equipped with option 001 (11228A), it has 429 registers; Opt 002 (11225A) calculator contains 1453 registers.

The Model 20's language is especially well suited for the control of peripherals. A Model 20 System (with peripherals) has a great deal of problem solving power, and, because of the algebraic language, this power is easy to apply.

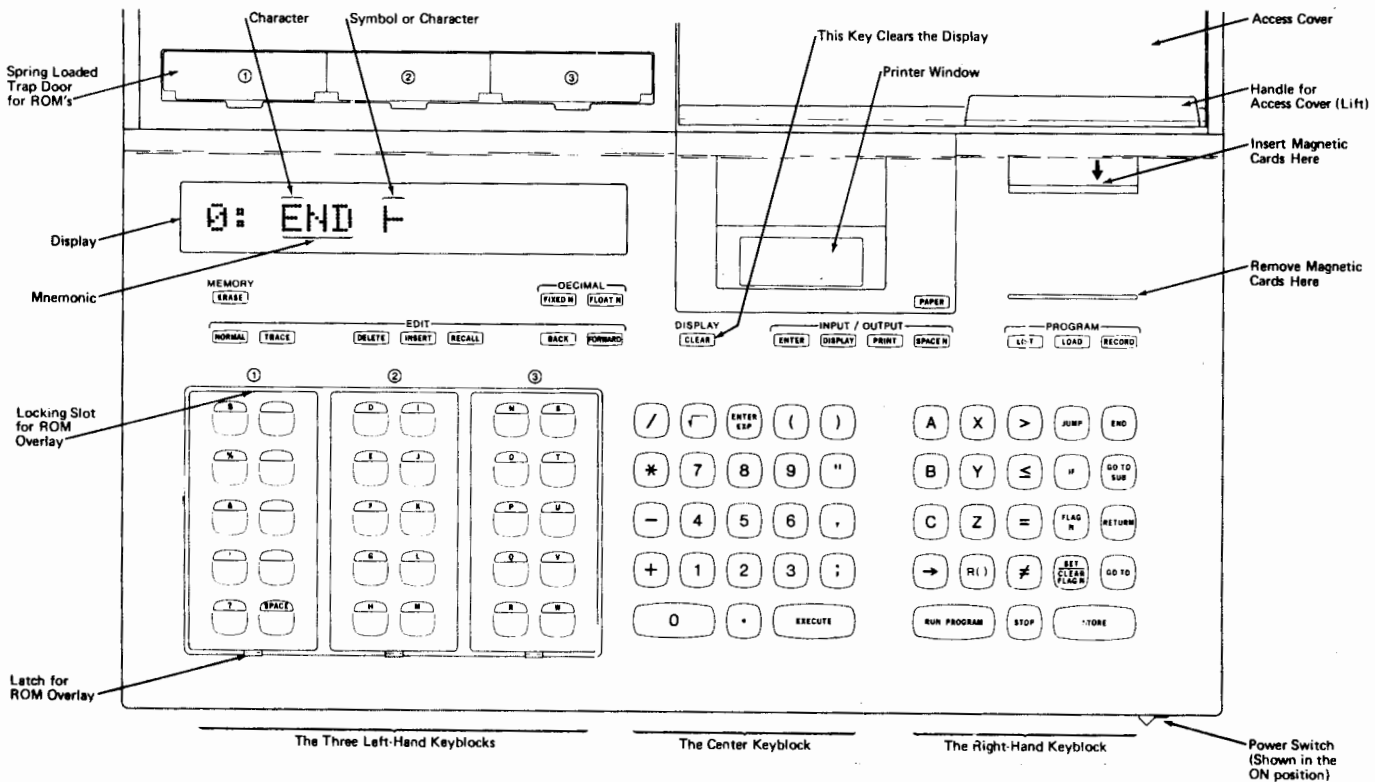

Figure 1-2. The 9820A Keyboard

THE 9810A and 9820A SERVICE KITS

Two service repair kits (the 11209B for the 9810A and 11229B for the 9820A) are available which provide all of the assemblies in their respective calculators. An additional kit, the 11227B, is available which contains only those assemblies which are unique to the 9820A. The 11227B can be used to enable the use of the 11209B (09810A) kit in the repair of 9820A Calculators. The 11495A kit updates the 9820A kit to include the Opt. 002 assemblies. Tables 1-3, 1-4, and 1-5 provide complete lists of the three service kit assemblies.

Table 1-3. The 11209B (9810A Service Kit)

Ref. Desig.	-hp- Part Number	TQ	Description
PROCESSOR			
A16	09810-69511	1	I/O Register
A17	09810-69512	1	I/O Clock
A18	09810-69513	1	Micro Processor
A19	09810-69514	1	ALU Register
BASIC MEMORY			
A31	09810-69522	1	Control Ass'y
A32	09810-69523	1	M Register
A33	09810-69524	1	T Register
A34	09810-69525		R/W Memory (Basic)
OPTIONAL MEMORY			
A0	09810-69521	1	51 Register Board
A1	11216-69521	1	111 Register Board
A2	11217-69526	1	1012 Register Board
A3	11218-69526	1	2036 Register Board
INPUT/OUTPUT DEVICES			
A4	11219-69550	1	Printer
A7	09810-69560	1	Magcard Reader
A8	09810-69530	1	Keyboard
A9	09810-69541	1	Display
POWER SUPPLIES			
A81	09810-69581		+5V Power Supply
A82	09810-66582		Misc. Power Supplies
A83	09810-66583		-12V Power Supplies

OTHER REPLACEMENT ITEMS

09810-66501	1	I/O Extender Ass'y
09810-67900	1	Chassis Ass'y
5040-5849	1	Printer Window
11209-84401	1	Misc. Material Kit
9220-1821	1	Wrapping, Protective

THE 9810A AND 9820A SERVICE KITS (cont'd)

Table 1-4. The 11227B (9810A to 9820A Update Kit)

Ref. Desig.	-hp- Part No.	TO	Description
MEMORY ASS'IES			
A35	09820-69521	1	ROM Ass'y No. 1
A36	09820-69522	1	ROM Ass'y No. 2
A37	09820-69523	1	Control Ass'y
A38	09820-69524	1	M Register
A39	09820-69525	1	T Register
A26	09820-69526	1	R/W Memory (Basic)
INPUT/OUTPUT ASS'IES			
A28	09820-69530	1	Keyboard Ass'y
A29	09820-69541	1	Display Ass'y
	09820-66501	1	I/O Extender Ass'y
	11227-84401	1	11227A Misc Material Kit
	9220-1821	2	Wrapping, Protective

THE 9810A AND 9820A SERVICE KITS (cont'd)

Table 1-5. The 11229B (9820A Service Kit)

Ref. Desig.	-hp- Part No.	TO	Description
PROCESSOR ASSEMBLIES			
A16	09810-69511	1	I/O Register
A17	09810-69512	1	I/O Clock
A18	09810-69513	1	Micro Processor
A19	09810-69514	1	ALU Register
MEMORY ASSEMBLIES			
A35	09820-69521	1	ROM Ass'y No. 1
A36	09820-69522	1	ROM Ass'y No. 2
A37	09820-69523	1	Control Ass'y
A38	09820-69524	1	M Register
A39	09820-69525	1	T Register
A26	09820-69526	2	R/W Memory
INPUT/OUTPUT ASSEMBLIES			
A4	11219-69550	1	Printer
A7	09810-69560	1	Magcard Reader
A28	09820-69530	1	Keyboard
A29	09820-69541	1	Display
	09820-66501	1	I/O Extender Ass'y
	09820-67900	1	Chassis Ass'y
POWER SUPPLIES			
A81	09810-69581	1	+5V Power Supply
A82	09810-66582	1	Msc Power Supplies
A83	09810-66583	1	12V Power Supplies
	11229-84401	1	Msc. Material Kit
	9220-1821	2	Wrappint, Protective
	9281-0400	1	Printer Paper

THE 9810A AND 9820A SERVICE KITS (con'd)

Table 1-6. The 11495A Service Kit

A43	11225-69543	1	M-Register
A44	11225-69544	1	T-Register
A81	11225-69581	1	+5V Power Supply
A45	11225-69545	3	R/W Memory Assemblies
	11225-67920	1	Memory Chassis Ass'y
	7120-3583	1	Opt 002 I.D. Decal

Chapter 2 INSTALLATION

POWER REQUIREMENTS

The calculator has the following power requirements (refer to Figures 2-1 and 2-2).

LINE VOLTAGE: The calculator will operate from nominal powerline voltages of 100, 120, 220, or 240 ac volts. The range of operation is within -10% and +5% of those values. Two switches on the rear panel of the calculator allow one of those four voltages to be selected as the operating voltage. (See Figures 2-1 and 2-2.)

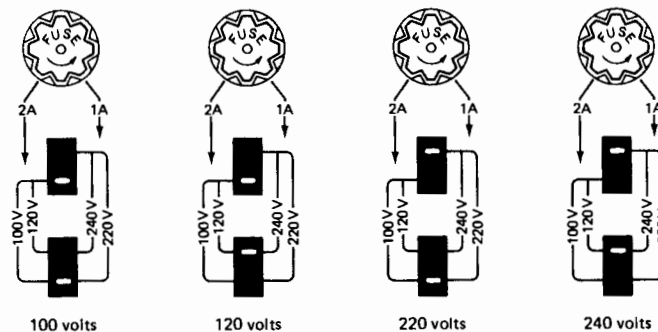

Figure 2-1. Switch Settings for the Various Nominal Powerline Voltages

NOTE

A different fuse is required for each of the two voltage ranges of 100-120 vac and 220-240 vac. See "FUSES" for further information.

POWER REQUIREMENTS (cont'd)

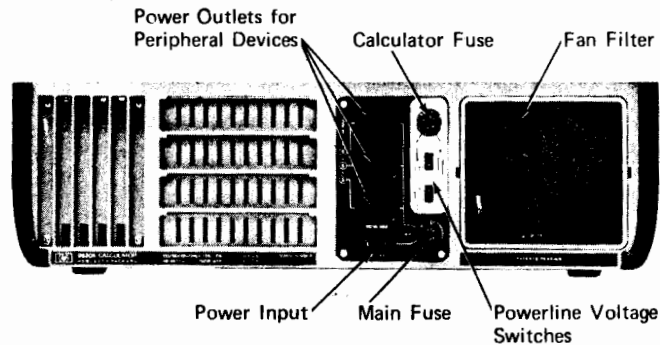

Figure 2-2. The Rear Panel

LINE FREQUENCY: The calculator can be operated on line frequencies 48 Hz to 66 Hz; the two frequently encountered frequencies are 50 Hz or 60 Hz.

POWER CONSUMPTION: With no peripheral equipment attached, the calculator requires a maximum of 150 voltamps.

There are three power outlets on the rear panel of the calculator. They may be used to supply ac power to peripheral equipment, and a maximum combined total of 610 voltamps may be drawn from these outlets by the calculator and all connected peripherals.

WARNING

THE OUTLETS ARE NOT SWITCHED ON OR OFF BY THE POWER SWITCH OF THE CALCULATOR, BUT ARE ACTIVE WHEN THE CALCULATOR IS CONNECTED TO AN AC POWER SOURCE.

GROUNDING REQUIREMENTS

To protect operating personnel, the National Electrical Manufacturers' Association (NEMA) recommends that the calculator's keyboard and cabinet be grounded. The calculator is equipped with a three conductor power cable which, when connected to an appropriate power receptacle, grounds the cabinet and the keyboard of the calculator. Do not destroy the ground connection if the available power outlet does not have a ground terminal. Instead, use the appropriate type of adapter.

FUSES

The calculator has two fuses located on the rear panel (see Figure 2-2). The main fuse is a 6-amp fuse. The calculator fuse is either a 2-amp fuse, for 100/120 vac operation, or a 1-amp fuse, for 220/240 vac operation.

The main fuse protects the calculator and any devices connected to the three power outlets. The calculator fuse protects just the calculator.

Three spare fuses, a 6-amp, a 2-amp, and a 1-amp (listed in table below) are shipped with each calculator.

Table 2-1. Power-Line Voltages and Fuses

NOMINAL VOLTAGE	OPERATING RANGE (-10%, +5% of nominal)	CALC. FUSE	-hp- Part Number
100 volts	90 to 105 volts	2-amp	2110-0002
120 volts	108 to 126 volts	2-amp	2110-0002
220 volts	198 to 231 volts	1-amp	2110-0001
240 volts	216 to 252 volts	1-amp	2110-0001
100-240	90 to 252 volts	6-amp	2110-0056

FUSES (cont'd)

WARNING

BEFORE CHANGING A FUSE, ENSURE THAT THE CALCULATOR IS DISCONNECTED FROM ANY POWER SOURCE.

To remove a fuse, press inwards on the cap of the fuseholder, while at the same time twisting the cap in the direction indicated by the arrow on the cap. Pull the cap free and remove the fuse. To install a fuse, place either end of the fuse into the pocket in the cap, and reattach the cap to the body of the fuseholder. Do this by pressing inwards on the cap and twisting it in the opposite direction of the arrow.

WARNING

ALWAYS BE SURE THAT THE PROPER FUSES ARE CORRECTLY INSTALLED IN THE CALCULATOR. FAILURE TO FOLLOW THIS PRECAUTION CAN DEFEAT THE PURPOSE OF THE FUSES, AND RESULT IN NEEDLESS DAMAGE TO THE CALCULATOR IN THE EVENT OF CERTAIN TYPES OF MALFUNCTIONS OR UNUSUAL LINE VOLTAGE CONDITIONS.



INITIAL TURN-ON PROCEDURE



With the calculator disconnected from any ac power source, verify that the correct calculator fuse is installed for the line voltage in your area. (Refer to the preceding section for information regarding the fuses.)

The two slide switches located on the rear panel (see Figure 2-1) must be set to the particular line voltage to be used. The switches are set by inserting the tip of a small screwdriver into the white slot on the switch and then sliding each switch so that the slots are at the line corresponding to the desired voltage.

INITIAL TURN-ON PROCEDURE (cont'd)

Switch the LINE OFF/ON switch, located on the right front of the calculator, to the OFF position. Connect the power cord to the ac power input connector (see Figure 2-2) at the rear of the calculator, and plug the other end of the cord into a suitable ac power outlet. Switch the LINE switch ON. After a few seconds, the calculator should display 0:END+. If not, recheck the turn-on procedure and verify that ac power is being applied to the calculator. If ac power is being applied to the calculator and the turn-on procedure (above) has been performed correctly, but the calculator does not power-up properly, refer to the TROUBLESHOOTING and REPAIR chapter of this manual.

◆◆◆◆◆ ELECTRICAL INSPECTION ◆◆◆◆◆

After the turn-on procedure has been successfully completed, the calculator should be checked for correct operation. This can be accomplished by the use of either the 9810A Exerciser Program or the 9820A Electrical Inspection Programs (depending on which calculator is being tested) which are prerecorded on magnetic cards. These programs are designed to completely check the associated calculator.



THE 9810A EXERCISER

Instructions for using the 9810A exerciser Program may be found on the envelope supplied with each set of cards (-hp- Part No. 09810-90021). More detailed instructions may be found in the 9810A CALCULATOR OPERATING MANUAL (09810-90000). Instructions for the electrical inspection of ROM's and peripherals may be found in the associated ROM or peripheral operating manuals.

ELECTRICAL INSPECTION (cont'd)

THE 9820A EXERCISER

Instructions for performing the electrical inspection of the 9820A is contained in the '9820A CALCULATOR SYSTEM ELECTRICAL INSPECTION BOOKLET' (-hp- Part No. 09820-90030). This booklet contains four prerecorded (machine language) magnetic cards and instructions for checking a Model 20 Calculator or almost any ROM which is plugged into the calculator. (The 11223A ROM Block cannot be tested using the ROM test program - see Supplement 'F'.) Various supplements (one for each peripheral) are available for the electrical inspection booklet which enable any available peripheral to be tested. Table 2-2 provides a current listing of the peripherals and supplements which are available at the time of this printing.

Table 2-2. Available Model 20 Peripheral
Electrical Inspection Supplements

Peripheral	Supplement	-hp- Part Number
9860A	'A'	09820-90050
9861A (PC I)	'B'	09820-90052
9862A (PC I)	'C'	09820-90054
9863A (PC I)	'D'	09820-90056
9864A (PC I or PC II)	'E'	09820-90058
9865A	'F'	09820-90059
9866A (PC I or PC II)	'J'	09820-90067
9868A	none necessary	
9861A (PC II)	'G'	09820-90061
9862A (PC II)	'H'	09820-90063
9863A (PC II)	'I'	09820-90065
9869A (PCI or PCII)	'K'	09820-90069

◆◆◆◆◆ 9810A PRINTER INSTALLATION (Option 004) ◆◆◆◆◆

The basic Model 10 Calculator does not contain a printer. The printer may be ordered as an option which is installed at the factory, or as an accessory (11219A) which is installed at the customer's location. The following procedure provides the information necessary to field install the 11219A Printer.

Table 2-3. Materials Supplied

DESCRIPTION	QUANTITY	-hp- PART NUMBER
Printer	1	11219-69550
Printer Paper	3 rolls	
Option 004 I.D. Tag		7120-2801
Clear Plastic Printer Window	1	5040-5849
Mounting Hardware:		
Screws	4	2360-0312
Flat Washers	4	3050-0228

TOOLS/EQUIPMENT REQUIRED:

- (1) Small Pozidriv (or No. 2 Phillips) Screwdriver
- (1) 3/8" open-end wrench

Keyboard and Top Cover Removal:

1. Disconnect power cord; remove all plug-in ROM's.
2. Tip calculator on end and remove the 4 screws which secure keyboard (see Figure 5-2).
3. Lower calculator and lift keyboard up and forward, away from the mainframe. Then, position keyboard as shown in Figure 2-3.

NOTE

The keyboard should not be disconnected.

4. Remove the four screws in top cover, then gently bow cover up in the middle and lift it off the mainframe.

9810A PRINTER INSTALLATION (Option 004) [cont'd]

5. Remove and discard the small cover insert which covers the printer opening.

Printer Installation

6. Install the printer mechanism by carefully lowering it straight down into place (see Figure 2-3). Be sure the P.C. board is properly seated in its connector on the mainframe mother board.
7. Secure the printer with the four screws and washers which are supplied in the printer kit.
8. Inspect the mainframe to ensure that all boards and connectors are properly seated. Remove any foreign material.

9810A Printer Checkout

9. After ensuring that the keyboard cannot short to the mainframe by placing it back into the calculator, but not fastening it in place, reconnect the power cord and switch the calculator ON.
10. Load a roll of printer paper. Be sure the bail drops back into place.
11. Press the paper lever (i.e., the red arm) until paper advances beyond the printhead.
12. To load and run the printer checkout program:

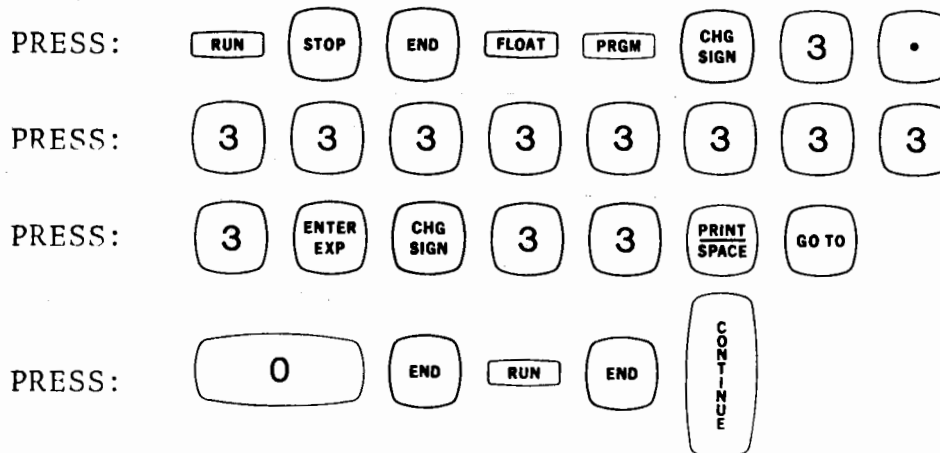

9810A PRINTER INSTALLATION (Option 004) [cont'd]

9810A Printer Checkout (cont'd)

The printer should print hard copy as shown in Figure 2-6A until STOP is pressed. Each character must be completely printed. If the same row of dots are missing in each line of print, the printer is defective and must be replaced. If any lines are not completely printed (Figure 2-6B) or if the print lines tilt to the right or left (Figure 2-6C), the print head requires adjustment. The print-head must be adjusted while the printer is running. If printer adjustment is not required, proceed to step 14.

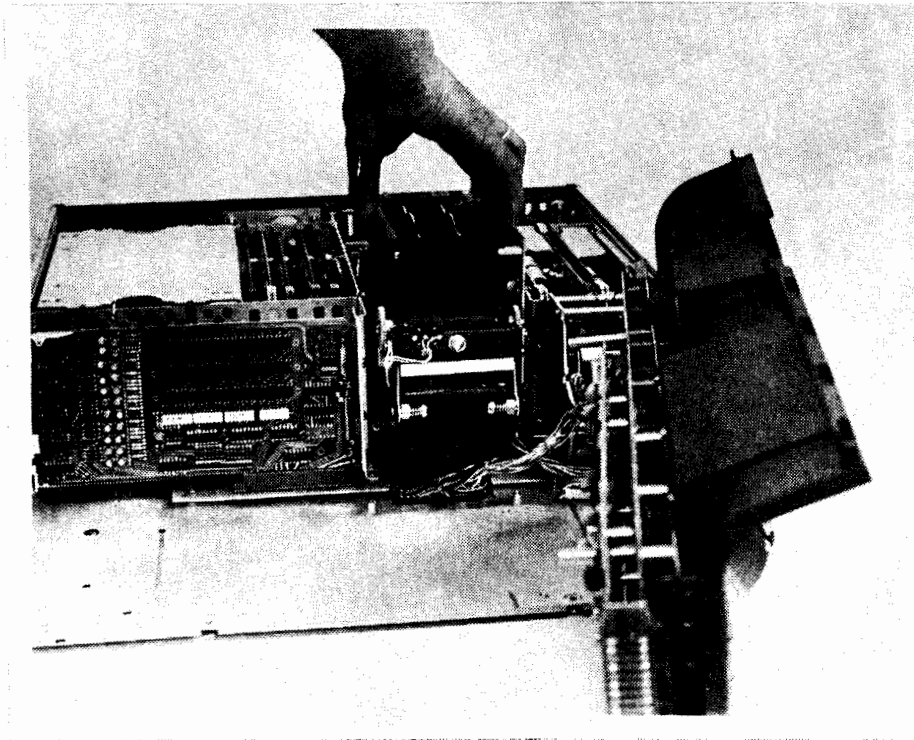

Figure 2-3.
Installing the Printer into the Calculator

9810A PRINTER INSTALLATION (Option 004) [cont'd]

PRINTER CHECKOUT (cont'd)

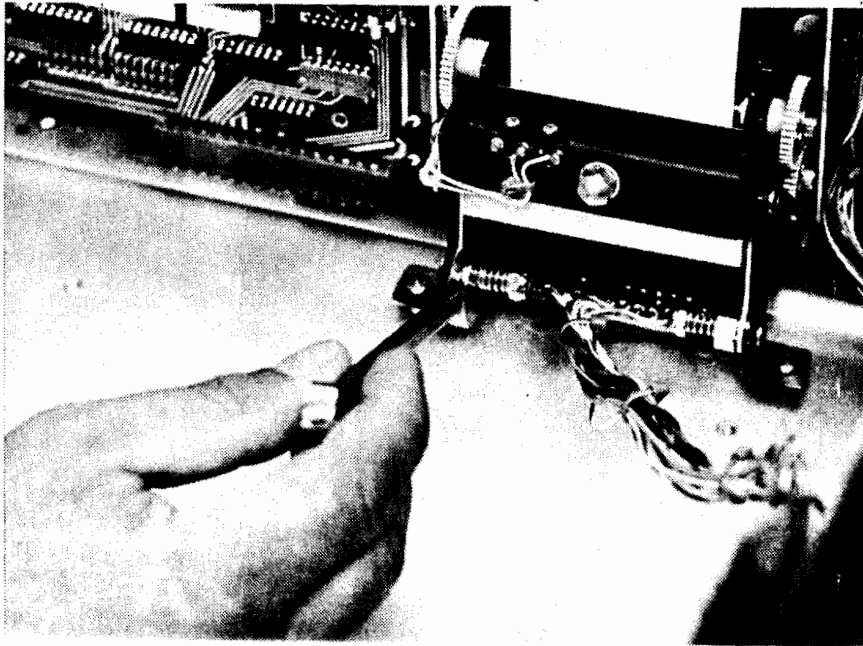

Figure 2-4. Adjusting the Printer

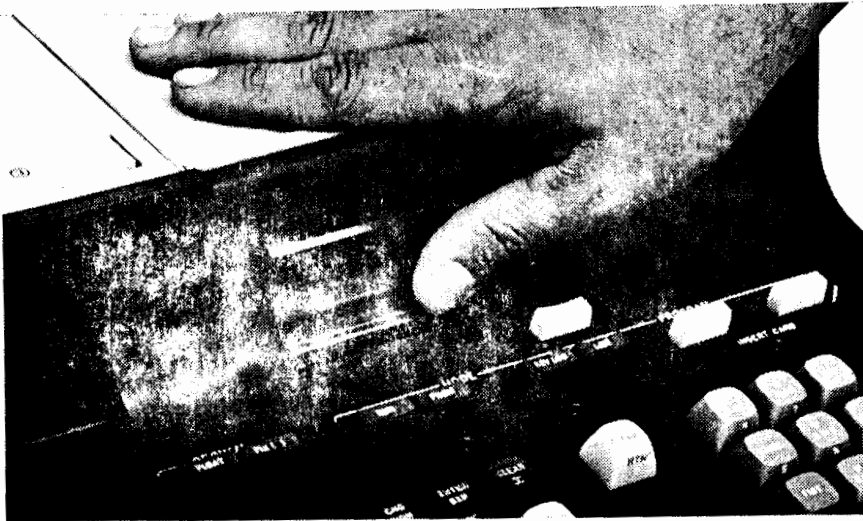

Figure 2-5. Installing the Printer Window

9810A PRINTER INSTALLATION (Option 004) [cont'd]



PRINTER CHECKOUT (cont'd)

13. The printhead adjustment consists of first carefully rotating each of the two adjustment nuts (see Figure 2-4) until the darkest, most uniform printout is obtained; then slowly readjusting each nut until the loudest printing sound is heard. Adjusting for loudest print sound ensures that the head is correctly aligned.

NOTE

If the printer cannot generate clear, uniform hardcopy as shown in Figure 2-6A, the printer should be considered defective and, therefore, replaced.

14. To verify PRINT/SPACE, KEYLOG and LIST operations:

PRESS:   (KEYLOG light ON) 

PRESS:    

The hard copy should appear as shown in Figure 2-7. If any information is missing, repeat this step.

If the printer does not perform as indicated, the problem may be either in the printer or in the mainframe. (Refer to Troubleshooting and Repair Chapter of this manual.)

If the hardcopy appears as in Figure 2-7, proceed to the next step.

9810A PRINTER INSTALLATION (Option 004) [cont'd]

Re-assembly Procedure

After verifying printer operation, the calculator may be re-assembled.

15. Switch the calculator OFF, then disconnect the power cord and remove the printer paper.
16. Replace the keyboard. Then, tip the calculator on the back panel and secure the keyboard with the screws which were removed in step 2.
17. Lower the calculator, replace the printer paper roll and affix the Option 004 identification tag in the space provided under the top cover flap.
18. Replace the top cover and secure it with the 4 screws which were removed in step 4.
19. Remove the opaque printer window and install the clear printer window. The window is removed by carefully sliding it up and forward (see Figure 2-5).
20. To thoroughly exercise the printer, perform the inspection procedure in Chapter 6 of the 9810A Operating Manual.



9820A PRINTER INSTALLATION



Use the same procedure to install a printer into a Model 20 Calculator as described for the Model 10. However, the checkout procedure is not the same. The Model 20 should be checked after a printer installation by running the electrical inspection procedure as described in the 'MODEL 20 SYSTEM ELECTRICAL INSPECTION BOOKLET'. The 9820A printer uses the same adjustments to obtain the proper printout as described for the 9810A.

9810A MEMORY OPTION INSTALLATION

The 9810A can exist in twelve different configurations. The memory module alone can exist in six different configurations (see Figure 2-8).

Table 2-4.
Different Configurations of the Model 10.

1.	Basic	(51 data registers and 500 program steps).
2.	Option 001	(111 data registers) A1 A0
3.	Option 002	(1012 total program steps) A2→top slot
4.	Option 003	(2036 total program steps) A3→top slot
5.	Option 004	(thermal printer) 11219A
6.	Option 001, 002	A1→A0; A2→top slot
7.	Option 001, 003	A1→A0; A3→top slot
8.	Option 001, 004	A1→A0; 11219A
9.	Option 002, 004	A2→top slot; 11219A
10.	Option 003, 004	A3→top slot; 11219A
11.	Option 001, 002, 004	A1→A0; A2→top slot; 11219A
12.	Option 001, 003, 004	A1→A0; A3→top slot; 11219A

NOTE

Option 001 accessories (e.g., 11219A, Opt 001) which are installed include the ZONE 1 installation charge as part of the list price. All other accessories require that a separate billing occur for the installation charges.

9810A MEMORY OPTION INSTALLATION (cont'd)

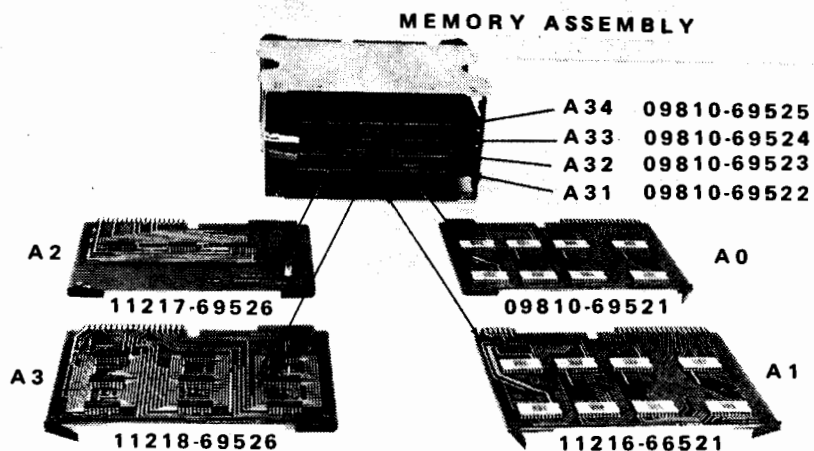

Figure 2-8. The Different Exchange Assemblies that Can Be Installed in the Memory Assembly

Figure 2-8 shows the four memory assemblies (A31-A34 and A0 or A1) which are required in every memory assembly before the memory will function. Either the A2 (Opt 002) or the A3 (Opt 003) assembly may be added to the upper-most PC slot to provide additional program memory. The basic A0 assembly (51 data registers) may be replaced with the A1 assembly (Opt 001) to provide additional data registers. Either the A0 or A1 assembly must be installed in the bottom PC slot before the memory assembly will operate correctly.

INSTALLATION OF OPTIONS 001 - 003

The following procedure should be used when installing or removing any memory PC assembly.

9810A MEMORY OPTION INSTALLATIONS (cont'd)

INSTALLATION OF OPTIONS 001 - 003 (cont'd)

CAUTION

METAL-OXIDE SEMICONDUCTORS (MOS) WILL BE DESTROYED BY STATIC DISCHARGES.

BEFORE EXCHANGING MOS ASSEMBLIES, EQUALIZE THE POTENTIAL BETWEEN YOURSELF, THE CALCULATOR, AND THE MOS ASSEMBLY BY TOUCHING THE CALCULATOR FRAME AND THE PROTECTIVE FOIL-WRAPPING AT THE SAME TIME.

EXCHANGE CREDIT WILL NOT BE ALLOWED ON MOS ASSEMBLIES NOT WRAPPED IN PROTECTIVE FOIL.

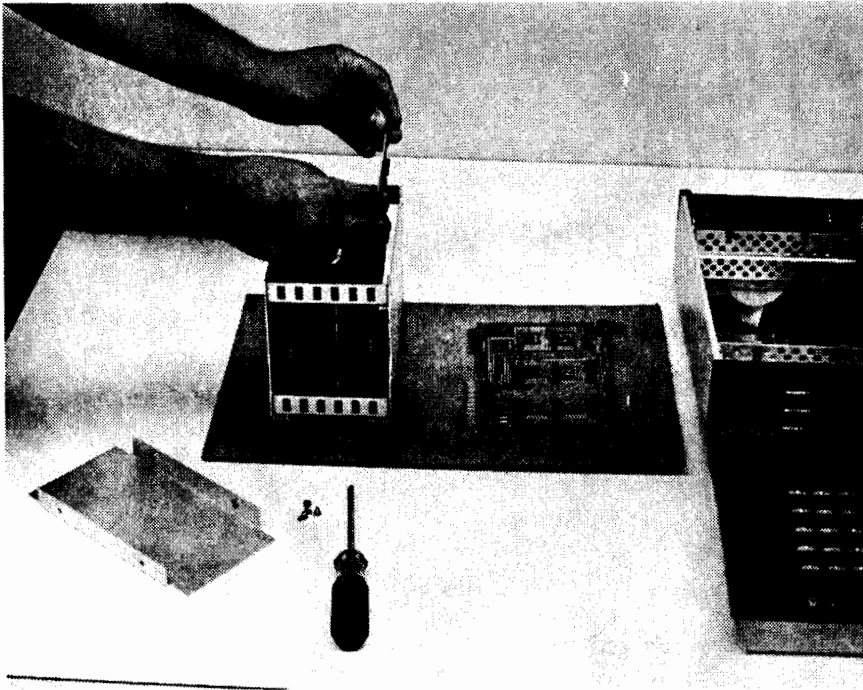

Figure 2-9. Exchanging PC Boards in the Memory Assembly

9810A MEMORY OPTION INSTALLATION (cont'd)

Installation of Options 001 - 003 (cont'd)

Table 2-5. 9810A MOS Memory Assemblies

Reference Designator	-hp- Part Number	Accessory Number	Function
A0	09810-69525	Basic	51 data registers
A1	11216-66521	11216A	111 data registers
A2	11217-69526	11217A	1012 program steps
A3	11218-69526	11218A	2036 program steps
A34	09810-69525	Basic	500 program steps

This procedure describes the installation of additional hardware necessary to provide options 001, 002, or 003 in the customer's Model 10. Each installation requires approximately 30 minutes of installation time.

Tools/Equipment Required

- (1) small pozidriv (or No. 2 Phillips) screwdriver
- (1) Model 10 Exerciser, -hp- Part Number 09810-90021

Top Cover Removal

1. Switch the calculator OFF and disconnect the power cord. Remove any plug-in ROM's.
2. Remove the four screws in the top cover, gently bow the cover up in the middle, and lift it off the mainframe.

Memory Module Removal and Board Replacement

CAUTION

THE FOIL-LINED CARTON IN WHICH THE NEW MEMORY BOARD IS SHIPPED MUST BE USED AS AN ANTI-STATIC SURFACE ON WHICH THE MEMORY MODLE IS PLACED WHILE REPLACING THE MEMORY BOARD.

9810A MEMORY OPTION INSTALLATION (cont'd)

Memory Module Removal and Board Replacement (cont'd)

3. Place the new board and carton as shown in Figure 2-9.

CAUTION

HANDLE THE MEMORY BOARDS ONLY BY THEIR COLORED EXTRACTORS.

4. Remove the four screws which secure the memory module. Remove the module and place it on the foil carton as shown in Figure 2-9.
5. Remove the four screws which secure the module cover and lift the cover off the module.

NOTE

The P.C. board extractors for the new assembly, replaced assembly, and board guides have the same color codes.

6. ● The 11216A or Option 001 (111 storage registers). Remove the 09810-66521 P.C. board (brown board extractors and guide) and replace it with the new 111 register P. C. board (11216-66521).
- The 11217A or Option 002 (1012 program steps). Install the new memory board (11217-66526) in the unoccupied (blue P.C. board guide) location.
- The 11218A or Option 003 (2036 program steps). If the 11217-66526 or a 11217-69526 board exists in the module (blue P.C. board extractor) remove it and replace it with the new board (11218-66526). If no P.C. board with a blue extractor is present (the slot with blue P.C. guide is vacant), install the new board in the vacant slot.

9810A MEMORY OPTION INSTALLATION (cont'd)

Memory Module Removal and Board Replacement (cont'd)

7. When the new P.C. board has been installed, replace the module cover and secure it with the four Phillips screws. Then, CAREFULLY INSTALL the memory module into the mainframe with the four Phillips screws that were previously removed.

Calculator Checkout

8. Reconnect the power cord and switch the calculator ON.
9. The Model 10 Exerciser can be used to checkout the modified calculator. The envelope which is shipped with the magnetic cards and the 9810A Operating Manual provides complete user instructions for the Model 10 Exerciser. If the exerciser does not operate correctly, recheck the procedure which was used to perform the exerciser. If the exerciser still does not run correctly, refer to the Troubleshooting and Repair Chapter of this manual.
10. Install the correct Option decal under the calculator top cover flap.

9820A MEMORY OPTION INSTALLATION

The basic Model 20 exists with one empty PC slot in the memory module. An additional A26 assembly is connected to the memory module in this (previously empty) slot to provide Option 001 (11228A) and increase the 9820A memory from 173 to 429 storage registers (see Figure 2-10). The following procedure describes the necessary information for the installation of the 11228A (Opt 001) memory option and the 11225A (Opt 002) memory option.

9820A MEMORY OPTION INSTALLATION (cont'd)

CAUTION

METAL-OXIDE SEMICONDUCTORS (MOS) WILL BE DESTROYED BY STATIC DISCHARGES.

BEFORE EXCHANGING MOS ASSEMBLIES, EQUALIZE THE POTENTIAL BETWEEN YOURSELF, THE CALCULATOR, AND THE MOS ASSEMBLY BY TOUCHING THE CALCULATOR FRAME AND THE PROTECTIVE FOIL-WRAPPING AT THE SAME TIME.

EXCHANGE CREDIT WILL NOT BE ALLOWED ON MOS ASSEMBLIES NOT WRAPPED IN PROTECTIVE FOIL.

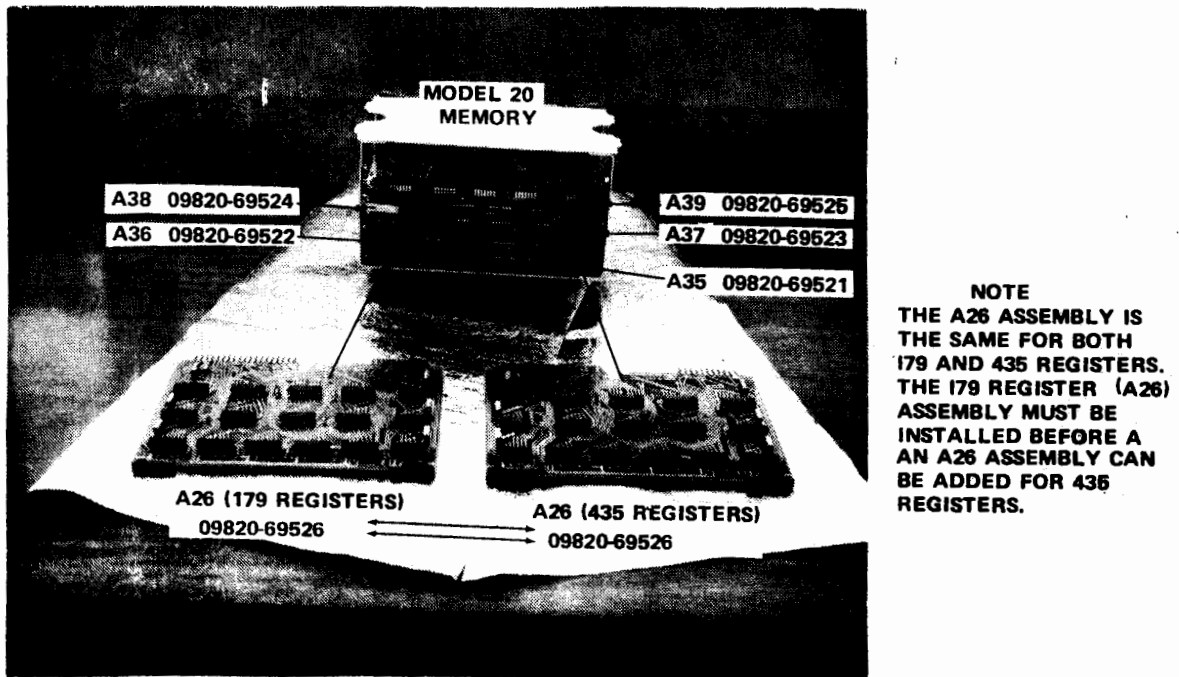

Figure 2-10. The 9820A Memory Configurations.

9820A MEMORY OPTION INSTALLATION (cont'd)

NOTE

The A26 Assembly is the same for both 173 and 429 registers. The 173 register (A26) assembly must be installed before an additional A26 assembly can be added for 429 registers.

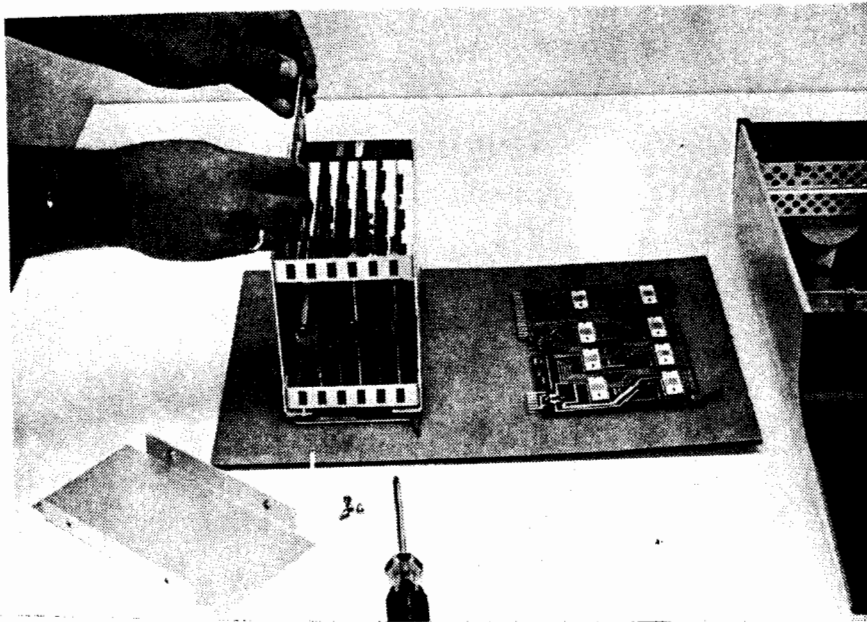

Figure 2-11. Exchanging PC Boards in the Memory Assembly

Tools/Equipment Required

- (1) Small Pozidriv (or No. 2 Phillips) Screwdriver
- (1) Model 20 Exerciser, -hp- Part Number 09820-90030.

Memory Module Access

1. Switch the calculator OFF and disconnect the ac power cord. Then, remove all plug-in ROM's.
2. Remove the four screws in the top cover. Then, gently bow the top cover and lift it off of the mainframe.
3. Remove the four screws which secure the memory module to the chassis.

9820A MEMORY OPTION INSTALLATION (cont'd)

Option 001 Installation

4. Place a piece of foil-lined carton on a flat surface and lay the A26 assembly on the foil as shown in Figure 2-11.
5. Equalize the potential between yourself, the calculator, and the optional A26 assembly by touching both items at the same time.
6. Remove the memory module by lifting upward on the board extractors.
7. Place the memory module on the protective foil as shown in Figure 2-11 and remove the assembly cover.
8. Install option 001 (429 storage registers) in the empty PC slot (blue PC board guides).
9. Replace the assembly cover and install the memory module in the calculator.
10. Connect the ac power cord to the power receptacle on the back panel and switch the calculator ON. 0: END F
11. PRESS: LIST

PRINTOUT: 0:
 END F
 R429

If step 11 results in the correct display and printout, Option 001 is probably installed correctly. To further verify proper calculator operation, perform the electrical inspection procedure in the '9820A SYSTEM ELECTRICAL INSPECTION BOOKLET' (09820-90030).

12. Install the Option 001 decal under the calculator top-cover flap and replace the calculator top cover.

9820A MEMORY OPTION INSTALLATION (cont'd)

Option 002 Installation

1. Switch the calculator OFF, then disconnect the ac power cord.
2. Remove all plug-in ROMs , then remove the top cover from the calculator.
3. Remove the power supply thermal plate, then remove the +5V power supply board (09810-69581).

CAUTION

PROTECTIVE FOIL MUST BE USED AS AN ANTI-STATIC SURFACE ON WHICH THE MEMORY MODULES AND MEMORY P.C. BOARD ARE PLACED WHILE EXCHANGING THE MEMORY BOARDS.



4. Remove the four screws which secure the memory module. Remove the memory module and place it on the protective foil.
5. Place the new memory chassis assembly (11225-67920) next to the original memory assembly.
6. Remove the cover plate from the original memory assembly and the new memory assembly.
7. Remove the two original memory ROM board A35(09820-69521) and A36 (09820-69522) from the original chassis and install them in the same location in the new memory chassis.
8. Replace the new memory chassis cover plate (11225-04121).
9. Install the new memory into the 9820A, then install the new +5V power supply and replace the thermal plate.
10. Connect the ac power cord and switch the 9820A ON. Then, run the 'READ/WRITE MEMORY DIAGNOSTIC TESTS' in the 9820A Electrical Inspection Booklet.
11. Replace the top cover and affix the Opt 002 decal in the space under the top cover flap. Install the plug-in ROMs, and verify that the system is operating correctly.

SEE CALCULATOR PRODUCTS SERVICE NOTE 9820A-1

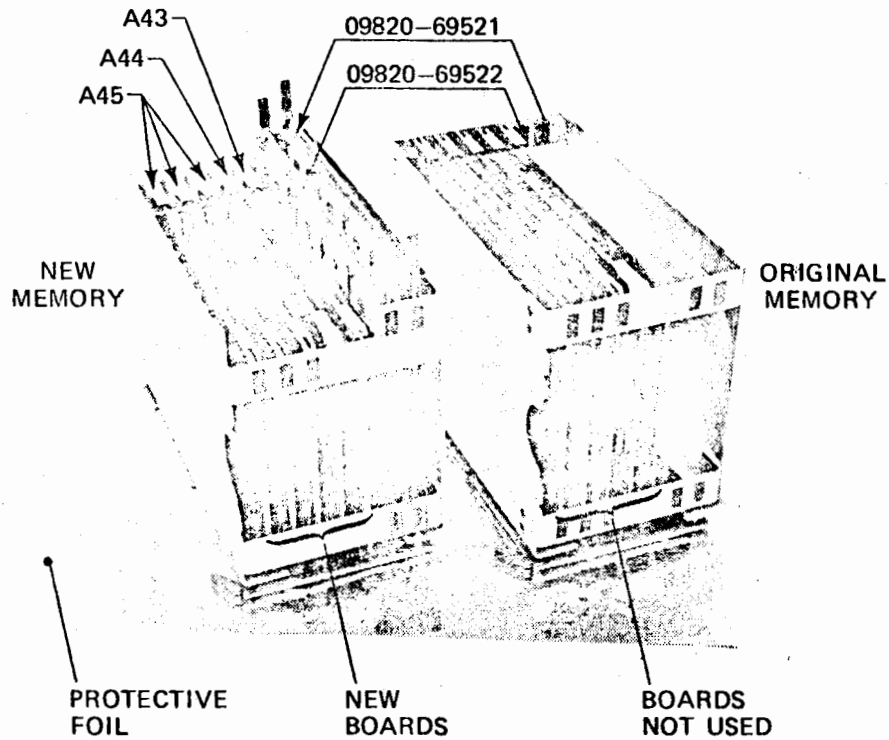

9820A Opt 002 Memory Board Placement

CAUTION

PROTECTIVE FOIL MUST BE USED AS AN ANTI-STATIC SURFACE ON WHICH THE MEMORY MODULES AND MEMORY P.C. BOARDS ARE PLACED WHILE EXCHANGING THE MEMORY BOARDS. HANDLE THE MEMORY BOARDS ONLY BY THEIR CODED EXTRACTORS.

Chapter 3

INSTRUMENT MAINTENANCE

GENERAL

We have found that a few minutes of prevenative maintenance usually results in greater customer satisfaction and fewer service repair calls. This chapter describes a few checks that we recommend be made on the calculator each time a system service call is made.

◆◆◆◆◆ CLEANING THE CALCULATOR AND FAN-FILTER ◆◆◆◆◆

Clean the calculator with a soft cloth dampened in clean water or in water containing a soft soap or mild detergent. Do not use an excessively wet cloth or allow water to penetrate inside the calculator. In particular, do not use any abraasive materials, especially on the display window.

The fan-filter (located on the rear of the calculator) should normally be cleaned about every three months. Clean it by holding it in under running water or by washing it in warm water and then rinsing in clean water. Dry the filter thoroughly before re-installing it.

The filter can be easily removed by using a small blunt instrument such as a screwdriver, a letter opener or a nail file. To replace the filter, snap in first one side and then the other.

◆◆◆◆◆ CLEANING THE MAGNETIC-CARD READER ◆◆◆◆◆

We have found that many card-reader failures are caused by a build up of magnetic material on the cardreader head. We, therefore, recommend that the service representative clean the card reader assembly each calculator serice call. The card reader should also be cleaned whenever it is suspected of being defective.

CLEANING THE MAGNETIC-CARD READER (cont'd)

The card reader head should be cleaned by coating the back (white) side of a spare clean 6" magnetic card with a cotton swab (-hp- Part Number 8520-0023) which has been soaked in either denatured alcohol or a solution of magnetic-head cleaner (use Part No. 8500-1251 only) and then running the card through the cardreader. This procedure should be performed several times, or until the head appears to be clean. Units which are extremely dirty may require that the assembly be removed from the calculator and cleaned with cotton applicators dipped in one of the previously mentioned solutions.

CAUTION

AVOID GETTING THE HEAD CLEANING SOLUTION ON ANY SURFACE OTHER THAN THE METAL PORTION OF THE MAGNETIC-CARD READER. DO NOT USE ANY SOLUTION OTHER THAN THE ONE RECOMMENDED.



PRINTER CHECKOUT



Verify that the printer is operating correctly and that the print-out is satisfactory. If any doubt exists as to proper operation or if the printer appears to be in need of adjustment, refer to the Printer Installation section of Chapter 2.

Chapter 4

PSEUDO-HARDWARE

TABLE 4-1

9810A PSEUDO-HARDWARE INDEX

SYMPTOM	PAGE
<u>9810A IDIOSYNCRASIES</u>	
Magnetic-Card Reader doesn't stop	4-3
Calculator will not load, list, or run programs	4-3
Keyboard entries intermitten in the Keylog mode	4-4
Program which contains subroutines cannot be run	4-4
Changing the sign of exponents appears abnormal	4-4
Blank display, no keyboard control	4-5
Program and keyboard control lost; 'Printer Alpha ROM' installed	4-5
Program lost when automatically loading programs	4-6
X-register will not clear; display blank; listing incorrect	4-7
Printout is compressed	4-7
Pressing PRINT/SPACE prints a dash and dot	4-7
Z-register exponent changes	4-7
<u>9810A ROM BLOCK IDIOSYNCRASIES</u>	
Incorrect results using 'Math ROM' keys	4-8
Inoperative 'Definable Functions ROM'	4-9
Program terminated when typewriter reaches the right margin	4-9
Loss of calculator control and program in memory when listing a program on typewriter (11212A ROM)	4-9

TABLE 4-2

9820A PSUEDO-HARDWARE INDEX

9820A IDIOSYNCRASIES

Note 10 when subtracting very small numbers	4-10
Data not recorded properly	4-10
Printout contains -.000's	4-10
Unexpected displays when going from FLOAT to FIXED	4-11
Loss of display and keyboard control	4-12
Incorrect printout in the TRACE mode	4-12
Program lost following the display of a NOTE 11	4-12
Nonsense displays	4-13

9820A ROM IDIOSYNCRASIES

Plotter 'tic' marks not accurate (11220A PCI ROM)	4-13
11223A Cassette Memory/Special Programs ROM tests	4-13

<u>9810A/9820A READ/WRITE memory problems.....</u>	<u>4-13</u>
--	-------------

9810 IDIOSYNCRASIES

SYMPTOM: Mag-Card Reader continues to run after loading or recording a program.

PROBABLE CAUSE: Last program step is not an END.

The calculator attempts to continue loading or recording programs until an END keycode is encountered. If no END step is in the program, the card-reader will continue attempting to load or record the program steps even though none remain.

SYMPTOM: Calculator will not load, list, or run programs.

PROBABLE CAUSE: Not enough memory or the memory is partially protected.

- a. The calculator cannot contain programs which require more program steps than allocated in memory.
- b. When the Definable Functions ROM is installed in the calculator, part or all of the program memory can be protected. When part of the program memory is protected, the unprotected memory is readdressed so that the first unprotected program step is 0000. For example, if steps 000-099 were protected, step 0100 would be readdressed to be 0000. The last program step available to the user would then be 1935 (Opt. 003 ONLY). Once a portion of the program memory is protected, it may remain protected following the removal of the Definable ROM unless the ac LINE switch is switched OFF which resets the program memory.

9810A IDIOSYNCRASIES (cont'd)

SYMPTOM: Keyboard entries intermittent in keylog mode.

PROBABLE CAUSE: Entries are being made too rapidly.

Time must be allowed for printing to occur when keyboard entries are made while the calculator is in Keylog. The time required for printing is approximately 1/4 second.

SYMPTOM: Program which contains Subroutines cannot be run.

PROBABLE CAUSE: User error; nesting over 5 Subroutines.

The calculator contains a counter routine which keeps a current account of nested subroutines. The counter is only reset by an END program step and allows a maximum of 5 subroutines to be nested. If a program (containing less than 5 subroutines) is partially run, stopped, and repeated using a GO TO Ø CONTINUE (no END), the counter can be incremented beyond 5. When the calculator attempts to nest a 6th subroutine, the program is stopped and a STATUS condition is indicated.

SYMPTOM: Changing the sign of exponents appears abnormal.

PROBABLE CAUSE: Normal operation; multiplication by powers of ten.

The repeated pressing of CHANGE SIGN does not necessarily alter the sign of the exponent. Instead, the CHANGE SIGN key causes the sign of the last unterminated exponent to be changed and adds it to the original exponent. (An exponent of Ø has no + or - value.) (cont'd on the next page)

9810A IDIOSYNCRASIES (cont'd)

EXAMPLE: ENTER: 123.4 into X (display 1.234 exp 02)
ENTER EXP 8 (adds 10^8 to 10^2)
Display: 1.234 exp 10
PRESS: CHANGE SIGN (changes the sign of 10^{+8} to 10^{-8}
and adds the result (10^{-8}) to the
original exponent (10^{+2})
DISPLAY: 1.234 exp -06

SYMPTOM: Display is blank, no keyboard control.

PROBABLE CAUSE: Temporary power interruption.



A power interruption of less than 1/2 second causes the +5V power supply to latch and removes power to the calculator logic. (This can be simulated by quickly switching the ac LINE switch OFF and ON.) Normal calculator operation can be returned by switching the calculator OFF, waiting a few seconds, and switching the calculator ON. However, the calculator memory is erased.

SYMPTOM: Program and Keyboard control lost, Printer Alpha ROM installed, and the last Printout is:

```
./ C71S71-9%9822  
9X.
```

PROBABLE CAUSE: User error; calculator memory exceeded in the Printer Alpha Mode.

If the end of memory routine (CLEAR X, DIVIDE, END) is executed in the Printer Alpha Mode, the calculator causes the printing of the printout shown above and locks up the keyboard. To return the calculator to normal operation, switch the ac power OFF, wait a few seconds, and switch the calculator ON.

9810A IDIOSYNCRASIES (cont'd)

SYMPTOM: Program lost when Automatically Loading Programs.

(FMT GO TO)

PROBABLE CAUSE: Normal Operation; extra STOP required in beginning of new program.

In some cases, an extra STOP may have to be added to a program if that program is to be run by means of 'FMT, GO TO'. Without the STOP the program may not operate correctly:

- a. Programs containing the 'TO RECTANGULAR' or 'TO POLAR' instruction (for the -hp- 11210A Mathematics Block) - at least one (programmed) STOP instruction must be executed sometime before the first of either the 'TO RECTANGULAR' or 'TO POLAR' instructions is executed. Only one such stop is needed; then the program will run normally. Should the program itself contains a 'FMT, GO TO' to call for another program - at least one (programmed) STOP must be executed sometime before that 'FMT, GO TO' is executed.

In many programs a STOP would normally be included because of a data entry; where there is no data to be entered, press CONTINUE, to resume program execution, after the stop. An extra STOP included at the beginning of a program to be run by 'FMT, GO TO' could be used to advantage as a check to verify that the correct program has been loaded. For example:

STEP	KEY
0000	CLEAR X
0001	3
0002	STOP

would indicate to the operator that program #3 had just been loaded.

9810A IDIOSYNCRASIES (cont'd)

SYMPTOM: X-Register will not clear; blank display; incorrect listings.

PROBABLE CAUSE: Possible user error; PAPER advance may have been pressed during program execution.

Pressing PAPER advance while a program is running may result with one or more of the above symptoms. This is caused by the calculator stopping the program in an abnormal condition. The only means of returning to normal operation, although the memory is erased, is to switch ac power OFF, wait a few seconds, and switch the ac power ON.

SYMPTOM: Printout is compressed.

PROBABLE CAUSE: Normal operation.

The first PRINT/SPACE instruction following either turn-on or advancing the paper may result in compressed print. If a Printer Alpha ROM is installed this can be avoided by pressing FMT FMT CLEAR FMT; thus causing the paper to advance one space.

SYMPTOM: Pressing PRINT/SPACE prints a dash and dot.

PROBABLE CAUSE: User error; PRINT/SPACE pressed too rapidly.

If the PRINT/SPACE key is pressed too rapidly, a dash and dot may be printed.

SYMPTOM: Z Register exponent changes.

PROBABLE CAUSE: Calculator Anomaly

Under some circumstances, the contents of the Z register may be changed. This is due to a problem on the A0 (51 data register) assembly which has been corrected on new versions of that assembly. (cont'd on the next page)

9810A IDIOSYNCRACIES (cont'd)

These assemblies should not be replaced to correct this situation, since the Z register is used only for temporary storage. If the operation of the Z-register becomes critical, contact Calculator Customer Service in either GMBH or Loveland.

SYMPTOM: Display does not clear after turn-on.

PROBABLE CAUSE: Calculator Anomaly

This problem is due to electronics problems on the A \emptyset (51 data register) assembly and has been corrected on new versions of that assembly. Contact Loveland Division (service department) or GMBH before replacing these assemblies to correct this problem.

9810A ROM BLOCK IDIOSYNCRASIES

SYMPTOM: Incorrect results using Math ROM (11210A) Keys

PROBABLE CAUSE: Calculator anomaly.

If a defined function is called from the calculator keyboard by pressing the math DEFINABLE key, and any one of the math block keys listed below are included in the definable function, the math block operations defined by that key may yield incorrect results.



4 and 7

This problem occurs only when the defined function is called from calculator keyboard; the same defined function will operate correctly when it is called in a program.

9810A ROM BLOCK IDIOSYNCRASIES (cont'd)

The problem can be avoided by inserting a STOP instruction in the program between the definable key and the first occurrence of any one of the math block keys listed above. When the function is being called only in a program, the STOP instruction can be replaced with a CONTINUE.

SYMPTOM: Inoperative Definable Functions ROM (51 data register memory only).

PROBABLE CAUSE: Calculator anomaly.

The DEFINABLE FUNCTIONS BLOCK must be 'initialized' each time it is plugged into a 9810A Calculator without Opt 001.

To initialize the block:

PRESS:

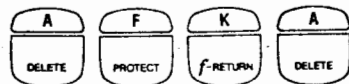

SYMPTOM: Programs Terminated when typewriter reaches right margin.

PROBABLE CAUSE: User error; typewriter margins not set properly.

The typewriter margins must be set to conform with typed messages; either from programs or the calculator keyboard.

SYMPTOM: Loss of Calculator Control and Program in Memory while Listing Program (11212A ROM only) on the typewriter.

PROBABLE CAUSE: User error; END or STOP STOP must be used when listing programs. (cont'd on the next page)

9810A ROM BLOCK IDIOSYNCRASIES (cont'd)

When the user wishes to continue listing a program which is in the calculator memory, the key sequence must be one of the following (assuming STOP has been pressed once):

a.  a. **STOP** **GO TO** **program** **step** **FMT** **2** **LIST**

b.  b. **END** **GO TO** **program** **step** **FMT** **2** **LIST**

(GO TO need only be used if a step other than 0000 is to be listed first.)

◆◆◆◆◆ 9820A IDIOSYNCRASIES ◆◆◆◆◆

(See page A-10 of the '9820A Operating and Programming Manual')

SYMPTOM: NOTE 10 when subtracting very small numbers.

PROBABLE CAUSE: Calculator anomaly.

Subtracting any number less than 1.0 E-87 from itself results in a NOTE 10 in the display.

SYMPTOM: Data Not Recorded Properly.

PROBABLE CAUSE: User error; wrong syntax used.

Rec"DA", A, B, ... or REC R(n) syntaxes do not result in an error note, but do not record data properly. The exponent of the first word in the first register is not recorded.

SYMPTOM: Printout Contains Negative Zero's (-.000)

PROBABLE CAUSE: Calculator anomaly (see page A-10 of the '9820A Operating and Programming Manual')

(cont'd on the next page)

9820A IDIOSYNCRASIES (cont'd)

If, when printing or displaying fixed point, a number is close enough to zero to appear as all zeros (.000...), the sign attached to the number will be the same as the previously printed or displayed number.

PRESS: FIXED (n) 3; PRT E-5; PRT -1, E-5; PRT -E-5;
 PRT -1, -E-5 STORE

PRESS: END RUN PROGRAM

PRINTOUT:

```
                  .000  
                 -1.000  
                 -.000  
                  .000  
                 -1.000  
                 -.000
```



SYMPTOM: Unexpected displays when going from FLOAT to FIXED.
PROBABLE CAUSE: Calculator anomaly (see page A-10 of the '9820A
Operating and Programming Manual').

When going from FLOAT N to FIXED N unexpected displays may occur.
Example:

PRESS: 2→A 3→B; DSP A+B EXEC

DISPLAY: 5.0000....E 00

PRESS: FIXED () 7 EXEC

DISPLAY: 7.0000....E 00

PRESS: 5→X EXEC

DISPLAY: 5.0000....E 00

PRESS: CLEAR FIXED () 2 EXEC

DISPLAY: 5.00 (first display is recalled, [after cleared],
 in the fixed 2 notation).

9820A IDIOSYNCRASIES (cont'd)

SYMPTOM: Loss of Display and Keyboard Control.

PROBABLE CAUSE: Temporary power interruption.

Temporary power interruptions of less than 1/2 second cause the +5Volt supply to latch OFF; thus all of the calculator logic is disabled. The only means of correcting this condition is to switch the calculator OFF, wait a few seconds, and switch the calculator ON.

SYMPTOM: Incorrect Printout in the TRACE Mode.

PROBABLE CAUSE: Calculator anomaly.

If the calculator is in the TRACE mode when a line is executed from the keyboard, BACK is pressed, and the line is shortened and again executed an incorrect printout showing two lazy T characters results. (The line is, however, executed properly.)

Example:

```
PRESS:          TRACE EXEC
PRESS:          R123 EXEC
PRESS:          BACK  BACK  BACK  EXEC

PRINTOUT:      R123T
                0.0000000000E 00
                R1T3T
                0.0000000000E 00
```

SYMPTOM: Program Lost following the Display of a NOTE 11

PROBABLE CAUSE: User error; calling ENTER statements from another ENTER statement.

If, during an ENTER statement, a subprogram is called which contains another ENTER statement, NOTE 11 will be displayed. If NOTE 11 is display STOP should always be pressed until STP appears in the display. Then press:

(The memory is erased because a subprogram is exited without executing an END.)

9820A IDIOSYNCRASIES (cont'd)

SYMPTOM: Nonsense Displays (unpredictable)

PROBLE CAUSE: User error after editing a line which was too long to be stored (NOTE 09).

Nonsense displays may be seen when a user attempts to store lines which are too long (NOTE 9) then presses BACK in an attempt to shorten his line. The results of this operation are not predictable. NOTE 9 lines should always be rewritten instead of salvaged to avoid this type of problem.

SYMPTOM: Plotter 'Tic' Marks not accurate (11220A PCI ROM)

PROBABLE CAUSE: Normal operation, see PCI Operating Manual.

IMPORTANT NOTE

THE 'MODEL 20 SYSTEM ELECTRICAL INSPECTION BOOKLET' ROM TEST DOES NOT TEST THE 11223A CASSETTE MEMORY/ SPECIAL PROGRAMS ROM BLOCK. THIS ROM BLOCK CAN ONLY BE TESTED BY USING 'SUPPLEMENT F' (09820-90059) OF THE BOOKLET.

◆◆◆◆◆ ADDITIONAL NOTES ◆◆◆◆◆

If the 9810A or 9820A symptoms are intermitten memory losses, false status lights, chinese characters, loss of keyboard control, or losses of portions of a program, the 09810-69522 or 09820-69523 board may be the source of the trouble. If these symptoms occur and NO OTHER FAILURE CAN BE FOUND, the above named assemblies, depending upon the calculator in question, should be exchanged on the Blue Stripe Program.

ADDITIONAL NOTES

Improper magnetic-card reader operation may sometimes result due to an improperly grounded card reader. A modification procedure is provided on page 6-28 which provides more adequate grounding of the card reader.

Chapter 5

ASSEMBLY ACCESS

9810A/9820A ASSEMBLY REMOVAL

Top Cover Removal

IMPORTANT NOTE



Always note the customer's options, ROM's, and peripheral connections before removing any of the assemblies. Do NOT rely only on the option label beneath the top cover, as the label may not be current.

Most calculator assemblies can be accessed following the removal of the calculator's top-cover. The top cover may be removed by first removing the four screws (under the flap) which secure the cover to the chassis. Then, gently bow the cover and lift it off of the chassis (see Figure 5-1).

CAUTION

THE CALCULATOR MAY BE DAMAGED IF ANY ASSEMBLY IS INSTALLED OR REMOVED WITH AC POWER APPLIED TO THE REAR PANEL RECEPTACLE AND THE CALCULATOR SWITCHED ON.

9810A/9820A ASSEMBLY REMOVAL (cont'd)

Top Cover Removal (ccnt'd)

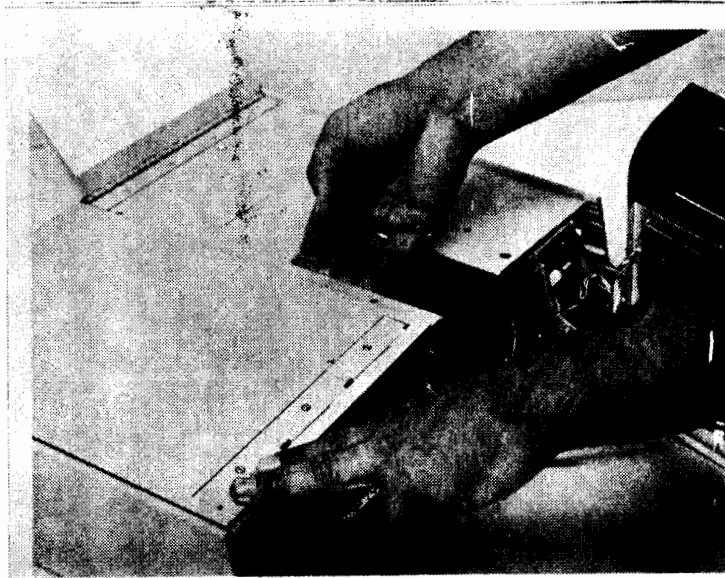

Figure 5-1. Removing the Calculator Top Cover

The Processor Assemblies

Switch the calculator OFF and remove any ac power. Each of the four processor assemblies (A16-A19) can be removed following the removal of the calculator top cover. Each processor assembly, when defective, should be exchanged on the -hp- Blue Stripe Program.

Power Supply Assemblies

With the exception of the +5V supply, each power supply output can be monitored on the test points which can be accessed through the slots in the isothermal (cover) plate. The +5V supply can be monitored using pin 14 (top-rear) on any one of the processor 14 pin integrated circuits. Table 5-1 lists the power supply specifications.

9810A/9820A ASSEMBLY REMOVAL (cont'd)

Power Supply Assemblies (cont'd)

Table 5-1. Power Supply Output Specifications

Power Supply	Nominal Voltage	Tolerance
+5V	+5V	±.1V
+12V	+12V	±.2V
+20V	+19.5V	±.6V
+24V	+24V	±.8V
-12V	-12V	±.4V
+16V	+16V	±.5V

If one or more of the power supplies is suspected of being defective, switch the calculator OFF and remove any ac power. Remove the access screws in the isothermal (cover) plate. The suspected power supply may be placed on an extender board and repaired either in the calculator at the customer's location or in the service kit at the service office.

NOTE

The +12V supply must have the correct output before any other power supply can switch ON.

The Troubleshooting and Repair Chapter of this manual provides the information necessary to repair each of the power supply assemblies.

Memory Assemblies

The calculator memory assemblies are contained in a separate shielded module. The memory module can be removed by first switching the calculator OFF and removing ac power. Next, place a protective-foil carton, foil side up, on a flat surface next to the calculator. Place the service kit memory module on the protective foil as shown in Figure 5-2. Equalize the potential between all of the assemblies by touching the kit module, foil, and

9810A/9820A ASSEMBLY REMOVAL (cont'd)

Memory Assemblies (cont'd)

calculator module at the same time. Once this is done, excessive movement (especially on a carpeted floor) should be avoided.

CAUTION

THE MOS MEMORY ASSEMBLIES LISTED IN TABLE 5-2 WILL BE DAMAGED BY STATIC DISCHARGE. THESE ASSEMBLIES SHOULD ONLY BE HANDLED BY THEIR BOARD EXTRACTORS, AND SHOULD BE PROTECTED BY THE FOIL-LINED CARTON WHENEVER POSSIBLE.

Table 5-2. The Calculator MOS Memory Assemblies

Ref. Desig.	-hp- Part Number	Accessory Number	Function
A0	09810-69521	Basic	51 data registers (9810A)
A1	11216-66521	11216A	111 data registers (9810A)
A2	11217-69526	11217A	1012 program steps (9810A)
A3	11218-69526	11218A	2036 program steps (9810A)
A34	09810-69525	Basic	500 program steps (9810A)
A35	09820-69521	Basic	ROM Ass'y No. 1 (9820A)
A36	09820-69522	Basic	ROM Ass'y No. 2 (9820A)
A26	09820-69526	Basic & 11228A	R/W Memory (9820A)
A45	11225-69545	11225A	R/W Memory (Opt 002 9820A)

Remove the four screws which secure the module to the chassis, and remove the module by lifting up on the module motherboard extractors until the module is free of its connector. Use the metal module-shield to lift the module out of the calculator and place the module, pc board down, on the protective foil as shown in Figure 5-2. Remove the four screws which secure the module cover in place, and remove the cover. The individual memory assemblies can now be accessed, and, if defective, exchanged on the -hp- Blue Stripe Program.

9810A/9820A ASSEMBLY REMOVAL (cont'd)

Memory Assemblies (cont'd)

IMPORTANT NOTE

The MOS Assemblies listed in Table 5-2 will not be accepted on the exchange program unless they are wrapped in protective foil.

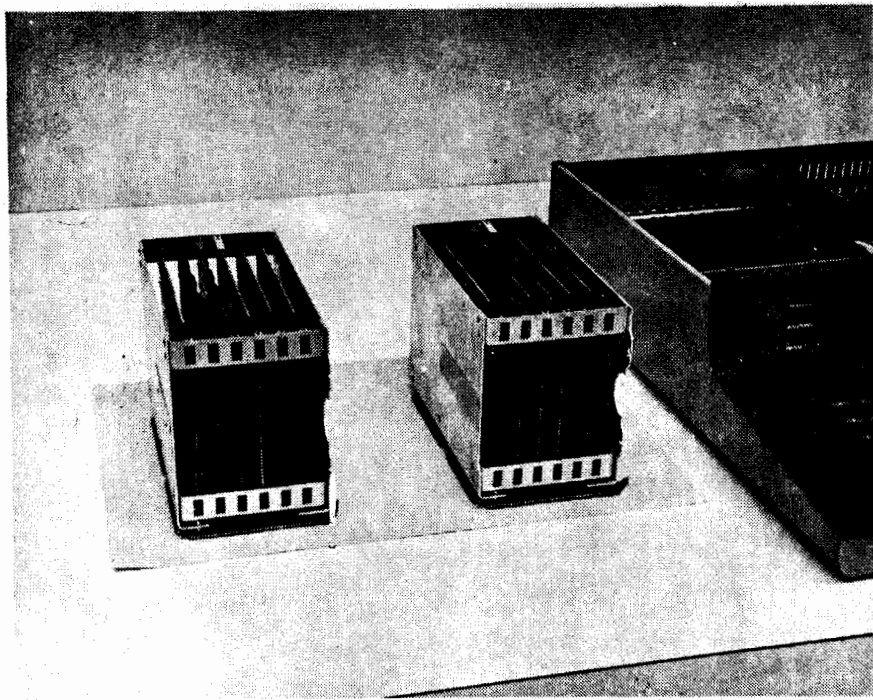

Figure 5-2. Exchanging the Memory Assemblies

The Keyboard Assemblies (9810A and 9820A)

Each of the calculator keycaps can be replaced should they become lost, cracked, or marred. This can be accomplished by bending two paper clips so that they can be hooked under the keycap. Next, use one hand to pull the cap off the key while using the other hand to prevent the key-return spring (retained by the key cap) from leaving the key lever (see Figure 5-3).

The Keyboard Assemblies (cont'd)



Figure 5-3. Removing the Calculator Key

The keyboard assembly consists of the keyboard, all keys, display window, keyboard logic assembly, ac power cable, and the keyboard signal cable. All of these assemblies should be exchanged as one unit.

The keyboard can be removed by switching the calculator OFF and disconnecting all of the ac power cords and I/O Signal cables which are connected to the calculator back panel. Set the calculator on the back panel (with the bottom of the instrument toward you) and remove the four screws (see Figure 5-4) which secure the keyboard to the chassis. Next, return the calculator to the normal position and slide the keyboard forward a few inches. Then, taking care not to damage the interconnecting cables, swing the keyboard to the right (see Figure 5-5). The Keyboard can be removed by disconnecting the ac power cable and unplugging the signal cable from the calculator.

9810A/9820A ASSEMBLY REMOVAL (cont'd)

The Keyboard Assemblies (cont'd)

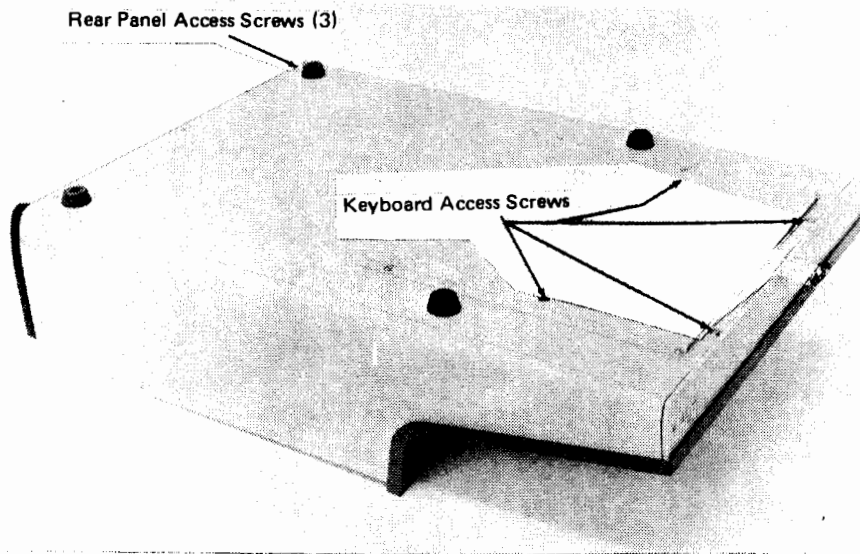

Figure 5-4. The Keyboard Access Screws

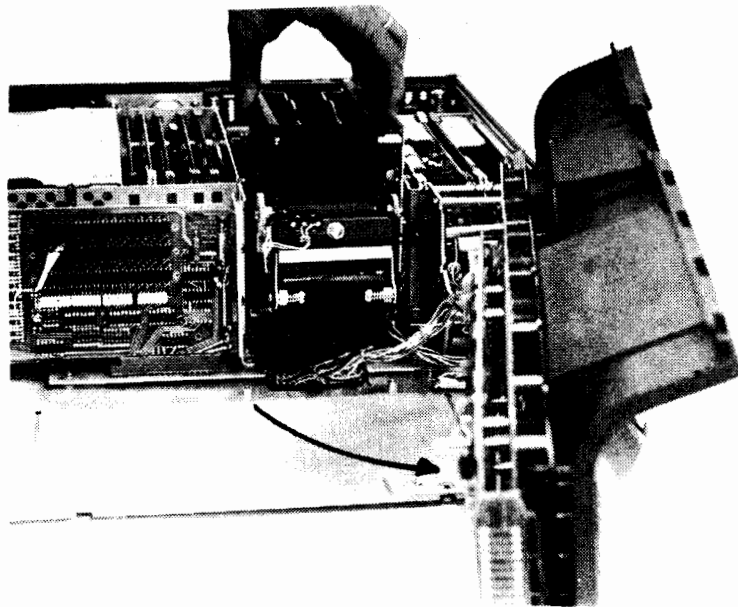

Figure 5-5. The Keyboard in the Access Position

9810A/9820A ASSEMBLY REMOVAL (cont'd)

Magnetic-card Reader Removal

NOTE

Prior to removing the card reader, always perform the card reader maintenance procedure described in Chapter 3.

The card reader consists of two assemblies; one assembly is the mechanical assembly and the second assembly is the electronic assembly which is located to the immediate left of the mechanical assembly. The two assemblies must be exchanged as one unit.

The following procedure should assist you in the removal of the card reader:

1. Switch the calculator OFF and remove any ac power. Then, remove the top cover and position the keyboard in the position shown in Figure 5-5.
2. Remove the connector on the front (keyboard) end of the card reader electronic assembly.
3. While observing precautions not to damage the card reader interconnecting wiring, lift the electronic assembly up and remove the pc-guide stud from the slot in the power supply chassis sheetmetal. Then place the electronic assembly on top of the power supply assembly.
4. Remove the four screws which secure the mechanical assembly to the calculator chassis.
5. Carefully lift the mechanical assembly out of the chassis.

9810A/9820A ASSEMBLY REMOVAL (cont'd)

Magnetic-Card Reader Removal (cont'd)

CAUTION

WHEN REPLACING A REBUILT CARD READER INTO THE CALCULATOR, ENSURE THAT THE ELECTRONIC ASSEMBLY PC-GUIDE STUD IS PROPERLY PLACED IN THE ALLOCATED SLOT AND THAT THE INTER-CONNECTING WIRING IS NOT PINCHED BETWEEN THE CARD READER AND CALCULATOR CHASSIS.

Printer Removal



NOTE

Prior to exchanging the printer, verify that the printer is aligned properly by performing the alignment procedure described in the 'Printer Installation' section of Chapter 2.

The printer can be removed by performing the following procedure:

1. Switch the calculator OFF and remove any ac power.
2. Remove the calculator top cover and place the keyboard in the position depicted in Figure 5-5. Remove the printer paper.
3. Remove the screws located in the front of the printer which secure the printer in place (see Figure 5-6).
4. Remove the two screws located on top and in the back of the printer.
5. Lift the printer up, out of the PC connector, then pull the unit forward until it can be removed from the chassis.

9810A/9820A ASSEMBLY REMOVAL (cont'd)

Printer Removal (cont'd)

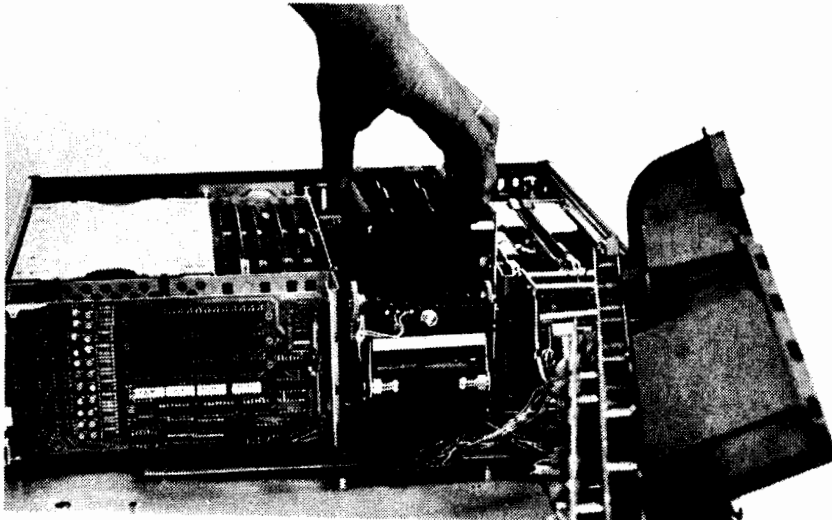

Figure 5-6. Removing the Printer

NOTE

The printer consists of two assemblies; the mechanical printer assembly and an attached electronic assembly.

6. The two printer assemblies must be exchanged together as one unit on the Blue Stripe Exchange Program.

IMPORTANT NOTE

Ensure that a strip of printer paper is between the printhead and platen (roller) before packaging the printer for shipment.

9810A/9820A ASSEMBLY REMOVAL (cont'd)

Rear Panel Access

WARNING

HIGH VOLTAGES MAY BE PRESENT ON THE REAR PANEL. DO NOT DISASSEMBLE THE REAR PANEL UNTIL ALL AC POWER IS REMOVED FROM THE CALCULATOR.

The rear panel may be accessed by removing the three screws in the bottom of the calculator (see Figure 5-4) and loosening the two 11/32" nuts located on the top-rear portion of the chassis. The rear panel can, then, be pulled out of the back of the calculator.

Each of the back panel components (see Figure 5-7 and 5-8) should be replaced with new replacement parts. Chapter 6 of this manual provides additional information for the repair of these assemblies.

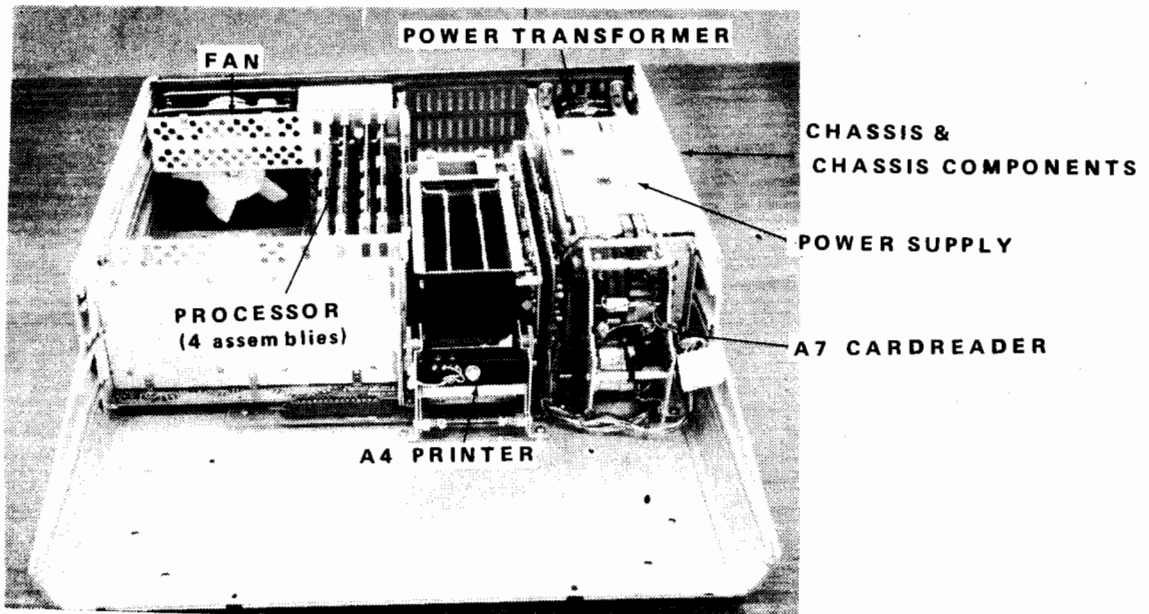

Figure 5-7. The Calculator Chassis

Chapter 6

TROUBLESHOOTING & REPAIR

9810A/9820A GENERAL INFORMATION

This chapter is intended to assist you in determining which calculator assembly is defective and detailed information for repairing of the power supply and rear panel assemblies. Chapter 5 provides information which is intended to assist you in the removal of the calculator assemblies.

CAUTION

SPECIAL TECHNIQUES ARE REQUIRED WHEN THE CALCULATOR MEMORY ASSEMBLIES ARE BEING SERVICED. FOR THIS REASON, YOU SHOULD BE THOROUGHLY FAMILIAR WITH THE MEMORY ASSEMBLY REMOVAL SECTION OF CHAPTER 5.

Whenever space is available, the recommended calculator/kit configuration is to have the service kit (intact) placed on the right side of the defective calculator, and a sheet of the (memory) protective foil on the left side. This enables you to exchange the calculator and kit assemblies more easily and provides a position, for the exchange of the memory assemblies, which uses the protective foil. If space is not available to permit the previous configuration, place the foil-lined carton next to the calculator and then place the kit in the immediate vicinity where the kit assemblies can be easily accessed.

The magnetic-card reader and printer require that instrument maintenance procedures be performed when the assemblies are suspected of being defective. These procedures are found in Chapter 3.

9810A and 9820A CALCULATOR
BLOCK DIAGRAM

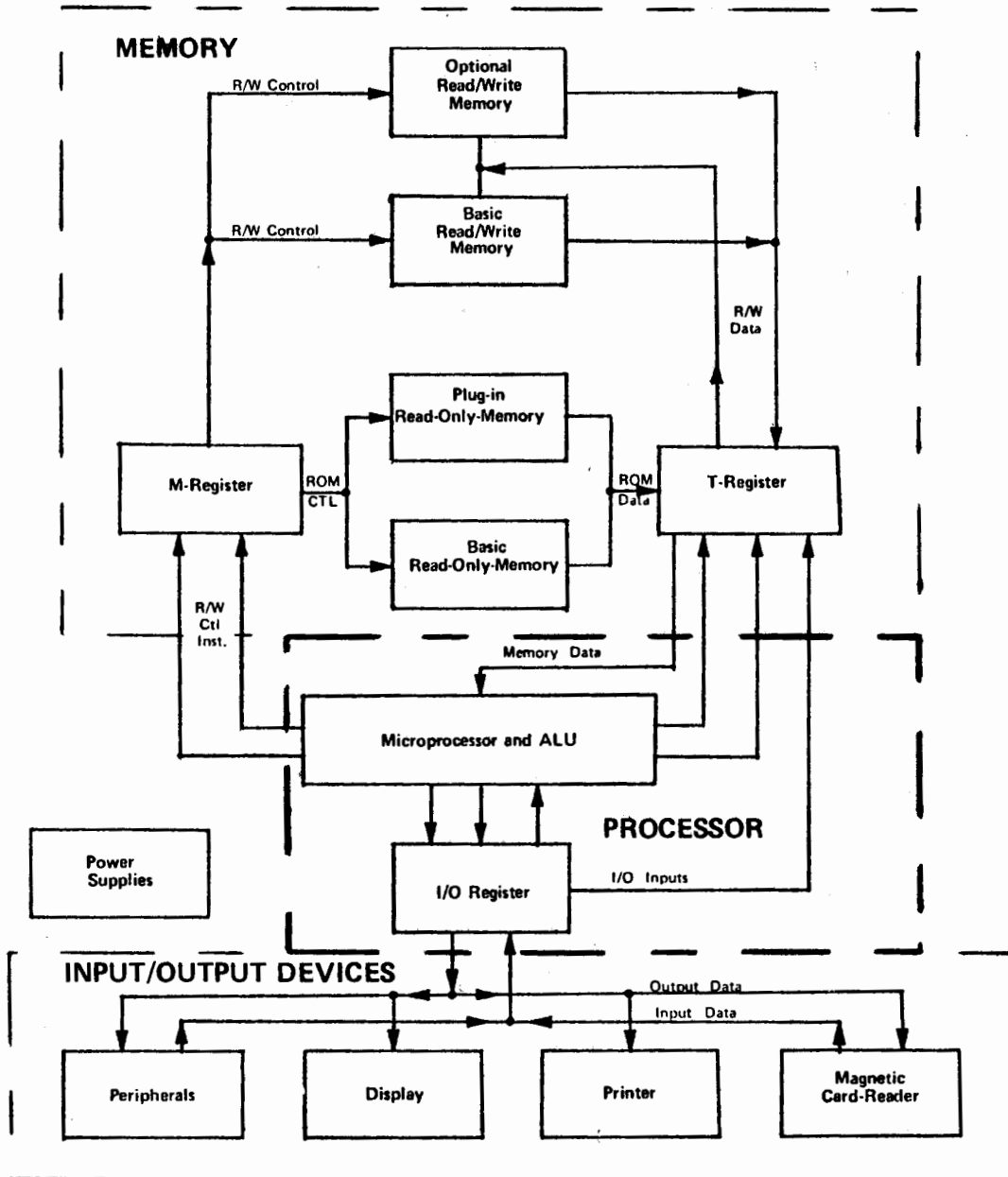

9810A/9820A GENERAL INFORMATION (cont'd)



ASSEMBLY	FUNCTION
Power Supplies	Provides +5V, ±12V, +16V, +19.5V, dual +24V dc power to the various calculator assemblies.
Read/Write Memory	User data a program storage area. Also used for machine bookkeeping.
Read-Only-Memory	Contains micro instructions for processor routines and also the machine language.
Keyboard	User data and program input area. Contains logic for inputting key codes into calculator I/O register.
Printer	Calculator hardcopy output mechanism.
Display	Display and LED drive logic.
Magnetic-Card Reader	Provides a means of permanently storing programs or data from R/W memory.
I/O Register	Controls inputs and outputs of calculator including signals to keyboard, display, printer and card-reader (2 assemblies). Also contains basic machine clock (8 M Hz).
M-Register	Memory Control logic.
T-Register	Controls transfer of data into or out of memory.
Microprocessor	Uses ROM data (in the form of micro-instructions) to control all calculator operations.
Arithmetic-Logic Unit	Processor assembly that provides arithmetic functions.

THE CALCULATOR PRINCIPLES OF OPERATION

The following presentation describes the calculator block diagrams on pages 6-2 and 6-3. The purpose of this presentation is to familiarize you with the principles of operation of each calculator assembly.

A 9800-Series calculator can be described as consisting of six basic blocks: The power supplies (described in detail later in this chapter), input/output devices (display, keyboard, etc.), processor or central processing unit (CPU), memory, I/O register, and plug-in ROM's.

Input/Output Devices

Communication between the operator and calculator is provided by any one of four internal I/O devices (the keyboard, display, printer - if installed, and magnetic-card reader) and any externally connected peripheral (e.g., typewriter, tape reader, plotter, etc.).

Each internal I/O device operates as though it were connected to one of the calculator I/O slots. The signals which are input to these devices, however, provide specific instructions for the indicated device (e.g., which display LED's or printer print-resistors are enabled or which code is recorded onto a magnetic card). Like peripherals, each internal device is addressed using a specific select code and utilizes the standard calculator I/O signals (e.g., CEO, SIH, CFI, etc). Each device must also contain some logic and the driver circuits necessary to perform its assigned function.

In general, if one I/O device appears to be defective while other devices appear to operate normally, that device (or the connections to that device) is defective. If two or more devices appear to be defective, the failure is probably some other calculator assembly-- possibly the mother board.

THE CALCULATOR PRINCIPLES OF OPERATION (cont'd)

Input/Output Register

The I/O Register (A16 and A17) is part of the processor and enables communications between the calculator and an internal I/O device or a peripheral. The I/O signals, from I/O devices, are temporarily stored in the I/O register until the processor can begin an input or output routine. Each time a character (16 bits) is input, say from the keyboard, the 16 bit character is stored in the I/O register and an interrupt signal is sent from the I/O register to the processor. The processor can then interrupt its routine and input the new character, continue its routine until an input routine is possible, or completely disregard the new character.*

To summarize, we can view the I/O register as a temporary storage facility and signal/timing bus that enables calculator communications with I/O devices (i.e., a telephone). An I/O Register failure would probably be indicated by the inability of the calculator to input or output data. (This symptom could, however, also be indicated by other defective calculator assemblies.)

The Calculator Memory

Each calculator utilizes two types of memory (i.e., temporary or permanent data storage areas): The Read/Write Memory and the Read-Only Memory. The R/W memory is primarily used to store user-inputted data and programs, which are used by the processor to perform the task assigned by the user. The read-only memory contains hard-wired data. The processor uses this data to translate and execute the user-initiated inputs. (The ROM data which is used by the processor to execute the user-input is in the form of microinstructions for the processor.)

* Unless keyboard control has been lost, some keys such as STOP always force an 'interrupt' sequence.

THE CALCULATOR PRINCIPLES OF OPERATION (cont'd)

The Calculator Memory (cont'd)

The R/W memory, along with storing the user-data, also contains the calculator bookkeeping information. This information includes machine variables such as the maximum used R/W memory address, the location and description of all installed plug-in ROM's, and special storage registers that may be used by the processor during arithmetic calculations. The memory address locations where the bookkeeping information is stored is dedicated to machine use and cannot be accessed by the user.

The R/W memory is volatile (i.e., its contents are lost when the calculator power is switched OFF) and data stored in the R/W memory must frequently be refreshed. Approximately every 1.6 milli-seconds, a 20 micro-second 'refresh cycle' automatically occurs. During this period, all calculator operations are temporarily stopped and the data in the R/W memory is read and restored in the same memory locations. This is the only situation in which a calculator operation is not under the control of the processor.

Any memory failure would probably result in incorrect instructions to the processor which would be indicated by the loss of keyboard control. It is possible, however, for the contents of specific memory addresses to be altered and the calculator would either 'remember' incorrect data or perform only specific operations incorrectly.

Plug-in ROM's

Plug-in ROM's simply add to the calculator read-only memory and provide microinstructions for the execution of their corresponding key inputs.

THE CALCULATOR PRINCIPLES OF OPERATION (cont'd)

The Memory M and T-Registers

The M(memory control) and T(temporary storage) registers are used by the processor to manipulate and temporarily store data being transferred into, or out of, the memory.

M and T-Register failures would probably result in symptoms similar to memory failures.

The Processor



Each of the previously described assemblies are actually tools that the processor uses to accomplish the user instructions. The processor, sometimes called the central processing unit (CPU), is actually a mini-calculator within the 9800 calculator. The processor contains its own read-only memory, storage registers, arithmetic unit (the ALU), and even a microprocessor. All user-instructions to the calculator are interpreted and executed by the processor.

The processor consists of four electronic assemblies. Two assemblies (A16 and A17) are used for the I/O Register, one of which also contains an 8 MHz machine clock. (The I/O Register was described in an earlier section.) The two remaining assemblies are the Arithmetic Logic Unit (ALU) and microprocessor. The remainder of this presentation describes the operation of these latter two assemblies.

The Arithmetic Logic Unit (A19)

All user and processor arithmetic operations are accomplished by the ALU. Calculations on user-data inputs are accomplished in the ALU by using temporary storage addresses in the R/W memory. Addition or subtraction of processor data is accomplished by the use of temporary storage registers within the processor.

THE CALCULATOR PRINCIPLES OF OPERATION (cont'd)

The Arithmetic Logic Unit (A19) (cont'd)

Failures on the ALU assembly usually are indicated by an inoperative calculator. An ALU failure is seldom indicated by machine errors when performing arithmetic operations on data inputs.

The Microprocessor

This is the very 'brain center' of the calculator. With the exception of the power supplies, no calculator electronic assembly can function correctly if the microprocessor fails. In fact, loss of keyboard control occurs because the microprocessor becomes "confused".

Operation of the microprocessor might best be described by following a highly simplified description of a simple calculator operation.

Pressing any calculator key causes the mini calculator within the 9800 calculator to 'wake up' and execute the following routine. The microprocessor, under control of a microprogram from its own ROM (not to be confused with any of the calculator ROM's), causes the coded key input (from the keyboard assembly) to be loaded into the I/O register. From there, the keycode is loaded into the T-register and, in most instances, the display assembly for displaying. The keycode in the T-register is analyzed and the calculator ROM address (one 16 bit word per address) for that keycode determined and fetched. The data from the selected calculator ROM address is the machine language instruction for the input keycode. This instruction is loaded into the T-Register and then processed by the processor. If the instruction is to be loaded into the R/W memory, the processor issues micro-instructions that will select the next higher, available R/W

THE CALCULATOR PRINCIPLES OF OPERATION (cont'd)

The Microprocessor (cont'd)

memory address (one 16 bit word per address) and loads that address with the machine language keycode instruction. If the input keycode requires that the processor execute a routine, the processor selects the calculator ROM address that contains the required routine, fetches the routine from that address, then executes the routine. If the input keycode requires the execution of a routine from a plug-in ROM, the microprocessor selects the plug-in ROM & Address of the routine. Once this is done the routine is fetched and executed. If the selected routine, for some reason, cannot be performed, the microprocessor initiates another routine which indicates, either by an error message or a status light, that an error was encountered. If the routine requires the use of a peripheral device, the processor outputs the peripheral's select code and checks the peripheral status. If the status is satisfactory, the appropriate ASCII character (and control signals) is output to the peripheral. The microprocessor also controls the timing of the phase changes (e.g., from fetch to execute) so that the microprocessor can perform the complex ROM (either calculator, plug-in, or processor) instructions. The timing for the M and T registers, I/O register, and ALU is also provided by the microprocessor (using the 8 MHz clock as a time base).

As you can see, the microprocessor controls the calculator and a failure on this assembly can create any number of symptoms. Usually, however, a microprocessor failure results in a 'dead' calculator (i.e., loss of keyboard control).

'POWER SUPPLY'
THEORY OF OPERATION

Refer to the +5V Schematic, Figure 6-3, a simplified drawing of the +5V power supply, and Figure 6-4, a representation of the significant power supply wave-forms, during the following presentation.

The +5V power supply utilizes a switching regulator technique to provide maximum output current with minimum heat dissipation by the series pass transistor. Since Q2 only draws current when saturated, power dissipation in Q2 is minimized.

CAUTION

THE +5V POWER SUPPLY MAY BE DAMAGED IF THE
SUPPLY IS OPERATED WITHOUT BEING PROPERLY
HEAT SUNK.

Q2 is switched by a small voltage difference between U1 pin 2 and U1 pin 3 (inputs to the IC operational amplifier). A +5V reference is established on the amplifier non-inverting input (pin 3) by voltage divider R1 and R2. C2 ensures that the +5V reference does not appear on U1 pin 3 before the +5V sense voltage (E out) appears on U1 pin 2. If the +5V reference should appear first, Q5 switches ON and disables the supply. (An example of this is when a 9800-Series Calculator is switched OFF then ON very quickly.) When the supply output is less than the reference voltage, U1 switches Q2 ON. The +19V Q2 collector voltage, divided by R3 and R4, establishes a higher reference voltage (see Figure 6-4). When the supply output increases to the higher reference voltage, U1 switches Q2 OFF and the previous reference decreases to the level originally established by R1 and R2. Q2 is switched ON when the voltage output is again equal to the reference voltage.

THEORY OF OPERATION (cont'd)

Functional Description

The Q2 output is a 20V square wave, which is filtered by L1, C4, and C5. The output of the filter (+5V) is the average of the Q2 collector signal. CR3 provides a continuous path for inductor (L1) current when Q2 is OFF. L2 isolates the capacitance of C4 and C5 from external filter capacitance, couples the ripple voltage to the +5V sense line, and provides additional +5V filtering.

+5V Protection



The +5V supply is short-circuit protected by Q5. Q5 is switched ON if either of two conditions occur:

1. If the +5V reference appears on U1 pin 3 before the sense voltage is +5V.
2. If the sense voltage is more than .6V below the reference voltage (+5V output shorted to ground or a negative supply).

Q5 switching ON clamps the operational amplifier output to the sense voltage (e.g., ground), thus Q2 is switched OFF.

Over-voltage protection is provided by Q4, CR4 and Q5. (An over-voltage condition will occur if either Q2 is shorted or the +5V supply should become shorted to a more positive supply.) When the +5V supply exceeds approximately 5.2V, CR4 begins conducting and switches Q4 ON. Q4, then, clamps the +5V Bus to ground, which switches Q5 ON, thus switching the supply OFF. (Q4 remains conducting until the instrument power is switched OFF.)

THEORY OF OPERATION (cont'd)

+5V Protection

CAUTION

THE +5V POWER SUPPLY IS NOT CURRENT LIMITED.
A FAILURE WHICH RESULTS IN EXCESSIVE +5V CURRENT MAY CAUSE DAMAGE TO THE INSTRUMENT.

Power on Preset (NPOP)

The one-shot (U2) is triggered as the +5V supply output is rising from 0 to +5V. The one-shot Q output switches Q3 ON, thus generating the (low) 'power on preset' (NPOP) pulse.

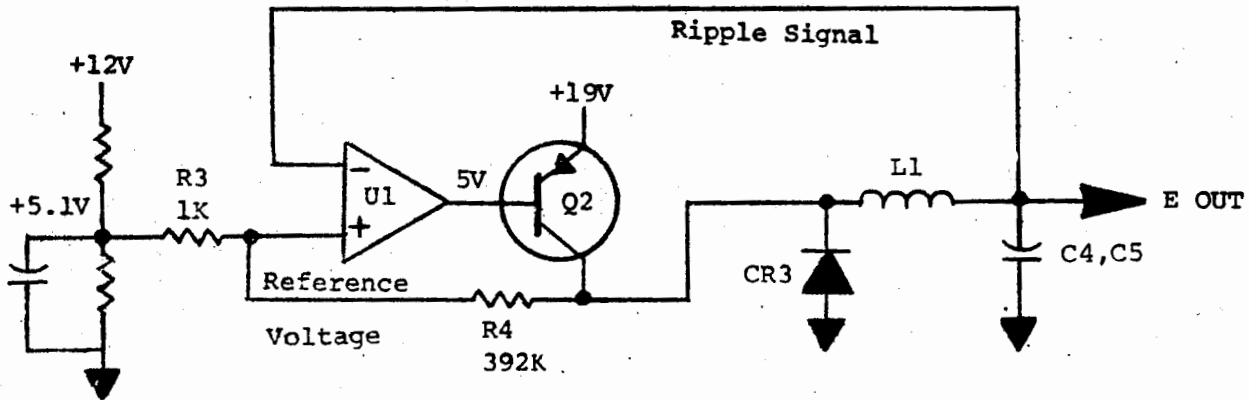
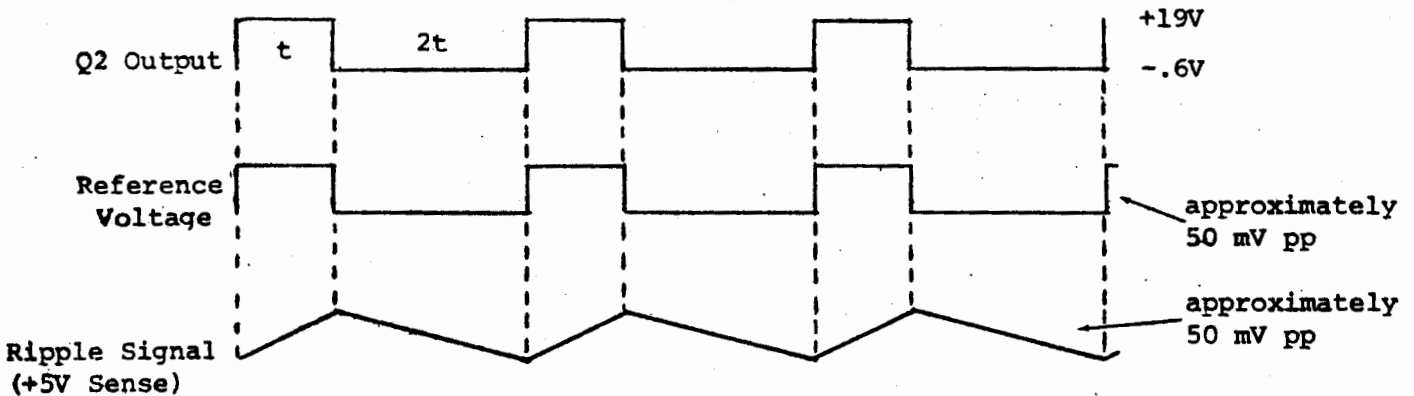

Figure 6-3. +5V Simplified Schematic



NOTE: When the reference voltage and the ripple signal are approximately equal, Q2 switches conduction states.

Figure 6-4. Power Supply Waveforms

THEORY OF OPERATION (cont'd)

+12V Power Supply

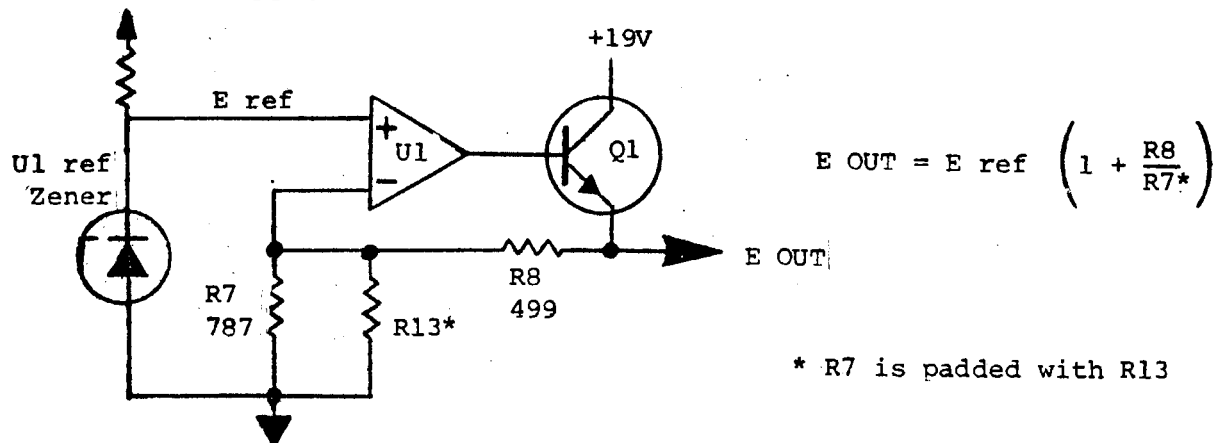

Figure 6-5. +12V Power Supply

Figure 6-5 is a simplified drawing of the +12V power supply and should be referred to during the following presentation.

The U1 internal reference zener diode provides a +7.15V reference for the (U1) operation amplifier. The +12V supply functions as a non-inverting amplifier which amplifies the zener reference voltage. The gain of the amplifier is determined by the ratio of R8 to R7. Since the feedback through R8 and R7 regulates the supply output, varying R7 (by changing R13) varies the supply output.

+12V Protection

R4 (in conjunction with U1) provides current limiting for Q1.

Q4 and CR9 provide 'over-voltage' protection. When the supply output increases to +13V, CR9 begins conducting and switches Q4 ON. Q4, then, clamps the supply output to ground which causes current limiting to occur.

THEORY OF OPERATION (cont'd)

-12V Power Supply

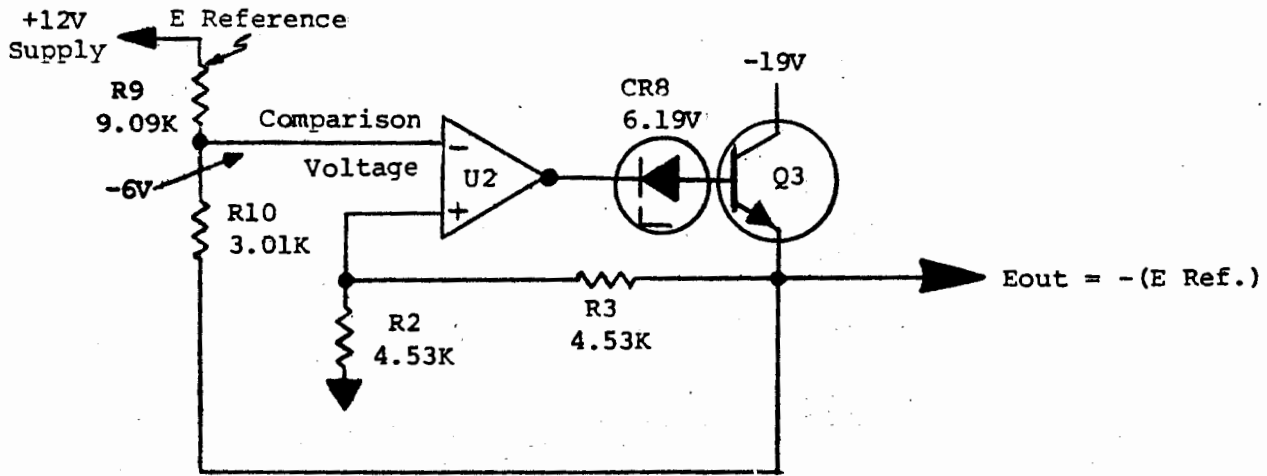

Figure 6-6. -12V Simplified Schematic

Figure 6-6 is a simplified drawing of the -12V power supply, and should be referred to during the following presentation.

The -12V power supply reference voltage is determined by the +12V and -12V outputs through R9 and R10. If the +12V supply increases, U2 senses the +12V increase and increases the Q3 output an equal amount. When the -12V supply is of equal magnitude to the +12V supply, the reference voltage will, again be -6V. In this manner, the -12V supply is forced to precisely 'track' the +12V supply. Thus, changing the value of R13* changes the output of both the +12V and -12V power supplies.

R2 and R3 provide feedback to stabilize the -12V supply and, in conjunction with R9 and R10, determines the supply output. (See the +12V supply presentation.)

CR8 shifts the level of the U2 output by 6.19V to provide proper biasing for Q3.

R6 (with U2) provides current limiting for Q3.

THEORY OF OPERATION (cont'd)

-12V Protection (cont'd)

Q5 and CR10 protects 'downstream' devices, should the -12V supply become more negative than -13V.

◆◆◆◆◆ TROUBLESHOOTING ◆◆◆◆◆

The Calculator Exchange Assemblies

NOTE

The following procedure assumes that the ac power (LINE) switch is in the OFF position before any assembly is exchanged.

The following procedure should assist you in finding the defective calculator assembly.

WARNING

BEFORE SERVICING A CALCULATOR ENSURE THAT POWER IS REMOVED FROM BOTH THE AC POWER INPUT AND THE CONVENIENCE OUTLETS. FAILURE TO OBSERVE THIS WARNING CAN RESULT IN ELECTRICAL SHOCK WHILE THE INSTRUMENT IS BEING SERVICED.

Note

Whenever possible, the appropriate service kit should be used as a 'functional' calculator to verify that a suspected defective PC board is actually the problem.

1. Verify that all of the power supply voltages are within limits. The power supply limits are: +12V, $\pm 0.2V$; -12V, $\pm 0.4V$; +5V; $\pm 0.1V$; +24, $\pm 0.8V$; +16V, $\pm 0.5V$; +19.5V, $\pm 0.6V$.
2. Note the customer's calculator configuration (i.e., memory options, peripherals and ROM's).
3. Exchange the calculator and kit processor assemblies.

TROUBLESHOOTING (cont'd)

The calculator Exchange Assemblies (cont'd)

4. If the calculator operates correctly, return the four calculator assemblies to the calculator, one assembly at a time, until the defective assembly is found. Exchange the kit assembly and the defective calculator assembly and return the remainder of the customer's assemblies to the calculator.

NOTE



If the customer's assemblies appear to be intermittent, check for a bad pc connector, intermittent shorts and loose or broken components. Then, check to see if the intermittent occurs following any particular sequence which might suggest where the problem may be found.

5. If the calculator processor appears to be operating normally or if the kit assembly does not alter or correct the symptoms and the problem appears to be in the display, a ROM, the printer, the magnetic-card reader, or a peripheral, then exchange the defective assembly.
6. While observing the necessary precautions that are required for the memory assemblies (see Chapter 5) exchange the calculator memory module with the kit module. If the symptoms are corrected, return the individual memory assemblies to the calculator until the defective assembly is found. Then, replace the defective calculator assembly with the associated kit assembly and return the remainder of the customer's assemblies to his calculator. The memory assemblies are on the -hp- Blue Stripe Exchange Program.

TROUBLESHOOTING (cont'd)

The Calculator Exchange Assemblies (cont'd)

7. Exchange the calculator and kit keyboard assemblies. If the problem is not corrected, the failure is either a bad connector or a power supply. If all power supply voltages are correct, place all of the customer's assemblies in the kit and verify proper operation. If the kit operates normally, the calculator may have a defective mother board or one of the signal cables is defective. If the kit does not operate normally, one or more of the customer's assemblies is defective. Recheck the symptoms and return to step 1 of this procedure. If necessary, the 09820-69523 or 09810-69522 assemblies may require replacement (pp 4-13)

+5V Power Supply

CAUTION

THE A81 ASSEMBLY MAY BE DAMAGED IF IT IS OPERATED CONTINUOUSLY FOR MORE THAN ONE MINUTE WITHOUT BEING PROPERLY HEAT SUNK.

NOTE

The A81 assembly may be operated for a longer period of time if the thermal plate is connected to the heat sink and the assembly is placed on extender boards. If this procedure is used, the heat sink should be periodically checked to ensure that it is not overheating.

The switching frequency of Q2 should be between 18 KHz (period = 55.6 μ s) and 30 KHz (period = 33.3 μ s) and is controlled by the value of R4. The only recommended values are listed below; if

TROUBLESHOOTING (cont'd)

+5V Power Supply

one of these three resistors does not bring the switching frequency within the specifications indicated above, there is probably a defective component on the A81 assembly.

Table 6-2. A81 R4 Padding List

R4	-hp- Part Number	Effect
475K	0757-0481	increases frequency
392K	0698-4535	nominal
324K	0757-0479	lowers frequency

It may be necessary to remove Q5 to troubleshoot the +5V supply as most failures will cause Q5 to be switched ON. Removing Q5 may, however, cause R6 to open. Therefore, it is recommended that a spare R6 (22 ohm, -hp- Part Number 0684-2201) be available when servicing the calculator (this resistor is not in the calculator service kits).

Common +5V power supply failures are defective regulator IC's (U1) or the case (collector) of Q2 becoming shorted to the heat sink (ground).

+5V Specification

+5V $\pm 2\%$

$\pm 12V$ Supplies

The most common failures on the A83 assembly are the two IC regulators U1 or U2. However, if U1 is changed the reference zener may be slightly different, necessitating a change in the value of R13. (Eout = +12V, $\pm .2$; -12V, $\pm .4V$)

TROUBLESHOOTING (cont'd)

+12V Power Supply (cont'd)

To determine the correct value of R13, perform the following procedure:

1. Switch the calculator OFF and remove the A83 assembly.
2. Remove R13.
3. Connect a 10-turn 100K pot in parallel with R7. (Adjust the pot for maximum resistance.
4. Install the A83 assembly and switch the calculator ON.
5. Slowly decrease the pot to give +12.1V output at TP1.
6. Remove the pot and measure the value of the resistance used in step 5.
7. Use the padding list (Table 6-3) to select the resistor nearest the resistance measured in step 6. Install the selected resistor.
8. Check TP1 and TP2 for +12V±.2V, -12V±.4V, respectively

Table 6-3. A83 R13 Padding List

Value	-hp- Part No.	Value	-hp- Part No.	Value	-hp- Part No.
221K	0757-0473	8.87K	0698-4202	4.32K	0757-0436
56.2K	0757-0459	7.87K	0698-3259	4.12K	0698-3493
32.4K	0698-4492	6.98K	0698-4470	3.83K	0698-3153
22.6K	0757-0349	6.34K	0698-3516	3.65K	0757-0434
17.4K	0698-4482	5.90K	0698-3515	3.40K	0698-4440
14.0K	0698-4479	5.36K	0698-3258	3.24K	0698-4439
11.5K	0698-3268	4.99K	0698-3279	3.09K	0698-4438
10.0K	0757-0442	4.64K	0698-3155		

9810A ASSEMBLY EXCHANGE TREE

CAUTION

STATIC DISCHARGE MAY
DAMAGE MOS MEMORY.

BEFORE EXCHANGING
THE A0, A1, A2, and A3
BOARDS USE THE FOIL
WRAPPING TO ESTABLISH
AN EQUAL POTENTIAL
BETWEEN ALL
BOARDS AND PERSONS
EXCHANGING BOARDS.

NOTE

The Memory Module means the memory assembly (A15) with any of the following memory boards (A0, A1, A2, or A3) installed.

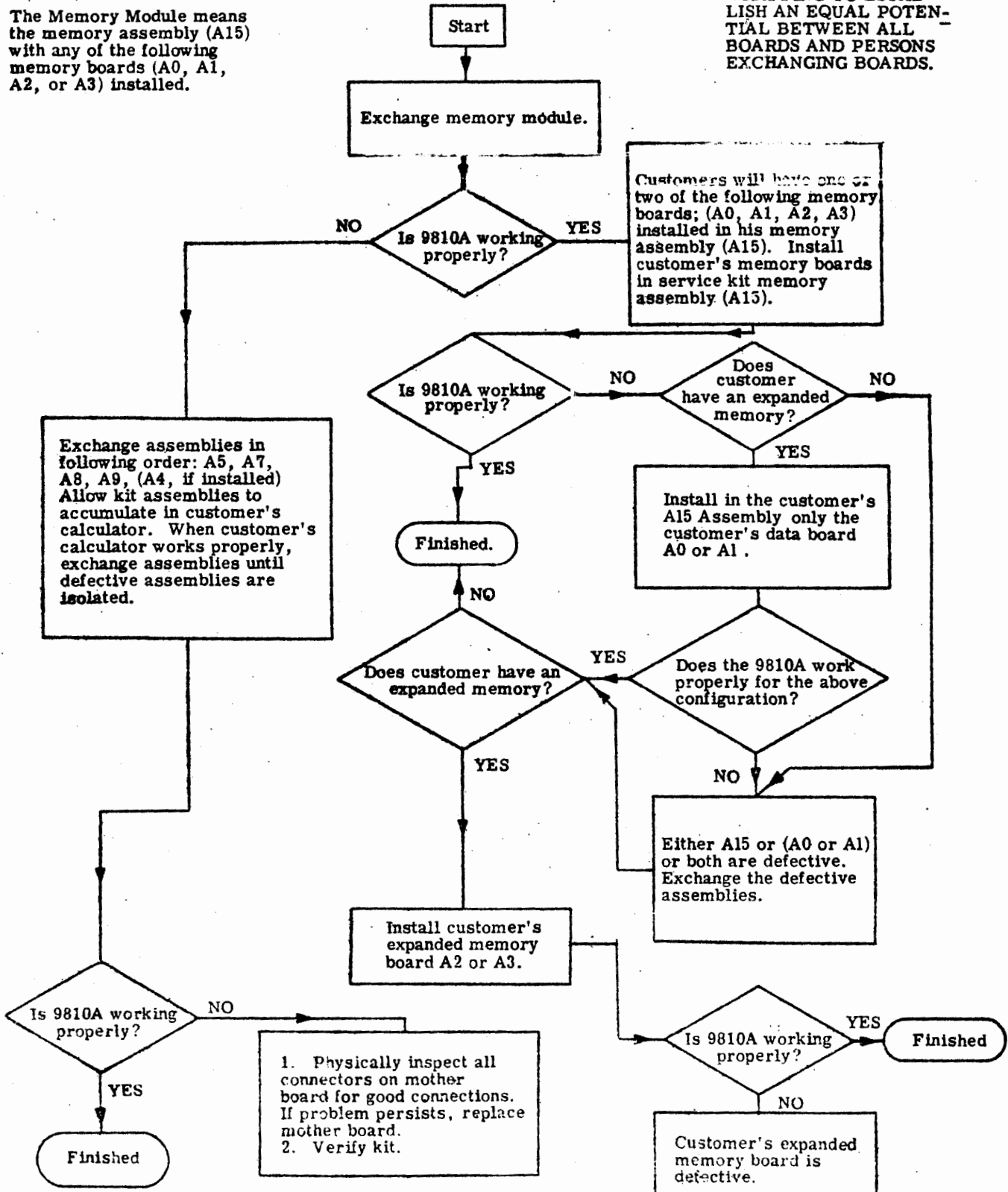

9820A TROUBLESHOOTING TREE

CAUTION
TURN LINE POWER SWITCH TO OFF BEFORE EXCHANGING ASSEMBLIES

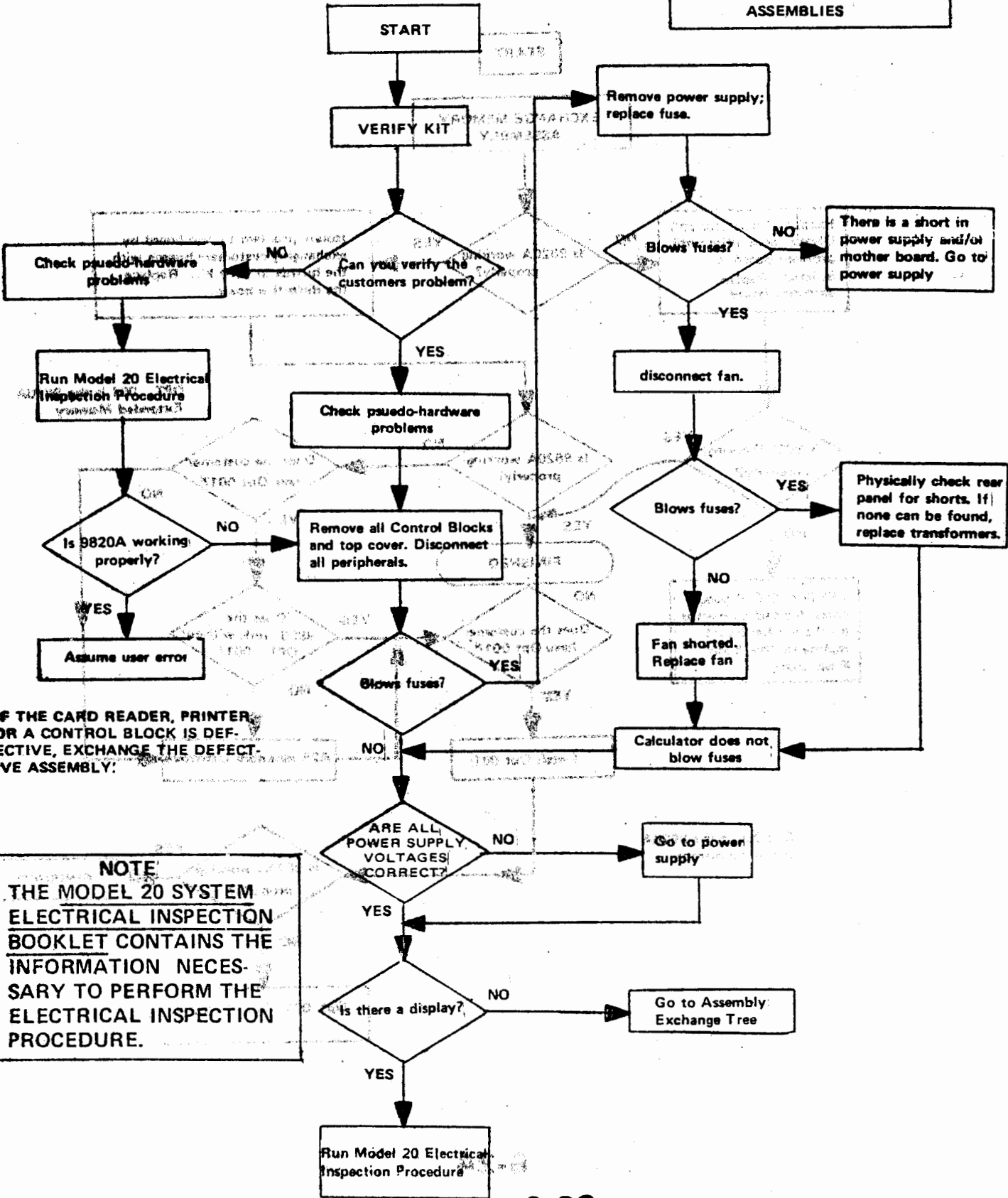

IF THE CARD READER, PRINTER, OR A CONTROL BLOCK IS DEFECTIVE, EXCHANGE THE DEFECTIVE ASSEMBLY.

NOTE
THE MODEL 20 SYSTEM ELECTRICAL INSPECTION BOOKLET CONTAINS THE INFORMATION NECESSARY TO PERFORM THE ELECTRICAL INSPECTION PROCEDURE.

9820A ASSEMBLY EXCHANGE TREE

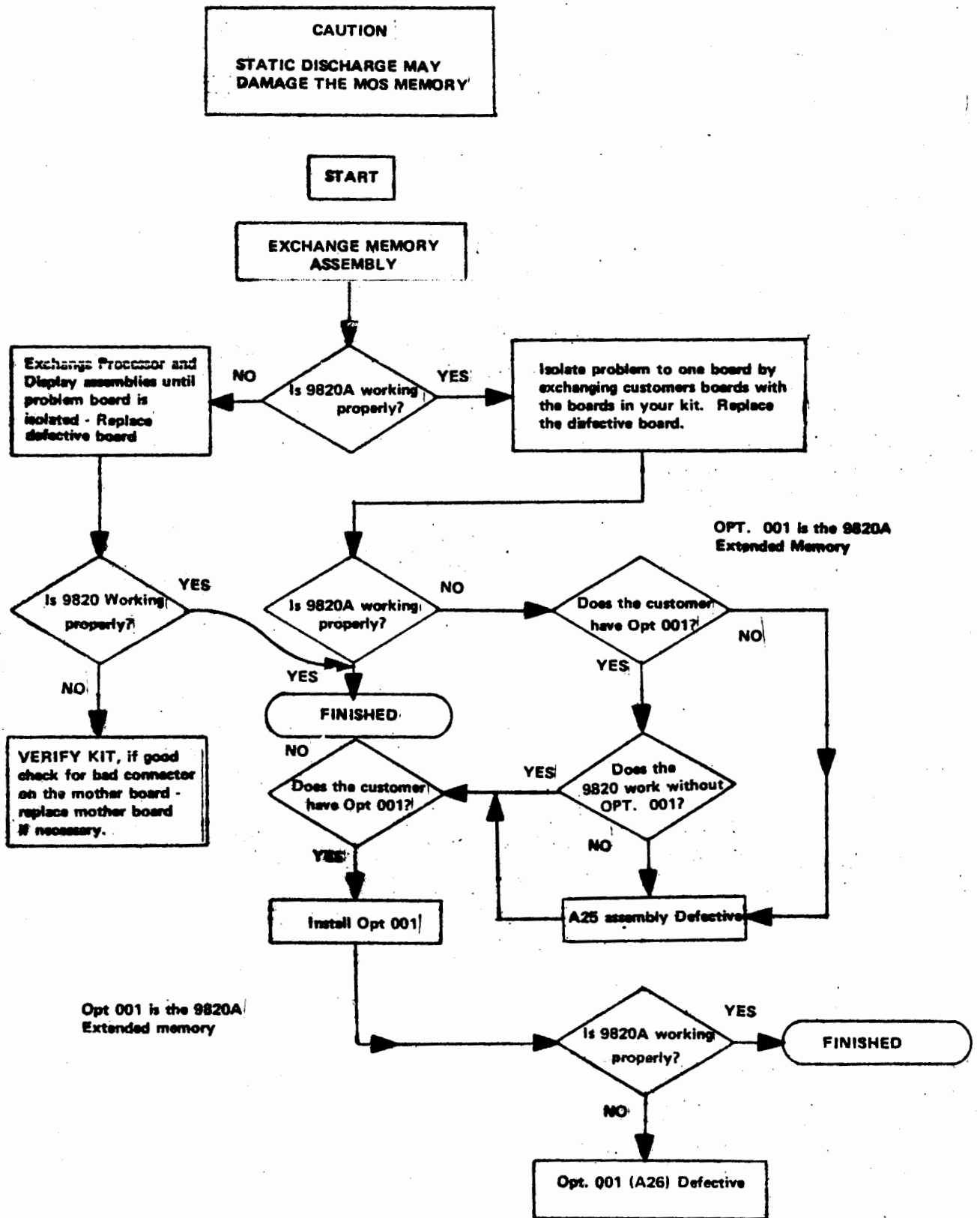

TROUBLESHOOTING (cont'd)

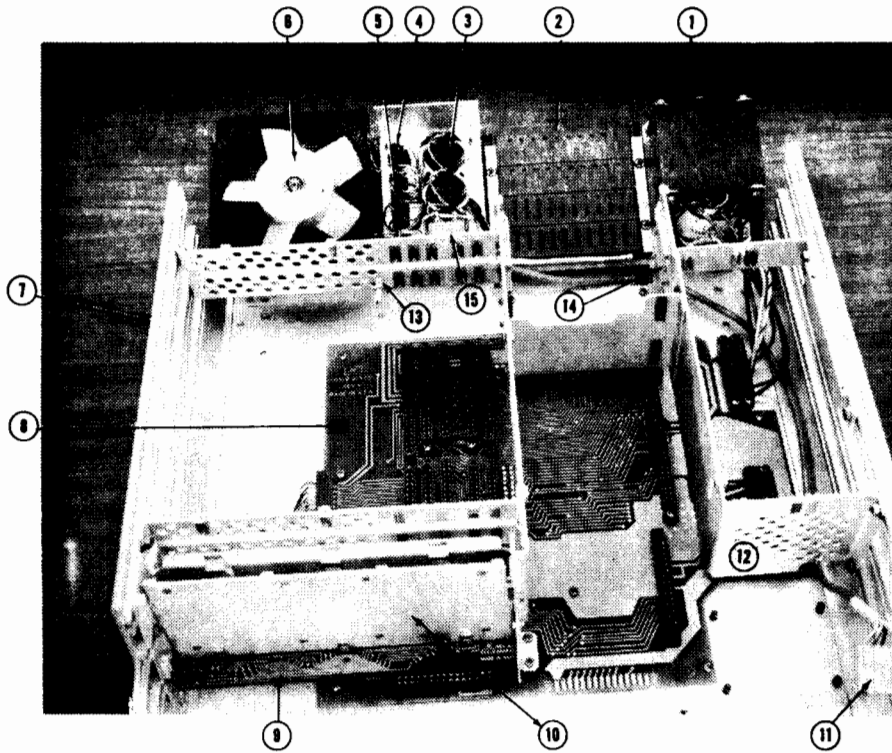

Refer to Table 6-4.

Figure 6-11.
9810A and 9820A Back Panel and Chassis Parts



TROUBLESHOOTING (cont'd)

Table 6-4.

FIG No.	-hp- Part Number	DESCRIPTION
1	9100-3230	Transformer, power
2	5040-5830 1460-1238	Door, I/O Extender Spring, I/O Door
3	1251-2995	Receptacle, power
4	1400-0048	Holder, fuse
5	3101-1609	Switch, slide
6	3160-0262 3150-0223 09101-04601	Fan, tubaxial * Filter, fan Filter, screen
7	09810-64401	Cabinet Ass'y
8	09810-66502	PC Ass'y, Mother
9	09820-61601	PC Ass'y, ROM
10	09820-60401	Housing Ass'y, ROM
12	09820-60102	Chassis Ass'y, Right
11	1251-2987	Connector, Keyboard
13	09820-60104	Chassis Ass'y, Left
14	5040-5908	Guides, I/O
15	9100-3142	Filter, Line

*The plastic frame and the fan filter must be glued together.

◆◆◆◆◆ SERVICING THE 9810A/9820A MAGNETIC-CARD READER ◆◆◆◆◆

Lamp Replacement Procedure

1. Remove the calculator top cover.
2. If the defective lamp is either of the two on the top of the cardreader, remove the lamp assembly by pulling it out with a pair of pliers. If one of the bottom lamps is defective ship to step 8.
3. Loosen brass nut on the front (Lamp) end of the assembly with a 3/16" wrench. (See Figure 6-12.)
4. Remove the brass nut and lamp holder.

SERVICING THE 9810A/9820A MAGNETIC CARD READER (cont'd)

Lamp Replacement Procedure (cont'd)

5. Replace the defective lamp, -hp- Part Number 2140-0092.
6. Screw the lamp holder back into place and replace the 3/16" brass nut.
7. Press the lamp assembly into the assembly holder.
8. If the defective lamp is on the bottom of the cardreader assembly, remove the calculator keyboard by removing the four screws on the bottom of the calculator.
9. Remove the defective lamp assembly by pulling it out with a pair of pliers.
10. Perform steps 3 through 7.
11. Replace the calculator top cover and keyboard.
12. Check to assure that the magnetic cardreader is performing properly by loading a known good program from a magnetic card into the calculator and verify that the program in memory and the program on the card are identical.

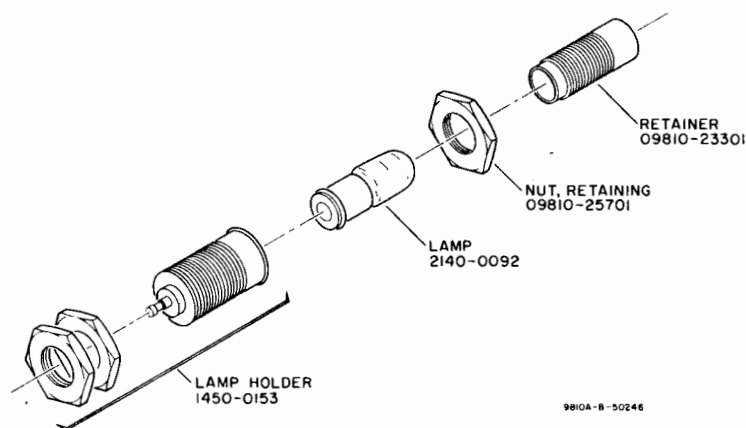

Figure 6-12.

SERVICING THE 9810A/9820A MAGNETIC CARD READER (cont'd)

Modification to Magnetic Card Reader 09810-69560

A ground strap and shoulder bolt have been added to all Magnetic Card Readers (09810-69560) now being manufactured. It should also be added to all calculators in the field as card-reader failure makes it necessary.

The ground strap was added because of the large number of card reader failures where the card would stop when half way through the reader. This was a result of a static charge building up on the pressure wheel shaft. When this charge is discharged to ground it would change the state of the flip-flop controlling the card reader motor. The ground strap allows the shaft to discharge slowly. The ground strap and shoulder bolt is available from Calculator Customer Service, Loveland.

<u>Qty</u>	<u>Description</u>	<u>-hp- Part Number</u>
1	Ground strap	1600-0344
1	Shoulder bolt	2360-0337

Installation Procedure

1. Remove calculator top cover.
2. Remove screws from keyboard and pull forward.
3. Remove four screws from card reader.
4. Lift card reader P.C. assembly from mother board.
5. Remove card reader and P.C. assembly.
6. Remove phillips screw and lock washer from upper right hand corner of the right side of the card reader (opposite side of pulleys).
7. Install ground strap between pressure wheel shaft and screw hole of step 6 with shoulder bolt (See Figure 13).
8. Replace card reader and P.C. assembly.
9. Replace keyboard and top cover.

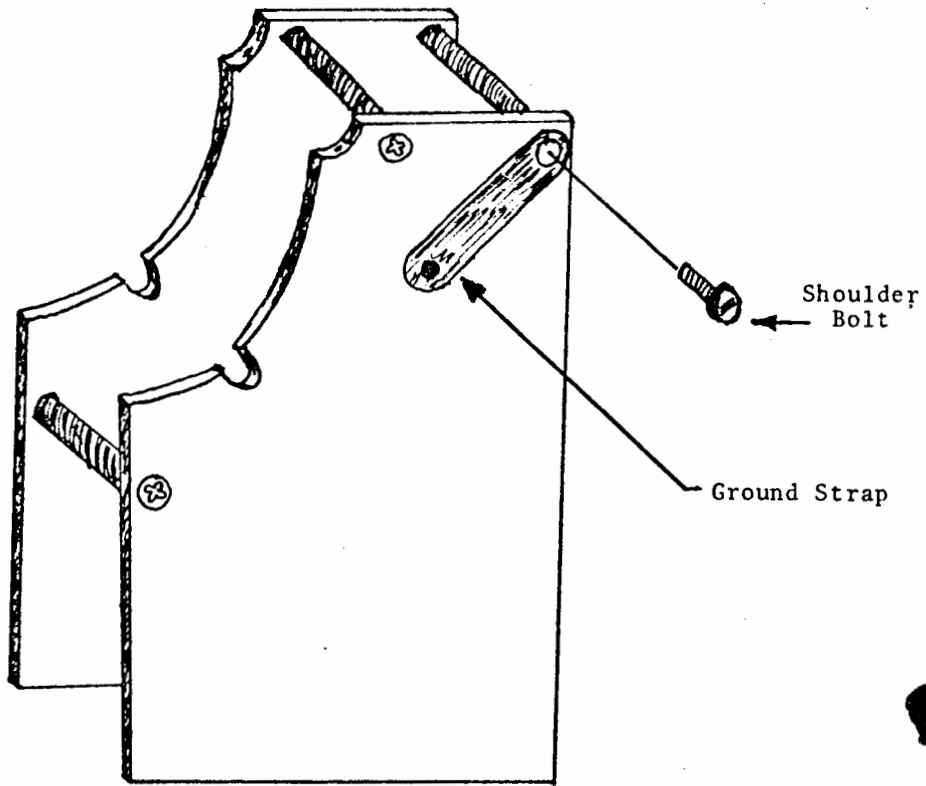

Figure 13.
Ground Strap Installation

9810A/9820A POWER SUPPLY

PARTS LIST

REFERENCE DESIGNATOR	-hp- PART NO.	TQ	DESCRIPTION
A81	00735-64101	1	Insulator-Xstr
C12	0150-0071	1	C-F 400PF 500V
C3	0150-0073	1	C-F 100PF 1000V
C2, 10, 11	0180-1701	3	C-F 6.8UF 6V
C4-9	0180-1714	6	C-F 330UF .1
C1	0180-2405	1	C-F 6400 UF 25V
R8	0684-1001	1	R-F 10 OHM .1
R9	0684-1011	1	R-F 100 OHM .1
R6	0684-2201	1	R-F 22 OHM .1
R5	0684-2211	1	R-F 220 OHM .1
R10	0684-2731	1	R-F 27K .1 1/4W
R12	0684-3311	1	R-F 330 OHM .1
R11	0684-3321	1	R-F 3300 OHM .1
R13	0687-4701	1	R-F 47 OHM .1
R1	0698-4461	1	R-F 698 OHM .01
R3	0757-0280	1	R-F 1000 OHM .01
R2	0757-0416	1	R-F 511 OHM .01
R4*	0757-0479	1	R-F 392K
R7	0811-3069	1	R-F 1 OHM
	09810-26581	1	PC BD +5
	09820-01181	1	Heat Sink-81
	1200-0080	1	Insulator-Diode
	1205-0033	2	Ht Sink-Semicon
	1205-0245	1	Heat Sink
	1400-0493	2	Strap-Cbl
U1	1820-0196	1	IC-U5R7723393
U2	1820-0261	1	IC-74121N
Q1	1853-0052	1	XSTR-2N3740
Q2	1853-0311	1	XSTR-2N3792
Q3,5	1854-0354	2	XSTR-S1 NPN
Q4	1884-0068	1	Thyristor
CR1,2	1901-0200	2	Dio-S1 3A 100V
CR3	1901-0511	1	Dio-S1 1N3889R
CR4	1902-3094	1	Dio-Bkdn 5.11V
	4040-0711	1	Extr-PC BD BRN
	4040-0616	1	Extr-PC BD GRA
L1	9100-3231	1	Choke 180UH
L2	9100-3232	1	Choke 40UH
L3-L6	9170-0894	4	Core-Mag
R4*	0698-3260		R-F 464K .01 1/8
R4*	0757-0477		R-F 332K .01 1/8
R4*	0757-0483		R-F 562K .01 1.8
A82	C4	0150-0035	1 C-F 20PF 600V
	C7	0150-0071	1 C-F 400PF 500V
	C3	0180-0049	1 C-F 20UF 50V
	C2,6	0180-0291	2 C-F 1UF 35V
	C5	0180-1794	1 C-F 22UF 35V
	C8	0180-1985	1 C-F 500UF 30V
	C1	0180-2406	1 C-F 5000 UF 40V
		0340-0162	1 Insulator-XSTR

NOTE

COMPONENTS WHICH ARE DIFFERENT FOR THE 11225-69581 (A81) ASSEMBLY ARE LISTED ON PAGE 6-32

REFERENCE DESIGNATOR	hp PART NO.	TO	DESCRIPTION	
A82	R11, 12	0684-1011	2 R-F 100 Ohm .1	
	R5	0684-1811	1 R-F 180 Ohm .1	
	R13	0687-6811	1 R-F 680 Ohm .1	
	R3	0698-3478	1 R-F 806 Ohm .01	
	R7	0698-4125	1 R-F 953 Ohm .01	
	R9	0698-4461	1 R-F 698 Ohm .01	
	R8	0698-4464	1 R-F 887 Ohm .01	
	R1	0698-4866	1 R-F 536 Ohm .01	
	R14	0698-8062	1 R-F 4.7 Ohm .1	
	R6	0757-0419	1 R-F 681 Ohm .01	
	R4	0757-0873	1 R-F 1.62K .01	
	R10	0811-2868	1 R-F .82 Ohm 1W	
	R2	0811-3079	1 R-F 51 Ohm 1W	
		09810-26582	1 PC BD +16V +24V	
		09820-01182	1 Heat Sink-82	
		1205-0021	1 Dissipator Heat	
		1400-0493	1 Strap-Cbl	
	U1,2	1820-0196	2 IC-U5R7723393	
	Q1	1854-0063	1 XSTR-2N3055	
	Q2	1854-0072	1 XSTR-2N3054	
	Q3	1884-0068	1 Thyristor	
	Q4	1884-0082	1 Thyristor	
	CR3,10	1901-0044	2 Dio S1	
	DR5,7,8	1901-0045	3 Dio-S1 .75A 100V	
	CR1,2	1901-0200	2 Dio-S1 3A 100V	
	CR9	1902-0243	1 Dio-Bkdn 30.1V	
	CR6	1902-3054	1 Diode-Breakdown	
	CR4	1902-3226	1 Dio-Bkdn 18.2V	
		4040-0712	1 Extr-PC Bd Red	
		4040-0716	1 Extr-PC BD Gra	
	A83	C4	0150-0071	1 C-F 400PF 500V
		C5	0150-0073	1 C-F 100PF 1000V
		C3	0180-0291	1 C-F 1UF 35V
		C6,7	0180-0387	2 C-F 47UF 20V
C8		0180-1779	1 C-F 18UF 35V	
C1,2		0180-2407	2 C-F 1000 UF 25V	
R11,12		0684-1011	2 R-F 100 Ohm .1	
R5		0684-3911	1 R-F 390 Ohm .1	
R7		0698-4014	1 R-F 787 Ohm .01	
R8		0698-4123	1 R-F 499 Ohm .01	
R2,3		0698-4443	2 R-F 4530 Ohm .01	
R13*		0698-999P	1 R-F Pad Value (see text)	
R10		0757-0273	1 R-F 3010 Ohm .01	
R9		0757-0288	1 R-F 9090 Ohm .01	
R1		0757-0409	1 R-F 274 Ohm .01	
R4,6		0811-3069	2 R-F 1 Ohm	
		09810-26583	1 PC BD +-12V	
		1205-0021	2 Dissipator Heat	
		1400-0493	1 Strap-Cbl	
U1,2		1820-0196	2 IC-U5R7723393	
Q2		1853-0010	1 XSTR-SI PNP	

	REFERENCE DESIGNATOR	-hp- PART NO.	TO	DESCRIPTION		
A83	Q3	1853-0063	1	Xstr;		
	Q1	1854-0063	1	Xstr; 2N3055		
	Q4,5	1884-0068	2	Thyristor		
	CR1-7	1901-0045	7	Dio; Si; .75A, 100V		
	CR8	1902-0049	1	Diò; Bkdn, 6.19V		
	CR9,10	1902-3191	2	Dio; Bkdn.		
		4040-0713		Extr - PC BD ORN		
		4040-0716		Extr - PC BD GRA		
11225A +5V Power Supply Parts Changes						
	C13	0180-0408		C-F 6400 uF		
	CR1	1901-0526		Dio		
	L1	9100-3297		Choke 132 uH		
	Q2	1853-0310		XSTR 2N4398		

KEY PART NUMBERS

PAPER
5040-6256

RECORD
2033

LOAD
2032

LIST
2036

KEY LOG
2013

PRGM
2012

RUN
2011

FIX ()
2009

FLOAT
2010

- A 1901
- B 1902
- C 1903
- D 1904
- E 1905
- F 1906
- G 1907
- H 1908
- I 1909
- J 1910
- K 1911
- L 1912
- M 1913
- N 1914
- O 1915
- π 1970
- $\frac{1}{x}$ 1982
- x^2 1983
- $\int x$ 1949
- CHG SIGN 1950
- ENTER EXP 1951
- CLEAR X 1952
- $\frac{1}{x}$ 1982
- int x 1981
- \uparrow ROLL 1984
- \sqrt{x} 1949
- 7 1930
- 8 1931
- 9 1932
- 4 1927
- 5 1928
- 6 1929
- X 1947
- 1 1924
- 2 1925
- 3 1926
- 1946
- 0 2037
- .
- 1971
- $y \rightarrow ()$ 1974
- $x \rightarrow ()$ 1973
- IN-DIRECT 1980
- $y \leftarrow ()$ 1977
- $x \leftarrow ()$ 1975
- \downarrow 1979
- $x \rightarrow y$ 1976
- \uparrow 1978
- 1968
- END 1968
- IF FLAG 1963
- IF $x < y$ 1964
- IF $x = y$ 1965
- IF $x > y$ 1966
- GO TO 1967
- 1958
- SET FLAG 1958
- LABEL 1959
- FMT 1960
- PRINT SPACE 1961
- SUB RETURN 1962
- 1969
- PAUSE 1969
- STOP 1967
- BACK STEP 1969
- STEP PRGM 1968
- 1995
- CLEAR 1995
- 2040
- CONTINUE 2040

All part numbers shown should be prefixed with 0370-. (For example, 0370-1997 is the complete part number for the 9810A STOP key.)

REFERENCE DESIGNATOR	hp- PART NO.	TQ	DESCRIPTION
	11209-84401	1	Service Kit
A0	09810-69521	1	51 Register Board
A1	11216-69521	1	111 Register Board
A2	11217-69526	1	1012 Register Board
A3	11218-69526	1	2036 Register Board
A4	11219-69550	1	Printer Assembly
A16	09810-69511	1	I/O Register
A17	09810-69512	1	I/O Clock
A18	09810-69513	1	Micro Processor
A19	09810-69514	1	Arithmetic Logic Unit
A7	09810-69560	1	Reader - Magnetic Card
A8	09810-69530	1	Keyboard Assembly
A9	09810-69541	1	Display Assembly
A10	11210-69521	1	Mathematics ROM
A11	11211-69521	1	Printer Alpha ROM
A13	11213-69521	1	Definable Functions ROM
A14	11214-69521	1	Statistical ROM
A15		1	Memory Assembly
A31	09810-69522	1	Control Ass'y
A32	09810-69523	1	M Register
A33	09810-69524	1	T Register
A34	09810-69525		RWM (Basic)
A81	09810-69581	1	+5V Power Supply
A82	09810-69582	1	Misc. Power Supplies
A83	09810-69583	1	±12V Power Supplies
	09810-66501	1	I/O Extender Assembly
	09810-67900	1	Chassis Assembly
	5040-5849	1	Window - Printer, Clear
A1	11216-69521	1	111 Register Board
	7120-2784	1	Option Plate
A2	11217-69526	1	1012 Total Program Step Board
	7120-277	1	Option Plate
A3	11218-69526	1	2036 Total Program Step Board
	7120-2778	1	Option Plate
A4	11219-69550	1	Printer Assembly
		3	Thermal Paper
	7120-2801	1	Option Plate
	5040-5849	1	Printer Window

REFERENCE DESIGNATOR	-hp- PART NO.	TQ	DESCRIPTION
778 4133	11210-69521	1	Math ROM
	09810-90024	1	Alpha/Math Exerciser
	09810-90002	2	Math ROM Operating Manual
	7120-2774	1	Keyboard Plate
	11211-69521	1	Printer Alpha ROM
	09810-90024	1	Alpha/Math Exerciser
	09810-90003	2	Printer Alpha ROM Operat- ing Manual
	11213-69521	1	Definable Function ROM
	09810-90004	2	Definable Function ROM Operating Manual
	7120-2775	1	Keyboard Plate
	11214-69521	1	Stat ROM
	09810-90026	1	Stat Exerciser Program
	09810-90005	2	Stat ROM Operating Manual
	7120-2776	1	Keyboard Plate
	09820-01183	1	Isothermal Plate, Power Supply
	09820-27901	1	Stud, Side Panel
	09820-27902	2	Stud, Side Panel
	09820-04121	1	Plate, Memory Cover
	09810-60421	1	Chassis, Memory
	09810-66501	1	Extender, I/O
	1500-0298	2	Belt, Printer Drive
	1500-0302	1	Belt, Paper Load
	5040-5845	1	Window, Display
	5040-5849	1	Window, Printer
	5040-5864	1	Panel, Keyboard
	5040-5865	1	Catch, Keyboard Overlay
	5040-5869	1	Panel, Front
	7120-2735	1	Name Plate (9810A)
	5040-5850	1	Key Shaft, Paper Advance
	1460-0205	1	Spring (comp ression), Paper Advance
	1460-1270	1	Spring, All other keys
	3101-1589	1	Line Power Switch
	1251-2987	1	Connector, Line Power Switch
09820-64101	1	Top Cover	
09810-60001	1	Chassis Assy	
09810-95009	1	Reply Card	
09820-04109	1	Plate-Printer Option	



REFERENCE DESIGNATOR	-hp- PART NO.	TQ	DESCRIPTION
	09820-64101	1	Cover Assy-Top
	2110-0001	1	Fuse-lamp NB
	4114-0476	1	Instr. Overlay
	5040-5849	1	Window-Printer, Clear
	5040-5907	1	Window-Dk Printer
	5060-5992	1	Opt 015 Handle Assy
	7120-2777	1	Opt 002 Plate-Option
	7120-2778	1	Opt 003 Plate-Option
	7120-2784	1	Opt 001 Plate-Option
	7120-2801	1	Opt 004 Plate-Option
	7120-2802	1	Plate-Feature
	7120-2803	1	Plate-Std Prog.
	7120-2804	1	Plate-Std Stor.
	7120-2854	1	Serial Plate-USA
	7120-3529	1	Opt 100 Plate-Opt.
	7120-3538	1	Opt 100 Plate-Serial
	8120-1378	1	CBL-AC Power
	9211-1658	1	Carton
	9220-1783	1	Post Pak
	9220-1784	1	Post Pak
	9220-1902	1	Liner
	9281-0400	1	Paper-Thermal
	9100-3230	1	Transformer, Power
	5040-5830	1	Door, I/O
	1460-1238	1	Spring, I/O Door
	1251-2995	1	Recpticle, pwr
	1400-0048	1	Holder, Fuse
	3101-1609	1	Switch, Selector
	3160-0218	1	Fan
	3150-0223	1	Fan Filter
	09101-04601	1	Screen, Filter
	09810-64401	1	Cabinet Ass'y
	09810-66502	1	Mother Board
	1251-2987	1	Connector, Keyboard
	5040-5908	1	Guides, I/O
	9100-3142	1	Line Filter
	0403-0812		Chassis Feet
	2140-0246		Power ON Lamp
	3150-0223		Filter, Foam
	5040-5833		Filter Frame
	09101-04601		Fan Screen,, mesh

REFERENCE DESIGNATOR	-hp- PART NO.	TQ	DESCRIPTION
	11229-84401	1	11229B Material Kit
	11227-84401	1	11227B Material Kit (9810A Update Kit)
A4	11219-69550	1	Printer Assembly
A5		1	Processor Assembly
A16	09810-69511	1	I/O Register
A17	09810-69512	1	I/O Clock
A18	09810-69513	1	Micro Processor
A19	09810-69514	1	Arithmetic Logic Unit
A7	09810-69560	1	Reader - Magnetic Card Assembly
A20	11220-69521	1	Peripheral Control Block Assembly
A21	11221-69521	1	Mathematics Control Block Assembly
A23	11222-69521	1	Definable Functions Block Assembly
A25		1	Memory Assembly
A35	09820-69521	1	ROM Ass'y No. 1
A36	09820-69522	1	ROM Ass'y No. 2
A37	09820-69523	1	Control Ass'y
A38	09820-69524	1	M Register
A39	09820-69525	1	T Register
A26	09820-69526	1	RWM (Basic)
A28	09820-69530	1	Keyboard Assembly
A29	09820-69541	1	Display Assembly
	09820-66501	1	I/O Extender Assembly
	09820-66526	2	Read Write Memory Assembly
	09810-67900	1	Chassis Assembly
	5040-5849	1	Window-Printer, Clear
	9281-0400	1	Printer Paper- Thermal
A81	09810-69581	1	+5V Power Supply
A82	09810-69582	1	Misc. Power Supplies
A83	09810-69583	1	±12V Power Supplies
	09820-64101	1	Top Cover
	09829-01183	1	Isothermal Plate, Power Supply
	09820-27901	1	Stud, Side Panel
	09820-27902	2	Stud, Side Panel
	09820-04121	1	Plate, Memory Cover
	09820-60421	1	Chassis, Memory
	09820-66501	1	Extender, I/O Ass'y
	1500-0298	2	Belt, Printer Drive
	1500-0302	1	Belt, Paper Feed

REFERENCE DESIGNATOR	hp PART NO.	TQ	DESCRIPTION
	5040-5834	1	Window, Display (9820)
	5040-5849	1	Window, Printer
	5040-5863	1	Panel, Keyboard
	5040-5865	1	Catch, Keyboard Overlay
	5040-5869	1	Panel, Front
	7120-2136	1	Name Plate (9820A)
	5040-5850	1	Key Shaft, Paper Advance
	1460-0205	1	Spring (compression), Paper Advance Key
	1460-1270		Spring (compression) All Other Keys
	3101-1589	1	Line Power Switch
	1251-2987	1	Connector, Line Power Switch
	09820-90030	1	Bklt-Elec. Insp.
	2110-0001	1	Fuse-lamp NB
	4114-0476	1	Instr. Overlay
	5040-5849	1	Window-Printer, Clear
	5060-5992	1	Handle Ass'y.
	7120-2805	1	Plate-Feature
	7120-2806	1	Plate-Std
	7120-2807	1	Plate-Option
	7120-2811	1	Plate-Serial
	7120-2840	3	Plate-Keyboard
	7120-3529	1	Plate-Option
	7120-3537	1	Plate-Serial
	8120-1378	1	CBL-AC Power
	9211-1658	1	Carton
	9220-1783	2	Post Pak
	9220-1784	2	Post Pak
	9220-1902	1	Liner
	9281-0400	1	Paper-Thermal
	0403-0812		Chassis Feet
	2140-0246		Power ON Lamp
	3150-0223		Filter, Foam
	5040-5833		Filter Frame
	09101-04601		Fan Screen, mesh

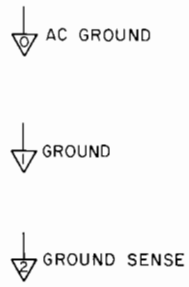
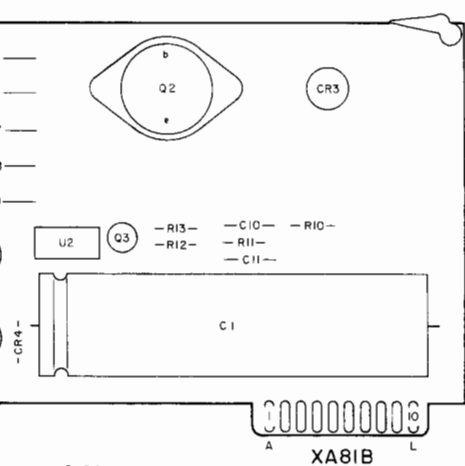
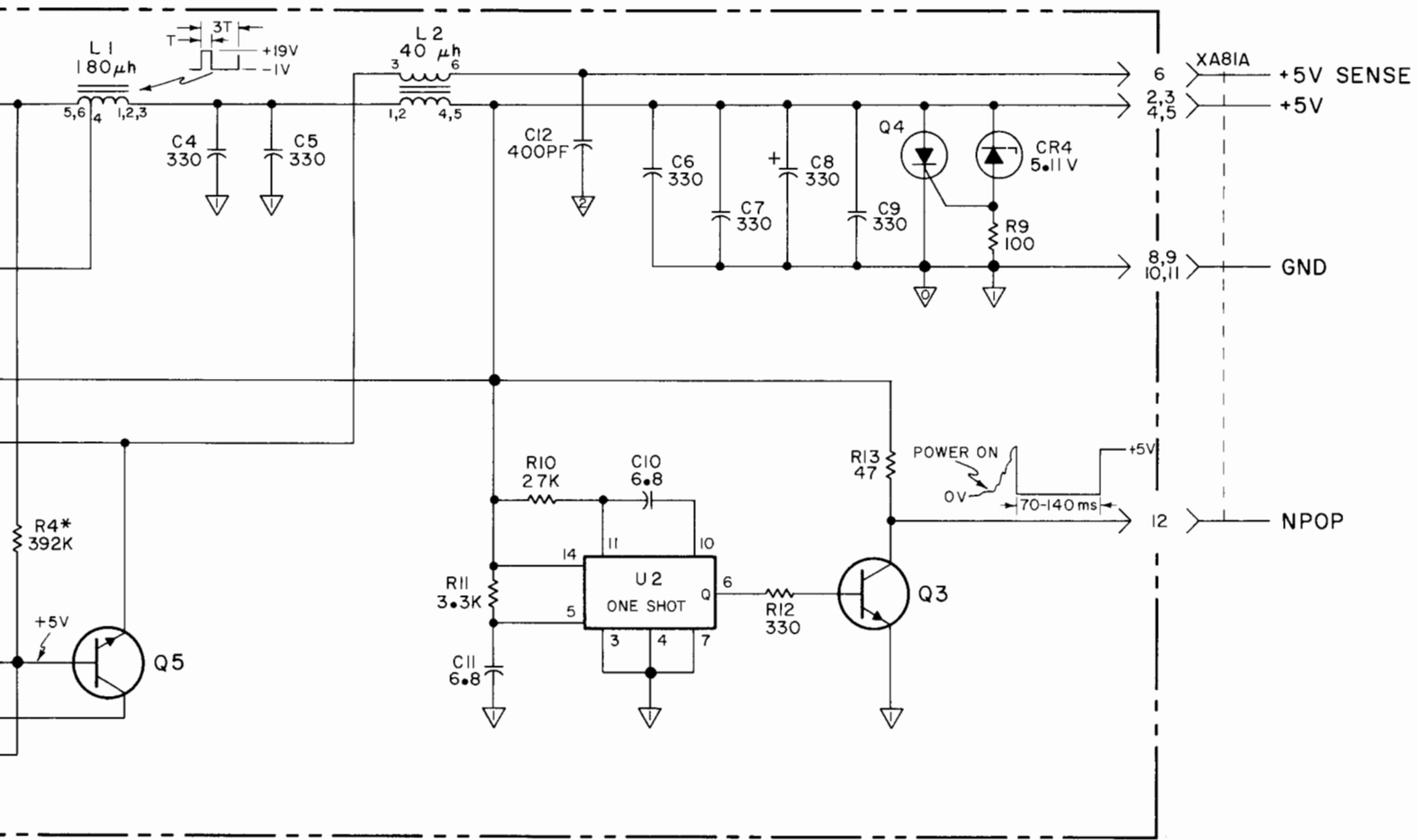

A81
Part No. 09810-66581
REV A

9810A AND 9820A
+5V POWER SUPPLY ASSEMBLY A81

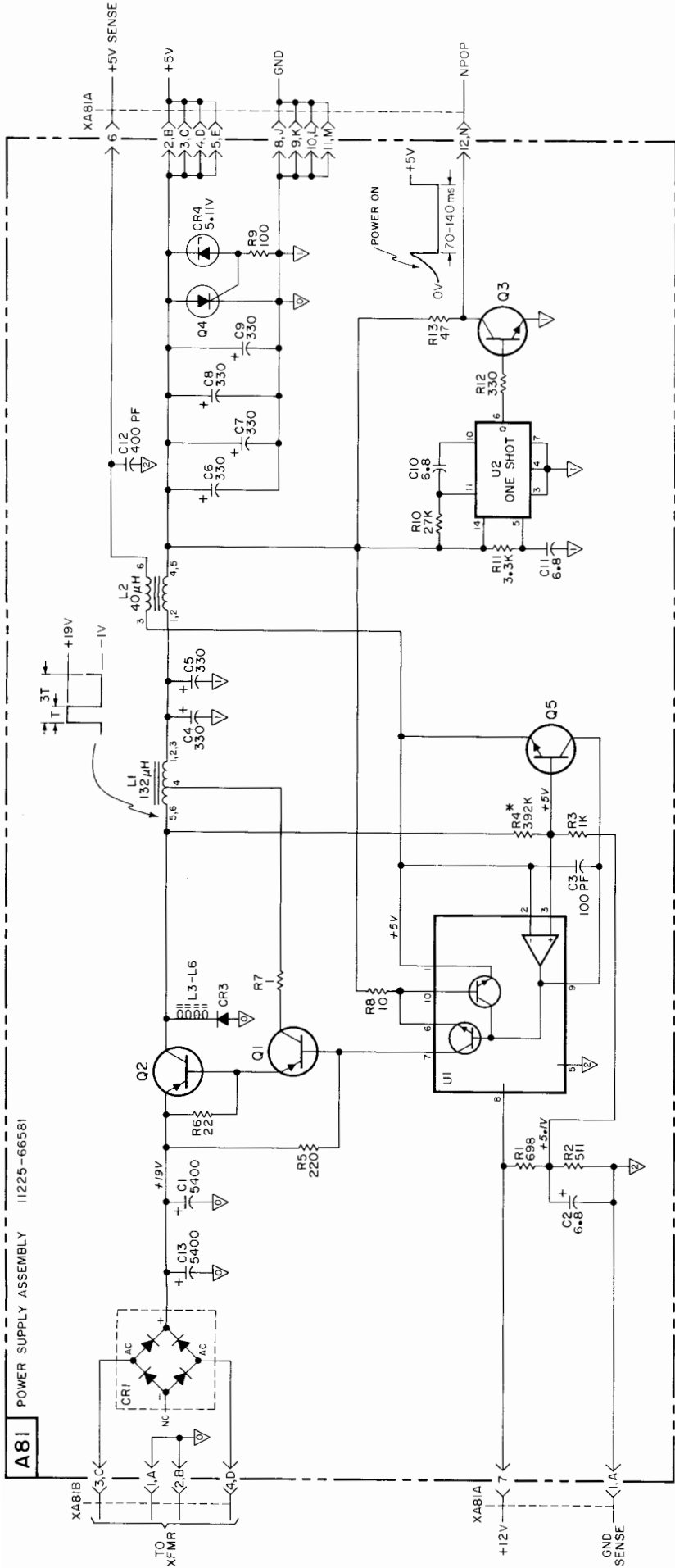

98204-0-50438

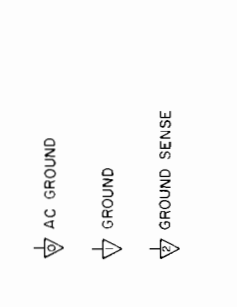

U1
TOP VIEW
1820-0196



A81 POWER SUPPLY ASSEMBLY 11225-66581

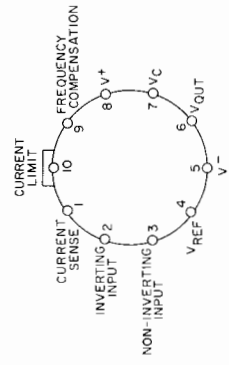
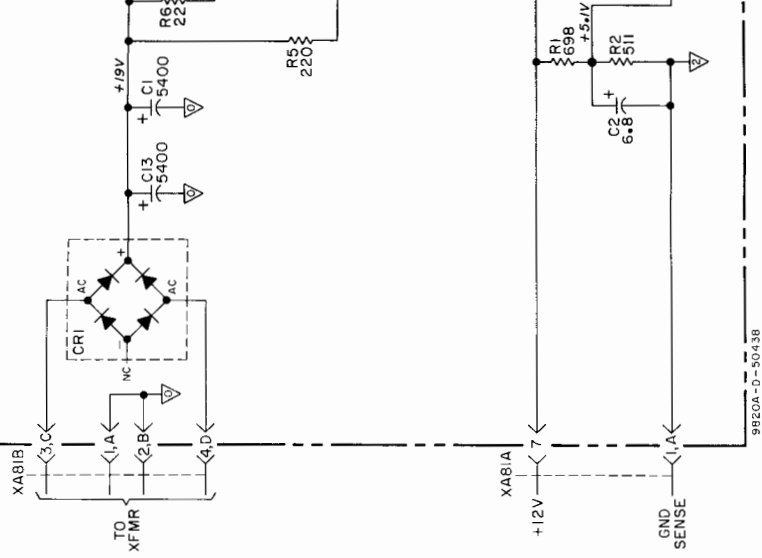

U1
TOP VIEW
1820-0196

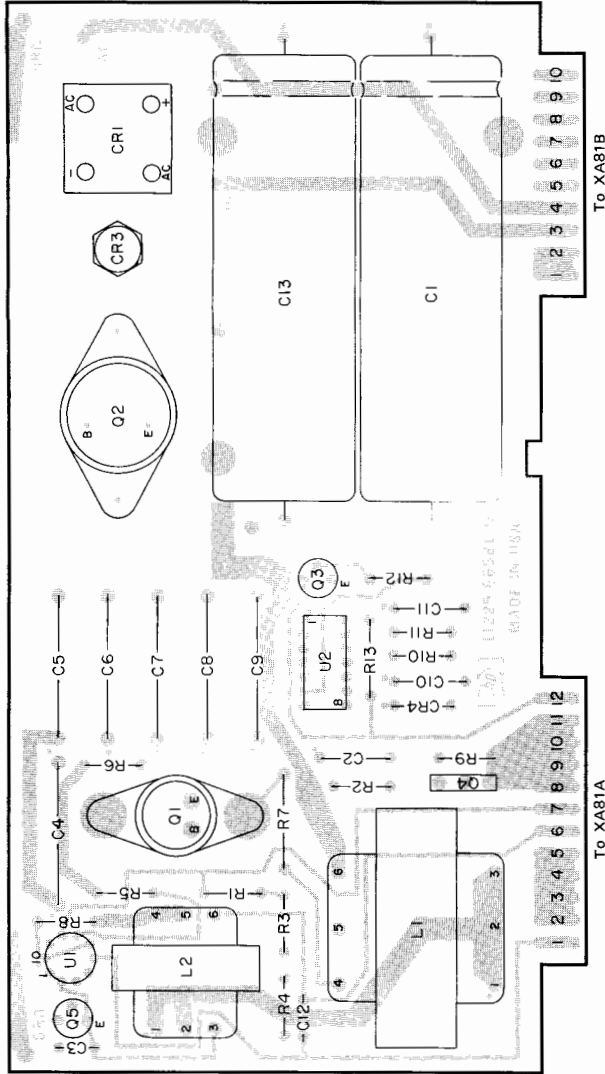

COMPONENT SIDE

A81
hp Part No. 11225-66581

9820A-A-50439

9820A-D-50438

A82 POWER SUPPLY ASSEMBLY (09810-66582)

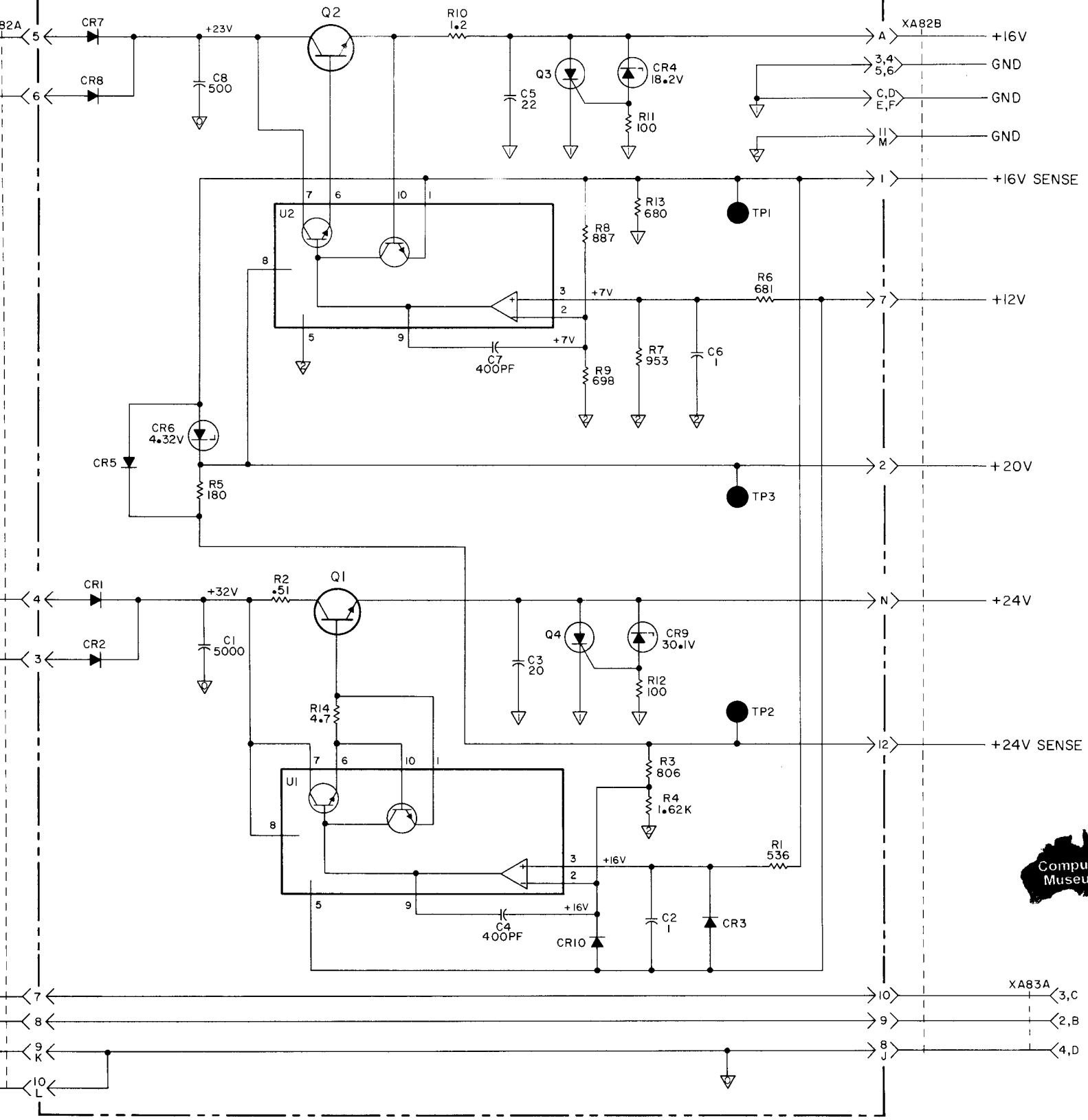

+16V and +24V POWER SUPPLY ASSEMBLY A82

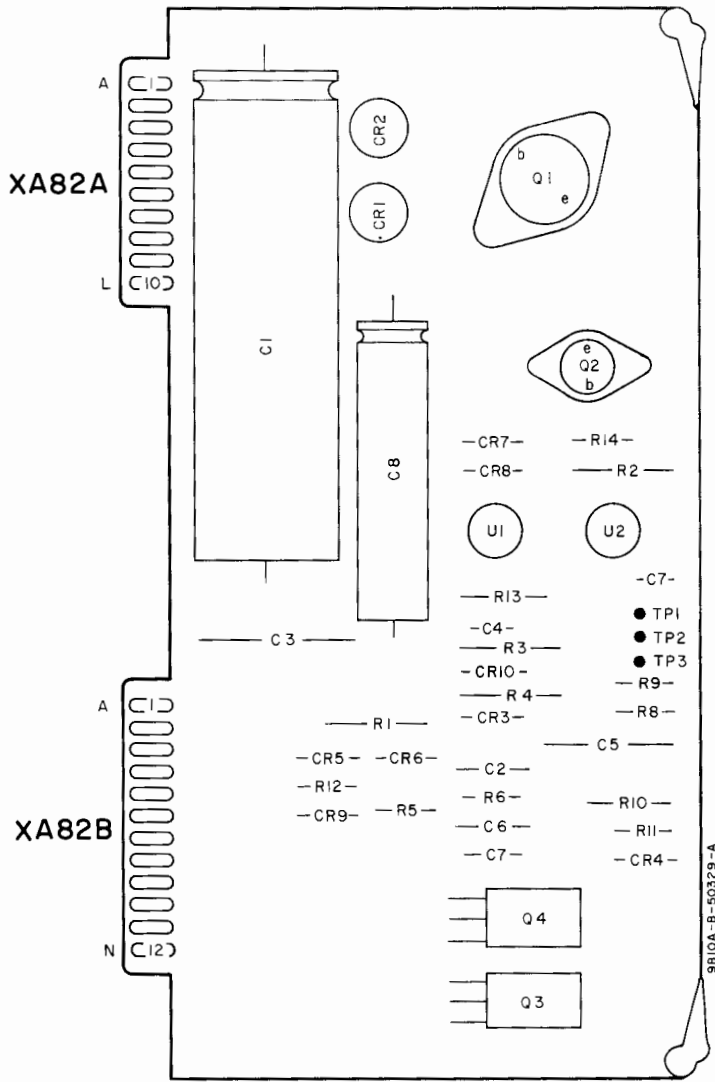

A82
hp Part No 09810-66582
 REV A

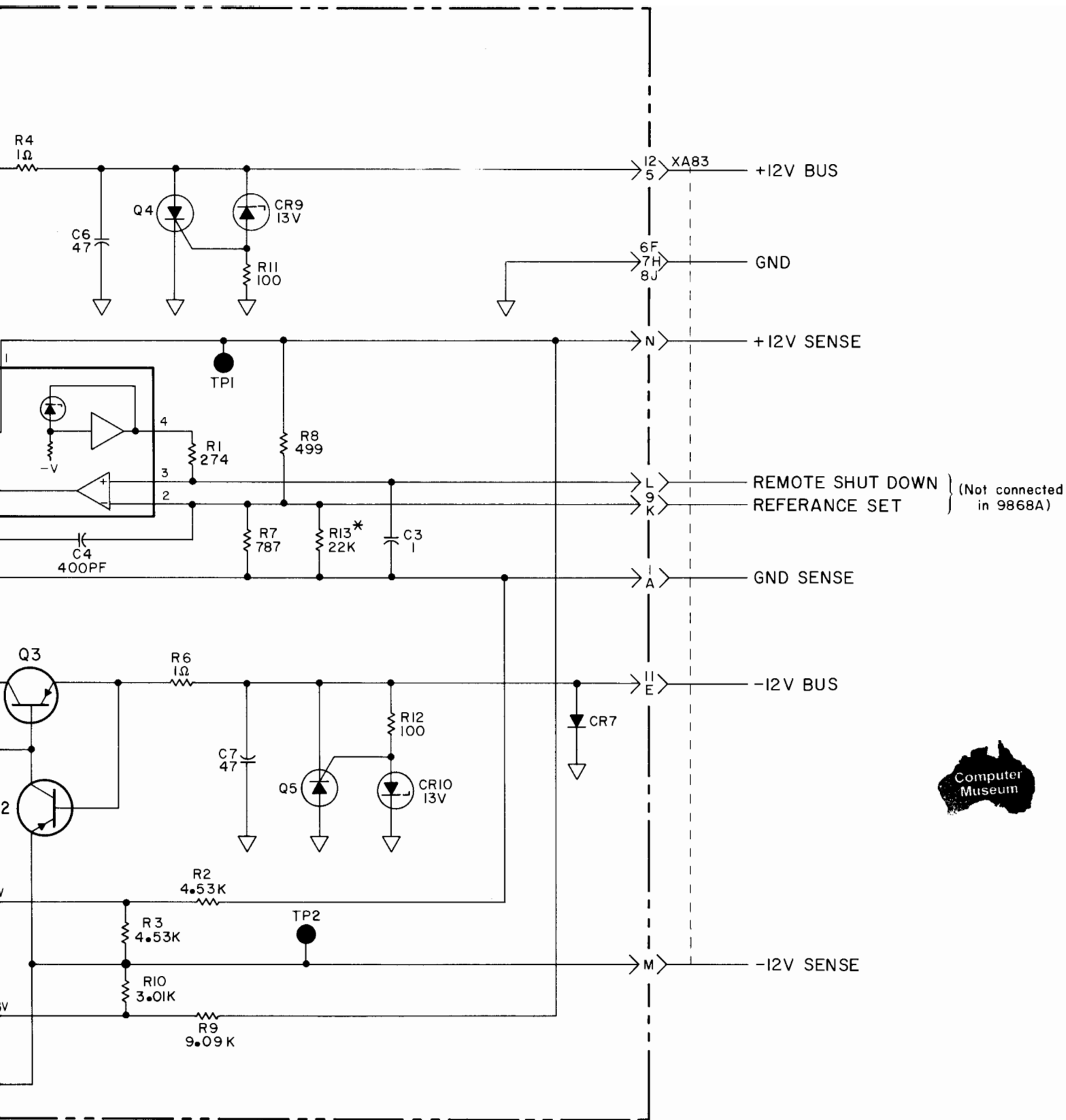

A83 POWER SUPPLY ASSEMBLY (09810-66583)

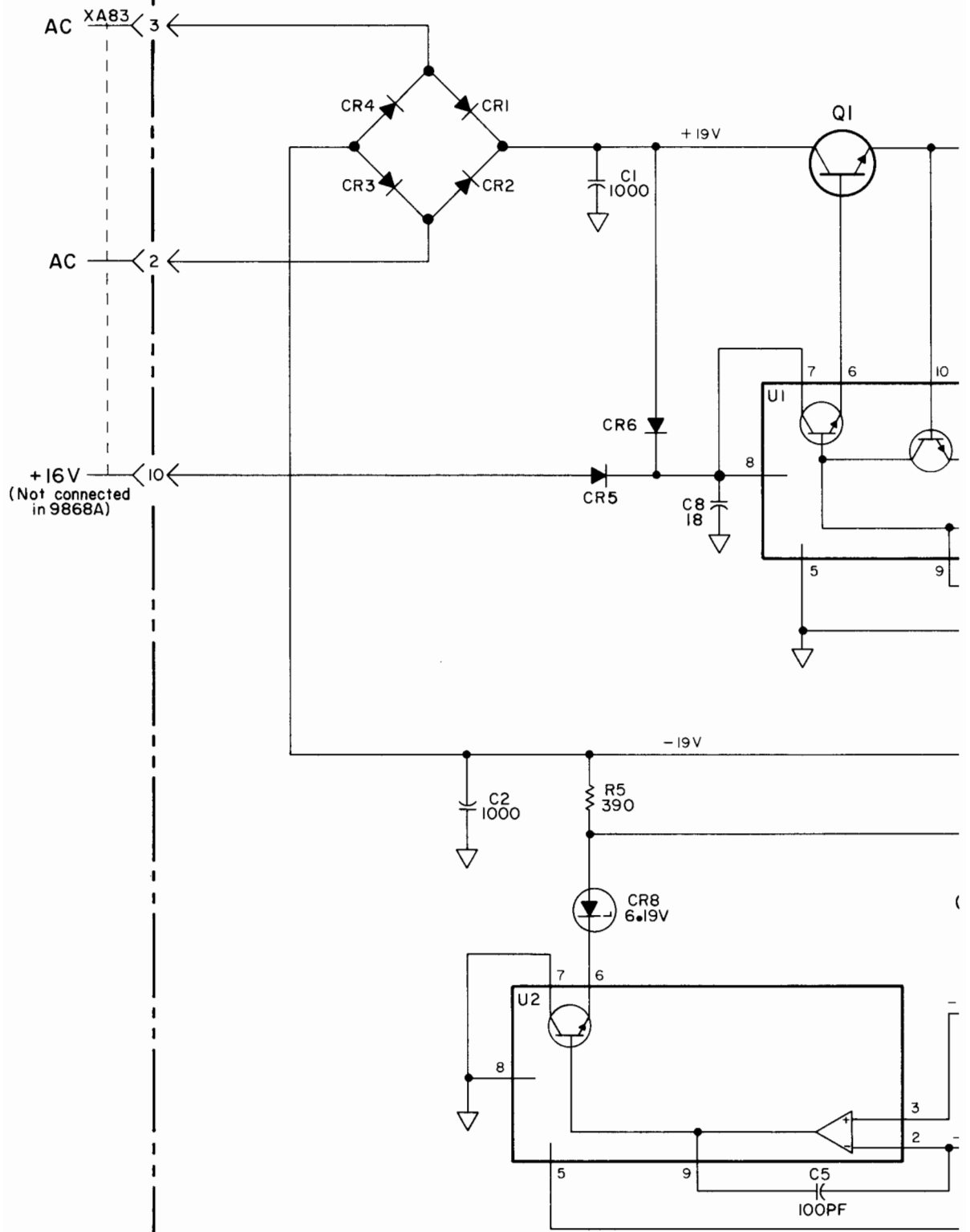

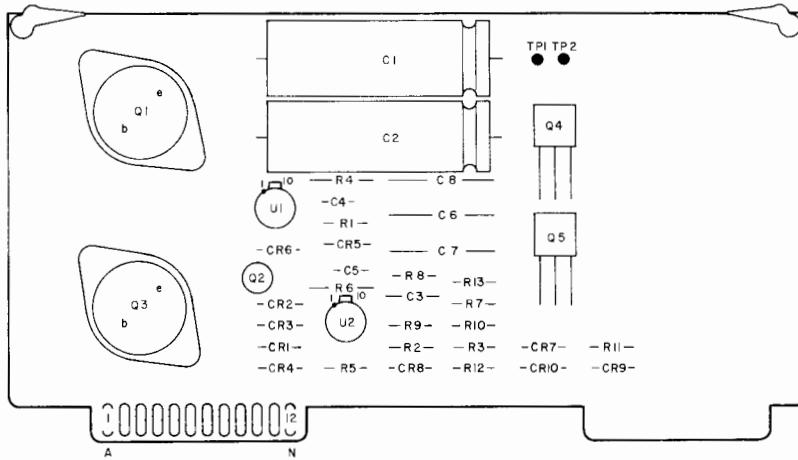

A83
 hp Part No 09810-66583
 REV A

