

HP 97098 I/O Expander Installation and Service

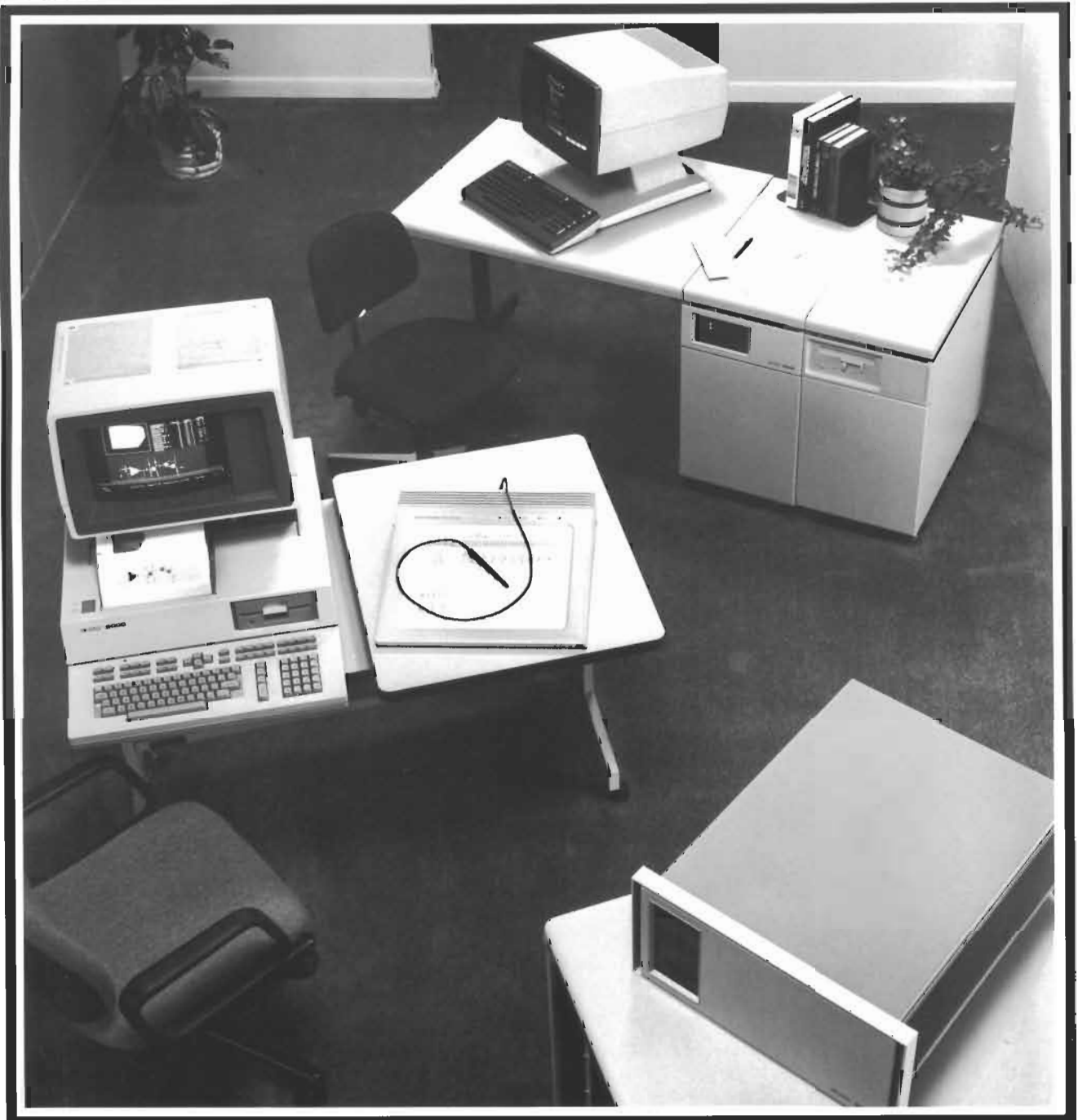

HP Computer Museum
www.hpmuseum.net

For research and education purposes only.



HP 97098 I/O Expander Installation and Service

Part No. 97098-90020

©Copyright Hewlett-Packard Company, 1982

This document refers to proprietary computer software which is protected by copyright. All rights are reserved. Copying or other reproduction of this program except for archival purposes is prohibited without the prior written consent of Hewlett-Packard Company.

Hewlett-Packard Engineering Systems Division
3404 East Harmony Road, Fort Collins, Colorado 80525

Printing History

New editions of this manual will incorporate all material updated since the previous edition.

Update packages may be issued between editions and contain replacement and additional pages to be merged into the manual by the user. Each updated page will be indicated by a note at the bottom of the page. A vertical bar in the margin indicates the changes on each page. Note that pages which are rearranged due to changes on a previous page are not considered updated.

Reprints incorporate all updates since the last edition.

The printing date changes on reprints and new editions.

First Edition...December 1982

Update 1...March 1983

Reprint...April 1983

Warranty Statement

Hewlett-Packard products are warranted against defects in materials and workmanship. For Hewlett-Packard Engineering Systems Division products sold in the U.S.A. and Canada, this warranty applies for ninety (90) days from the date of delivery.* Hewlett-Packard will, at its option, repair or replace equipment which proves to be defective during the warranty period. This warranty includes labor, parts, and surface travel costs, if any. Equipment returned to Hewlett-Packard for repair must be shipped freight prepaid. Repairs necessitated by misuse of the equipment, or by hardware, software, or interfacing not provided by Hewlett-Packard are not covered by this warranty.

HP warrants that its software and firmware designated by HP for use with a CPU will execute its programming instructions when properly installed on that CPU. HP does not warrant that the operation of the CPU, software, or firmware will be uninterrupted or error free.

HEWLETT-PACKARD MAKES NO WARRANTY OF ANY KIND WITH REGARD TO THIS MATERIAL, INCLUDING, BUT NOT LIMITED TO, THE IMPLIED WARRANTIES OF MERCHANTABILITY AND FITNESS FOR A PARTICULAR PURPOSE. Hewlett-Packard shall not be liable for errors contained herein or for incidental or consequential damages in connection with the furnishing, performance or use of this material.

This document contains proprietary information which is protected by copyright. All rights are reserved. No part of this document may be photocopied, reproduced or translated to another program language without the prior written consent of Hewlett-Packard Company. The information contained in this document is subject to change without notice.

Restricted Rights Legend

Use, duplication, or disclosure by the Government is subject to restrictions as set forth in paragraph (b)(3)(B) of the Rights in Technical Data and Software clause in DAR 7-104.9(a).

*For other countries, contact your local Sales and Support Office to determine warranty terms.

Table of Contents

Chapter 1. General Information

Introduction	1-1
Description	1-1
Equipment Supplied	1-2
Options	1-2
Power Options	1-2
Rack-Mount Options	1-2
System Configuration Options	1-2
Initial Inspection	1-2

Chapter 2. Installation

Introduction	2-1
FCC Radio Frequency Interference Statement	2-1
Power Requirements	2-1
Grounding Requirements	2-2
Fuse	2-2
Power Cords	2-3
Installing the I/O Expander	2-4
System Operation	2-5
Select Codes	2-5
Installing I/O Cards	2-6

Chapter 3. Service

Introduction	3-1
Theory of Operation	3-1
Buffer Board	3-1
Connector Board	3-5
Power Supply	3-5
Ac Components	3-5
Troubleshooting	3-6
IOP Bus	3-6
I/O Card or Device	3-6
I/O Expander	3-6
Assembly Access	3-8
Covers	3-8
I/O Cards	3-8
Power Supply	3-9
Buffer Board	3-10
Connector Board	3-12
Power Supply Fan	3-12
I/O Fan	3-12
LED Board and Cable	3-12
IOP Cable	3-12
Replaceable Parts	3-13

Figures

2-1	Line Voltage Selection Switches	2-2
2-2	Power Cords	2-3
3-1	I/O Expander Block Diagram	3-2
3-2	Buffering	3-3
3-3	Bi-directional Signal Circuit	3-3
3-4	Output-only Signal Circuit	3-4
3-5	Input-only Signal Circuit	3-4
3-6	Top Interior View From Back	3-10
3-7	Bottom Interior View	3-11
3-8	Top Interior View From Front	3-11

Tables

1-1	Supplied Equipment	1-2
3-1	Replaceable Parts	3-13

Chapter 1

General Information

Introduction

The HP 97098A I/O Expander contains up to eight HP-IO cards and connects them to an additional I/O processor (IOP) installed in an HP 9000 Series Computer. The I/O expander provides the physical space and power for eight cards, and the additional IOP supplies eight additional select codes.

One or two I/O expanders can be installed on the computer. In addition to the one standard I/O processor required by the computer, the computer must provide one IOP for each I/O expander installed.

The I/O expander cable connects to the second or third IOP in the processor stack. In the case of the 9000 Model 20, the I/O expander cable connects to a connector on the processor door. For the 9000 Model 30/40, the cable connects to a connector on the back panel. In both cases, a ribbon cable interconnects the second or third IOP in the processor stack with the I/O expander connector.

Description

The I/O expander is housed in a System II rack enclosure and consists of the following components:

- Power supply
- Buffer board
- Connector board
- IOP cable assembly
- Ac wiring
- Structural



The power supply provides outputs of +5, +12, and -12 volts.

The buffer board buffers the signals and serves as the HP-IO backplane for eight HP-IO cards.

The connector board connects the power supply to the buffer board.

The cable assembly consists of a metal hood assembly and a 6-foot shielded flat cable. The design of the hood and cable minimizes radiated electromagnetic interference (EMI) and provides repeatable transmission characteristics for the high speed digital signals.

The ac components include the on/off switch, two 110/220 volt selector switches, line filter, fuse, fans, and two I/O door interlock switches.

The remaining parts are structural.

Equipment Supplied

Table 1-1 lists the equipment which is furnished with the I/O expander.

Table 1-1. Supplied Equipment

Description	Quantity	Part Number
Installation and Service Manual	1	97098-90020
Power Cord	1	8120-1378*
Spare Fuse, 3A, 250V, NB	1	2110-0003**
Spare Fuse, 4A, 250V, NB	1	2110-0055***
Labels for Select Codes 16-23	1	7121-3564

* Part number for the standard power cord is shown. See Figure 2-2 for power cord options.

** 220V operation

*** 110V operation

Options

Power options, rack mounting options, and system configuration options are available for the I/O expander.

Power Options

The power options consist of power cords and line voltage selection. Power options are described in Chapter 2.

Rack-Mount Options

The following rack-mount options can be ordered directly out of the standard HP catalog for System II rack enclosure parts:

- 5061-0078 Rack Flange Kit
- 5061-0084 Rack Flange and Front Handle Kit

System Configuration Options

The I/O expander can be ordered with one of the following:

- HP 9000 Option 241: First additional IOP
- HP 9000 Option 242: Second additional IOP

Initial Inspection

The I/O expander and its accessories were carefully inspected before they were shipped to you. Please verify that the correct accessories are present; then inspect the I/O expander for physical damage. If any damage is found, contact the nearest HP Sales and Support Office. Refer to Chapter 2 for the electrical inspection information after you have installed your I/O expander.

Chapter 2

Installation

Introduction

This chapter includes information and procedures required for proper installation of the I/O expander. Power and grounding data is provided, including information on voltage selection switches, fuse, and power cords. I/O expander installation procedures are provided along with system operation and select code information. Procedures for installing I/O cards are also provided.

FCC Radio Frequency Interference Statement

**FEDERAL COMMUNICATIONS COMMISSION
RADIO FREQUENCY INTERFERENCE
STATEMENT (U.S.A. ONLY)**

The Federal Communications commission (in Subpart J of Part 15, Docket 20780) has specified that the following notice be brought to the attention of the users of this product.

Warning: This equipment generates, uses, and can radiate radio frequency energy, and, if not installed and used in accordance with the instructions manual, may cause interference to radio communications. It has been tested for compliance with the limits for a Class A computing device pursuant to Subpart J of Part 15 of FCC Rules, which are designed to provide reasonable protection against such interference when operated in a commercial environment. Operation of this equipment in a residential area is likely to cause interference in which case the user, at his own expense, will be required to take whatever measures may be required to correct the interference.

Power Requirements

The I/O expander has the following two input power ranges, configurable by changing the two voltage selection switches on the back panel:

- 110V nominal, ranging from 90 to 132 volts
- 220V nominal, ranging from 198 to 250 volts

Note

Both of the LINE SELECTOR switches must be in the same position. Both must be in the 110V position or both must be in the 220V position.

Figure 2-1 shows the line voltage selection switches on the back panel in both possible configurations. Set both switches in the required positions for your line voltage.

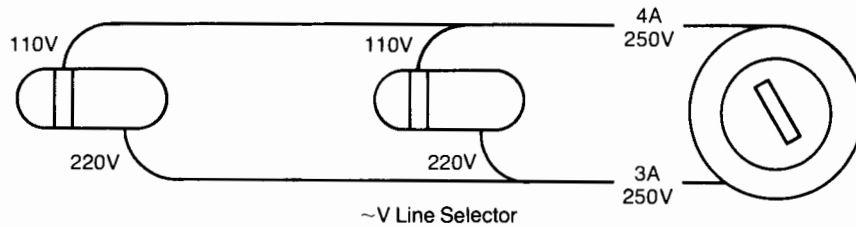

Figure 2-1. Line Voltage Selection Switches

Grounding Requirements

To protect operating personnel, the National Electrical Manufacturer's Association (NEMA) recommends that the I/O expander cabinet be grounded. The I/O expander is equipped with a three-conductor power cable which, when connected to an appropriate receptacle, grounds the cabinet of the I/O expander.

Fuse

The I/O expander must be fitted with a 4 amp, 250 volt fuse for 110 volt operation or a 3 amp, 250 volt fuse for 220 volt operation. The fuse part number is listed in Table 1-1.

WARNING

BEFORE CHANGING THE FUSE, ENSURE THAT THE I/O EXPANDER LINE CORD IS DISCONNECTED FROM ANY POWER SOURCE.

CAUTION

ENSURE THAT THE CORRECT FUSE IS USED. OTHERWISE, A MALFUNCTION OR UNUSUAL LINE VOLTAGE MAY DAMAGE THE I/O EXPANDER.

To remove the fuse, press in on the cap of the fuseholder and at the same time twist the cap in the direction indicated by the arrow on the cap. Pull the cap free and remove the fuse. To install the fuse, place either end of the fuse into the pocket in the cap, and reinstall the cap by pressing in on the cap and twisting it in the opposite direction from the arrow.

Power Cords

WARNING

IF IT IS NECESSARY TO REPLACE THE POWER CORD, THE REPLACEMENT CORD MUST HAVE THE SAME POLARITY AS THE ORIGINAL CORD. OTHERWISE, A SHOCK HAZARD MIGHT EXIST WHICH COULD RESULT IN INJURY OR DEATH. ALSO, THE EQUIPMENT COULD BE SEVERELY DAMAGED IF EVEN A RELATIVELY MINOR INTERNAL FAILURE OCCURRED.

Power cords with different plugs are available for the equipment; plug configurations are shown in Figure 2-2. Each plug has a ground connector. The cord packaged with the equipment depends upon where the equipment is to be delivered. If your equipment has the wrong power cord for your area, please contact your local HP Sales and Support Office.

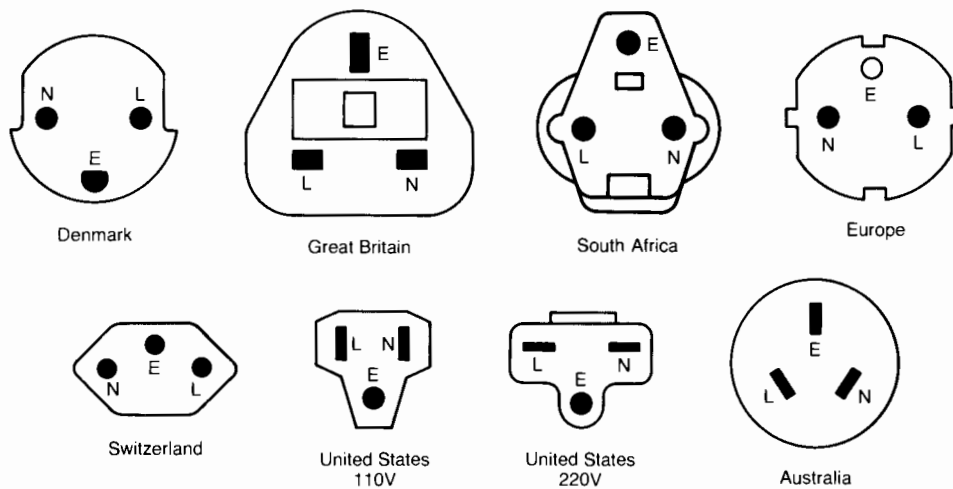

Power cords supplied by HP have polarities matched to the power-input socket on the computer:

- L = Line or Active Conductor (also called "live" or "hot")
- N = Neutral or Identified Conductor
- E = Earth or Safety Ground

Figure 2-2. Power Cords

Installing the I/O Expander

An additional IOP must be installed in the computer to install the I/O expander. Additional IOPs (second or third IOP) are not customer installable, but must be factory-installed or field-installed by an HP customer engineer (refer to System Configuration Options in Chapter 1).

To install an I/O expander on a system that has the additional IOP installed, do the following:

1. Place the I/O expander in the desired location.
2. Set the I/O expander AC POWER switch to the OFF position.
3. Set the computer power switch to the off position.
4. Connect the I/O expander flat cable to the computer:

- a. HP 9000 Model 20 Computer

Open left side door of computer. Connect I/O expander flat cable to connector on processor stack door. (As viewed from left side of computer, right connector on stack door is to second IOP; left connector on stack door is to third IOP.) Route cable out opening in back of computer. Close left side door.

- b. HP 9000 Model 30/40 Computer

Connect I/O expander flat cable to connector on back panel of computer. If Model 30, upper connector is to second IOP and lower connector to third IOP. If Model 40, right connector is to second IOP and left connector to third IOP.

5. Set the 110V/220V LINE SELECTOR switches for the proper voltage selection and ensure that the proper fuse is installed. Refer to Table 1-1.

Note

Both of the LINE SELECTOR switches must be in the same position. Both must be in the 110V position or both must be in the 220V position.

6. Connect the I/O expander power cord to the AC LINE socket and plug the cord into the ac power source.
7. Set the AC POWER switch to the ON position.

Note

Both rear I/O doors must be closed and the captive screws fully tightened for the I/O expander to power up. If the machine does not turn on properly, check and tighten the I/O doors using a screwdriver if necessary. Proper RFI performance requires that the I/O doors be tightly closed.

8. Verify I/O expander operation by observing the front panel LED.
9. If the I/O expander is connected to the third IOP, install the optional select code labels for select codes 16-23 over the standard labels per the Select Codes description which follows.
10. Turn the computer on and verify proper operation of the I/O cards installed in the I/O expander.

System Operation

The AC POWER switch must be in the ON position for the I/O expander to operate. The front panel LED indicates whether power is on. Note that both rear I/O doors must be closed and the captive screws fully tightened for the I/O expander to power up.

Note

At power up, turn on the I/O expander before turning on the computer. This ensures that the operating system recognizes the I/O expander and its I/O cards.

On system power-up, the system software catalogs the I/O cards. Therefore, the I/O expander should be turned on before or at the same time as the computer. Otherwise, errors occur when I/O expander cards are accessed. Executing a SCRATCH ALL from the computer also catalogs the I/O cards.

WARNING

THE CIRCUITRY TO THE AC POWER SWITCH IS ENERGIZED EVEN WITH THE SWITCH IN THE OFF POSITION. ALWAYS DISCONNECT I/O EXPANDER FROM AC SOURCE BEFORE OPENING ANY COVER INCLUDING I/O DOORS.



Select Codes

I/O expander I/O cards are assigned different select codes than computer I/O cards to differentiate the expander cards and the mainframe cards. Select codes 0-7 are reserved for mainframe I/O cards and other system components. The I/O expander connected to the second IOP in the system is assigned select codes 8-15. The I/O expander connected to the third IOP is assigned select codes 16-23.

Within an I/O expander, each slot has a fixed select code as shown by the label on the door. The lowest numbered select code (lowest priority) is assigned to the upper left slot as viewed from the back. The highest numbered select code (highest priority) is assigned to the lower right slot. The select code labels on the I/O expander as shipped from the factory are configured for an attachment to the second IOP. Therefore, the left label is numbered 8-11 from top to bottom, and the right label is numbered 12-15 from top to bottom. If the I/O expander is to be connected to the third IOP, affix a second set of labels, which are supplied separately, over the original labels. The left label of the second set is numbered 16-19 from top to bottom, and the right label is numbered 20-23 from top to bottom.

Installing I/O Cards

Note

The I/O expander powers down when the AC POWER switch is turned off or when either I/O door is opened. Whenever the I/O expander powers down, I/O card state and data are lost.

1. Set the I/O expander AC POWER switch to the OFF position.
2. Disconnect I/O expander from ac power source.

Note

Opening I/O door removes power to I/O cards, causing loss of information and I/O card state.

3. Loosen the thumbscrews on the I/O door, and open the door.

Note

Install replacement I/O card with ejectors out (extended). Seat card firmly in buffer board and push ejectors in to lock card in place.

4. Remove or insert the appropriate I/O cards component side up, always handling by the ejectors. Note that the select code is dependent on the slot number and whether the I/O expander is connected to the second or third IOP.
5. Close the I/O door and tighten the thumbscrews. Power does not come up unless door is fully closed.
6. Connect I/O expander to ac power source.
7. Set the I/O expander AC POWER switch to the ON position.
8. Cycle power on the computer, or execute a SCRATCH ALL.

Note

Cycling power on the computer, or executing a SCRATCH ALL, resets and initializes the I/O cards. System initialization also builds a table of valid I/O cards, enabling an added card to be recognized by the system.

Chapter 3

Service

Introduction

This chapter contains a block diagram, a theory of operation based on functional modules, troubleshooting aids, assembly access procedures, and replaceable parts data. This information helps you service the 97098A I/O Expander.

If you have difficulty repairing the I/O expander or if you would rather have HP repair it, contact the nearest Sales and Support Office for assistance.

Theory of Operation

Figure 3-1 is an overall block diagram of the I/O expander. Each of the major functional blocks is described in the following paragraphs.

Buffer Board

The buffer board has eight 80-pin connectors for the connection of eight HP-IO cards. The buffer board also has a connector that connects to the connector board to provide power to the buffer board and I/O cards. The IOP bus from the computer connects to the buffer board via a 50-pin connector. The IOP bus signals are identical to the internal computer IOP signals.

The buffer board logic buffers the signals from the IOP and drives eight I/O cards. To minimize capacitance on individual bus lines and thus maximize speed, the buffer board is divided into two identical backplanes of four cards each, as shown in Figure 3-2.

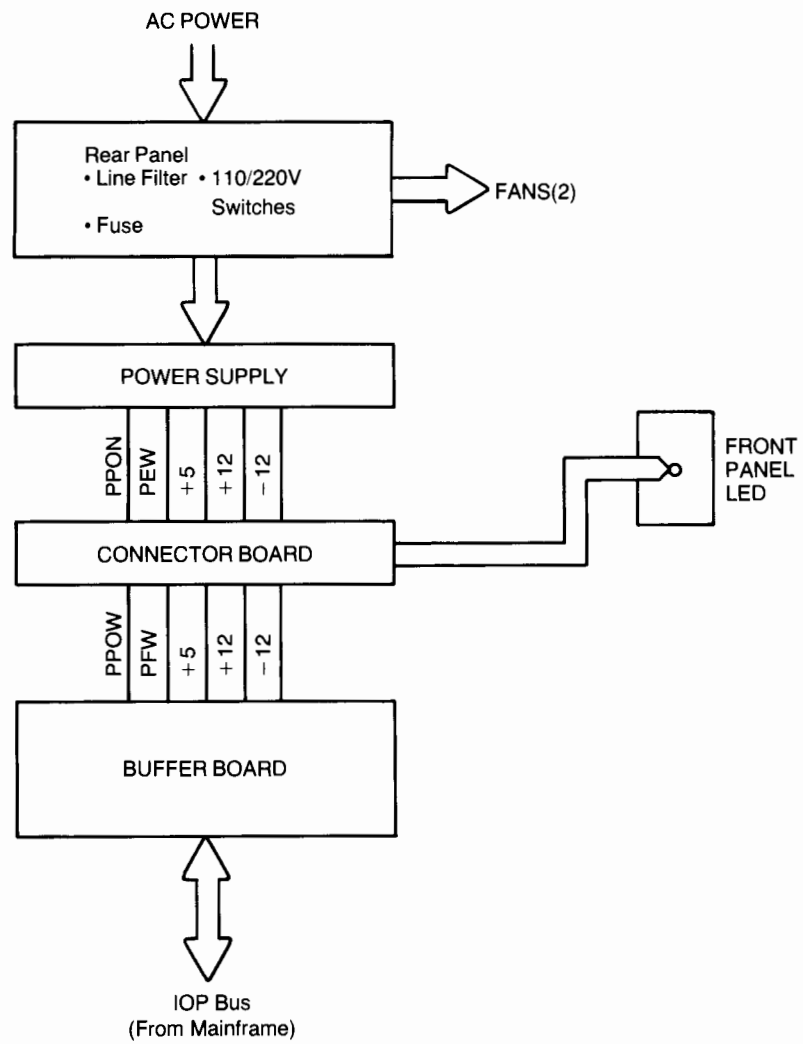

Figure 3-1. I/O Expander Block Diagram

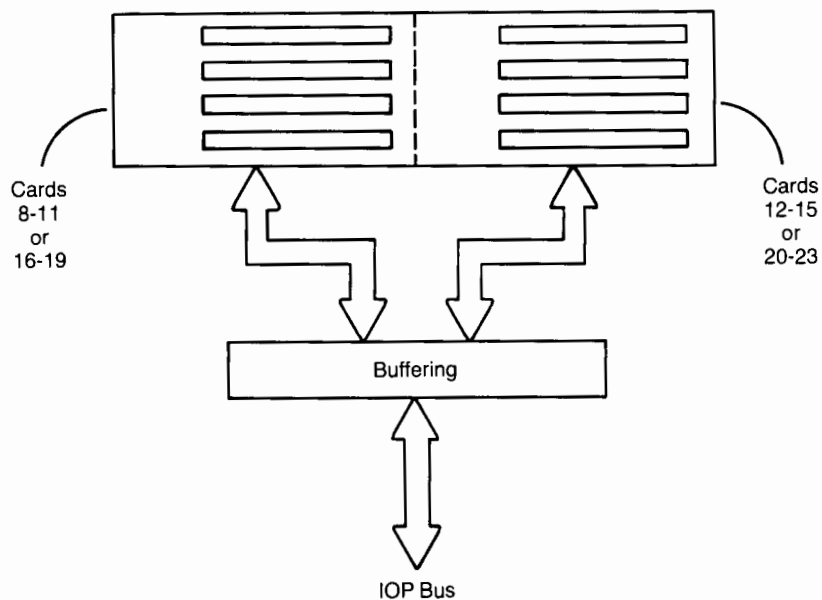

Figure 3-2. Buffering

Various types of signals are contained on the IOP bus. They can be divided into the following groups:

Bi-directional Bus Signals (– D0 to – D15)

These data signals are buffered with the circuitry shown in Figure 3-3. The circuitry drives the buffer board with IOP data except during POLL, READ, or IFC. During POLL or READ the data from the two buses are OR'ed together and driven onto the bus back to the IOP. During IFC both read and write buffers are disabled.

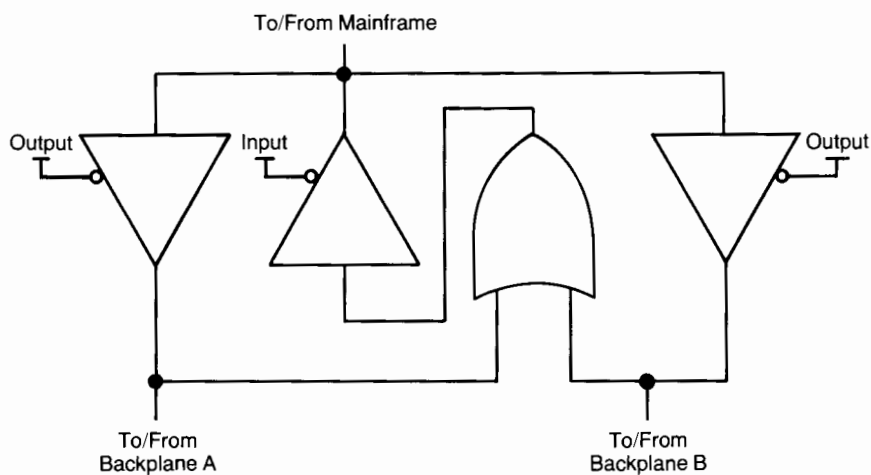

Figure 3-3. Bi-directional Signal Circuit

Output-only Signals (IC1-4, PA0-2, READ)

The circuit shown in Figure 3-4 drives these signals to each of the two four-card backplanes. Signals are divided to minimize load capacitance.

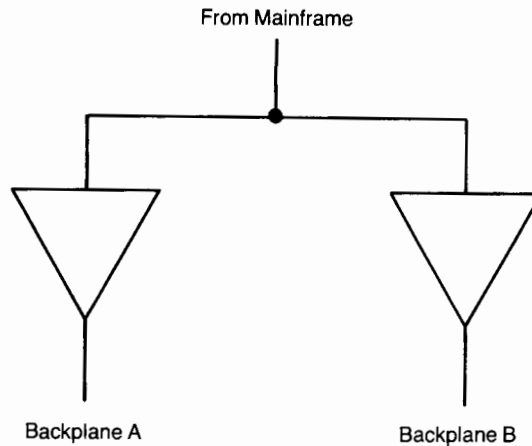

Figure 3-4. Output-only Signal Circuit

Input-only Signals (STS, DBYTE[FLAG], DEND, BR, ARQ[ASNC])

The circuit shown in Figure 3-5 drives the input-only signals. ARQ is driven only during POLL.

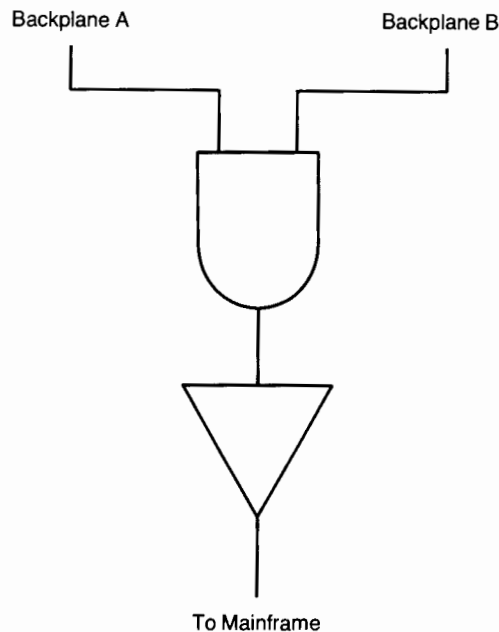

Figure 3-5. Input-only Signal Circuit

14.7456 MHz Clock

This signal is generated by a crystal oscillator clock and is buffered. This clock may be used by I/O cards as a clock reference or as a clock source for running microprocessors or other logic.

IFC

This output signal is OR'ed by the I/O expander with the PPON (power valid) signal from the I/O expander power supply and becomes the IFC (interface clear) signal for the HP-IO cards.

SYNC

This signal is the POLL signal inverted.

PPON, PFW

These two signals are generated by the power supply.

**SPON, +5S**

These signals may be used for power fail applications where the I/O card is able to retain information. The NORMAL/BATTERY switch on top of the buffer board connects +5S to +5 and SPON to PPON in the NORMAL position. By moving the switch, these connections can be broken and the lines driven by an external source. This switch should be in the NORMAL position when no battery backup is in use.

Connector Board

The connector board connects the power supply outputs to the buffer board. The connector board also has bypass connectors and a connection for the front panel LED.

Power Supply

The main outputs of the power supply are +5, +12, and -12 volts. The total power input is 220 watts, although the I/O expander uses only 96 watts (maximum) for I/O cards and 15 watts for the buffer board.

Ac Components

The major components of the ac path are as follows:

Ac Switch

The AC POWER switch disconnects line current from the remainder of the I/O expander. In the ON position, the expander is powered up and the front panel LED is lit. In the OFF position, the expander is off.

Ac Line Filter

The ac line filter reduces the amount of radiation transferred back on the ac line from the power supply. It also reduces the line transient and conducted susceptibility.

Fuse

From the ac line filter, the line goes through either a 3A, 250V or 4A, 250V fuse to protect against internal shorts. The power supply also has two 5A fuses. The I/O expander fuse has a lower rating so that the customer-accessible fuse fails first if a malfunction or unusual line voltage occurs.

110/220 Volt Line Selector Switches

These switches select a voltage setting of 110 or 220 volts. Both switches must be in the same position, either 110V or 220V. The switches also switch the ac fans. In 110V mode, the fans are in parallel. In 220V mode, the fans are in series. The switches are functionally equivalent to one triple-pole, double-throw switch.

I/O Door Interlock Switches

Each of the two I/O doors has an associated interlock switch. If either door is opened, the switch shuts off power to the I/O expander. This feature is a personnel safety precaution which also reduces possibility of damage to I/O card or expander.

Troubleshooting

The I/O system components that can fail when an I/O expander is used are as follows:

- IOP bus (including IOP finstrate in computer)
- I/O card or device
- I/O expander

This subsection provides troubleshooting hints and procedures for these three areas.

IOP Bus

The IOP finstrate in the computer performs a self-test at power-up. A red LED on the computer indicates if the IOP failed self-test.

I/O Card or Device

If the I/O expander powers up, but an I/O card or device seems to be malfunctioning, perform the following tests:

1. Cycle power on the I/O expander while observing the I/O card self-test LEDs visible through the holes in the expander's I/O doors. The LEDs should turn on when the self-test begins and go off at the conclusion of the self-test. If an LED fails to turn on or stays on permanently, the I/O card has failed its self-test and should be replaced.
2. If the I/O card seems to pass self-test, move the I/O card to the computer and repeat the self-test. If the I/O device still fails to function properly, the problem resides within the computer, I/O card, or device. If the I/O device does work properly, the problem resides in the I/O expander or I/O channel.

I/O Expander

WARNING

ALWAYS DISCONNECT I/O EXPANDER FROM AC SOURCE BEFORE OPENING ANY COVER INCLUDING I/O DOORS. WAIT AT LEAST ONE MINUTE FOR POWER SUPPLY CAPACITORS TO DISCHARGE.

1. With I/O expander powered on, observe the front panel LED. The LED lit indicates +12V power is present. Check for operation of +5V and -12V supplies by observing the two green LEDs on the buffer board. These LEDs are on the component side of the buffer board and can be observed through the right side panel of the I/O expander. If the I/O expander is rack-mounted, the LEDs can be observed through the cable holes in the left door as viewed from the back.

If all LEDs are on, perform the procedures under previous subsection titled I/O Card or Device. If the I/O card works in the computer but not in the I/O expander, the problem is probably in either the buffer board or in the IOP in the computer.

If all LEDs are off, an ac circuitry or power supply failure is indicated.

If one or two LEDs are on, the problem is probably:

- a. A power supply output has failed (likely),
- b. An I/O card or buffer board is grounding a power trace (less likely),
- c. The LED has failed (least likely).

WARNING

DO NOT TOUCH THE POWER SUPPLY AS YOU PERFORM THE FOLLOWING PROCEDURE. WAIT AT LEAST ONE MINUTE AFTER TURNING POWER OFF BEFORE CHANGING THE WIRING BACK TO ITS ORIGINAL STATE.

2. To check for proper operation of the ac circuitry, disconnect the ac power cord from the power source and remove the top cover. Disconnect the internal ac line cord from the power supply by removing the screw that secures the cord to the receptacle and unplugging the cord from the power supply. Disconnect the ac power cord from the line filter and connect it directly to the power supply.

Connect the ac power cord to the power source and turn on the I/O expander. Observe the LEDs to determine if outputs are working.

If all supply outputs work when the supply is wired directly to line current, the problem is in the ac circuitry.

If the supply still fails to work, the problem is in the power supply itself or beyond the supply. Check both 5A fuses on the power supply before replacing the supply.

Return the wiring to its original state.

3. If one or more of the power supply outputs is not working, open the I/O doors, remove all I/O cards, and close the doors. Power up the I/O expander and determine which outputs are present. If the outputs are now operational, an I/O card is causing the failure. If the same output(s) is still not working, the power supply has probably failed. The buffer board or connector board could be causing the failure, but that is unlikely and they should be the last assemblies checked.
4. If an ac component fault is likely, check power continuity back to the line filter, and replace defective component.
5. If one supply is failing, check the indicator LED with a voltmeter to ensure it's working before disassembling the power supply.

Assembly Access

The following procedures describe the removal of replaceable assemblies. The replacement procedures are the reverse of the removal procedures. Special instructions required for reassembly are clearly noted.

A list of the assemblies that have replacement procedures in this subsection follows:

- I/O Cards
- Power Supply
- Buffer Board
- Connector Board
- Power Supply Fan
- I/O Fan
- LED Board and Cable
- IOP Cable

The following tools are required to disassemble the computer:

- #1 Pozidriv screwdriver
- #2 Pozidriv screwdriver
- Flat-blade screwdriver
- 2.5-millimetre Allen wrench

WARNING

TURN AC POWER SWITCH OFF AND UNPLUG LINE CORD FROM AC POWER SOURCE BEFORE REMOVING ANY ASSEMBLY. ALLOW POWER SUPPLY CAPACITORS TO DISCHARGE FOR AT LEAST ONE MINUTE BEFORE REMOVING COVER.

Covers

The top, bottom, and side covers each have one #2 Pozidriv captive screw at the back of the expander that attaches the cover to the rack enclosure. To remove any cover, loosen the screw and slide the cover toward the back.

I/O Cards

1. Turn ac power switch off and unplug line cord from ac power source. Wait one minute for power supply capacitors to discharge.
2. Loosen two captive thumbscrews on I/O door and swing door open. A flat-blade screwdriver may be required to loosen thumbscrews.

3. Disconnect I/O cable connector from I/O card to be replaced.

CAUTION

HANDLE I/O CARDS CAREFULLY TO PREVENT DAMAGE TO CARD FROM ELECTROSTATIC DISCHARGE OR OTHER CAUSES. HOLD BY EJECTORS OR SIDE EDGES ONLY. DO NOT TOUCH EDGE CONNECTORS OR CARD PLANES. IMMEDIATELY PLACE CARD IN ANTISTATIC BAG OR ON ANTI-STATIC SURFACE.



4. Pull out on card ejectors to release card from buffer board and slide card out of slot.

Note

Install replacement I/O card with ejectors out (extended). Seat card firmly in buffer board and push ejectors in to lock card in place.

Power Supply (See Figure 3-6.)

1. Turn ac power switch off and unplug line cord from ac power source. Wait one minute for power supply capacitors to discharge.
2. Remove top cover.
3. Disconnect internal ac line cord from receptacle on power supply.
4. Disconnect both ac power switch wires that interconnect AC POWER switch and power supply from the power supply.
5. Loosen two captive screws at side of power supply that attach power supply holder to base.
6. Slide power supply toward fan, releasing supply from holder in base and from connector on connector board, and remove power supply.
7. Slide power supply from holder and retain holder for use with replacement supply.

Reassembly Note

Connect one ac switch wire to the wire on the power supply. Always connect the other ac power switch wire to the 110V post.

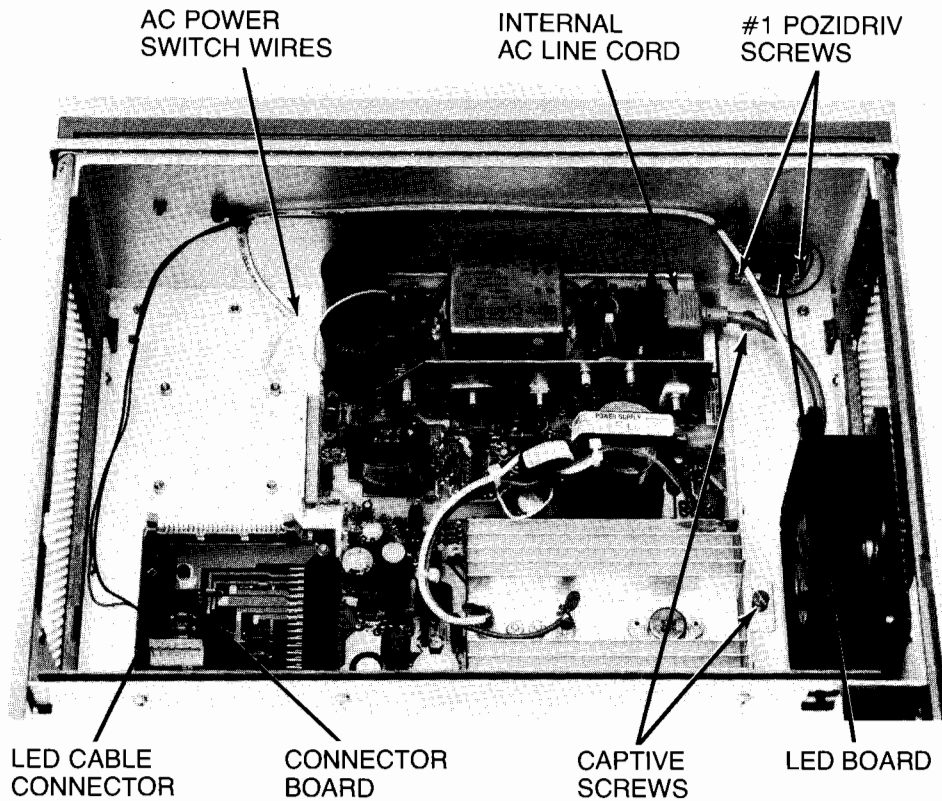

Figure 3-6. Top Interior View From Back

Buffer Board (See Figures 3-7 and 3-8.)

1. Turn ac power switch off and unplug line cord from ac power source. Wait one minute for power supply capacitors to discharge.
2. Remove power supply as previously described.

CAUTION

THE BUFFER BOARD IS HELD IN PLACE BY NINE SCREWS, A CONNECTOR ON THE CONNECTOR BOARD, AND THE INTERNAL IOP CABLE. REMOVE THE BUFFER BOARD ACCORDING TO THE FOLLOWING PROCEDURES TO AVOID DAMAGE TO EQUIPMENT.

3. Remove bottom cover and remove IOP cable connector from buffer board.
4. Remove nine #2 Pozidriv screws from buffer board.
5. Lift buffer board carefully to disconnect from connector board, and remove buffer board.

CAUTION

ENSURE THAT THE REPLACEMENT BUFFER BOARD HAS ITS NORMAL/BATTERY SWITCH IN THE CORRECT POSITION. THE SWITCH MUST BE IN THE NORMAL POSITION UNLESS A BACKUP BATTERY HAS BEEN ADDED.

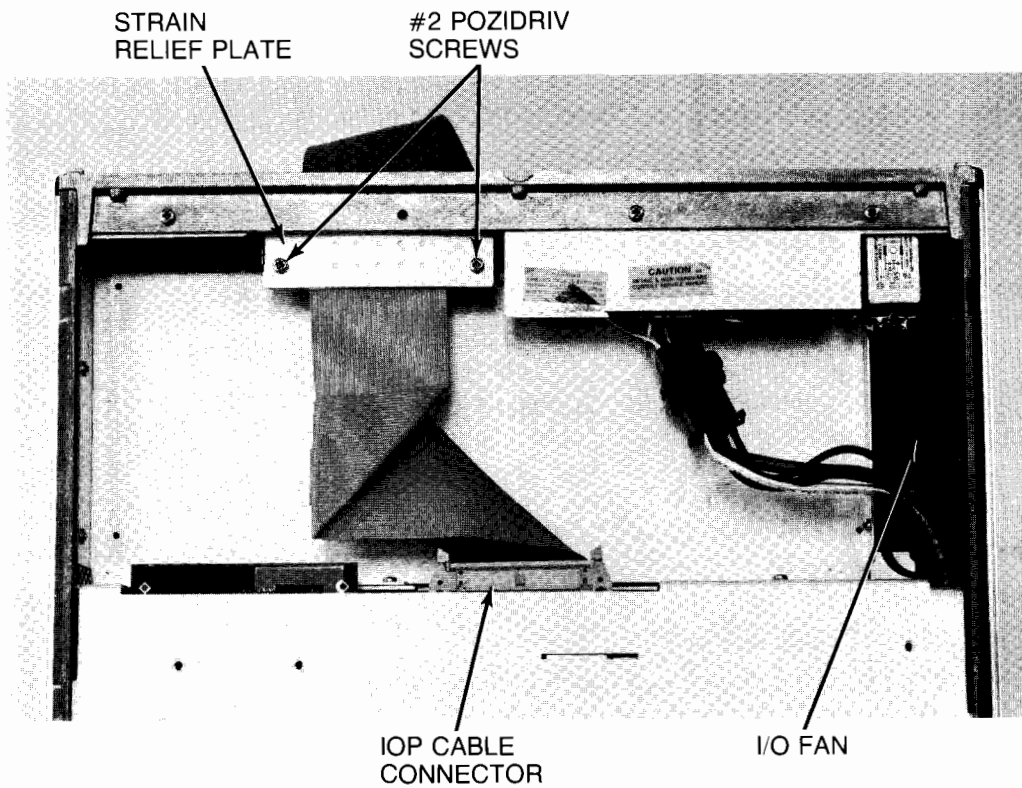

Figure 3-7. Bottom Interior View

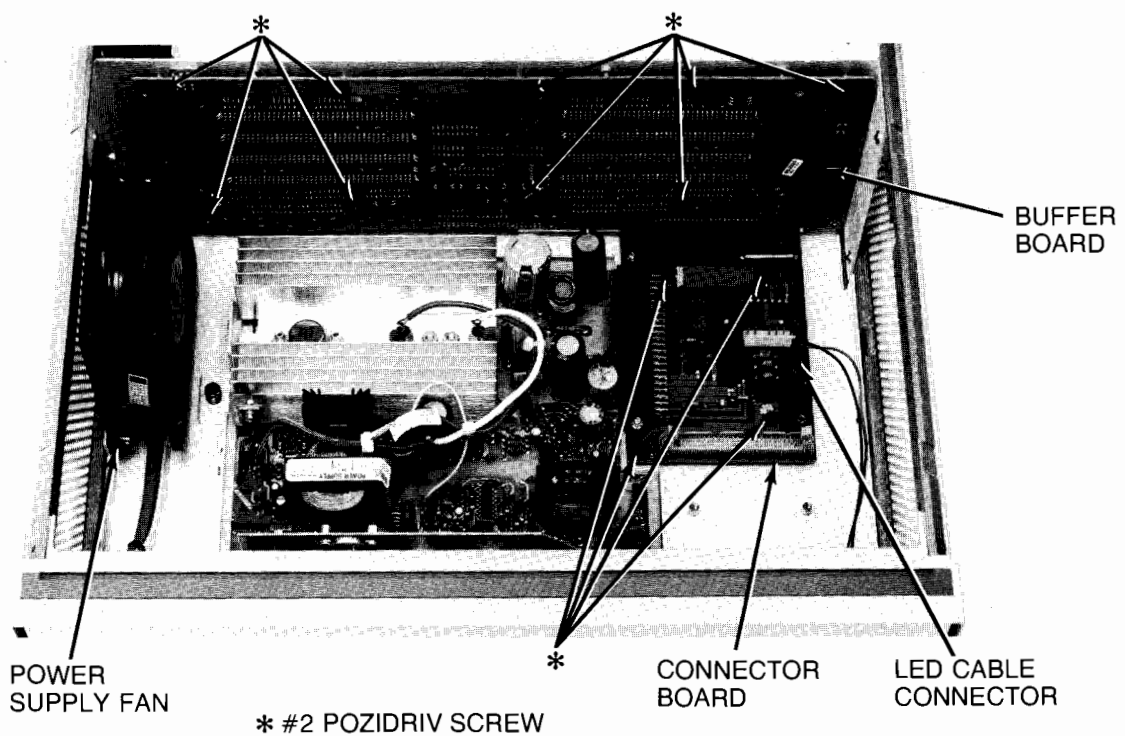

Figure 3-8. Top Interior View From Front

Connector Board (See Figure 3-8.)

1. Turn ac power switch off and unplug line cord from ac power source. Wait one minute for power supply capacitors to discharge.
2. Remove power supply as previously described.
3. Remove buffer board as previously described.
4. Remove LED cable connector from connector board.
5. Remove four #2 Pozidriv screws from connector board, and remove connector board.

Power Supply Fan (See Figure 3-8.)

1. Turn ac power switch off and unplug line cord from ac power source. Wait one minute for power supply capacitors to discharge.
2. Remove top cover.
3. Unplug power cable from fan.
4. Remove three 2.5-millimetre hex head screws from fan, and remove fan.

I/O Fan (See Figure 3-7.)

1. Turn ac power switch off and unplug line cord from ac power source. Wait one minute for power supply capacitors to discharge.
2. Remove top, bottom, and left side covers.
3. Unplug power cable from fan through bottom of rack enclosure.
4. Remove four 2.5-millimetre hex head screws from fan, and remove fan.

LED Board and Cable (See Figure 3-6.)

1. Turn ac power switch off and unplug line cord from ac power source. Wait one minute for power supply capacitors to discharge.
2. Remove top cover.
3. Unplug LED cable connector from connector board.
4. Cut cable tie wrap as required to remove LED board and cable.
5. Remove two #1 Pozidriv screws from LED board, and remove board and cable.

IOP Cable (See Figure 3-7.)

1. Turn ac power switch off and unplug line cord from ac power source. Wait one minute for power supply capacitors to discharge.
2. Remove bottom cover.
3. Remove IOP cable connector from buffer board.
4. Remove two #2 Pozidriv screws that attach cable strain relief plate to rack enclosure, and remove plate.
5. Remove IOP cable.

Replaceable Parts

Table 3-1 lists the replaceable parts for the I/O expander.

Table 3-1. Replaceable Parts

Exchange Part Number	New Part Number	Qty	Description
0957-0001	0950-0885	1	Power supply
09898-69501	09898-66501	1	Buffer board
	09898-66502	1	Connector board
	3160-0311	2	Fan
	09878-66506	1	Power-on LED board and cable
	09898-61601	1	IOP cable assembly
	8120-3819	1	Power switch and cable
	3101-0402	1	Interlock switch
	1600-1256	1	Deck sheet metal
	1600-1257	1	Power supply bracket
	1600-1258	1	Card cage top
	1600-1340	1	Brace
	0403-0441	4	Plastic card guide
	7121-3563	1	Select code labels (8-15)
	7121-3564	1	Select code labels (16-23)
	8120-1351	1	Power cord, Great Britain
	8120-1369	1	Power cord, Australia
	8120-1689	1	Power cord, Europe
	8120-1378	1	Power cord, U.S.A., 110V
	8120-0698	1	Power cord, U.S.A. 220V
	8120-2104	1	Power cord, Switzerland
8120-2956	1	Power cord, Denmark	
8120-4211	1	Power cord, South Africa	

Manual Comment Sheet Instructions

If you have any comments or questions regarding this manual, write them on the enclosed comment sheets and place them in the mail. Include page numbers with your comments wherever possible.

If there is a revision number, (found on the Printing History page), include it on the comment sheet. Also include a return address so that we can respond as soon as possible.

The sheets are designed to be folded into thirds along the dotted lines and taped closed. Do not use staples.

Thank you for your time and interest.

MANUAL COMMENT SHEET

**HP 97098 I/O Expander
Installation and Service**

97098-90020

April 1983

Update No. _____

(See the Printing History in the front of the manual)

Name: _____

Company: _____

Address: _____

Phone No: _____

fold ----- fold

fold ----- fold



NO POSTAGE
NECESSARY
IF MAILED
IN THE
UNITED STATES

BUSINESS REPLY MAIL
FIRST CLASS PERMIT NO. 37 LOVELAND, COLORADO

POSTAGE WILL BE PAID BY ADDRESSEE

Hewlett-Packard Company
Engineering Systems Division
Attn: Cust. Documentation/Dept. 4231
3404 East Harmony Road
Fort Collins, Colorado 80525

