



9111A Graphics Tablet User's Manual

Aug. 1, 1980

Hewlett-Packard Desktop Computer Division
3404 East Harmony Road, Fort Collins, Colorado 80525
(For World-wide Sales and Service Offices see back of manual.)
Copyright by Hewlett-Packard Company 1978

Table of Contents

The 9111A and You

Introduction	1-2
Specifications	1-4
Accessories Supplied	1-5
Accessories Available	1-5
Unpacking	1-6
Graphics Tablet Supplies	1-6
Maintenance Agreements	1-7
Power Requirements	1-8
Grounding Requirements	1-8
Power Cords	1-9
Fuses	1-10
HP-IB	1-11
Addressing	1-11
Cabling	1-11
Switching the Graphics Tablet On	1-12
Stylus	1-13
Softkeys	1-14
Digitize Light	1-14
Overlays and Menus	1-14
Overlay	1-14
Menus	1-16
Cleaning the Platen	1-17

Common Graphics Tablet Operations

Continuous Digitizing	2-2
Single Point Digitizing	2-3
Digitizing P1 and P2	2-3
Scaling	2-4
Cursor Tracking with Picks	2-5

Theory of Operation

Register Diagram	3-2
Register Model	3-3
Position, Cursor, and Digitizing	3-3

Menu	3-6
Errors, SRQ's and Parallel Polls	3-6
Beeper	3-9
Scaling Points	3-10
Resolution, Scale Factor, and Product ID	3-11
Errors and What They Mean	3-12
9111A Error Numbers	3-12
User Generated (Maskable) Errors	3-12
User Interaction Self Test Errors	3-13
Hardware Errors	3-13
User Interaction Self Test	3-13
Continuous Self Test	3-16
Interfacing	
HP-IB	4-2
Overview of the HP-Interface Bus	4-2
HP-IB System Terms	4-2
Interface Bus Concepts	4-2
Message Concepts	4-4
Graphics Tablet Bus Functions	4-6
Data Messages	4-6
Clearing the Graphics Tablet	4-7
Aborting a Bus Transaction	4-7
Parallel Poll	4-7
Serial Poll	4-8
Service Requests	4-8
Talk Only Mode	4-8
HP-IB Worksheet	4-8
General Interfacing Considerations	4-10
Interfacing Notes	4-13
HP 1000	4-13
HP 85	4-14
Language Reference	
9111A Instruction Set	5-2
Data Termination	5-2
HPGL Compatability	5-3
Methods Used to Represent Syntax	5-4
Pictorial Representation	5-4

Linear Representation	5-7
Beep	5-8
Frequency	5-8
Duration	5-9
Amplitude	5-9
Continuous Sampling Mode	5-10
Cursor Rate	5-12
Digitizer Clear	5-13
Default	5-14
Digitize Point	5-15
Input Masks	5-16
Error Mask	5-16
Status Mask	5-17
Parallel Poll Mask	5-17
Initialize	5-18
Input Points	5-19
Output Actual Stylus Position	5-20
Output Cursor	5-21
Output Digitized Point	5-23
Output Error	5-26
Output Factor	5-27
Output Identification	5-28
Output Key	5-29
Output Points	5-31
Output Resolution	5-32
Output Status	5-33
The Status Byte	5-34
Read Cursor	5-35
Read Softkey	5-37
Switch Follow	5-39
Single Sample Mode	5-40
Set Key	5-41
Switch Normal	5-42
Test Digitizer	5-43
Take Point	5-44
No-operation Instructions	5-45
Binary Data Transfer	5-45

Appendix

ASCII Table	A-2
Overlay / Menu Dimensions	A-4
Platen Physical Dimensions	A-5
Platen Digitizing Units Dimensions	A-6



The 9111A and You

Introduction

The HP 9111A is a Graphics Tablet which can add interactive graphics control (cursor moving and picking) and graphics input to your computer. The 9111A adds these features to your system:

- Program Control — 16 Softkeys are available for user interaction and program control.
- Programmable Beeper — The beeper is programmable in musical tones (on an even tempered scale) for human engineering of audio prompts.
- Multiple Modes — Single Point is available for picking objects and two Continuous modes for graphics input applications.
- Durable ceramic surface for the platen.
- Human Engineered Stylus — The stylus is slim and lightweight with good tactile feedback.
- Programmable Cursor Rate — You can adjust the cursor update rate to match your CRT refresh rate.
- Easy to Program — HP-GL provides precise control of all Graphics Tablet functions.

Characters

The characters on the next page are used throughout the book to emphasize various points. We would like to thank Rand Renfro for providing these drawings.

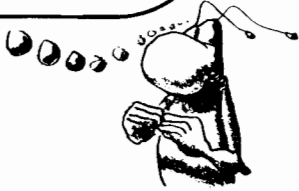
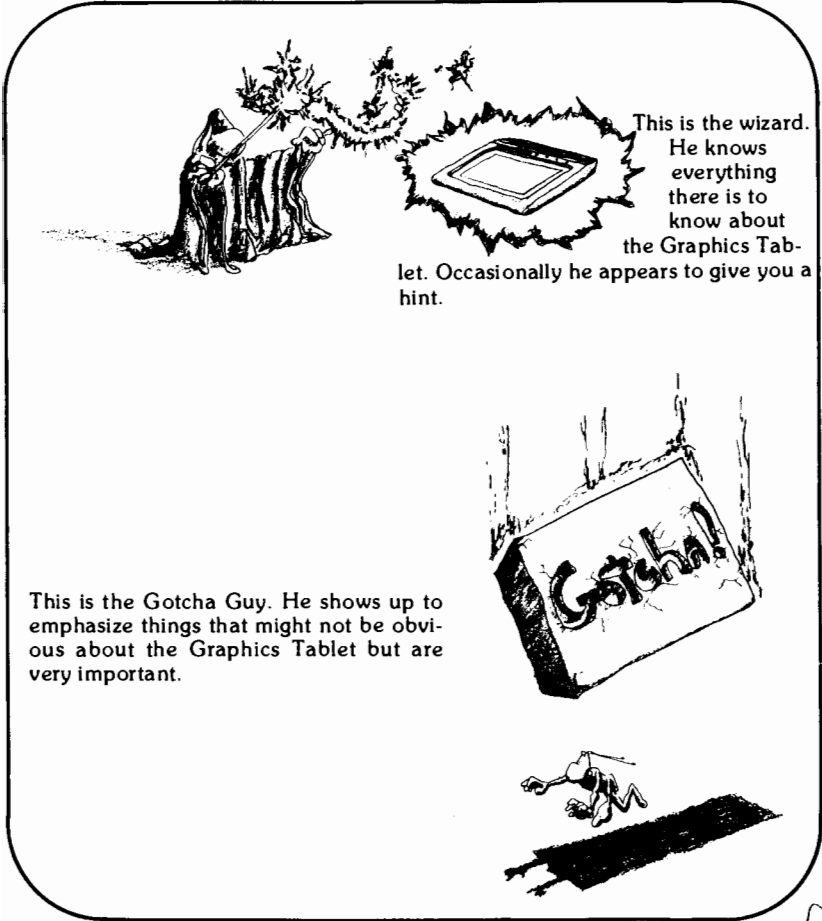

Cast of Characters

Specifications

NOTE

The specifications of the Graphics tablet were measured with a bare platen. They may not apply when menus or other source documents are on the platen.

Resolution	0.100mm (.00394 in.)
Accuracy	±0.600mm (.0236 in.) (20° C, each measured point) Derate .004mm/° C deviation from 20° C
Data Rate	Programmable from 1 to 60 coordinate pairs/sec. Average rate ± .2Hz from nominal.
Active Digitizing	
Area	218.5 x 300.8mm (8.6 x 11.8 in.) not including menu area.
Stylus Motion Rate	
on paper	500mm/sec.
on platen	730mm/sec.
Document Material	Single sheet, electrically non-conductive, homogenous <.5mm thick
Repeatability	±1 resolution unit from mode of data.
Platen Artwork Accuracy	origin, self-test dot, any border, measured vs. documented ±2.8mm (.11 in.)

POWER REQUIREMENTS

Source (±10%)	100 Vac
	120 Vac
	220 Vac
	240 Vac
Frequency	48 to 66 Hz
Consumption	200mA@100 Vac
25W Maxium	165mA@120 Vac
	90mA@220 Vac
	80mA@240 Vac

SIZE/WEIGHT

Height	85mm (3.35 in.)
Width	440mm (17.32 in.)
Length	440mm (17.32 in.)
Weight	
net	5.8kg (12.8 lbs.)
shipping	10.8kg (23.8 lbs.)

OPERATING ENVIRONMENTAL RANGE

Temperature	0° to 55° C
Relative Humidity	5% to 90% at 40° C non-condensing

Accessories Supplied

Item	Part Number
Overlay	4040-1748
Pack of Blank Menus	9270-0977
Pack of Stylus Refills	09111-68701
9111A User's Manual	09111-90000
Spare Fuses	_____
Power Cord	_____

Accessories Available

Item	Part Number
Package of 3 overlays	7121-0988
Pack of Blank Menus	9270-0977
Package of stylus.....	09111-68701
Refills	
2 Inkless	
3 Ink	
Padded Carrying Case	1540-0685

OPTIONS

045	9111A-9845B System Tutorial Manual	09111-90045
-----	---------------------------------------	-------------

Unpacking

Your 9111A Graphics Tablet is carefully inspected, both electrically and mechanically, before shipment. It should be free of scratches and in perfect electrical order upon receipt. Carefully inspect the Graphics Tablet for any physical damage caused in transit. Notify your local HP Sales and Service Office and file a claim with the carrier if there is any damage.

Please check to ensure that you have received all of the items which you ordered and that all the accessories are present, as listed below.

Accessories

Overlay	1	4040-1748
Pack of Blank Menus	1	9270-0977
Fuse (½ amp, NB)	1	2110-0012
Fuse (¼ amp, NB)	1	2110-0004
Cartridges		09111-68701
Inkless	2	
Inked	3	
9111A Graphics Tablet		
User's Manual	1	09111-90000

There may also be a System Tutorial Manual included as part of a specific option you have purchased.

The cartridges and the fuse are contained in a small plastic pouch. You can punch the pouch to put in your manual.

If you have any difficulties with your system, if it is not operating properly, or if any of the items are missing, please contact your nearest HP Sales and Service Office; addresses are supplied at the back of the 9111A Users Manual.

Graphics Tablet Supplies

Replacement supplies are mentioned at various places in the following sections. They may be purchased from Hewlett-Packard's

Computer supplies center. Orders may be placed in the United States by calling (800) 538-8787 outside of California or by placing a collect call to (408) 738-4133 within California. Supplies may also be ordered through your local HP Sales and Service Office. Accessories available for the 9111 include:

Pack of Blank Menus	9270-0977
Overlays	7121-0988
Stylus Cartridges	0911-68701
2 Inkless	
3 Inked	

Maintenance Agreements

When you buy Hewlett Packard equipment, service is an important factor. If you are to get maximum use from your equipment, it must be in good working order. An HP Maintenance Agreement is the best way to keep your equipment in optimum running condition.

Consider these important advantages:

- **Priority Service** — Your Maintenance Agreement insures that you receive priority treatment with an agreed on response time.
- **On-Site Service** — There is no need to package your equipment and return it to HP. Fast and efficient modular replacement at your location saves you both time and money.
- **Fixed Cost** — The cost is the same regardless of the number of calls, so it is a figure you can budget.
- **Complete Package** — A single charge covers labor, parts, and transportation.
- **Regular Maintenance** — Periodic visits are included, per factory requirements to keep your equipment in optimum operating condition.
- **Individualized Agreements** — Each Maintenance Agreement is tailored to support your equipment configuration and your requirements.

1-8 The 9111A and You

After considering these advantages, we are sure you will find that a Maintenance Agreement is an important and cost-effective investment.

For more information, please contact your local HP Sales and Service Office.

Power Requirements

The 9111A may be powered from 100, 120, 220, or 240 VAC. The range of operation is within $\pm 10\%$ of each nominal voltage. Two switches on the rear panel are used to select the line voltage. Check to make sure the switches are set appropriately for your local line voltage, according to the drawing below. The line frequency must be between 48 and 66 Hz. The Graphics Tablet requires a maximum of 25 voltamps.

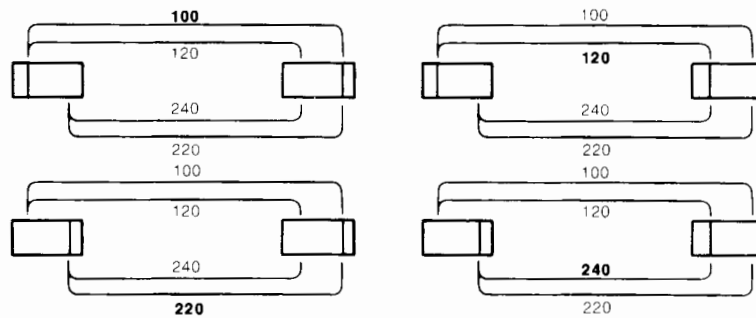

CAUTION

THE GRAPHICS TABLET MAY BE DAMAGED IF THE LINE VOLTAGE SWITCHES ARE SET INCORRECTLY. CHECK THE SWITCH SETTINGS BEFORE APPLYING POWER.

Grounding Requirements

The National Electrical Manufacturers Association (NEMA) recommends that the Graphics Tablet be grounded to protect operating personnel from electrical shock. The Graphics Tablet is equipped with a three conductor power cable which, when connected to an appropriate receptacle, grounds the cabinet of the unit.

Power Cords

Power cords supplied by HP will have polarities matched to the power input socket on the equipment, shown below:

WARNING

IF IT IS NECESSARY TO REPLACE THE POWER CORD, THE REPLACEMENT CORD MUST HAVE THE SAME POLARITY AS THE ORIGINAL, OTHERWISE A SAFETY HAZARD FROM ELECTRICAL SHOCK MIGHT EXIST. THIS COULD RESULT IN INJURY OR DEATH TO PERSONNEL. IN ADDITION, THE EQUIPMENT COULD BE SEVERELY DAMAGED IF EVEN A RELATIVELY MINOR INTERNAL FAILURE OCCURRED.

Power cords with different plugs are available for the equipment; the part number of each cord is shown in the figure below. The cord packaged with your equipment depends upon where your equipment is to be delivered. If your equipment has the wrong power cord for your area, please contact your local HP Sales and Service Office.

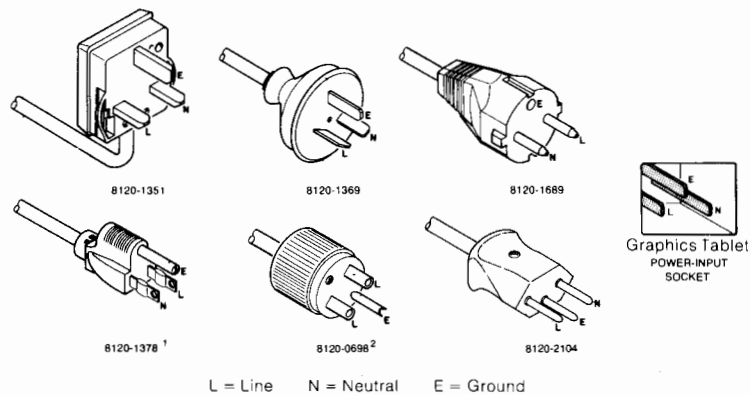

¹UL and CSA approved for use in the United States of America and Canada with equipment set for either 100 or 120 Vac operation.

²UL and CSA approved for use in the United States of America and Canada with equipment set for either 200 or 240 Vac operation.

Fuses

Two fuses are provided for the 9111A, a ½ amp normal blow for use with 100 and 120 volt settings, and a ¼ amp normal blow for use with 220 and 240 volt settings. Make sure the fuse in use matches the voltage setting on the back panel of the 9111A.

WARNING

FOR CONTINUED PROTECTION AGAINST FIRE HAZARD, REPLACE ONLY WITH THE SAME TYPE AND RATING OF FUSE AS SPECIFIED FOR THE LINE VOLTAGE BEING UTILIZED.

Voltage	Fuse
100, 120V	½A
220, 240V	¼A

WARNING

BEFORE CHANGING THE FUSE, BE SURE THAT THE GRAPHICS TABLET IS DISCONNECTED FROM ANY POWER SOURCE.

To remove a fuse, press in on the cap of the fuse holder and twist the cap in the direction indicated by the arrow on the cap. Pull the cap free and remove the fuse.

To install a fuse, place either end of the fuse into the pocket in the cap and reinstall the cap by pressing in on the cap and twisting it in the opposite direction from the arrow.

Always be sure that the correct fuse is used. The wrong fuse could result in damage to the graphic tablet if a malfunction or unusual line voltage occurs.

HP-IB



Addressing

There are 6 small switches next to the HP-IB connector on the rear panel of the 9111A. Five of these switches are address switches, and the sixth is used to initiate the Self Test. The HP-IB address of the 9111 is selected by setting the binary value of the address on the switches, as in the diagram below. Setting the address to 31 configures the Graphics Tablet to the Talk Only Mode. In the Talk Only Mode the 9111 sends a binary cursor location and status word in six bytes. This is the Default Binary Response, and is sent whenever no other data is requested before a read operation. See the "Talk Only Mode" in the Interfacing chapter for more information.

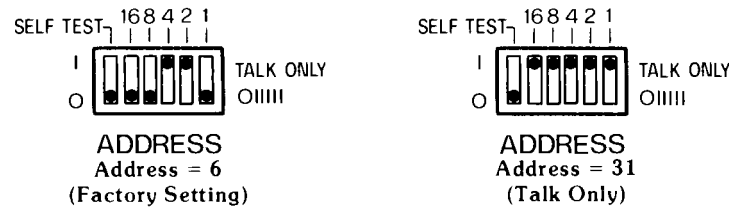

Cabling

If any other devices are to be connected to the your computer through the same interface, the 9111A should be the device nearest the controller on the HP-IB system. The total cable length of the HP-IB system should be 2 metres times the number of device in the system or 20 metres whichever is less. The cable may be distributed in any convenient configuration. Failure to follow these cabling limits may produce an HP-IB system with unreliable data transfer characteristics. For further details on electrical and physical characteristics of the HP-IB, consult the IEEE Standard Digital Interface for Programmable Instrumentation (IEEE Std 488-1978).

Switching the Graphics Tablet On

The following steps should be followed when you are switching your Graphics Tablet on for the first time.

1. Verify that the line voltage switch is set for the voltage level in your area.
2. Verify that the proper fuse is installed for the line voltage setting ($\frac{1}{2}$ amp Normal Blow for 100V to 110V or $\frac{1}{4}$ amp Normal Blow for 220V to 240V).
3. Connect the power cord to the Graphics Tablet and an ac power source.
4. Switch the Graphics Tablet on by pushing the POWER switch at the rear of the righthand side of the Graphics Tablet to 1.

The lights at top of the Graphics Tablet should flash on briefly, and an ascending sequence of tones (the "hello" sequence) should be heard. This means that the 9111 has passed the electronics self test.

If any of the lights fail to flash, or if a "warbling" tone is heard, the device has failed the self test. If this happens, consult the section Errors and What They Mean in the Theory of Operation chapter of this manual.

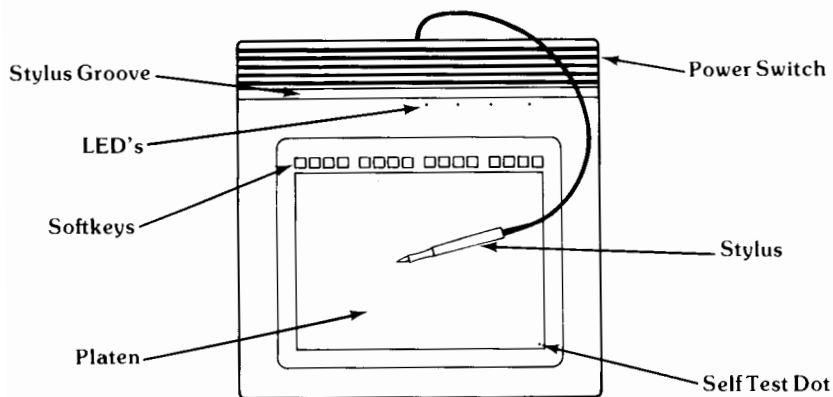

Stylus

The ball-point-pen-shaped-thing on the end of the cable is called a **Stylus**. The stylus is your means of physically interacting with the Graphics Tablet, and thus with your graphics system. A switch in the stylus may be closed by pressing on the tip of the stylus.

This switch closure can be detected by the Graphics Tablet and used to tell it to do something. Press the tip of the stylus lightly against the platen, and then slowly increase the pressure until you hear/feel a click. This means that the switch has closed. Now slowly release the pressure. You should feel the switch very distinctly as it releases.

The stylus contains a ball point pen cartridge, and both inked and non-inked refills are available. Cartridges may be changed or replaced by unscrewing the front of the stylus. When replacing the cartridge, make sure the spring is not bent (replacement springs are shipped with the cartridges) and that the O-ring is in place (see the photograph below). Positioning of the O-ring is not critical, as the stylus - O-ring mechanism is self adjusting, as long as the parts are placed on the cartridge in the correct order. The inked cartridges have a brass tip and the inkless cartridge has a nickel-plated tip with a silver color.

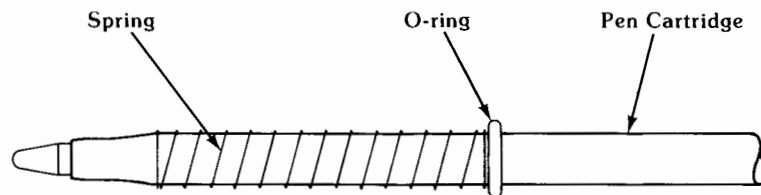

Replacement cartridges may be purchased by ordering part number 09111-68701 for a pack of 5 cartridges. The cartridges may be ordered through your local HP Sales and Service Office or through the Computer Supply Center as described on page 1-6.

Softkeys

Try pressing the tip of the stylus down in one of the numbered squares along the top of the platen. The light labeled **Menu** should come on. Press it in the same square again, and the **Menu** light should go out. The squares along the top of the platen are called softkeys, and can be interpreted by the 9111. The Graphics Tablet can be set up to generate a **Service Request** or a positive **Parallel Poll** response when any of the squares is selected, and will return the number of the selected square upon receipt of the correct **HP-GL** instruction.

The menu area can be turned off to extend the digitizing area available.

Digitize Light

The Digitize light will come on whenever the 9111 is ready to digitize a point. Pressing the stylus anywhere within the active digitizing area on the platen will extinguish the light.

Overlays and Menus

Included with your 9111 are an overlay and some menu blanks. The overlay is provided to hold down materials for menu and digitizing applications. The menu material is provided for generating artwork for heavily used application programs.

Overlay

The overlay is a sheet of frosted plastic with tabs on the sides. The tabs fit into the slots indicated in the illustration below, and hold the overlay firmly in place. The frosted side of the overlay should be up to reduce glare.

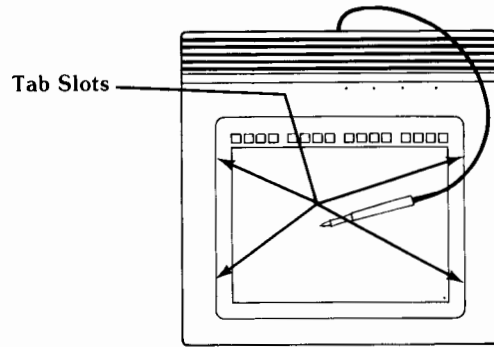

The overlay is made of polyester. While this plastic is very durable, it can be dissolved by certain solvents and should be cleaned using one of the following methods:

- Wash with water.
- Wash with soap and water — then rinse thoroughly with water to remove soap residue.
- Wash with isopropanol — then rinse with water to remove residue.
- Wash with a mild, non-abrasive household cleaner (such as Formula 409[®]) — then rinse with water to remove the residue.

Any cleaning should be followed by a thorough rinse with water to remove residue, as chemical residues can distort the measurement fields used by the 9111.

1-16 The 9111A and You



Notice that all the above instructions involve

a water wash or rinse at some point. THIS

IS VERY IMPORTANT. Any residual films left by any of the cleaning agents used can degrade the performance of the system used to locate the stylus. KEEP THE OVERLAY CLEAN.

Overlays may be purchased by ordering part number 7121-0988. The overlays may be ordered through your local HP Sales and Service Office or through the Computer Supply Center described on page 1-6

Menus

While paper is suitable for many menu applications, if the menu is to be used over an extended period of time, paper tends to wear out, requiring frequent replotting of the menus. Additionally, paper may degrade the accuracy of the Graphics Tablet in high humidity environments. The acetate menu material provided is durable, and is precut to fit the cutout in the casetop. This allows mechanical alignment of the menu, instead of visual alignment. Inks designed to acetate should be used to generate the artwork (such as the transparency pens for the 9872 plotter — part number 5060-6818). The menus can be cleaned once the ink has dried completely (this may take several days.) Use a damp towel or sponge and clean gently.

If you wish to make your own menus, the physical dimensions are given in Appendix A. Menu blanks may be purchased from HP — by ordering part number 9270-0977. The menu blanks may be ordered through your local HP Sales and Service Office or from the Computer Supply Center described on page 1-6.

The 9111 uses an electronic system to determine the location of the stylus in relation to a conductive grid beneath the platen. Conductive materials can interfere with this sensing operation. The conductivity of many materials increases at high humidities. For maximum accuracy, source document digitizing should be done in an environment with low relative humidity.



Some inks and pencil leads are highly conductive and can distort the fields used in the measuring process. When designing menus for high accuracy applications, be sure to plot or print them with a low conductivity ink on low conductivity materials. Note that the materials must have a low conductivity in the environment in which they are to be used, and that conductivity of many materials increases markedly with increases in the relative humidity.



The above comments also apply to source documents you are digitizing.



Cleaning the Platen

The platen on the 9111 is made of a very rugged ceramic. Although it is possible to chip and scratch it, it will not show wear under normal usage. Some cautions should be observed in cleaning it to avoid abrasion to the surface. The following cleaning methods are acceptable:

1-18 The 9111A and You

- Wash with water.
- Wash with soap and water — then rinse thoroughly to remove soap residue.
- Wash with isopropanol — then rinse with water to remove residue.
- Wash with a mild, non-abrasive household cleaner (such as Formula 409[®]) — then rinse with water to remove the residue.



Dirt and oils on the platen can distort the fields used for measurement. This results in degraded accuracy in high humidity environments. The solution is simple — KEEP THE PLATEN CLEAN!

CAUTION

BE CAREFUL NOT TO GET MOISTURE INSIDE THE CABINET OF THE 9111.

Any cleaning should be followed by a thorough rinse with water to remove any residue, as chemical residues can distort the measurement fields used by the 9111.



**Common
Graphics Tablet
Operations**

2-2 Common Graphics Tablet Operations

There are certain common procedures encountered when operating the 9111A Graphics Tablet. Some of these, along with algorithms to implement them, are discussed below. The algorithms are presented in Pseudo-code. This is not a real language, but rather a formalism for discussing algorithms. For a detailed description of the instructions, used, refer to the Language Reference in the back of this book.

Continuous Digitizing

Continuous digitizing is used to generate or follow line contours with the 9111A. There are two modes of continuous digitizing, Switch Normal and Switch Follow. Both modes generate streams of data points which must be read individually using the OD instruction. In Switch Normal the first pen press is interpreted as a 'begin digitizing' signal and the second pen press is treated as an 'end digitizing' signal. In Switch Follow the points are digitized while the switch is depressed. In both modes, the last point sent by an OD instruction has a pen parameter of 0.

The following program fragment shows how to implement the continuous mode. The first lines initialize the Graphics Tablet to default conditions (DF), select the continuous mode (CN) and select either Switch Normal (SN) or Switch Follow (SF) Mode. These instructions set up the Graphics Tablet. The program then goes into a loop which continuously reads the Status of the Graphics Tablet (OS) and tests for the Digitized point available Bit (Bit 2) to come true. Bit 2 is set whenever a digitized point is available.

When a digitized point is available, the point is read using an OD command. If Pen = 1, another point in the contour is added to the data base, and if Pen = 0, the contour currently being recorded is terminated, and the data base set to read the next point as the beginning of a new contour.

```
OUTPUT "DF;CN" to Graphics Tablet
IF Mode = SWITCHNORMAL
  THEN OUTPUT "SN" to Graphics Tablet
  ELSE OUTPUT "SF" to Graphics Tablet
```

```

DO while you want to digitize
  BEGIN
    REPEAT
      OUTPUT "OS" to Graphics Tablet
      ENTER Status from Graphics Tablet
      UNTIL BIT 2 of Status = 1
      OUTPUT "OD" to Graphics Tablet
      ENTER X,Y, Pen from Graphics Tablet
      IF Pen = 0
        THEN Terminate Line Contour in the Data Base
        ELSE Update the Data Base
    END
  END

```

Single Point Digitizing

In some applications, you may wish to digitize single points rather than contours. The following program fragment shows how to implement single point digitizing. The first line sets the Graphics Tablet to a known state (DF) and selects the single point mode (SG). The program then goes into a loop which continually reads the Status of the 9111A, and tests for the digitized point available bit (Bit 2) to come true. Bit 2 is set whenever a digitized point is available.

When the point is available, it is read into the computer, and a sequence of beeps sent to acknowledge the point being taken. The Data Base is then updated.

```

OUTPUT "DF;SG" to Graphics Tablet
DO while you want to digitize
  BEGIN
    REPEAT
      OUTPUT "OS" to Graphics Tablet
      ENTER Status from Graphics Tablet
      UNTIL BIT 2 of Status = 1
      OUTPUT "OD" to Graphics Tablet
      ENTER X,Y from Graphics Tablet
      OUTPUT "BP20,100,3;BP22;BP24;BP26" to Graphics Tablet
      UPDATE Data Base
    END
  END

```

Digitizing P1 and P2

In HP graphics systems, scaling is available using P1 and P2 which can be read from the devices involved in a graphics system. The

2-4 Common Graphics Tablet Operations

following routine allows you to set the values for P1 and P2 by digitizing the appropriate points on the Platen.

The program below is actually two digitize point routines set up back to back. The first step is to set the single point mode (SG). Next a waiting loop is entered, and the point read as soon as it is available. An audible prompt is sent to acknowledge the point. This process is repeated for P2. The digitizing mode is then cleared and the values for X and Y of P1 and P2 are sent to the 9111A using the IP instruction.

```
OUTPUT "DF;SG" to Graphics Tablet,
OUTPUT "Digitize P1" to Prompt Screen
REPEAT
  OUTPUT "OS" to Graphics Tablet
  ENTER Status from Graphics Tablet
  UNTIL BIT 2 of Status = 1
  OUTPUT "OD" to Graphics Tablet
  ENTER X1,Y1 from Graphics Tablet
  OUTPUT "BP20,100,3;BP22;BP24;BP26" to Graphics Tablet
  OUTPUT "Digitize P2" to Prompt Screen
  REPEAT
    OUTPUT "OS" to Graphics Tablet
    ENTER Status from Graphics Tablet
    UNTIL BIT 2 of Status = 1
    OUTPUT "OD" to Graphics Tablet
    ENTER X2,Y2 from Graphics Tablet
    OUTPUT "BP20,100,3;BP22;BP24;BP26" to Graphics Tablet
    OUTPUT "DC;IP", X1,Y1,X2,Y2 to Graphics Tablet
```

Scaling

Having set up P1, and P2 in the above example, it would be nice for the computer to be able to use them for something. That brings up scaling.

Scaling is a mathematically simple operation. The most common form includes translation as well as scaling. The formulas used are:

$$\begin{aligned}x' &= ax + b \\y' &= cy + d\end{aligned}$$

where x' = the new x coordinate
 y' = the new y coordinate
 x = the original x coordinate
 y = the original y coordinate
 a = the x scaling factor
 c = the y scaling factor
 b = the x offset
 d = the y offset

The scaling factors are used to map the graphics tablet coordinate system into the user coordinate system. The limits of the Graphics Tablet coordinate system are found by reading P1 and P2 from the Graphics Tablet. The value for Xmin, Xmax, and Ymin, Ymax in your coordinate system must also be known.

Using Xmin, Ymin, Xmax, Ymax for the Graphics Tablet range and domain, and Xmin', Ymin', Xmax', Ymax' for your range and domain, the following algorithms produce a, b, c, and d.

SEND "OP" to 9111
 ENTER Xmin, Ymin, Xmax, Ymax from 9111
 Domain = Xmax - Xmin
 Range = Ymax - Ymin
 Domain' = Xmax' - Xmin'
 Range' = Ymax' - Ymin'
 $a = \text{Domain}' / \text{Domain}$
 $c = \text{Range}' / \text{Range}$
 $b = Xmin' - Xmin \star a$
 $d = Ymin' - Ymin \star c$



The determination of the scale and offset factors only needs to be done when your units are redefined. Once they are defined, simply plug the incoming data from the Graphics tablets into the scaling formulas to map the Digitizing Units from the digitizer into your units.

Cursor Tracking with Picks

In using the 9111A for data manipulation (as opposed to data entry) it is quite common to use a pointer on a CRT (or other

2-6 Common Graphics Tablet Operations

interactive device) to track the position of the stylus of the 9111A. Many cursor tracking applications also need to interpret "picks" (pen press) as controlling inputs to a program by interpreting the position of the stylus on a Menu. The 9111A has a set of softkeys along the upper edge of the platen. Menus can also be designed covering the entire active area of the platen, including the softkey area.

The following algorithm can call appropriate subroutines to interpret commands from the softkeys and menu data from the rest of the platen. First, the DF instruction is used to set the Graphics Tablet to a known state. Then the Single Point mode (SG) is selected. The computer then goes into a loop reading the stylus position and status information using an OC instruction. Each time the stylus position is read, a pointer is repositioned on the CRT to match the new stylus position. Bit 10 of the Status bit is then checked to detect a pen press, and the loop is exited if the pen is pressed.

Once a pen press is detected, Bit 2 of the Status word is tested to see if a point had been digitized (softkey selection overrides the digitize response). If a point has been digitized, the OD instruction is used to read the point, and a menu interpretation routine is called. If no point has been digitized, BIT 7 of the status word is tested. Bit 7 being set indicates a softkey selection. A softkey interpretation routine can then be used on the value returned by the RS instruction. If none of the above tests are passed, the program falls through to an error handling routine.

```
OUTPUT "DF;SG" to Graphics Tablet
DO while you want to read menu
  BEGIN
    REPEAT
      OUTPUT "OC" to Data Tablet
      ENTER X,Y, Pen, Key, Status, Error from Graphics Tablet
      MOVE POINTER to X,Y
    UNTIL Pen = 1
  IF BIT 2 of Status = 1
    THEN BEGIN
      OUTPUT "OD" to Graphics Tablet
```

Common Graphics Tablet Operations 2-7

```
ENTER X,Y from Graphics Tablet
OUTPUT "BP20,100,3;BP22;BP24;BP26" to Graphics Tablet
INTERPRET MENU (X,Y)
END
ELSE
IF BIT 7 of Status = 1
THEN BEGIN
OUTPUT "RS1" to Graphics Tablet
ENTER Key from Graphics Tablet
OUTPUT "BP20,100,3;BP22;BP24;BP26" to Graphics Tablet
INTERPRET COMMAND (Key)
END
ELSE Error in taking point
END
```

Many of these algorithms are implemented in the Graphics Languages available in HP mainframes. Check your Graphics Programming manual to see.

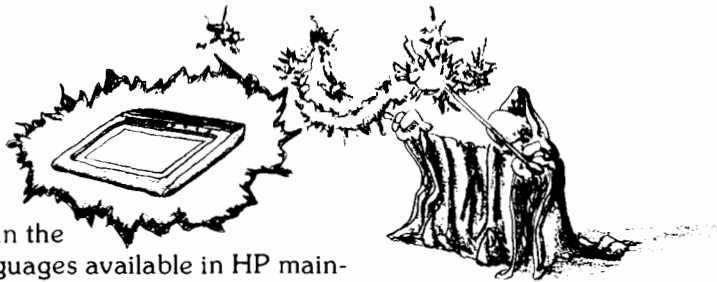

Theory of Operation



3-2 Theory of Operation

This Theory of Operation Section is a description of the Virtual Machine you will have to deal with to program the 9111A. It is a SOFTWARE model of the machine, not a hardware model. The details of the actual hardware used to implement the digitizing and other functions of the 9111 can be found in the Service Manual (Part number 09111-90030). Detailed descriptions of the Syntax and Semantics can be found in the Language Reference.

Register Diagram

This diagram shows the registers in the 9111A along with the interconnections for read and write operations and timing. Refer to this diagram during the explanation of the register model.

This Page Folds Out



Register Model

An operational model of the 9111A may be formed by looking at the internal registers. This model can provide considerable insight to programming the graphics tablet.

The register model presented below is a tool for programming. It reflects the internal workings of the Graphics Tablet only so far as a programmer is able to control and interact with the 9111 through the HPGL control language. A detailed description of the control language can be found in the Language Reference.

Position, Cursor, and Digitizing

The first process to look at is the actual position determination. A timing routine uses the contents of the **Data Rate** register to determine how often to check the position of the stylus.

Once the stylus position is determined, a test is made to see if the signal from the stylus was of sufficient amplitude to insure an accurate reading. The positional information is also checked to see if the raw data is consistent with itself. If these conditions are met and the **I/O** register is empty a binary representation of the stylus position and pen parameter is loaded into the output register to provide the default binary transfer. The **Cursor** register is then updated with the position of the stylus and the current physical pen status. Once the cursor is updated, the following conditions are checked:

1. Stylus within boundary
2. Digitize Mode Active
3. Valid digitize mode in **Digitize Mode** register
4. a — Pen Press if SG mode in effect
b — Actively Digitizing if CN mode in effect

If these conditions are all met, the **Digitize** register is updated with the new position, and a pen status bit derived from the physical pen bit and the contents of the **Switch Mode** register. (**Switch Mode** can contain SN for Switch Normal or SF for switch follow.

3-4 Theory of Operation

In Switch Normal the first pen press is a begin digitizing signal and the next pen press is an end digitizing signal. In Switch Follow points are digitized while the pen is depressed. In both modes the last point sent by an OD instruction will have a 0 pen parameter. Both switch modes work only in the Continuous [CN] mode.)

The **Digitize Mode** register can be set for SG (single) or CN (continuous) or for neither. If either mode is set, a DP instruction will be ignored. Otherwise the DP instruction will enable the digitizing mechanism to take a single point (this mode is cleared as soon as a single point is taken). This allows the 9111A to be compatible with digitizing programs written for the 9872A Plotter or the 9874A Digitizer.

NOTE

Support of the 9111A may be provided in a higher level language on your Hewlett-Packard mainframe. Check your mainframe Graphics System Manual (and the 9111A System Tutorial if it is available for your mainframe).

Working the Registers

Register Name	Range	Default	Modifying Instructions	Function
Data Rate	1-60	60	CR	Sets rate of cursor update (sets to default if no parameter is sent)
			IN,DF and HP-IB Device Clear	Sets Default Value.
Cursor X	@ -900 to @ 12900	0	OC	Reads Current Cursor values
Y	@ -900 to @ 10300	0	OC	Reads Current Cursor values
Pen	0-1	-	OC	Reads current cursor values. 0-1 is physical pen

NOTE

The contents of the **Key** register, the **Status** Register, and the **Error** register are all appended to the contents of the **Cursor** register when an OC instruction is received. See the OC instruction in the Language Reference for details.

Digitize				
X	-120 to 12152	-	OD	Reads Current digitize value
Y	-120 to 9115	-	OD	Reads Current digitize value
Pen	0-1	-	OD	Reads current pen values.
Digitize Mode	SG,CN,0	0	SG,CN	Selects Single (SG) or Continuous (CN) Mode.
			DP	Enables a single point to be taken (ignored if SG or CN mode is enabled)
			IN,DF,HP-IB Device Clear, DC	Clears Mode Register
Switch Mode	SN,SF	SN	SN,SF	Selects Switch Normal (SN) or Switch Follow (SF) digitizing mode
			IN,DF,HP-IB Device Clear	Selects Switch Normal mode



3-6 Theory of Operation

Menu

The Menu is controlled by the **Menu Switch** register, which enables or disables the operation of the menu reading routine. After a valid location is determined for the cursor, and once the pen has been pressed, the data is evaluated to determine if the stylus is in the menu area. If the point at which the pen was pressed lies in the menu area and the **Menu Switch** register is set to enable menu recognition, a menu selection is recognized. The **Key** register is then updated, and the appropriate bit in the **Status** register is set. The digitize response that would normally be generated by the pen press is suppressed if the menu selected response is generated.

Working the Registers

Register Name	Range	Default	Modifying Instructions	Function
Menu Switch	On, Off	On	RS<1,0>	Enables Menu (1) or Disables Menu (0)
Key	0-16		IN, DF, HP-IB Device Clear	Turns Menu On
			SK<any Param*>	Sets Key=0
			RS	Loads current value of Key into I/O buffer and then clears key register to 0
			IN, DF, HP-IB Device Clear	Sets Key to 0

* Typically 0

Errors, SRQ's, and Parallel Polls

The **E Mask**, the **S Mask**, and the **P Mask** are used to control what errors will be reported, when Service Requests are generated, and how the 9111A will respond to a parallel poll on the HP-IB. We'll look at the S and P Masks first.

The **S Mask** and the **P Mask** provide bit by bit mapping of the **Status** register. If a bit is set in the **S Mask**, and the corresponding bit in the **Status** register comes true, an SRQ is generated by the interface. The **P Mask** operates similarly, but sets the Parallel Poll bit true. (Both masks perform a logical AND of the bits in the mask with the bits in the **Status** register, and then a logical OR of the results of the ANDs.)

Notice in the block diagram that there are two status registers, one in the I/O block and one in the main structure of the 9111A. When an OS instruction is received, the internal **Status** register is accessed. When an HP-IB Serial Poll is executed, the **I/O Status** register is accessed. This is all as it should be, but there are two points to take note of.

First, the **Status** register contains 11 status bits, and the **I/O Status** register contains 8 bits. Obviously, some information is lost in mapping 11 significant bits into 8. The lower 8 bits (0-7) are copied from the **Status** register into the **I/O Status** register.

Second, notice that the contents are copied. The **Status** register contents are updated, and then copied into the **I/O Status** register as soon as possible. This process is not instantaneous, and it is possible to have a slightly different status in the **I/O Status** register (the response to a serial poll) than in the **Status** register inside the 9111A (response to OS).

In order to insure consistent status information, it is best to use either Serial Polls or OS instructions in a program, not both. This will make sure you are always following the same response path to obtain status information.



3-8 Theory of Operation

The **E Mask** works a little differently from the S and P masks. The **E Mask** corresponds to a $2^{(N-1)}$ representation of the error bit patterns, where N is the decimal value returned by the 9111A in response to an Output Error instruction (OE) for errors 1,2,3, and 7. Whenever an error whose bit is set true in the **E Mask** occurs, the **Error** register is updated, the error light comes on, and the Error bit in the **Status** register is set true.

To set the **E Mask**, the decimal value representing the bit pattern is set to the 9111A. Adding the decimal values for the appropriate errors (from the table below) will give the decimal value to be sent. A 0 masks all maskable errors.

Error Number	Error	Decimal Value
1	Bad Instruction	1
2	Wrong Number of parameters	2
3	Illegal parameter value	4
7	Inconsistent Raw Data	64

Self Test and System errors cannot be masked.

Working the Registers

Register Name	Range	Default	Modifying Instructions	Function
E Mask	0-32767	7	IM	Inputs decimal value equivalent to desired bit pattern
			IN,DF,HP-IB Device Clear	Sets S Mask to Default value
Error	0-110	0	OE	Output Error loads the contents of the error register into the I/O buffer.

S Mask	0-32767	0	IM	Inputs decimal value equivalent to desired bit pattern
			IN,DF,HP-IB Device Clear	Sets S Mask to Default value
P Mask	0-32767	0	IM	Inputs decimal value equivalent to desired bit pattern
			IN,DF,HP-IB Device Clear	Sets P Mask to Default value

Beeper

There are three registers associated with the Beep instruction (BP). The **Note** register determines the frequency of the tone produced by the beeper (See the Language Reference for correspondence between note numbers and musical tones). The **Duration** register determines how long the beeper will sound. The **Amplitude** register determines how loud the note will be. The beeper tone characteristics are determined by these registers. If any parameter is missing from the parameter list of a BP instruction, the current value of the register which that parameter normally controls is used to execute the beep. If 'BP' is received with no parameters, the beep is executed exactly as the last beep was.

Working the Registers

Register Name	Range	Default	Modifying Instructions	Function
Note	0-255	12	BP	Selects one of 49 notes from an even tempered musical scale
			IN,DF,HP-IB Device Clear	Sets to default value
Duration	0-32767	150	BP	Sets duration of the tone in milliseconds
			IN,DF,HP-IB Device Clear	Sets to default value

3-10 Theory of Operation

Amplitude	0-5	4	BP	Sets the amplitude of the tone in a pseudo-log scale
			IN,DF,HP-IB Device Clear	Sets to default value

Scaling Points

Hewlett-Packard Graphics Systems use two programmable points for scaling operations. These are stored in the **P1** and **P2** registers. The **P1** register contains the X and Y coordinates of the lower left corner of the platen area to be scaled, and the **P2** register the X and Y coordinates of the upper right corner. The Graphics Systems in HP Mainframes scale units from the 9111A so that P1 is Xmin, Ymin in Users Units, and P2 is Xmax, Ymax in Users Units.

Working the Registers

Register Name	Range	Default	Modifying Instructions	Function
P1				
X	+ / - 999999	400	IP	Sets new P1, P2 or resets default values if all parameters are omitted.
			IN,DF,HP-IB Device Clear	Sets to default values
Y	+ / - 999999	400	IP	Sets new P1, P2 or resets default values if all parameters are omitted.
			IN,DF,HP-IB Device Clear	Sets to default values
P2				
X	+ / - 999999	11632	IP	Sets new P1, P2 or resets default values if all parameters are omitted.
			IN,DF,HP-IB Device Clear	Sets to default values

Y	+ / - 999999	8340	IP	Sets new P1, P2 or resets default values if all parameters are omitted.
---	--------------	------	----	---

Resolution, Scale Factor, and Product ID

There are three 'read only' registers in the 9111A which contain descriptive data about the device. The **Resolution** and **Factor** registers contain constants describing the measuring units used by the 9111A. The **Resolution** register describes the distance between measuring units in millimetres. This reads out as 0.025 millimetres (25 microns), although the resolution of the 9111A is actually 0.100 millimetres (100 microns). Using 25 micron units of measure allows compatibility with the 9872 and 9874. The 9111A simply rounds the data to the nearest 100 microns, although the output is in terms of 25 micron units. The **Factor** register contains the number of measuring units per millimetre. Once again, there are four times as many measuring units per millimeter as there are resolvable points. The value of the **Factor** register is the inverse of the value of the **Resolution** register. The **Product ID** register contains the product Identification string.

Working the Registers

Register Name	Range	Default	Associated Instructions	Function
Resolution X,Y	-	.025	OR	Output Resolution (OR) loads the X and Y resolution values into I/O buffer
Factor X,Y	-	40	OF	Output Factor loads the X and Y Factors into the I/O buffer
Product ID	-	"9111A"	OI	Output ID Loads the ID string for the 9111A into the I/O buffer

Errors and What They Mean

There are three general classes of errors on the 9111A. The error numbers fall into three groups, depending on what phase of operation they may be encountered in. A binary code of the error number is flashed on the indicator lights during the error tone if an error is encountered during the self test.

The best method to determine the error number unambiguously is to send an OE instruction to the 9111 and then read the error number back.

9111A Error Numbers

User Generated (Maskable) Errors

These errors can be encountered during routine operation of the 9111, and are maskable errors. This means that they may be selectively masked to set the error flag in the status word, and to turn on the error light and set off the error tone.

1. Instruction not recognized.
Illegal instruction.
Instruction exceeded 45 characters (mnemonic + parameters + terminator, but excluding blanks and carriage returns)
OD sent with no valid digitizing mode in effect.
2. Wrong number of parameters
3. Illegal parameter value.
7. Inconsistent stylus location data.
(This generally indicates an exceptionally noisy environment, or a hardware failure. If the data is inconsistent once, no point is output. In order to generate this error, four points in succession must fail the consistency test.)

User Interaction Self Test Errors

These errors occur during the user interaction self test.

50. Illegal proximity signal at time of Self Test Request. (Is the stylus in the stylus tray? This could also indicate a faulty proximity testing circuit.)
51. Illegal pen press at time of self test. (Is pen pressed at the time the test is requested? Otherwise, the pen switch could be stuck or a lead in the cable shorted. Try replacing the cartridge, as a bent cartridge may bind in the stylus.)
52. Pen press detected before proximity detector indicates signal level is sufficient to make accurate measurement. (Platen could be dead, the stylus shorted, or the center conductor of cable open.)
53. Indicated position error. (You might have missed the Self Test Dot, or there could be a problem in the platen or stylus mechanism.)

Hardware Errors

Errors 100 to 110

Errors 100 to 110 may occur during the electronics self test. If you encounter one of them, write the number down. It can be of use to the service man.

User Interaction Self Test

You can initiate the User Interaction Self Test at any time to determine if the Graphics Tablet is operating properly. It can be performed according to the following procedure:

Place the stylus in the stylus tray (see photograph).

Flip the Self Test switch on the rear panel on and then immediately off. You should see all of the lights (except power) flash on and then off as the self test switch is turned on.

3-14 Theory of Operation

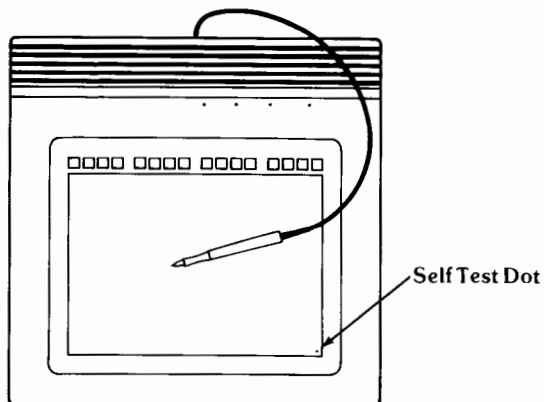

Shortly after the switch is turned off, the lights should flash again and the “hello” tone sequence should be heard. The “hello” sequence is heard whenever the Graphics Tablet is turned on. It consists of a sequence of musical tones of ascending frequency (C, E, and G, all in the octave below middle C.) This indicates that the 9111 has passed the Electronics Self Test.

Now remove the stylus from the stylus tray and digitize the Self Test Dot (the dot in the lower right hand corner of the platen — see the photograph above).

The “hello” sequence should be heard again. This indicates that the 9111 is ready to go.

The sequence above describes a Self Test in which every thing operates correctly. The Self Test can also be initiated by sending a TD instruction to the 9111. If this method is used, the first flashing of the indicator lights will not occur. **DO NOT ATTEMPT TO COMMUNICATE WITH THE GRAPHICS TABLET WHILE THE SELF TEST IS IN PROGRESS.**

Use the flowchart below for details on how the Self Test operates in the event of a failure.

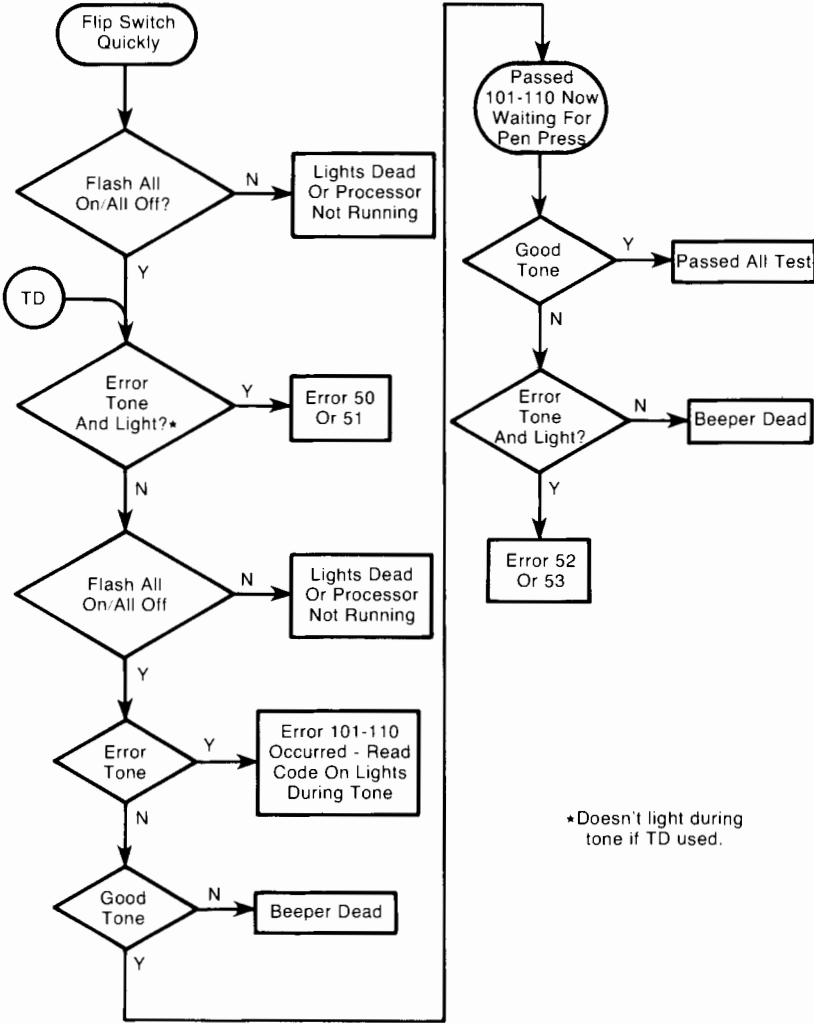

*Doesn't light during tone if TD used.

Self Test Flowchart

3-16 Theory of Operation

Continuous Self Test

While the self test described above locates numerous hardware failures, some errors (especially intermittent ones) are more difficult to track down. A continuous self test has been provided to find such errors. The continuous self test is activated by turning the self test switch on and leaving it on. The 9111 is then put in a continuous self test cycle. If an error is detected, the lights lock in the pattern representing the error, and the testing is halted. The error can be read by sending an OE instruction to the Graphics Tablet.

Interfacing



HP-IB

Overview of the HP-Interface Bus

The following is a definition of the terms and concepts used to describe the HP-IB (bus) system operations.

HP-IB System Terms

1. **Byte** — A unit of information consisting of 8 binary digits (bits).
2. **Device** — Any unit that is compatible with the IEEE Standard 488-1978.
3. **Device Dependent** — A response to information sent on the HP-IB that is characteristic of an individual device's design and can vary from device to device.
4. **Operator** — The person that operates either the system or any device in the system.
5. **Addressing** — The characters sent by a controlling device to specify which device will send information on the bus and which device(s) will receive that information.
6. **Polling** — The process used by a controller to locate a device that needs to interact with the controller. There are two types of polling.
 - **Serial Poll** — This method obtains one byte of operational information about an individual device in the system. The process must be repeated for each device from which information is desired.
 - **Parallel Poll** — This method obtains information about a group of devices simultaneously (one bit per device).

Interface Bus Concepts

Devices which communicate along the interface bus can be classified into three basic categories:

1. **Talkers** — Devices which are addressed to **send** information on the bus.
2. **Listeners** — Devices which are addressed to receive information on the bus.
3. **Controllers** — Devices that can specify the talker and listener for an information transfer. Controllers can be categorized as one of two types:
 - **Active Controller** — The current controlling device on the bus.
 - **System Controller** — The controller (which can be active or inactive) that can take priority control of the bus even if it is not the current active controller. Although each bus system can have only one system controller, the system can have any number of devices capable of being the active controller.

A typical HP-IB system is shown below.

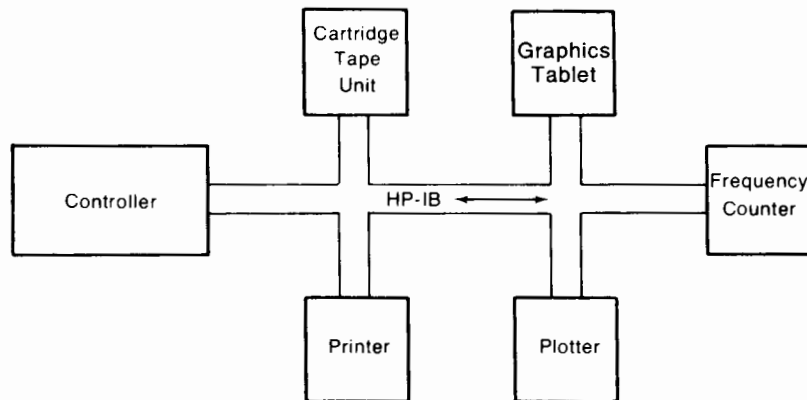

4-4 Interfacing

Message Concepts

Devices which communicate along the interface bus are transferring quantities of information. The transfer of information can be from one device to another device or from one device to several devices. These quantities of information can easily be thought of as “messages”. Typically, each message consists of two basic parts; the address specified by the controller and the information that comprises the message.

In turn, the message can be classified into one of twelve types. The twelve types of messages are defined as follows with the messages that pertain to the Graphics Tablet highlighted in color.

1. **The Data Message** — This is the actual information which is sent from one talker to one or more listeners along the interface bus. Data can be in numeric form, or can be a string of characters (typically ASCII).
2. **The Trigger Message** — This message causes the listening device(s) to perform a device dependent action, synchronized with the occurrence of this message.
3. **The Clear Message** — This message causes either the listening device(s) or all of the devices on the bus to return to their predefined device dependent states.
4. **The Remote Message** — This message causes the device to switch from local front-panel control to remote program control.
5. **The Local Message** — This message clears the Remote Message from the listening device(s) and returns the device(s) to local front panel control.
6. **The Local Lockout Message** — This message prevents a device operator from manually inhibiting remote program control.
7. **The Clear Lockout and Set Local Message** — This message causes all devices on the bus to be removed from **Local Lockout** and returned to **Local**. This message also clears the **Remote Message** for all devices on the bus.

8. **The Require Service Message** — A device can send this message at any time to signify that the device needs some type of interaction with the controller. This message is cleared when the device sends its **Status Byte Message** or if the device no longer requires service.
9. **The Status Byte Message** — A byte that represents the status of a single device on the bus. One bit indicates whether the device sent a **Require Service Message** and the remaining bits indicate operational conditions defined by the device. The byte is sent from a talking device in response to a serial poll operation performed by a controller.
10. **The Status Bit Message** — A byte that represents the operational conditions of a group of devices on the bus. Each device responds on a particular bit of the byte thus identifying a device dependent condition. This bit is typically sent by devices in response to a parallel poll operation performed by a controller. The Status Bit Message can also be used by a controller to specify the particular bit and logic level that a device will respond with when a parallel poll operation is performed. Thus more than one device can respond on the same bit.
11. **The Pass Control Message** — This transfers the bus management responsibilities from the active controller to another controller.
12. **The Abort Message** — The system controller sends this message to unconditionally assume control of the bus from the active controller. This message terminates all bus communications but does not implement a **Clear Message**.

These messages represent a full implementation of all HP-IB capabilities. Each device in a system, however, may be designed to use only the messages that are applicable to its purpose in the system. It's important for you to be aware of the HP-IB functions implemented on each device connected to your HP-IB system to ensure the operational compatibility of the system.

4-6 Interfacing

Graphics Tablet Bus Functions

Each device in an HP-IB system may be capable of using all or any portion of the messages just defined. A device's capabilities are grouped under 10 interface functions which are defined by the IEEE Standard 488-1978. The following table shows which messages the 9111A Graphics Tablet is designed to use.

Bus Message Implementation

Message	9111A Implementation
Data	Receive and Send
Trigger	Not Implemented
Clear	Receive
Local	Not Implemented
Remote	Not Implemented
Local Lockout	Not Implemented
Clear Lockout/Set Local	Not Implemented
Require Service	Send Only
Status Byte	Send Only
Status Bit	Send Only
Pass Control	Not Implemented
Abort	Receive Only *

* If a message from the 9111 is aborted while the terminating line feed of the message is in the I/O buffer in the 9111, the first character of the following message will be sent with EOI true.

Data Messages

The data message is the ASCII coded data sent and received by the 9111, and the binary data used for the default binary response. These messages are discussed in the Theory of Operation section and the Language Reference. Data messages other than the Default Binary Transfer Message are sent with a trailing Carriage Return and Linefeed with EOI true during the Line Feed. Carriage Returns and Spaces are ignored when received, and any character received with EOI true will terminate the message.

Clearing the Graphics Tablet

The Graphics Tablet may be cleared by three methods. An HP-IB Device Clear, or an HP-IB Selected Device Clear may be sent, or a DF instruction can be sent. Any of these methods will clear the current digitizing mode and any digitized point currently in the digitize register in addition to setting default parameters.

Aborting a Bus Transaction

An Abort message can be sent to the 9111. It will immediately halt the data transaction.

If the bus transaction sending the terminating linefeed from the 9111 is aborted with the linefeed still in the 9111's I/O buffer, the first character in the following message transmitted by the 9111 will be sent with EOI true. In fact, if the linefeed is not sent for any reason, the first character in the next message will be sent with EOI true. On any listening device that responds to EOI, this will terminate the data string with the first character.

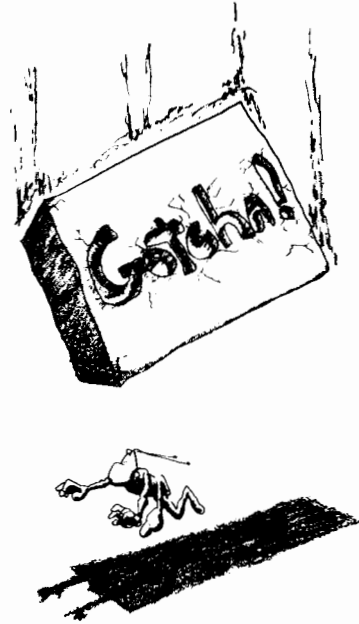

Parallel Poll

The parallel poll register in the 9111 may be configured to respond affirmatively to the poll for a number of reasons using the third parameter in the IM instruction to set the P mask. The same bit meanings applicable to the Status Mask apply to the P Mask. The bit which the Graphics Tablet responds to a parallel poll on is dependent on the setting of the switch which selects the HP-IB address for the unit. The response is always low affirmative (i.e.

4-8 Interfacing

negative true logic, where a low voltage indicates a true response).

Serial Poll

A Status Byte message is sent by the 9111 whenever a Serial Poll message is received. The Status Byte message consists of the lower eight bits (0 to 7) of the current status word in the 9111. The bits represent:

Bit 7	Bit 6	Bit 5	Bit 4	Bit 3	Bit 2	Bit 1	Bit 0
Menu Selected	SRQ Sent	Error	Ready	Initialized	Digitized Point Available	Always Clear	Always Clear

Service Requests

The 9111 can be set up to generate an SRQ by using the second parameter in the IM instruction. The SRQ is generated if any bit represented by a bit set true in the S Mask comes true in the Status Register.

Talk Only Mode

If the Graphics Tablet is set to the talk only mode (Address 31) it does not use the HP-IB addressing protocol. Instead, it responds to all initiated data transfers by outputting the Default Binary Cursor Response. This consists of 6 bytes of data, with the first two pair of bytes being a sixteen bit, twos complement (Most Significant Bit first) representation of the X and Y coordinates of the the cursor location, and the last sixteen bits containing the Status Word of the machine. The sixth byte in the sequence is always sent with EOI true, to allow confirmation of the synchrony of the data transfer.

HP-IB Worksheet

The Worksheet at the end of this chapter is provided for you to use in operating and programming devices in your HP-IB system. Each devices HP-IB implementation should be filled into an appropriate column on the form. For each of the 12 messages listed,

either an R (for receive only), an S (for send only), an SR (for Send and Receive) or an NI (for Not Implemented) should be lettered in the appropriate box to show each devices response to each message.

The Graphics Tablets response to the various HP-IB messages has been printed in the second column on the worksheet. The first column has been left blank for your controller. The remaining columns can be used for other devices connected to the bus.

Once the worksheet has been filled in for all the devices in your HP-IB system, you can use the information as an aid in programming your application. When your program makes use of an HP-IB message, you can read across the columns for that message and check that the appropriate devices have the necessary capability to respond properly to the message. The worksheet also helps you ensure that each device has a unique address code.

In addition, the back of the worksheet provides a place to list the status byte (serial poll) information for the devices in your system. The Graphics Tablet's status byte has been filled in for you. This information can be useful if you have any service request routines in your program applications on the HP-IB.



General Interfacing Considerations

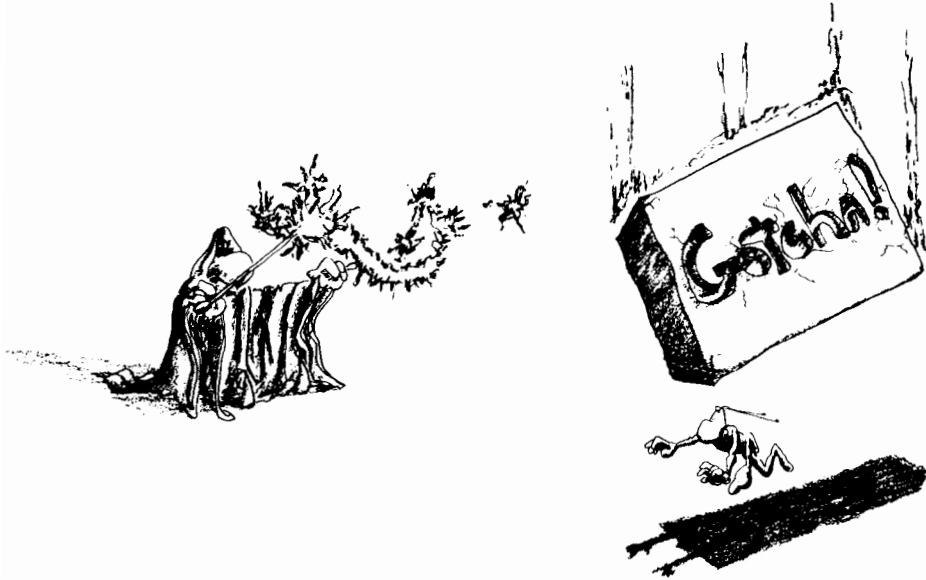

While the 9111 is a generally well behaved HP-IB device, there are a few anomalies in it's operation that you should know about when you try to program it. A few of the potential problems are listed below, along with some methods to program around them.

1. If two conditions that may occur simultaneously are set up to generate an SRQ, SRQ may be inhibited until all the conditions that are causing the SRQ are cleared.

The most common cause of this problem is setting the Graphics Tablet to send SRQ on Pen Pressed (Bit 9) and Digitized Point (Bit 2). This is commonly done to allow digitizing and menu reading in the same program. A better method is to use mutually exclusive conditions to generate the SRQ (such as Menu Selected and Digitized Point Available — Bits 7 and 2).

If bit 9 is programmed to generate SRQ, the controller must be able to keep up with the interrupt rate programmed in the Graphics Tablet. If your system should "lock up" when running a program that uses this configuration, simply lift the pen clear of the platen, which will remove the pen press (Bit 9) interrupting condition.

2. If the terminating linefeed in a Data Message from the 9111 is not read from the I/O Buffer, the first character of the following Data Message is sent with EOI true.

This only matters if your system responds to the EOI control line and terminates inputs on a Carriage Return. If your system does not recognize this line, it does not matter that the first character in a message is sent with EOI true.

If your system terminates communication on a character received with EOI true, make sure the Linefeed at the end of a Data Message is read in, even if it means programming a separate read operation on your system to do it.

3. If Serial Polls are being done repeatedly, it is possible for Bit 6 of the status byte to remain incorrectly set after one of them. This condition normally correct itself after $1/\text{Cursor Rate}$ seconds. However, if the beeper is being used, the correction can take the duration of the beeper operation for Bit 6 to be cleared.

Use either Serial Polls or SRQs, don't poll for one condition and interrupt for another.

4. If the controller takes control asynchronously and does not follow with an IFC message, the 9111 interface will be irreversibly locked up.

If your system locks up due to this, you must turn the 9111 off and restart it. To avoid the problem, simply program any controller in the system to send an IFC message after taking control asynchronously.

4-12 Interfacing

5. Binary information in the Default Binary Response can be old if the transfer is being paced by the controller. It can be as old as the time since the last data was received minus the period defined by the current value of the Cursor Rate.
By simply sending A CR-LF to the 9111, the buffer in the Graphics Tablet will be cleared of the old information and current position data will be available from the 9111.
6. While the interface is in the Serial Poll Active State (SPAS) the 9111 is "hung". No data gathering from the platen is possible. If the pen is moving, and the Serial Poll operation takes on the order of 10 milliseconds or greater, erratic position data may result.
7. If a Serial Poll occurs within 1 millisecond of other bus traffic, Bit 6 can fail to be cleared for 30 milliseconds.
This is only a problem if your controller can respond to an SRQ in less than 1 millisecond, and if your bus is large and configured for multiple interrupts. If so, always check the status of the 9111 to determine if it interrupted, and then go on to other devices in the system.
8. Following each serial poll conducted by the controller when SRQ is not asserted, there will be a 2.4 microsecond window during which a condition that would normally cause SRQ to be asserted will cause SRQ to go active and immediately return to inactive.

There are several methods to program around this.

- Do Serial Polls exclusively.
- Set system for SRQ on condition requiring attention from the controller, then do Serial Poll to determine device generating the SRQ.
- Do an OS while awaiting the SRQ.
- Do OC and look at the status that follows the pen and menu data after the location.
- Use the Default Binary Response while waiting for an SRQ.

9. During a beep, only the Busy and Ready bits in the Parallel Poll register are updated. No data can be obtained during a beep. Pen press may be lost during a long beep.
Your programs must be designed with the knowledge that the Graphics Tablet is essentially "dead" during a beep.
10. If a Serial Poll is interrupted by a Parallel Poll while the interface is in SDYS, incorrect data can be sent in response to the Serial Poll.
This can be avoided by using OS instead of the Serial Poll whenever the system is using Parallel Polls to look for interrupting devices.

Interfacing Notes

HP 1000

Communication between the 9111 and HP 1000 computer can be accomplished in two principle ways — free format ASCII and binary data transfer. Details concerning the READ and WRITE statements (for ASCII communication) can be found in "The HP-IB in HP 1000 Systems User's Manual" (P/N 59310-90064) and in "HP 1000/HP-IB Programming Procedures", Application Note 401-1, available from:

Hewlett-Packard Company
Sales Literature Center
1820 Embarcardero Rd
Palo Alto, CA 94303

A sample FORTRAN program to input X, Y, and Status information from the 9111, using the Default Binary Transfer is given below:

```
FTN4  
PROGRAM SAMPLE  
INTEGER I(3)  
EXTERNAL REIO
```

4-14 Interfacing

```
10  CALL REIO (1,34+2100B,I,3)
    WRITE (1,50) I(1),I(2),I(3)
    GOTO 10
50  FORMAT (317)
    END
```

In the Call to the system utility REIO, the logical unit (LU) of the 9111 is 34. The 2100B is added to the LU of the device in order to handle binary data input without terminating on a Carriage Return or Line Feed bit pattern. The 3 indicates three words of data to be input to the array I. The WRITE statement sends the X, Y and Status to a device at LU 1 (normally a terminal).

HP 85

The HP 85 Printer/Plotter ROM provides high level language support for the 9111A. This support is the same as that provided for digitizing with HP plotters. To access this support, declare the 9111 as the system plotter:

```
PLOTTER IS 306
```

This assumes the HP-IB interface card select code is set to 3 and the Graphics Tablet address is set to 6.

After this declaration is made, the normal graphics statements are available for use with the 9111A. Particularly useful are:

```
LIMIT
SCALE
CURSOR
DIGITIZE
```

Consult the HP 85 Printer/Plotter ROM manual (Part number 00085-90140) for details. Features that are not supported directly by the graphics statements in the ROM may be accessed by declaring the 9111 as a printer and printing to it.

```
PRINTER IS 306
PRINT "BP20,1000,5"
```

The HP 85 I/O ROM can also be used to communicate with the 9111 to access features which are not supported in the Printer/Plotter ROM.

```
OUTPUT 306; "RS"  
ENTER 306;S
```



HP-IB Polling Information Worksheet

Bit Significance	MSB							LSB	P P a o r l a l l B e i l t
Bit Position	7	6	5	4	3	2	1	0	
Decimal Value	128	64	32	16	8	4	2	1	
Status Byte (Serial Poll) Information									
Device Address Code	9111A	Menu Selected	6	SRQ Sent	Error	Ready	Initialized	Digitized Point Available	Always Clear
Device Address Code									
Device Address Code									
Device Address Code									
Device Address Code									
Device Address Code									
Device Address Code									
Device Address Code									
Device Address Code									
Device Address Code									



Language Reference



Language Reference

9111A Instruction Set

The instruction set for the 9111A Graphics Tablet consists of 27 Hewlett-Packard Graphics Language (HPGL) instructions. Each instruction is a two-letter mnemonic which can be either upper or lower case. Depending on the instruction, some of the mnemonics allow numeric parameters. If more than one parameter is allowed with an instruction, the parameters must be separated with a comma. Spaces and carriage return (CR) characters within the data string are ignored by the graphics tablet.

Data transfer to and from the graphics tablet is in 8-bit ASCII code. Data placed on the bus by the graphics tablet is terminated with the carriage return/linefeed (CR/LF) characters. Parameters within the data string are separated with a comma. Instructions received by the graphics tablet must be terminated with a linefeed (LF) character, semicolon (;) or the HP-IB END method. Data termination is discussed next.

Data Termination

The graphics tablet responds to three types of data (instruction) termination. The three types are explained next. See your controller manual for the output format of your controller.

1. Whenever the graphics tablet receives a data string followed by a linefeed character (ASCII decimal 10), the data is interpreted as a complete instruction (two letter mnemonic with any allowable parameters). Any additional data characters received by the graphics tablet are interrupted as another instruction. HP Desktop Computers generate the CR/LF characters internally for the control of peripheral devices. This is an operating system function and to avoid the output of these characters you must specify certain formats (see the operating manual for your computer for more information on its output format).

2. Whenever the graphics tablet receives a data string followed by a semicolon (ASCII decimal 59) character, the data is interpreted as a complete instruction (two letter mnemonic with any allowable parameters). Any additional data characters received by the graphics tablet are interpreted as another instruction. The semicolon character is available on the keyboard of the HP Desktop Computers and must be typed in along with the graphic tablet instruction.
3. HP-IB END refers to a third method of data termination available with the graphics tablet. This method uses the EOI (end of identify) interface signal line in conjunction with the last character in the data string. If EOI is set true (signal condition) prior to the graphics tablet receiving the last character in a data string, the last character serves its initial function (mnemonic or parameter) as well as acting as the data terminator.

NOTE

HP-IB END is a method of termination involving hardware as well as software functions. See the IEEE Std. 488-1978 for more information on this method.

HPGL Compatibility

The graphics tablet HPGL language differs from the 9874A's (HP Digitizer) language in the following respects:

1. Any instruction with more than one allowable parameter can have any parameter change without re-specifying the other parameters again. See the following example.

Assuming we have specified Input Points to be the following values.

IP 600,600,11000,8000

5-4 Language Reference

Later we need to re-specify IP. We want to change the 11000 to 8000. This can be done by just specifying the 8000 as shown next.

IP,,8000

With the 9874A Digitizer you had to re-specify each parameter whether it changed or not. The graphics tablet allows you to specify just the parameter you want to change providing you position it through the used of commas.

2. The IP instruction sent to the graphics tablet without parameters sets IP to default. Default for Input Points is 400,400,11632,8340.

Sending "IP,,," does not change the current existing values for Input Points.

3. The binary transfer is unique to the graphics tablet. This is a (controller read initiated) binary output mode for fast data transfer. See the section titled "Binary Data Transfer" in this syntax section.

Methods Used to Represent Syntax

This syntax section uses two methods of representing the instruction set for the graphics tablet. The conventions of each form are as follows.

Pictorial Representation

All items bolded and enclosed by a rounded envelope must be received by the graphics tablet exactly as shown (e.g., Mnemonics, Commas and Semicolon). Items in lighter text and enclosed by a rounded envelope refer to a termination character or termination method (e.g., Linefeed and HP-IB END). Items enclosed by rectangular boxes are names of parameters used in the instruction. A description of each parameter is given in the text following the drawing. Instruction elements are connected by lines. Each line can only be followed in one direction, from left to right. Any combination of instruction elements that can be generated by following the lines in the proper direction is syntactically

correct. An instruction element is optional if there is a valid path around it. This form of syntax representation is easy to use, and in some cases, more formally correct than the alternate form described as "Linear Representation" which follows the next example.

The Beep instruction syntax is presented next. It is highlighted three different ways. The accompanying text describes the highlighting as well as what the graphics tablet needs to receive if this example were actually encountered.

I need to program that certain sound, but I don't know the parameters. I'll start by sending BP with default parameters. Default parameters are 12,150,4.

This is the path on the graphic representation that I'll follow.

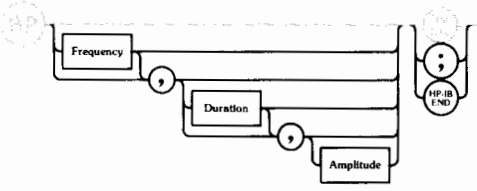

This is what the graphics tablet needs to receive.

BP Linefeed



5-6 Language Reference

Oh No! That's the wrong frequency; its not long enough and its too loud. I'll change all the parameters. I'll send note "A" above middle C (value 33), specify a duration of 1 second (value 1000), and soften the tone a little (value 3).

This is the path on the graphic representation that I'll follow.

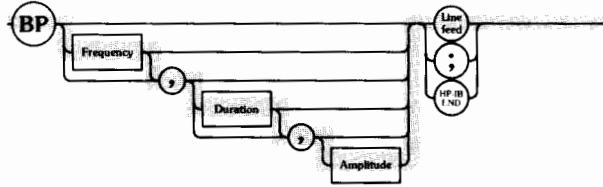

This is what the graphics tablet needs to receive.

BP33,1000,3 Linefeed

That's it; no, its still too loud. I'll soften the tone just a little. Now I don't want to change the other parameters so I need to send a comma specifying the place for both the frequency and duration parameters. This causes the graphics tablet to use the last specified parameters. Then I'll send a 2 for the amplitude.

This is the path on the graphic representation that I'll follow.

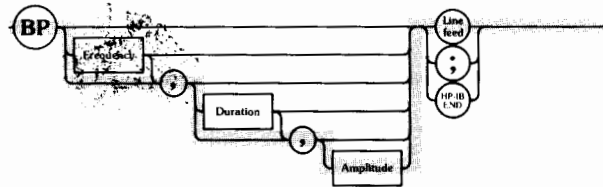

This is what the graphics tablet needs to receive.

BP,,2 Linefeed

That's the tone I want to hear.



Linear Representation

This form of syntax representation is included to be compatible with previous HP manuals. Many user's are accustomed to seeing this form. If both forms are new to you, it is recommended that you concentrate on the Pictorial form.

Bold Type : All items shown in **bold** type must be received by the graphics tablet exactly as shown. The one exception is that the mnemonics can appear in lower case characters.

[]: Items within square brackets are optional. If the optional items are used, the comma must precede the second, third, and fourth items in the optional list.

| : A vertical line between two items reads as "or"; only one of the items may be included.



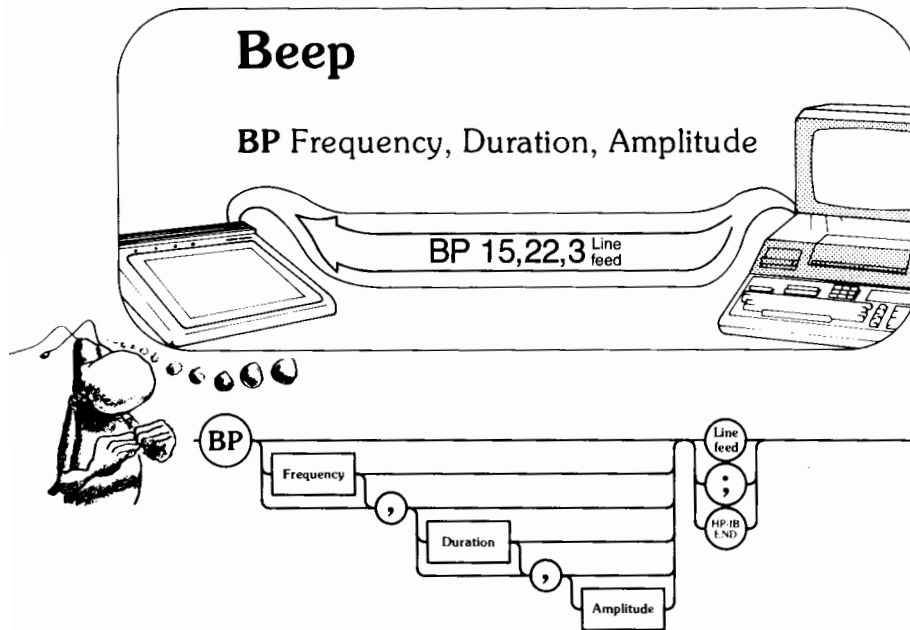

BP [Frequency][, Duration][, Amplitude]
Linefeed | ; | HP-IB END

This instruction generates the graphics tablet's internal tone. Three parameters (frequency, duration, and amplitude) are allowed with this instruction.

Frequency

Values 0 thru 48 produce notes of increasing pitch on an even tempered musical scale, with 0 representing C two octaves below middle C (frequency of 130.81 Hz) and 48 representing C two octaves above middle C (frequency of 2093.0 Hz). The following formula can be used to determine the approximate frequency generated by the values 0 thru 48:

frequency in hertz = 1.0595^N multiplied by 130.81Hz

the power N = the parameter value (0 thru 48)

130.81 Hz = the frequency of C represented by the value 0

Parameter values of 49 thru 255 are accepted, but produce the same pitch as 48. The following table shows the parameter values and corresponding notes.

	Note	N	Note	N
	C	48 to 255		
	B	47	A#,Bb	46
	A	45	G#,Ab	44
	G	43	F#,Gb	42
	F	41		
	E	40	D#,Eb	39
	D	38	C#,Bb	37
	C	36		
	B	35	A#,Bb	34
	A	33	G#,Ab	32
	G	31	F#,Gb	30
	F	29		
	E	28	D#,Eb	27
	D	26	C#,Bb	25
	C	24		
	B	23	A#,Bb	22
	A	21	G#,Ab	20
	G	19	F#,Gb	18
	F	17		
	E	16	D#,Eb	15
	D	14	C#,Bb	13
	C	12		
	B	11	A#,Bb	10
	A	9	G#,Ab	8
	G	7	F#,Gb	6
	F	5		
	E	4	D#,Eb	3
	D	2	C#,Bb	1
	C	0		

Duration

Duration (length the tone is generated) is specified in milliseconds. The values accepted are 1 thru 32 767. 32 767 milliseconds specify almost 33 seconds of the tone generation.

Amplitude

Values 0 thru 5 are accepted. 0 gives no tone whereas 1 gives a soft tone and 5 gives the loudest tone.

BP 12, 150, 4 is in effect at power on and reset. If the **BP** instruction is received without parameters, the tablet beeps using the last specified values for frequency, duration, and amplitude. Spaces and carriage return characters contained within the **BP** instruction are ignored by the graphics tablet.

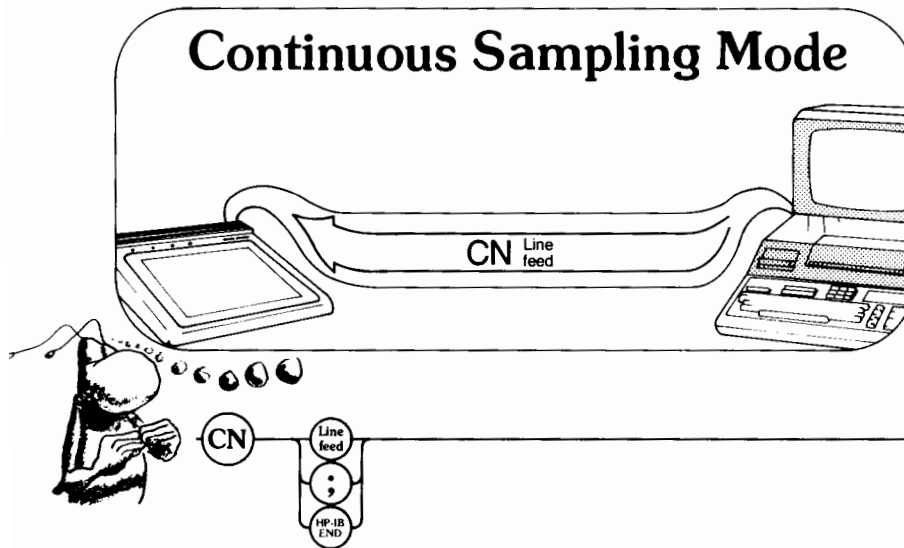

CN Linefeed | ; | HP-IB END

The CN instruction sets the graphics tablet's continuous sampling mode. Once the CN mode is selected data sampling is controlled by the digitize switch contained within the stylus. Pressing the pen tip firmly against the graphics tablet's active surface initiates continuous digitizing. To stop the continuous digitizing the pen tip must again be firmly pressed against the tablet's active surface.

The digitizing mode described above is the continuous sampling mode with the stylus digitizing switch set to switch normal (SN). This toggling mode of the digitize switch is the default mode when CN is specified.

The SN and SF instructions allows you to program the response of the digitize switch.

The stylus digitize switch has an alternate mode which is specified using the SF (switch follow) mnemonic. When the SF condition is

specified, the continuous digitizing is initiated only when the stylus pen is firmly pressed against the tablet's active surface. When the downward pressure is lessened causing the stylus digitize switch to open, continuous digitizing is stopped.

The mnemonics SF or SN can be specified at any time relative to setting the CN mode. The graphics tablet remembers a digitize switch condition specified prior to receiving a CN instruction.

CN [$\Delta t, \Delta D$]

For compatibility reasons the graphics tablet allows two parameters with the CN instruction. The parameters are accepted, but not acted upon.

A recommended sequence for the use of the CN instruction follows:

- Set the CN mode.
- Set the digitize switch mode (SF or SN).
- Check bit 2 of the tablet's status.
- If bit 2 is set, send OD and read X,Y, and pen data.
- If bit 2 is not set, keep checking bit 2.

When a point is digitized, bit 2 is set.

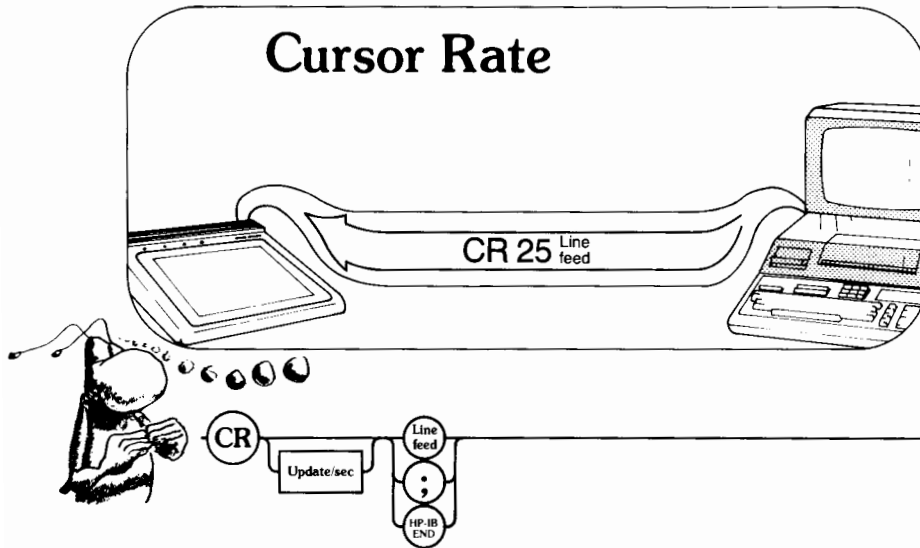

CR [update/sec] Linefeed | ; | HP-IB END

This instruction allows you to specify the data rate of the continuous sampling mode. CR allows you to control the number of data points going into your data base via time control. Another use for the instruction would be to establish or eliminate a stylus cursor lag (time delay between the stylus from the graphics tablet and a CRT cursor).

The values 1 thru 60 are the accepted parameter range and correspond to updates per second.

Specifying a CR with no parameters sets the default value which is 60 updates per second.

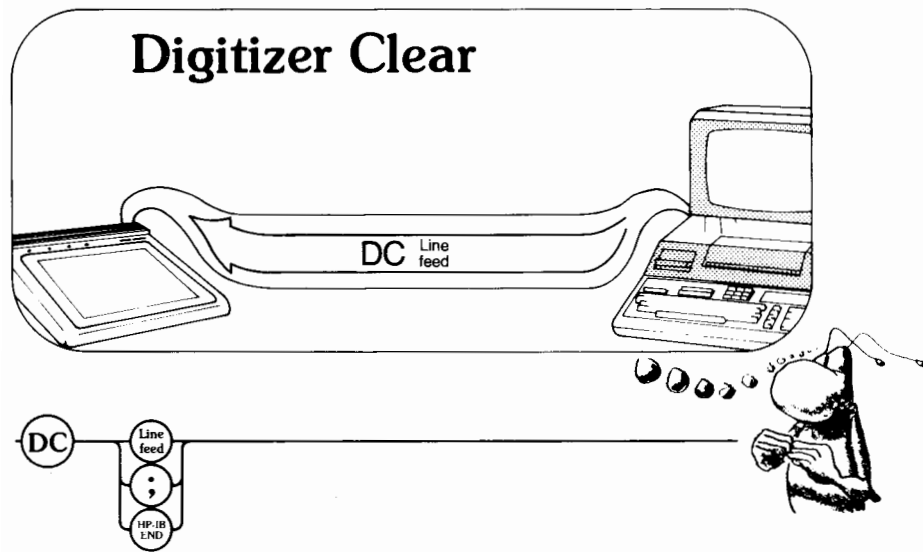

DC Linefeed | ; | HP-IB END

The digitizer clear instruction clears the modes set by the following mnemonics: DP, SG, CN. In addition to clearing these modes, any digitized point coordinates are cleared as well as bit 2 of the status byte.

5-14 DF

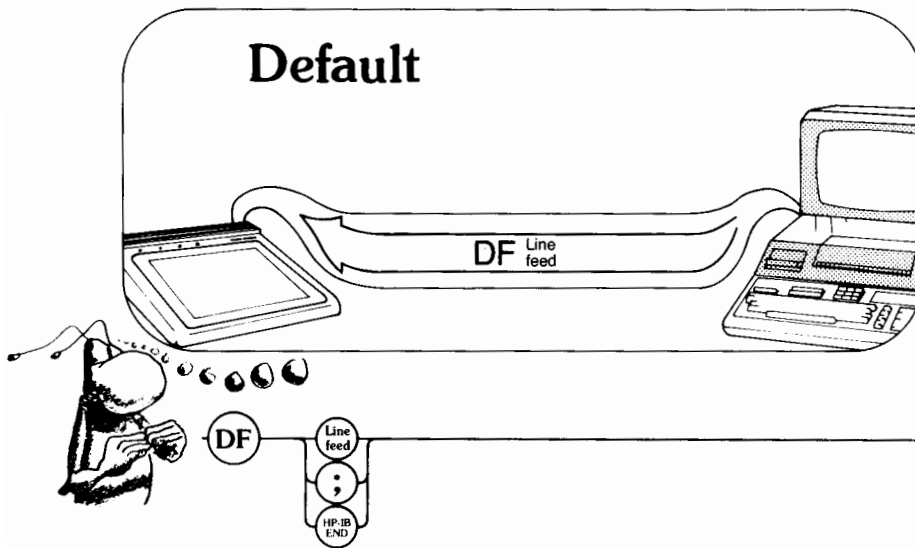

DF Linefeed | ; | HP-IB END

The DF instruction sets the graphics tablet to a predetermined power-on state.

The following conditions are set by the default instruction.

Condition	Default	Set Value
Cursor Sample Rate		60/second
E Mask		7
S Mask		0
P Mask		0
Status Byte		16 (Bit 4 is set)
Menu Area		On
Menu Item		0
Digitizing State (CN or SG)		None
Stylus Digitize Switch		Switch Normal Mode

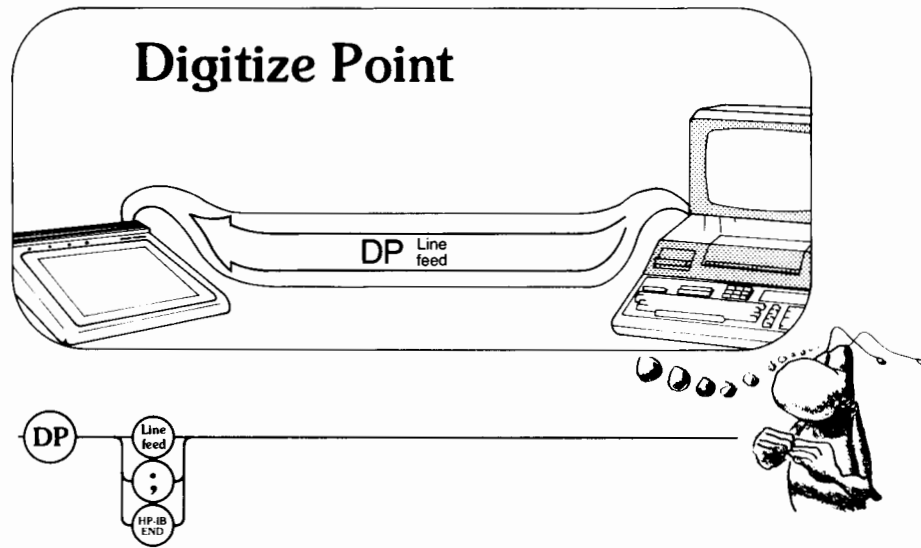

DP Linefeed | ; | HP-IB END

The digitize point instruction prepares the graphics tablet to recognize the next pen press as a digitized point. The digitize LED is illuminated. This instruction is used without the continuous or single sampling mode. If a CN or SG mode is set the DP instruction is ignored.

DP is a single point digitizing instruction that is compatible with the digitizing operation provided on some HP plotters. A suggested implementation using DP is shown next.

- Clear the graphics tablet using DF.
- Set the DP mode.
- Check bit 2 of the tablet's status.
- If bit 2 is set, send OD and read X,Y, and Pen data.
- If bit 2 is not set, keep checking bit 2.

Bit 2 is set when a point is digitized.

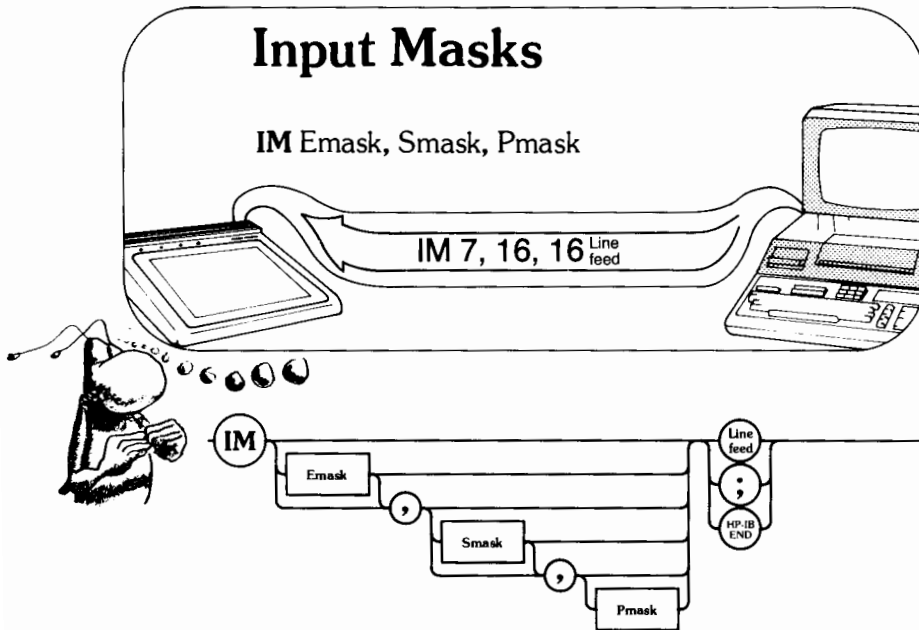

`IM[E-mask][,S-mask][,P-mask]Linefeed | ; | HP-IB END`

The input mask instruction is used by your controller to selectively enable the following: the recognized errors, the status conditions that can cause a service request, and to select status conditions that cause a response from a parallel poll.

Error Mask

The summed value of the errors that you want to enable is specified. See the error mask table.

The default error mask is 7.

Value	Bit	Error Mask Error
0	0	No Error
1	1	Instruction not recognized, instruction exceeded 45 characters, or OD sent with no digitizing mode in effect.
2	2	Wrong number of parameters
4	3	Illegal parameter value
64	7	Inconsistent Stylus Location Data

Status Mask

The S-mask value specifies the status byte conditions that can send the require service message (interface line SRQ). The S-mask value is the decimal equivalent sum of the bit values of the selected status-byte bits. See the following table.

Status Mask		
Bit Values	Status Bits	Meaning
1	0	Always Clear
2	1	Always Clear
4	2	Digitize Point Available
8	3	Initialized (Completed Power On Self Test)
16	4	Ready (Completed Power On Self Test, User Self Test, or Beep Instruction)
32	5	Error
64	6	SRQ Sent
128	7	Menu Selection
256	8	Proximity
512	9	New Cursor Information Available
1024	10	Pen Switch is Pressed

Parallel Poll Mask

The parallel poll response bit is determined through the selection of the addresses switches. See the next table. An affirmative parallel poll response is enabled by the P-mask matching the status word, and is programmed using the same techniques as the S-mask (see table above).

Parallel Poll	
Decimal Value Returned	HP-IB Address
128	0
64	1
32	2
16	3
8	4
4	5
2	6
1	7
0	

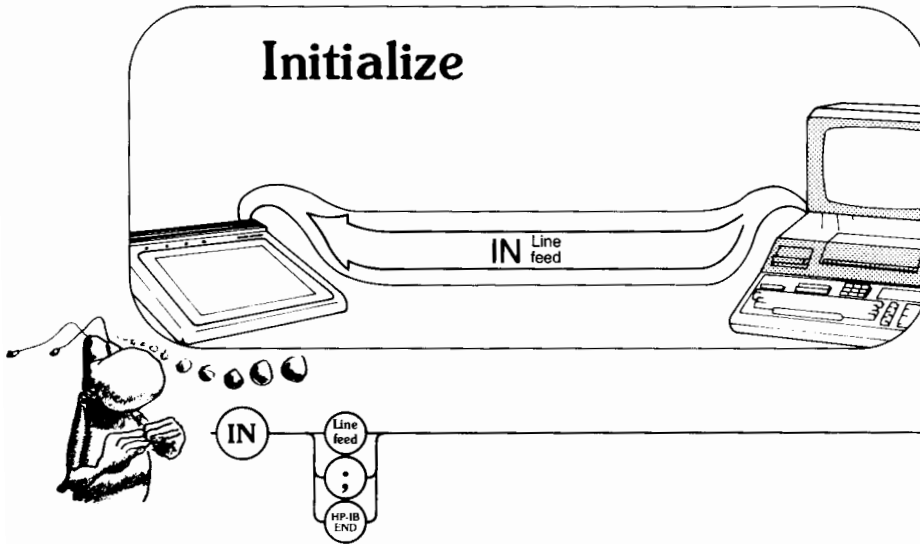

IN Linefeed | ; | HP-IB END

The initialize instruction performs the self test and then sets the graphics tablet to its power-on condition.

The following conditions exist after the graphics tablet is initialized:

Condition	Set Value
Sample Rate	60/second
E Mask	7
S Mask	0
P Mask	0
Status Byte	16 (Bit 4 is set)
Menu Area	On
Menu Item	0
Digitizing State (CN or SG)	None
Stylus Digitize Switch	Switch Normal Mode
P1 and P2 Values	<u>P1</u> <u>P2</u> 400,400 11632,8340

It is recommended that you always follow the IN instruction with the DF instruction when you are using the binary data transfer mode.

Input Points

IP P1X, P1Y, P2X, P2Y

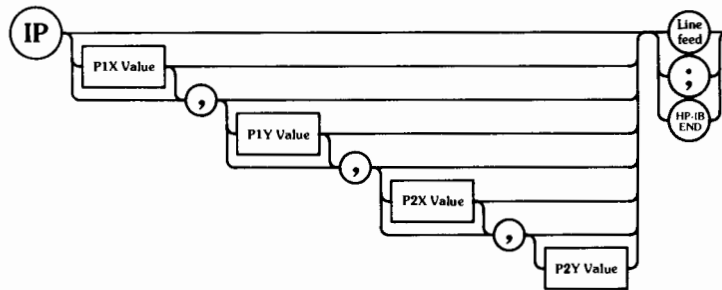
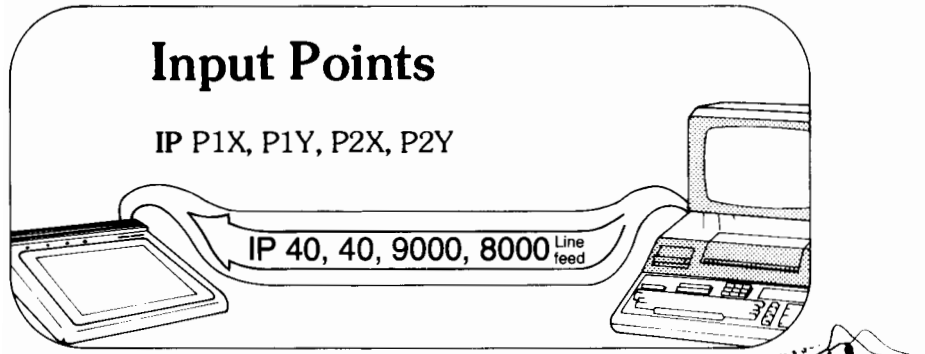

IP[P1 X][, P1 Y][, P2 X][, P2 Y] Linefeed | ; | HP-IB END

The input points instruction causes the graphics tablet to store four values specified by your controller program. These values can then be output for scaling purposes.



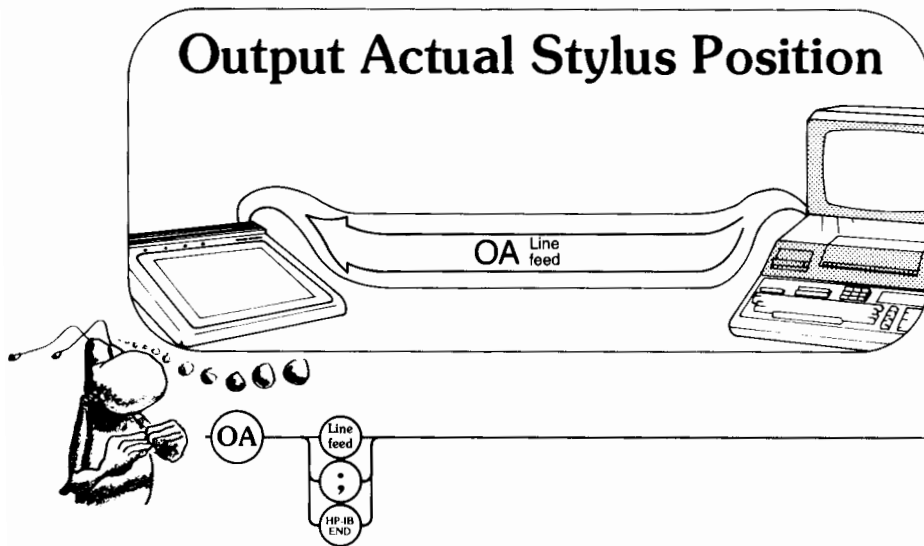

OA Linefeed | ; | HP-IB END

This instruction is the same as the OC. It causes the graphics tablet to output the last known X, Y, Pen, Menu Selection, Status, and Error information. See the OC instruction.

The return parameters and output format is shown next.

XXXXX	,	XXXXX	,	X,	XX,	XXXX,	XXX	CR/LF
<u> </u>		<u> </u>		<u> </u>	<u> </u>	<u> </u>	<u> </u>	
X value		Y value		PEN	MENU	STATUS	ERROR	

A recommended sequence using the OA instruction is presented next.

- Set digitizing and digitize switch mode.
- Check bit 2 of the tablet's status.
- If bit 2 is set, send OA and read the X,Y, and Pen data.
- If bit 2 is not set, keep checking until it is set.

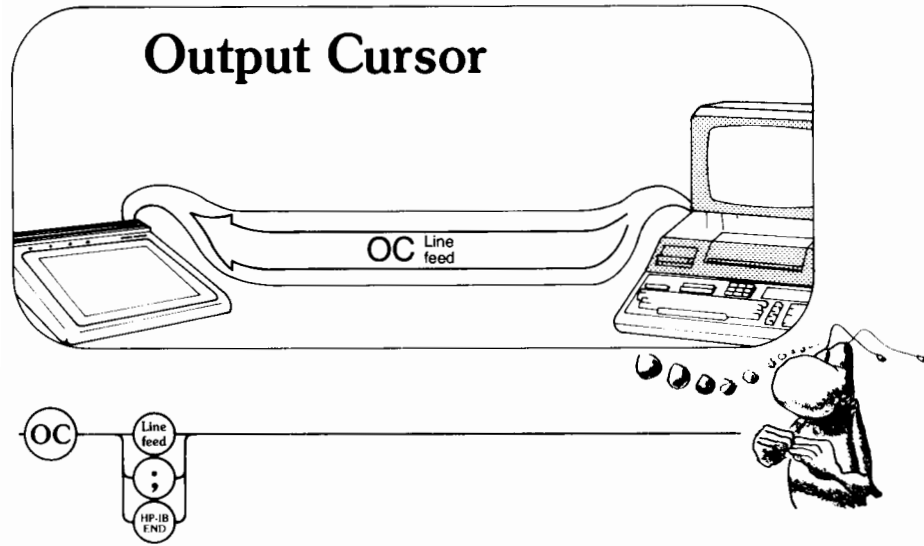

OC Linefeed | ; | HP-IB END

This instruction sets up the graphics tablet to output the following information: X, Y, PEN, MENU, STATUS, and ERROR. The next instruction to the graphics tablet (from the controller) is expected to be a controller input instruction. It is not necessary to read all parameters into your controller. The OC parameters (output and format) is shown next.

<u>X value</u>	<u>Y value</u>	<u>PEN</u>	<u>MENU</u>	<u>STATUS</u>	<u>ERROR</u>	
XXXXX	,	XXXXX	,X,	XX,	XXXX,	XXX CR/LF

The parameters X, Y, and ERROR are output using a variable length format. The X and Y values can have maximum character field of 5 characters and a minimum field of one character. Smaller numbers (1 or 2 digits) can possibly contain a minus sign if you are digitizing in the lower left hand corner.

5-22 OC

The error value can have a maximum of three characters and a minimum of 1 character.

The pen value is a fixed one character field.

The key and status parameters are fixed in length (key = 2 characters, status = 4 characters) and can contain leading zeros.

The parameters are each separated with a comma and the entire output string is terminated with a carriage return and linefeed.

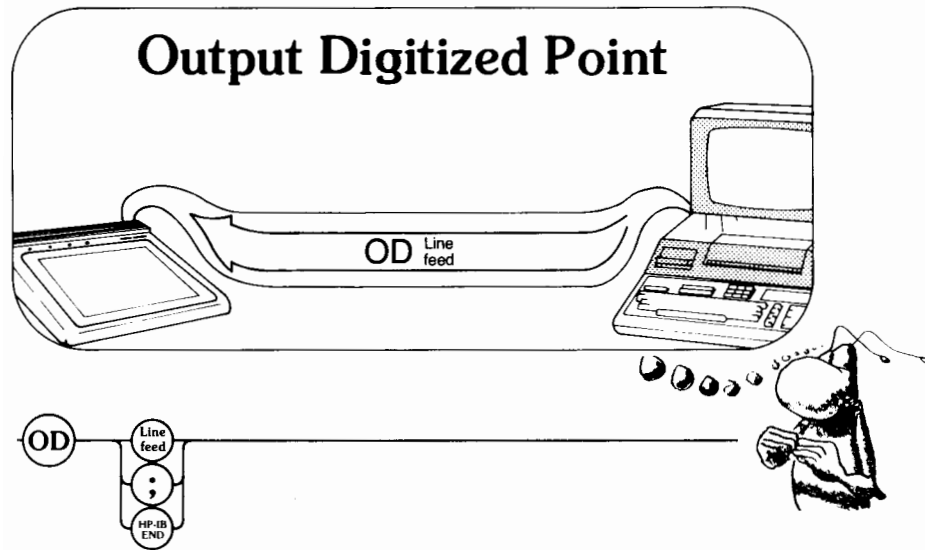

OD Linefeed | ; | HP-IB END

The output digitized point instruction reads the graphics tablet to output the known stylus position. The next instruction to the graphics tablet is expected to be a controller input instruction. The following parameters are available with the OD instruction. It is not necessary to read all the parameters into your controller.

<u>X value</u>	<u>Y value</u>	<u>PEN</u>	
XXXXX	,	XXXXX	,
		X	CR/LF

The X and Y values are output in a variable length field. The field can vary from 5 ASCII characters down to 1 character. Digitizing in the extreme lower or left platen area can cause a minus sign to be sent over with the data.

The pen parameter is a single character field. This character will always be a one or a zero.

5-24 OD

When digitizing in the CN (continuous) mode, each point will have a pen parameter of one except the final (or last) point. This last point will always have a parameter of 0.

Digitizing in the SG (single) mode, the pen parameter will always be a one.

The output digitized point (OD) instruction is designed to be used with bit 2 of the status byte. The suggested implementation is shown next.

- Set digitizing mode (CN or SG).
- Check bit 2 of the tablet's status.
- If bit 2 is set, send OD and read the X, Y, and PEN Data.
- If bit 2 is clear keep checking until it's set.

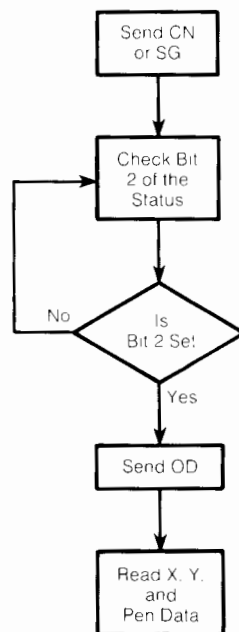

When the graphics tablet receives the CN or SG instruction, the green "Digitize" LED will light. The graphics tablet is now ready to take a point. When a point is digitized, bit 2 of the tablet's status is set to 1. To digitize a point place the stylus tip on the tablet's active surface and press enough to energize the digitize switch. Once bit 2 is set then the OD instruction is sent to the tablet and the controller can read the X, Y, and PEN data.

If OD is received by the graphics tablet and bit 2 of the status byte is not set, the graphics tablet takes control of the HP-IB control lines and stops further data communication until bit 2 is set. System I/O communication is halted until a point is digitized. It is recommended that you not try using this mode of operation if the S mask is set to generate an SRQ (interrupt) on bit 2 of the status byte.

If OD is received by the graphics tablet and a digitizing mode (DP, SG or CN) is not set, the following controller input instruction receives the following data: X = 0, Y = 0, PEN = -1. Error 1 is also generated.



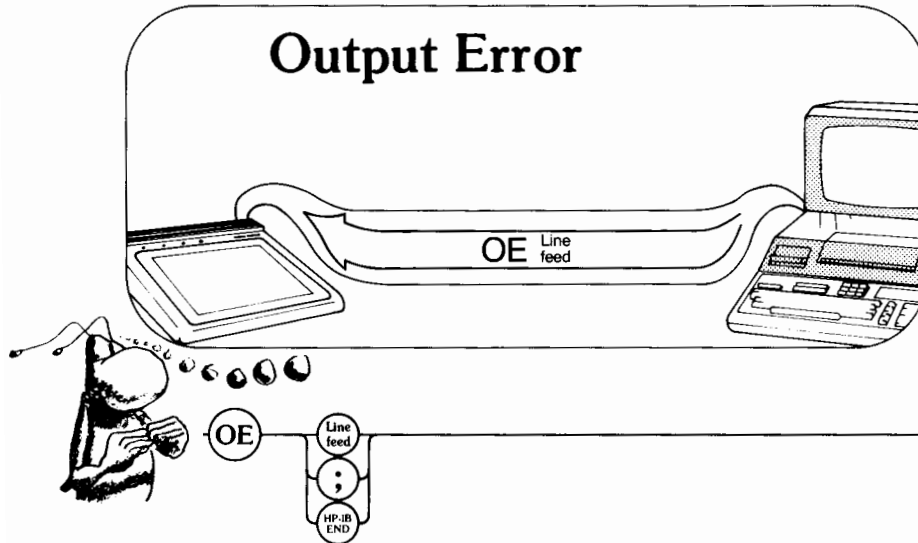

OE Linefeed | ; | HP-IB END

The OE instruction reads the graphics tablet to output its current error condition. With the next controller input instruction (addressed to the graphics tablet), this current error condition is output. The graphics tablet's errors values and meaning are listed next.

Values	Error Meanings
0	No error
1	Instruction not recognized, instruction exceeded 45 characters, "OD" received with no digitizing mode set.
2	Wrong number of parameters
3	Illegal parameter value
7	Inconsistent Stylus Location Data

When an error is generated, bit 5 of the status byte is set. Bit 5 is cleared when the graphics tablet receives the "OE" instruction. Of course, the next instruction to the graphics tablet is expected to be the controller input to receive output error data.

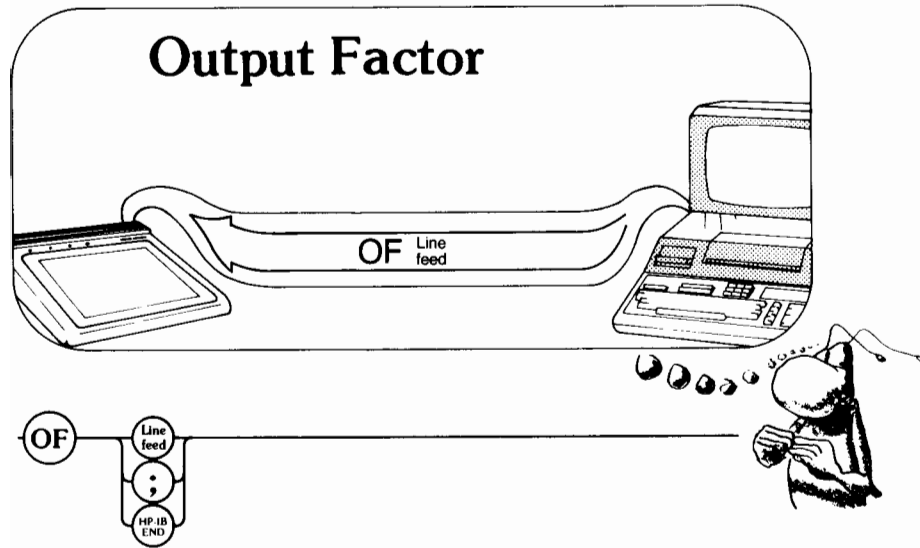

OF Linefeed | ; | HP-IB END

The output factor sets up the digitizer to output two parameters with the next controller input instruction. The two parameters represent the X and Y resolution expressed in lines/millimetres. The values are 40 and 40. The output data string is shown next.

40,40CRLF

This is the apparent resolution of the graphics tablet; however, the data is rounded internally to 10 line/millimetres.

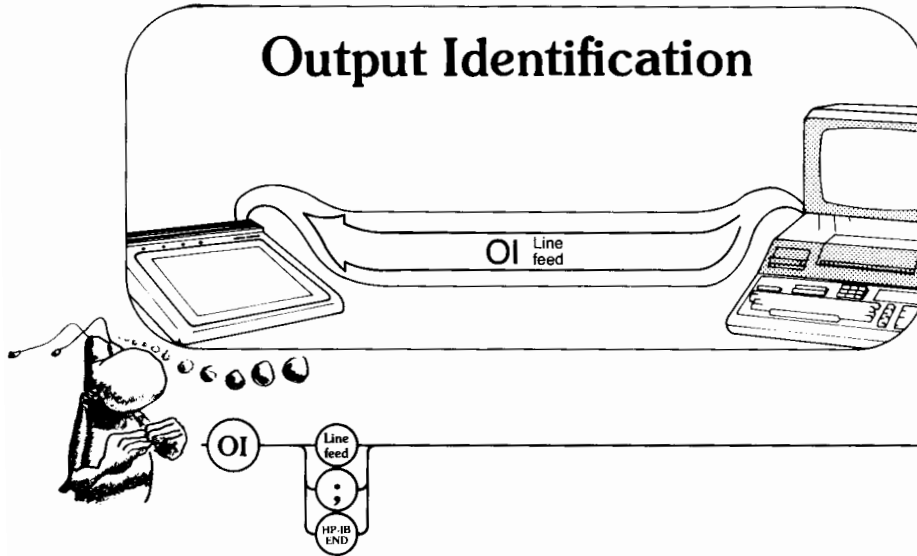

OI Linefeed | ; | HP-IB END

The output identification instruction gets the graphics tablet ready to output one parameter when the next controller input is expected. This parameter is 9111A. This instruction can be used to identify this device on a large bus system. The output data string is shown next:

9111ACRLF

Incidentally, this is the only instruction to return a non-numeric data character.

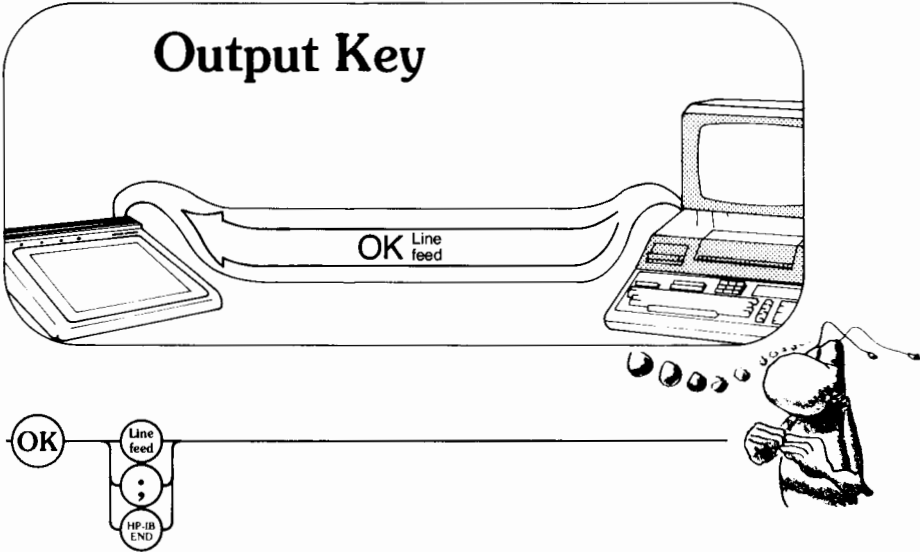

OK Linefeed | ; | HP-IB END

This instruction sets the graphics tablet to output the selected menu value upon the receipt of the next controller input instruction. When you select a menu square (energizing the digitize switch, contained within the stylus, within a square area marked on the upper section of the platen), bit seven of the status byte is set. If you are checking bit seven (via program control) you should send an OK instruction once bit seven is set. And this is followed with a controller read instruction.

The OK instruction clears bit seven of the status and readies the graphics tablet to output a value associated with the selected square. The following table shows the value associated with each predefined menu square.

5-30 OK

Menu

Output Value Menu Square Selected

1	1
2	2
4	3
8	4
16	5
32	6
64	7
128	8
256	9
512	10
1024	11
2048	12
4096	13
8192	14
16384	15
32768	16

Energizing the digitizing switch in a square menu area will set a value (see the previous table). Energizing the digitize switch in the same square clears the previously set value and bit 7 of the status byte.

For compatibility reasons with the 9874A digitizer this instruction is allowed. When used in this manner this instruction would normally be followed by the SK0 instruction in order to clear the menu value and menu light.

If compatibility is not a concern, it is recommended that you use the RS instruction which is more suited for the graphics tablet.

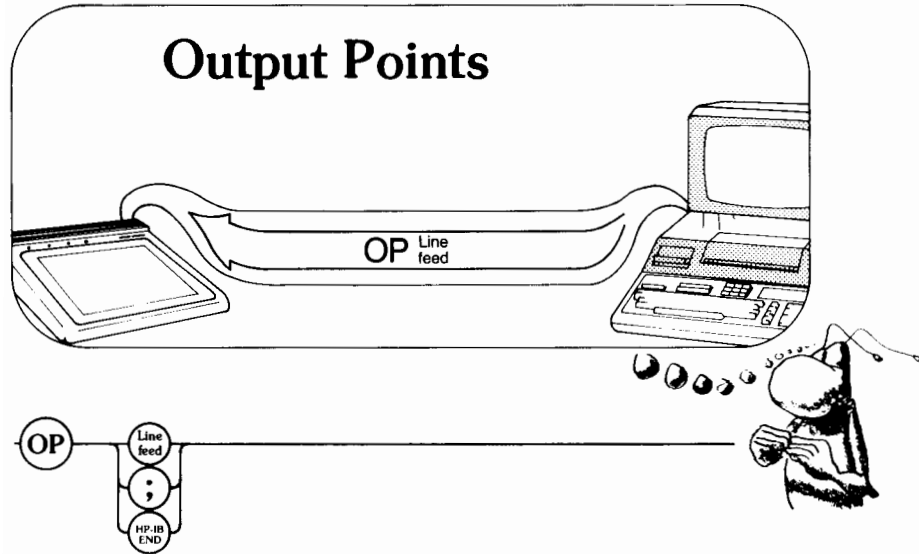

OP Linefeed | ; | HP-IB END

This instruction outputs the scaling points. P1 and P2. These are the same coordinates input with IP (Input Points). The graphics tablet outputs four points with the next controller input instruction. The output data string is shown next.

$$\begin{array}{cccc} \text{XXXXX, XXXXX, XXXXX, XXXXX} & \text{CR LF} \\ \hline \text{P1 X} & \text{P1 Y} & \text{P2 X} & \text{P2 Y} \end{array}$$

Each value can vary from 5 characters down to 1 character; the string contain comma delimiters and a CR/LF as the string terminator.

Incidentally, negative values are allowed if they are input with the IP instruction.



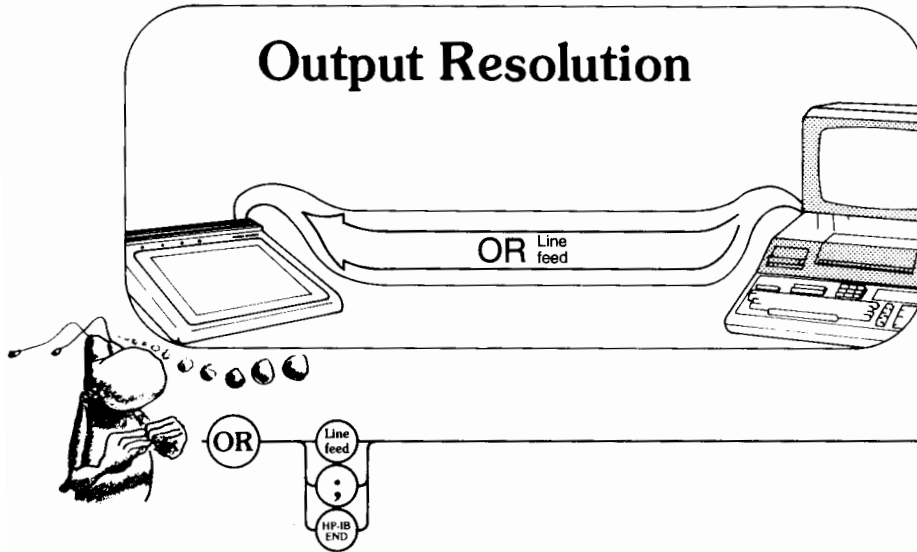

OR Linefeed | ; | HP-IB END

The output resolution instruction sets up the graphics tablet to output two parameters with the next controller input instruction. The two parameters represent the X and Y resolution expressed in lines per millimetres. The values are .025 and .025. The output data string is shown next.

.025,.025 CR LF

The apparent resolution of the graphics tablet is .025 millimetres; however, the data is rounded internally to the nearest .1 millimetre. For scaling purposes, consider all data transferred to and from the tablet as representing .025 millimetre units.

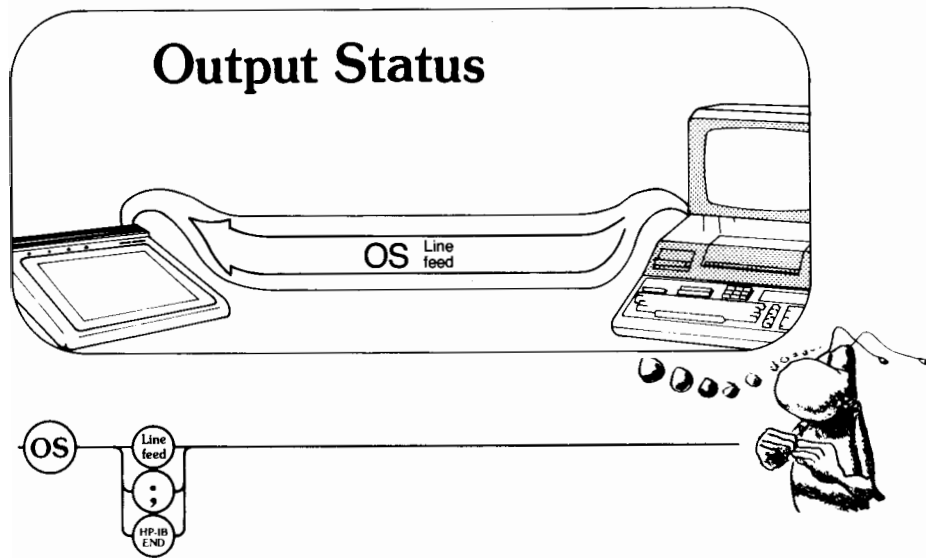

OS Linefeed | ; | HP-IB END

This instruction sets up the graphics tablet to output the decimal sum of the bits which are set in the status word when it receives the next controller input instruction. The status word consists of eleven bits (0 through 10). Different bits are set corresponding to the graphics tablet's internal condition. The summed total weighted value of the set bits is output. See the following status word table.

The Status Word

Weighted Value	Bit	Set Bit Meaning	Instruction to Clear Bit
1	0	Always Clear	
2	1	Always Clear	
4	2	Digitize Point Bit - This bit is set when a point is digitized.	OD, DC, DF, IN
8	3	Initialize Bit - Completed Power on Self Test.	OS and DF
16	4	Ready Bit - Completed Power Self Test, User Interaction Self Test, and Beep.	Initiating the Power on Self Test, User Interaction Self Test, or Beep Instruction.
32	5	Error Bit - Error Detected.	OE, DF, and IN
64	6	Service Request Bit - SRQ Generated.	Clear SRQ
128	7	Softkey Bit - Menu Item Selected.	OK, RS, DF, and IN
256	8	Proximity Bit - Pen Tip within approximately $\frac{1}{4}$ inch of the active platen area.	Remove the Pen Tip from the active Platen area.
512	9	New Cursor Position Bit - The Buffers containing cursor positional data are updated.	Binary Read, DF, IN, and OC
1024	10	Pen Press Bit - Pen is pressed against the active platen area.	Lift Pen

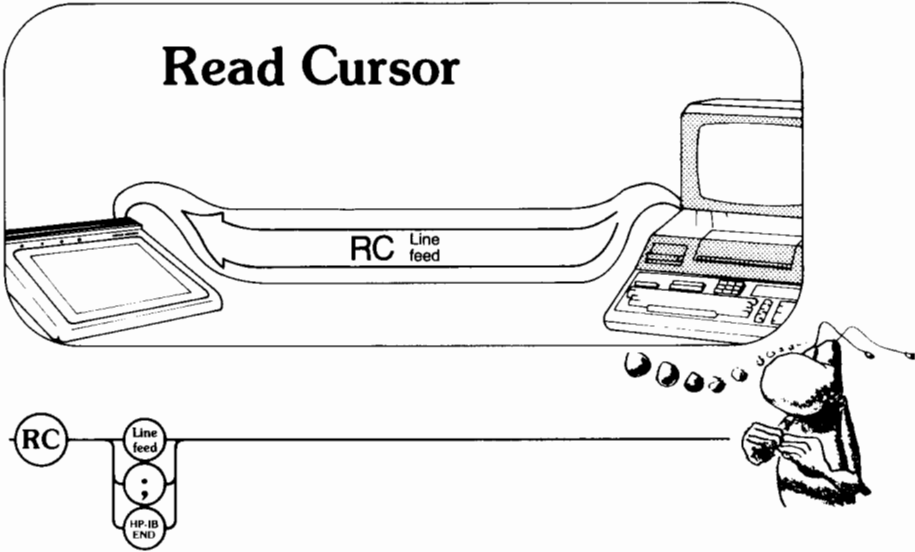

RC Linefeed | ; | HP-IB END

This instruction sets up the graphics tablet to output the following information X, Y, PEN, STATUS, and ERROR. Upon the next controller input instruction, the following parameters are read into your controller. The RC parameters (format) are shown next.

<u>X value</u>	<u>Y Value</u>	<u>PEN</u>	<u>Key</u>	<u>STATUS</u>	<u>ERROR</u>	
XXXXX	, XXXXX	, X	, XX	, XXXX	, XXX	CR LF

The parameters X, Y, and error are output using a variable length format. The X and Y values can have a maximum character field of 5 characters and a minimum field of one character. Smaller numbers (1 or 2 digit) can possibly contain a minus sign if you are digitizing in the lower left hand corner. The error value can have a maximum of three characters and a minimum of one character.

The pen value is a fixed one character field.

5-36 RC

The key and status parameters are fixed in length (key = 2 characters, status = 4 characters) and can contain leading zeros.

The parameters are separated with comma delimiters and the graphics tablet terminates all outputs with a carriage return and linefeed characters.

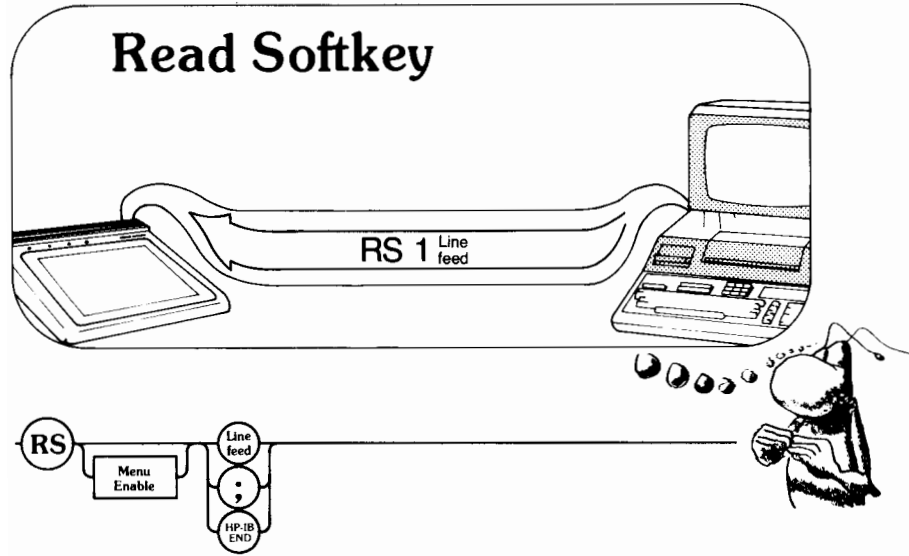

RS [menu enable] Linefeed | ; | HP-IB END

This instruction set up the graphics tablet to output a decimal number corresponding to the selected menu square. This number is output with the next controller input instruction. See the following table for the value output and its corresponding menu square.

5-38 RS

Menu	
Output Value	Menu Square Selected
0	No Square Selected
1	1
2	2
3	3
4	4
5	5
6	6
7	7
8	8
9	9
10	10
11	11
12	12
13	13
14	14
15	15
16	16

The parameter allowed with the RS instruction can be a one or a zero. A one enables the menu area of the platen, whereas a zero disables the menu area. The output value shown in the previous table is available in any case. RS clears the menu number and status bit 7. Also, the menu value is cleared after it is read.

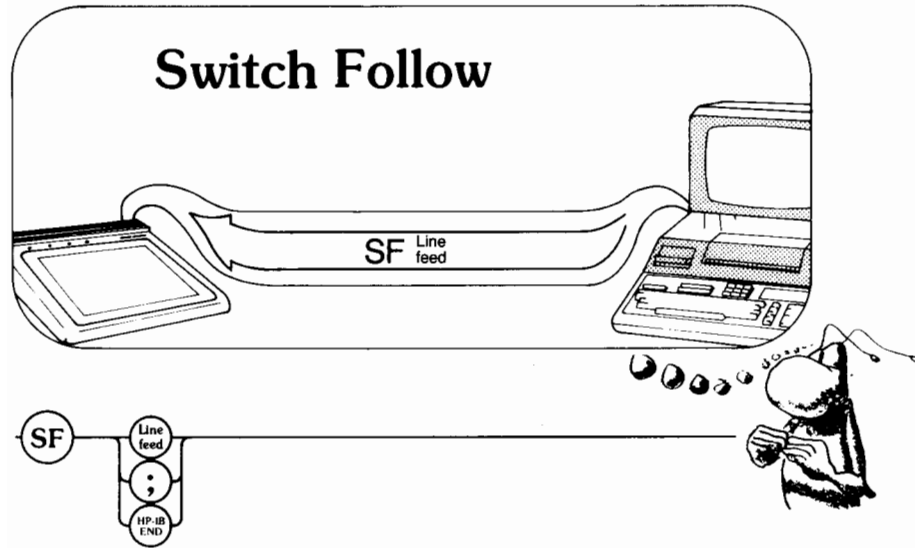

SF Linefeed | ; | HP-IB END

This instruction places the digitize switch (internal to the stylus) into a press to digitize mode. Points are digitized only while the pen is pressed to the platen. This instruction is only used in the continuous sampling mode. The last point sent out using the OD instruction will have a pen parameter value of zero.

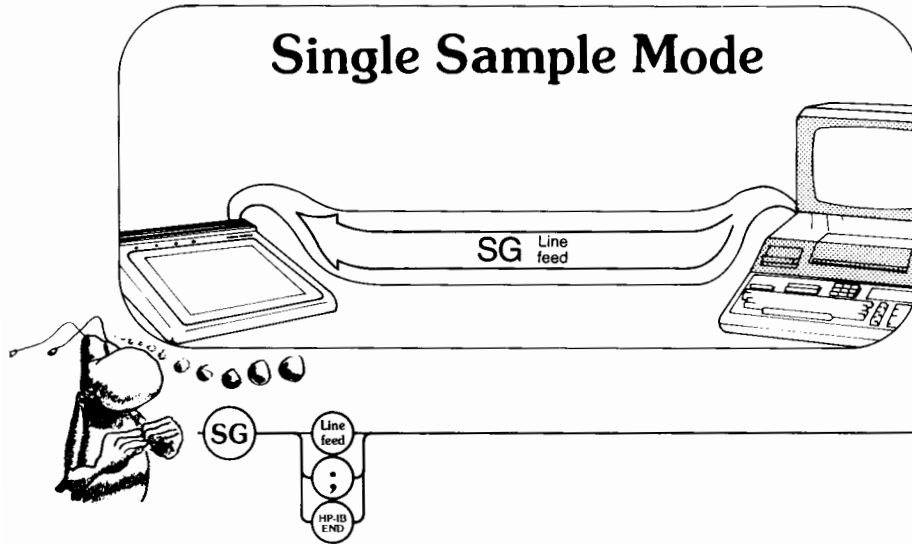

SG Linefeed | ; | HP-IB END

The SG instruction sets the graphics tablet's single sample mode. When this mode is set, the digitize LED above the active area is illuminated and the digitize switch within the stylus is armed. When the digitize switch is energized (pressing the pen tip onto the active area) a coordinate point is stored in the tablet. This process sets bit 2 of the status byte. The data is transferred to your controller via the OD instruction.

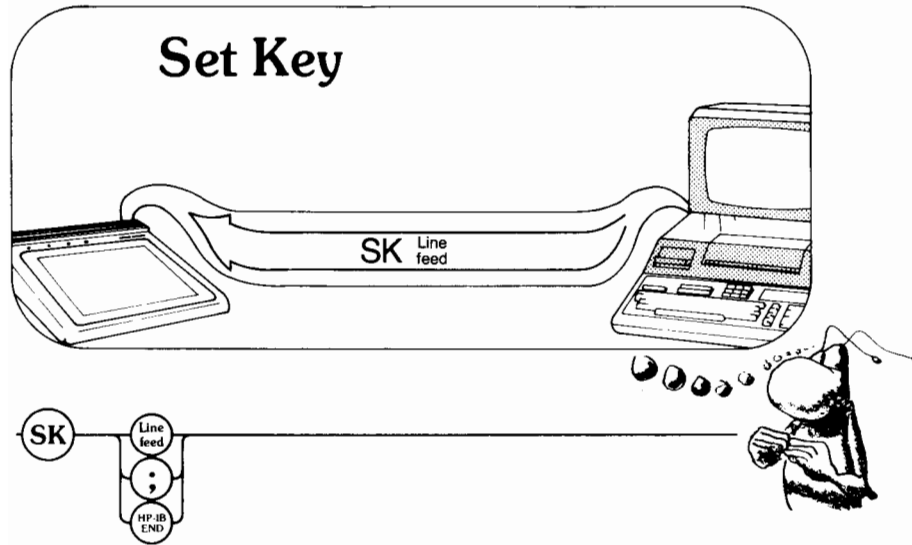

SK Linefeed | ; | HP-IB END

The set key instruction clears any previously picked menu value and also bit seven of the status byte. This instruction is normally used following an "OK" instruction. It would be used to clear the graphics tablet between menu selections.

SK [value] is allowed for compatibility with the HP graphics devices. The [value] is read into the graphics tablet and discarded.



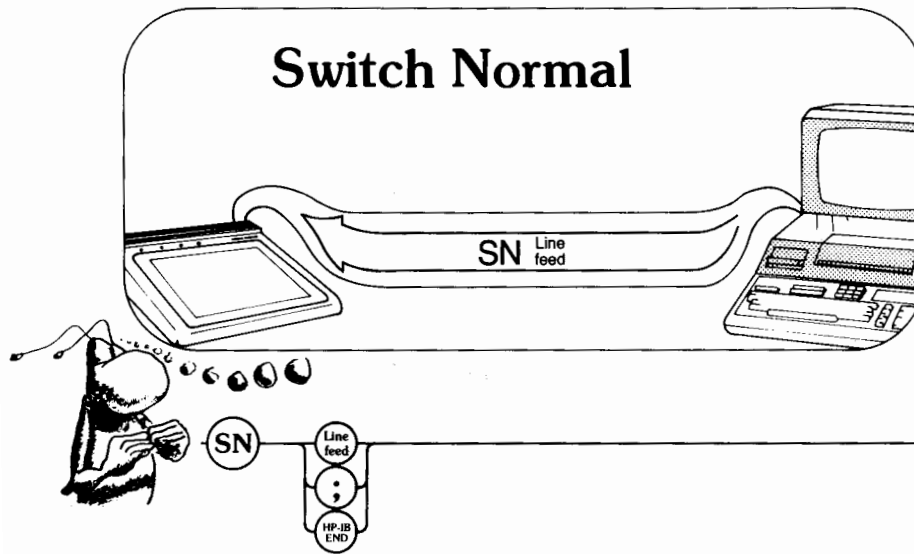

SN Linefeed | ; | HP-IB END

SN sets the switch normal (default) mode of the digitize switch. The first pen press starts the digitizing process; the next pen press stops the digitizing. This instruction is used in the CN (continuous sampling mode) and the last coordinate value output (with OD) will have a pen parameter of zero.

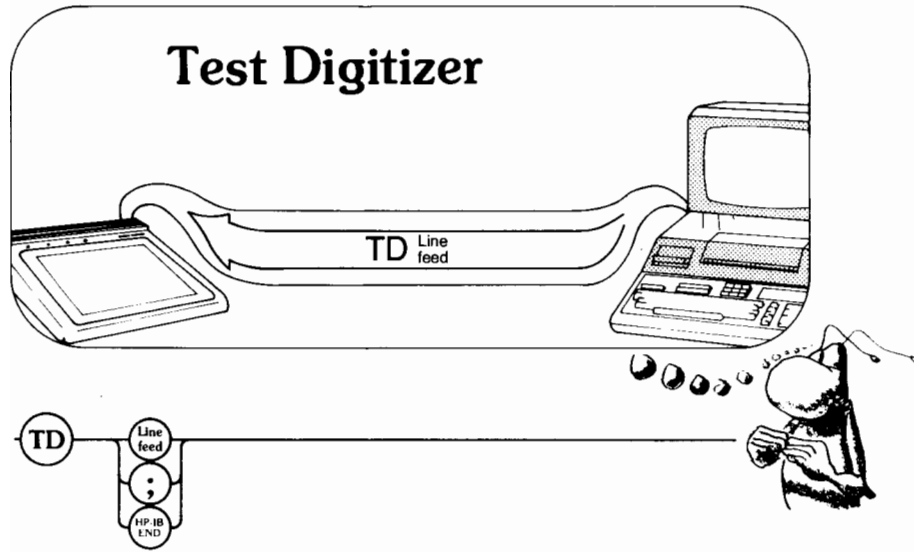

TD Linefeed | ; | HP-IB END

This instruction sets up the user interaction self test mode. You must digitize the dot on the active surface, which is checked for accuracy. If any instruction is received by the graphics tablet while it is waiting for the digitized point, the self test is aborted. See the section titled "Errors and What They Mean" for more information on the Self Tests.

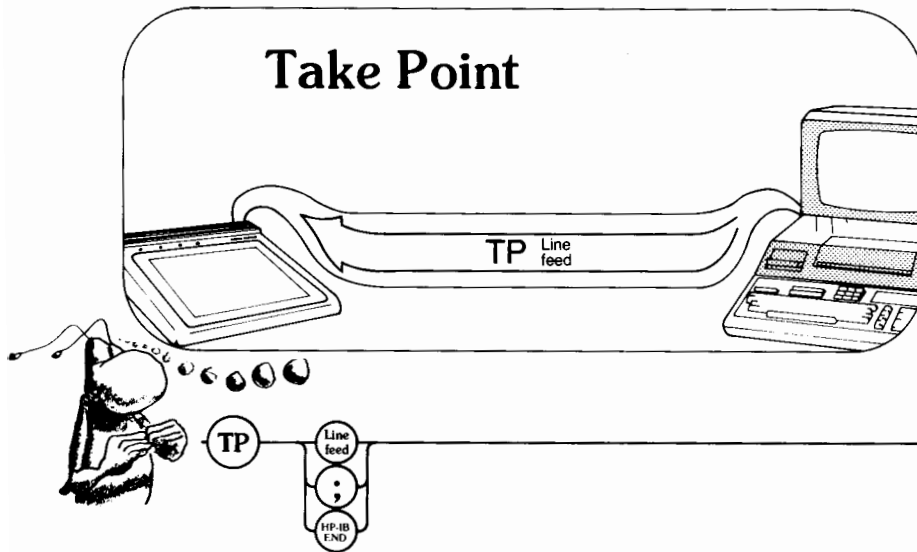

TP Linefeed | ; | HP-IB END

The take point instruction simulates the press of the digitize switch. This is done regardless of the actual pen position (pen down or pen up).

This instruction can be used to force a point to be digitized in the SG mode or to terminate digitizing a string of data in the CN (Switch Normal) mode.

No-operation Instructions

The following instructions are accepted without error, but cause no action within the graphics tablet.

AN
AT
AV
CC
DD
DR
IW
LB
LT
PA
PC
PD
PG
PU
RV
SL
SP
SR

Note: OW is not allowed

Binary Data Transfer

A binary data transfer mode is available on the graphics tablet. This binary transfer is the default mode of operation and is available using any of the bus addresses.

Binary transfer is initiated with your controller doing a read operation. This read operation must follow the hardware guidelines of the IEEE 488-1978 Standard. The binary data placed on the bus is 6 bytes of data. The first 2 bytes of data is the binary representation of the stylus X position. This is followed with 2 bytes of Y position and 2 bytes of the tablet's current status. Each 2 bytes is a two's complement binary number sent with the most significant bit first. Another controller read will initiate another output of binary data. For most efficient timing your controller read cycles should approximately match the cursor update cycles. See the CR instruction.

Appendix



A-2 Appendix

ASCII Table

ASCII Char.	EQUIVALENT FORMS				HP-IB
	Binary	Oct	Hex	Dec	
NULL	00000000	000	00	0	
SOH	00000001	001	01	1	GTL
STX	00000010	002	02	2	
ETX	00000011	003	03	3	
EOT	00000100	004	04	4	SDC
ENO	00000101	005	05	5	PPC
ACK	00000110	006	06	6	
BELL	00000111	007	07	7	
BS	00001000	010	08	8	GET
HT	00001001	011	09	9	TCT
LF	00001010	012	0A	10	
VT	00001011	013	0B	11	
FF	00001100	014	0C	12	
CR	00001101	015	0D	13	
SO	00001110	016	0E	14	
SI	00001111	017	0F	15	
DLE	00010000	020	10	16	
DC1	00010001	021	11	17	LLO
DC2	00010010	022	12	18	
DC3	00010011	023	13	19	
DC4	00010100	024	14	20	DCL
NAK	00010101	025	15	21	PPU
SYNC	00010110	026	16	22	
ETB	00010111	027	17	23	
CAN	00011000	030	18	24	SPE
EM	00011001	031	19	25	SPD
SUB	00011010	032	1A	26	
ESC	00011011	033	1B	27	
FS	00011100	034	1C	28	
GS	00011101	035	1D	29	
RS	00011110	036	1E	30	
US	00011111	037	1F	31	

ASCII Char.	EQUIVALENT FORMS				HP-IB
	Binary	Oct	Hex	Dec	
space	00100000	040	20	32	LA0
!	00100001	041	21	33	LA1
"	00100010	042	22	34	LA2
#	00100011	043	23	35	LA3
\$	00100100	044	24	36	LA4
%	00100101	045	25	37	LA5
&	00100110	046	26	38	LA6
'	00100111	047	27	39	LA7
(00101000	050	28	40	LA8
)	00101001	051	29	41	LA9
*	00101010	052	2A	42	LA10
+	00101011	053	2B	43	LA11
,	00101100	054	2C	44	LA12
-	00101101	055	2D	45	LA13
.	00101110	056	2E	46	LA14
/	00101111	057	2F	47	LA15
0	00110000	060	30	48	LA16
1	00110001	061	31	49	LA17
2	00110010	062	32	50	LA18
3	00110011	063	33	51	LA19
4	00110100	064	34	52	LA20
5	00110101	065	35	53	LA21
6	00110110	066	36	54	LA22
7	00110111	067	37	55	LA23
8	00111000	070	38	56	LA24
9	00111001	071	39	57	LA25
:	00111010	072	3A	58	LA26
;	00111011	073	3B	59	LA27
<	00111100	074	3C	60	LA28
=	00111101	075	3D	61	LA29
>	00111110	076	3E	62	LA30
?	00111111	077	3F	63	UNL

Appendix A-3

ASCII Char.	EQUIVALENT FORMS				HP-IB
	Binary	Oct	Hex	Dec	
@	01000000	100	40	64	TA0
A	01000001	101	41	65	TA1
B	01000010	102	42	66	TA2
C	01000011	103	43	67	TA3
D	01000100	104	44	68	TA4
E	01000101	105	45	69	TA5
F	01000110	106	46	70	TA6
G	01000111	107	47	71	TA7
H	01001000	110	48	72	TA8
I	01001001	111	49	73	TA9
J	01001010	112	4A	74	TA10
K	01001011	113	4B	75	TA11
L	01001100	114	4C	76	TA12
M	01001101	115	4D	77	TA13
N	01001110	116	4E	78	TA14
O	01001111	117	4F	79	TA15
P	01010000	120	50	80	TA16
Q	01010001	121	51	81	TA17
R	01010010	122	52	82	TA18
S	01010011	123	53	83	TA19
T	01010100	124	54	84	TA20
U	01010101	125	55	85	TA21
V	01010110	126	56	86	TA22
W	01010111	127	57	87	TA23
X	01011000	130	58	88	TA24
Y	01011001	131	59	89	TA25
Z	01011010	132	5A	90	TA26
[01011011	133	5B	91	TA27
\	01011100	134	5C	92	TA28
]	01011101	135	5D	93	TA29
^	01011110	136	5E	94	TA30
_	01011111	137	5F	95	UNT

ASCII Char.	EQUIVALENT FORMS				HP-IB
	Binary	Oct	Hex	Dec	
`	01100000	140	60	96	SC0
a	01100001	141	61	97	SC1
b	01100010	142	62	98	SC2
c	01100011	143	63	99	SC3
d	01100100	144	64	100	SC4
e	01100101	145	65	101	SC5
f	01100110	146	66	102	SC6
g	01100111	147	67	103	SC7
h	01101000	150	68	104	SC8
i	01101001	151	69	105	SC9
j	01101010	152	6A	106	SC10
k	01101011	153	6B	107	SC11
l	01101100	154	6C	108	SC12
m	01101101	155	6D	109	SC13
n	01101110	156	6E	110	SC14
o	01101111	157	6F	111	SC15
p	01110000	160	70	112	SC16
q	01110001	161	71	113	SC17
r	01110010	162	72	114	SC18
s	01110011	163	73	115	SC19
t	01110100	164	74	116	SC20
u	01110101	165	75	117	SC21
v	01110110	166	76	118	SC22
w	01110111	167	77	119	SC23
x	01111000	170	78	120	SC24
y	01111001	171	79	121	SC25
z	01111010	172	7A	122	SC26
{	01111011	173	7B	123	SC27
	01111100	174	7C	124	SC28
}	01111101	175	7D	125	SC29
~	01111110	176	7E	126	SC30
DEL	01111111	177	7F	127	SC31

A-4 Appendix

Overlay/Menu Dimensions

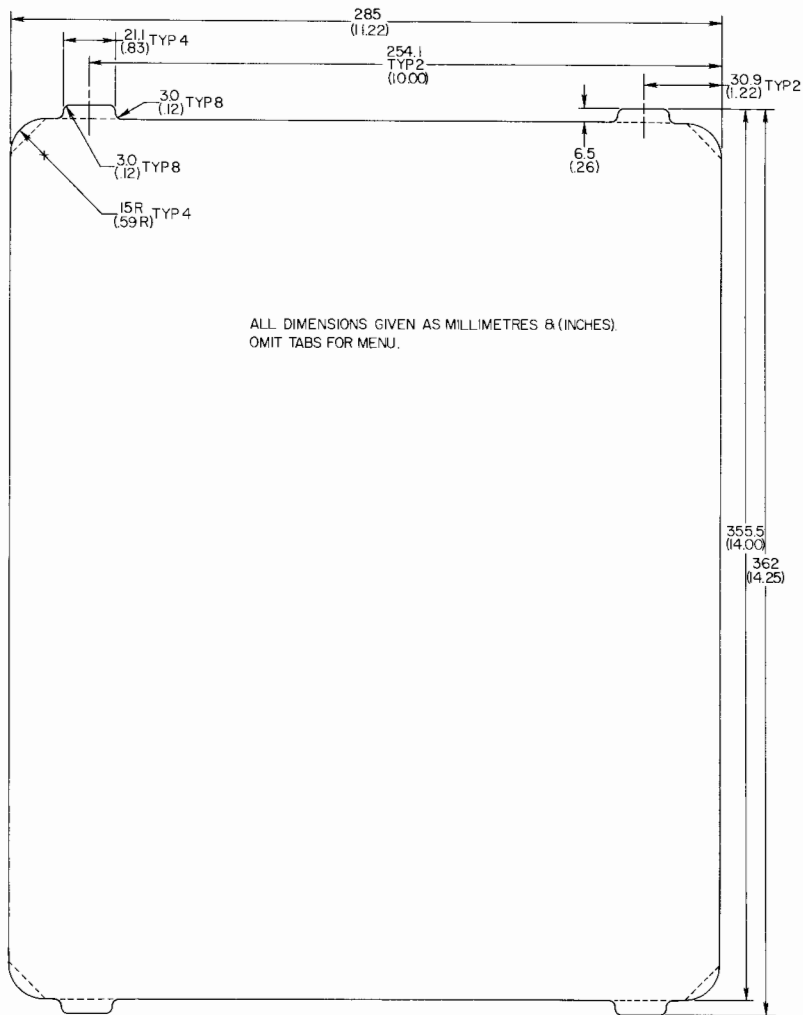

A-6 Appendix

Platen Digitizing Units Dimensions

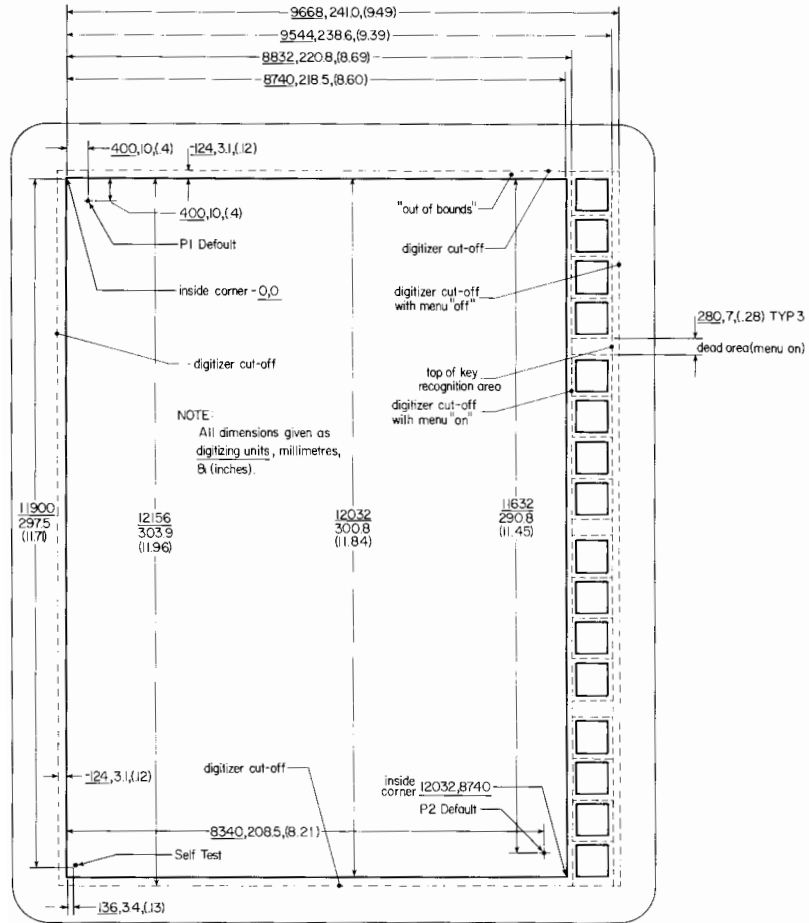

Subject Index



a

Abort Message	4-5
Aborting a Bus Transaction	4-7
Accessories	1-6
Active HP-IB Controller	4-3
Addressing, HP-IB	1-11
Amplitude Register	5-9
Amplitude, Beep	5-9
Applying Power	1-12
ASCII Table	A-2
Audible Prompt	5-8

b

Beep	5-8
Beeper	5-9
Begin Test	5-43
Binary Data Transfer	4-8,5-45
Blank Menus	1-16
BP	5-8
Bus Functions	4-6
Byte	4-2

c

Cabling, HP-IB	1-11
Cartridges, Stylus	1-13
Changing Fuses	1-10

I-2 Index

Characters	1-2
Cleaning Overlays	1-15
Platen	1-17
Clear Digitizer	5-13
Lockout and Set Local Message	4-4
Menu Selection	5-41
Message	4-4
Clearing the Graphics Tablet	4-7
CN	5-10
Common Operations	2-1
Compatibility, HPGL	5-3
Conductive Inks	1-17
Conductive Papers	1-17
Consumable Materials	1-6
Continuous Digitizing	2-2
Sampling Mode	5-10
Self Test	3-16
Contour Lines	2-2
Controller, Active	4-3
HP-IB	4-3
Sysyem	4-3
Cords, Power	1-9
CR	5-12
Cursor Rate	5-12
Register	3-3
Tracking	2-5
Read	5-35

d

Data Message	4-4,4-6
Rate	5-12
Termination	5-2
DC	5-13
Default	5-14
Default Binary Transfer	4-8,5-45

Device, HP-IB	4-2
DF	5-14
Digitize Mode	3-4
Mode Resister	3-3
Point	5-15
Register	3-3
Digitized Point, Output	5-23
Clear	5-13
Compatibility	5-3
Units, Platen Artwork	A-6
Digitizing Light	1-14,5-25
Mode, Continuous Sample	5-10
Mode, Single Sample	5-40
P1-P2	2-3
Scaling Points	2-3
Continuous	2-2
Single Point	2-3
Dimensions, Digitizer Units,	
Platen Artwork	A-6
Menu and Overlay	A-4
Physical, Platen Artwork	A-5
DP	5-15
Duration Register	5-9
Duration, Beep	5-9

e

E Mask	3-6,5-16
Emask	5-16
Error Mask	5-16
Numbers	3-12,5-16
Output	5-26
Errors	3-6,3-12
Errors and What They Mean	3-12

f

Factor Register	3-11
Factor, Output	5-27
Features	1-2
Force Digitize Point	5-44
Frequency, Beep	5-8
Fuses	1-10

g

Gotcha's	4-10
Graphic Data Manipulation	2-5
Syntax	5-4
Graphics Tablet Bus Functions	4-6
Instruction Set	5-2
Supplies	1-6
Grounding Requirements	1-8

h

Hardware Errors	3-13
Hewlett Packard Interface	
Bus	1-11,4-1
Hewlett-Packard Graphics	
Language	5-2
High Level Language Support	2-7
HP 1000	4-13
HP 85	4-14
HP 9874 Compatibility	5-3
HP-IB	1-11,4-2
Controller	4-3
Active Controller	4-3

Addressing	1-11
Cabling	1-11
Concepts	4-2
Device	4-2
Listener	4-3
Messages	4-4
System Controller	4-3
System Terms	4-2
Talker	4-3
Worksheet	4-8
HPGL	5-2
Compatibility	5-3

i

I/O Register	3-3
I/O Status Register	3-6,3-7
Identification, Output	5-28
IEEE 488-1978	1-11
IM	5-16
IN	5-18
Initialize	5-18
Input Masks	5-16
Input Points	5-19
Instruction Set	5-2
BP	5-8
CN	5-10
CR	5-12
DC	5-13
DF	5-14
DP	5-15
IM	5-16
IN	5-18
IP	5-19
No-Op	5-45
OA	5-20

I-6 Index

OC.....	5-21
OD.....	5-23
OE.....	5-26
OF.....	5-27
OI.....	5-28
OK.....	5-29
OP.....	5-31
OR.....	5-32
OS.....	5-32
RC.....	5-35
RS.....	5-37
SF.....	5-39
SG.....	5-40
SK.....	5-41
SN.....	5-42
TD.....	5-43
TP.....	5-44
Interfacing.....	4-1, 4-10
Notes.....	4-13
HP 1000.....	4-13
HP 85.....	4-14
Internal Status Register.....	3-7
IP.....	5-19

k

Key Register.....	3-6
Output.....	5-29
Set.....	5-41

l

Language.....	5-2
Language Reference.....	5-2

Line Contours	2-2
Cords	1-9
Voltage	1-8
Linear Syntax	5-4,5-7
Listener, HP-IB	4-3
Local Lockout Message	4-4
Local Message	4-4

m



Maintenance Agreements	1-7
Mask, Error	5-16
Parallel Poll	5-17
Status	5-17
Maskable Errors	3-12,5-16
Menu	1-14,3-6
Blanks	1-16
Dimensions	A-4
Processing	3-6
Selection, Output	5-29
Selection, Read	5-37
Switch Register	3-6
Menus	1-16
Message Concepts	4-4
Mode, Single Sample	5-40
Switch Follow	5-39
Switch Normal	5-42
Modes, Digitizing	3-4
Modes, Switch	3-3

n

No-Operation Instructions	5-45
Noise	5-8

Non-conductive Papers and
Inks 1-17
Note Register 5-9
Notes, Musical 5-8

O

OA 5-20
OC 5-21
OD 5-23
OE 5-26
OF 5-27
OI 5-28
OK 5-29
OP 5-31
OR 5-32
Ordering Menu Blanks 1-16
 Overlays 1-16
OS 5-33
Output Actual Stylus
 Position 5-20
 Cursor 5-21
 Digitized Point 5-23
 Error 5-26
 Factor 5-27
 Identification 5-28
 Key 5-29
 Menu Selection 5-29
 Points 5-31
 Resolution 5-32
 Scaling Points 5-31
 Status 5-33
Overlay Dimensions A-4
 Menus 1-14
 Cleaning 1-15

p

P Mask	3-6
P1-P2	3-10
Digitizing	2-3
Input	5-19
Output	5-31
Read	5-31
Parallel Poll	3-6,4-7
Parallel Poll Mask	5-17
Pass Control Message	4-5
Pen Processing	3-3
Physical Dimensions, Platen	
Artwork	A-5
Picks	2-5
Platen Artwork, Digitizer	
Units	A-6
Platen Artwork, Physical	
Dimensions	A-5
Platen, Cleaning	1-17
Pmask	5-17
Point, Take	5-44
Position, Cursor, and	
Digitizing	3-3
Power Cords	1-9
Power On Initialization	5-18
Power Requirements	1-8
Powering Up	1-12
Problems	4-10
Product Id	3-11
Product Identification, Output	5-28
Prompt	5-8
Pseudo-code	2-2

R

Rate, Cursor	5-12
RC	5-35
Read Cursor	5-21,5-35
Digitized Point	5-23
Error	5-26
Key	5-29
Menu Selection	5-29
P1-P2	5-31
Resolution	5-32
Scaling Points	5-31
Softkey	5-37
Stat	5-33
Stylus Position	5-20
Refills, Stylus	1-13
Register Diagram	3-2
Register Model	3-3
Remote Message	4-4
Representing Syntax	5-4
Require Service Message	4-5
Reset Graphics Tablet	5-18
Resolution	3-11
Resolution, Output	5-32
RS	5-37

S

S Mask	3-6
Scale Factor	3-11
Scaling	2-4
Factor, Output	5-27
Points	3-10
Points, Digitizing	2-3
Points, Output	5-31

Self Test	3-13
Self Test, Continuous	3-16
Serial Poll	4-8
Service Request	4-8,5-17
Service Request Message	4-8
Set Default Conditions	5-14
Key	5-41
Masks	5-16
Mode, Single Sample	5-40
Mode, Switch Follow	5-39
Mode, Switch Normal	5-42
SF	5-39
SG	5-40
Single Point Digitizing	2-3
Single Sample Mode	5-40
SK	5-41
Smask	5-16
SN	5-42
Softkey, Read	5-37
Softkeys	1-14
Software Model	3-2
Specifications	1-4
SRQ	4-8,5-17
SRQ's	3-6
Status Bit Message	4-5,4-7
Status Byte Message	4-5,4-8
Status Mask	5-16,5-17
Status Register	3-6
Status, Output	5-33
Stylus	1-13
Stylus Position, Output	5-20
Stylus Refills	1-13
Supplies	1-6
Support in a High Level	
Language	2-7
Switch Follow	5-10,5-39
Switch Mode Register	3-3
Switch Normal	5-10,5-42

Switching the Graphics	
Tablet On	1-12
Syntax Representation	5-4
System Controller, HP-IB	4-3
System Terms, HP-IB.	4-2

t

Table, ASCII.	A-2
Tablet Bus Functions	4-6
Take Point.	5-44
Talk Only Mode	4-8
Talker, HP-IB	4-3
TD	5-43
Terminators, Data.	5-2
Test Digitizer.	5-43
Theory of Operation.	3-1
Tone	5-8
TP	5-44
Tracking the Cursor	2-5
Transformations, Scaling.	2-4
Translation	2-4
Trigger Message	4-4

u

Unpacking.	1-6
User Generated Errors.	3-12
User Interaction Self Test	3-13
User Interaction Self Test Errors.	3-13

V

Virtual Machine 3-2

W

Worksheet, HP-IB 4-8