

HEWLETT-PACKARD

HP 82905B

# Printer

## OWNER'S MANUAL



$$Z = \begin{bmatrix} 10 & 00 \\ 01 & 00 \\ 00 & V_{11} V_{12} \\ 00 & V_{21} V_{22} \end{bmatrix} =$$

$$X = (A^T A)^{-1} A^T$$



A =

			0.0569	-0.2520
	0.1	0.6389	0.0	-0.4688
K =	-0.0709	0.1861	-0.8383	-0.4806
	0.0726	-0.4109	-0.5354	0.7253
	-0.2002	-0.6231	0.1027	-0.1411
	0.7357			
R =	1.4446	1.6867	1.2530	
	0.0	-1.3389	-0.1486	
	0.0	0.0	1.1831	



# HP 82905B Printer

## Owner's Manual

June 1982

Reorder Number  
82905-90014



**HP Computer Museum**  
**[www.hpmuseum.net](http://www.hpmuseum.net)**

**For research and education purposes only.**

# Contents

<b>Section 1: General Information</b>	
Introduction .....	5
Compatibility .....	5
Specifications .....	6
Interface Options .....	7
<b>Section 2: Installation</b>	
Unpacking and Inspecting the Printer .....	9
Selecting an Operating Site .....	9
Removing the Shipping Screws .....	9
Installing the Ribbon Cartridge .....	9
Installing the Paper Separator .....	11
Loading Paper .....	11
Setting the Top of Form .....	13
Adjusting the Printer Head Gap .....	14
Connecting Your Printer to a Power Source .....	14
Connecting the Printer to a Series 80 Computer .....	15
Select Code Switch .....	15
Device Address .....	16
Connecting the Printer to an HP 125 Computer .....	17
Connecting the Printer to Other Devices .....	17
Self-Test .....	17
<b>Section 3: Operating the Printer</b>	
Introduction .....	19
Front Panel Switches and Indicators .....	19
Power On .....	20
Preset Operating Conditions .....	20
Out-of-Paper Detection .....	20
Text Mode .....	20
General Control Codes .....	21
Form Control .....	21
Spacing and Print Mode Selection .....	22
Graphics Mode .....	23
Initiating Graphics Mode .....	24
Graphics Print Example .....	25
<b>Section 4: Accessories, Maintenance, and Service</b>	
Accessories .....	27
Maintenance .....	27
Parts Replacement .....	27
Service .....	28
Warranty Information .....	28
How to Obtain Repair Service .....	29
Serial Number .....	29
General Shipping Instructions .....	29
Potential for Radio/Television Interface .....	30
<b>Appendix A: Reference Tables</b> .....	33
<b>Appendix B: Character Sets</b> .....	37
<b>Appendix C: Using the Printer With the Optional HP-IL Interface</b> .....	43
<b>Appendix D: Using the Printer With the Optional Serial Interface</b> .....	49
<b>Appendix E: Using the Printer With the Optional Parallel Interface</b> .....	55



## General Information

### Introduction

The HP 82905B Printer is a general purpose printer featuring 80 character per second bi-directional printing. The printer utilizes a  $9 \times 9$  dot matrix character format. It prints in 40, 66, 80, or 132 columns. You can choose among normal, expanded, compressed, or compressed expanded characters. Normal size characters may also be emphasized.

The printer has a graphics mode which gives you the ability to print illustrations, charts, graphs, block letters, etc. using patterns of dots under software control. You can also specify functions such as line spacing, form length, and skip over perforation under software control.

### Compatibility

The HP 82905B Printer conforms to IEEE Standard 488-1978. It may be connected to any Hewlett-Packard Series 80 Personal Computer. Connection to an HP-83 or HP-85 requires an HP 82937A HP-IB Interface module and a Plotter/Printer ROM (part number 00085-15002). Connection to an HP-87 requires only an HP-IB Interface Cable (HP part no. 10833A, B, C, or D). The HP-87 Plotter ROM is not required, but provides two enhancements for printers. These enhancements allow you to copy either the alpha or graphics screen to the HP 82905B Printer with a single command.

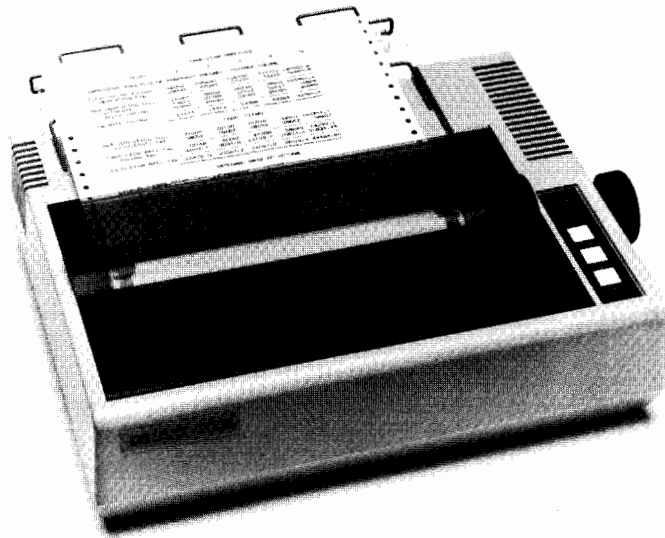

Other available interface options for the HP 82905B Printer are listed on page 7 and explained in appendices C, D, and E.

## Specifications

<b>Printer</b>	
Printing Method	Impact dot matrix.
Character Structure	
Text Mode	9 × 9 dot matrix.
Graphics Mode	72 × 60, 72 × 120 dots to the inch.
Character Size	2.1 mm (0.083 inch) × 3.1 mm (0.120 inch).
Characters Per Line	40, 66, 80, 132.
Paper Feed	Adjustable sprocket feed.
Paper	Fanfold.
Paper Width	101.6 mm (4 inches) to 254 mm (10 inches).
Copies	Original plus two carbons.
Paper Thickness	0.3 mm (0.01 inch) maximum.
Line Spacing	6, 8, 9, 12, 18, 24, 36, or 72 lines per inch.
Printing Direction	Bi-directional with logical seeking (text mode).
Printing Speed	80 characters per second.
Line Feed Repeat Rate	5 line feeds per second.
Ribbon	Black inked cartridge ribbon.
<b>Environmental</b>	
Operating Temperature	5° to 35° C (41° to 95° F).
Storage Temperature	–30° to 60° C (–22° to 140° F).
Operating Humidity	10 to 90 percent (no condensation).
Storage Humidity	5 to 90 percent (no condensation).
<b>Power Requirement</b>	
Power Supply	100V, 50/60 Hz. 120V, 50/60 Hz. 220V, 50/60 Hz. 240V, 50/60 Hz.
Maximum Power Consumption	100 W.
<b>Reliability</b>	
MTBF (excluding printhead life)	5,000,000 lines.
Printhead MTBF	70,000,000 characters.
<b>Physical Specifications</b>	
Dimensions	374 × 305 × 107 mm (14.7 × 12.0 × 4.2 inches).
Weight	Approximately 5.5 kg (12 lb).



## Interface Options

The HP 82905B Printer is available with the following interface options:

Interface	120V	220V	240V
IEEE Standard 488-1978 (HP-IB)	option 002	option 003	option 004
HP-IL	option 248	option 348	option 448
Serial (RS-232C)	option 240	option 340	option 440
Parallel (Centronics)	option 242	option 342	option 442

Operation of the printer is essentially the same regardless of the interface used. Information particular to the HP-IL, serial, and parallel interfaces is provided in appendices C, D, and E.

### CAUTION

Each of the HP 82905B Printers has been configured for compatibility with a single type of interface. Do not attempt to use the connector located on the back of the printer in the lower right corner unless your printer has been configured with the parallel interface option (options 242, 342, or 442).



4

## Installation

### Unpacking and Inspecting the Printer

Your printer was carefully inspected, both electrically and mechanically, before shipment. Remove it from the shipping carton and carefully inspect the printer for any physical damage that may have occurred during shipment. You should immediately notify your dealer and file a claim with any carriers involved if there is any such damage.

Check that you have received all of the standard accessories listed in section 4. If any item is missing, contact the dealer or sales office where you purchased your printer.

After you have verified that the shipment is complete, remove the clear protective mylar covering from the product identification plate and the control panel.

### Selecting an Operating Site

When selecting a site to operate your printer keep the following guidelines in mind:

- The printer should be placed on a flat surface, such as a tabletop, with enough room behind the printer for the paper separator.
- Don't expose the printer to direct sunlight or greasy dust. Greasy dust may cause the printhead to malfunction.
- Don't operate the printer at temperatures below 5° C (41° F) or above 35° C (95° F).

### Removing the Shipping Screws

When your printer was shipped, shipping screws were installed to protect the printing mechanism from vibration during transportation. These screws must be removed before you operate the printer. Remove the screws by following the procedure below:

1. Carefully stand the printer on its left side on a flat surface.
2. Use a phillips head screwdriver to remove the two shipping screws on the bottom of the printer case.
3. Save the shipping screws for possible later use.
4. Place the printer in its operating position.

### Installing the Ribbon Cartridge

You can easily install the ribbon cartridge in the following manner.

1. Raise the printer lid.
2. Make sure that the scale (paper retainer) is turned toward and touching the platen.

3. Grasp the projection at the center of the cartridge case and push the cartridge down onto the printer mechanism.

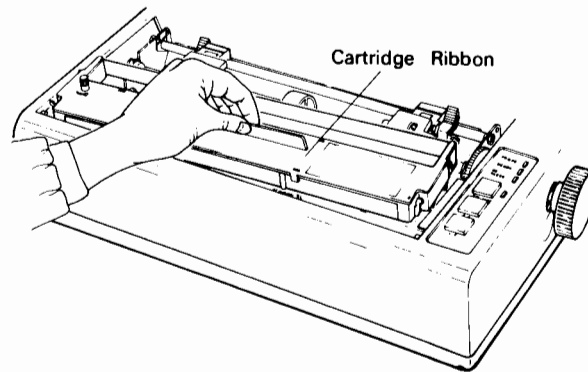

4. Place the ribbon between the printing head nose and the ribbon mask. Do this by turning the ribbon feeding knob on the cartridge case in the direction of the arrow while depressing the ribbon with a pencil (or similar tool).

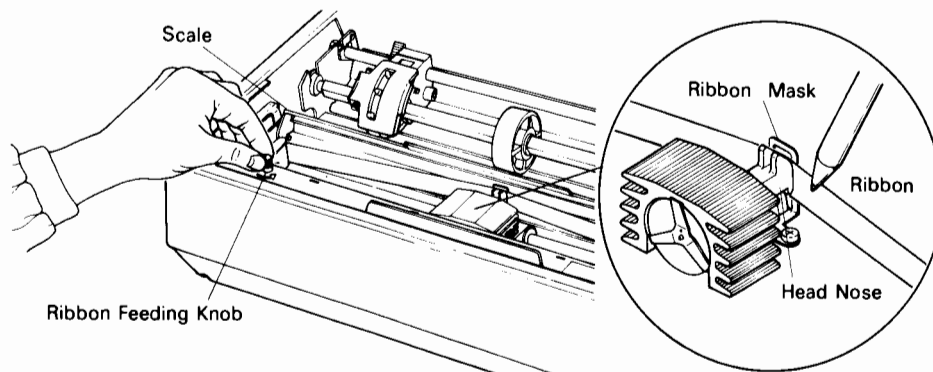

5. Make sure that the ribbon is not twisted or creased and the cartridge is firmly seated in place. Then, tighten the ribbon by turning the ribbon feeding knob in the direction of the arrow.
6. Lower the printer lid.

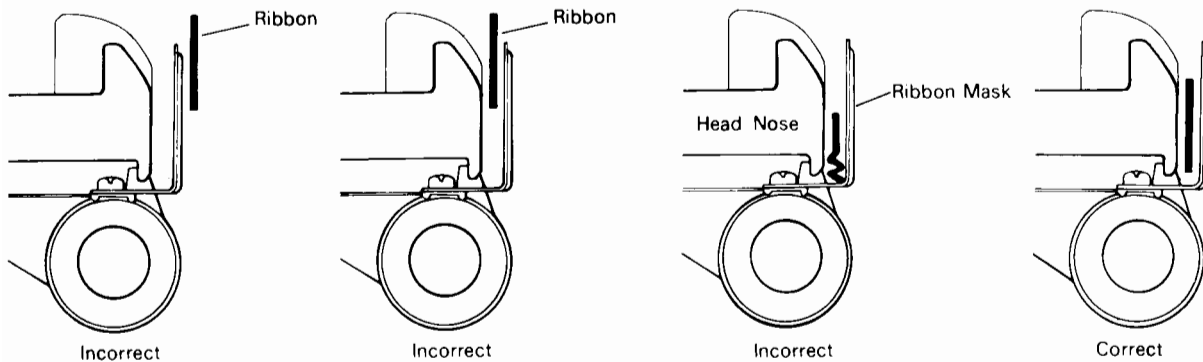

## Installing the Paper Separator

The paper separator helps maintain smooth paper flow through the printer. It is installed by inserting the protrusions on its front edge into the two holes located at the rear of the paper feeding mechanism.

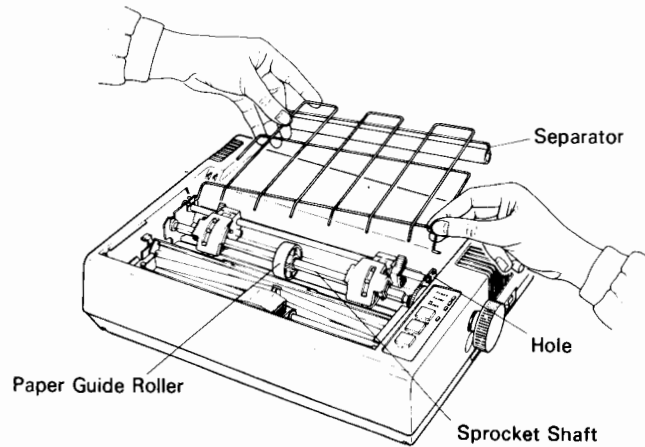

## Loading Paper

The printer accommodates fanfold paper from 4 inches to 10 inches wide. To load the paper:

1. Raise the printer lid.
2. Move the scale toward the front of the printer and away from the platen.
3. If the paper guide roller is not at the center of the sprocket shaft, move it there.
4. Raise the two paper holding covers.
5. Insert the paper between the paper separator frame and the roller.

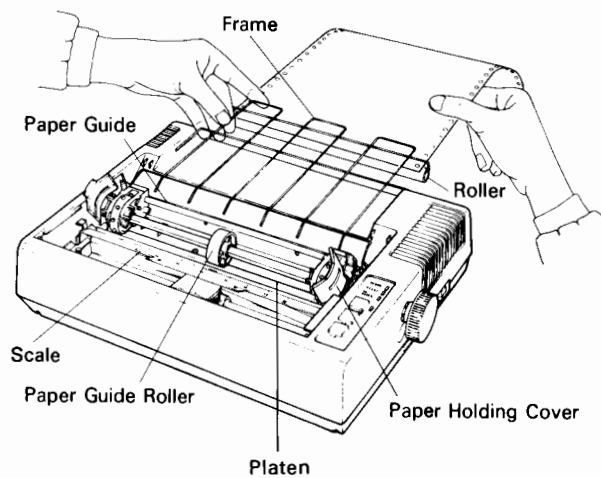

6. Push the paper into the slot between the paper guides at the rear of the printer mechanism. Be sure to pass the paper beneath the upper paper guide.
7. After the leading edge of the paper has emerged from under the platen, pull it through.
8. Release the two paper sprockets by raising the lock levers. Move the sprockets to the paper width. Lock the sprockets in place by lowering the levers.

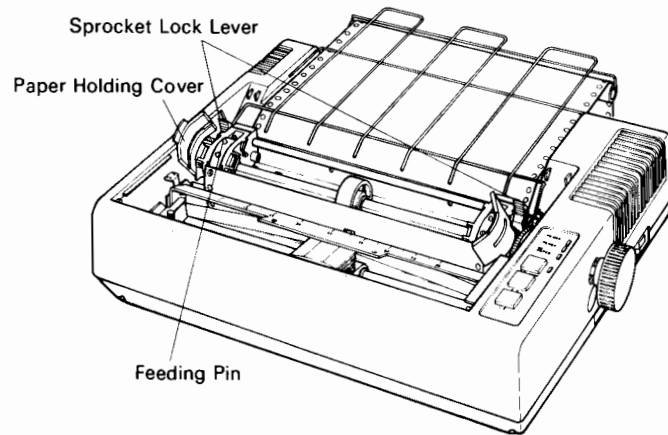

9. Center the paper feed holes over the sprocket pins. Push the scale back against the paper and adjust the tension of the paper. Push the two paper holding covers back down into place.
10. Lower the printer lid.

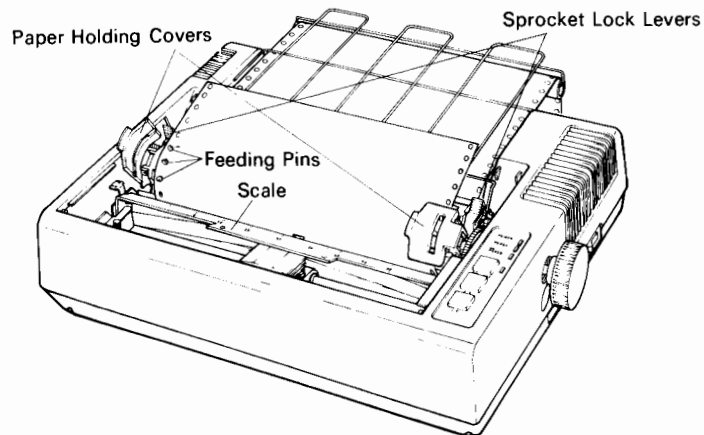

When you operate the printer on a desk or a bench, arrange the paper supply in parallel with the printer as shown below. This arrangement permits the paper to fold in an accordian style.

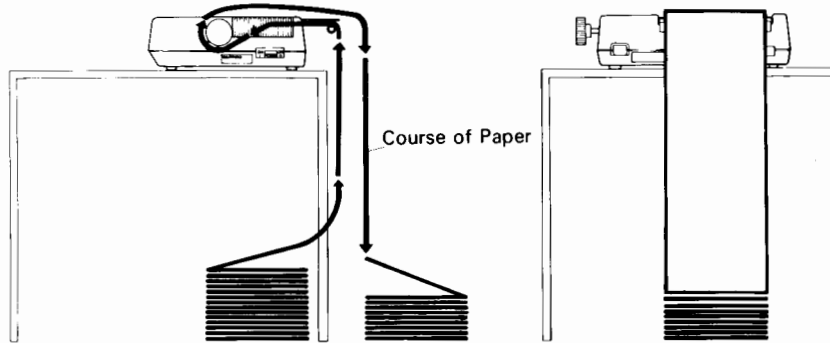

## Setting the Top of Form

The top of form, the position in which the first line of print is printed on the paper, is determined when the printer is turned on. Adjust the paper position with the paper feed knob so that the desired line position is at the print head level and turn the printer on. This position now is the top of form.

The printer has index marks on the paper sprockets which allow you to precisely set the top of form. To use the marks to establish the top of form:

1. Place a pencil mark on the edge of the paper 77 millimeters (3.08 inches) above the perforation and align this mark with the index marks.
2. Place the power switch in the ON position. The printer will now recognize this position as the top of form.

An approximate top of form can be established by manually advancing the paper to the end of the paper separator and turning on the printer.

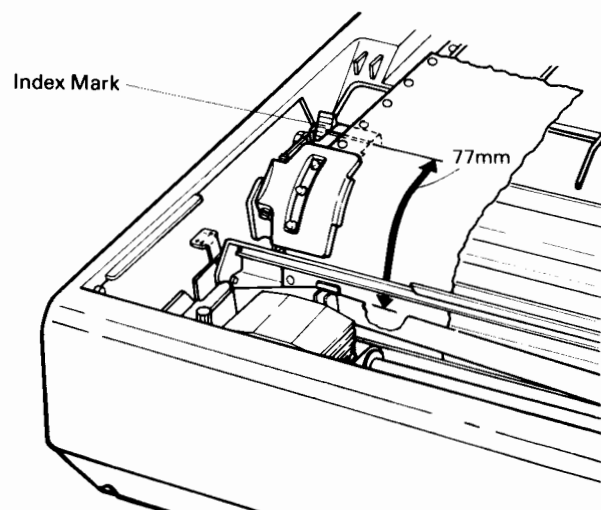

## Adjusting the Printer Head Gap

The gap between the printer head nose and the platen is adjustable. This adjustment is used to vary the printing pressure and to allow the printer to accommodate paper of various thicknesses.

To adjust the gap, move the head adjusting lever located on the left side of the printer frame. If you move the lever toward the front of the printer, the gap will widen and, conversely, if you move it toward the rear of the printer, the gap will narrow. For a single sheet of paper, the center position generally gives good print quality with minimum ribbon wear.

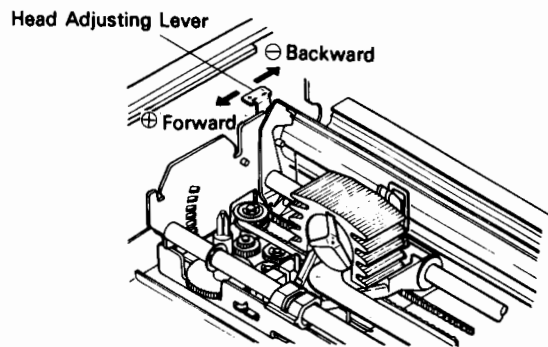

## Connecting Your Printer to a Power Source

The HP 82905B Printer is pre-wired to operate with one of the following four ac power sources:

- 100 Vac, 50/60 Hz.
- 120 Vac, 50/60 Hz.
- 220 Vac, 50/60 Hz.
- 240 Vac, 50/60 Hz.

Before connecting your printer to a power source, check the label on the rear of the printer chassis to make sure the power rating is correct. If your printer has a power rating different from that of the available power source, do not attempt to operate the printer. Contact your dealer or Hewlett-Packard for a replacement unit with the correct power rating.

Power cords supplied for the printer should match the plug requirements in your area. However, power cords with different plugs are available and are illustrated below. If your printer has the wrong power cord for your area, please contact your local dealer or sales representative.



**WARNING**

Use only the power cord specified by Hewlett-Packard for your area. If it is necessary to replace the power cord, the replacement must have the same polarity as the original. Otherwise a safety hazard from electrical shock may exist. In addition, the unit could be extensively damaged.

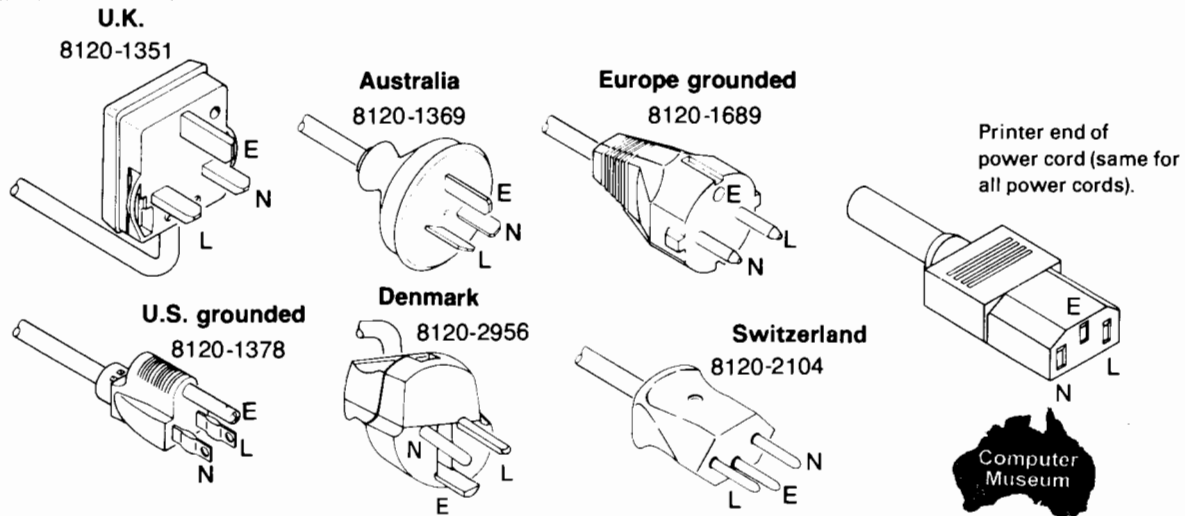

## Connecting the Printer to a Series 80 Computer

If you are connecting your printer to a Series 80 Personal Computer using an HP 82937A Interface module, use the following procedure:

1. Be sure to turn the printer and the computer off before you install the interface module.
2. Plug the HP 82937A Interface module into an I/O port on the computer. If the printer is not the first peripheral to be connected to the interface, attach an accessory HP-IB cable in piggy-back fashion to the connector of a previously connected peripheral device.
3. Plug the HP-IB connector on the interface cable into the HP-IB receptacle on the printer. Secure the connection with the two screws on the HP-IB connector.
4. To route statements to the printer, enter `PRINTER IS 701,80`. This assumes that the HP-IB select code is 7 and that the printer address is 01.

If you are connecting the printer to an HP-87 computer using the computer integrated interface, use one of the cables listed on page 5 of this manual. Then, execute `PRINTER IS 701,80`.

If you are connecting the printer to an HP-86 computer using the computer integrated interface, refer to appendix E.

Refer to appendix C, D, or E if your printer is equipped with an HP-IL, serial, or parallel interface.

### Select Code Switch

The select code of the HP 82937A HP-IB Interface module and the internal HP-87 interface is preset to 7 at the factory. If you wish to change that setting, please refer to the *HP-IB Owner's Manual* for instructions.

The select code of the HP-86 printer/disc interface is factory preset to 7 and cannot be changed.

For computer systems other than HP Series 80 Personal Computers, refer to the HP-IB information for that system.

## Device Address

Each device used with the IEEE Standard 488 interface bus must have a unique address. The device address for HP 82905B Printer is preset to 1 at the factory.

A six segment switch on the interface printed circuit assembly is used to assign the printer's address. Access to this switch is gained by removing the switch cover on the upper case of the printer. Before changing the switch setting make sure you turn off the printer.

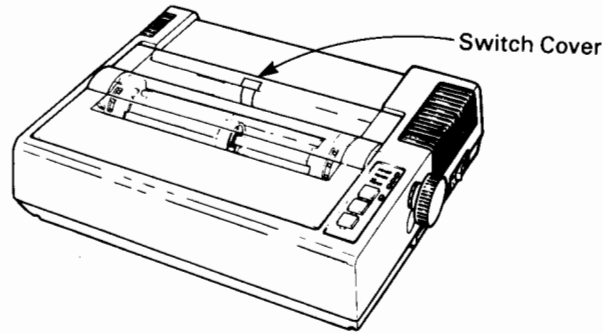

The individual switch segments can be independently set to the ON or OFF position labeled on the switch with the tip of a pencil or similar tool. The ON position of each segment corresponds to binary 1 and the OFF position corresponds to binary 0. Segment six is not used so there are 31 (0 through 30) possible addresses. The following table shows the possible switch settings:

Switch Segment					Address
1 (LSB)	2	3	4	5 (MSB)	
0	0	0	0	0	0
1	0	0	0	0	1
0	1	0	0	0	2
1	1	0	0	0	3
0	0	1	0	0	4
1	0	1	0	0	5
0	1	1	0	0	6
1	1	1	0	0	7
0	0	0	1	0	8
1	0	0	1	0	9
0	1	0	1	0	10
1	1	0	1	0	11
0	0	1	1	0	12
1	0	1	1	0	13
0	1	1	1	0	14
1	1	1	1	0	15
0	0	0	0	1	16
1	0	0	0	1	17
0	1	0	0	1	18
1	1	0	0	1	19
0	0	1	0	1	20
1	0	1	0	1	21
0	1	1	0	1	22
1	1	1	0	1	23
0	0	0	1	1	24
1	0	0	1	1	25
0	1	0	1	1	26
1	1	0	1	1	27
0	0	1	1	1	28
1	0	1	1	1	29
0	1	1	1	1	30

The drawing below shows the switch set to an address of 1:

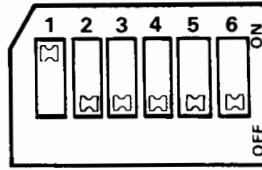

## Connecting the Printer to an HP 125 Computer

If your printer is equipped with a serial interface, refer to appendix E for instructions on connecting the printer and configuring the HP 125 for communication with the printer.

If your printer is equipped with an HP-IB interface, use the procedure described in the section entitled “Installing an HP-IB Printer” in the *Getting Started With Your HP 125* manual.

## Connecting the Printer to Other Devices

If you are connecting the printer to a device other than a Series 80 or HP 125 computer, follow the interfacing guidelines for that particular system. If your printer is equipped with an HP-IL, serial, or parallel interface, refer to appendix C, D, or E for additional information.

## Self-Test

The HP 82905B Printer has a self-test feature that is useful in verifying proper operation of the printer. The self-test prints all of the standard characters provided by the printer. It is a good idea to execute the self-test at the time of installation and at any other time you wish to confirm that the printing mechanism is operating properly.

```

789: ; <=>?@ABCDEFGHIJKLMN O PQRSTU VWXYZ[\]^_`abcdefg
89: ; <=>?@ABCDEFGHIJKLMN O PQRSTU VWXYZ[\]^_`abcdefgh
9: ; <=>?@ABCDEFGHIJKLMN O PQRSTU VWXYZ[\]^_`abcdefghi
: ; <=>?@ABCDEFGHIJKLMN O PQRSTU VWXYZ[\]^_`abcdefghij
; <=>?@ABCDEFGHIJKLMN O PQRSTU VWXYZ[\]^_`abcdefghijkl

```

To execute the self-test, place the POWER switch in the ON position *while* pressing the LF switch.



## Operating the Printer

### Introduction

This section gives you information on how to operate your HP 82905B Printer. Off-line operation as well as on-line operation in the text and graphics modes is described.

### Front Panel Switches and Indicators

There are three switches and four indicators (green LEDs) on the printer control panel and a power switch on the right side of the printer case.

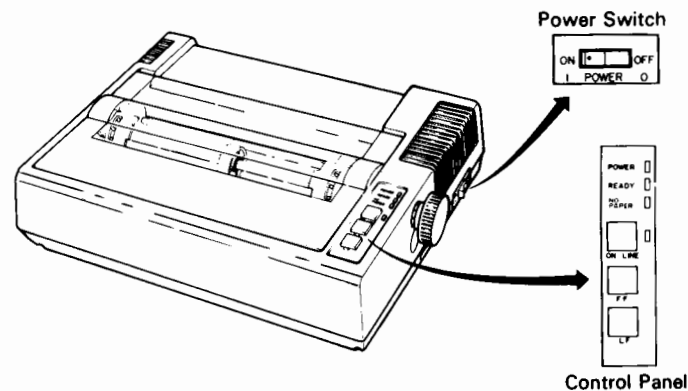

The switches and indicators are listed along with their functions in the following table:

Switch/Indicator	Function
Switch	
POWER	Controls ac power to the printer.
ON LINE	This switch switches the printer between the remote and local mode. It does not function while the printer is printing.  If ON LINE is pressed while data is being sent to the print buffer, the printer immediately enters the local mode.
FF (Form Feed)	When you press this switch, the paper advances to the next top-of-form position. The FF switch is operational only in the local mode.
LF (Line Feed)	When you press this switch, the paper advances one line. The LF switch is operational only in the local mode.
Indicator	
POWER	When this indicator is lighted, the printer is receiving ac power.
READY	When this indicator is lighted, the printer is ready to receive data.
NO PAPER	When this indicator is lighted, the paper supply is nearly exhausted. If this indicator lights when there is still paper in the printer, check to see if the paper is properly installed.
ON LINE	When this indicator is lighted, the printer is in the remote mode and ready to receive data or control codes from the computer.

## Power On

After all of the system connections are complete (refer to section 2), you can turn the printer on using the power switch on the right side of the printer case. All of the system components should be turned on before the host computer is turned on.

## Preset Operating Conditions

When your printer was shipped from the factory its operating functions were preset to the following:

- Line Spacing: 6 lines per inch.
- Form Length: 11 inches.
- Columns per Line: 80.

## Out-of-Paper Detection

When the out-of-paper detector (a reed switch on the paper guide) detects that the paper supply is low, printing stops and a buzzer sounds for approximately 10 seconds. If this should happen, follow the instructions in section 2 for installing new paper. To resume operation, press ON LINE.

## Text Mode

The HP 82905B Printer has two modes of operation when used on line with a computer: text and graphics. Text mode is the normal operating mode for the printer and will probably be the one you use most often. When the printer is first turned on, it operates in text mode until instructed to change to the graphics mode.

In text mode, all of the printer functions can be controlled by ASCII (American Standard Code for Information Interchange) codes (see appendix B) transmitted as data to the printer. These codes can be transmitted separately to initialize the printer for a given print job, embedded in the data to be printed, or as a combination of both methods. Control codes are not printed by the printer.

In the control codes, the following notation is used:

- Lower case “c” indicates the CTRL key is pressed while typing the letter or symbol. Letters or symbols shown are for HP Series 80 Personal Computers. If you are using a different computer, check with the manufacturer’s literature to determine the correct key for your computer.

The control code “escape (ESC)” allows additional characters to be transmitted as part of the code. Control codes containing “ESC” are known as escape sequences. The HP 82905B Printer recognizes two types of escape sequences: two-character escape sequences and parameterized escape sequences.

The two-character escape has the following general form:

ESC X

where,

**X** is an ASCII character from 48 (0) through 126 (~).

The parameterized escape sequence has the following general form:

ESC X y #1 z1 #2 z2 ... zn

where,

**X** is the parameterized character. This character indicates that this escape sequence is parameterized. It may be an ASCII character from 32 (space) through 47 (/).

**y** is the group character. This character specifies the type or group of control being performed. It may be an ASCII character from 96 (') through 126 (~).

**#i** is the value field. This character specifies a value. It may be the ASCII character 48 (0) through 57 (9), 32 (space), 43 (+), or 45 (-). This is an optional string and if it is not present, the value is zero. A "+" or "-" character preceding a value field converts the numeric argument to a relative value.

**zi** is the parameter character. It specifies the parameter to which the value field, if any, applies. It may be the ASCII character 96 (') through 126 (~). It is optional if only one parameter is specified.

**zn** is the terminating character. This character is the same as the parameter, but it is also used to terminate the escape sequence. It may be an ASCII character from 64 (@) through 94 (<).

Escape sequences with a common group character may be combined by using a lower case terminating character to terminate each individual escape sequence and an upper case character to terminate the entire escape sequence. This is shown, for example, by "a/A" in the escape sequence descriptions which follow.

For example, with an HP Series 80 Personal Computer,

```
PRINT CHR$(27)&"&166p6f1L"
```

is a combination of three escape sequences (the common group designator is the "l"):

PRINT CHR\$(27)&"&166P"	66 line logical page
PRINT CHR\$(27)&"&16F"	6 line text
PRINT CHR\$(27)&"&11L"	enable skip-over-perforation

## General Control Codes

### Bell (G<sup>c</sup> or CHR\$(7))

This control code causes the printer's buzzer to sound for one second.

### Line Feed (J<sup>c</sup> or CHR\$(10))

This control code causes all data stored in the print buffer to be printed and advances the paper one line.

### Carriage Return (M<sup>c</sup> or CHR\$(13))

This control code causes all data stored in the print buffer to be printed and moves the carriage to the first printing position on the same line.

**Shift Out (N<sup>c</sup> or CHR\$(14))**

This control code enables the alternate character set. This character set replaces the standard character set until the control code shift in is received. Both the standard and the alternate character set are listed in appendix B.

**Shift In (O<sup>c</sup> or CHR\$(15))**

This control code cancels the shift out code and restores the standard character set.

**Escape (I<sup>c</sup> or CHR\$(27))**

This control code prepares the printer to receive instructions.

**Reset (ESC E)**

This escape sequence resets the printer to its preset operating condition (power on).

**Form Control****Form Feed (L<sup>c</sup> or CHR\$(12))**

This control code advances the paper vertically to the next predetermined top-of-form position.

**Set Text Length (ESC & 1 # f/F)**

This escape sequence sets the length of the text within a logical page. The value field, #, contains the number of lines of text. If a text length of zero or greater than the logical page length is specified, the command is ignored.

For example, to set the form length to 52 lines with an HP Series 80 Personal Computer use the command:

```
PRINT CHR$(27)&"&152F"
```

**Set Logical Page Length (ESC & 1 # p/P)**

This escape sequence sets the length of the logical page. The value field, #, contains the number of lines in the logical page. The maximum number of lines allowed in a logical page is 128. If a page length greater than 128 is specified, the command is ignored. The power-on default for page length is 11 inches.

To set the page length to 66 lines with an HP Series 80 Personal Computer, the command is:

```
PRINT CHR$(27)&"&166P"
```

**Skip Over Perforation (ESC & 1 # l/L)**

This escape sequence enables or disables the skip-over-perforation function of the printer. A 1 in the value field turns on the function and a 0 turns it off. The default state is skip-over-perforation mode off.

To turn the function on with an HP Series 80 Personal Computer, the command is:

```
PRINT CHR$(27)&"&11L"
```



## Spacing and Print Mode Selection

### Vertical Line Spacing (ESC & 1 # d/D)

This escape sequence sets the vertical line spacing to the number of lines per inch specified in the value field, #. Acceptable values are: 6, 8, 9, 12, 18, 24, 36, and 72. The default is 6 lines per inch.

To set vertical line spacing to 9 lines per inch with an HP Series 80 Personal Computer, enter:

```
PRINT CHR$(27)&"&19D"
```



### Select Print Mode (ESC & k # s/S)

This escape sequence is used to select the print mode of the printer according to the following table. The value field specifies the mode.

Mode	Value Field	Horizontal Pitch	Char/Line
Normal	0	10.00	80
Expanded	1	5.00	40
Compressed	2	16.50	132
Compressed, Expanded	3	8.25	66
Emphasized	9	10.00	80

Normal and expanded or compressed and compressed, expanded print can be mixed on the same line. Other combinations may cause unexpected results.

### Print Examples

Entering `PRINT CHR$(27)&"&k0S`This is a line of normal type." prints:

```
This is a line of normal type.
```

Entering `PRINT CHR$(27)&"&k1S`This is a line of expanded type." prints:

```
This is a line of expanded type.
```

Entering `PRINT CHR$(27)&"&k2S`This is a line of compressed type." prints:

```
This is a line of compressed type.
```

Entering `PRINT CHR$(27)&"&k3S`This is a line of compressed, expanded type." prints:

```
This is a line of compressed, expanded type.
```

Entering `PRINT CHR$(27)&"&k9S`This is a line of emphasized type." prints:

```
This is a line of emphasized type.
```

## Graphics Mode

The HP 82905B Printer has two graphics modes that give you the ability to produce virtually any graphic display using patterns of printed data under software control. When graphics mode is enabled, the entire page becomes a matrix of dot positions that the print head can access. There are 480 dot positions on a line in the standard graphics mode and 960 dot positions in the dual-density graphics mode.

The printer utilizes a raster scan technique of producing graphics which prints vertical columns of eight dots across the page during each pass of the print head. Dot patterns are the “image” of the binary equivalent of the ASCII characters transmitted to the printer.

The illustration below shows the relationships between the dot wires in the print head and the binary data. Only the upper eight dot wires can be controlled in graphics mode.

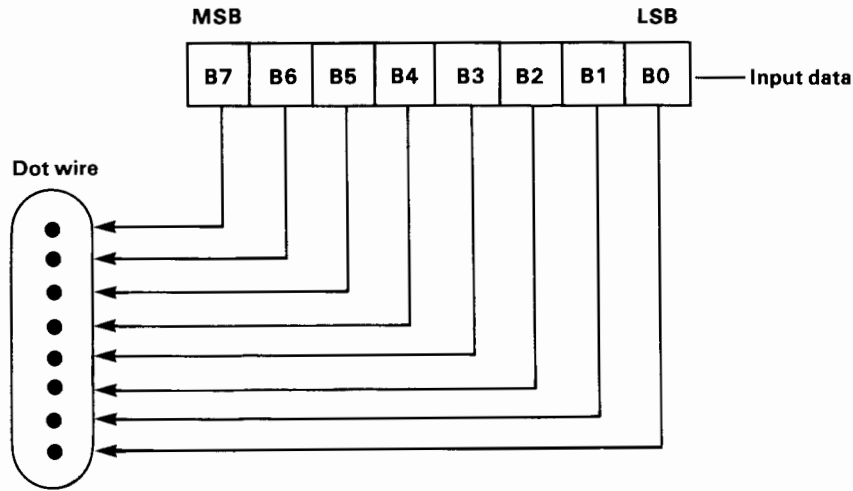

If a bit is “1”, the dot is printed; if it is “0”, the dot is not printed. For example, assume that the data consists of the ASCII characters “ and P:

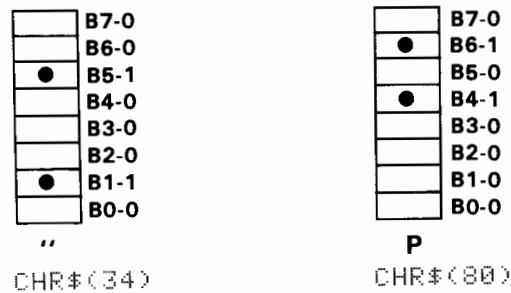

### Initiating Graphics Mode

The escape sequence to initiate graphics mode is:

```
ESC * b # g/G
```

The value field specifies the decimal number of bytes of graphic information to be printed.

For example with an HP Series 80 Personal Computer the command:

```
PRINT CHR$(27)&"*b128G"
```

prepares the printer to print 128 bytes of graphic data.

The kind of graphics output (standard or dual-density) is determined by which print mode the printer is in when it receives the graphics command. If the printer is in normal or expanded print mode, its graphic output is standard; however, if it is in compressed or compressed expanded print mode, its graphics output is dual-density.

Because only eight of the nine dot wires print in the graphics mode, the vertical spacing of the printer should be changed to nine lines per inch in order to eliminate blank spaces between lines. With an HP Series 80 Personal Computer, the appropriate command is:

```
PRINT CHR$(27)&"&190"
```

## Graphics Print Example

This sample program illustrates how you can create new symbols using the graphics mode. The program causes the printer to print the letters "AB," a small rectangle, and then the letters "CD."

Input:

```
100 DIM A$(5)
110 A$=CHR$(254)&CHR$(130)&CHR$(130)&CHR$(130)&CHR$(254)
120 PRINT "AB";
130 PRINT CHR$(27)&"*b5G"&A$
140 PRINT "CD"
999 END
```

Output:

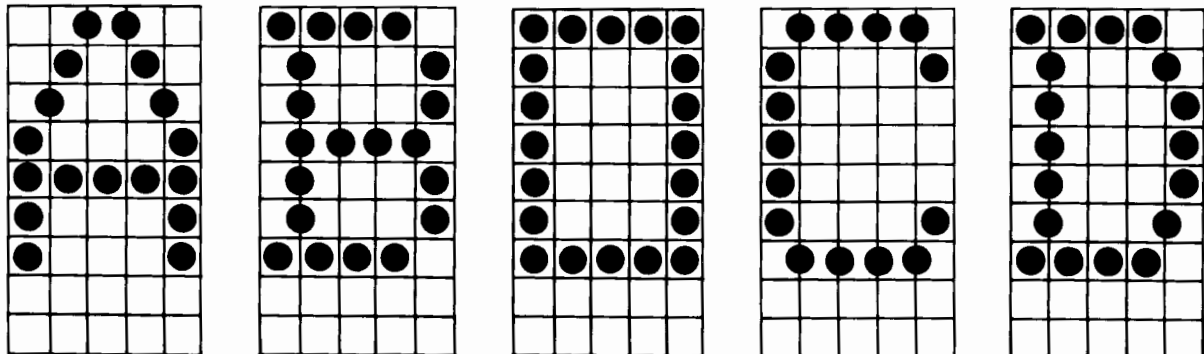



## Accessories, Maintenance, and Service

### Accessories

The following accessories are supplied with each printer:

- Power Cord.
- Owner's Manual.
- Ribbon Cartridge.

Additional accessories can be ordered as follows:

- HP 92154P Replacement Print Head.
- HP 92156A Ribbon Cartridges (Two-Pack).

### Maintenance

The HP 82905B Printer doesn't require any regular maintenance other than cleaning of the exterior surface. It should be cleaned with a soft brush to remove paper dust and particles approximately every two months. A mild detergent and water solution is recommended for cleaning.

### Parts Replacement

Other than the ribbon cartridge, the printer has only one owner-replaceable part: the print head.

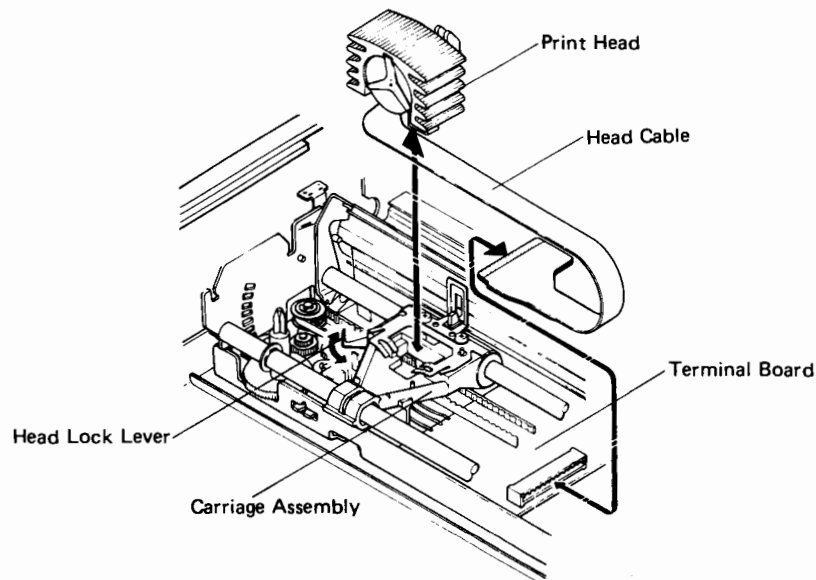

If, for some reason, the print head must be replaced, use the following procedure:

**CAUTION**

The carriage assembly should not be moved while the print head is removed from the carriage.

1. Remove the ribbon cartridge as described in section 2.
2. Turn the head lock lever clockwise and lift the print head out of the carriage assembly.
3. Carefully remove the cable connecting the print head to the terminal board.
4. Install a new print head on the carriage assembly and return the head lock lever to its original position.
5. Carefully insert the new cable into the terminal board connector.
6. Reinstall the ribbon cartridge.

## Service

If at any time you suspect that your printer is malfunctioning (other than the print head), run the self-test (see section 2). The self-test exercises most of the printer mechanical functions and electronics. If the printer fails the self-test, the printer requires service. However if the self-test passes, refer to the service information for your computer system. In the case of a printer that is being used with a plug-in interface module, refer to the computer owner's documentation and to documentation accompanying the interface module for service information.

## Warranty Information

The complete warranty statement is included in the information packet shipped with your printer. Additional copies may be obtained from any authorized Hewlett-Packard dealer, or the sales and service office where you purchased your printer.

If you have questions concerning the warranty, please contact:

**In the U.S.:** One of the Field Repair Centers listed on the Service Information Sheet packaged with the printer.

**In Europe:**

Hewlett-Packard S.A.  
7, rue du Bois-du-Lan  
P.O. Box  
CH-217 Meyrin 2  
Geneva  
Switzerland  
Tel. (22) 82 70 00

**Other Countries:**

Hewlett-Packard Intercontinental  
3495 Deer Creek Rd.  
Palo Alto, California 94304  
U.S.A.  
Tel. (415) 857-1501

**How to Obtain Repair Service**

Not all Hewlett-Packard facilities offer service for the HP 82905B Printer. For information on service in your area, contact your nearest authorized HP dealer or the nearest Hewlett-Packard sales and service office.

If your printer malfunctions and repair is required, you can help assure efficient servicing by having the following items with your printer at the time of service:

1. A description of the configuration of the system you were using at the time of failure.
2. A brief description of the malfunction symptoms for the service personnel.
3. Printouts or other material that illustrate the problem area(s).
4. A copy of the sales slip or other proof of purchase to establish the warranty coverage period.

**Serial Number**

Each printer carries an individual serial number. It is a good idea to keep a separate record of this number. Should your printer be stolen or lost the serial number is often necessary for tracing and recovery, as well as any insurance claims. Hewlett-Packard does not maintain records of individual owner's names and printer serial numbers.

**General Shipping Instructions**

Should you ever need to ship the printer, be sure that all components are packed in a protective package (use the original shipping case), to avoid in-transit damage. If you saved the shipping screws as suggested in section 2, re-install them before shipment. We suggest that you always insure shipments.

If you happen to be outside of the country where you bought your printer, contact the nearest authorized dealer or local Hewlett-Packard office for shipping instructions. All customs duties are your responsibility.

## Potential for Radio/Television Interference (For U.S.A. Only)

The HP 82905B Printer generates and uses radio frequency energy and may cause interference to radio and television reception. Your printer complies with the specifications in Subpart J of Part 15 of the Federal Communications Commission rules for a Class B computing device. These specifications provide reasonable protection against such interference in a residential installation. However, there is no guarantee that interference will not occur in a particular installation. If the printer does cause interference to radio or television reception, which can be determined by turning the printer off and on, you can try to eliminate the interference problem by doing one or more of the following:

- Reorient the receiving antenna.
- Change the position of the printer with respect to the receiver.
- Move the printer away from the receiver.
- Plug the printer into a different outlet so that the printer and the receiver are on different branch circuits.

If necessary, consult an authorized HP dealer or an experienced radio/television technician for additional suggestions. You may find the following booklet, prepared by the Federal Communications Commission, helpful: *How to Identify and Resolve Radio/TV Interference Problems*. This booklet is available from the U.S. Government Printing Office, Washington, D.C. 20402, Stock No. 004-000-00345-4.



**Notes**



# Reference Tables

## HP Series 80 and ASCII Character Sets\*

EQUIVALENT FORMS				EQUIVALENT FORMS				EQUIVALENT FORMS				EQUIVALENT FORMS			
Series 80 Char.	Binary	ASCII	Dec	Series 80 Char.	Binary	ASCII	Dec	Series 80 Char.	Binary	ASCII	Dec	Series 80 Char.	Binary	ASCII	Dec
@ <sup>c</sup>	00000000	NULL	0	SPACE	00100000	space	32	Ⓔ	01000000	@	64	˘	01100000	'	96
A <sup>c</sup>	00000001	SOH	1	!	00100001	!	33	Ⓕ	01000001	A	65	Ⓕ	01100001	a	97
B <sup>c</sup>	00000010	STX	2	"	00100010	"	34	Ⓖ	01000010	B	66	Ⓖ	01100010	b	98
C <sup>c</sup>	00000011	ETX	3	#	00100011	#	35	Ⓖ	01000011	C	67	Ⓖ	01100011	c	99
D <sup>c</sup>	00000100	EOT	4	\$	00100100	\$	36	Ⓖ	01000100	D	68	Ⓖ	01100100	d	100
E <sup>c</sup>	00000101	ENQ	5	%	00100101	%	37	Ⓖ	01000101	E	69	Ⓖ	01100101	e	101
F <sup>c</sup>	00000110	ACK	6	&	00100110	&	38	Ⓖ	01000110	F	70	Ⓖ	01100110	f	102
G <sup>c</sup>	00000111	BEL	7	'	00100111	'	39	Ⓖ	01000111	G	71	Ⓖ	01100111	g	103
H <sup>c</sup>	00001000	BS	8	(	00101000	(	40	Ⓖ	01001000	H	72	Ⓖ	01101000	h	104
I <sup>c</sup>	00001001	HT	9	)	00101001	)	41	Ⓖ	01001001	I	73	Ⓖ	01101001	i	105
J <sup>c</sup>	00001010	LF	10	*	00101010	*	42	Ⓖ	01001010	J	74	Ⓖ	01101010	j	106
K <sup>c</sup>	00001011	VT	11	+	00101011	+	43	Ⓖ	01001011	K	75	Ⓖ	01101011	k	107
L <sup>c</sup>	00001100	FF	12	,	00101100	,	44	Ⓖ	01001100	L	76	Ⓖ	01101100	l	108
M <sup>c</sup>	00001101	CR	13	-	00101101	-	45	Ⓖ	01001101	M	77	Ⓖ	01101101	m	109
N <sup>c</sup>	00001110	SO	14	.	00101110	.	46	Ⓖ	01001110	N	78	Ⓖ	01101110	n	110
O <sup>c</sup>	00001111	SI	15	/	00101111	/	47	Ⓖ	01001111	O	79	Ⓖ	01101111	o	111
P <sup>c</sup>	00010000	DLE	16	0	00110000	0	48	Ⓖ	01010000	P	80	Ⓖ	01110000	p	112
Q <sup>c</sup>	00010001	DC1	17	1	00110001	1	49	Ⓖ	01010001	Q	81	Ⓖ	01110001	q	113
R <sup>c</sup>	00010010	DC2	18	2	00110010	2	50	Ⓖ	01010010	R	82	Ⓖ	01110010	r	114
S <sup>c</sup>	00010011	DC3	19	3	00110011	3	51	Ⓖ	01010011	S	83	Ⓖ	01110011	s	115
T <sup>c</sup>	00010100	DC4	20	4	00110100	4	52	Ⓖ	01010100	T	84	Ⓖ	01110100	t	116
U <sup>c</sup>	00010101	NAK	21	5	00110101	5	53	Ⓖ	01010101	U	85	Ⓖ	01110101	u	117
V <sup>c</sup>	00010110	SYNC	22	6	00110110	6	54	Ⓖ	01010110	V	86	Ⓖ	01110110	v	118
W <sup>c</sup>	00010111	ETB	23	7	00110111	7	55	Ⓖ	01010111	W	87	Ⓖ	01110111	w	119
X <sup>c</sup>	00011000	CAN	24	8	00111000	8	56	Ⓖ	01011000	X	88	Ⓖ	01111000	x	120
Y <sup>c</sup>	00011001	EM	25	9	00111001	9	57	Ⓖ	01011001	Y	89	Ⓖ	01111001	y	121
Z <sup>c</sup>	00011010	SUB	26	:	00111010	:	58	Ⓖ	01011010	Z	90	Ⓖ	01111010	z	122
[ <sup>c</sup>	00011011	ESC	27	;	00111011	;	59	Ⓖ	01011011	[	91	Ⓖ	01111011	{	123
\ <sup>c</sup>	00011100	FS	28	<	00111100	<	60	Ⓖ	01011100	\	92	Ⓖ	01111100		124
] <sup>c</sup>	00011101	GS	29	=	00111101	=	61	Ⓖ	01011101	]	93	Ⓖ	01111101	}	125
^ <sup>c</sup>	00011110	RS	30	>	00111110	>	62	Ⓖ	01011110	^	94	Ⓖ	01111110	~	126
_ <sup>c</sup>	00011111	US	31	?	00111111	?	63	Ⓖ	01011111	_	95	Ⓖ	01111111	DEL	127

\*The HP 82905B Printer prints the standard ASCII character set which corresponds to decimal positions 32 to 126 in the above table.

## HP 82905B Printer Control Codes and Escape Sequences

HP 82905B Printer Control Codes and Escape Sequences

Description	Function	Control Code or Escape Sequence
<b>General</b>		
Sound the buzzer.	Bell (BEL)	G <sup>c</sup>
Print data in the buffer and advance paper one line.	Line Feed (LF)	J <sup>c</sup>
Print data in print buffer and move carriage to the first character position on the pending line.	Carriage Return (CR)	M <sup>c</sup>
Enable alternate character set.	Shift Out (SO)	N <sup>c</sup>
Prepare printer to receive instructions.	Escape (ESC)	[ <sup>c</sup>
Restore standard character set.	Shift In (SI)	O <sup>c</sup>
Reset printer to power on state.	Reset	ESC E
<b>Form Control</b>		
Advance paper vertically to next top of form.	Form Feed (FF)	L <sup>c</sup>
Set length of text (in number of lines).	Set Text Length	ESC & 1 # f/F
Set page length (in number of lines).	Set Logical Page Length	ESC & 1 # p/P 1<#<128
Enable/disable the skip-over-perforation function.	Skip Over Perforation	ESC & 1 # 1/L #: 1 = enable 0 = disable
<b>Spacing and Print Mode Selection</b>		
Set the vertical spacing to a specified number of lines per inch.	Vertical Line Spacing	ESC & 1 # d/D # = 6, 8, 9, 12, 18, 24, 36, or 72
Select either normal, expanded, compressed, compressed expanded, or emphasized printing mode.	Select Print Mode	ESC & k # s/S #: 0—Normal 1—Expanded 2—Compressed 3—Compressed, Expanded 9—Emphasized
<b>Graphics Mode</b>		
Invoke graphics mode.	Initiate Graphics Mode	ESC * b # g/G # = number of data bytes of graphic information to be printed.

Lower case “c” indicates that the **CTRL** key is pressed while typing the letter or symbol. The keys shown are for HP Series 80 Personal Computers. If you are using a different computer, check with the manufacturer’s literature to determine the correct key for your system.

**Notes**



# Character Sets

## HP 82905B Standard Character Set

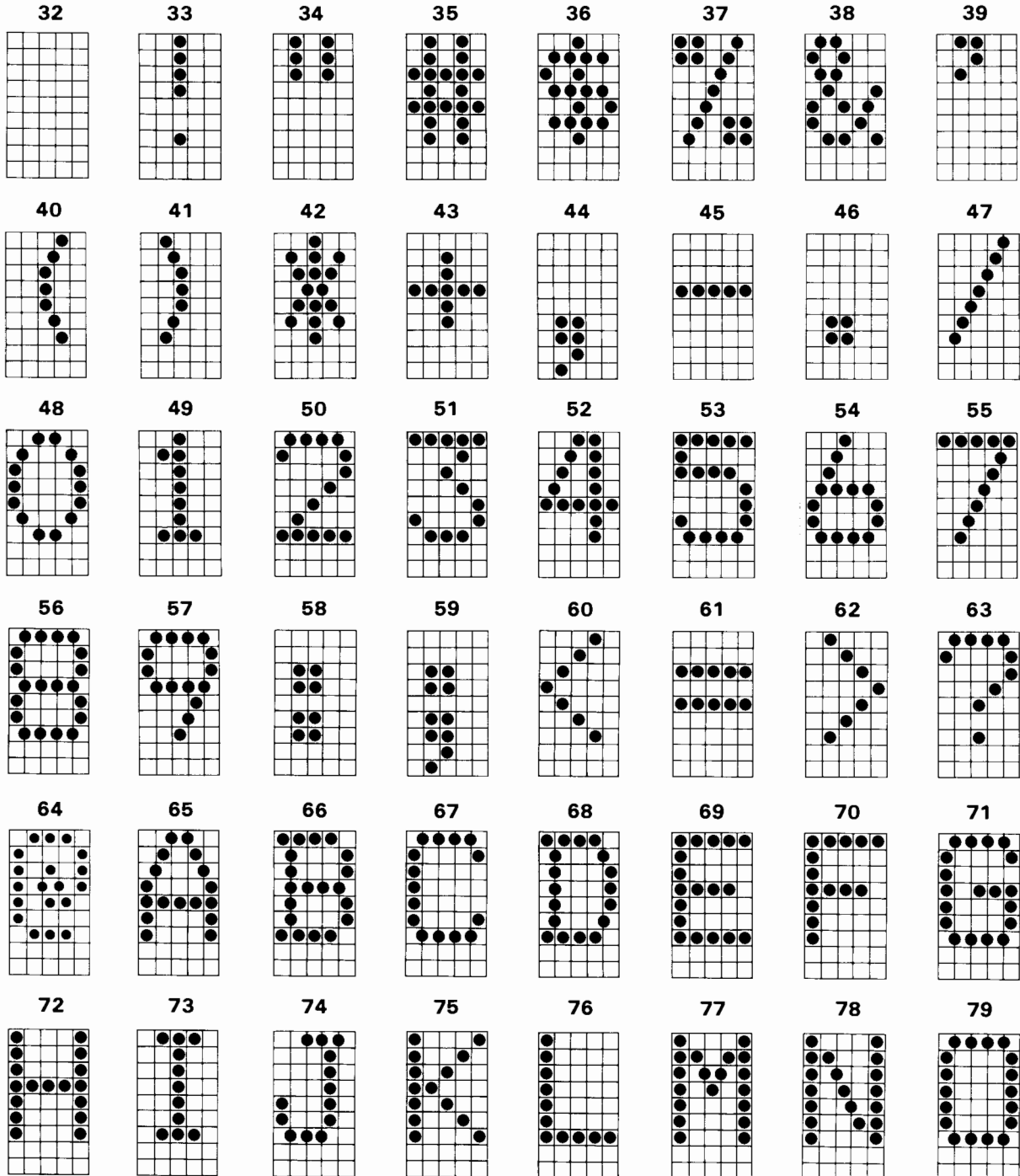

80

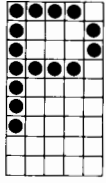

81

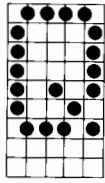

82

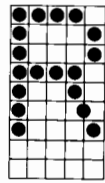

83

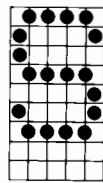

84

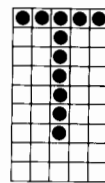

85

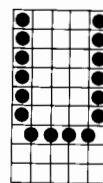

86

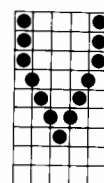

87

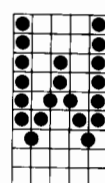

88

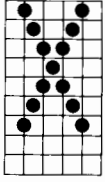

89

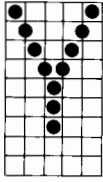

90

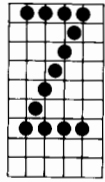

92

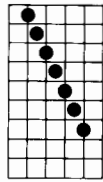

93

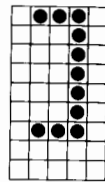

91

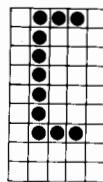

94

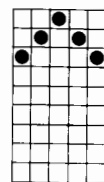

95

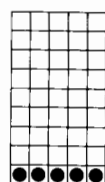

96

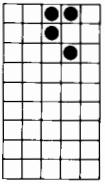

97

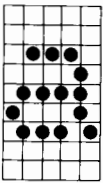

98

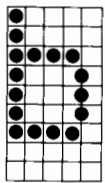

99

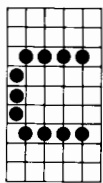

100

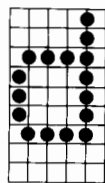

101

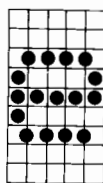

102

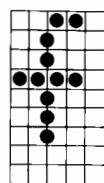

103

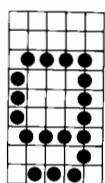

104

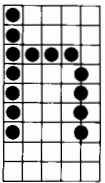

105

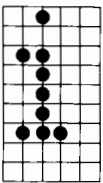

106

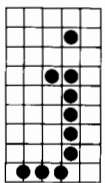

107

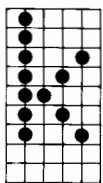

108

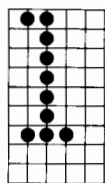

109

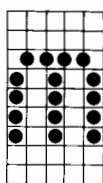

110

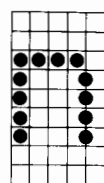

111

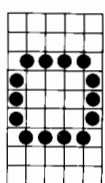

112

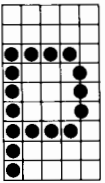

113

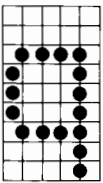

114

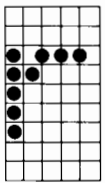

115

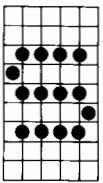

116

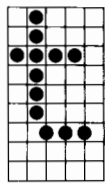

117

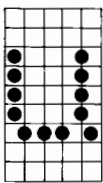

118

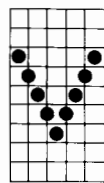

119

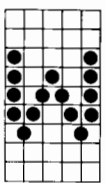

120

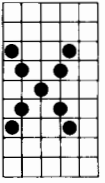

121

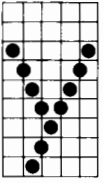

122

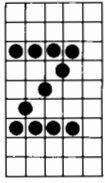

123

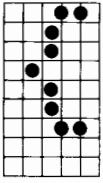

124

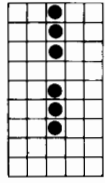

125

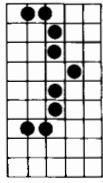

126

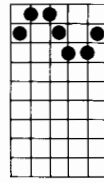

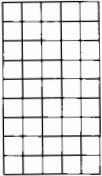
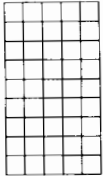
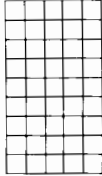
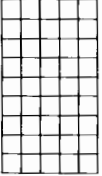
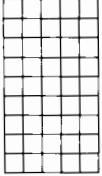
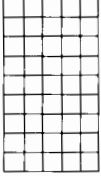
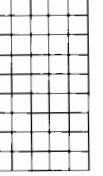
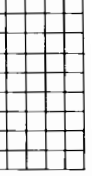
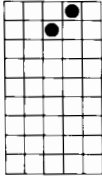
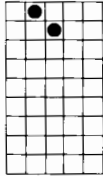
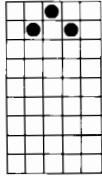
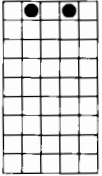
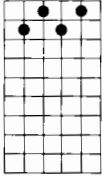
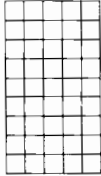
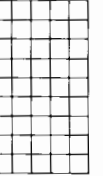
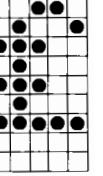
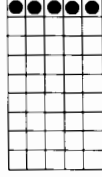
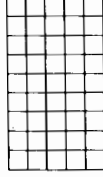
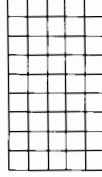
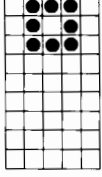
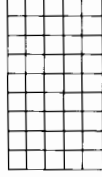
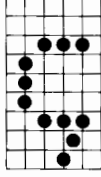
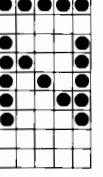
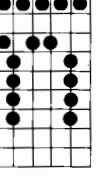
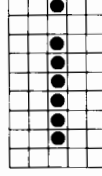
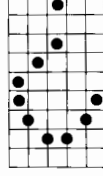
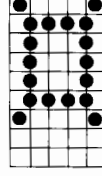
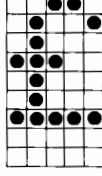
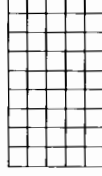
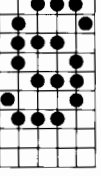
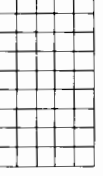
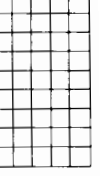
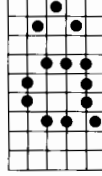
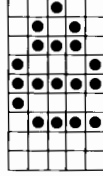
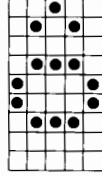
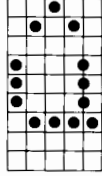
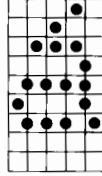
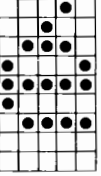
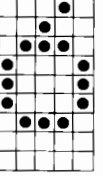
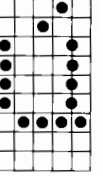
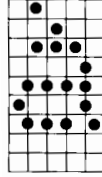
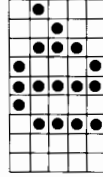
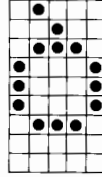
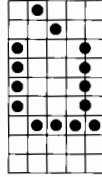
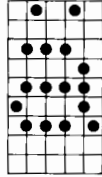
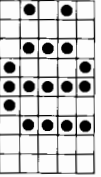
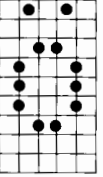
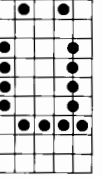
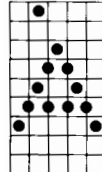
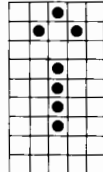
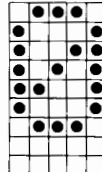
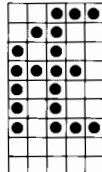
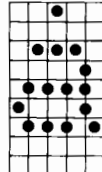
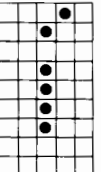
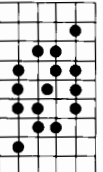
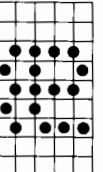

## HP 82905B Alternate Character Set \*

32 (160)	33 (161)	34 (162)	35 (163)	36 (164)	37 (165)	38 (166)	39 (167)
							
40 (168)	41 (169)	42 (170)	43 (171)	44 (172)	45 (173)	46 (174)	47 (175)
							
48 (176)	49 (177)	50 (178)	51 (179)	52 (180)	53 (181)	54 (182)	55 (183)
							
56 (184)	57 (185)	58 (186)	59 (187)	60 (188)	61 (189)	62 (190)	63 (191)
							
64 (192)	65 (193)	66 (194)	67 (195)	68 (196)	69 (197)	70 (198)	71 (199)
							
72 (200)	73 (201)	74 (202)	75 (203)	76 (204)	77 (205)	78 (206)	79 (207)
							
80 (208)	81 (209)	82 (210)	83 (211)	84 (212)	85 (213)	86 (214)	87 (215)
							

88 (216)

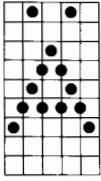

89 (217)

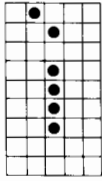

90 (218)

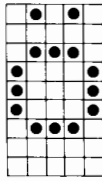

92 (219)

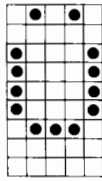

93 (220)

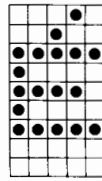

91 (221)

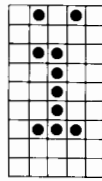

94 (222)

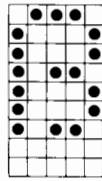

95 (223)



\*The HP 82905B Printer supports the 8-bit mode of invoking the characters of the alternate character set. The number in parentheses is the decimal equivalent with the eighth bit of a character byte set to "1".

**Notes**



## Using the Printer With the Optional HP-IL Interface

The HP 82905B Printer (options 148, 248, 348, and 448) is used in the Hewlett-Packard Interface Loop (HP-IL). To connect the printer to a loop, use the compatible cables that are shipped with your printer and other HP-IL devices. These cables connect to cause the loop to be formed or maintained. You should not need to force the connectors when the loop is properly configured. Simply connect the cables to the proper connectors to form the interface loop. Each device, including the interface, should have two cables connected to it. All devices in the loop must be on for the loop to operate properly.

The connectors indicate the direction of information transfer (and the numbering of devices during operation) as shown below:

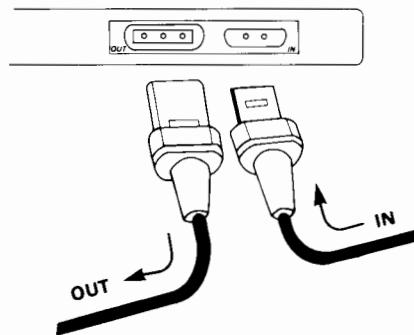

The illustration below shows a typical HP-IL loop.

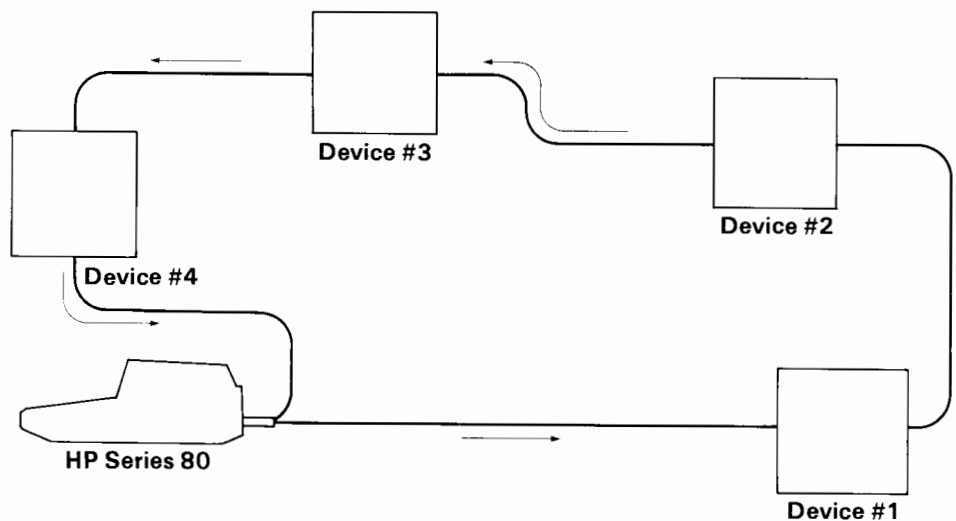

## Printing From a Computer

If you are using an HP Series 80 Personal Computer to control the loop, you will need the HP 82938A HP-IL Interface. Install it in the computer according to the instructions in the owner's manual. Be sure that the system controller switch is *enabled* and that you know the select code setting of the interface.

**Note:** The HP-83/85 requires either the Plotter/Printer ROM or the I/O ROM to print using the HP 82938A HP-IL Interface.

To designate your printer as the system printer, use:

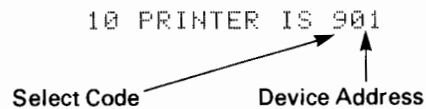

The device address is determined by the number of devices in the loop and the relative position of the printer in the loop. If the printer and the computer (with HP-IL interface) are the only two devices in the loop, then the device address for the printer is 01. For more information, refer to section 3 of your HP-IL interface owner's manual.

## Printing From a Calculator

The HP-41C/CV Calculators can use the HP-IL Module to form a loop with the HP 82905B Printer. With the printer switch on the module *enabled* and the printer ON LINE, print commands such as **(PRX)** (print contents of X-register) and **(PRP)** (print program) will generate output on the printer.

**Example:** The following HP-41C/CV program will produce the various types of print shown under Output.

```

01LBL "PRINT"
02 XEQ "PRSEL"
03 "0"
04 XEQ "MODSEL"
05 "NORMAL PRINT"
06 PRA
07 "1"
08 XEQ "MODSEL"
09 "DOUBLE WIDE "
10 "+ PRINT. US"
11 ACA
12 "EFUL FOR TITLES"
13 PRA
14 "9"
15 XEQ "MODSEL"
16 "HP82905B "
17 "+ EMPHASIZED"
18 PRA
19 "UNDERLINE VIA "
20 "+ SOFTWARE"
21 ACA
22 13
23 ACCOL
24 95
25 9

```

Carriage Return  
 ACCOL allows CR to be sent independently of LF.

```

26 XEQ "RCHR"
27 PRBUF
28 "2"
29 XEQ "MODSEL"
30 "+COMPRESSED AND"
31 ACA
32 "3"
33 XEQ "MODSEL"
34 "EXPANDED"
35 "+COMPRESSED"
36 PRA
37 12                               Send form feed to clear paper.
38 ACCHR
39 STOP

40LBL "PRSEL"
41 "HP82905B"
42 FINDID
43 SELECT
44 RTN                               } Subroutine to find HP 82905B Printer anywhere on the HP-IL loop
                                     and make it the printer.

45LBL "MODSEL"
46 27
47 ACCHR
48 38
49 ACCHR
50 107
51 ACCHR
52 "+S"
53 ACA
54 RTN                               } Subroutine to send escape sequences that selects print mode.

55LBL "RCHR"
56 STO 11
57 RDN

58LBL 01
59 ACCHR
60 DSE 11
61 GTO 01
62 RTN
63 END                               } Subroutine to send repeated characters.
                                     y: Code for ACCHR
                                     x: Number of times to send character.

```

To run the example program, first key in the program and then key in the following:

<code>XEQ ALPHA PRSEL ALPHA</code>	Select HP 82905B.
<code>ALPHA 9 ALPHA</code>	
<code>XEQ ALPHA MODSEL ALPHA</code>	Select emphasized print.
<code>SF 16</code>	Select normal output listing mode.
<code>XEQ ALPHA PRP ALPHA ALPHA PRINT ALPHA</code>	
<code>XEQ ALPHA PRINT ALPHA</code>	

**Output:**

XEQ "PRINT"  
 NORMAL PRINT  
 DOUBLE WIDE PRINT. USEFUL FOR TITLES  
 HP82905B EMPHASIZED  
UNDERLINE VIA SOFTWARE  
 COMPRESSED AND EXPANDED COMPRESSED

**HP 82905B Printer Response to HP-41C/CV Functions**

Function	Printer Response
SKPCHR	Accumulates one skipped character.
FMT	Accumulates one space.
ACCOL	Accumulates one space plus a character specified by the code in X-register ( $0 \leq X \leq 127$ ).
SKPCOL	Accumulates one or more spaces.
ACSPEC	Accumulates one space plus seven ASCII characters specified by the column print numbers used in BLDSPEC.
PRPLOT	Not compatible with the HP 82905B.

See the *HP 82160A HP-IL Module Owner's Manual* for a complete listing of printer functions.



## HP-IL Capability

### HP 82905B HP-IL Capability Subsets

Function	Description
R	Receiver. Complete capability.
AH	Acceptor handshake. Complete capability.
SH1	Source handshake. Complete capability.
D	Driver. Complete capability.
L1, 3	Listener. Basic listener, unaddress if MTA.
LE 1, 3	Extended listener. Basic listener, unaddress if MTA.
T 2, 3, 4, 6	Talker. Send status, send device id, send accessory id, unaddress if MLA.
TE 2, 3, 4, 6	Extended talker. Send status, send device id, send accessory id, unaddress if MLA.
CO	Controller. No capability.
DC2	Device clear. Universal and addressed device clear commands made available to the user.
DT0	Device trigger. No capability.
PP1	Parallel poll. Complete capability.
SR1	Service request. Basic capability.
AA1	Auto address. Complete capability.
AE1	Auto extended address. Complete capability.
AMO	Auto multiple address. No capability.
RLO	Remote local. No capability.
PDO	Power down. Basic capability.
DDO	Device dependent commands. No capability.

## HP-IL ID and Status Information

Accessory ID: 33 decimal equivalent.

Device ID: ASCII string: HP 82905B CR/LF.

Status: First byte: decimal equivalent.

128—All OK, buffer not empty.

161—Ready to receive data, 40 byte buffer empty.

194—Requires manual intervention. OFF-LINE or NO PAPER.

Second byte:

O	O	PE	OL	BF	BE	BS	O
---	---	----	----	----	----	----	---

where PE = 1 when out of paper.

OL = 1 when printer is off-line.

BF = 1 when the 40 character buffer is full.

BE = 1 when the 40 character buffer is empty.

BS = 1 when the printer is busy printing.





## Using the Printer With the Optional Serial Interface

The HP 82905B Printer (options 240, 340, and 440) is compatible with computing and data communications devices equipped with an RS-232C (serial) interface port and hardware handshake capability. Such devices include:

- Certain HP 2620-series data terminals.
- Certain HP 2640-series data terminals.
- The HP 125 computer.
- HP Series 80 Personal Computers.

The printer accepts data according to the following parameters:

Baud	4800 bits/sec
Start bits	1 bit
Data bits	8 bits
Stop bits	1 bit
Parity check	none
Buffer size	2,048 characters

Contact your nearest HP sales and service facility for additional information regarding compatibility of the HP 82905B Printer with Hewlett-Packard terminals.

### Connecting the Printer to a Computer

#### Connecting the Printer to the HP 125 Computer

An HP-13242G RS 232 Cable is required to connect the printer to an HP 125 computer. Use the printer *Configuration Menu* to establish the following configuration:

```
BaudRate 4800   Parity NONE(0)   Straps xz   Hndsk eTx
PtrNulls   4     SRRXmit OFF       SRRInvert OFF  Xon/Xoff(X) Recv
```

### Using the Printer With an HP Series 80 Personal Computer

#### Connecting the Printer

There are two ways to connect the printer to an HP Series 80 Personal computer using a serial interface:

- An HP 82939A Serial Interface can be used in combination with an HP 02631-60065 interconnecting cable. The interconnecting cable is required for physical compatibility of connectors.

- The HP 82939A (option 001) Serial Interface eliminates the need for the interconnecting cable. However, the interface must be modified to configure it properly for communication with the printer. The procedure for modifying the interface, which involves swapping the wires at pins 8 and 25 and at pins 11 and 24 of interface connector J1, is explained in the *HP 82939A Serial Interface Owner's Manual*. The final configuration must be:

J1 Pin Number	Wire Color	Function
8	red	Transmitted Data
25	orange	Received Data
11	green	Clear to Send (not used)
24	black	Data Terminal Ready

### Establishing the Interface Configuration

The interface requires further reconfiguration in order to communicate with the printer. This is accomplished either by altering settings on switches S1 and S2 of the interface assembly or by changing the contents of interface Control Registers 3, 4, and 5.

The following switch settings properly configure the interface. Refer to the *HP 82939A Serial Interface Owner's Manual* for instructions on accessing and setting the switches.

#### Switch S1

Segment	Setting	Action
1	1	Enable auto handshake
2	1	} Select code = 10
3	1	
4	1	

#### Switch S2

Segment	Setting	Action
1	0	} No parity
2	0	
3	0	
4	0	One stop bit
5	1	} Word length = 8
6	1	
7	1	} Baud = 4800
8	1	
9	0	
10	1	

The following statements configure the interface by writing to the appropriate interface control registers. It is *not* necessary to execute these statements if the switches have been set according to the previous tables.

- For the HP-85 equipped with an I/O ROM, execute:

```
CONTROL 10,3;13      Sets baud to 4800.
CONTROL 10,4;3       Sets no parity and 8 data bits.
CONTROL 10,5;48      Enables auto handshake.
```

- For the HP-86, HP-87, and the HP-85 equipped with a Plotter/Printer ROM, execute:

```
SET I/O 10,3,13     Sets baud to 4800.
SET I/O 10,4,3      Sets no parity and 8 data bits.
SET I/O 10,5,48     Enables auto handshake.
```

### Addressing the Printer

To address the printer, execute the appropriate `PRINTER IS` statement for your system.

- For the HP-85 equipped with an I/O ROM, execute:

```
PRINTER IS select code
```

#### Example:

```
PRINTER IS 10
```

- For the HP-86, HP-87, and the HP-85 equipped with a Plotter/Printer ROM, execute:

```
PRINTER IS select code [, line length]
```

#### Example:

```
PRINTER IS 10,80
```

## Connecting the Printer to Data Terminal Equipment

In addition to the parameters listed on page 49, the following terminal features are necessary for printer/terminal compatibility:

Handshake	via printer pin #20 (Data Terminal Ready)
Null Padding	4 or more characters (for the HP 2623 and HP 2640-series terminals)

The printer does not support XON/XOFF or ENQ/ACK handshake protocols.

Null character padding of four or more characters prevents possible terminal timeouts generated by multiple form feeds sent to the printer. The timeouts would otherwise occur when the buffer is full due to the time required to perform a form feed operation (approximately 0.2 seconds per line).

The following accessories are required to connect the printer to Hewlett-Packard terminals:

- HP 2620-series terminals—an HP 13242G RS 232 Cable.
- HP 2640-series terminals—an HP 13232G RS 232 Cable and an HP 13250 Serial Printer Interface.

## Serial Receptacle Pin Assignments

The following table describes the pin assignments of the printer's serial interface receptacle. Signal direction follows the conventions:

“Out”—Signal is transmitted from the printer to the computer or terminal.

“In”—Signal is transmitted from the computer or terminal to the printer.

Pin Number	Signal	Direction	Description
1	Protective Ground	—	
2	Transmitted Data	Out	Data transmitted by printer.
3	Received Data	In	Data received by printer.
4	Request to Send	Out	Not used by printer.
5	Clear to Send	In	Not used by printer.
6	Data Set Ready	In	Not used by printer.
7	Signal Ground	—	
8	Received Line Signal Detect	In	Not used by printer.
20	Data Terminal Ready	Out	Handshake line.

## The Printer/Terminal Handshake

The printer Data Terminal Ready (DTR) line (pin #20) provides the hardware handshake between the printer and the terminal by monitoring the contents of the 2048-character printer buffer. The DTR line becomes HIGH (logic level 1,  $-3V$  to  $-27V$ ) when the printer buffer contains 2,032 or more characters. The line becomes LOW (logic level 0,  $+3V$  to  $+27V$ ) when the buffer contains 2,031 or fewer characters.

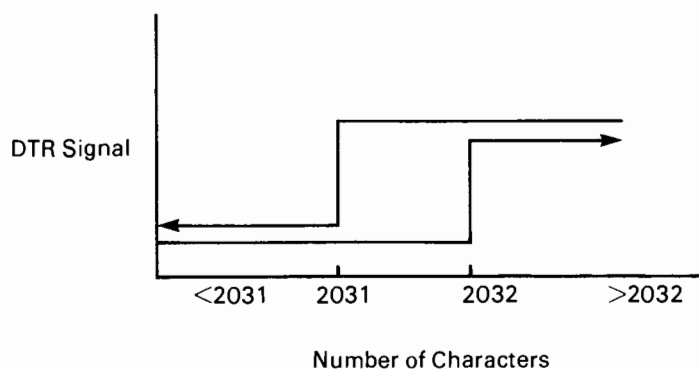

Null character padding of four or more characters ensures that any form feed processed by the printer will empty the buffer to 2,031 characters or less. This sets the DTR line low and prevents a terminal timeout.

## Terminal/Host Handshake Timeouts

Timeouts by terminal/host software handshakes, shown below, may be generated by multiple form feeds sent to the printer.

Handshake	HP 1000	HP 3000
ENQ/ACK	3.8 seconds	15 seconds
XON/XOFF	Handshake not available	No timeout

### Preventing HP 1000 Timeouts

HP 1000 software revision 2140 (HP part number 92001-16035 %DVA05 REV 2140 provides for extending the timeout period to over 327 seconds. To change the timeout with software revision 2140, respond to the file manager prompt (: with:

```
: CN,<LU>,34B,<time>
```

where <LU> is the session logical unit number for the terminal and <time> is the time in hundredths of seconds.

This is the only means of preventing form feed timeouts on the HP 1000.

### Preventing HP 3000 Timeouts

The action taken depends on the terminal in use:

HP 2620-series terminals—Configure the terminal for XON/XOFF handshaking.

HP 2642A and HP 2647F terminals—Configure the terminal for XON/XOFF handshaking.

HP 2640-series terminals other than the HP 2642A and HP 2647F—Two or more consecutive form feeds may cause a timeout unless one of the following preventative actions is taken:

- Log on using TERM TYPE 16; this disables the timeout. However, the backspace function is changed to backspace/line feed. Keep in mind that certain HP 3000 software automatically sets TERM TYPE 10.
- Use HP 2640-series terminals with a factory-installed D99 option. This option adds a ROM to the system that provides XON/XOFF handshaking.
- HP 2640-series terminals without a factory-installed D99 option can be adapted to support XON/XOFF handshaking by purchasing a DC1/DC3 Kit (HP part number 93983J), available with the following options:

Option 1—for the HP 2645A Terminal.

Option 2—for the HP 2648A Terminal.

Option 3—for the HP 2647A Terminal.





## Using the Printer With the Optional Parallel Interface

The HP 82905B Printer (options 242, 342, 442) is compatible with computing devices equipped with a standard parallel, or “Centronics”-type, interface. This includes:

- The HP-86. The PRINTER receptacle of the HP-86 printer/disc interface is designed for connecting a printer equipped with a parallel interface.
- All HP Series 80 Personal Computers with an installed HP 82949A Printer Interface.

The printer is connected to the interface cable by inserting the cable connector into the printer interface receptacle. Then, press the bail clips located on both sides of the receptacle in towards the cable housing until the clips snap into place.

### Printer Receptacle Pin Assignments

The printer interface receptacle is compatible with a standard Amphenol-type, 36-pin connector. Both the HP 82957A Printer Cable used with the HP-86 and the HP 82949A Printer Interface are equipped with this connector.

The direction conventions used in the table of pin assignments are:

“In”—The signal is received by the printer from the computer.

“Out”—The signal is transmitted by the printer to the computer.

Signal Pin No.	Signal	Direction	Description
1	Strobe	In	A LOW pulse of width greater than 0.5 $\mu$ s reads one byte of data.
2	DATA 1	In	Data bits 0 through 7 receive a byte of data.
3	DATA 2	In	
4	DATA 3	In	
5	DATA 4	In	
6	DATA 5	In	
7	DATA 6	In	
8	DATA 7	In	
9	DATA 8	In	
10	Acknlg	Out	The printer sends a low-going pulse to indicate that it has accepted a byte of data and is ready for more data.
11	Busy	Out	A HIGH logic level indicates the printer cannot receive data due to data entry, a printing operation, off-line status, or error status.
12	O-O-P	Out	A HIGH logic level indicates the printer is out of paper.

13	Selected	Out	A HIGH logic level indicates that the printer is selected.
14, 15			Not used.
16	Logic Gnd		
17	Chassis Gnd		
18			Not used.
19 to 30	Logic Gnd		Ground returns.
31	$\overline{\text{Input Prime}}$	Out	A LOW pulse of width greater than 50 us resets the printer and clears the print buffer.
32	$\overline{\text{Error}}$	In	A LOW level indicates the printer has reached a paper end or off-line state, or has developed an error condition.
33	Logic Gnd		Ground return.
34			Pulled to 5V through a 3.3 k $\mu$ resistor.
35			Not used.
36	Logic Gnd		

### Printer Timing Diagram

The timing diagram illustrates the DATA and handshake lines during transfer of one data byte to the printer. DATA lines 1 through 8 and the Strobe line are driven by the interface, whereas the Acknlg line is driven by the printer.

Minimum and typical timing intervals are:

Interval	Description	Minimum Value	Typical Value
$t_D$	Delay from DATA written to data $\overline{\text{Strobe}}$ .	0.5 $\mu\text{s}$	
$t_{SB}$	Data $\overline{\text{Strobe}}$ width.	0.5 $\mu\text{s}$	
$t_{ACK}$	$\overline{\text{Acknlg}}$ pulse width.		5 $\mu\text{s}$
$t_H$	Duration of valid data after $\overline{\text{Strobe}}$ .	0.5 $\mu\text{s}$	

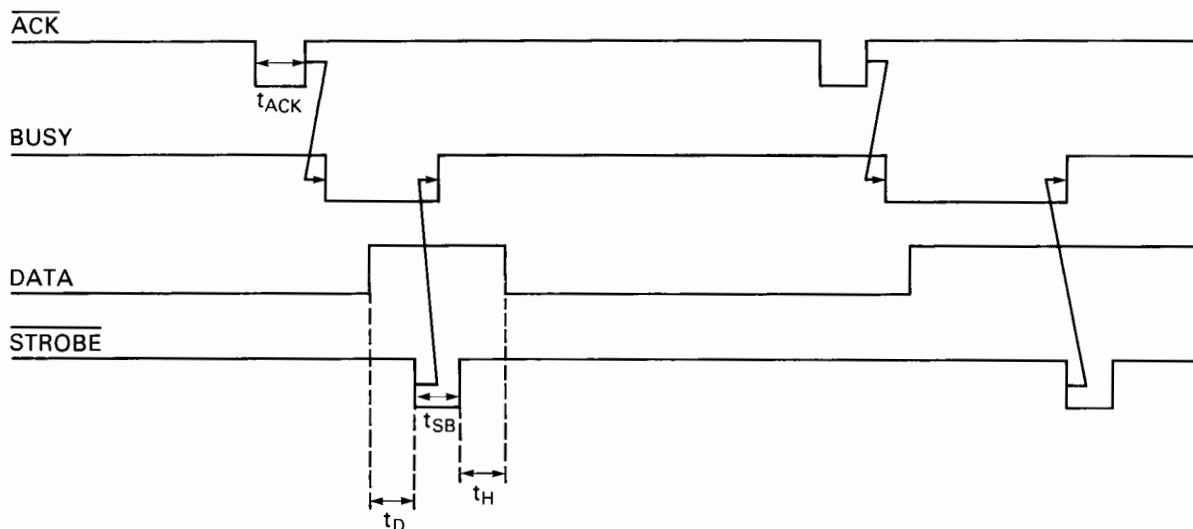



**HEWLETT  
PACKARD**

**Personal Computer Division  
1010 N.E. Circle Blvd., Corvallis, OR 97330, U.S.A.**

Reorder Number  
82905-90014

Printed in U.S.A. 6/82

82905-90057