

HEWLETT-PACKARD

HP 82161A

Digital Cassette Drive

OWNER'S MANUAL

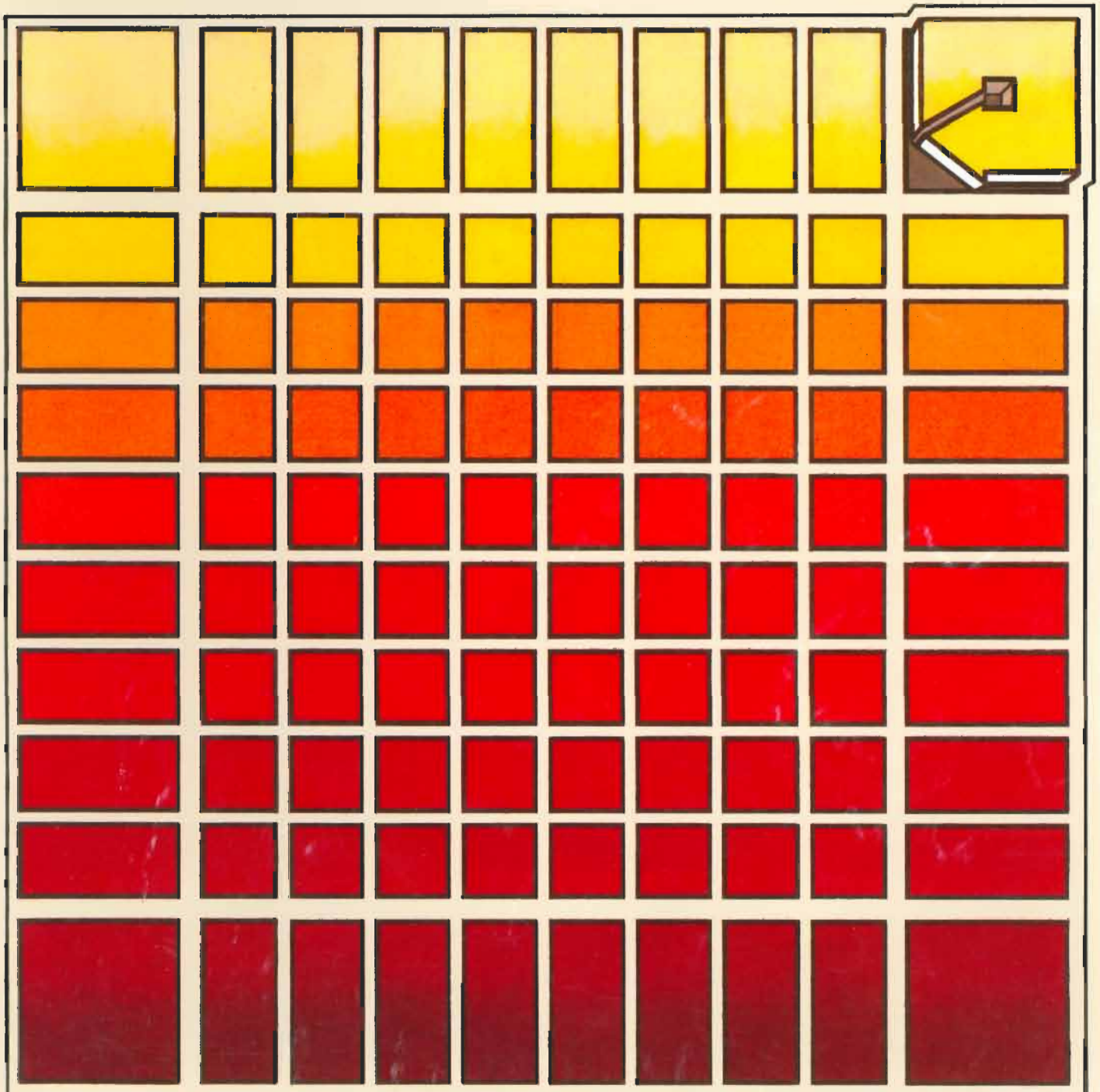



HP 82161A Digital Cassette Drive

Owner's Manual

February 1981

82161-90002

HP Computer Museum
www.hpmuseum.net

For research and education purposes only.

Contents

Introduction	5
Installation	5
Power	5
Interface Connections	6
Loading a Cassette	6
Operation	7
Technical Description	8
Internal Design	8
Controlling the Drive	9
Startup Conditions	9
HP-IL Messages	9
Device Dependent Commands	11
Appendix A: Care, Warranty, and Service Information	15
Care of the Drive and Cassettes	15
Verifying Proper Operation	16
Limited One-Year Warranty	16
What We Will Do	16
What Is Not Covered	16
Warranty for Consumer Transactions in the United Kingdom	17
Obligation to Make Changes	17
Warranty Information	17
Service	18
Obtaining Repair Service in the United States	18
Obtaining Repair Service in Europe	18
International Service Information	19
Service Repair Charge	19
Service Warranty	19
Shipping Instructions	19
Further Information	19
Potential for Radio/Television Interference	20
Applications Information	20
Dealer and Product Information	20
Appendix B: Accessories and Specifications	21
Accessories	21
Specifications	21

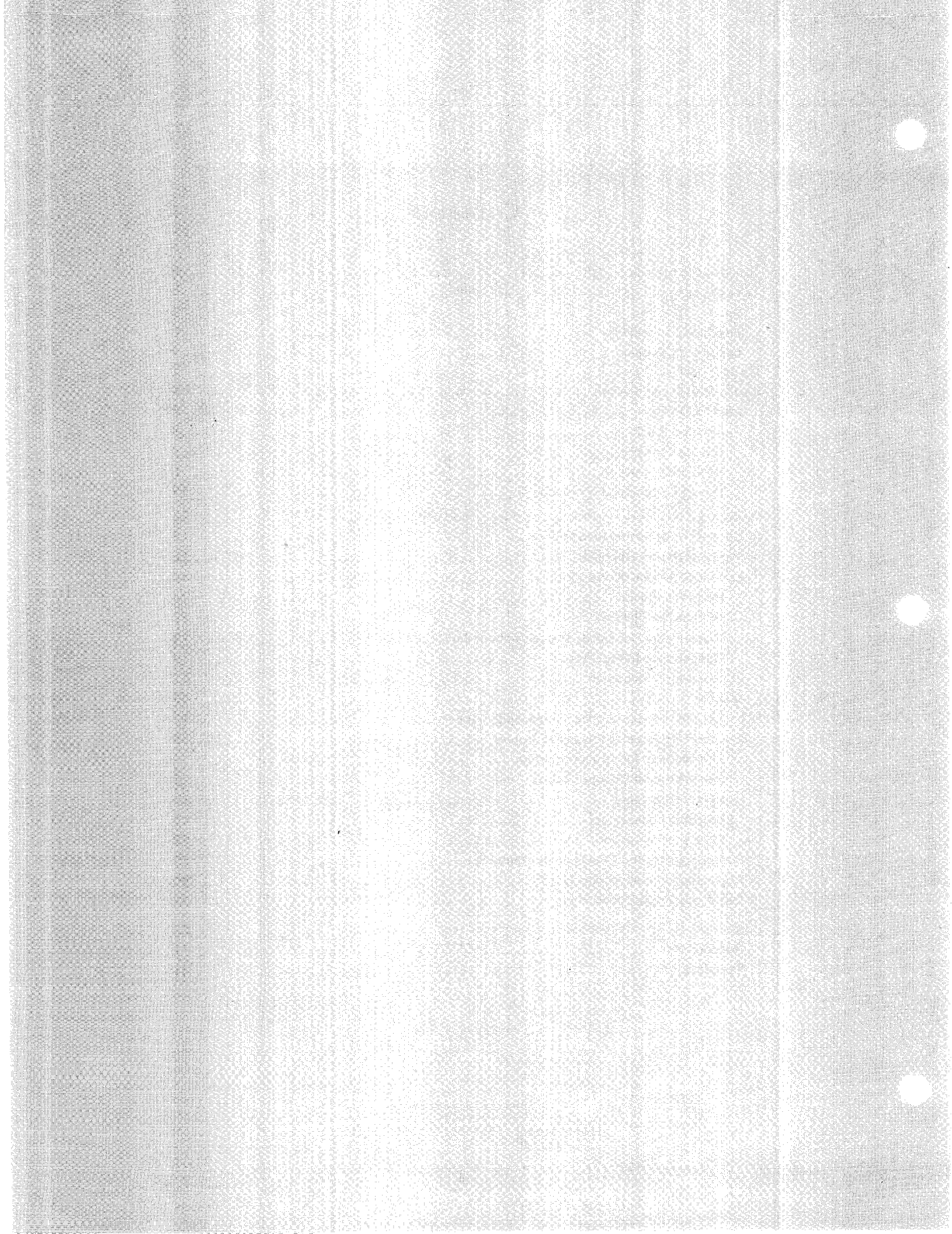

Introduction

The HP 82161A Digital Cassette Drive provides mass storage capabilities for your calculator or computer system. The cassette drive is a mass storage peripheral device that stores up to 512 records (131,072 bytes) of information on a removable Mini Data Cassette. You connect the cassette drive to your system using the Hewlett-Packard Interface Loop (HP-IL).

Typically, you control the cassette drive by using your calculator or computer and its HP-IL capabilities or HP-IL extensions. For this reason, the owner's manual for your calculator, computer, or HP-IL extension should be your primary reference for operating peripherals such as the cassette drive.

This manual gives information about connecting the cassette drive and describes its capabilities.

Your HP 82161A Digital Cassette Drive is packaged with the following accessories:

- One HP-IL cable.
- One Hewlett-Packard Mini Data Cassette.
- A rechargeable battery pack (installed in the cassette drive).
- A recharger.



Optional accessories and specifications for the HP 82161A Digital Cassette Drive are listed in appendix B.

Installation

The following paragraphs describe how to set up the HP 82161A Digital Cassette Drive so that you can begin using it with your system.

Power

Power for the HP 82161A Digital Cassette Drive is provided by a rechargeable battery pack. The battery pack is located in the compartment in the bottom of the drive.

CAUTIONS

Be sure the cassette drive is turned off before removing the battery pack.

Be sure the cassette drive is turned off before connecting or disconnecting the recharger.

Be sure the battery pack is installed whenever the recharger is connected.

If these cautions are not followed, the cassette drive's circuitry could be damaged.

To recharge the battery pack using ac power, first switch the cassette drive to OFF. Then insert the ac plug of the recharger into the proper power source. Connect the recharger connector into the POWER receptacle at the rear of the cassette drive. The drive can be operated normally while the battery pack recharges.

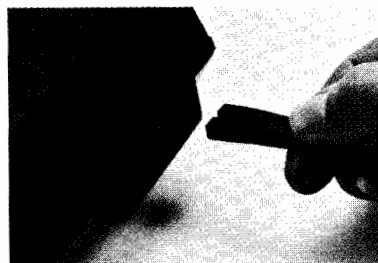

To remove or replace the battery pack, first switch the cassette drive to OFF and disconnect it from the interface loop. Then release the battery door by sliding its two latches inward and drop the door and pack into your hand. Install the battery pack by aligning its contacts with the two spring connectors, then replace the door and secure its two latches.

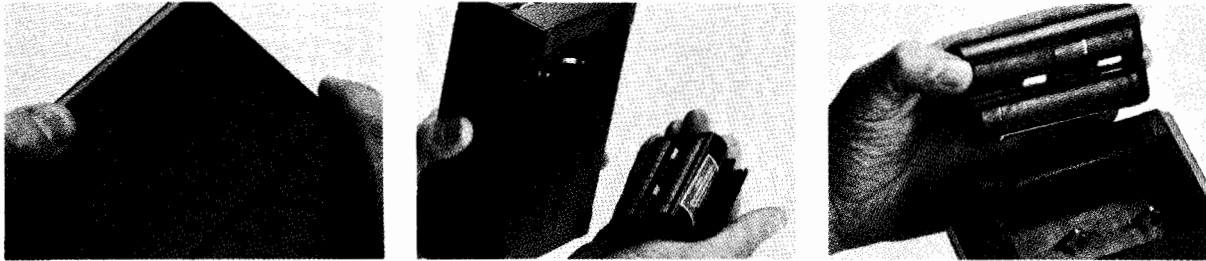

Interface Connections

The Hewlett-Packard Interface Loop can consist of several peripheral devices and a controller (calculator or computer). The devices may be connected in any order—but all of the interface cables must form a continuous loop. All connections are designed to ensure proper orientation.

To connect the HP 82161A Digital Cassette Drive to the loop, first turn off the controller. Then merely disconnect the loop in one place and connect the cassette drive into the loop at that place. (In some situations, the cassette drive might be the only peripheral in the loop.)

Note: Be sure the controller is turned off before connecting interface cables. If this is not done, the system's operation may be disrupted.

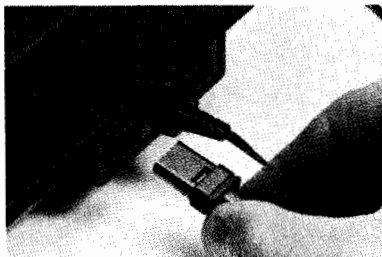

All devices must be turned on for the interface to operate properly.

Loading a Cassette

To load a Mini Data Cassette into the HP 82161A Digital Cassette Drive, open the cassette door by pressing the OPEN button on the front panel. The cassette can be loaded in only one orientation. Keep the white label facing up and the exposed tape facing into the drive. Slide the cassette into the receptacle in the door and close the door. If the tape is positioned improperly, the door will not close completely. *Do not force the door.*

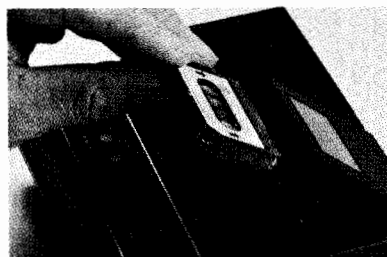

When removing a cassette from the drive, it is good practice first to rewind the tape by pressing the REWIND button on the front panel. To remove the cassette, press the OPEN button and slide out the cassette. Store the cassette in its protective holder or in the storage compartment in the top of the case.

Note: Do not open the cassette door while the drive is operating or the BUSY light is on. The cassette will not be damaged, but some information may be lost.

Operation

As soon as the HP 82161A Digital Cassette Drive has power, is connected to a controller via the interface loop, is switched ON, and has a cassette installed, you can begin using its mass storage capabilities. (If the POWER light doesn't turn on or the BAT light does turn on, recharge the battery pack as described above.) You should refer to the owner's manual for your calculator, computer, or HP-IL extension to find the primary information about controlling the cassette drive.

Refer to appendix A for additional information about using Mini Data Cassettes and about verifying proper operation of the drive.

The front panel on the cassette drive contains several controls that allow you to set and monitor the drive's operation.

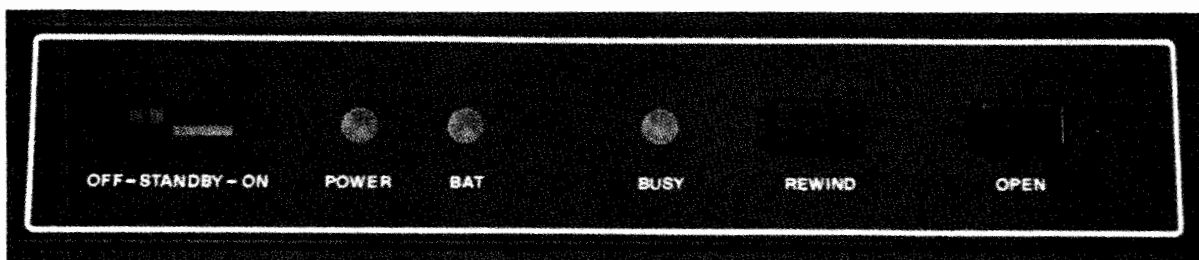

OFF-STANDBY-ON Switch. This switch sets the power mode of the drive. When set to the OFF position, the drive is turned off and cannot be turned on except by manually changing this switch. When set to the ON position, the drive is turned on and cannot be turned off except by manually changing this switch. When set to the STANDBY position, the drive can be turned on and off by the controller using its HP-IL capabilities. When it is on, the cassette drive uses somewhat more power in the STANDBY position than in the ON position. Use the STANDBY position only when you intend to have the controller set the power state.

POWER Light. This light is on whenever the drive is in its operating power state. The light goes off if the battery power is not sufficient to run the drive.

BAT Light. This light indicates the condition of the rechargeable battery pack. If the light is off, battery power is adequate. If the light is on, battery power is low—only about 10 to 15 minutes of operating power remain. If the power is low and you wish to continue using the drive, turn off the drive and either replace the battery pack or connect the recharger.

CAUTION

Continued operation with the BAT light on may damage the rechargeable battery pack or destroy information on the cassette.

BUSY Light. This light is on whenever the drive is performing or set to perform an operation. Specifically, the light is on if the drive is actually executing an operation or is set as a talker or a listener.

REWIND Button. Pressing this button causes the cassette to be rewound to the clear leader at the start of the tape. In this condition, the tape is less likely to be damaged when not installed in the drive. This button does not operate when the BUSY light is on.

OPEN Button. Pressing this button causes the cassette door to open, allowing you to insert or remove a cassette. The drive sets its status to indicate that a new tape has been inserted.

Technical Description

The preceding pages have covered the basic information about using the HP 82161A Digital Cassette Drive. The next two sections discuss some of the more technical aspects of the cassette drive. For most applications you will not need to use the following information. However, it is included here for those situations that require such detail.

Internal Design

The HP 82161A Digital Cassette Drive has three internal features that are important for understanding the drive's operation: buffer 0, buffer 1, and the byte pointer.

Buffer 0. This buffer consists of 256 cells, with each cell capable of holding one byte (eight bits). Buffer 0 is used for holding information that is being transferred between the tape and the interface loop.

Buffer 1. This buffer also consists of 256 cells, with each cell capable of holding one byte. Buffer 1 is used for holding information being sent to or received from the interface loop.

Byte Pointer. The byte pointer is essentially an indicator that directs the transfer of information into and out of buffers 0 and 1. It specifies a certain cell (or byte) in the buffer—from 0 to 255. The transfer normally follows the pointer, which advances from one cell to the next. This one pointer applies to both buffers.

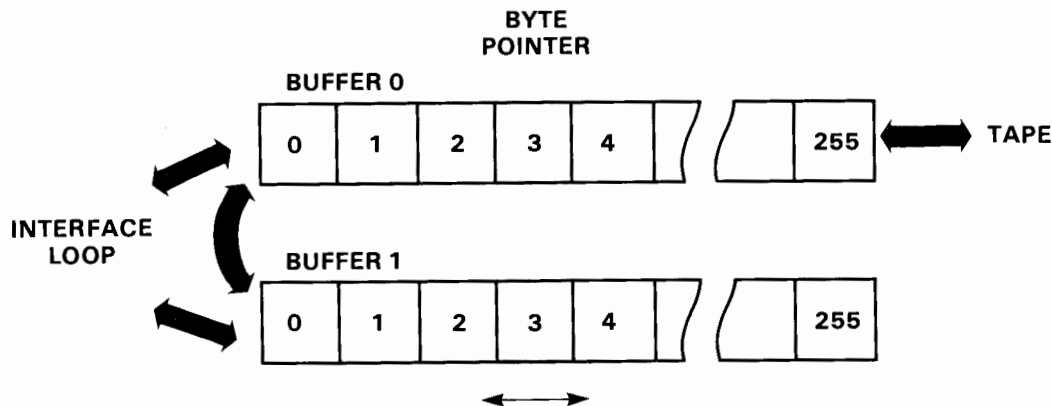

The cassette drive has two primary modes for recording information on the tape: continuous recording and partial recording. Continuous recording is selected by the Write (Device Dependent Listener 2) command. Partial recording is selected by the Partial Write (Device Dependent Listener 6) command. (HP-IL commands are discussed below.)

For continuous recording, the contents of buffer 0 are defined by data received on the interface loop. Each time buffer 0 is filled, its contents replace one record on the tape. This recording mode is useful for storing entire records.

For partial recording, the current record on the tape is first copied into buffer 0, then part (or all) of this copy is replaced by data from the interface loop. Whenever the buffer is filled, the revised contents replace the original record on the tape and the next record is copied into buffer 0. This recording mode is useful for changing *part* of a record without affecting the rest of the record.

Two tracks of information are available on the cassette, with each track consisting of 256 records. (Each record contains 256 bytes.) Both tracks are accessible without turning the cassette over. It is possible for one file to span from the end of the first track to the beginning of the second track. To reduce access time and tape wear caused by running the tape back and forth, rename such a file to a name you won't use and then store the information again in a new file.

Controlling the Drive

Most controllers perform a specified operation by automatically sending a preprogrammed sequence of HP-IL messages around the interface loop. You would not be using the actual HP-IL messages in this case, but rather you would be using the HP-IL capabilities built into your calculator, computer, or HP-IL extension. However, this section describes how the HP 82161A Digital Cassette Drive responds to the *individual* HP-IL messages.

The cassette drive operates according to information it receives on the interface loop. Specifically, the drive responds to the standard HP-IL messages (listed below), including device-dependent commands (listed separately).

Startup Conditions. Whenever the cassette drive turns on—including recovery from a low-power condition—it winds the tape to the start of the first record, clears the recording mode, and sets its HP-IL address to an undefined state. An undefined address prevents the drive from performing any operation until it is assigned a valid address.

HP-IL Messages. When the drive receives an HP-IL message on the interface loop, the drive responds according to the following list. Except where noted, the drive automatically sends each HP-IL message to the next device in the loop.

HP-IL MESSAGE	CASSETTE DRIVE RESPONSE
COMMAND GROUP	
Interface Clear	Talker or listener status removed and pending command cleared (unless Device Clear command).
Device Clear	Tape wound to start of first record, recording mode cleared, and sending of data terminated.
Selected Device Clear	If listener, device cleared as with Device Clear command.
Go To Local	No response.
Local Lockout	No response.
Remote Enable	No response.
Not Remote Enable	No response.
Parallel Poll Enable 0-15	No response.
Parallel Poll Disable	No response.
Parallel Poll Unconfigure	No response.
Group Execute Trigger	No response.

HP-IL MESSAGE	CASSETTE DRIVE RESPONSE
Loop Power Down	If ON, device not accessible for 0.7 second, address becomes undefined, device set as with Device Clear and Interface Clear, and power remains on. If STANDBY, device goes to low-power state and sets itself to become active if it receives any signal. When activated, address becomes undefined and device set as with Device Clear and Interface Clear.
Enable Asynchronous Requests	No response.
Auto Address Unconfigure	Address set to 2.
Listen Address 0-31	If address matches, device removed from talker status and becomes a listener. If address is 31, device removed from listener status.
Unlisten	Device removed from listener status.
Device Dependent Listener 0-31	If listener, responds as described under Device Dependent Commands (page 11).
Talk Address 0-31	If address matches, device removed from listener status and becomes a talker. If address doesn't match, device removed from talker status.
Untalk	Device removed from talker status.
Device Dependent Talker 0-31	If talker, responds as described under Device Dependent Commands (page 11).
Secondary Address 0-30	No response.
Null	No response.
READY GROUP	
Take Control	No response.
Ready For Command	Executes previous command.
Send Data	If talker, begins sending data as previously selected.*
Send Status	If talker, sends one byte of status (refer to the table following this list).*
Send Device ID	No response.
Send Accessory ID	If talker, sends one byte with the value 16.*
Not Ready For Data	If talker, makes previous data byte the last byte sent.
End Of Transmission—OK	If talker, sent at end of data or for read error.
End Of Transmission—Error	If talker, sent immediately for bad HP-IL error check.
Auto Address 0-31	If device has earlier auto address, no response. If address is 31, no response. If message address less than 31 and device doesn't have earlier auto address, sets device address to message address, increments message address by one, and passes revised message.
Auto Extended Primary 0-31	No response.
Auto Extended Secondary 0-31	No response.
Auto Multiple Primary 0-31	No response.
IDENTIFY GROUP	
Identify (no service request)	No response.
Identify (service request)	No response.
DATA GROUP	
Data Byte (no service request) } Data Byte (service request) }	If talker, performs HP-IL error check and sends next data byte.* If listener, accepts data byte and passes to next device.
End Byte (no service request) } End Byte (service request) }	If listener, accepts data byte, records contents of buffer 0 onto tape, and passes the byte to next device.

* Indicates that the received message is not passed to the next device in the loop.

Status Byte Definition

STATUS BYTE		CONDITION	DEFINITION
DECIMAL	BINARY*		
0-15	0000 - - - -	Idle Condition	No error and not executing a previous command.
16	00010000		Not used.
17	00010001	End Of Tape Error	Unexpectedly reached end of tape.
18	00010010	Stall Error	Tape has stalled.
19	00010011	End/Stall Error	End Of Tape and Stall conditions.
20	00010100	No Tape Error	No tape is installed in drive.
21	00010101	Device Error	Device possibly requires service.
22	00010110	Device Error	Device possibly requires service.
23	00010111	New Tape Error	A new tape has been inserted but not positioned.
24	00011000	Time Out Error	No data detected on tape.
25	00011001	Record Number Error	Retrieved record number not as expected.
26	00011010	Checksum Error	Computed checksum differs from expected.
27	00011011		Not used.
28	00011100	Size Error	Specified track number greater than 1.
29	00011101		Not used.
30	00011110		Not used.
31	00011111		Not used.
32-63	001 - - - - -	Busy Condition	Device is executing a previous command. (This is not an error.)

*The eight bits are shown in order—bit 7 (most-significant) through bit 0 (least-significant). The - symbol indicates either a "0" or a "1".

Device Dependent Commands. Device Dependent Listener commands and Device Dependent Talker commands are special HP-IL messages whose meanings depend upon the device receiving them—the listener or the talker. When these commands are sent to the cassette drive, they are referred to by names that correspond to the specific actions they cause. Device-dependent command numbers, names, and responses are listed below. The Device Dependent Listener commands are listed first; the Device Dependent Talker commands are listed after.

Device Dependent Listener Commands

NUMBER	NAME	DESCRIPTION
0	Write Buffer 0	Subsequent Data Bytes are treated as data. That is, they are stored in buffer 0 starting at the byte pointer location and, when the buffer fills, are recorded onto the tape according to the current recording mode. Additional data bytes fill the buffer starting at its first cell and are recorded onto the tape. A subsequent End Byte is stored as a data byte.
1	Write Buffer 1	Subsequent Data Bytes are stored in buffer 1 starting at the byte pointer location. When the buffer fills, additional data bytes replace those already in the buffer, starting at the first cell. A subsequent End Byte is stored the same way. (This command also clears the partial recording mode set up by the Partial Write command—Device Dependent Listener 6 command.)
2	Write	The device is set for continuous recording of information onto the tape. The byte pointer is set to the first cell in buffer 0. As subsequent Data Bytes fill buffer 0, its contents will be recorded into sequential records on the tape (leaving the tape positioned at the next record). The contents of buffer 0 will be recorded onto the tape when a Close Record (Device Dependent Listener 8) command or End Byte is received.
3	Set Byte Pointer	Subsequent Data Bytes redefine the byte pointer—from 0 to 255. Only the last byte received is used.

Device Dependent Listener Commands (Continued)

NUMBER	NAME	DESCRIPTION
4	Seek	The next two Data Bytes are interpreted as a track number (0 or 1) and a record number (0 thru 255), and the tape is positioned to that track and record. If the track number is greater than 1, the tape is not moved and a Size Error is generated (refer to the Status Byte Definition table above). (This command also clears the partial recording mode set up by the Partial Write command—Device Dependent Listener 6 command.)
5	Format	The value 255 is recorded in each byte in all records on the tape. This sets up on the tape the physical positions of the records. When finished, the tape is positioned to the first cell of record 0, track 1. (This command also clears the partial recording mode set up by the Partial Write command—Device Dependent Listener 6 command.)
6	Partial Write	The device is set for partial recording of information onto the tape. That is, the current record is read from the tape into buffer 0 and the tape is positioned back to the start of the same record. Subsequent Data Bytes will replace the contents of buffer 0 starting at the byte pointer location. When the buffer is filled, its contents will be recorded in the current record on the tape, the next record will be read into buffer 0, and the tape will be positioned back to the start of the record just read. The byte pointer is not changed when the buffer is recorded. This continues until a Close Record (Device Dependent Listener 8) command or End Byte is received. A Close Record command will cause the contents of buffer 0 to be recorded and the tape to be positioned back to the start of the same record. An End Byte will be stored in buffer 0 and will cause the contents to be recorded and the tape to be positioned back to the start of the same record—unless the End Byte fills the buffer, for which the buffer contents will be recorded, the next record will be read into the buffer, and the tape positioned back to the start of the record just read.
7	Rewind	The tape is rewound to the leader at the very beginning and is generally used when the tape is going to be removed. The tape can't be used until after the tape door is opened and closed, a Device Clear command is received, or a Seek (Device Dependent Listener 4) command repositions the tape.
8	Close Record	The contents of buffer 0 are recorded in the current record on the tape. Following a Write (Device Dependent Listener 2) command, a Close Record command leaves the tape positioned at the next record. Following a Partial Write (Device Dependent 6) command, a Close Record command leaves the tape positioned at the start of the record just recorded.
9	Transfer Buffer	The contents of buffer 0 are copied into buffer 1. The byte pointer is reset to 0.
10	Exchange Buffers	The contents of buffer 0 and buffer 1 are exchanged. The byte pointer is reset to 0.
11-31		The device is set to ignore Data Bytes and End Bytes until directed by subsequent Device Dependent Listener commands. This prevents improper use. (These commands also clear the partial recording mode set up by the Partial Write command—Device Dependent Listener 6 command.)

Device Dependent Talker Commands

NUMBER	NAME	DESCRIPTION
0	Send Buffer 0	A subsequent Send Data message causes the contents of buffer 0 to be sent on the interface loop. Data starts with the byte indicated by the byte pointer. When the end of the buffer is reached, the next record is read from the tape into the buffer and sent on the interface loop. This continues until the end of tape is reached, a Not Ready For Data message is received, or any error condition occurs. (This command also clears the partial recording mode set up by the Partial Write command—Device Dependent Listener 6 command.)
1	Send Buffer 1	A subsequent Send Data message causes the contents of buffer 1 to be sent on the interface loop. Data starts with the byte indicated by the byte pointer. It continues until the end of the buffer is reached or a Not Ready For Data message is received.
2	Read	The next record is read from the tape into buffer 0. A subsequent Send Data message causes the contents of buffer 0 to be sent on the interface loop starting with the first byte in the buffer. When the end of the buffer is reached, the next record is read into the buffer and sent. This continues until the end of tape is reached, a Not Ready For Data message is received, or any error condition occurs. (This command also clears the partial recording mode set up by the Partial Write command—Device Dependent Listener 6 command.)
3	Send Position	Three bytes indicating the current tape position are sent on the interface loop. The first byte represents the track number, 0 or 1. The second number represents the record number, 0 through 255. The third number represents the byte number, 0 through 255.
4	Exchange Buffers	The contents of buffer 0 and buffer 1 are exchanged. The byte pointer is reset to 0.
5-31		The device is set to not send data unless directed by subsequent Device Dependent Talker commands. This prevents improper use.

Care, Warranty, and Service Information

Care of the Drive and Cassettes

The HP 82161A Digital Cassette Drive requires little maintenance. Just follow these guidelines:

- Avoid letting dust and other foreign material accumulate in the cassette compartment. Keep the cassette door closed except when loading cassettes.
- After every 10 to 15 hours of cumulative tape use, clean the recording head and end-of-tape sensor as follows:
 1. Open the cassette door. Remove the cassette if one is present.
 2. Use a clean cotton swab to gently clean the end-of-tape sensor. One part is located to the right of the recording head; the other part is recessed in the bottom of the cassette compartment.
 3. Use a cotton swab moistened with isopropyl alcohol to gently rub the recording head with a side-to-side motion. Dry the head with a dry swab using a similar motion. Be careful not to leave any lint in the compartment.

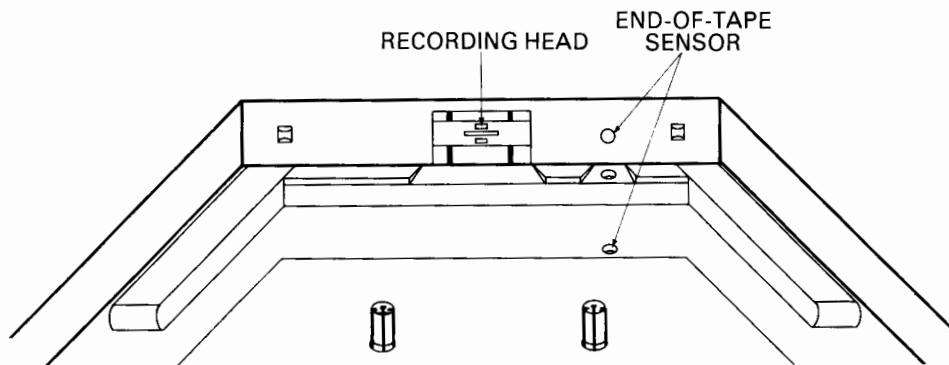

HP Mini Data Cassettes are special, high-quality digital cassettes. Other cassettes may not provide adequate reliability for storing and retrieving information. Mini Data Cassettes require no maintenance. But the performance of the cassettes depend on the care you give them. Observe the following guidelines:

- Always rewind the tape before removing the cassette from the drive. This protects the recording surface from physical damage.
- Always store the cassette in its protective holder or in the storage compartment in the drive.
- Always keep the cassettes within the temperature range of 10° to 45° C (50° to 113° F).
- Avoid extreme temperature variations, especially over a short time period. If possible, wind the tape from one end to the other and back during or after a large temperature change.
- Avoid extremely humid or dry conditions (above 80 percent or below 20 percent relative humidity).
- Avoid strong magnetic fields such as near transformers or magnets. Strong fields may cause information to be lost. (Metal detectors used in airport terminals will not affect stored information.)
- Never pull the tape out of the cassette. Keep the tape fully wound.
- Never attempt to clean the tape.

Verifying Proper Operation

If at any time you suspect that your cassette drive or interface loop is not operating properly, you can verify its operation by doing the following:

1. Check that all peripheral devices are turned on.
2. Check that the POWER light is on and the BAT light is off. If the rechargeable battery pack has inadequate power, the drive will not operate.
3. Clean the recording head and end-of-tape sensor as described above.
4. Check that the calculator or computer and its interface are working properly. Refer to the owner's manuals for those devices.
5. Turn off the calculator or computer and the cassette drive. Then disconnect the drive from the interface loop.
6. Turn on the cassette drive while it is disconnected from the interface loop. Select a good cassette that is rewound to the clear leader at the beginning of the tape. Insert the cassette into the drive and allow the drive to reposition the tape. Then remove the cassette without rewinding it.
 - If the tape is near the beginning (most of the tape is on the right side as viewed from the front of the drive) and a small index hole in the tape is positioned along the exposed area on the side of the cassette, the drive is operating properly. (You may need to wind the tape slightly to see the hole.)
 - If the tape is not positioned as described above, repeat this step with another cassette. If cassettes are not positioned as described, the drive requires service.

If this procedure indicates proper operation, but you still experience difficulty, try to verify that the cassette is not bad. Do this by performing the troublesome operation using different files on the tape or using a different tape. If you cannot determine the cause of the difficulty, write or telephone Hewlett-Packard at an address or phone number listed below under Service.

Limited One-Year Warranty

What We Will Do

The HP 82161A Digital Cassette Drive is warranted by Hewlett-Packard against defects in materials and workmanship for one year from the date of original purchase. If you sell your unit or give it as a gift, the warranty is automatically transferred to the new owner and remains in effect for the original one-year period. During the warranty period, we will repair or, at our option, replace at no charge a product that proves to be defective, provided you return the product, shipping prepaid, to a Hewlett-Packard service center.

What Is Not Covered

This warranty does not apply if the product has been damaged by accident or misuse or as the result of service or modification by other than an authorized Hewlett-Packard service center.

No other express warranty is given. The repair or replacement of a product is your exclusive remedy. **ANY OTHER IMPLIED WARRANTY OF MERCHANTABILITY OR FITNESS IS LIMITED TO THE ONE-YEAR DURATION OF THIS WRITTEN WARRANTY.** Some states, provinces, or countries do not allow limitations on how long an implied warranty lasts, so the above limitation may not apply to you. **IN NO EVENT SHALL HEWLETT-PACKARD COMPANY BE LIABLE FOR CONSEQUENTIAL DAMAGES.** Some states, provinces, or countries do not allow the exclusion or limitation of incidental or consequential damages, so the above limitation or exclusion may not apply to you.

This warranty gives you specific legal rights, and you may also have other rights which vary from state to state, province to province, or country to country.

Warranty for Consumer Transactions in the United Kingdom

This warranty shall not apply to consumer transactions and shall not affect the statutory rights of a consumer. In relation to such transactions, the rights and obligations of Seller and Buyer shall be determined by statute.

Obligation to Make Changes

Products are sold on the basis of specifications applicable at the time of manufacture. Hewlett-Packard shall have no obligation to modify or update products once sold.

Warranty Information

If you have any questions concerning this warranty, please contact an authorized Hewlett-Packard dealer or a Hewlett-Packard sales and service office. Should you be unable to contact them, please contact:

- In the United States:

Hewlett-Packard
1000 N.E. Circle Blvd.
Corvallis, OR 97330
Telephone: (503) 758-1010
Toll-Free Number: (800) 547-3400 (except in
Oregon, Hawaii, and Alaska)

- In Europe:

Hewlett-Packard S.A.
7, rue du Bois-du-lan
P.O. Box
CH-1217 Meyrin 2
Geneva
Switzerland
Telephone: (022) 83 81 11

Note: Do *not* send units to this address for repair.

- In other countries:

Hewlett-Packard Intercontinental
3495 Deer Creek Rd.
Palo Alto, California 94304
U.S.A.
Telephone: (415) 857-1501

Note: Do *not* send units to this address for repair.

Service

Hewlett-Packard maintains service centers in most major countries throughout the world. You may have your unit repaired at a Hewlett-Packard service center any time it needs service, whether the unit is under warranty or not. There is a charge for repairs after the one-year warranty period.

Hewlett-Packard products are normally repaired and reshipped within five (5) working days of receipt at any service center. This is an average time and could possibly vary depending upon the time of year and work load at the service center. The total time you are without your unit will depend largely on the shipping time.

Obtaining Repair Service in the United States

The Hewlett-Packard United States Service Center for battery-powered computational products is located in Corvallis, Oregon:

Hewlett-Packard Company
Corvallis Division Service Department
P.O. Box 999/1000 N.E. Circle Blvd.
Corvallis, Oregon 97330, U.S.A.
Telephone: (503) 757-2000

Obtaining Repair Service in Europe

Service centers are maintained at the following locations. For countries not listed, contact the dealer where you purchased your unit.

AUSTRIA

HEWLETT-PACKARD GmbH
Kleinrechner-Service
Wagramerstr.-Liebiggasse
A-1220 VIENNA
Telephone: (222) 35.16.20

BELGIUM

HEWLETT-PACKARD BELGIUM SA/NV
Boulevard de la Woluwe 100
Woluwelaan
B-1200 BRUSSELS
Telephone: (2) 762 32 00

DENMARK

HEWLETT-PACKARD A/S
Datavej 52
DK-34-60 BIRKEROD (Copenhagen)
Telephone: (02) 81 66 40

EASTERN EUROPE

Refer to the address listed under Austria

FINLAND

HEWLETT-PACKARD OY
Revontulentie 7
02100 ESPOO 10 (Helsinki)
Telephone: (90) 455 02 11

FRANCE

HEWLETT-PACKARD FRANCE
Division Informatique Personnelle
S.A.V. Calculateurs de Poche
F-91947 Les Ulis Cedex
Telephone: (6) 907 78 25

GERMANY

HEWLETT-PACKARD GmbH
Kleinrechner-Service
Vertriebszentrale
Berners Strasse 117
Postfach 560 140
D-6000 FRANKFURT 56
Telephone: (611) 50041

ITALY

HEWLETT-PACKARD ITALIANA S.P.A.
Casella postale 3645 (Milano)
Via G. Di Vittorio, 9
I-20063 CERNUSCO SUL NAVIGLIO (Milan)
Telephone: (2) 90 36 91

NETHERLANDS

HEWLETT-PACKARD NEDERLAND B.V.
Van Heuven Goedhartlaan 121
N-1181 KK AMSTELVEEN (Amsterdam)
P.O. Box 667
Telephone: (020) 472021

NORWAY

HEWLETT-PACKARD NORGE A/S
P.O. Box 34
Oesterndalen 18
N-1345 OESTERAAS (Oslo)
Telephone: (2) 17 11 80

SPAIN

HEWLETT-PACKARD ESPANOLA S.A.
Calle Jerez 3
E-MADRID 16
Telephone: (1) 458 2600

SWEDEN

HEWLETT-PACKARD SVERIGE AB
Enighetsvagen 3
Box 205 02
S 161 BROMMA 20 (Stockholm)
Telephone: (8) 730 05 50

SWITZERLAND

HEWLETT-PACKARD (SCHWEIZ) AG
Kleinrechner-Service
Allmend 2
CH-8967 WIDEN
Telephone: (057) 50111

UNITED KINGDOM

HEWLETT-PACKARD Ltd
King Street Lane
GB-WINNERSH, WOKINGHAM
BERKSHIRE RG11 5AR
Telephone: (734) 784774

International Service Information

Not all Hewlett-Packard service centers offer service for all models of HP products. However, if you bought your product from an authorized Hewlett-Packard dealer, you can be sure that service is available in the country where you bought it.

If you happen to be outside of the country where you bought your unit, you can contact the local Hewlett-Packard service center to see if service is available for it. If service is unavailable, please ship the unit to the address listed above under Obtaining Repair Service in the United States. A list of service centers for other countries can be obtained by writing to that address.

All shipping, reimportation arrangements, and customs costs are your responsibility.

Service Repair Charge

There is a standard repair charge for out-of-warranty repairs. The repair charges include all labor and materials. In the United States, the full charge is subject to the customer's local sales tax. In European countries, the full charge is subject to Value Added Tax (VAT) and similar taxes wherever applicable. All such taxes will appear as separate items on invoiced amounts.

Products damaged by accident or misuse are not covered by the fixed repair charges. In these situations, repair charges will be individually determined based on time and material.

Service Warranty

Any out-of-warranty repairs are warranted against defects in materials and workmanship for a period of 90 days from date of service.

Shipping Instructions



Should your unit require service, return it with the following items:

- A completed Service Card, including a description of the problem and system setup when the problem occurred.
- A sales receipt or other documentary proof of purchase date if the one-year warranty has not expired.

The product, the Service Card, a brief description of the problem and system configuration, and (if required) the proof of purchase date should be packaged in the original shipping case or other adequate protective packaging to prevent in-transit damage. Such damage is not covered by the one-year limited warranty; Hewlett-Packard suggests that you insure the shipment to the service center. The packaged unit should be shipped to the nearest Hewlett-Packard designated collection point or service center. Contact your dealer directly for assistance. (If you are not in the country where you originally purchased the unit, refer to International Service Information above.)

Whether the unit is under warranty or not, it is your responsibility to pay shipping charges for delivery to the Hewlett-Packard service center.

After warranty repairs are completed, the service center returns the unit with postage prepaid. On out-of-warranty repairs in the United States and some other countries, the unit is returned C.O.D. (covering shipping costs and the service charge).

Further Information

Service contracts are not available. Circuitry and designs are proprietary to Hewlett-Packard, and service manuals are not available to customers.

Should other problems or questions arise regarding repairs, please call your nearest Hewlett-Packard service center.

Potential for Radio/Television Interference

The HP 82161A Digital Cassette Drive generates and uses radio frequency energy and, if not installed and used properly (that is, in strict accordance with the instructions in this manual), may cause interference to radio and television reception. It has been type tested and found to comply with the limits for a Class B computing device in accordance with the specifications in Subpart J of Part 15 of FCC rules, which are designed to provide reasonable protection against such interference in a residential installation. However, there is no guarantee that interference will not occur in a particular installation. If the cassette drive does cause interference to radio or television reception, which can be determined by turning the cassette drive off and on, you are encouraged to try to correct the interference by one or more of the following measures:

- Reorient the receiving antenna.
- Relocate the cassette drive with respect to the receiver.
- Move the cassette drive away from the receiver.
- Plug the cassette drive's recharger into a different outlet so that the cassette drive and the receiver are on different branch circuits.

If necessary, you should consult your dealer or an experienced radio/television technician for additional suggestions. You may find the following booklet, prepared by the Federal Communications Commission, helpful: *How to Identify and Resolve Radio—TV Interference Problems*. This booklet is available from the U.S. Government Printing Office, Washington, D.C. 20402, Stock Number 004-000-00345-4.

Applications Information

A number of our users submit program applications or unique programs to Hewlett-Packard. However, we can consider using only ideas given freely to us. Since it is the policy of Hewlett-Packard not to accept suggestions given in confidence, the following statement must be included with your submittal:

"I am voluntarily submitting this information to Hewlett-Packard Company. The information is not confidential and Hewlett-Packard may do whatever it wishes with the information without obligation to me or anyone else."

Dealer and Product Information

For dealer locations, product information, and prices, please call (800) 547-3400. In Oregon, Alaska, and Hawaii, call (503) 758-1010.

Accessories and Specifications

Accessories

Optional accessories are available for the HP 82161A Digital Cassette Drive:

Hewlett-Packard Mini Data Cassettes, available in packages of 10 (model number HP 82176A) or individually (from dealers).

HP-IL Cables, available (in packages of two) in the following lengths:

½ meter (1½ feet)	HP 82167A
1 meter (3 feet)	HP 82167A Option 001
2 meters (6 feet)	HP 82167A Option 002
3 meters (10 feet)	HP 82167A Option 003
5 meters (16 feet)	HP 82167A Option 005

Reserve Power Pack (model number HP 82037A).

Security Cable (model number HP 82044A).

Specifications

The following specifications apply to the HP 82161A Digital Cassette Drive.

Data Format

- Number of tracks: 2.
- Density: 335 bits per centimeter (850 bits per inch).
- Format: 256 bytes per record (8 bits per byte).
- Formatted capacity: 512 records (131,072 bytes).
- Encoding method: bi-phase-level phase encoding.

Drive Mechanism

- Type: two-motor, hub drive.
- Read/write speed: 23 centimeters (9 inches) per second.
- Search/rewind speed: 76 centimeters (30 inches) per second.

Interface

- Type: HP-IL (Hewlett-Packard Interface Loop).
- Default address: undefined.

Power Requirements

- Primary source: HP 82033A Battery Pack.
- Recharging time for pack: 14 to 16 hours (drive turned on or off).
- Usage: ON 1.5 watts maximum (motor off).
STANDBY (on) 1.7 watts maximum (motor off).
STANDBY (off) 0 watts.

Temperature Limits

- Operating: 10° to 40° C (50° to 104° F).
- Charging: 15° to 40° C (59° to 104° F).
- Storage: -40° to 75° C (-40° to 167° F).

Digital Cassette

- Type: Hewlett-Packard Mini Data Cassette.
- Tape length: 24 meters (80 feet).
- Temperature limits: 10° to 45° C (50° to 113° F).
- Humidity limits: 20 to 80 percent relative humidity.



1000 N.E. Circle Blvd., Corvallis, OR 97330, U.S.A.