

HP50960

* This machine uses HP9817 Box, PSU, Backplane (Diagrams Included), but no speaker fitted (JB on Backplane is not used)

* standard configuration includes:
HP98204A Video (Text board only)
09920-66537 HP-MIL/HPIB
HP50962 SRM
See DIO schematics

* Boot sequence is similar to HP9000/200
BOOTROM4.0

HP50960

MCG8440 Dual-Channel DMA Controller

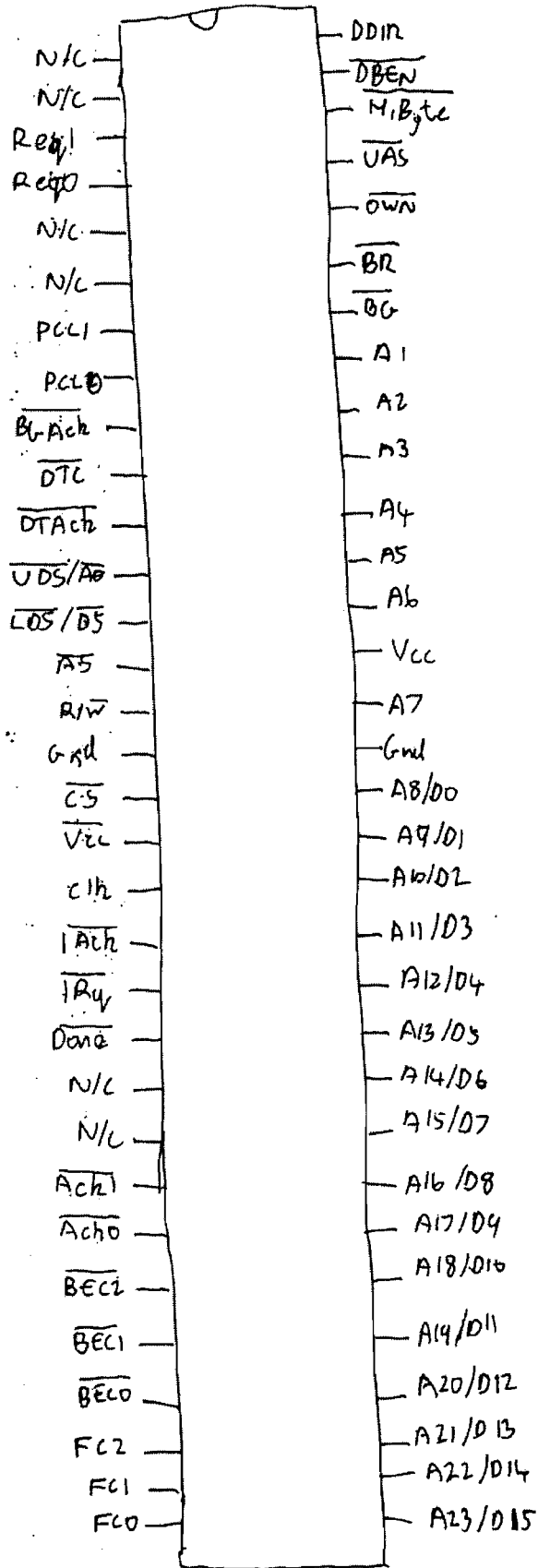

HP50960

ITL1-0004 Medusa HP1B Interface

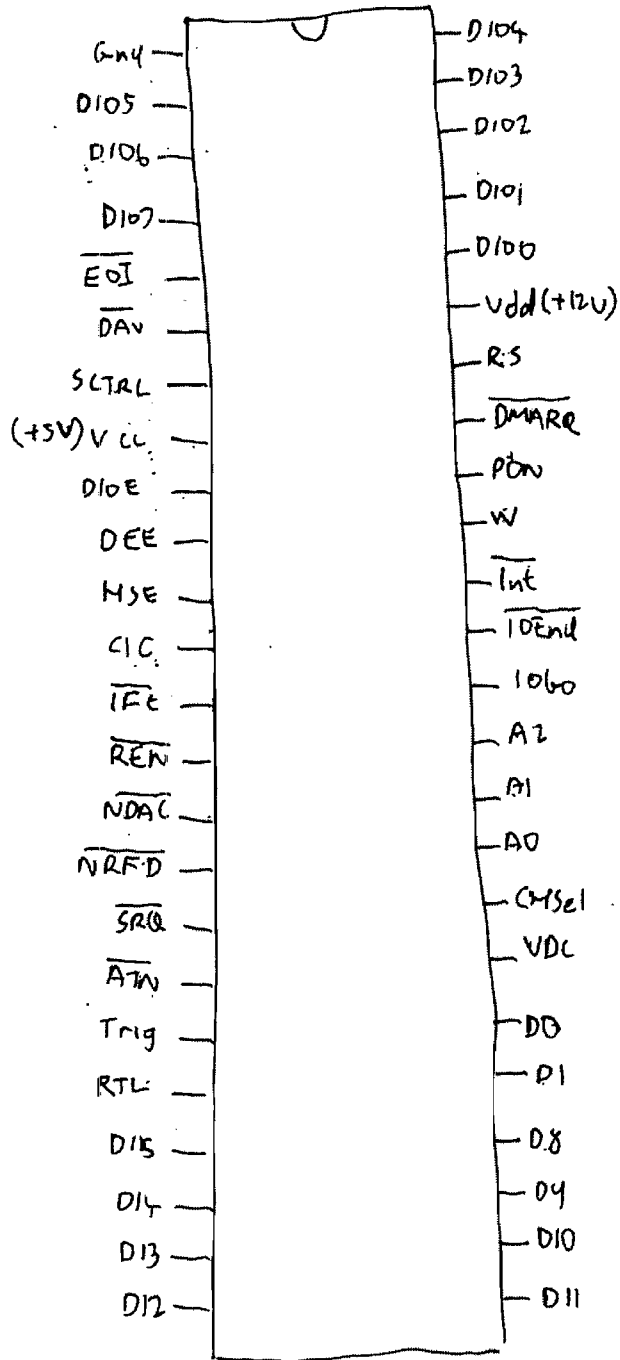

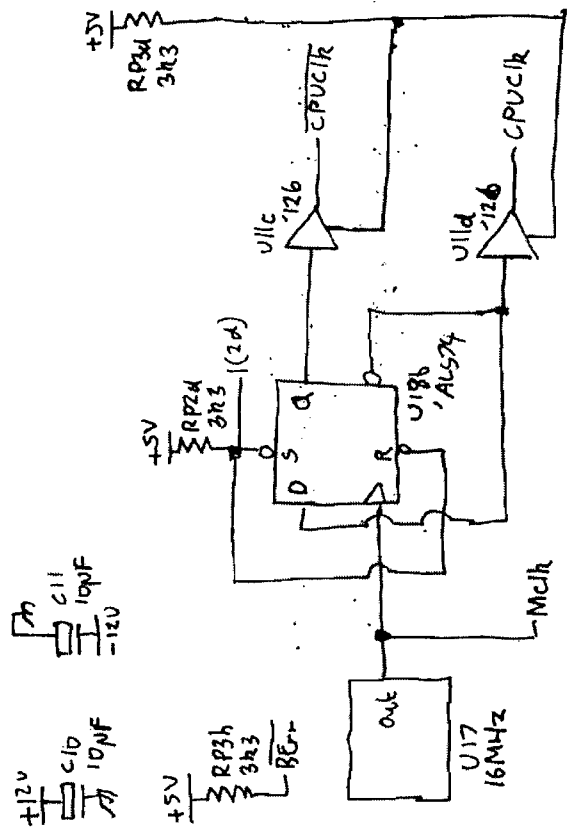
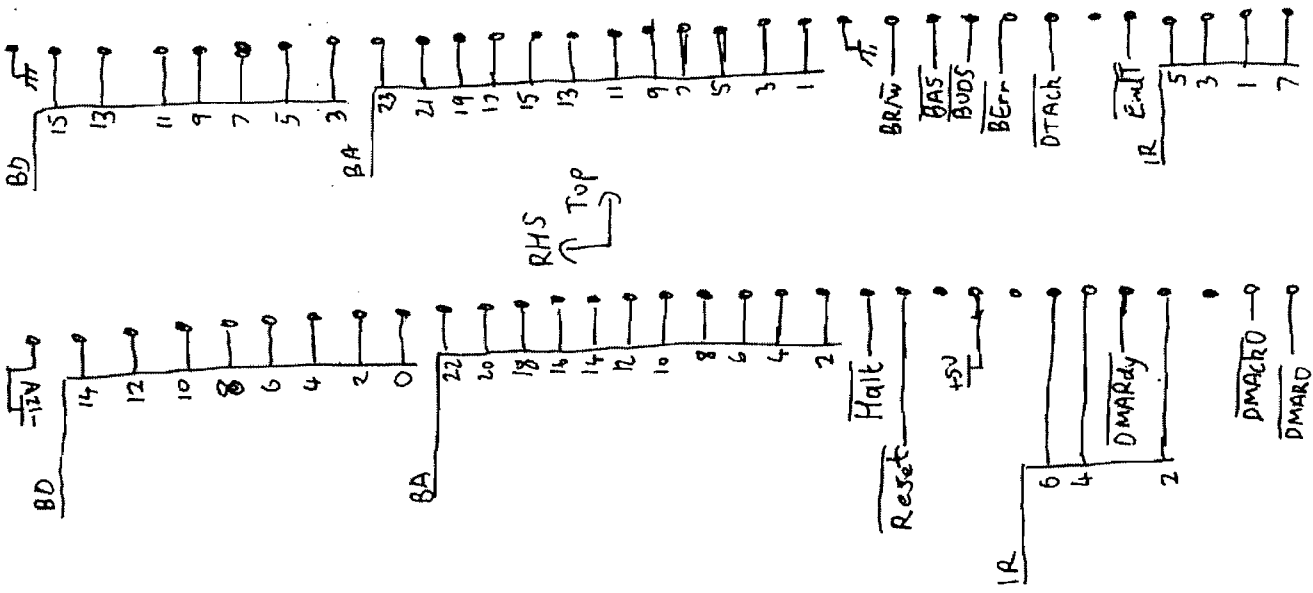
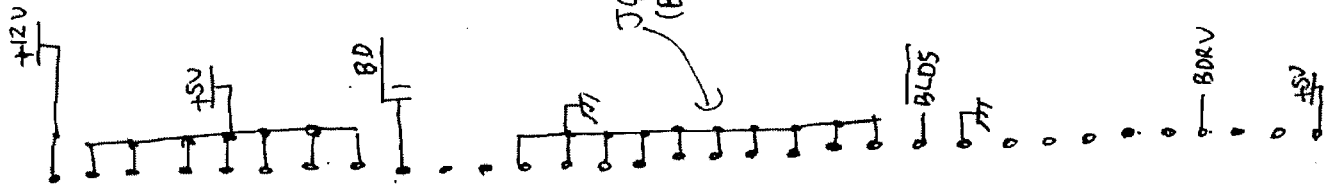

Master Clock

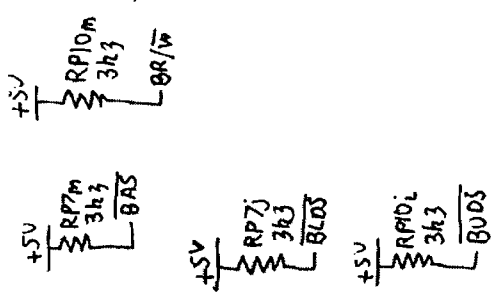
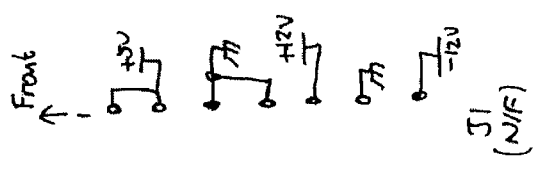

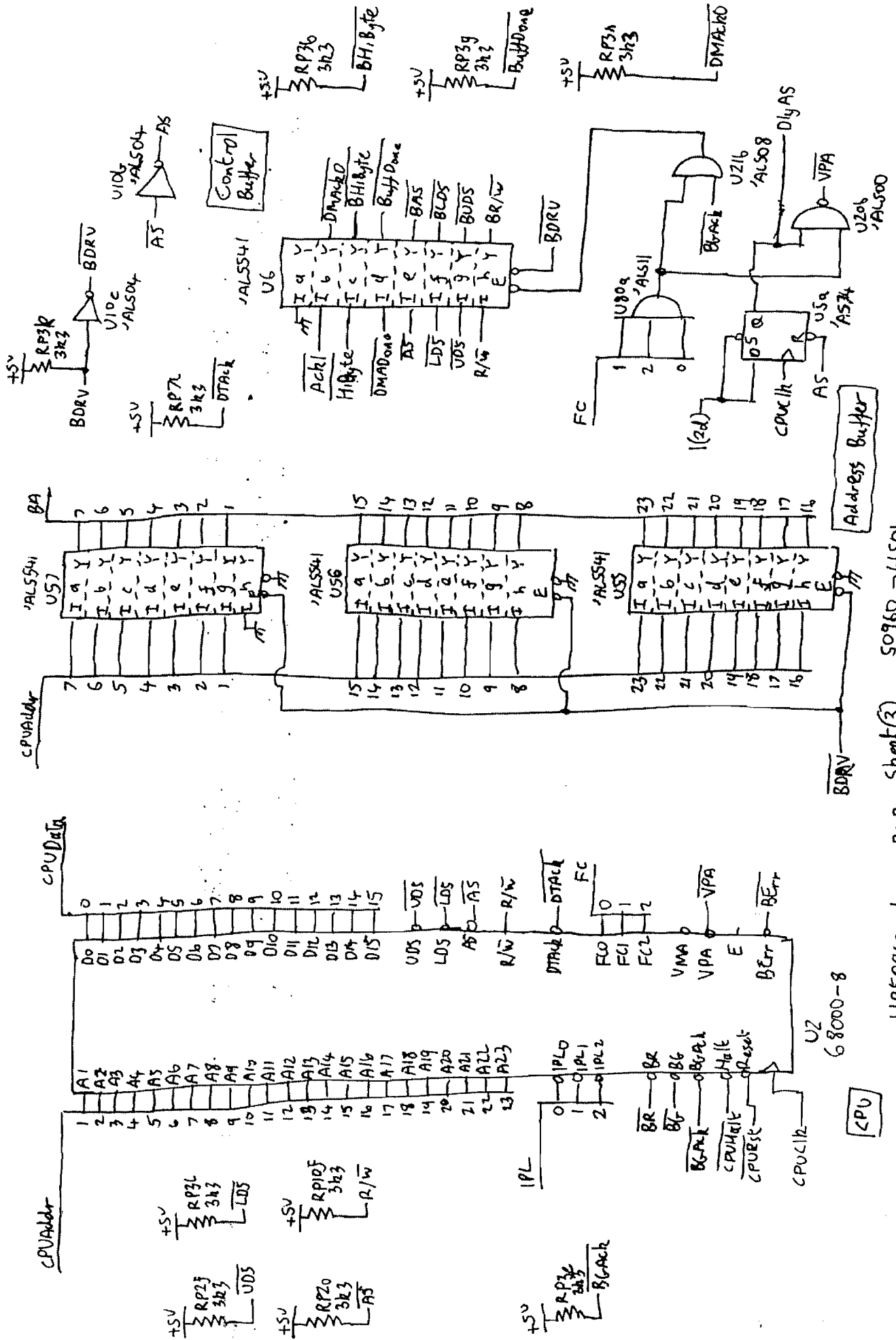

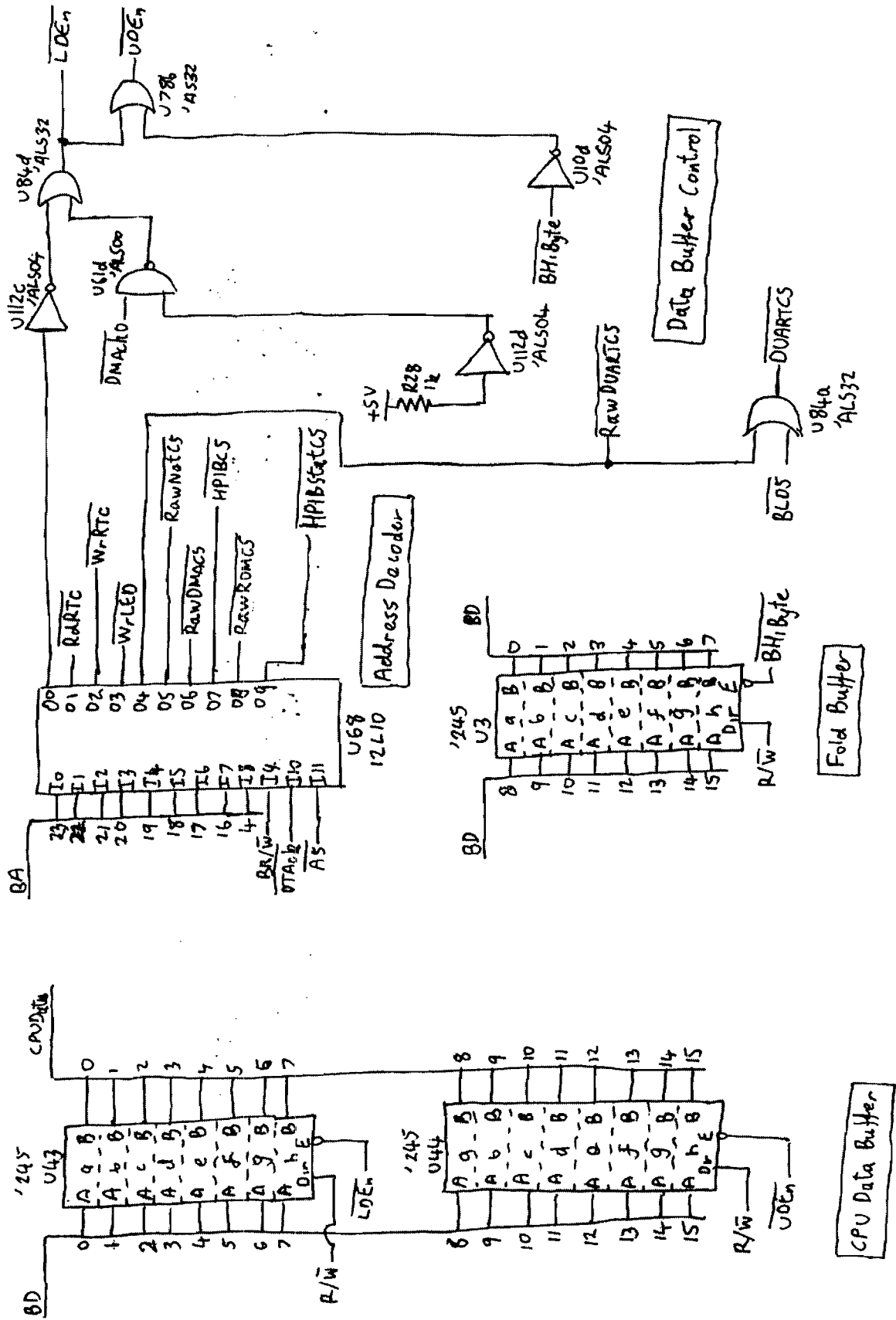

68440-8
U49

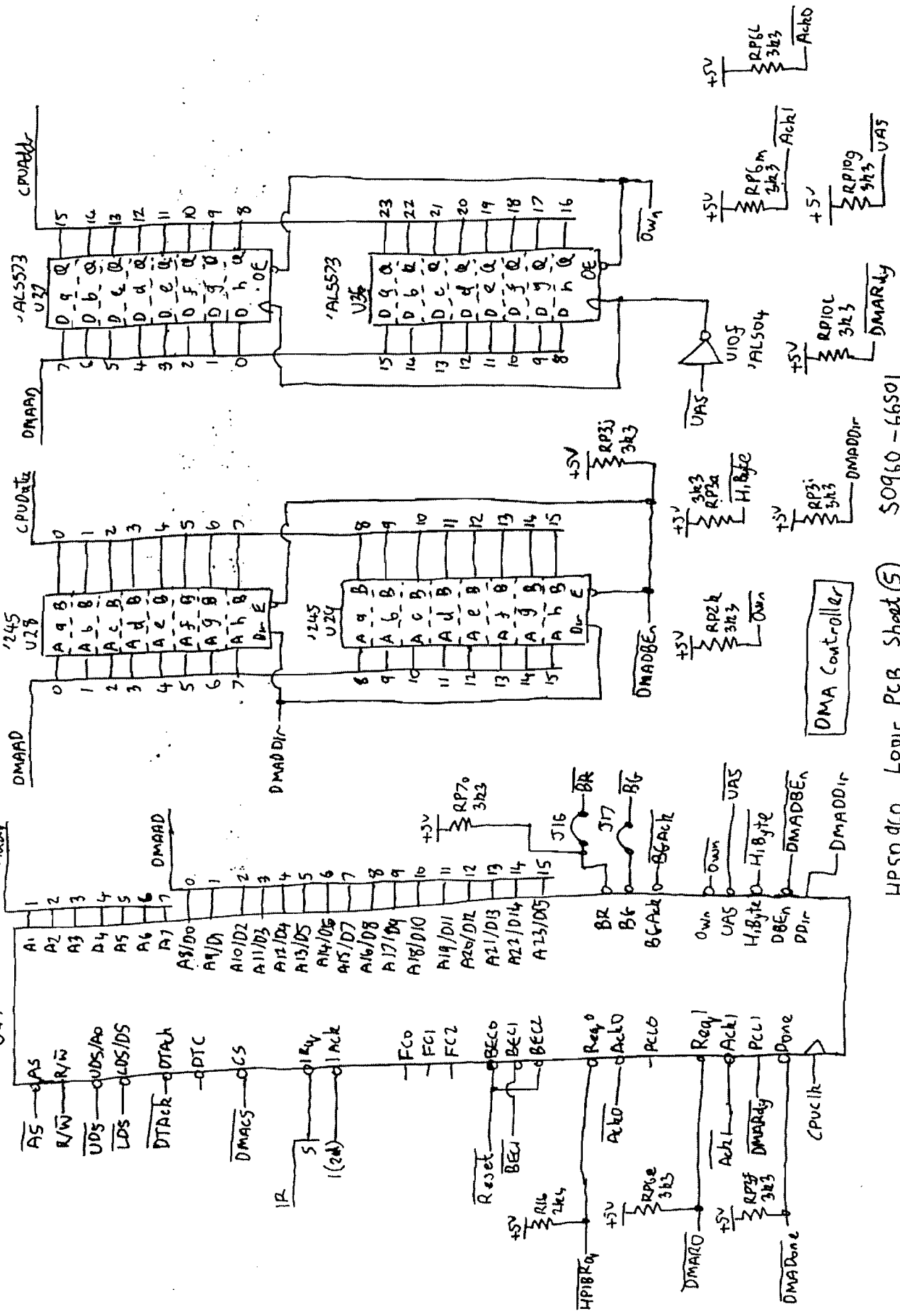

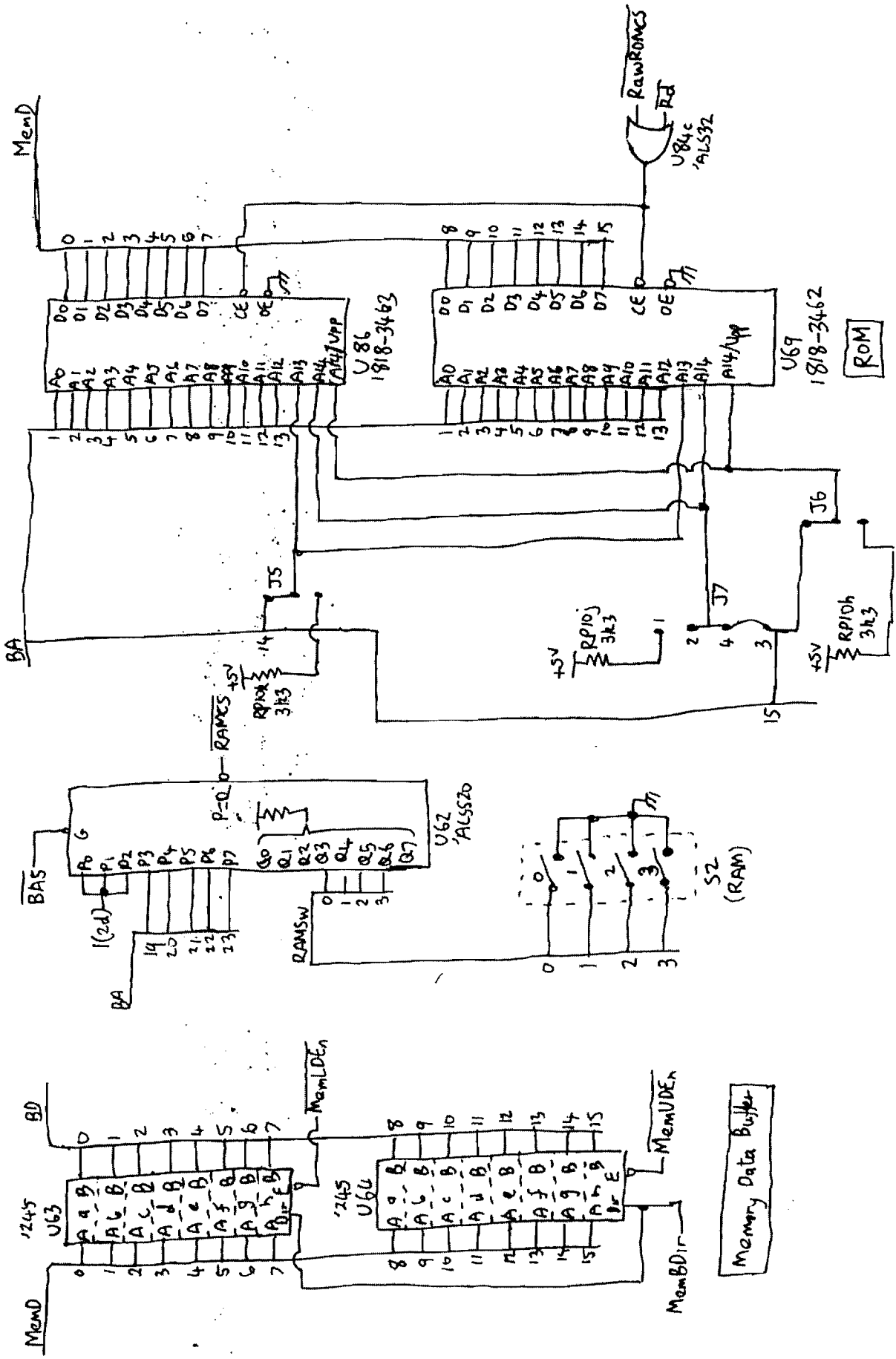

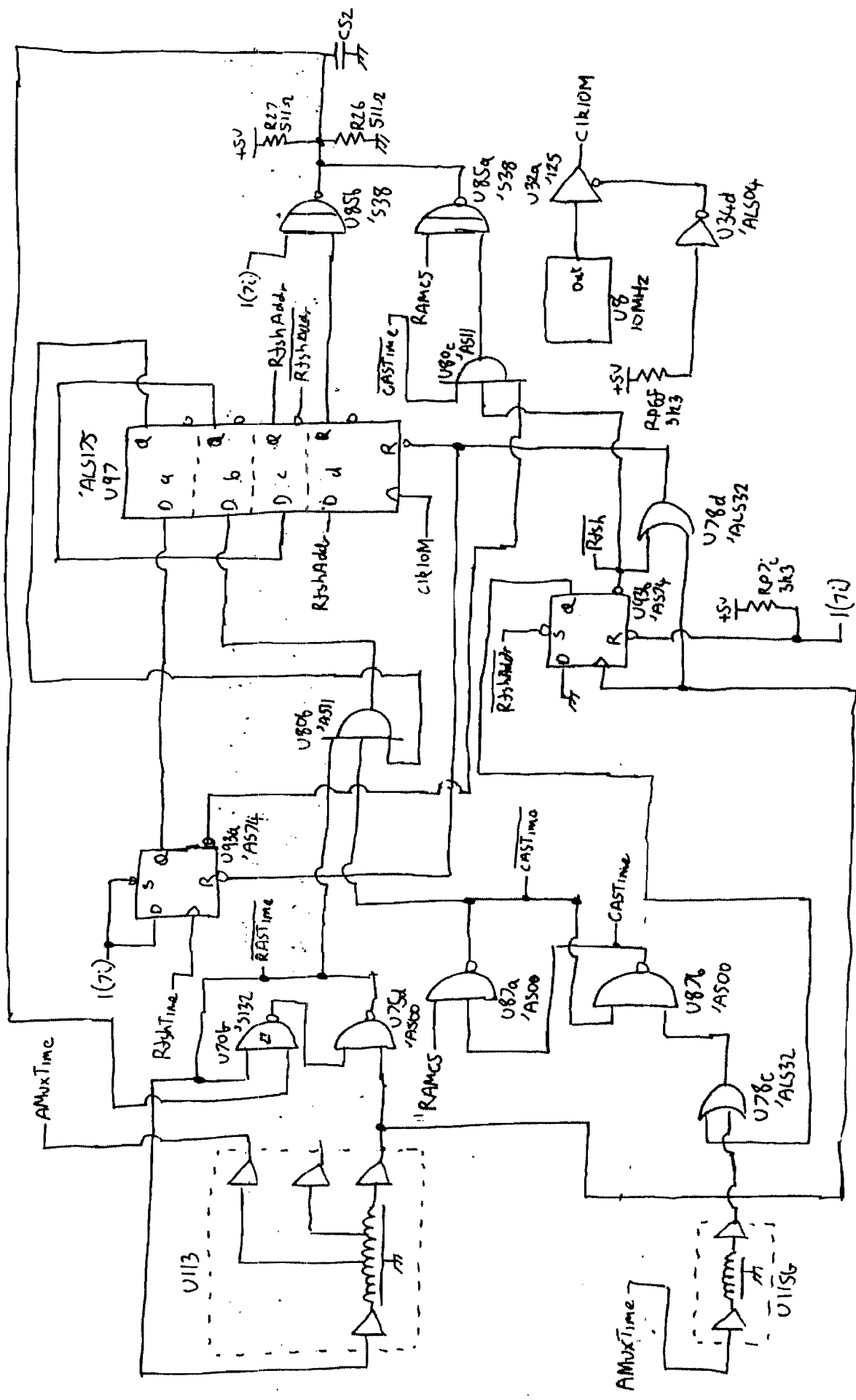

RAM Timing

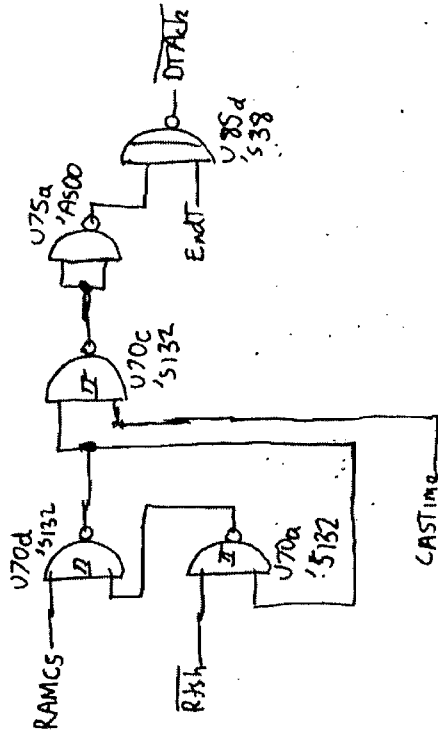

DTACH

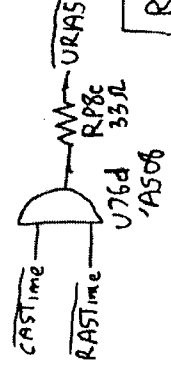
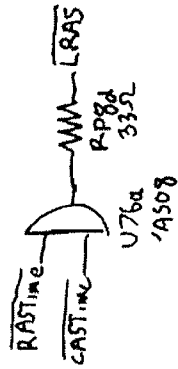
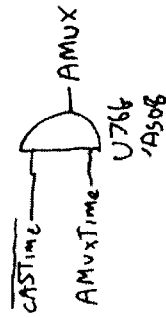
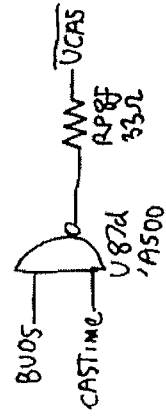
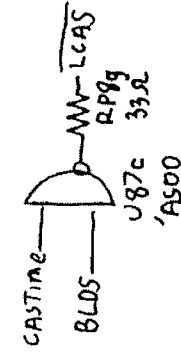
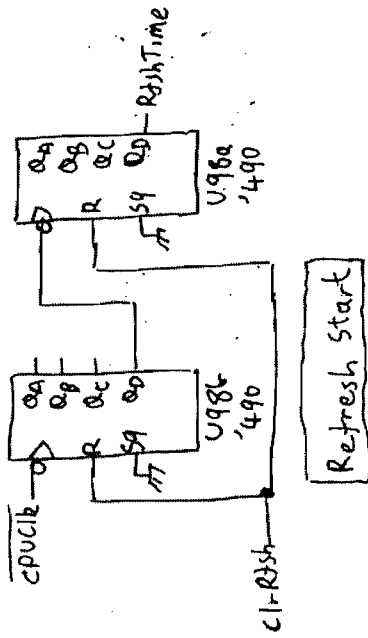
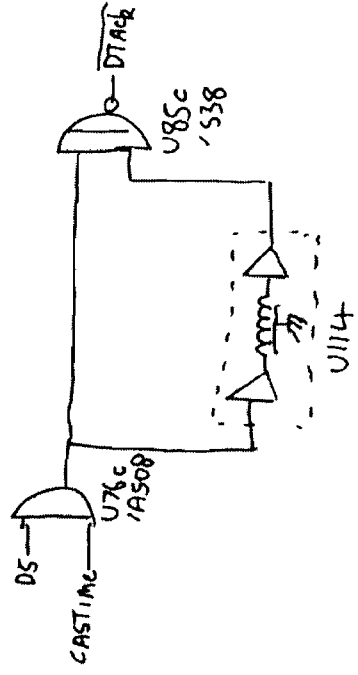

RAM Control

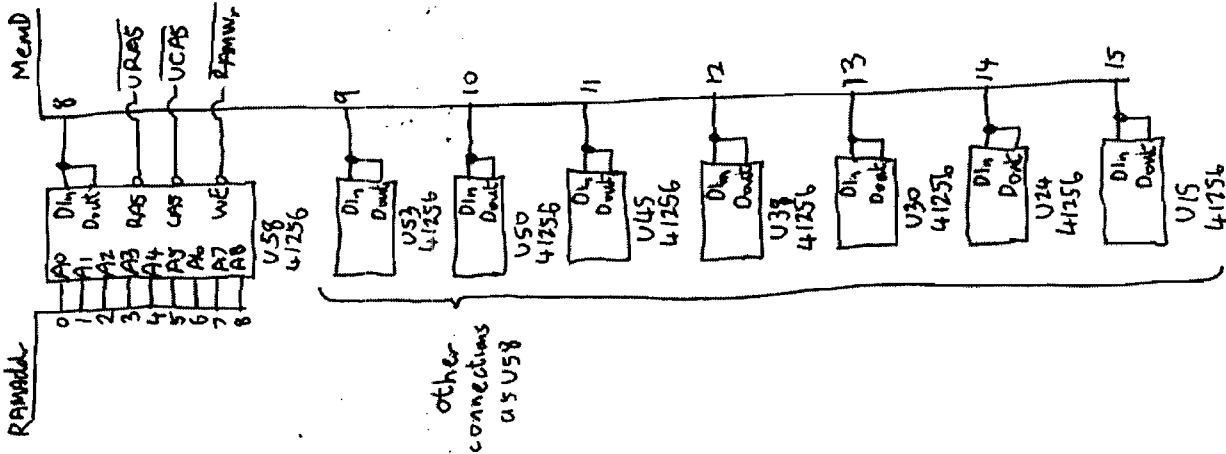

RAM

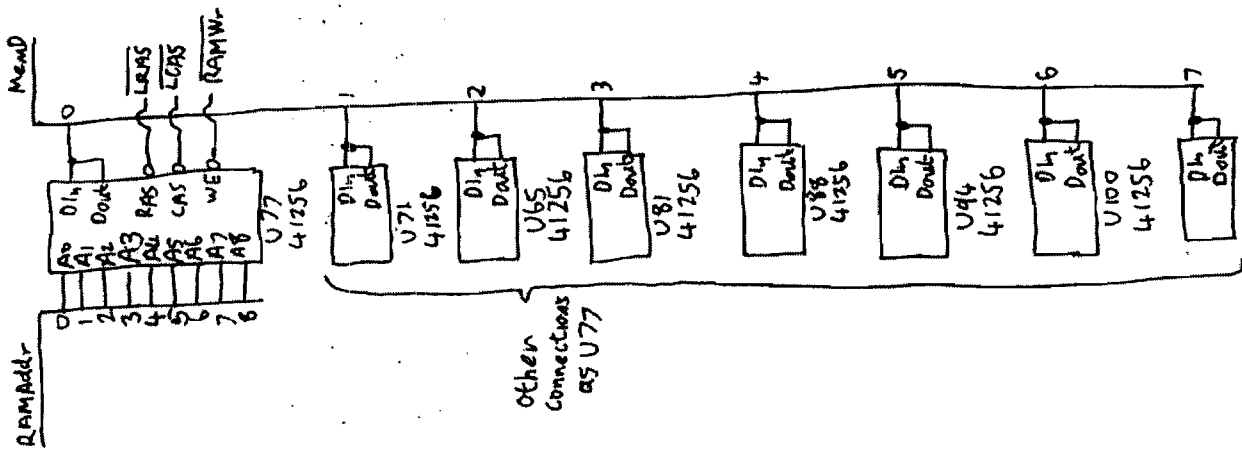

HP50960 Logic PCB Sheet 10 50960-66501

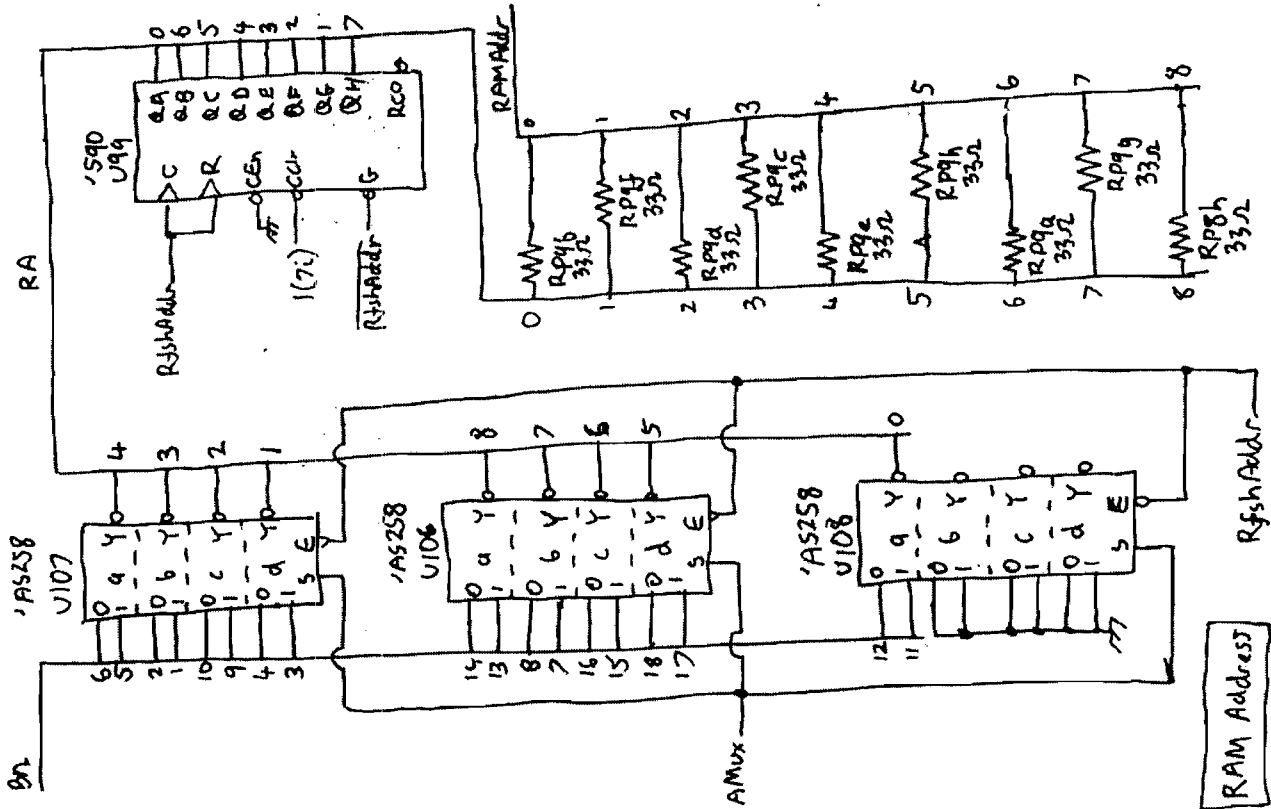

RAM Address

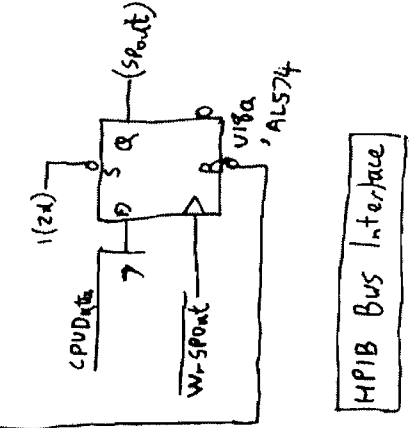
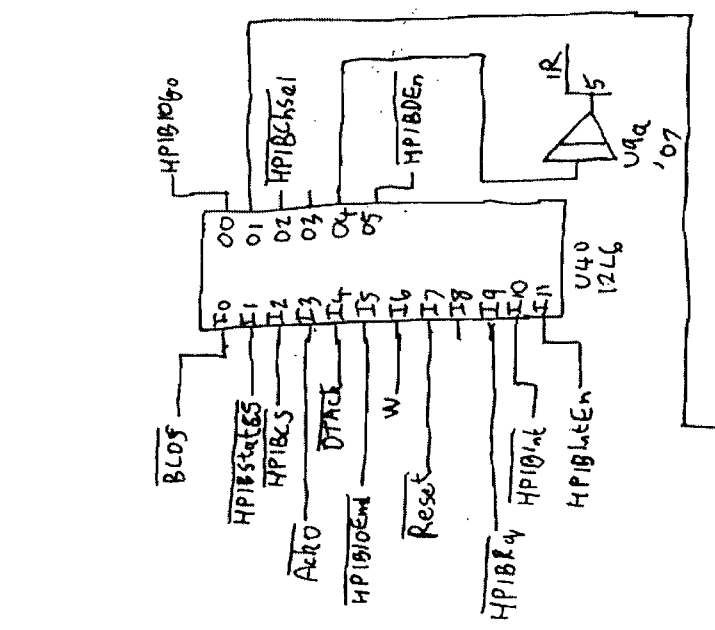
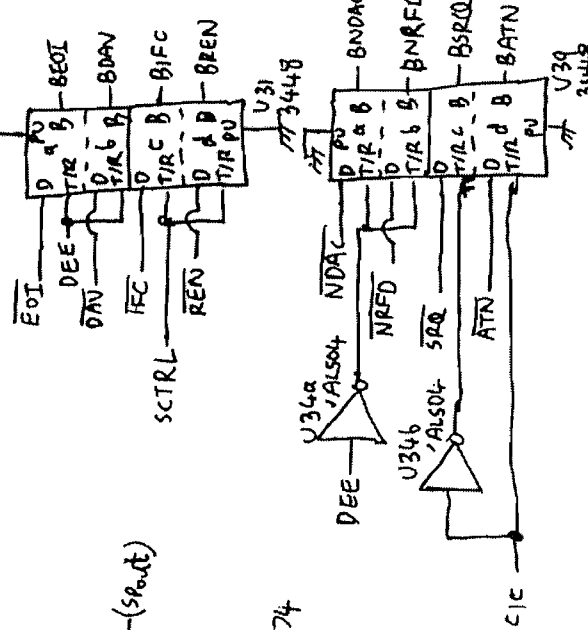
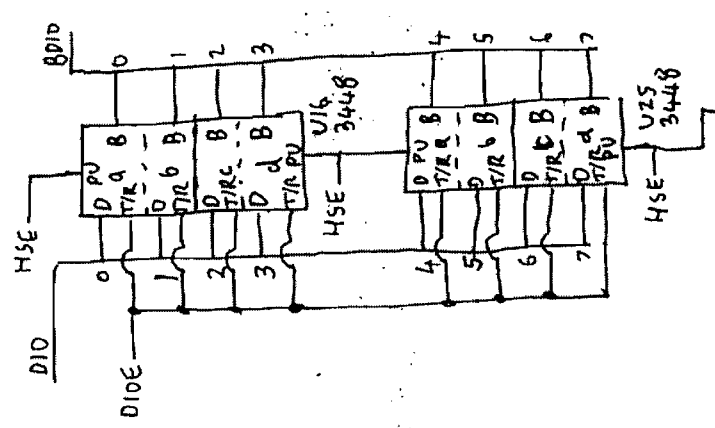
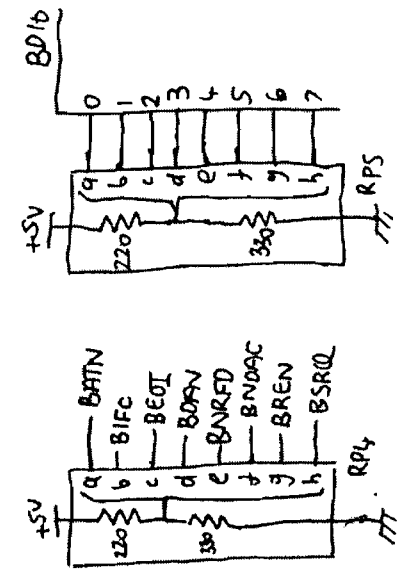
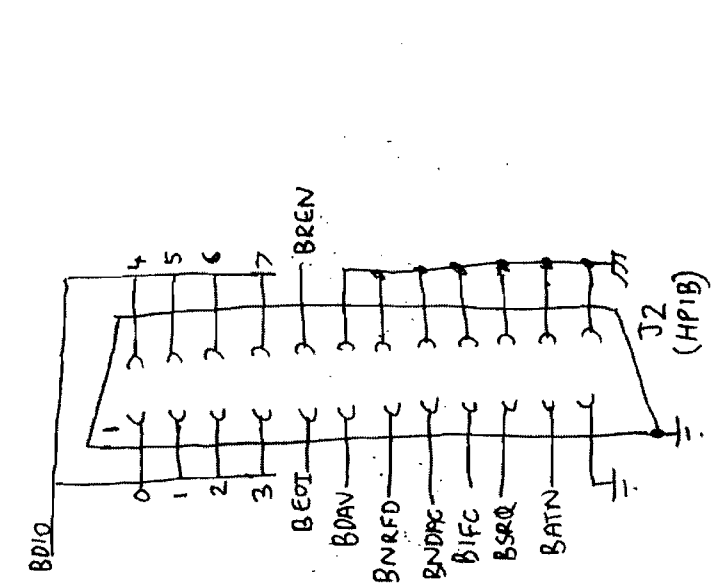

HP50960 Logic PCB Sheet 13
50960 - 66501

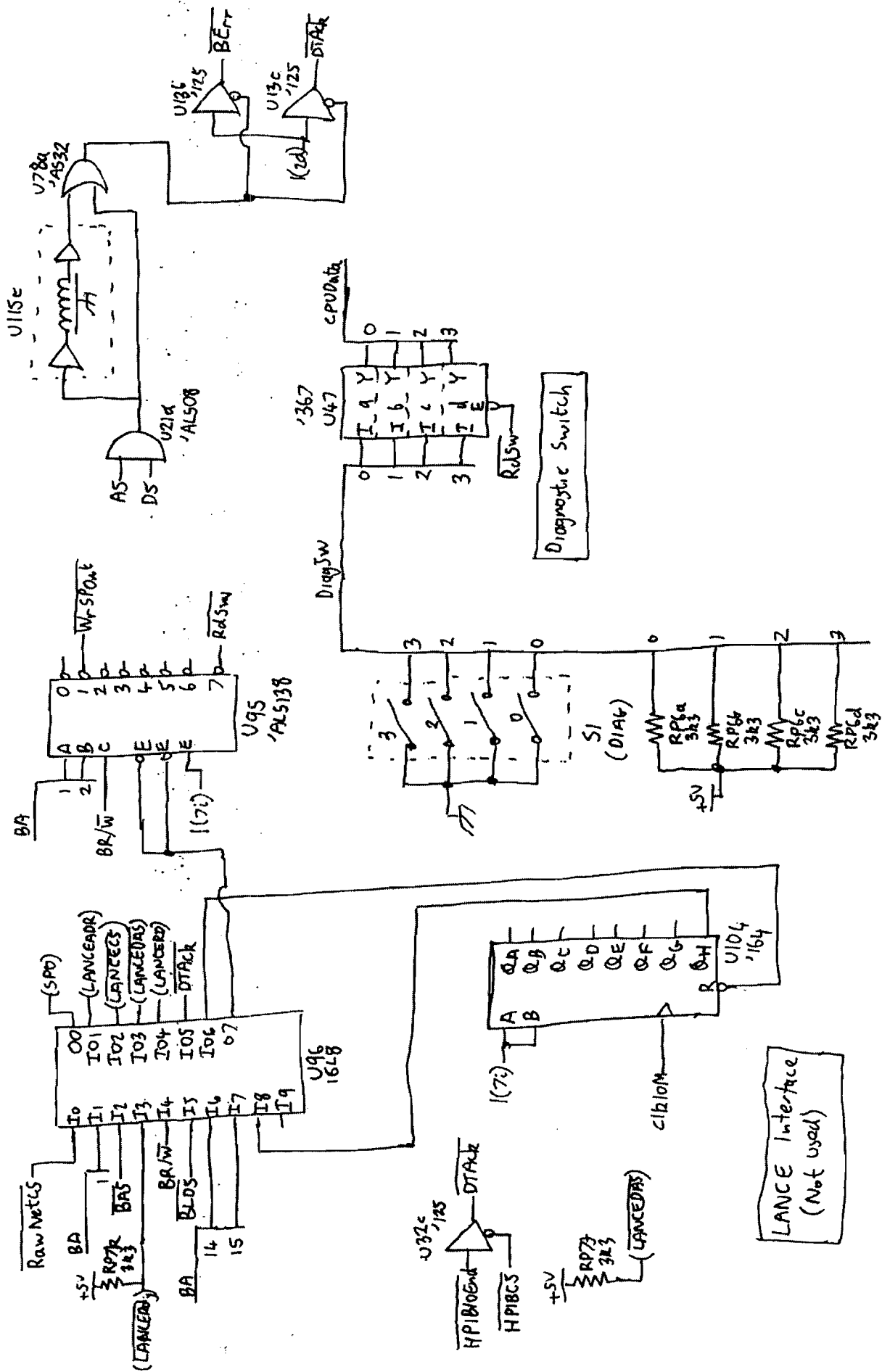

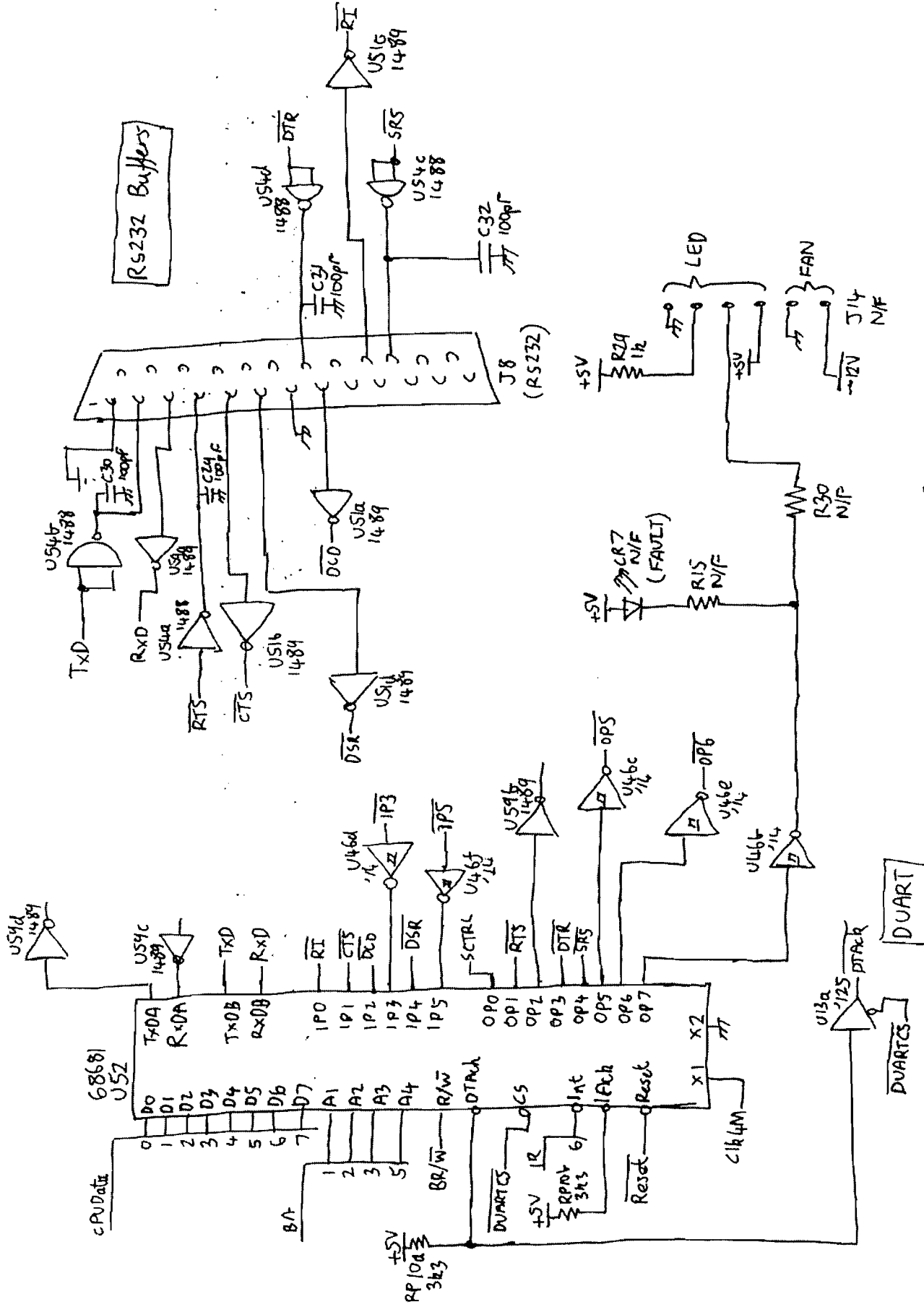

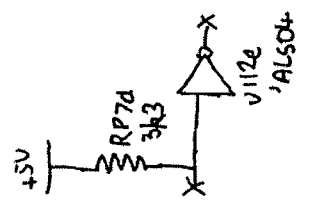
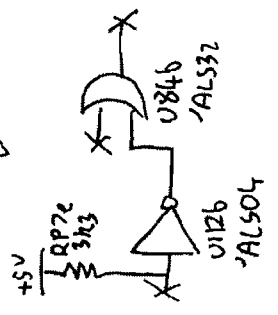
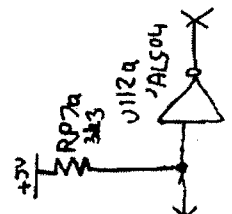
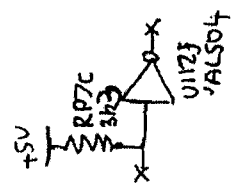
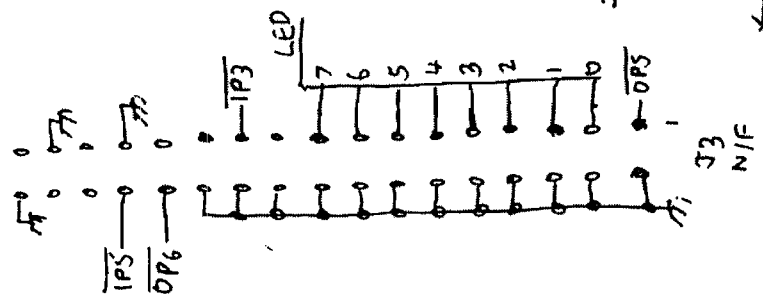
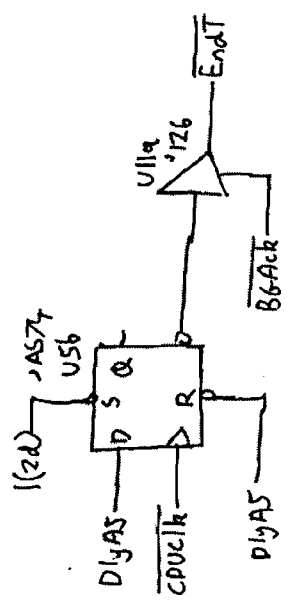
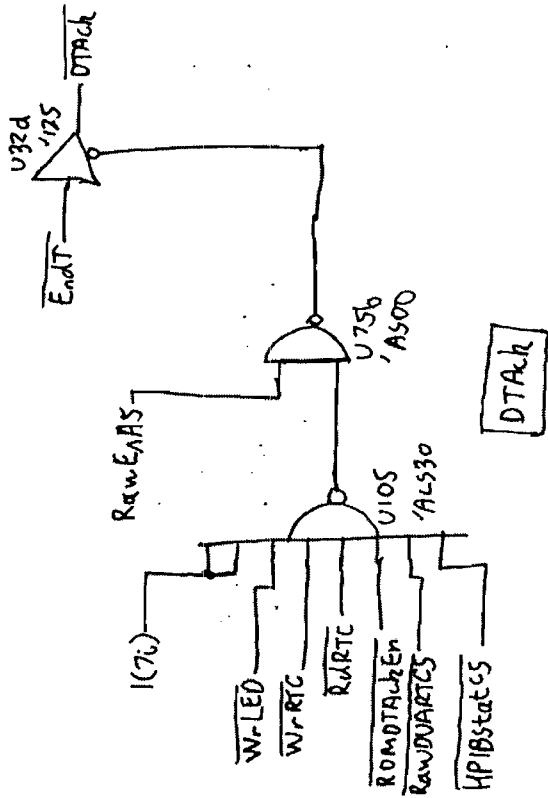

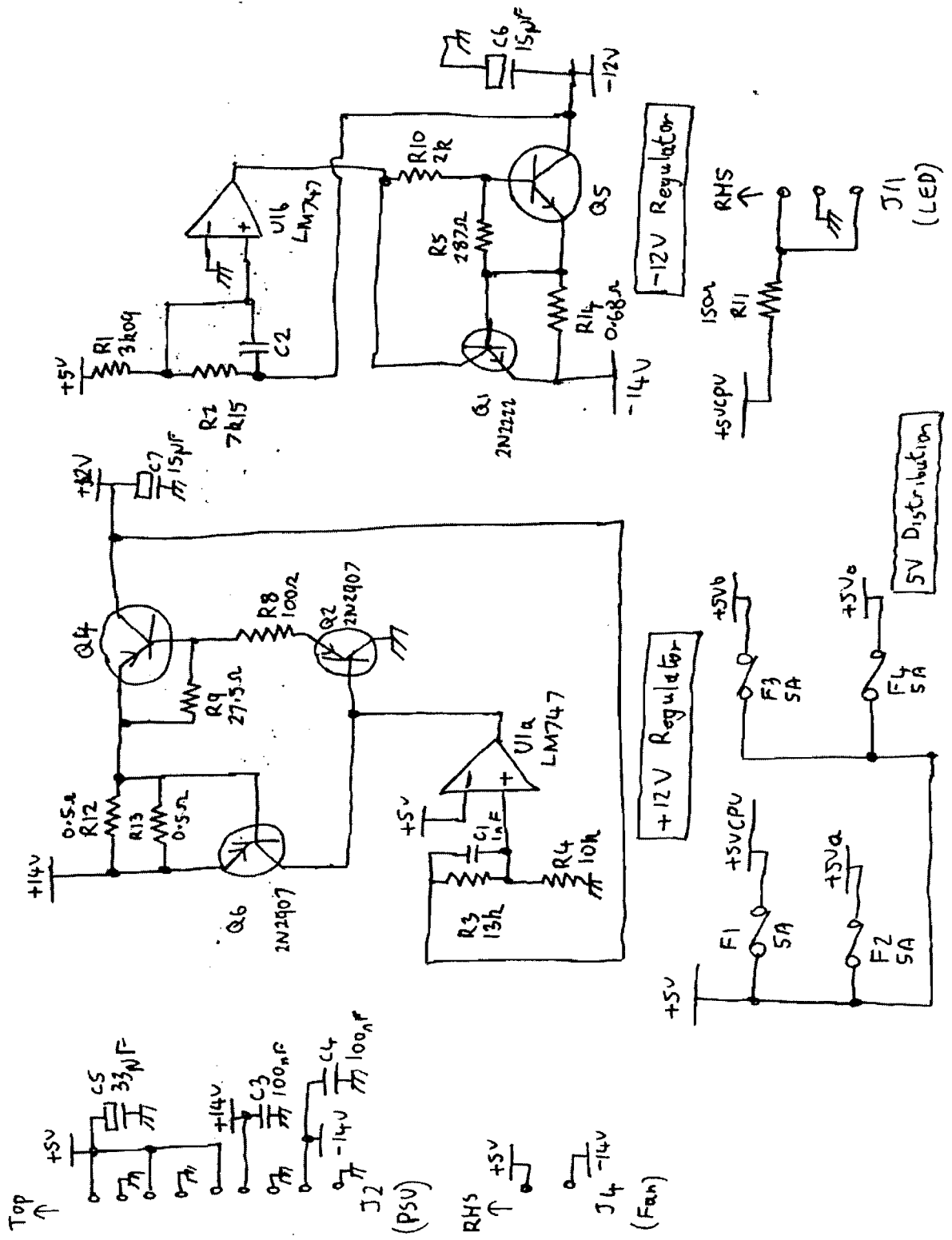

09817-66563

HP9817 Backplane Sheet ①

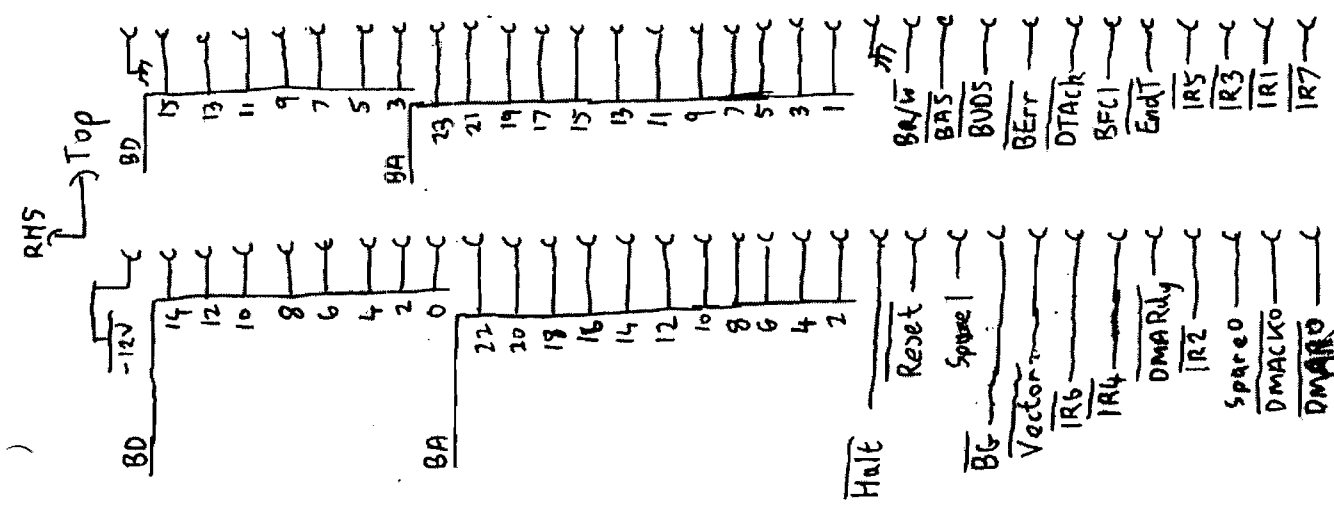

J1 (Logic PCB)

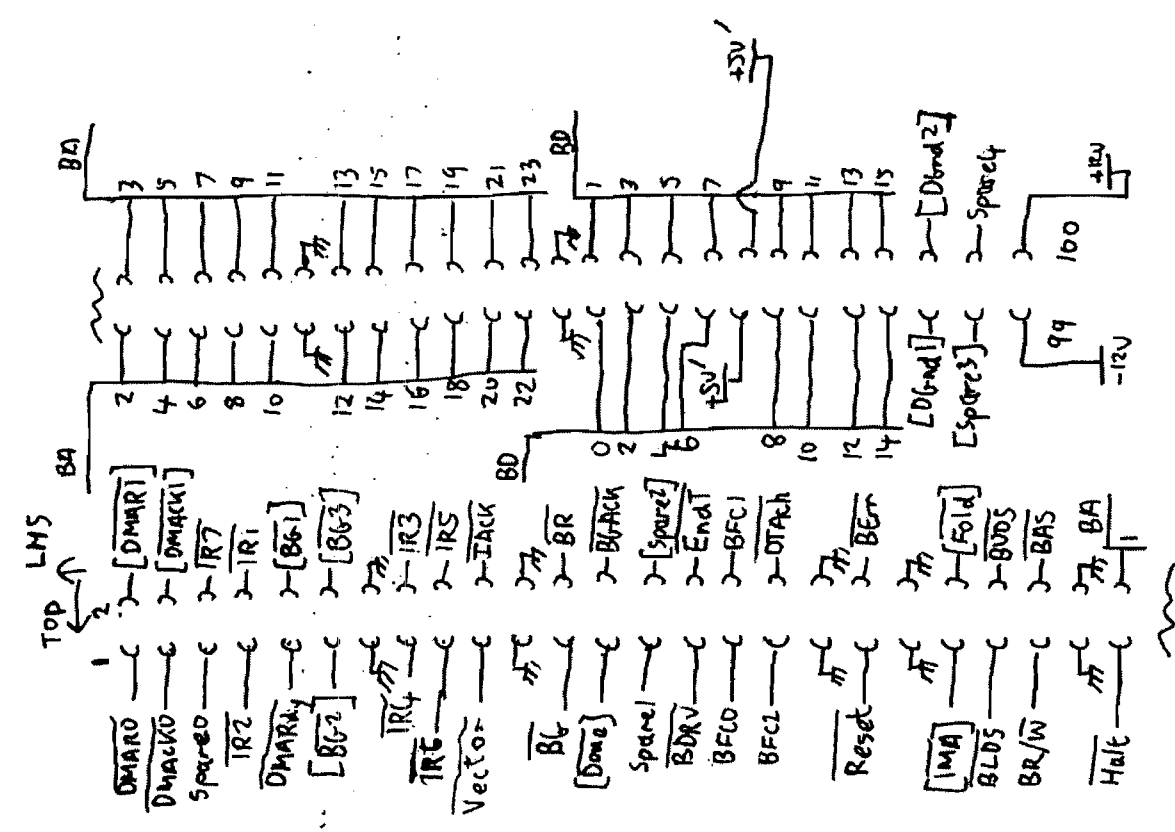

J5 (DIO)
(DIO slot (Typical of 6))

Note

D10 signals in square brackets are bused between slots, but do not go to Logic PCB

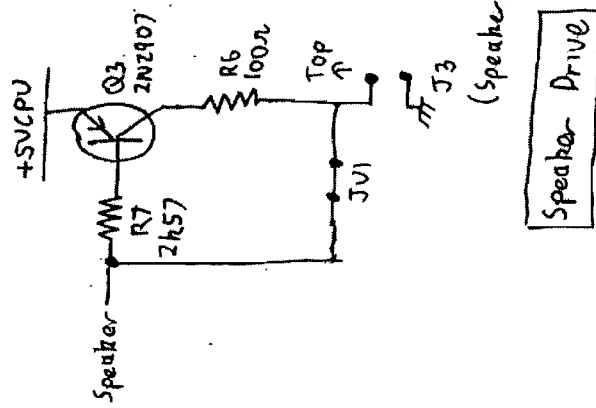
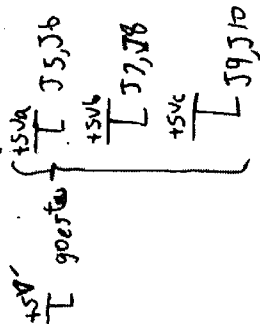

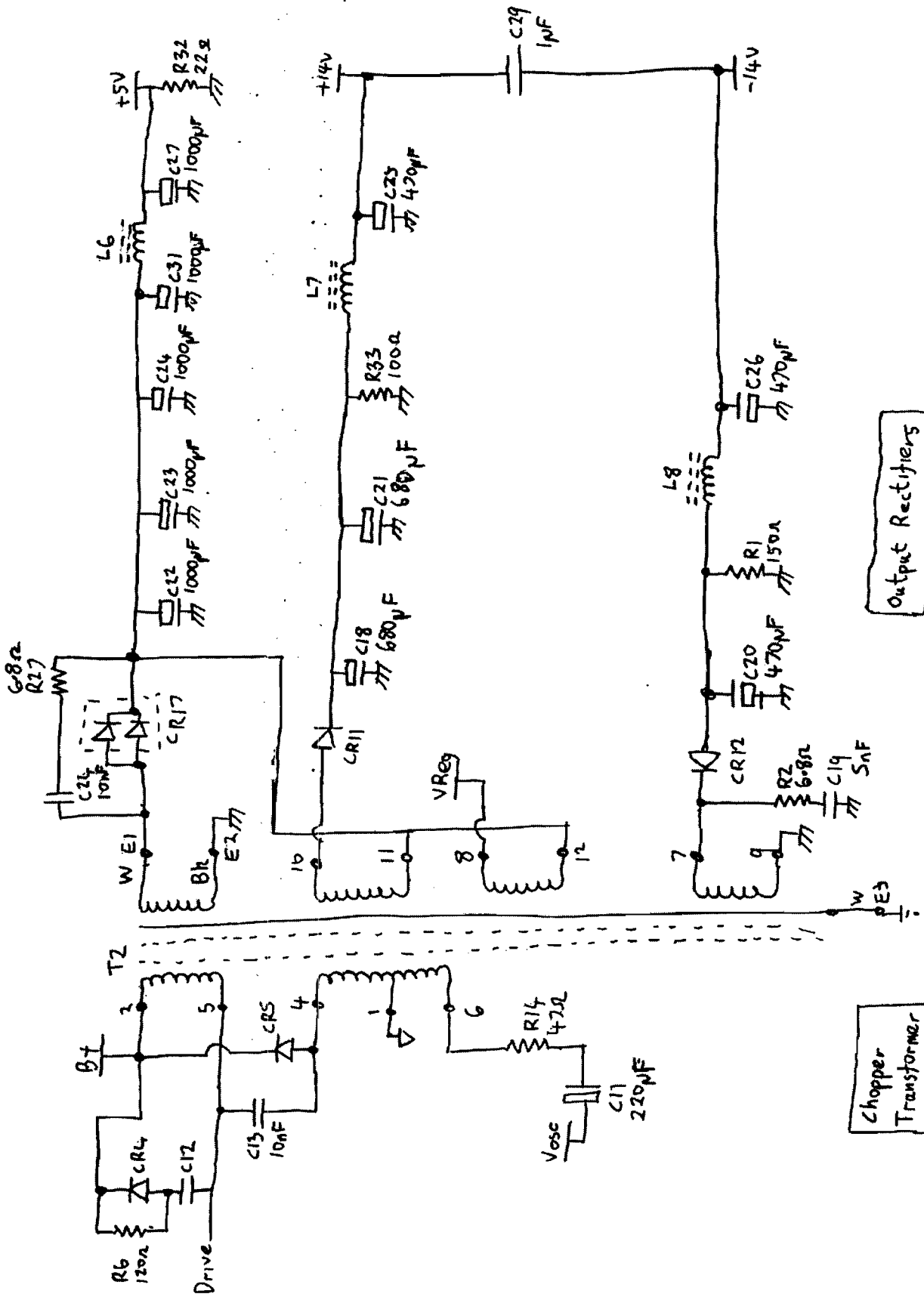

Chopper Transformer

Output Rectifiers

Power/Mate
09817-66552

HP9817 PSU PCB Sheet 3

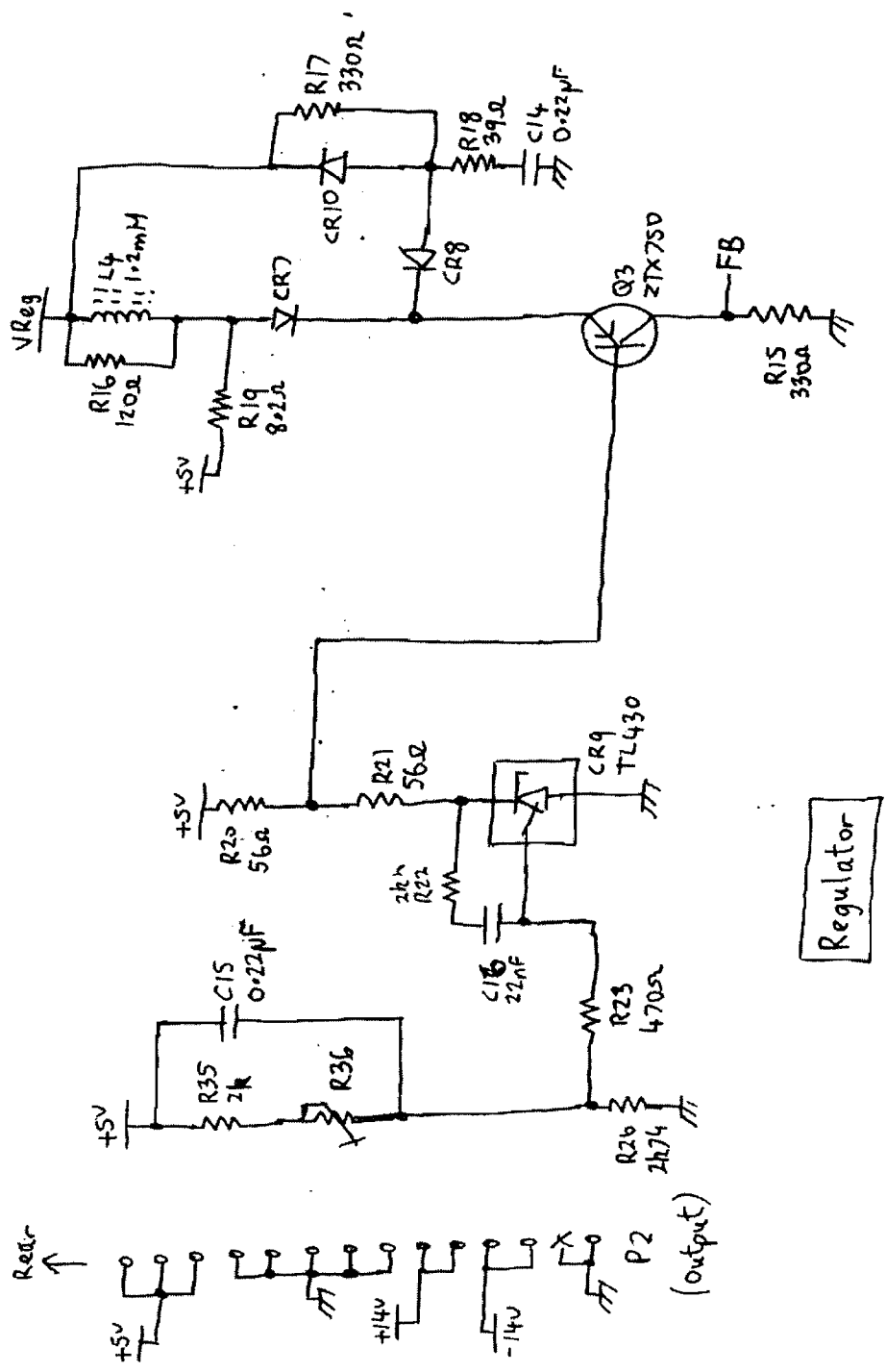

Power/Mate
09817-6655Z

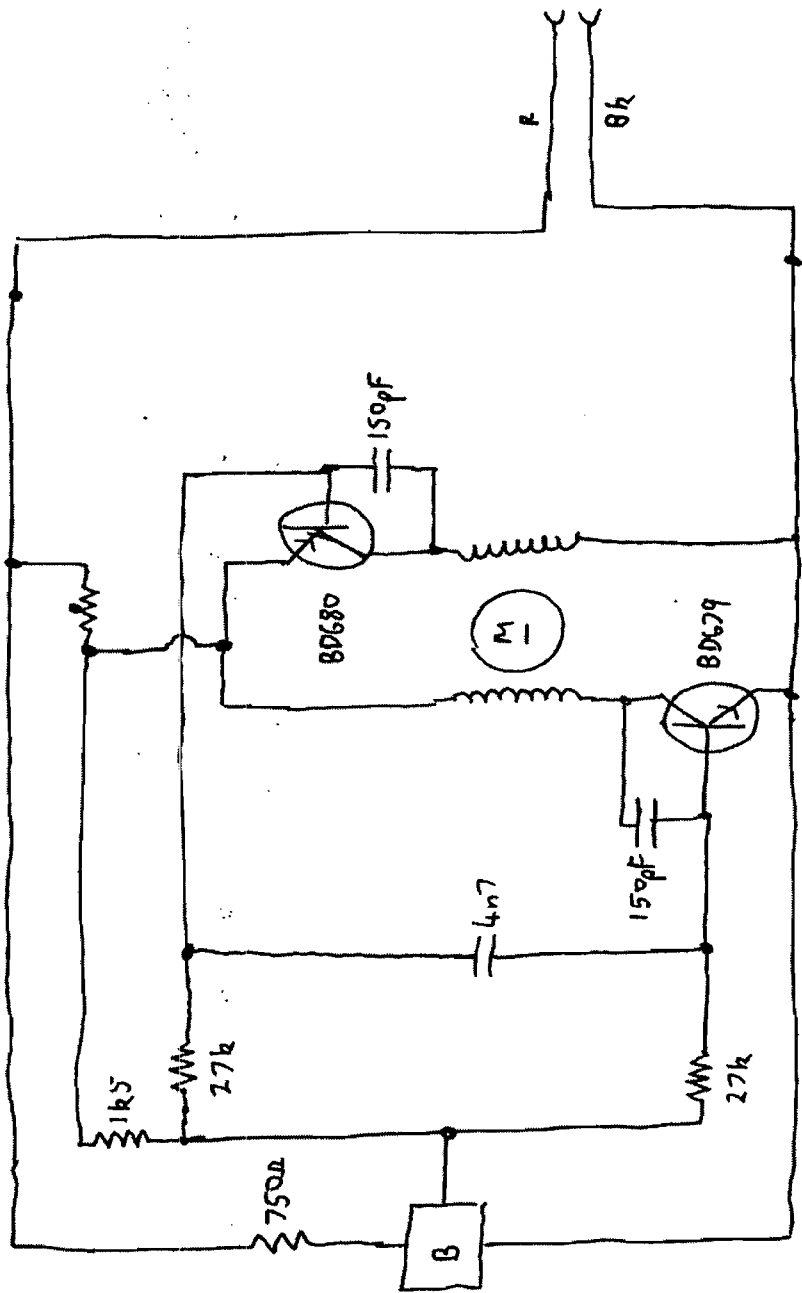

HP9817 Fan

Position	1	2	3	4
Voltage	115V	115V	230V	230V
Terminal	a	b	c	d

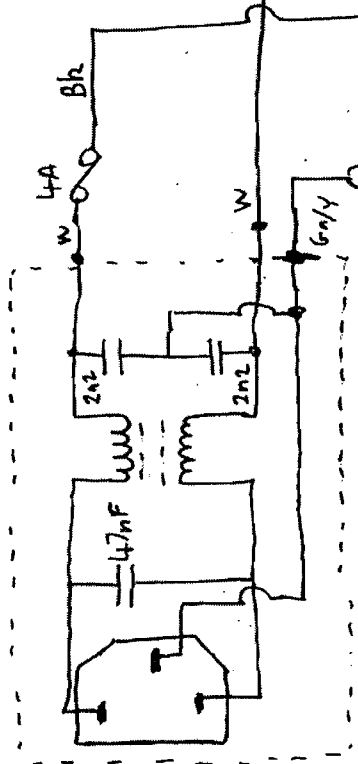
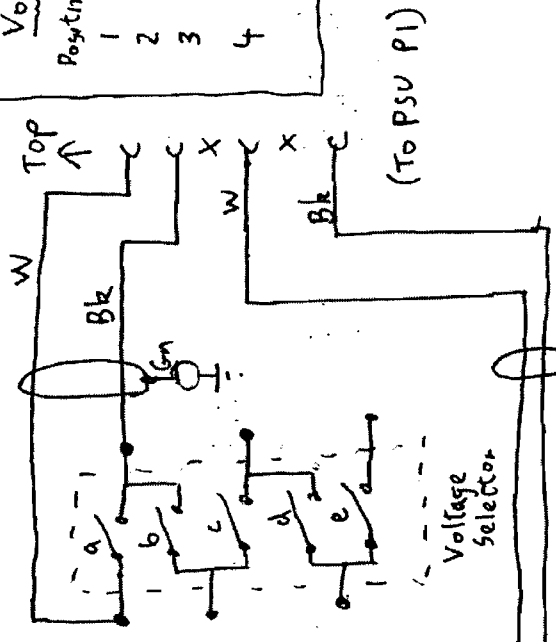

Mains Input Cable

Rear ↑

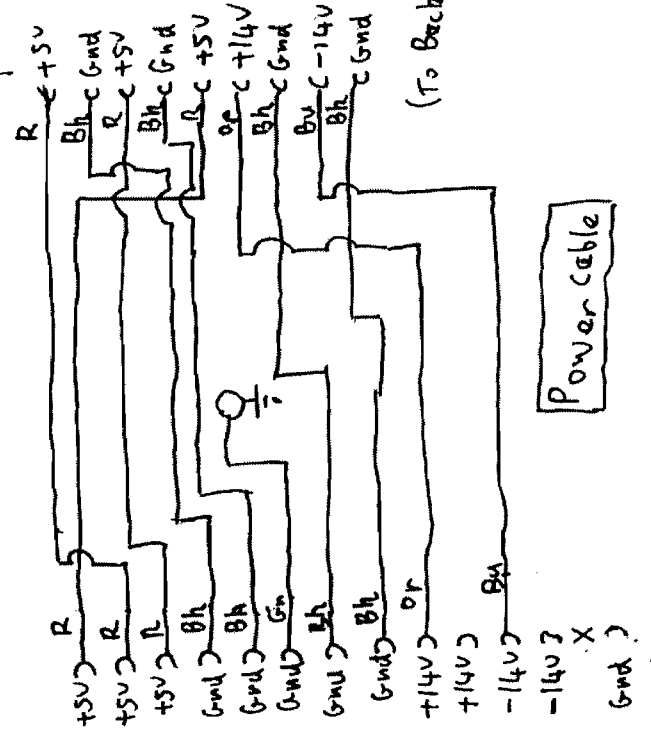

Power cable

(To PSU P2)

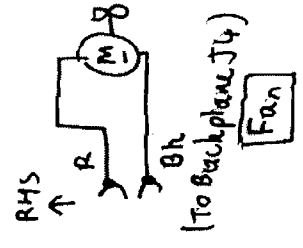

(To Backplane J4)

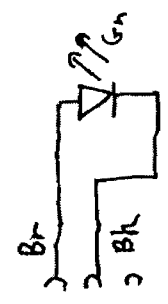

(To Backplane J11)

Power LED



(To Backplane J3)

Speaker

HP9817 Wiring