

Model 362/382 Controllers and HP A2246/A2247 Bus Expanders

Service Manual

HP 9000 Series 300 Controllers



**HP Part No. A1473-90030
Printed in USA July, 1991**

**Edition 1
E0791**

Notices

Information in this document is subject to change without notice.

Hewlett-Packard makes no warranty of any kind about this manual, including, but not limited to, the implied warranties of merchantability and fitness for a particular purpose. Hewlett-Packard shall not be liable for errors contained herein or direct, indirect, special, incidental or consequential damages about the furnishing, performance, or use of this material.

Warranty. Please carefully read the enclosed *Hewlett-Packard Software Product License Agreement and Limited Warranty* before operating this product. Rights in the software are offered only on the condition that the customer accepts all terms and conditions of the License Agreement.

Operating the product indicates your acceptance of these terms and conditions. If you do not agree to the License Agreement, you may return the unused product for a full refund.

A copy of the specific warranty terms applicable to your Hewlett-Packard product and replacement parts can be obtained from your local Sales and Service Office.

Copyright © Hewlett-Packard Company 1991 This document contains information which has been protected by copyright. All rights are reserved. Reproduction, adaptation, or translation without prior written permission is prohibited, except as allowed under the copyright laws.

Copyright © AT&T, Inc. 1980, 1984, 1986

Copyright © The Regents of the University of California 1979, 1980, 1983, 1985.

Software mentioned and documentation is based in part on the Fourth Berkely Software Distribution under license from the Regents of the University of California.

Restricted Rights Legend

Use, duplication or disclosure by the United States Government is subject to restrictions as set forth in subparagraph (c) (1) (ii) of the Rights in Technical Data and Computer Software clause at FARs 52.227.7013.

Hewlett-Packard Company
Fort Collins Systems Division
3404 East Harmony Road
Fort Collins, Colorado 80525

Printing History

This manual's printing date and part number show its current edition. The printing date will change when a new edition gets printed. Minor changes may be made at reprint without changing the printing date. The manual part number will change when extensive changes occur.

Manual updates may be issued between editions to correct errors or document product changes. To ensure that you receive these updates or new editions, you should subscribe to the appropriate product support service. See your Hewlett-Packard Sales Representative for details.

July, 1991 Edition 1

Safety Symbols and Conventions

The following conventions are used throughout this manual:

Note	Notes contain important information set off from the text.
-------------	--

Caution	Caution messages indicate procedures which, if not observed, could result in damage to equipment. Do not proceed beyond a CAUTION sign until the indicated conditions are fully understood and met.
----------------	---

Warning	Warning messages indicate procedures or practices which, if not observed, could result in personal injury. Do not proceed beyond a WARNING sign until the indicated conditions are fully understood and met.
----------------	---

Regulatory Statements

FCC Regulations (U. S. A. Only)

The Federal Communications Commission (in Subpart J of Part 15, Docket 20780) has specified that the following notice be brought to the attention of the users of this product.

Warning. This equipment generates, uses, and can radiate radio frequency energy and if not installed and used in accordance with the instructions manual, may cause interference to radio communications. It has been tested and found to comply with the limits for a Class A computing device pursuant to Subpart J of Part 15 of FCC rules, which are designed to provide reasonable protection against such interference when operated in a commercial environment. Operation of this equipment in a residential area is likely to cause interference

HP Computer Museum
www.hpmuseum.net

For research and education purposes only.

in which case the user at his own expense will be required to take whatever measures may be required to correct the interference.

Manufacturers Declaration (Germany Only)

Herstellerbescheinigung

Hiermit wird bescheinigt, daß dieses Gerät in Übereinstimmung mit den Bestimmungen der Postverfügung 1046/84 funktentstört ist. Der Deutschen Bundespost wurde das Inverkehrbringen dieses Gerätes angezeigt und die Berechtigung zur Überprüfung der Serie auf Einhaltung der Bestimmungen eingeräumt.

Turvallisuusyhteenveto (Finland Only)

Laserturvallisuus

Luokan 1 Laserlaite

Klass 1 Laser Apparat

HP 9000 Model 382 tietokoneeseen voidaan asentaa muistilaitteeksi laitteensisäinen CD-ROM-levyasema, joka on laserlaite. Tällöin myös päälaitteena toimiva tietokone katsotaan laserlaitteeksi.

Kyseinen CD-ROM-levyasema on käyttäjän kannalta turvallinen luokan 1 laserlaite. Normaalisissa käytössä levyaseman suojakotelo estää lasersäteen pääsyn laitteen ulkopuolelle.

HP 9000 Model 382 tietokoneen on tyyppihyväksynyt Suomessa laserturvallisuuden osalta Työsuojeluhallitus, Työsuojeluhallituksen hyväksyntänumero TSH 222/6019/90. Laitteiden turvallisuusluokka on määritetty valtioneuvoston päätöksen N:o 472/1985 ja standardin SFS-IEC 825 mukaisesti. Tiedot CD-ROM-levyasemassa käytettävän laserdiodin säteilyominaisuuksista:

Aallonpituus 780 nm

Teho 0,4 mW

Luokan 1 laser

VCCI Statement (Japan Only)

この装置は、第二種情報装置（住宅地域又はその隣接した地域において使用されるべき情報装置）で住宅地域での電波障害防止を目的とした情報処理装置等電波障害自主規制協議会（VCCI）基準に適合しております。

しかし、本装置をラジオ、テレビジョン受信機に近接してご使用になると、受信障害の原因となることがあります。

取扱説明書に従って正しい取り扱いをして下さい。

Laser Safety Statement (For U.S.A. Only)

(For controllers with a CD ROM disk drive installed.)

The CD ROM mass storage system is certified as a Class 1 laser product under the U.S. Department of Health and Human services (DHHS) Radiation Performance Standard according to the *Radiation Control for Health and Safety Act* of 1968.

This means that the mass storage system does not produce hazardous laser radiation. Since laser light emitted inside the mass storage system is completely confined within protective housings and external covers, the laser beam cannot escape from the machine during any phase of user operation.

Warning

- Use of controls, adjustments, or performing procedures different from those specified in this manual may result in hazardous invisible laser radiation exposure. None of the mechanisms within the mass storage system contain customer or field-replaceable parts.
 - The CD ROM drive becomes a Class 3B laser mechanism when disassembled. If the CD ROM drive is disassembled, exposure to the invisible laser beam and hazardous invisible laser radiation could result in blindness. Do NOT disassemble the CD ROM drive for any reason.
-

Finding Service Information

On the next page is a Service Information Locator. It shows where to find a variety of subjects dealing with servicing these products. To use this table, first find the type of information you need to reference in the left-hand column. Next, move to the right in that row to a referenced chapter number. Last, move up the column with the information's referenced chapter to the top. Across the top are manual titles and part numbers that have the information documented.

Chapter identifiers in the Locator use the following codes:

- **Chapter Number:** Numbers, such as 2. Inclusive chapters, such as 4-6.
- **Appendices:** A.
- **Entire Manual:** All
- **Varies:** (Check Table of Contents or Index.)

In some cases, two or more references will be shown for a given information type. You should check all references to be sure you get the specific information you need.

For example, suppose you need to find out what the Repair Philosophy is for the Model 382 controller. Locating "Repair Philosophy" in the left-hand column, and moving to the right in that row, you'll notice that this information is in "Chapter 1" of a manual. At the top of this column is the manual's abbreviated title. Chapter 7 in this manual lists manual titles and part numbers for service information.

Manuals identified in this locator are abbreviated by their initials as listed in the following table.

**Related Manual
Abbreviations and Manual Titles**

Abbreviation	Manual Title(s)
SM	Service Manual
SHB	Service Handbook
PI	Product Installation Note/Manual/Guide
CG	Series 300 Configuration Guide
OG	Controller's Owner's or Getting Started Guide

Service Information Locator.

Service Information	SM	SHB	CG	PI	OG
Assembly replacement and access	2				A
Block diagrams	3	9			
Booting Operating Systems	4,5,6				1
Controller tests/diagnostics	4,5	2	1,2,3		
Configurations	1,4,5	3	All		A
Configuring internal interfaces	4,5	3			A
Electrical requirements	1	1			
Environmental requirements	1,3	2			
Functional descriptions	3,4				
Installation	2,5	2		All	Varies
I/O Bus architecture	1,3				
Keyboard Differences	1,3,5	3			
Memory upgrades	1,3,5	3	4	All	A
Mass storage devices and upgrades	1,3,5	3	4	All	A
Monitors	1,3	3	3		
Networking	1,3	3	5		
Operating systems	1,4,5	3	1,A		1
Options/Accessories	1,3	3	Varies		A
Ordering parts	7	8			
Part numbers	7	8	All		
Peripherals	1,3,5	3	1,3,4,5,6		
Product information	1	1	All		1
Product numbers	1	1,3	All		1
Reference material	8	10			
Repair philosophy	1,7	1			
Self-tests	4,5,6	5			A
Service notes	1	11			
Tools required	2	1			A
Troubleshooting	6	4			
Turn-on	3,4,5,6	4,5			2
System Bundles	1	3	2		



Contents

1. Product Information	
Product Descriptions	1-1
Controller Features	1-2
Memory	1-3
System Graphics	1-3
Built-In Interfaces	1-3
Small Computer Systems Interface (SCSI)	1-4
RS-232 Serial Interface	1-4
HP Parallel Interface	1-4
Hewlett-Packard Human Interface Loop (HP-HIL)	1-4
Local Area Network Interface	1-4
Audio Interface	1-5
HP-IB Interface	1-5
Internal Mass Storage Devices	1-5
Supported Accessory Cards	1-5
DIO-I Accessory Cards	1-5
Supported DIO-I Accessory Cards	1-6
DIO-I Accessory Cards	1-6
Hardware Architecture	1-6
Controller Hardware Architecture	1-6
Expander Hardware Architecture	1-6
Operating Systems	1-7
HP-UX	1-7
System Bundles	1-8
Technical Information	1-9
Electrical	1-9
Regulatory	1-9
Environmental	1-10
Physical	1-10
Controllers	1-10
Expanders	1-10
Product Identification	1-11
Support	1-11
Hardware Support	1-11
Field Repair Philosophy	1-11
Schematics	1-11
Supported Configurations	1-11
Repair Services	1-12
Hardware Support Services	1-12

2. Assembly Replacement

Introduction	2-1
Tools Required	2-1
Safety Precautions	2-2
Electrical Precautions	2-2
Mechanical Precautions	2-2
Model 362 and 382 Controllers	2-3
Overview and Parts References	2-3
DIO-I Accessory Cards	2-6
Preliminary Requirements	2-6
Removal and Installation	2-6
Top Cover	2-7
Preliminary Requirements	2-7
Removal	2-7
Installation	2-8
RAM Boards	2-9
Preliminary Requirements	2-9
Removal	2-9
RAM Board Installation Requirements	2-11
Model 362 Controller	2-11
Model 382 Controller	2-11
Installation	2-12
DIO-I Card Cage and Backplane	2-13
Preliminary Requirements	2-13
Removal and Installation	2-13
DIO-I Backplane Board	2-15
Preliminary Requirements	2-15
Removal and Installation	2-15
Hard Disk Drives	2-17
Preliminary Requirements	2-17
Removal and Installation	2-17
Left-Side Hard Disk Drives	2-17
Flexible Disk Drive	2-20
Preliminary Requirements	2-20
Removal and Installation	2-20
CD ROM Disk Drives	2-23
Preliminary Requirements	2-23
Removal and Installation	2-23
Real-Time Clock Battery	2-26
Preliminary Requirements	2-26
LAN Board	2-28
Preliminary Requirements	2-28
Removal	2-28
Installation	2-30
System Board	2-31
Preliminary Requirements	2-31
Removal	2-31
Installation	2-33
Power Supply	2-34
Preliminary Requirements	2-34
Removal and Installation	2-34

Front Panel	2-36
Preliminary Requirements	2-36
Removal and Installation	2-36
Feet	2-38
Preliminary Requirements	2-38
Removal and Installation	2-38
Fan	2-39
Preliminary Requirements	2-39
Removal and Installation	2-39
SCSI Cable	2-41
Preliminary Requirements	2-41
Removal and Installation	2-41
Power Switch Assembly	2-43
Preliminary Requirements	2-43
Removal and Installation	2-43
Mass Storage Trim Plate	2-45
Preliminary Requirements	2-45
Removal and Installation	2-45
HP A2246A DIO-I 4-Slot and HP A2247A DIO-II 2-Slot Bus Expanders	2-46
Overview and Parts References	2-46
DIO-I and DIO-II Accessory Cards	2-51
Preliminary Requirements	2-51
Removal and Installation	2-51
Top Cover	2-52
Preliminary Requirements	2-52
Removal	2-52
Installation	2-53
Removing an Expander from a Controller	2-54
Preliminary Requirements	2-54
Removal and Installation	2-54
DIO-I Expander Fan	2-56
Preliminary Requirements	2-56
Removal and Installation	2-56
DIO-I Expander Power Supply	2-59
Preliminary Requirements	2-59
Removal and Installation	2-59
DIO-I Expander Card Cage and Backplane	2-62
Preliminary Requirements	2-62
Removal and Installation	2-62
Front Panel	2-65
Preliminary Requirements	2-65
Removal and Installation	2-65
Power Cable Assembly	2-67
Preliminary Requirements	2-67
Removal and Installation	2-67
DIO-II Expander Power Supply	2-69
Preliminary Requirements	2-69
Removal and Installation	2-69
DIO-II Expander Fan	2-71
Preliminary Requirements	2-71
Removal	2-71

Installation	2-73
DIO-II Card Cage	2-74
Preliminary Requirements	2-74
Removal and Installation	2-74
Flexible Backplane	2-76
Preliminary Requirements	2-76
Removal and Installation	2-76
3. Functional Description	
Overview	3-1
Power Supply	3-3
System Board	3-4
CPU Circuit	3-4
Boot ROM Circuit	3-6
Graphics Circuit	3-6
Low-Resolution Graphics	3-6
Medium-Resolution Graphics	3-7
Memory Controller Circuit	3-7
Model 362 RAM Controller	3-7
Model 382 RAM Controller	3-8
DIO-II I/O Controller	3-9
SCSI Interface Circuit	3-9
Termination	3-10
Internal Configuration	3-10
External Configuration	3-10
LAN Interface Circuit	3-11
HP Parallel Interface Circuit	3-13
HP-HIL Interface Circuit	3-14
HP-IB Interface Circuit	3-14
Audio Interface Circuit	3-15
RS-232 Interface Circuit	3-15
Model 362 RS-232 Interface	3-15
Model 382 RS-232 Interface	3-15
RAM Boards	3-16
Model 362 Memory	3-17
Model 382 Memory	3-18
Backplane Board	3-19
Hard Disk Drives	3-20
52 Mbyte Hard Disk Drives	3-21
Performance	3-21
Data Transfer Rates	3-21
Maximum Error Rates	3-21
Seek Times	3-21
Environmental Requirements	3-21
Ambient Temperature	3-21
Altitude	3-22
Ambient Relative Humidity	3-22
210 Mbyte and 420 Mbyte Hard Disk Drives	3-23
Performance	3-23
Buffer to SCSI Bus Data Transfer Rate	3-23
SCSI Bus to Buffer Data Transfer Rates	3-23

Maximum Error Rates	3-23
Functional	3-24
Environmental Requirements	3-24
Ambient Temperature	3-24
Altitude	3-24
Ambient Relative Humidity	3-24
CD ROM Disk Drive	3-25
Technical Information	3-26
Controller Data Transfer Rate (asynchronous)	3-26
Access Time (including latency)	3-26
Functional	3-26
Media	3-27
Environmental Requirements	3-27
Temperature	3-27
Altitude	3-27
4. Boot ROM Functions	
Boot ROM Functions	4-1
Power-Up Display	4-1
Power-Up Sequence	4-2
Human Interfaces	4-3
Output Devices	4-3
Input Devices	4-3
Booting Over the LAN	4-3
Normal Power-Up Displays	4-5
Power-Up Display	4-5
Boot ROM Self-Tests	4-6
Hardware Initialization Support	4-6
Go/No-Go Self-Test Support	4-6
Failure Indications	4-6
Boot ROM Messages	4-7
5. Configuring the Controller	
Introduction	5-1
Keyboard Differences	5-1
Key Difference	5-1
Boot ROM Functions	5-3
Power-Up Displays	5-3
Configuration Control Mode	5-3
Configuration Control Mode Menu	5-3
Configuring the Internal Interfaces	5-4
Internal Interface Default Values	5-5
Example Interface Configuration	5-5
Auto System Selection Mode	5-7
The Menu	5-7
Menu Options	5-8
System Selection Example	5-8
Error Messages	5-9
Finding the HP-UX SCSI Bus Addresses	5-11
HP-UX Program for SCSI Addresses	5-11
Internal Mass Storage Configurations	5-12

Hard Disk Drives	5-12
Setting the Hard Disk Drive Configuration Jumpers	5-12
SCSI Bus Address Jumpers	5-13
The HP A2257A 52 Megabyte Hard Disk Drives	5-13
Setting the Drive Configuration Jumpers	5-13
SCSI Bus Address Jumpers	5-14
3.5-in Flexible Disk Drive	5-14
Setting the Configuration Jumpers	5-14
Function Jumpers	5-16
SCSI Bus Address Jumpers	5-16
SCSI Bus Address Jumpers	5-16
CD ROM Disk Drive	5-16
Setting the Drive Configuration Jumpers	5-16
SCSI Bus Address Jumpers	5-17
Parity	5-17
Audio Use	5-17
External SCSI Cables	5-18
SCSI Cable Rules	5-18
Supported Accessory Cards	5-18
DIO-I Accessory Cards	5-18
Supported DIO-I Accessory Cards	5-19
Graphics Configuration	5-19
LAN Type	5-20

6. Troubleshooting

Introduction to Troubleshooting	6-1
Analytic Troubleshooting	6-1
Operating Systems	6-2
Troubleshooting in the HP-UX Environment	6-2
Troubleshooting Procedures	6-2
Troubleshooting Flowcharts	6-3
Boot ROM Self-Tests	6-6
Hardware Initialization Support	6-6
Go/No-Go Self-Test Support	6-6
Failure Indications	6-7
General Description of Failure Codes	6-8
State and Failure Codes	6-9
Test Mode	6-11
Self Test Control Menu	6-12
Continuous Self-Tests	6-12
Extended Self-Tests	6-12
Test Memory	6-12
Memory Configurations and Addressing	6-13
Model 362 Memory Troubleshooting	6-13
Example: Total Memory of 8 Mbytes	6-14
Model 382 Memory Troubleshooting	6-14
Example: Total Memory of 8 Mbytes	6-15
Example: Total Memory of 24 Mbytes	6-15
Set Defaults	6-16
Run Tests	6-16
SCSI Interface and Device Testing	6-16

Normal SCSI Testing	6-16
SCSI Exerciser Testing	6-17
CE Mode Functions	6-18
Controller Checkout Procedures	6-19
Checkout Procedures for Model 362/382 Controllers	6-19
Using The HP-UX ce.utilities	6-20
7. Parts Lists	
Introduction	7-1
Exchange Parts	7-1
Model 362 and 382 Controllers	7-2
HP A2246A DIO-I Bus Expander	7-6
HP A2247A DIO-II Bus Expander	7-8
8. Reference Documentation	
Introduction	8-1
Service Documentation	8-1
System Installation and Getting Started Documentation	8-2
Upgrade Documentation	8-2
Index	



Figures

1-1. Model 362 or Model 382 Controller System	1-1
1-2. Controller Rear Panel	1-3
2-1. Controller Hardware Orientation	2-3
2-2. Model 362 Controller and Model 382 Controller Exploded View	2-4
2-3. Expanders Hardware Orientation	2-46
2-4. HP A2246A 4-Slot DIO-I Bus Expander Exploded View	2-48
2-5. HP A2247A 2-Slot DIO-II Bus Expander Exploded View	2-50
3-1. Model 362/382 Controller Functional Assemblies	3-1
3-2. Model 362/382 Functional Block Diagram	3-2
3-3. Power Supply	3-3
3-4. System Board	3-5
3-5. LAN Board Jumper Positions	3-12
3-6. RAM Board	3-17
3-7. Controller DIO-I Backplane Board	3-19
3-8. Hard Disk Drives	3-20
3-9. CD ROM Disk Drive	3-25
4-1. Typical Power-Up Display	4-2
4-2. Power-Up Display	4-5
5-1. HP 46021B ITF Keyboard	5-2
5-2. HP 98203C Keyboard	5-2
5-3. Hard Disk Drive Configuration Jumper Locations	5-12
5-4. 52 Megabyte Hard Disk Drive Configuration Jumper Locations	5-13
5-5. Flexible Disk Drive Configuration Jumper Locations	5-15
5-6. CD ROM Configuration Jumper Locations	5-16
5-7. System Board Graphics Jumpers	5-19
5-8. LAN Board Jumper Positions	5-20
6-1. Troubleshooting: Main Flowchart	6-3
6-2. Troubleshooting: Problems While Booting	6-4
6-3. Troubleshooting: Problems While Booting (continued)	6-5
7-1. Model 362 and 382 Controller Exploded View	7-3
7-2. HP A2246A DIO-I Bus Expander Exploded View	7-7
7-3. HP A2247A DIO-II Bus Expander Exploded View	7-9

Tables

1-1. Model 362 and 382 Controller Features	1-2
1-2. Supported Keyboards for Model 362 and 382 Controllers	1-4
1-3. Supported DIO-II Accessory Cards	1-5
1-4.	1-6
1-5. Model HP-UX Operating Systems and Languages	1-7
1-6. Model 382 Controller HP-UX System Bundles	1-8
1-7. Model 362 and 382 Controller BASIC System Bundles	1-8
1-8. Model 382 Controller HP VEE-TEST System Bundle	1-8
2-1. Model 362 Controller and Model 382 Controller Parts References	2-5
2-2. Model 382; Total RAM vs. Slot Numbers and Board Sizes	2-11
2-3. HP A2246A 4-Slot DIO-I Bus Expander Parts References	2-47
2-4. HP A2247A 2-Slot DIO-II Bus Expander Parts References	2-49
3-1. CPU Functional Features	3-5
3-2. Low-resolution Graphics Circuit Technical Information	3-7
3-3. Model 362 Controller RAM Addresses	3-8
3-4. Model 382 Controller RAM Addresses	3-9
3-5. Recommended SCSI Bus Addresses and Device Usage	3-10
3-6. SCSI Interface Default Configurations	3-11
3-7. SCSI Interface Technical Information	3-11
3-8. LAN Default Configurations	3-12
3-9. LAN Interface Technical Information	3-13
3-10. HP Parallel Interface Default Configurations	3-13
3-11. HP Parallel Interface Technical Information	3-13
3-12. Audio Output Technical Information	3-15
3-13. RS-232 Interface Technical Information	3-16
3-14. Total RAM vs. Slot Numbers and Board Sizes	3-17
3-15. Total RAM vs. Slot Numbers and Board Sizes	3-18
3-16. Models 362/382 Hard Disk Drive Summary	3-20
3-17. 52 MByte Disk Drive	3-21
3-18. Hard Disk Drive Formatted Capacity	3-23
4-1. LAN Boot Errors	4-4
4-2. Boot ROM Displayed Status Messages	4-7
5-1. Built-In Interface Default Configurations	5-5
5-2. Configuration Mode Entry Error Messages	5-10
5-3. Configuration Mode Exit Error Messages	5-10
5-4. Hard Disk Drive Configuration Jumper Functions	5-13
5-5. Hard Disk Drive Configuration Jumper Functions	5-14
5-6. Flexible Disk Drive Configuration Bottom Jumper Functions	5-15
5-7. CD ROM Drive Configuration Jumper Functions	5-17
5-8. CD ROM SCSI ID Addresses and Switch Settings	5-17
5-9.	5-18
5-10.	5-19
6-1. UNEXPECTED USE OF (address) Failure Messages	6-7

6-2. General Failure LED Indications	6-8
6-3. Self-Test LED Special State and Failure Codes	6-9
6-4. Self-Test LED State and Failure Codes for Interfaces	6-10
6-5. Boot ROM Displayed Error Messages	6-10
6-6. Model 362 Controller RAM Addresses vs. Boards	6-13
6-7. Model 382 Controller RAM Addresses	6-14
6-8. SCSI Exerciser Functions	6-17
6-9. SCSI Exerciser CE Mode Functions	6-18
6-10. Voltage Test Points and Tolerances Red Wire to Pin 1	6-19
7-1. Model 362 and 382 Controller Electrical Parts List	7-2
7-2. Model 362 and 382 Controller Mechanical Parts List	7-4
7-3. HP A2246A DIO-I Bus Expander Parts List	7-6
7-4. HP A2247A DIO-II Bus Expander Parts List	7-8
8-1. Related Service Documentation	8-1
8-2. System Installation and Getting Started Documentation	8-2
8-3. Upgrade Documentation	8-2

Product Information

Product Descriptions

The HP 9000 Series 300 Model 362 and 382 controller systems are designed for the Measurement Automation markets using HP-UX or BASIC operating systems. They are object code compatible with most earlier Series 300 and Series 400 computers. Many capabilities of personal computers have been implemented. Key features include a low-cost 20 MIPS performance and a versatile I/O set including serial, and parallel interface ports. Optional internal mass storage devices include hard, flexible and CD ROM disk drives. Model 382 controllers have either frame-buffer graphics with 1024 by 768 high-resolution graphics or 640 by 480 VGA compatible graphics. Model 362 controllers have VGA compatible graphics with 640 by 480 resolution.

Two expanders permit adding accessory cards to increase system applications. An HP A2246A 4-slot DIO-I Bus Expander attaches to the top of either controller. An other expander, the HP A2247A 2-slot DIO-II expander may be used in the same way.

The controllers are similar to the HP A1314A, HP A1319A and HP A1324A R-Series Integrated Controllers. Similar architecture and assemblies are used.

Figure 1-1 shows a typical controller and expander in a system.

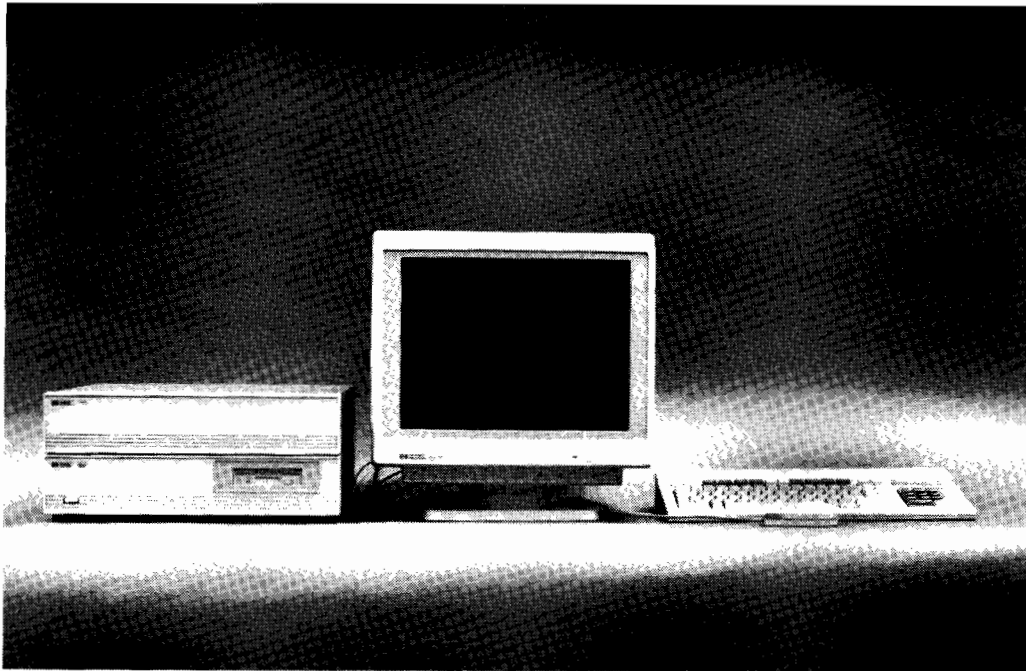

Figure 1-1. Model 362 or Model 382 Controller System

Controller Features

Table 1-1 lists the features of the Model 362 and 382 Controllers.

Table 1-1. Model 362 and 382 Controller Features

Feature	Model 362 Controller	Model 382 Controller
CPU	MC68030 CPU @ 25 MHz	MC68040 CPU @ 25 MHz
Floating-point co-CPU	HP A2249A Co-CPU Upgrade	Part of MC68040
RAM	2 slots 2 to 16 Mbytes	4 slots; 8 to 32 Mbytes
Graphics	640 by 480 VGA color	1024 by 768 Hi-Res Color, or 640 by 480 VGA color
Standard interfaces	One RS-232 serial I/O port. One 25-pin HP Parallel port. One HP-IB IEEE 488 I/O port. One HP-HIL I/O port. Internal SCSI for internal drives. Speaker output.	One RS-232 serial I/O port. One HP Parallel port. One HP-IB IEEE 488 I/O port. One HP-HIL I/O port. Internal SCSI for internal drives. Speaker output.
Optional interfaces	HP A2256A SCSI Upgrade. HP A2255A LAN Board Upgrade.	
Accessory card slots	One DIO-I card slot	One DIO-I card slot
Optional mass storage devices	HP A2252A 3.5-in flexible disk drive. HP A2253A CD-ROM drive. HP A2257A 52 Mbyte hard drive, BASIC only. HP A2258A 220 Mbyte hard drive. HP A2259A 420 Mbyte hard drive.	HP A2252A 3.5-in flexible drive. HP A2253A CD-ROM drive. HP A2257A 52 Mbyte hard drive, BASIC only. HP A2258A 220 Mbyte hard drive. HP A2259A 420 Mbyte hard drive.
Operating systems	BASIC.	HP-UX. BASIC BASIC-UX

Memory

User-installable RAM boards are used as follows:

- Model 362 controllers have two RAM slots and use one or two of the RAM boards that are also used in HP Vectra Personal Computers:
 - HP D2381A 2 Mbyte RAM board.
 - HP D2156A 4 Mbyte RAM board.
 - HP D22152 8 Mbyte RAM board.
- Model 382 controllers have four RAM slots and use these Error Checking and Correcting (ECC) RAM boards in pairs:
 - HP A2200A 4 Mbyte RAM board upgrade, two HP 98236A 2 Mbyte RAM boards.
 - HP A2201A 8 Mbyte RAM board upgrade, two HP 98236B 4 Mbyte RAM boards.
 - HP A2202A 16 Mbyte RAM board upgrade, two HP 98236C 8 Mbyte RAM boards.

System Graphics

Each controller's system board has built-in graphics circuits:

- Model 362 controller; 640 by 480 VGA compatible color graphics.
- Model 382 controller has one of two system boards with these graphics:
 - 1024 by 768 high-resolution color graphics.
 - 640 by 480 VGA compatible color graphics.

Bundled systems may include one of these monitors:

- HP D1182A 14-inch Color Monitor with Model 362 or 382 controller BASIC systems.
- HP A1497A 16-inch Color Monitor with Model 382 HP-UX controller systems.

Built-In Interfaces

Built-in interfaces have connectors on the rear panel as shown in Figure 1-2.

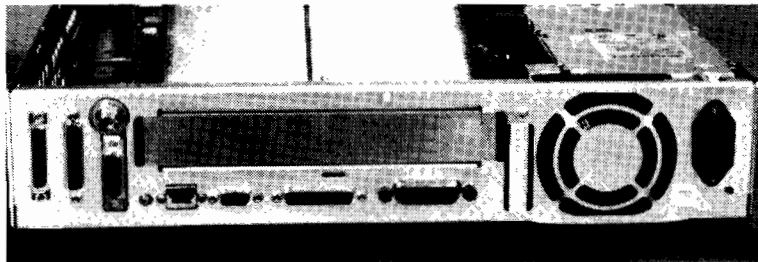

Figure 1-2. Controller Rear Panel

Small Computer Systems Interface (SCSI)

Internally, a ribbon cable connects the CPU to optional internal mass storage devices. The optional HP A2256A External SCSI Interface adds a high-density, shielded external connector and replaces the standard internal SCSI ribbon cable.

RS-232 Serial Interface

One 9-pin RS-232 serial interface ports are provided. The RS-232 interface can be configured under Boot ROM control. Interface values such as remote/local may be changed by users. Terminals are supported on the RS-232 interface connector.

HP Parallel Interface

A 25-pin HP Parallel interface port is provided for use with devices using the Centronics™ interface protocols. Some configuration parameters are available under Boot ROM control in Configuration Mode for internal interfaces.

Hewlett-Packard Human Interface Loop (HP-HIL)

The HP-HIL connector on the rear panel accepts a variety of HP-HIL input devices. Keyboards are normally connected here. Three keyboards are available and supported with the operating systems listed in Table 1-2.

Table 1-2. Supported Keyboards for Model 362 and 382 Controllers

Operating System	Model 362 Controller	Model 382 Controller
HP-UX		HP 46021B ITF Keyboard HP C1429A PC-101 Keyboard
BASIC	HP 46021B ITF Keyboard HP 98203C Keyboard	HP 46021B ITF Keyboard HP 98203C Keyboard

Other HP-HIL devices may also be connected to the keyboard or HP-HIL connector.

Local Area Network Interface

An optional factory or user installed HP A2255A IEEE 802.3 Ethernet Local Area Network (LAN) board has two interface ports:

- ThinLAN uses the BNC connector. An internal attachment unit interface is used.
- AUI LAN uses the 15-pin connector. An external attachment unit interface is required for use on the network.

Either port is activated by the LAN board's LAN jumper position. Some LAN interface values can be configured by keyboard entry under Boot ROM control in Configuration Mode for internal interfaces.

The user-installed option is the HP A2255A LAN Interface Upgrade.

Audio Interface

A voice-quality audio output is used. An output connector for external speaker or headphones is on the rear panel. When used, the internal speaker is disabled when external device is connected. Its programmable audio output can be voice or tones. *Audio CD ROMs cannot output to the audio out connector.*

An internal speaker is also used to output voice and tones.

HP-IB Interface

Hewlett-Packard Interface Bus (HP-IB) is Hewlett-Packard's version of the IEEE 488 interface standard and is much like HP-IB implementations on other HP 9000 Series 200/300/400 computers.

Internal Mass Storage Devices

Model 362 and 382 controllers may use up to two internal mass storage devices connected to the internal SCSI interface. The controller is available in diskless as well as diskfull configurations. Diskfull configurations have their hard disk drive bay fitted with either a 210 or 420 Mbyte hard disk drive. Hard disk drives are pre-formatted. As an option, either the HP-UX or BASIC operating system may be preloaded. A second disk drive bay can have one of several optional removable-media mass storage devices installed.

Factory-installed and customer-installable mass storage devices include:

- HP A2252A 3.5-in flexible disk drive.
- HP A2253A CD-ROM disk drive.
- HP A2257A 52 Mbyte hard disk drive.
- HP A2258A 220 Mbyte hard disk drive.
- HP A2259A 420 Mbyte hard disk drive.

Most Hewlett-Packard HP-UX software will be distributed on CD ROM.

Supported Accessory Cards

DIO-I Accessory Cards

The HP A2247A 4-slot bus expander accepts DIO-II accessory cards. These cards are also used on other Series 300 computers. Refer to Table 1-3 for the supported accessory cards.

Table 1-3. Supported DIO-II Accessory Cards

DIO-II Accessory Cards in HP A2247A 2-Slot DIO-II Bus Expander	HP-UX Support?	BASIC Support?
HP 98297A Real Time Interface Card	Yes	No
HP 98638A 8-Port Multiplexer Card	Yes	No
HP 98641A RJE 2780/3780 Interface Card	Yes	No

Supported DIO-I Accessory Cards

DIO-I Accessory Cards

Model 362 and 382 controllers and the HP A2246A 4-slot bus expander accept DIO-I accessory cards. These cards are also used on other Series 300 and 200 computers. Refer to Table 1-4 for the supported accessory cards.

Table 1-4.

DIO-I Accessory Cards in Model 362 and 382 Controllers and HP A2246A 4-Slot DIO-I Bus Expander	HP-UX Support?	BASIC Support?
HP 98622A 16-Bit Parallel (GPIO) Interface Card	Yes	Yes
HP 98624A HP-IB (IEEE 488) Interface Card	Yes	Yes
HP 98625B High-Speed HP-IB (IEEE 488) Interface Card	Yes	Yes
HP 98626A RS-232-C Serial Interface Card	Yes	Yes
HP 98642A 4-Port Multiplexer Card	Yes	No
HP 98643A Local Area Network (IEEE 802.3) Interface Card	Yes	Yes
HP 98644A RS-232-C Serial Interface Card	Yes	Yes
HP 98658A Small Computer Systems Interface Card	Yes	Yes

Hardware Architecture

Controller Hardware Architecture

Most of the controller's functionality is on one assembly, the system board. Most interface controllers, CPU circuits, memory controller and graphics/video circuits are on the system board. A separate LAN board has the LAN interface circuit. RAM boards plug into sockets on the system board. Test and function indicating LEDs are on the system board. Each mass storage device has its controller circuits on a PC board that is part of the device.

The DIO-II bus goes to a connector at the top of the controller for optional bus expanders to connect to. It also connects to the DIO-I slot where several accessory cards may be installed.

Other separate assemblies include the fan, speaker and power supply assemblies.

Expander Hardware Architecture

Both the 2-slot DIO-II and 4-slot DIO-I bus expanders have their backplanes positioned to connect with either the controller or a second expander. The 2-slot expander accepts system-board size accessory cards. Its 32-bit bus provides faster data rates for these boards. A 16-bit data bus is used in the 4-slot DIO-I bus expander, although the full 32-bit bus goes through to its top connector. This allows a 2-slot DIO-II expander to be attached to it. Refer to Table 1-4 and Table 1-3 for supported accessory cards.

Operating Systems

HP-UX

HP-UX 8.0 (or later) is supported only on the Model 382 Controller. It is preloaded on an internal hard disk drive. This allows users to start using their systems immediately after hardware installation; HP-UX does not have to be installed on-site. Table 1-5 lists the HP-UX operating systems and languages for the Model 382 controller.

Table 1-5. Model HP-UX Operating Systems and Languages

Operating system:	HP-UX 8.0 or later. HP-UX complies with the UNIX System V Interface Definition X/Open and POSIX Specifications and will be fully compliant with Operating Systems Foundation (OSF).
Window system:	X Window System Version 11 (X11) Release 4.
Languages:	C, Pascal, FORTRAN, Ada, Common LISP, C + +.

System Bundles

At introduction, controllers are shipped in several system bundles. These bundle configurations may change and some may be deleted or added. Table 1-6, Table 1-7 and Table 1-8 lists the introduction system bundles. Some bundles may include expanders, LAN and/or external SCSI interfaces.

Note HP A1097A/B 16-inch Color Monitors are not available as stand-alone products. Each is shipped with its system bundle. Corporate Price Lists do not include these monitors.

Up to 24 Mbytes of RAM can be factory installed; users must install any additional RAM themselves. Users may contact Hewlett-Packard and have the additional RAM installed.

Table 1-6. Model 382 Controller HP-UX System Bundles

Bundle Product Number	HP-UX Installed?	RAM	Graphics	Monitor	Mass Storage
HP A1474A	Opt.	4 MB	VGA	None	Optional
HP A2250A	Opt.	4 MB	VGA	HP D1182A 14-in VGA	Optional

Table 1-7. Model 362 and 382 Controller BASIC System Bundles

Bundle Product Number	RMB-UX Installed?	RAM	Graphics	Monitor	Mass Storage
HP A2241A	No	4 MB	VGA	None	Flex Drive
HP A2242A	Yes	8 MB	VGA	HP D1182A 14-in. VGA	Optional
HP A2245A	No	8 MB	Hi-Res	HP A1497A 16-in.	420 MB

Table 1-8. Model 382 Controller HP VEE-TEST System Bundle

Bundle Product Number	HP V-TEST Installed?	RAM	Graphics	Monitor	Mass Storage
HP A2243A	Opt.	16 MB	Hi-Res	HP A1497A 16-in.	Optional

Technical Information

Note Technical information listed herein should not be interpreted as specifications. Official specifications are listed in the HP 9000 Model 362 and 382 Controller Technical Data Sheet.

Electrical

Line voltage	100 - 120 V ac 48-66 Hz 220 - 240 V ac 48-66 Hz
Model 362 Controller maximum current	1.27 A; 100 - 120 V ac 0.78 A; 220 -240 V ac
Model 382 Controller maximum current	1.27 A; 100 - 120 V ac 0.78 A; 220 -240 V ac
HP A2246A Expander maximum current	1.0 A; 100 - 120 V ac 0.5 A; 220 - 240 V ac
HP A2247A Expander maximum current	1.0 A; 100 - 120 V ac 0.5 A; 220 - 240 V ac
Model 362 Controller Power consumption	76 watts; 100 - 120 V ac 80 watts; 220 - 240 V ac
Model 382 Controller Power consumption	76 watts; 100 - 120 V ac 80 watts; 220 - 240 V ac
HP A2246A Bus Expander Power Consumption	56 watts; 100 - 120 V ac 35 watts; 220 - 240 V ac
HP A2247A Bus Expander Power Consumption	56 watts; 100 - 120 V ac 35 watts; 220 - 240 V ac

Regulatory

VDE Level:	B
FCC Class:	A
VCCI Class:	1
Safety:	UL, CSA, IEC

Environmental

	Diskless	With Internal Drives
Operating temperature	0° - 55° C	5° - 40° C
Non-operating temperature	-40° - 70° C	-1° C - 60° C
Heat dissipation	263 BTU	263 BTU
Humidity (non-condensing); operating	15 - 95%	20 - 80%
Humidity (non-condensing); non-operating	5 - 95%	10 - 90%
Maximum altitude, operating (to 47°C):	4570 metres (15,000 ft.)	3048 metres (10,000 ft.)
Maximum altitude, non-operating:	15 240 metres (50,000 ft.)	15 240 metres (50,000 ft.)

Physical

Controllers

Height:	102 mm (4-inches) with feet attached 89 mm (3.5-inches) without feet
Width:	419 mm (16.5-inches)
Depth:	432 mm (17-inches)
Weight:	9.1 kg (20 pounds) without internal drives, excluding accessory card 10.9 kg (24 pounds) with two internal drives, excluding accessory card

Expanders

Height:	102 mm (4-inches) with feet attached 89 mm (3.5-inches) without feet
Width:	419 mm (16.5-inches)
Depth:	432 mm (17-inches)
Weight:	HP A2246A, 8.6 kg (19 pounds), excluding accessory cards HP A2247A, 9.1 kg (20 pounds), excluding accessory cards

Product Identification

On the bottom of each product, a label lists the products serial number. Its information can be interpreted as shown below for an example serial number 6124A29001:

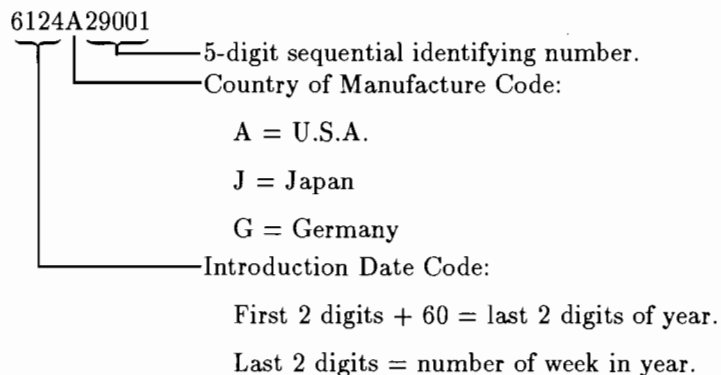

Support

Support services and policies mentioned in this section are subject to change. Please consult your local Hewlett-Packard Sales and Service Office for the current support policies.

Hardware Support

Field Repair Philosophy

Field Repair Philosophy for the Model 362 and 382 controllers, HP A2246A and HP 2247A Expanders is assembly, or board level. This means that when a failure occurs, the problem is diagnosed to the assembly having the failed part. That assembly is then replaced. Component parts required for certain configurations are available. Other component parts are not available.

Some assemblies may be exchanged for rebuilt ones. Other assemblies are only available as new ones. Refer to Chapter 7, or the *Model 362/682 Controller and HP 2246/7A Bus Expander Service Handbook*, Chapter 8, for information on replacement parts.

Schematics

In support of the repair philosophy, this manual contains information to the assembly level. Schematics are not available for these products.

Supported Configurations

Only controller products with Hewlett-Packard approved parts, accessories, peripherals, operating systems and application programs are supported by Hewlett-Packard. Any controller product with other than HP approved hardware or software connected or installed must have the non-HP approved hardware and software removed by the customer before On-Site repair is accomplished.

Repair Services

Hewlett-Packard provides repair services in two ways:

- On-Site Repair.
- Customer Repair.

For On-Site Repair, an HP Customer Engineer goes to the customers site, troubleshoots, and repairs the hardware to the assembly level. The defective assembly is replaced with a new or rebuilt assembly. This service is available through a service contract or a time-and-materials basis.

Customers have the option of repairing their own HP controller products. Contact your nearest Hewlett-Packard Sales and Service Office for information concerning service training, special tools and test equipment, and spare parts.

Hardware Support Services

There are many hardware support options available, from utilizing on-site maintenance groups to buying full support from the local sales office. Please contact your local Hewlett-Packard Sales and Service Office for these services.

Assembly Replacement

Introduction

In this chapter, you'll learn how to replace assemblies in the controllers and expanders. There are two sections in this chapter:

- 'Model 362 and 382 Controllers' covers both controllers.
- 'HP A2246A 4-Slot DIO-I and HP A2247A 2-Slot DIO-II Bus Expander' covers both expanders.

Tools Required

Caution In these products, special M4 screws requiring 6 mm hex-head or #1 PhillipsTM screwdrivers are used. Do not use other screwdrivers as they will damage the screw head recess.

All field replaceable parts can be accessed with these tools:

- 5 mm nutdriver, 100 mm (4-inch) blade.
- 8 mm (5/16-in.) nutdriver, 100 mm (4-inch) blade.
- 7 mm (9/32-in) nutdriver, 100 mm (4-inch) blade.
- #1 Phillips screwdriver, 100 mm (4-inch) blade.
- Light-duty flat-tipped screwdriver, 150 mm (6-in.) blade.
- Needlenose pliers.

Safety Precautions

Electrical Precautions

As with any electrical/electronic product, certain safety precautions must be practiced. These safety precautions, when followed protect both you and the equipment from injury and possible permanent damage.

Caution Integrated circuit components in these products can be damaged by electro-static discharge. It doesn't make any difference whether the ICs are installed on a printed circuit board or laying on a table. Static charges can build up in people to a potential of several thousand volts by simply walking across a room.

These circuits in the controller, bus expander, accessories and peripherals can be protected by using a static free workstation and wearing clothes that do not hold static charges before handling any of the unit's PC boards.

When you need to remove or install a part, remove power from the product first. With the static free workstation in place, touch sheet metal with your fingers before touching the printed circuit assembly. If the assembly is not going to be re-installed, place the assembly in an anti-static bag and set it aside.

Following these precautions will extend the life of the controller products you maintain.

Mechanical Precautions

Caution Hard disk drives are vulnerable to physical shock. *Dropping a hard disk drive from even a small height will damage its heads and platters.*

Always handle hard disk drives with extreme caution.

Do not set a hard disk drive upside down on any surface.

Model 362 and 382 Controllers

Overview and Parts References

For each controller assembly, Preliminary requirements are listed and must be done before the Removal instructions are followed.

Instructions are based on the:

- Hardware orientation shown in Figure 2-1.
- Exploded view shown in Figure 2-2.
- Parts listed in Table 2-1.

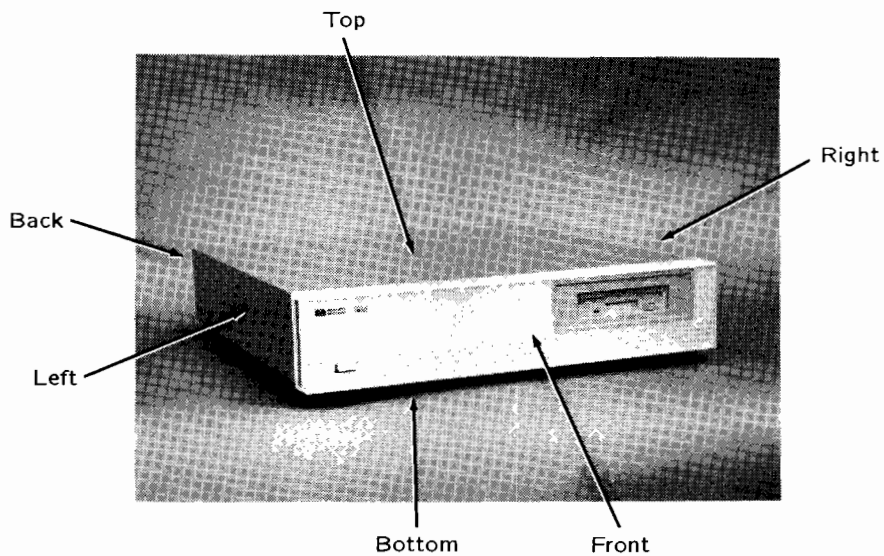

Figure 2-1. Controller Hardware Orientation

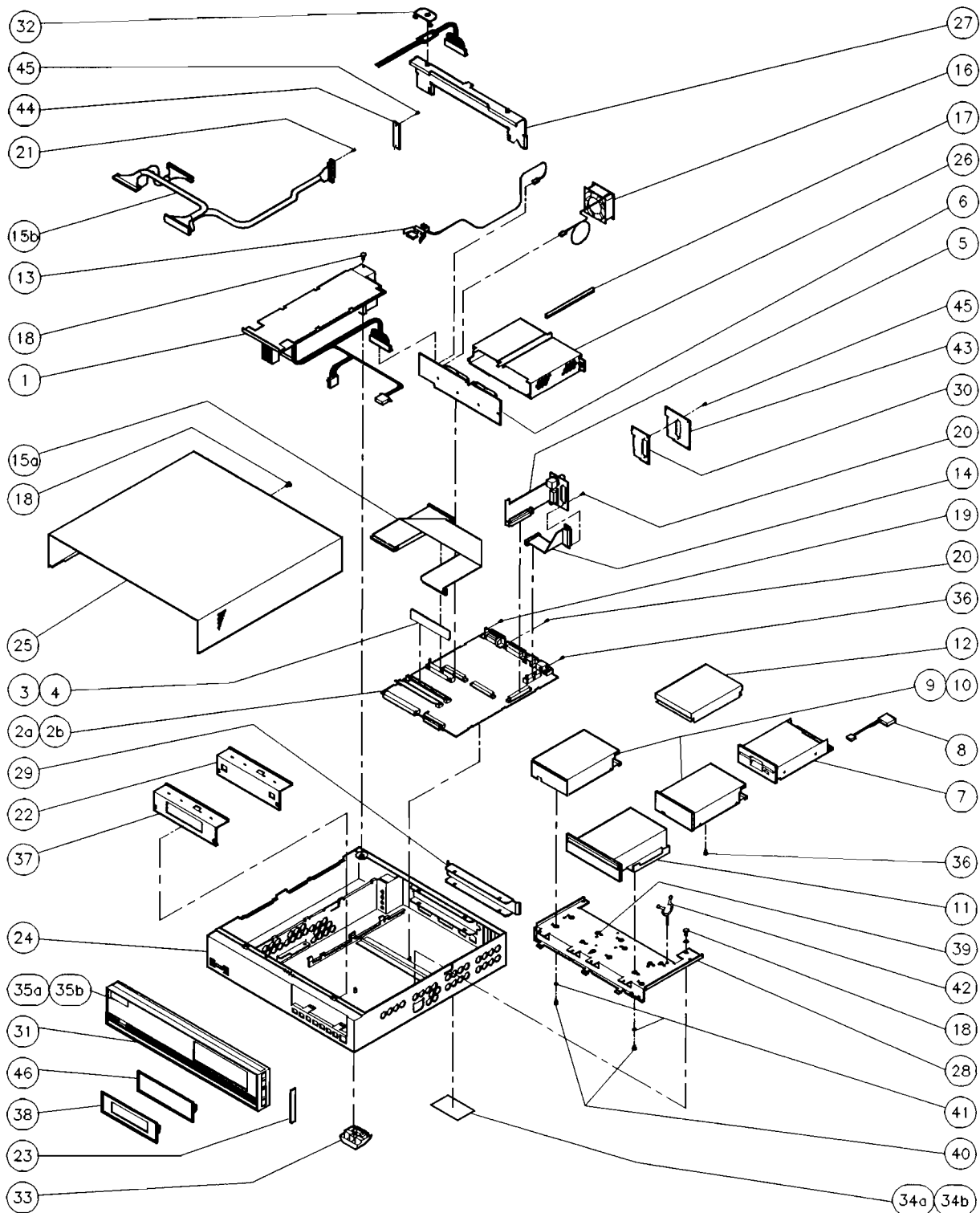

Figure 2-2. Model 362 Controller and Model 382 Controller Exploded View

Table 2-1. Model 362 Controller and Model 382 Controller Parts References

Ref. No.	Part Name	Ref. No.	Part Name
1	Power supply	26	DIO-I card cage
2	System Board	27	DIO-I card cage support
3	Model 382 Controller RAM	28	Mass storage tray
4	Model 326 Controller RAM	29	DIO-I slot cover plate
5	LAN board	30	LAN RFI cover plate
6	DIO-I backplane board	31	Front panel (bezel)
7	3.5-in. flexible disk drive	32	Wire hold-down
8	Flex disk drive power cable	33	Foot
9	210 Mbyte hard disk drive	34a	UL/CSA label; Model 362
10	420 Mbyte hard disk drive	34b	UL/CSA label; Model 382
11	CD ROM disk drive	34c	Regulatory label
12	52 Mbyte hard disk drive	34d	Battery warning label
13	Power switch assembly	35a	Nameplate, Model 362
14	HP Parallel ribbon cable	35b	Nameplate, Model 382
15a	SCSI cable, internal drives only	36	Screw; M3X.0.5
15b	SCSI cable, internal/external drives and rear panel	37	Flexible drive RFI cover plate
16	Fan	38	Drive RFI cover plate
17	Card guide snap mount	39	Hard disk isolation grommet
18	Screw; M4X6 pan head	40	Shoulder screw
19	Jackscrew; HP-IB connector	41	Washer
20	Jackscrew; interface connector	42	Cable clamp
21	SCSI jack screw	43	SCSI/LAN RFI cover plate
22	Mass storage RFI cover plate	44	SCSI RFI cover plate
23	Side trim	45	Screw, LAN/SCSI RFI cover plate
24	Chassis	46	Blank trim plate
25	Top cover		

DIO-I Accessory Cards

Preliminary Requirements

Before you remove an accessory card:

1. Shut down the operating system.
2. Turn OFF the controller.
3. Remove any cables connected to the accessory card.

Removal and Installation

Installing accessory cards is the reverse of removing them.

Follow this step to remove and install accessory cards:

Remove the two thumb screws holding the card's back plate to the rear panel, then pull the card out.

Note the positions of configuration switches or jumpers; set the replacement accessory card's jumpers or switches to the same positions.

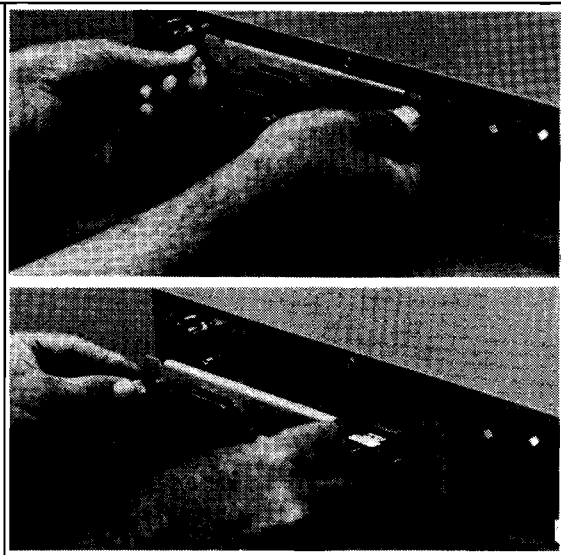

Top Cover

Preliminary Requirements

Before you remove the controller's top cover:

1. Shut down the operating system.
2. Turn OFF the controller.
3. Remove all cables and cords attached to the controller.
4. If rack mounted, remove the units from the rack.
5. If an expander is attached, remove the expander(s). Refer to the section in this chapter titled 'HP A2246A and HP A2247A Expanders' for instructions.

Removal

Follow these steps to remove the top cover:

- 1** Remove the screw holding the top cover to the rear panel.

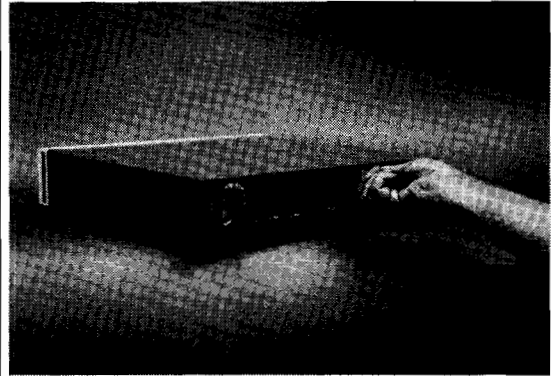

2 Pull the top cover straight back and off the controller.

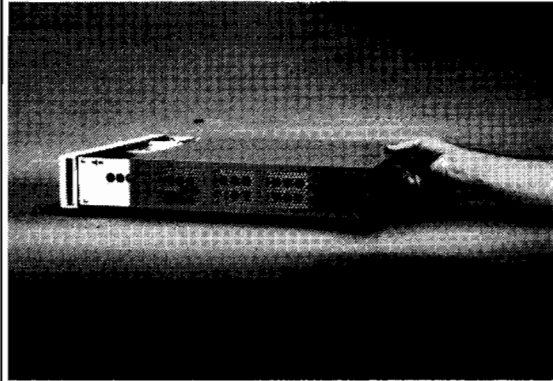

Installation

Installing the top cover is the reverse of removing it.

When replacing the top cover, make sure the tabs on each bottom side at the back fit into their chassis slots

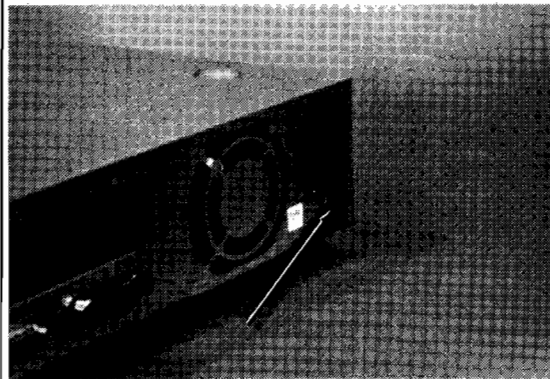

RAM Boards

Preliminary Requirements

Before you remove the controller's RAM boards:

1. Shut down the operating system.
2. Turn OFF the controller.
3. Remove all cables and cords attached to the controller.
4. If rack mounted, remove the units from the rack.
5. If an expander is attached, remove the expander(s). Refer to the section in this chapter titled 'HP A2246A and HP A2247A Expanders' for instructions.
6. Remove the top cover.

Removal

Note RAM boards must be installed in their correct slot to be properly addressed. Refer to the RAM configuration tables for instructions.

Follow these steps to remove the RAM boards:

- 1** If disk drives are installed, disconnect their ribbon and power cables and move the cables out of the way.

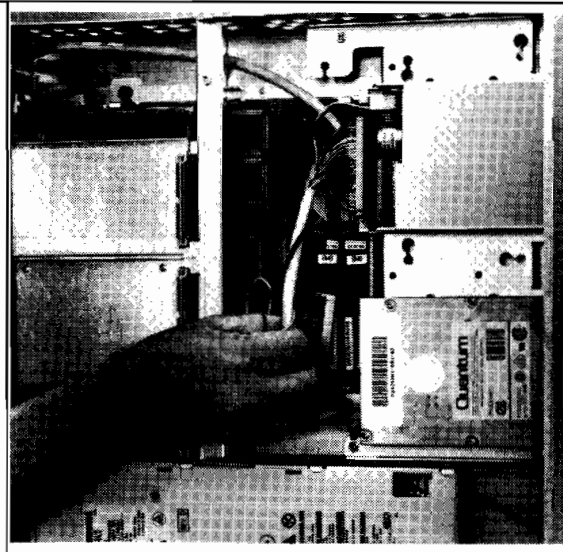

2 Release the RAM board clips by pushing them out until they snap:

- On Model 382s, do the front one first.
- On Model 362s, do the back one first.

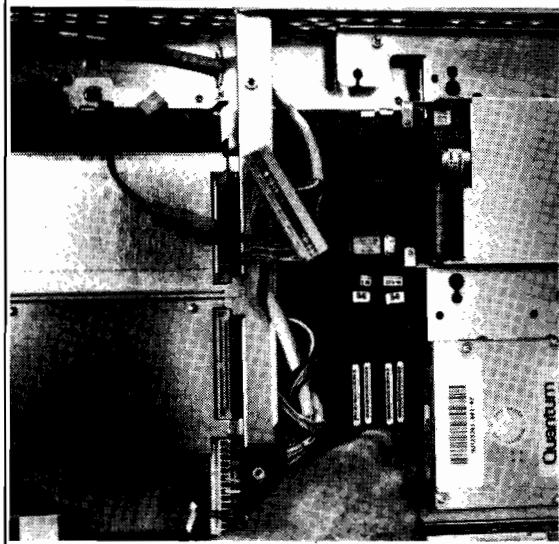

3 Tilt the RAM board to a vertical position, then lift it up and out of its socket.

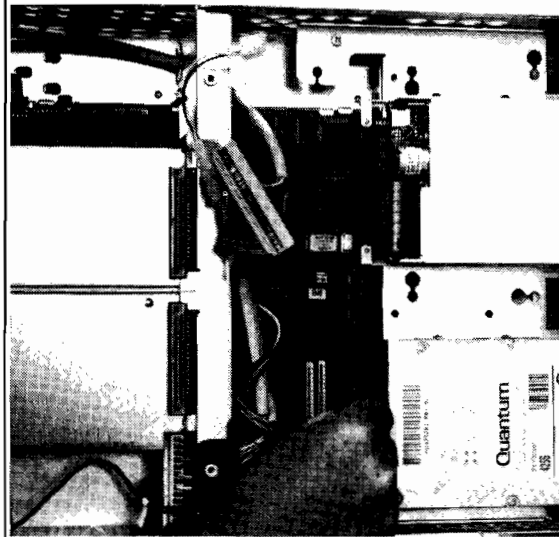

4 Remove the other RAM boards the same way.

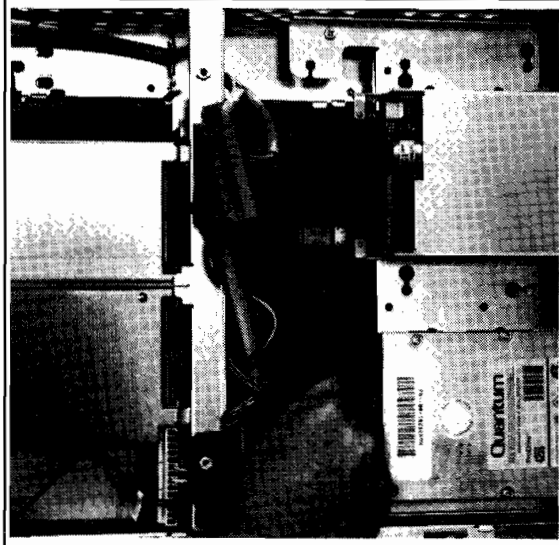

RAM Board Installation Requirements

Model 362 Controller. RAM boards may go in any slot. No requirement exists for a larger board to go in a specific slot.

Model 382 Controller. Model 382 Controller's RAM boards must meet these installation requirements:

- Boards must be installed in pairs; each board must be the same size.
- Slot pair labeled 'RAM Pair 0' must have the largest size RAM board pair.
- Slots pair labeled 'RAM Pair 1' boards must be equal to, or smaller than boards in slot pair labeled 'RAM Pair 0.'

Table 2-2 lists all supported RAM board configurations. Your controller uses one of these configurations.

Table 2-2. Model 382; Total RAM vs. Slot Numbers and Board Sizes

Total Memory	RAM Pair 0	RAM Pair 1
4 MBytes	(2 MB) (2 MB)	
8 MBytes	(4 MB) (4 MB)	
8 MBytes	(2 MB) (2 MB)	(2 MB) (2 MB)
12 MBytes	(4 MB) (4 MB)	(2 MB) (2 MB)
12 MBytes	(2 MB) (2 MB)	(2 MB) (2 MB)
16 MBytes	(4 MB) (4 MB)	(4 MB) (4 MB)
16 MBytes	(8 MB) (8 MB)	
20 MBytes	(8 MB) (8 MB)	(2 MB) (2 MB)
24 MBytes	(8 MB) (8 MB)	(4 MB) (4 MB)
32 MBytes	(8 MB) (8 MB)	(8 MB) (8 MB)

Installation

Follow these steps to install the RAM boards:

- 1** Position the board vertically in the connector, oriented correctly.

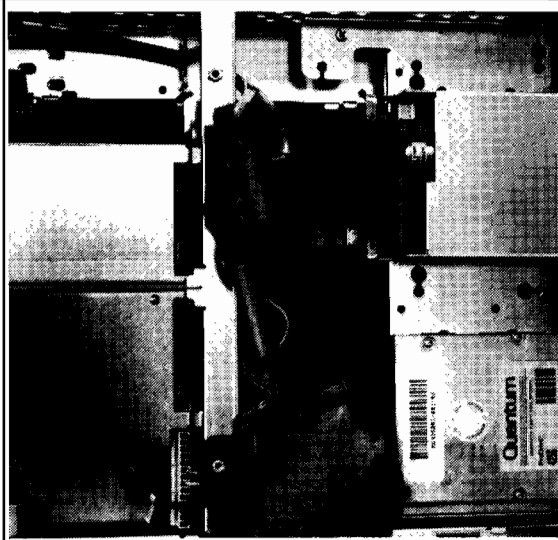

- 2** Tilt the RAM board down and snap it in place in its socket.

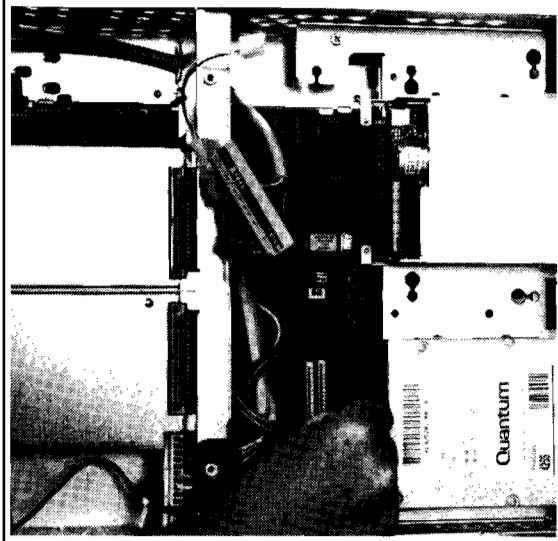

DIO-I Card Cage and Backplane

Preliminary Requirements

Before you remove the controller's DIO-I card cage and backplane:

1. Shut down the operating system.
2. Turn OFF the controller.
3. Remove all cables and cords attached to the controller.
4. If rack mounted, remove the units from the rack.
5. If an expander is attached, remove the expander(s). Refer to the section in this chapter titled 'HP A2246A and HP A2247A Expanders' for instructions.
6. Remove the top cover.

Removal and Installation

Installing the card cage and backplane is the reverse of removing it.

Follow these steps to remove the card cage and backplane:

1 Remove the wire clip guard, then disconnect these power connections from the backplane board and mass storage devices:

- Power distribution cable.
- Fan wire connector.
- Power switch wire connector.

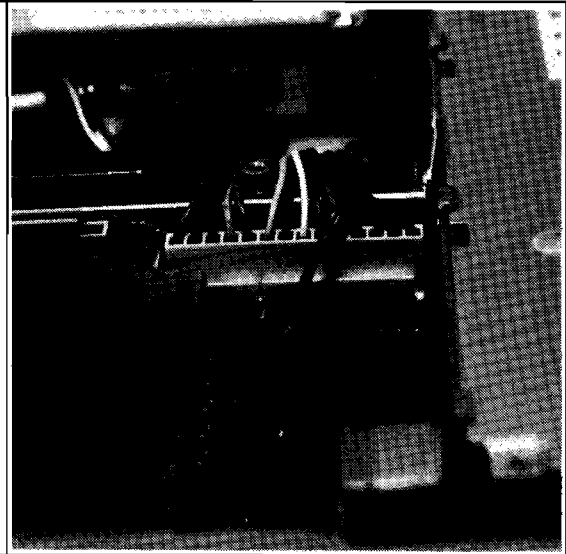

- 2** Release the DIO-I support by unsnapping two hooks at each side of the chassis.

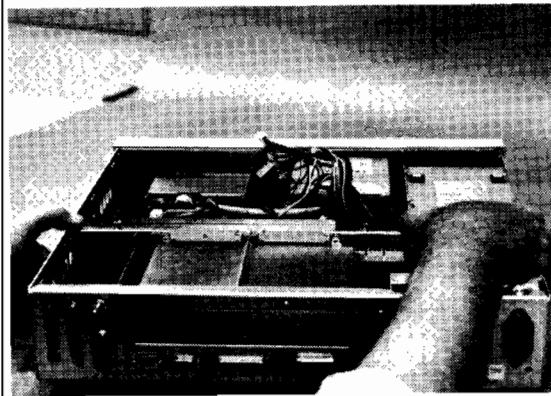

- 3** Tilt the support forward about 45° and sliding rearward to unlatch the two hooks at the bottom of the chassis to lift it out.

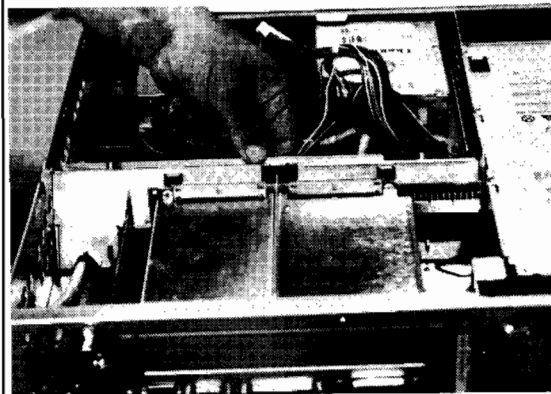

- 4** Remove the DIO-I backplane and card cage from the system board by pulling it upwards.

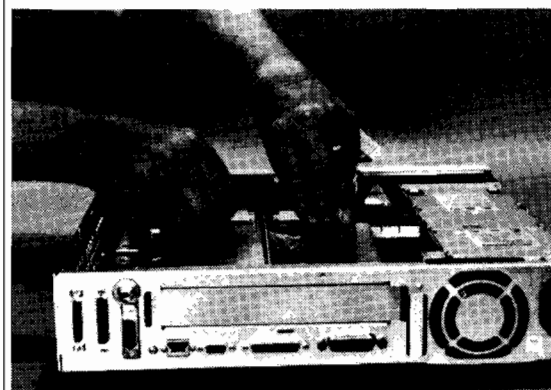

DIO-I Backplane Board

Preliminary Requirements

Before you remove the controller's DIO backplane board:

1. Shut down the operating system.
2. Turn OFF the controller.
3. Remove all cables and cords attached to the controller.
4. If rack mounted, remove the units from the rack.
5. If an expander is attached, remove the expander(s). Refer to the section in this chapter titled 'HP A2246A and HP A2247A Expanders' for instructions.
6. Remove the:
 - a. Top cover.
 - b. DIO card cage with backplane board attached.

Removal and Installation

Installing the DIO backplane board is the reverse of removing it.

Follow these steps to remove the DIO backplane board:

- 1** Hold the card cage as shown, then push the backplane board towards the single tab while lifting it up. The two small tabs will release.

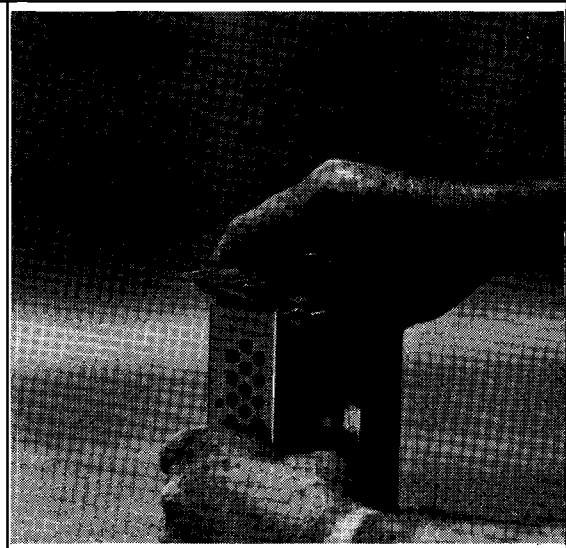

2 While holding the back of the board up with one hand, use any tool to push the third tab off of the board.

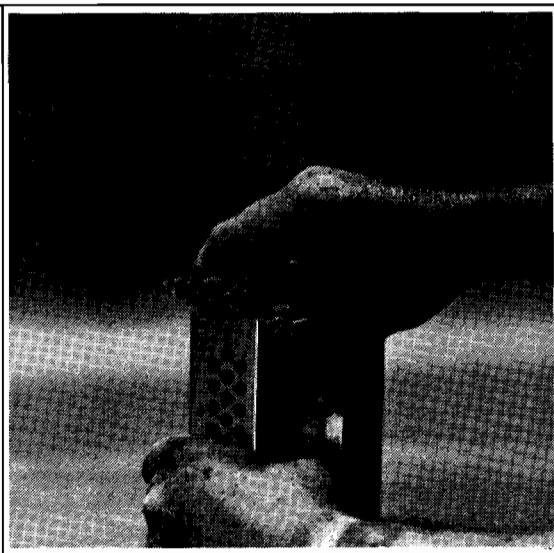

Hard Disk Drives

Preliminary Requirements

Before you remove one of the controller's hard disk drives:

1. Verify the heads are parked.
2. Shut down the operating system.
3. Turn OFF the controller.
4. Remove all cables and cords attached to the controller.
5. If rack mounted, remove the units from the rack.
6. If an expander is attached, remove the expander(s). Refer to the section in this chapter titled 'HP A2246A and HP A2247A Expanders' for instructions.
7. Remove the top cover.

Removal and Installation

Installing hard disk drives is the reverse of removing them.

Left-Side Hard Disk Drives. Follow these steps to remove a hard disk drive:

- 1** Unplug the power and SCSI cables from all drives.

Note the SCSI cable connectors as they are connected to the drives.

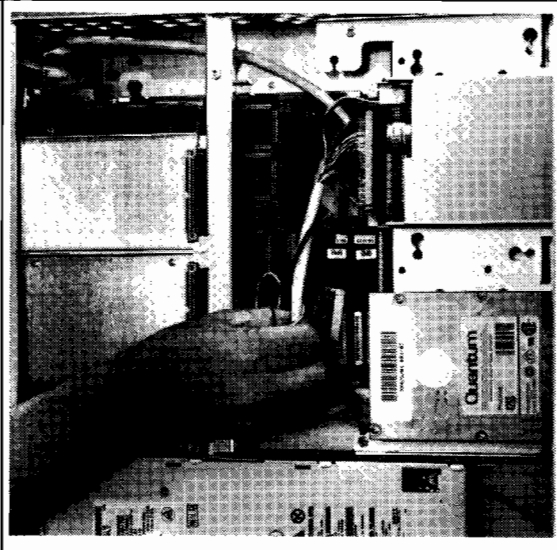

- 2** Remove the two screws at the rear of the drive tray, one on each rear corner.

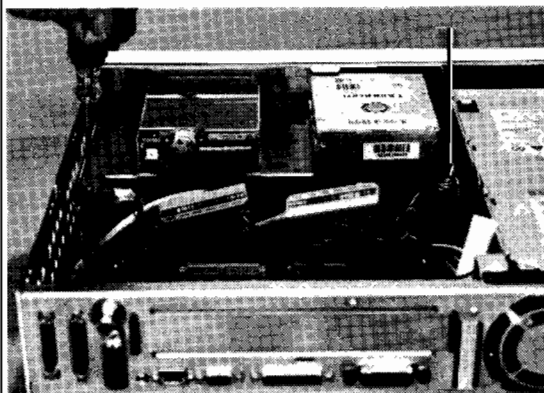

- 3** Slide the drive tray to the rear about 12 mm (0.5-in.) until the three tabs are free from the chassis and lift the drive assembly out of the unit.

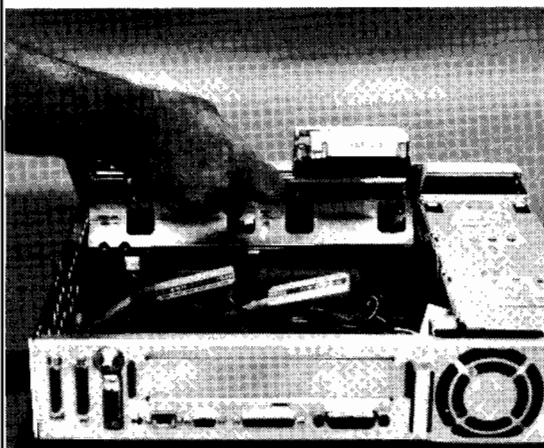

Caution

Although mass storage devices are well-protected from physical shock when installed in the controller, it is very easily damaged when removed. Avoid dropping or striking the device. Handle it gently at all times.

- 4** Remove the four screws from the bottom of the tray holding the drive and remove the drive from the tray.

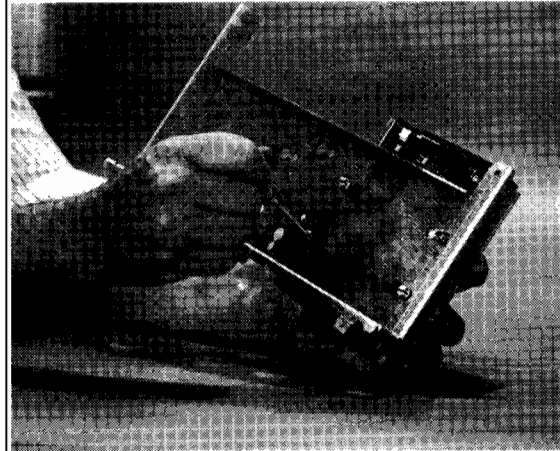

- 5** Note the configuration jumper/switch positions. The replacement drive must be configured the same.

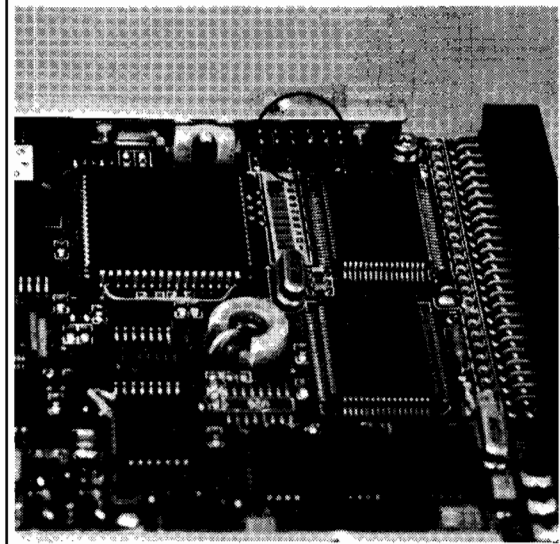

Flexible Disk Drive

Preliminary Requirements

Before you remove the controller's flexible disk drives:

1. Shut down the operating system.
2. Turn OFF the controller.
3. Remove all cables and cords attached to the controller.
4. If rack mounted, remove the units from the rack.
5. If an expander is attached, remove the expander(s). Refer to the section in this chapter titled 'HP A2246A and HP A2247A Expanders' for instructions.
6. Remove the top cover.

Removal and Installation

Installing flexible disk drives is the reverse of removing them.

Follow these steps to remove the flexible disk drive:

- 1** Unplug the power and SCSI cables from all drives.

Note the SCSI cable connectors as they are connected to the drives.

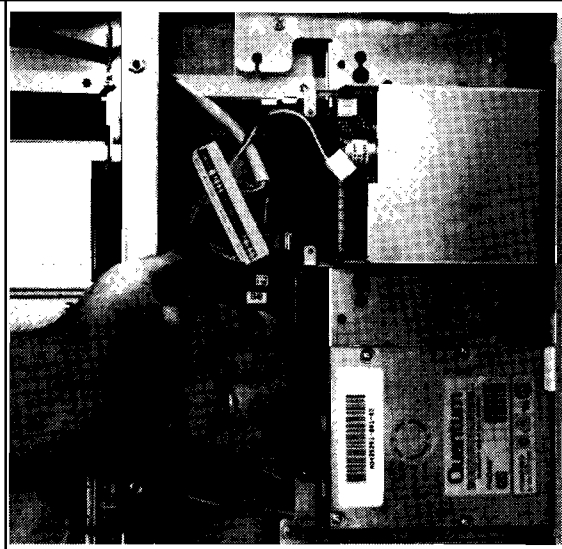

- 2** Remove the two screws at the rear of the drive tray, one on each corner.

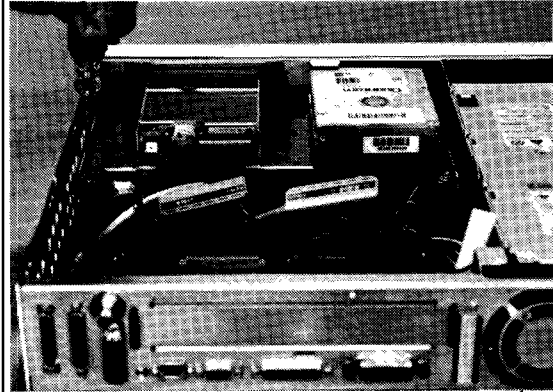

- 3** Slide the drive tray to the rear about 12 mm (0.5-in.) until the three tabs are free from the chassis and lift the drive assembly out of the unit.

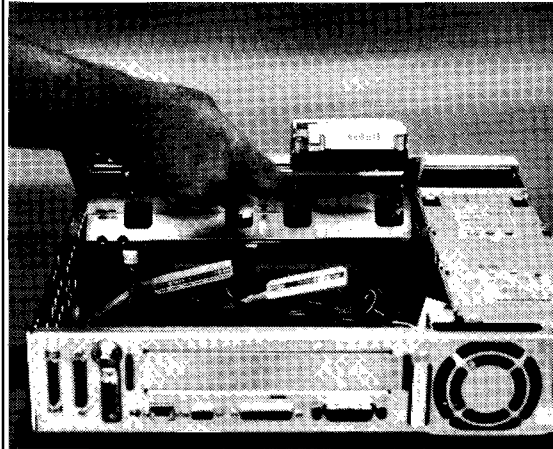

Caution

Although mass storage devices are well-protected from physical shock when installed in the controller, it is very easily damaged when removed. Avoid dropping or striking the device. Handle it gently at all times.

- 4** Remove the four screws from the bottom of the tray holding the drive and remove the drive from the tray.

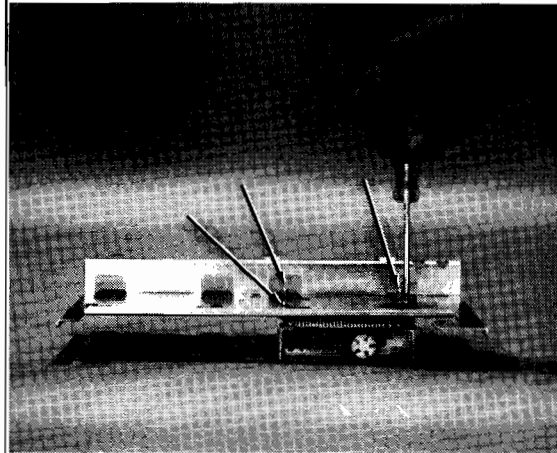

- 5** Note the configuration jumper/switch positions. The replacement drive must be configured the same.

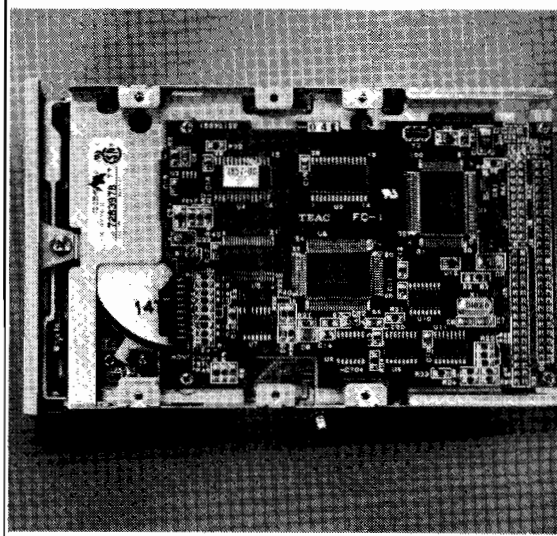

CD ROM Disk Drives

Preliminary Requirements

Before you remove the controller's CD ROM disk drives:

1. Shut down the operating system.
2. Turn OFF the controller.
3. Remove all cables and cords attached to the controller.
4. If rack mounted, remove the units from the rack.
5. If an expander is attached, remove the expander(s). Refer to the section in this chapter titled 'HP A2246A and HP A2247A Expanders' for instructions.
6. Remove the top cover.

Removal and Installation

Installing CD ROM disk drives is the reverse of removing them.

Follow these steps to remove the CD ROM disk drive:

- 1** Unplug the power and SCSI cables from all drives.

Note the SCSI cable connectors as they are connected to the drives.

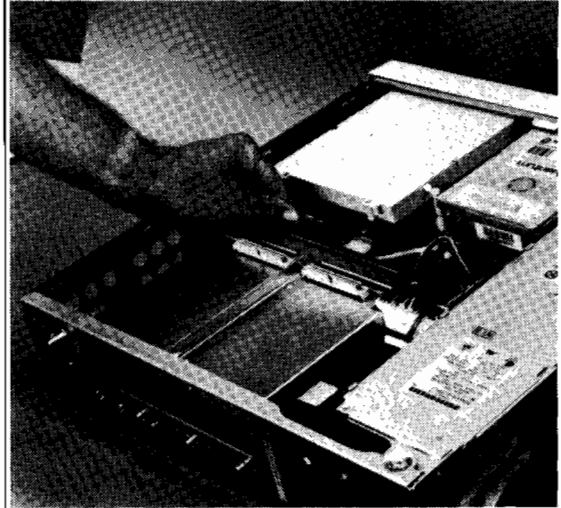

- 2** Remove the two screws at the rear of the drive tray, one on each corner.

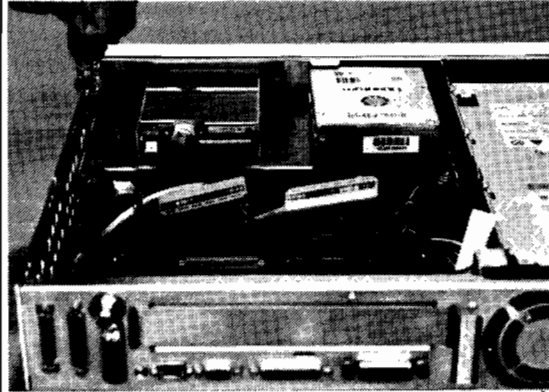

- 3** Slide the drive tray to the rear about 12 mm (0.5-in.) until the three tabs are free from the chassis and lift the drive assembly out of the unit.

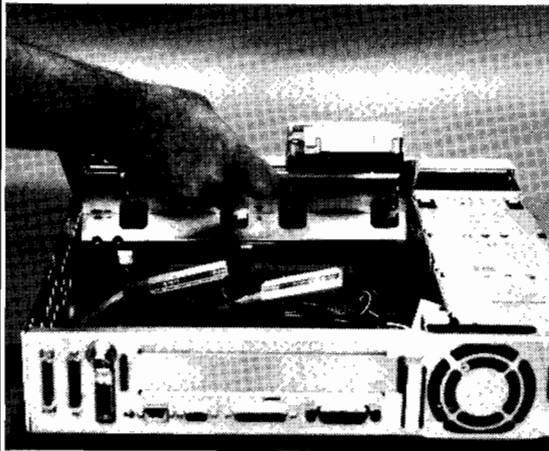

Caution

Although mass storage devices are well-protected from physical shock when installed in the controller, it is very easily damaged when removed. Avoid dropping or striking the device. Handle it gently at all times.

- 4** Remove the four screws from the bottom of the tray holding the drive and remove the drive from the tray.

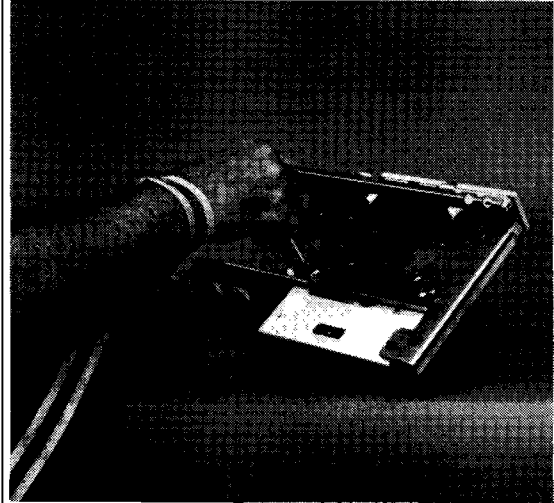

- 5** Note the configuration jumper/switch positions. The replacement drive must be configured the same.

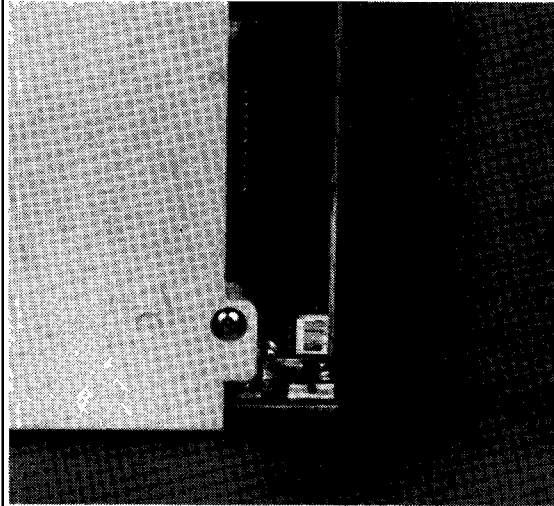

Real-Time Clock Battery

Preliminary Requirements

Before you remove the controller's RTC battery:

1. Shut down the operating system.
2. Turn OFF the controller.
3. Remove all cables and cords attached to the controller.
4. If rack mounted, remove the units from the rack.
5. If an expander is attached, remove the expander(s). Refer to the section in this chapter titled 'HP A2246A and HP A2247A Expanders' for instructions.
6. Remove the:
 - a. Top cover.
 - b. DIO-I card cage and backplane.

Follow these steps to replace the RTC battery:

- 1** Raise the tab holding the battery in place and remove the battery.

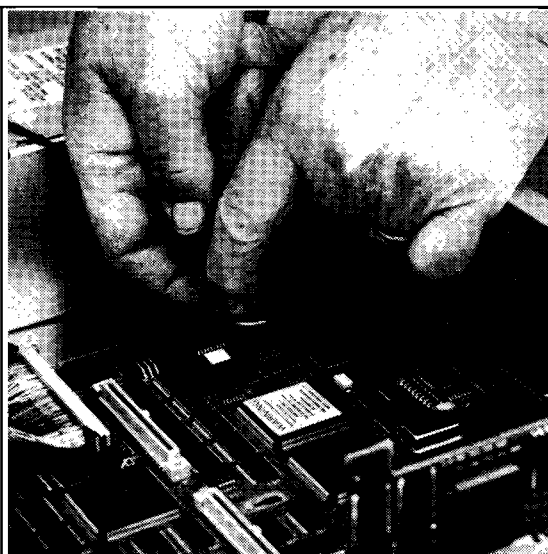

Warning

Lithium batteries may explode if mistreated. Do not put lithium batteries in fires, try to recharge or disassemble them.

Replace battery with only a Matsushita Electric BR-2325 three-volt lithium battery (HP part number 1420-0314)! Use of any other battery may cause fire or explosion.

2 Install the new battery with its '+' side up.

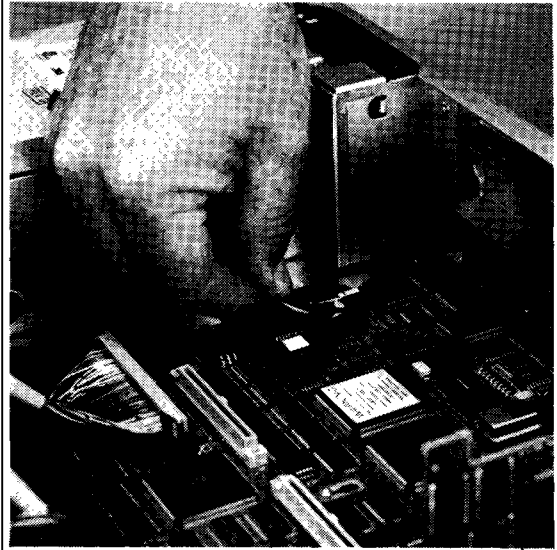

LAN Board

Preliminary Requirements

Before you remove the controller's LAN board:

1. Shut down the operating system.
2. Turn OFF the controller.
3. Remove all cables and cords attached to the controller.
4. If rack mounted, remove the units from the rack.
5. If an expander is attached, remove the expander(s). Refer to the section in this chapter titled 'HP A2246A and HP A2247A Expanders' for instructions.
6. Remove the:
 - a. Top cover.
 - b. DIO card cage and backplane.
 - c. System board I/O connector screws from the rear panel.

Removal

Follow these steps to remove the LAN board:

- 1** Slide the system board back about 12 mm (0.5-in). to let the LAN board's connectors clear the rear panel.

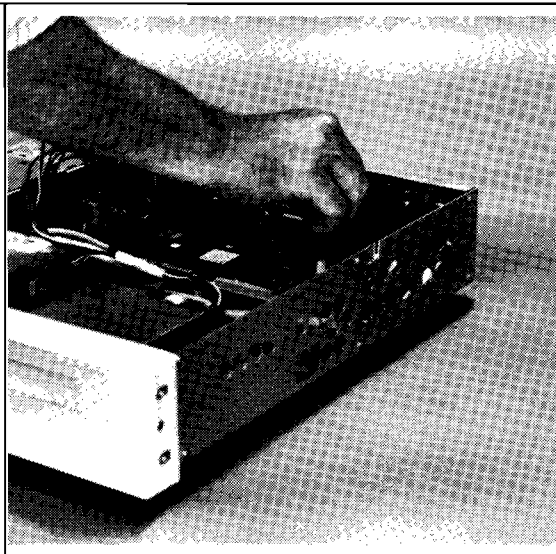

- 2** Remove the LAN board from the system board by pulling it up and tilting its front to let its connectors clear the rear panel.

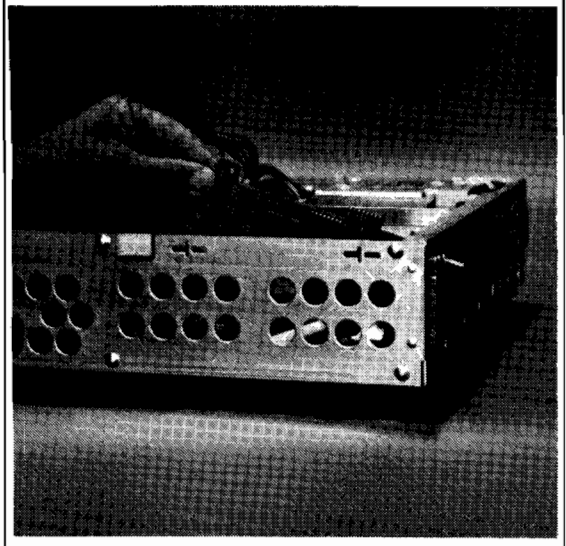

Installation

- 1** Before installing the LAN board, ensure its LAN type jumper is set to the correct position.

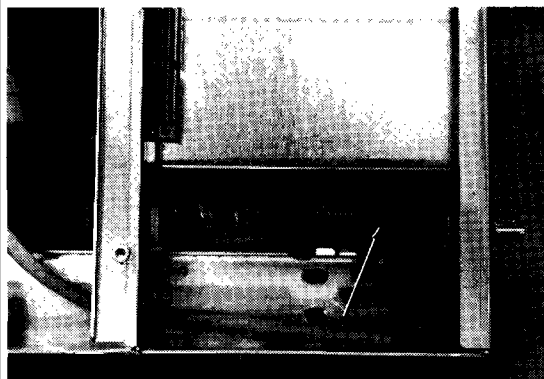

- 2** Install the LAN board the reverse of installing it.

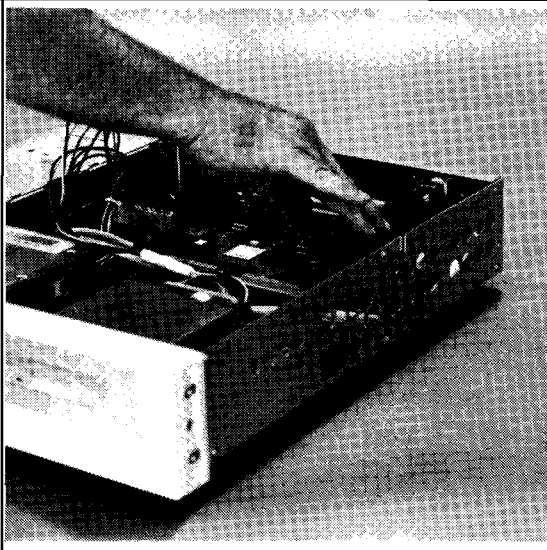

System Board

Preliminary Requirements

Before you remove the controller's system board:

1. Shut down the operating system.
2. Turn OFF the controller.
3. Remove all cables and cords attached to the controller.
4. If rack mounted, remove the units from the rack.
5. If an expander is attached, remove the expander(s). Refer to the section in this chapter titled 'HP A2246A and HP A2247A Expanders' for instructions.
6. Remove the:
 - a. Top cover.
 - b. SCSI and power cables from the mass storage devices if installed.
 - c. RAM boards.
 - d. Mass storage tray with drives attached.
 - e. DIO-I card cage and backplane.
 - f. SCSI cable connector from system board.

Removal

Follow these steps to remove the system board:

- 1** Remove all the interface connector screws holding the system board's I/O connectors to the rear panel

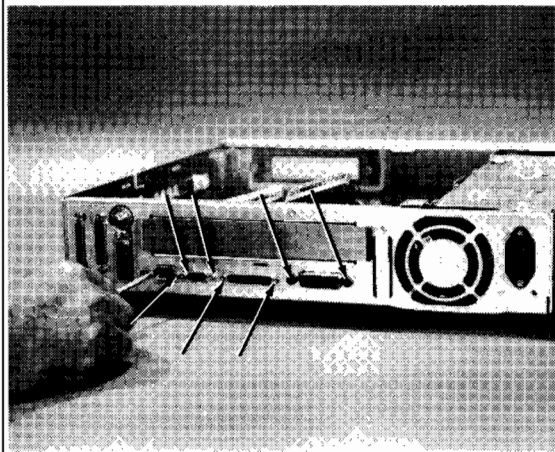

- 2** Pull the system board (with LAN board, if installed) towards the front until the notches on its side align with the tabs on both sides of the system board.

Note the keyhole standoffs in the middle of the system board.

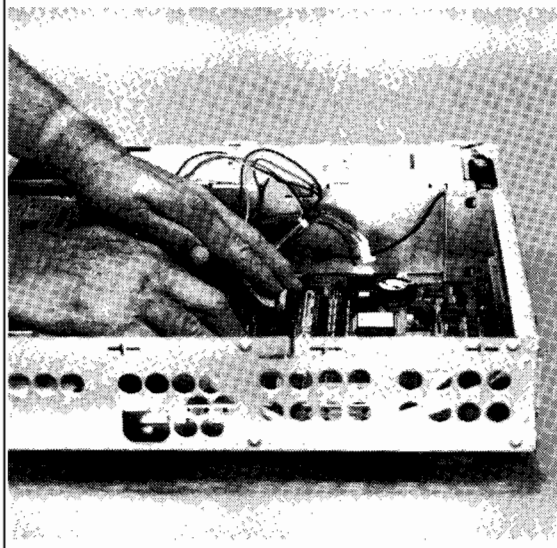

- 3** Lift the system board up and out of the chassis.

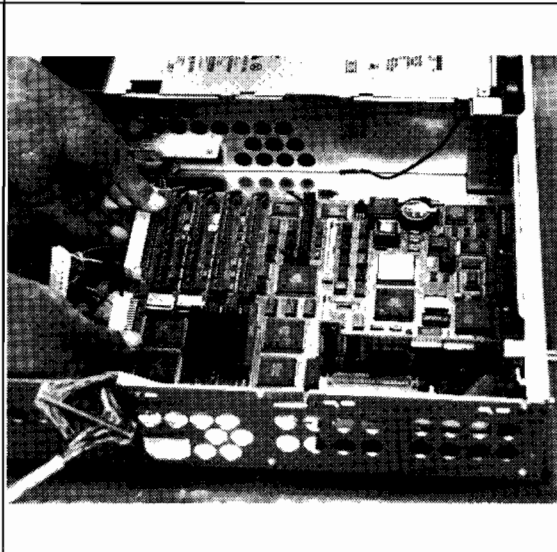

- 4** If installed, remove the LAN board from the system board.

If no LAN board is installed, go on to the next step.

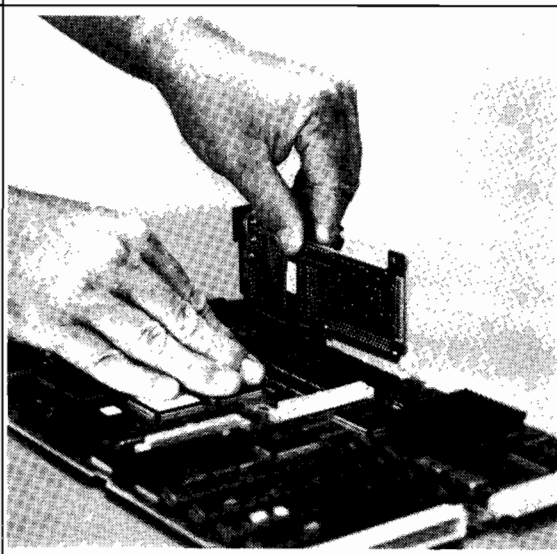

- 5** Unplug the HP Parallel ribbon cable from its connector on the system board.

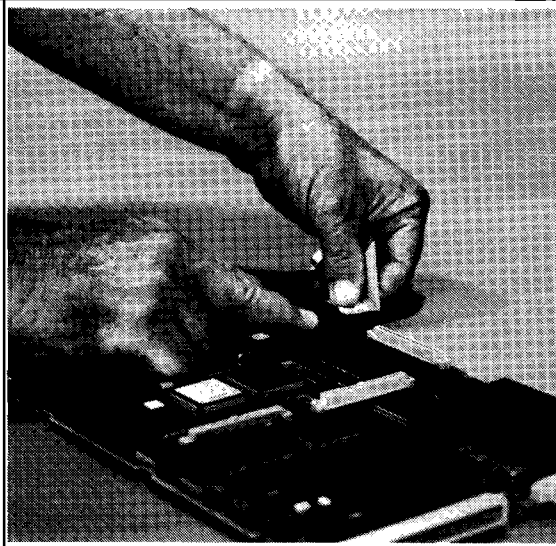

Installation

System board installation is the reverse of removing it.

Before installing a system board, make sure the:

- LAN board is installed, if required, and its jumper is in the correct position.
- RAM boards are replaced in the correct RAM sockets. You can do this after installing the system board.
- Color/Grayscale graphics jumper is in the color position.
- Graphics enable switch is in the ENABLE position if system board graphics is used.

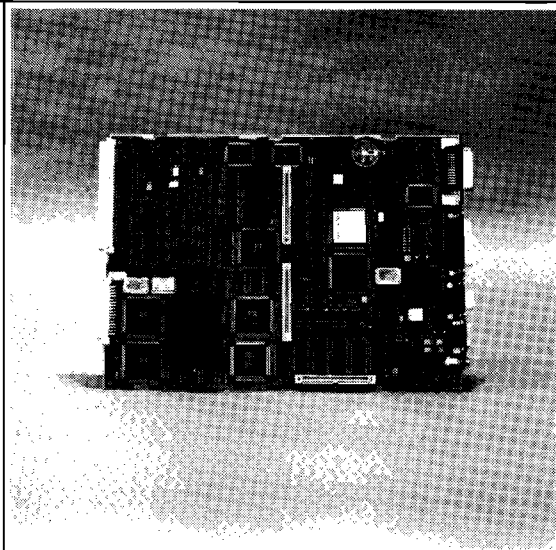

Note

Grayscale graphics is not supported on Model 362 and 382 Controllers. The grayscale configuration is used only in the HP A1314A, HP A1319A and HP A1324A R/362 and R/382 Integrated Controllers.

Power Supply

Preliminary Requirements

Before you remove the controller's power supply:

1. Shut down the operating system.
2. Turn OFF the controller.
3. Remove all cables and cords attached to the controller.
4. If rack mounted, remove the units from the rack.
5. If an expander is attached, remove the expander(s). Refer to the section in this chapter titled 'HP A2246A and HP A2247A Expanders' for instructions.
6. Remove the top cover.

Removal and Installation

Installing the power supply is the reverse of removing it.

Follow these steps to remove the power supply:

- 1** Remove the wire guard clip and power distribution cable from the DIO-I backplane.

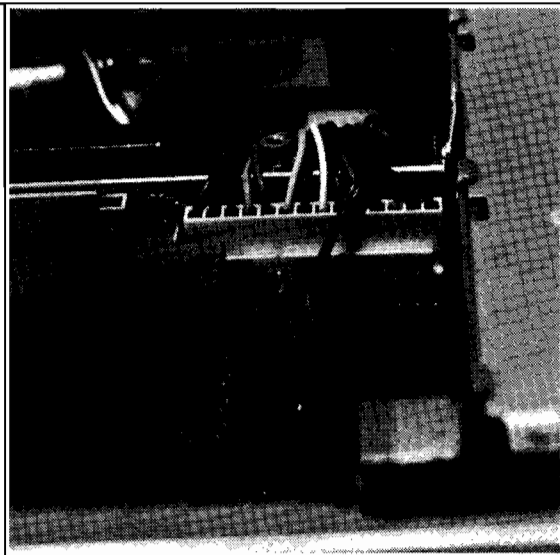

- 2** Remove the power supply's mounting screw from the rear of the chassis.

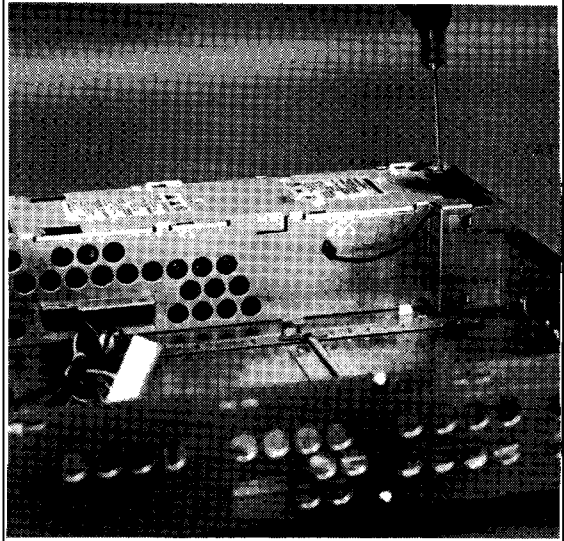

- 3** Slide the supply forward about 12 mm (0.5-in.) until its slots align with the chassis tabs.

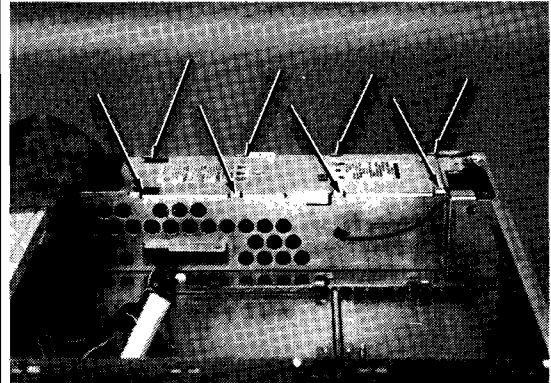

- 4** Lift the supply up and out of the unit, while feeding the cable through the slotted hole.

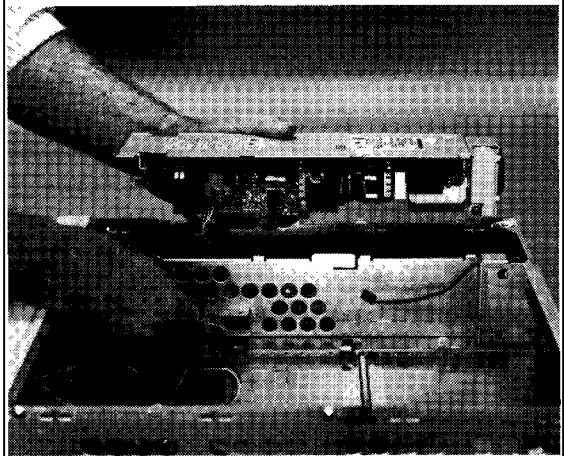

Front Panel

Preliminary Requirements

Before you remove the controller's front panel:

1. Shut down the operating system.
2. Turn OFF the controller.
3. Remove all cables and cords attached to the controller.
4. If rack mounted, remove the units from the rack.
5. If an expander is attached, remove the expander(s). Refer to the section in this chapter titled 'HP A2246A and HP A2247A Expanders' for instructions.
6. Remove the top cover and front feet.

Removal and Installation

Installing the front panel is the reverse of removing it.

Follow these steps to remove the front panel:

- 1** With your thumb nails or a small flat screwdriver, lift the back edge of the top of the front panel to release the top tabs.

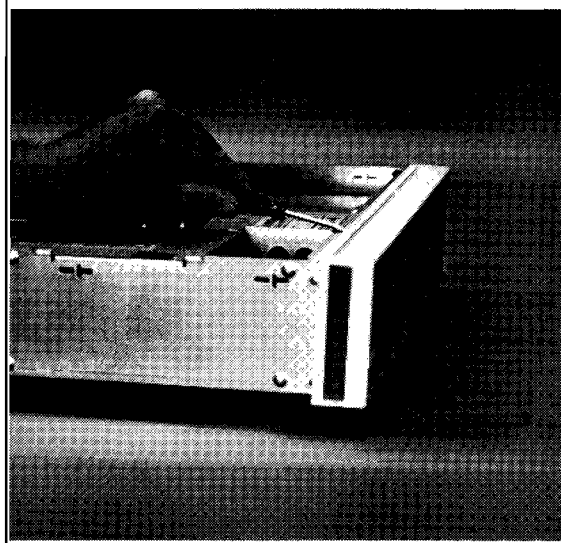

2 Release the two bottom tabs.

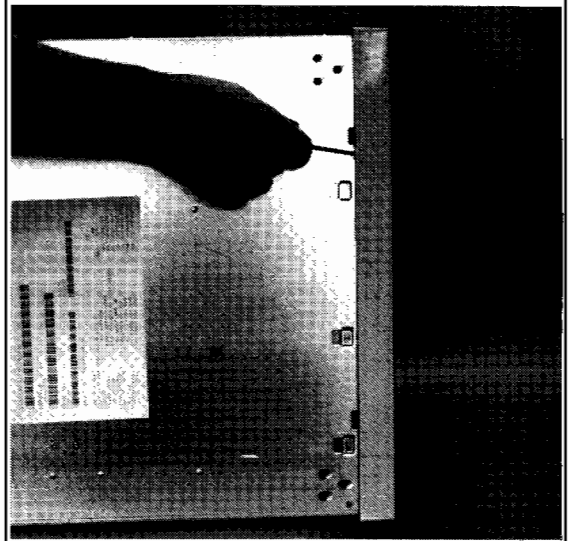

3 While holding the top from snapping back into place, push the two bottom tabs out of the bottom of the chassis and slide the panel forward to remove it.

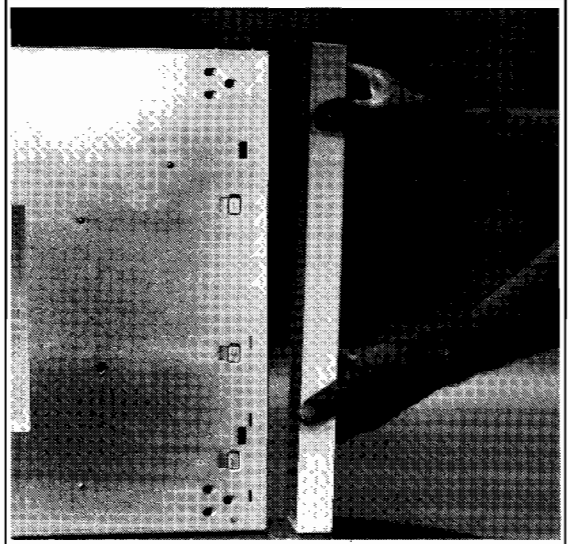

Feet

Preliminary Requirements

Before you remove the controller's feet:

1. Shut down the operating system.
2. Turn OFF the controller.
3. Remove all cables and cords attached to the controller.

Removal and Installation

Installing the feet is the reverse of removing them.

To remove the feet:

Push up and back on the foot's front edge, then pull the foot forward and out of its chassis holes.

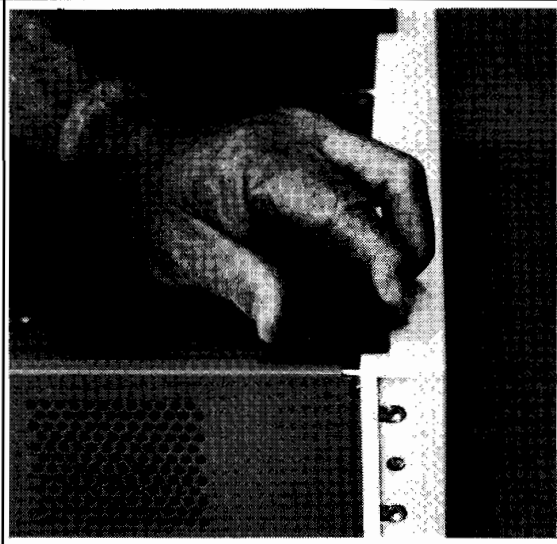

Fan

Preliminary Requirements

Before you remove the controller's fan:

1. Shut down the operating system.
2. Turn OFF the controller.
3. Remove all cables and cords attached to the controller.
4. If rack mounted, remove the units from the rack.
5. If an expander is attached, remove the expander(s). Refer to the section in this chapter titled 'HP A2246A and HP A2247A Expanders' for instructions.
6. Remove the top cover.
7. Remove the power supply.

Removal and Installation

Installing the fan is the reverse of removing it.

Follow these steps to remove the fan:

- 1** Unplug the fan cable from the DIO-I backplane board.

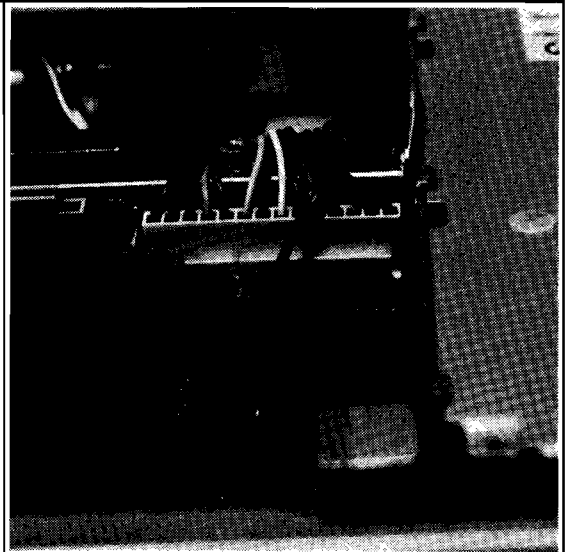

2 Slide the fan towards the left side and to the front, then lift it out while pulling its wires through the fan wire hole in the power supply.

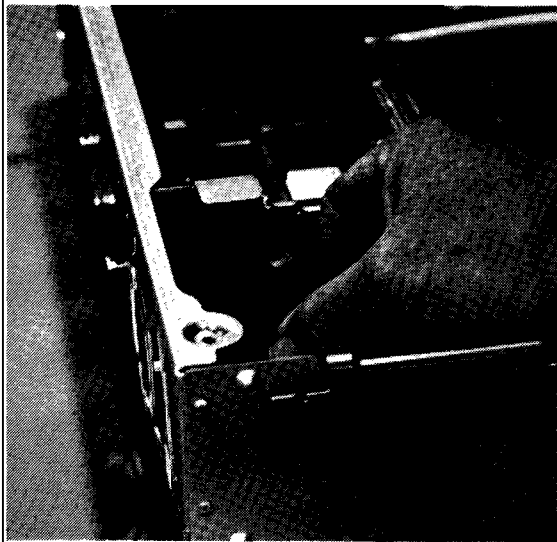

3 Note the airflow arrow on the fan. When installing the fan, the airflow must be towards the outside.

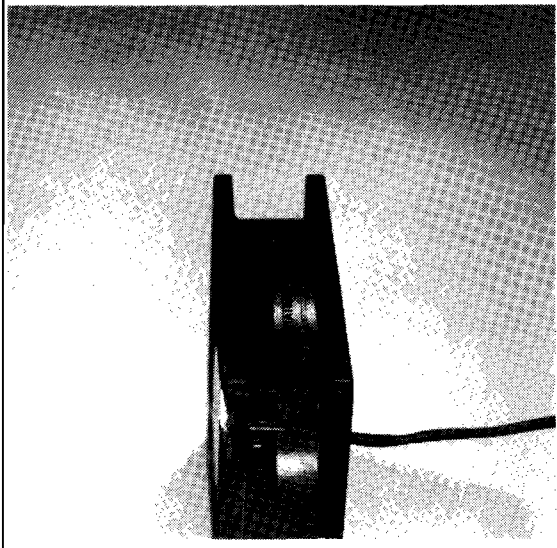

SCSI Cable

This procedure applies to both the internal and external connector SCSI cable.

Preliminary Requirements

Before you remove the controller's scsi cable:

1. Shut down the operating system.
2. Turn OFF the controller.
3. Remove all cables and cords attached to the controller.
4. If rack mounted, remove the units from the rack.
5. If an expander is attached, remove the expander(s). Refer to the section in this chapter titled 'HP A2246A and HP A2247A Expanders' for instructions.
6. Remove the:
 - a. Top cover.
 - b. DIO-I support.

Removal and Installation

Installing the SCSI cable is the reverse of removing it.

Follow these steps to remove the SCSI cable:

- 1** Unplug the SCSI cable from all mass storage devices.

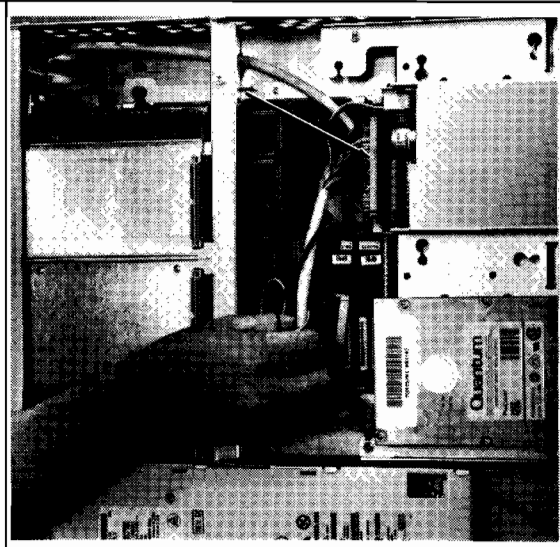

2 Release the system board's SCSI connector clips, then unplug the SCSI cable connector.

If you are removing an internal SCSI cable, remove the cable.

If you are removing an external connector SCSI cable, go on to the next step.

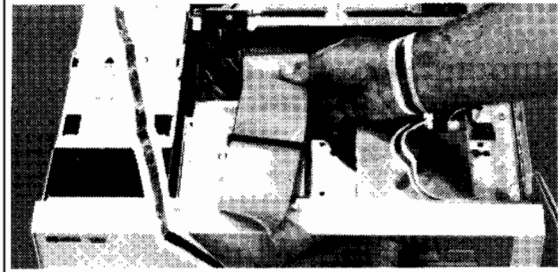
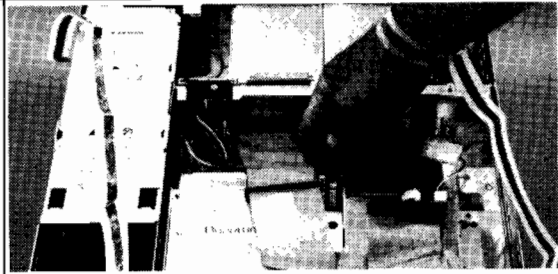

3 Remove the rear panel's SCSI connector's top and bottom screw.

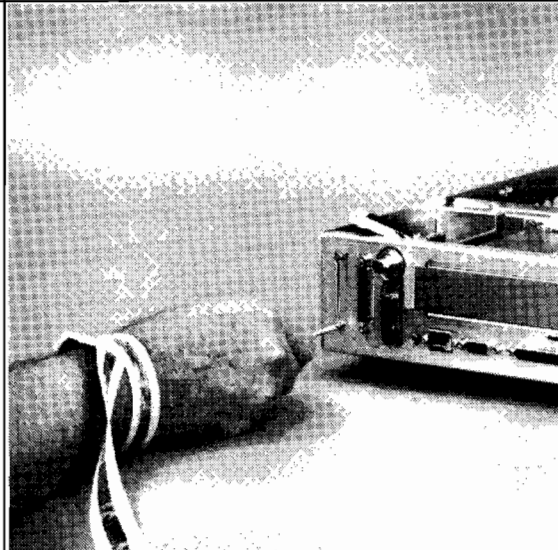

4 Remove the connector from the rear panel from the inside.

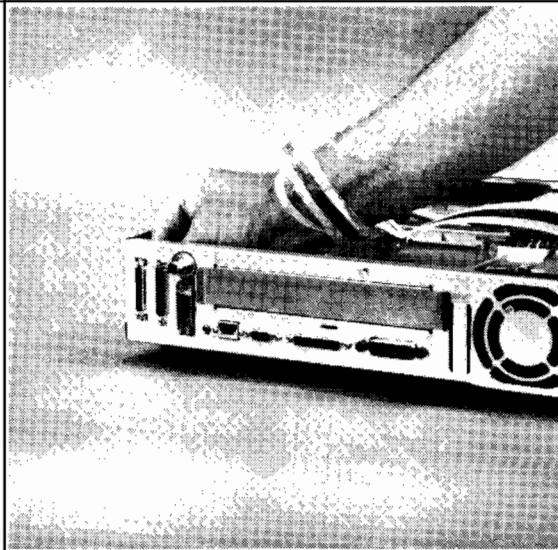

Power Switch Assembly

Preliminary Requirements

Before you remove the controller's power switch assembly:

1. Shut down the operating system.
2. Turn OFF the controller.
3. Remove all cables and cords attached to the controller.
4. If rack mounted, remove the units from the rack.
5. If an expander is attached, remove the expander(s). Refer to the section in this chapter titled 'HP A2246A and HP A2247A Expanders' for instructions.
6. Remove the top cover and wire guard clip.

Removal and Installation

Installing the power switch assembly is the reverse of removing it.

Follow these steps to remove the power switch assembly:

- 1** Unplug the power switch cable from the DIO-I backplane board.

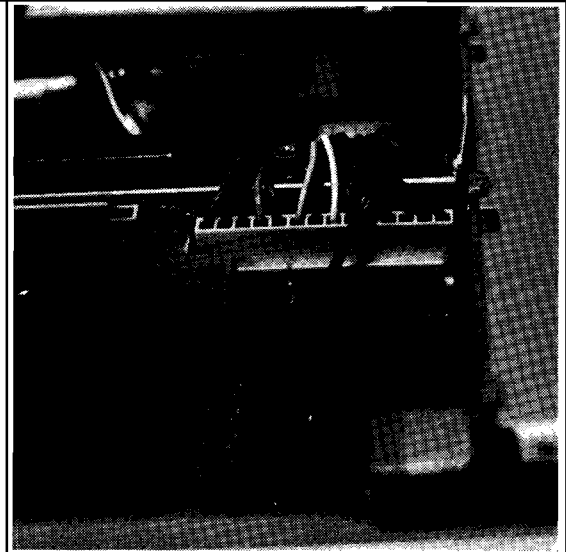

- 2** Spread the power switch clips apart and pull the power switch assembly out of the controller.

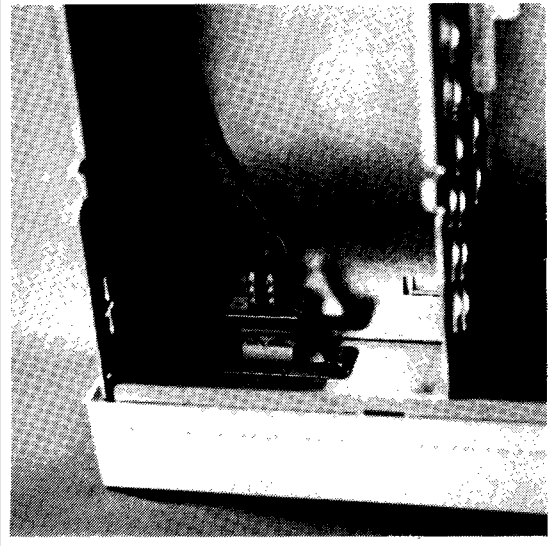

Mass Storage Trim Plate

Preliminary Requirements

Before you remove the controller's mass storage trim plate:

1. Shut down the operating system.
2. Turn OFF the controller.
3. Remove all cables and cords attached to the controller.
4. If rack mounted, remove the units from the rack.
5. If an expander is attached, remove the expander(s). Refer to the section in this chapter titled 'HP A2246A and HP A2247A Expanders' for instructions.
6. Remove the top cover.

Removal and Installation

Installing the mass storage trim plate is the reverse of removing it.

Follow these steps to remove the mass storage trim plate:

Press down and back on the upper lip of the trim plate, then remove the trim plate while holding its top bent down.

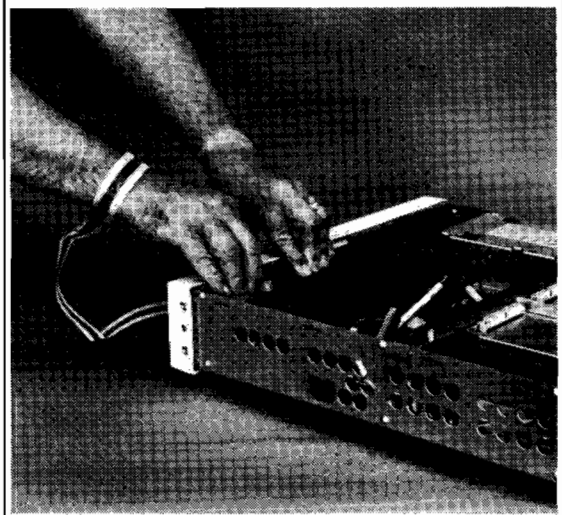

HP A2246A DIO-I 4-Slot and HP A2247A DIO-II 2-Slot Bus Expanders

Overview and Parts References

For each expander assembly, Preliminary Requirements are listed and must be done before the Removal instructions are followed.

Instructions are based on the:

- Hardware orientation shown in Figure 2-3.
- Exploded view shown in Figure 2-4 and Figure 2-5.
- Parts listed in Table 2-3 and Table 2-4.

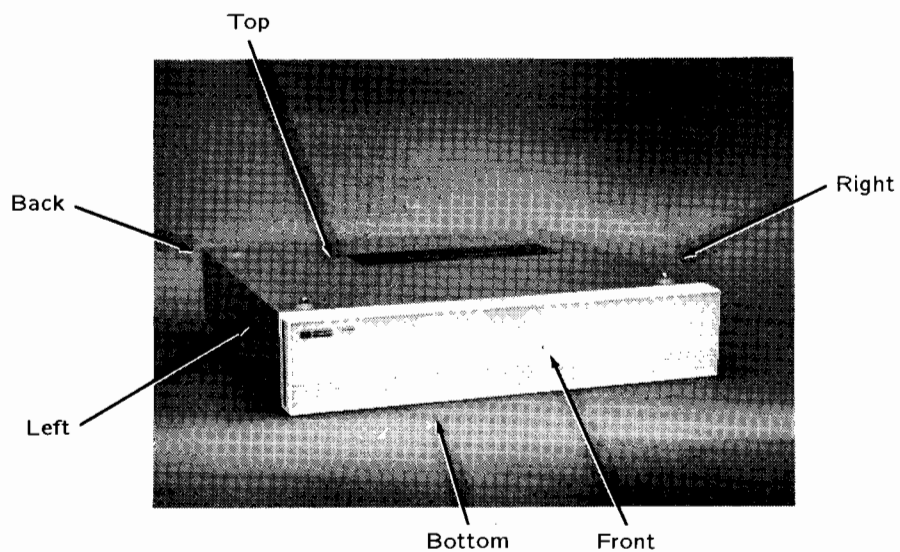

Figure 2-3. Expanders Hardware Orientation

Table 2-3. HP A2246A 4-Slot DIO-I Bus Expander Parts References

Ref. No.	Part Name	Ref. No.	Part Name
1	Power supply	14	Safety shield
2	Fan	15	Cable shield
3	Power cord adapter	16	Mounting standoff
4	DIO-I backplane	17	Gang card guide
5	Screw, M4X6 #1 Phillips	18	Front bezel, panel
6	Bushing	19	Wire hold down
7	Screw, M3X6 flat-head	20	DIO-I slot blank cover
8	Screw, M3X12	21	Label ID/INFO/UL/CSA
9	Chassis	22	Side trim panel
10	Top cover	23	Label; front panel
11	System board support	24	Cable clamp
12	Right card guide	25	Screw; M3X0.5
13	Left card guide		

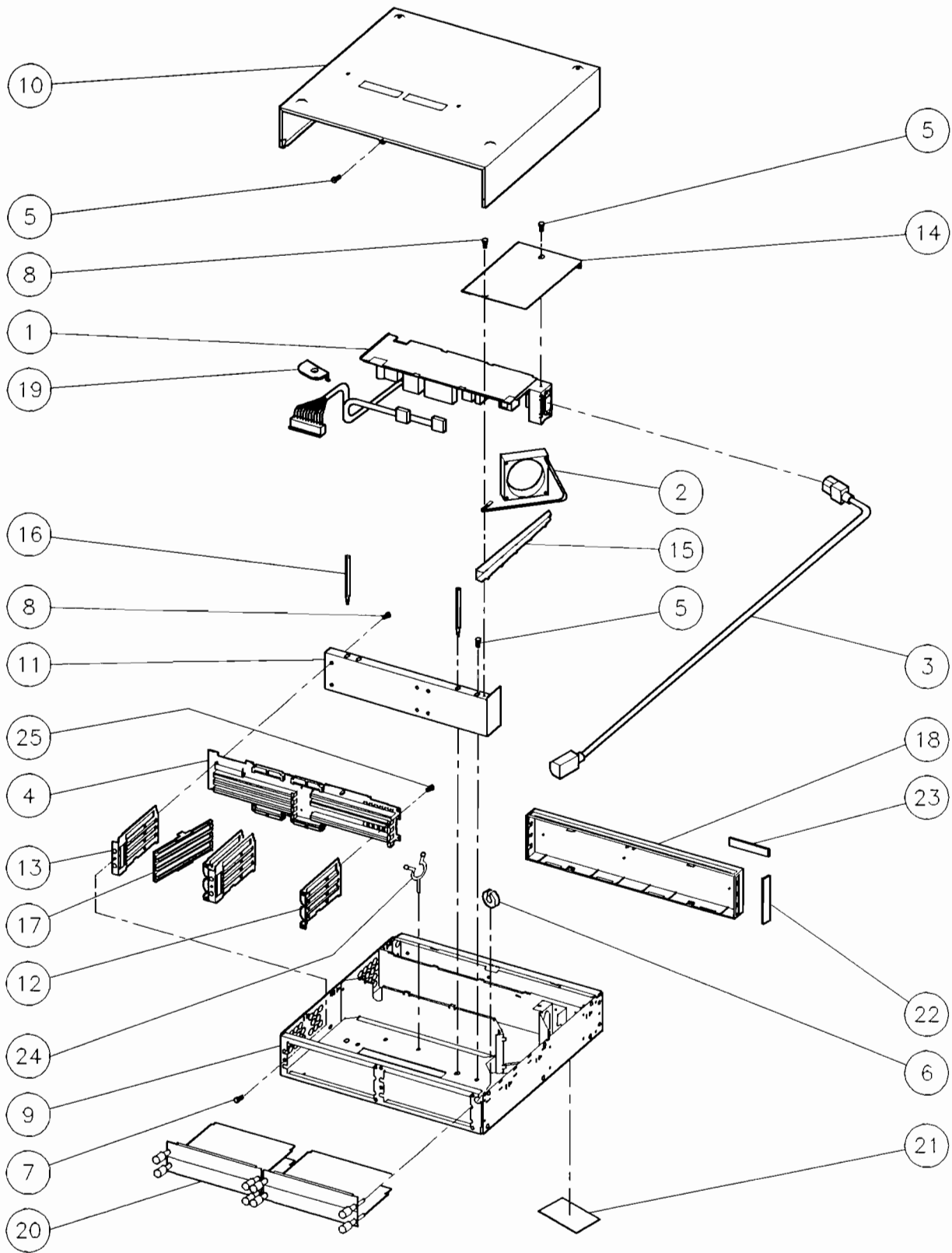

Figure 2-4. HP A2246A 4-Slot DIO-I Bus Expander Exploded View

Table 2-4. HP A2247A 2-Slot DIO-II Bus Expander Parts References

Ref. No.	Part Name	Ref. No.	Part Name
1	Power supply	11	Card cage
2	Fan	12	Bottom flex support
3	Flex circuit	13	Mounting standoff
4	Screw, M3X6 flat-head	14	Label, SER/PLTR
5	Screw, M4X8 Pozidriv®	15	DIO-II slot blank cover
6	Screw, M3X.0.5	16	Label, ID/INFO/UL/CSA
7	Top cover	17	Side trim panel
8	Chassis	18	Bushing
9	Top flex support	19	Front panel
10	Right-rear flex support	20	Backplane support

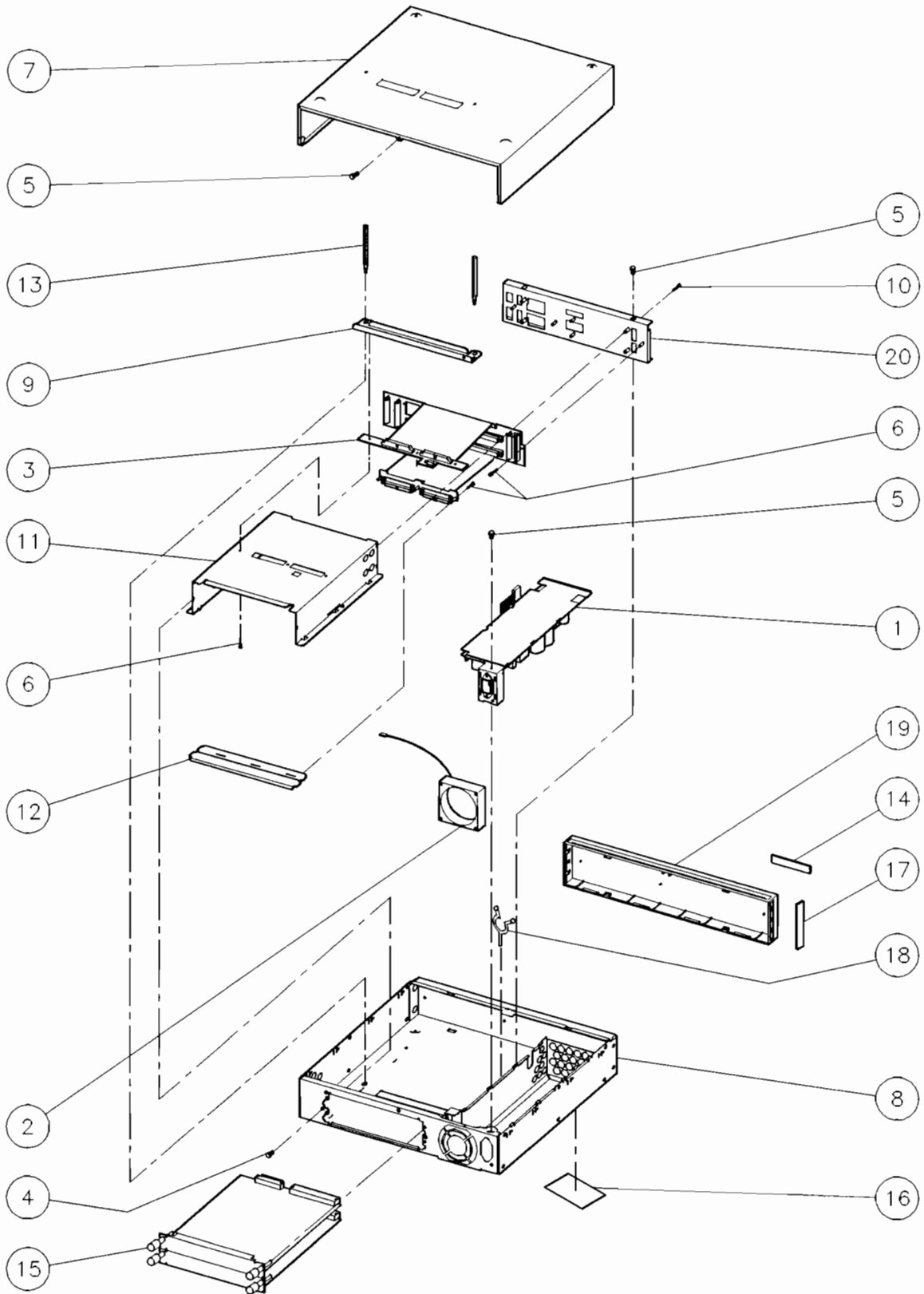

Figure 2-5. HP A2247A 2-Slot DIO-II Bus Expander Exploded View

DIO-I and DIO-II Accessory Cards

Preliminary Requirements

Before you remove an accessory card:

1. Shut down the operating system.
2. Turn OFF the controller.
3. Remove any cables connected to the accessory card.

Removal and Installation

Installing accessory cards is the reverse of removing them.

Follow this step to remove and install accessory cards:

Remove the two thumb screws holding the card's back plate to the rear panel, then pull the card out.

Note the positions of configuration switches or jumpers; set the replacement accessory card's jumpers or switches to the same positions.

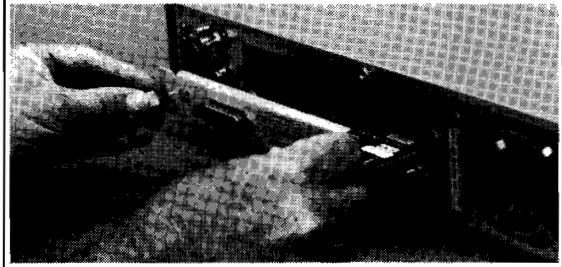
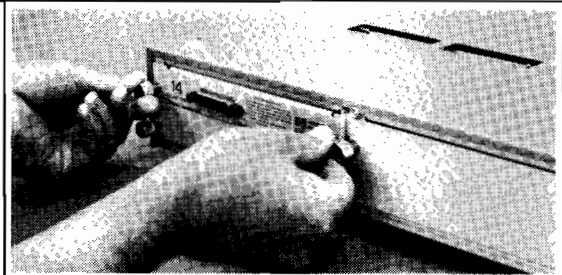

Top Cover

Preliminary Requirements

Before you remove the expander's top cover:

1. Shut down the operating system.
2. Turn OFF the controller.
3. Remove all cables and cords attached to the controller.
4. If rack mounted, remove the units from the rack.

Removal

Installing the expander's top cover is the reverse of removing it.

Follow these steps to remove the expander's top cover:

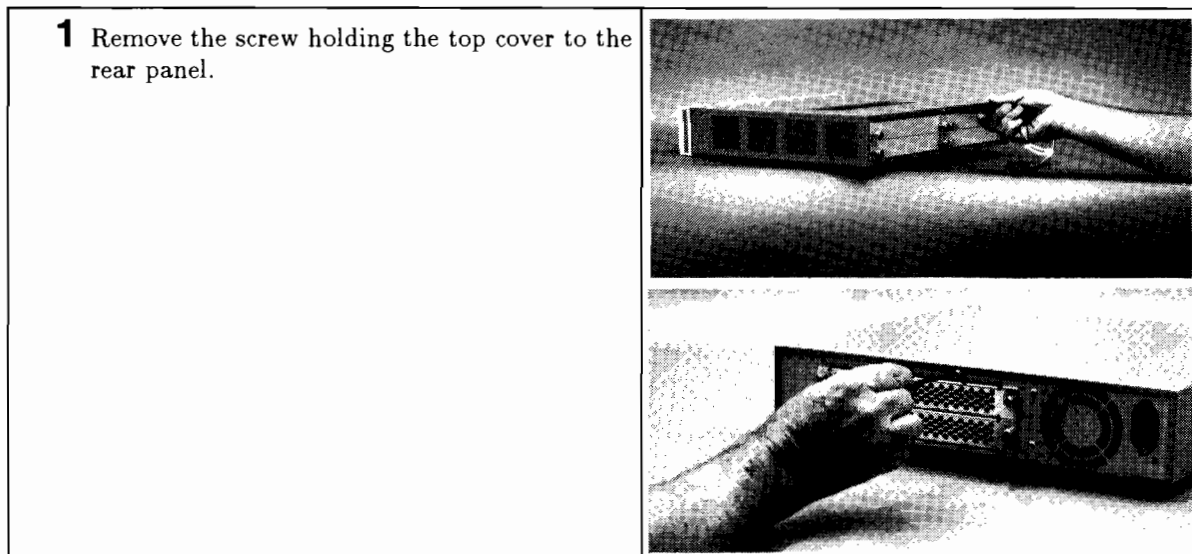

2 Slide the top cover off to the rear of the expander

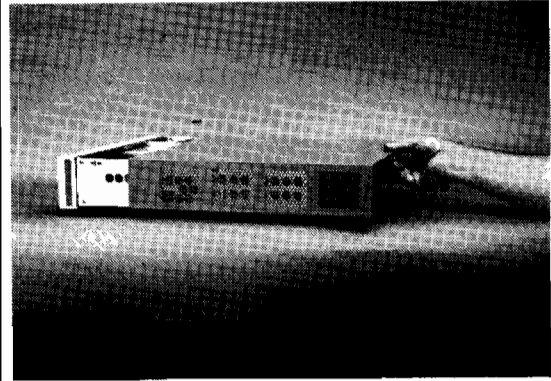

Installation

Installing the top cover is the reverse of removing it.

When replacing the top cover, make sure the tabs on each bottom side at the back fit into their chassis slots

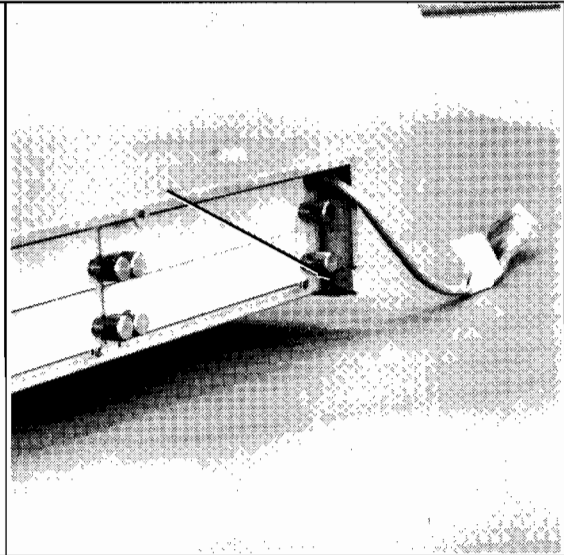

Removing an Expander from a Controller

Preliminary Requirements

Before you remove an expander from its controller:

1. Shut down the operating system.
2. Turn OFF the controller.
3. Remove all cables and cords attached to the controller.
4. If rack mounted, remove the units from the rack.
5. Remove the top cover.

Removal and Installation

Installing the expander on a controller is the reverse of removing it.

Follow these steps to remove the expander from the controller:

- 1** Remove the two screws at the front, bottom of the expander that holds the expander to the controller

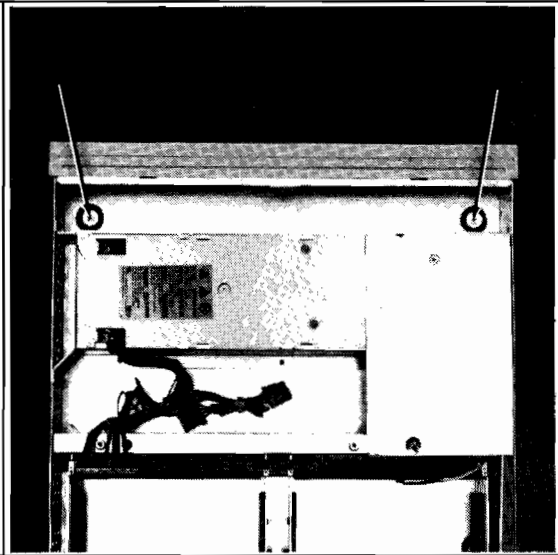

- 2** Remove the two mounting studs from the expander's center wall.

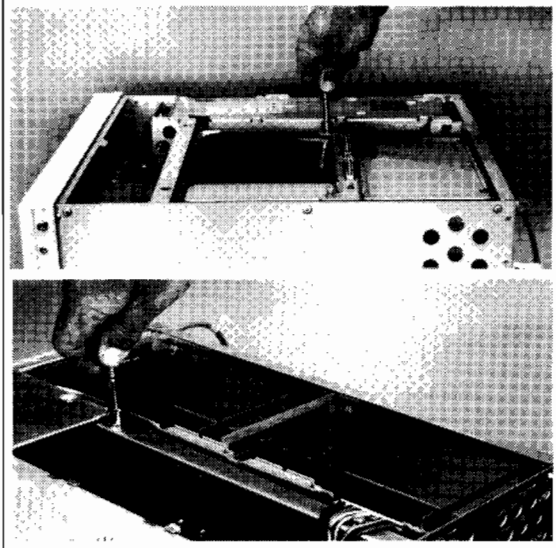

- 3** When installing the expander on a controller, align the two front bottom holes over the threaded holes on the controller, or lower expander, then lower the expander and connect the backplane edge connectors. Replace all screws and mounting studs.

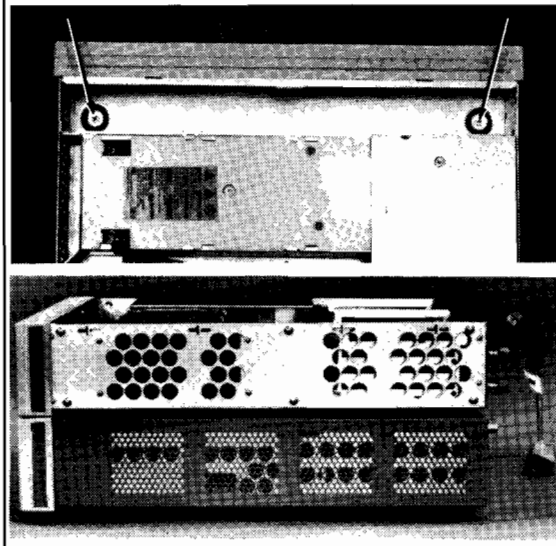

DIO-I Expander Fan

Preliminary Requirements

Before you remove the DIO-I expander's fan:

1. Shut down the operating system.
2. Turn OFF the controller.
3. Remove all cables and cords attached to the controller.
4. If rack mounted, remove the units from the rack.
5. If an expander is attached, remove the expander.
6. Remove the top cover.

Removal and Installation

Installing the fan is the reverse of removing it.

Follow these steps to remove the fan:

- 1** Disconnect the fan wire connector from the DIO backplane board..

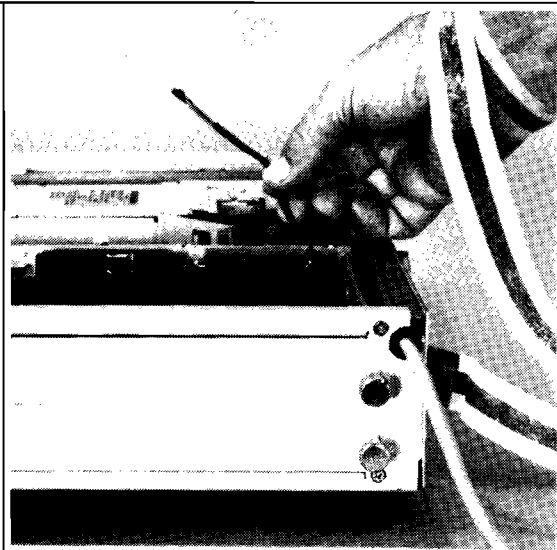

2 Remove the screw from the fan's cover plate, then lift off the plate.

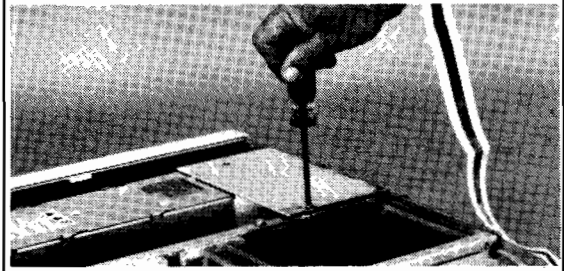

3 Note the airflow arrow on the fan. When installing the fan, the airflow must be towards the outside.



4 Lift the fan up and out of the chassis.

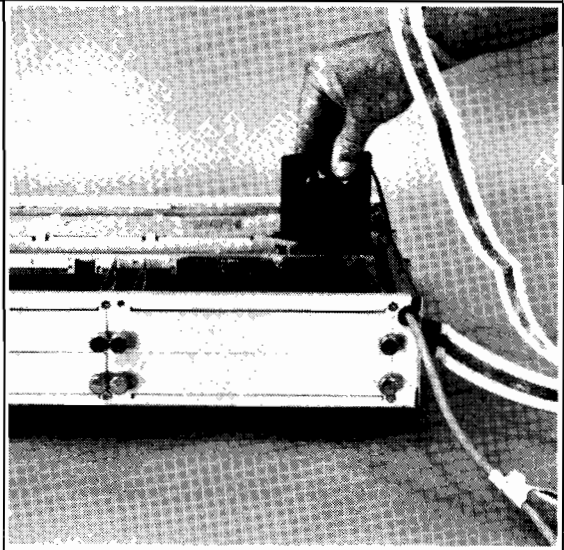

- 5** Note the two small tabs on the fan that mate to the chassis notches for fan installation.



DIO-I Expander Power Supply

Preliminary Requirements

Before you remove the expander's power supply:

1. Shut down the operating system.
2. Turn OFF the controller.
3. Remove all cables and cords attached to the controller.
4. If rack mounted, remove the units from the rack.
5. If an expander is attached, remove it.
6. Remove the top cover.

Removal and Installation

Installing the expander power supply is the reverse of removing it.

Follow these steps to remove the expander power supply:

- 1** Remove the wire guard clip, then unplug the power distribution cable connector from the DIO backplane.

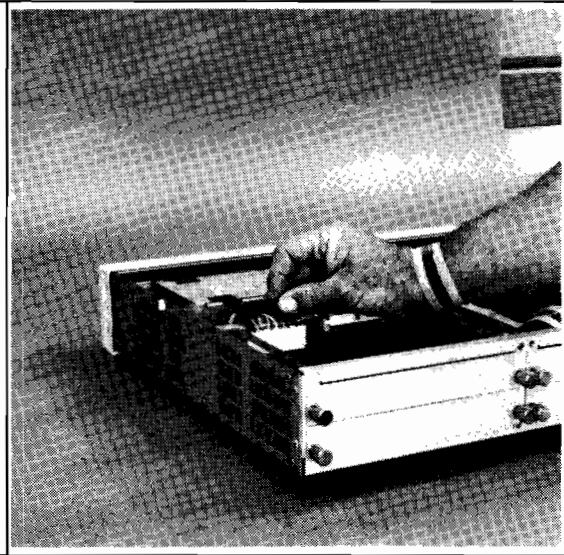

- 2** Remove the mass storage power cable connectors from their clamps.

This is the same power supply used in the Model 362 and 382 controllers. The mass storage power cables are not used in the expander.

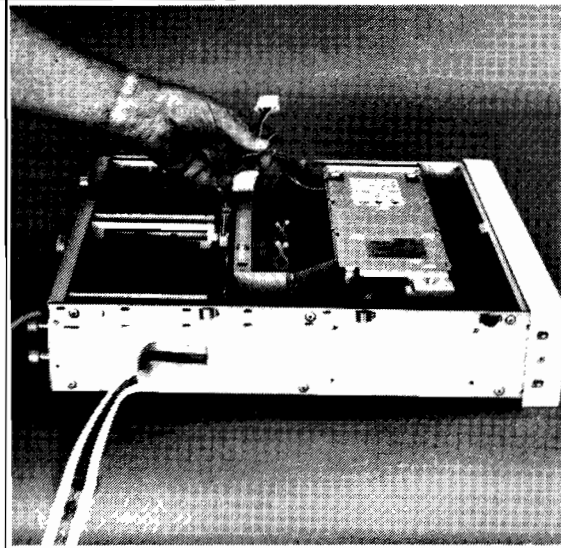

- 3** Remove the fan safety shield from over the fan.

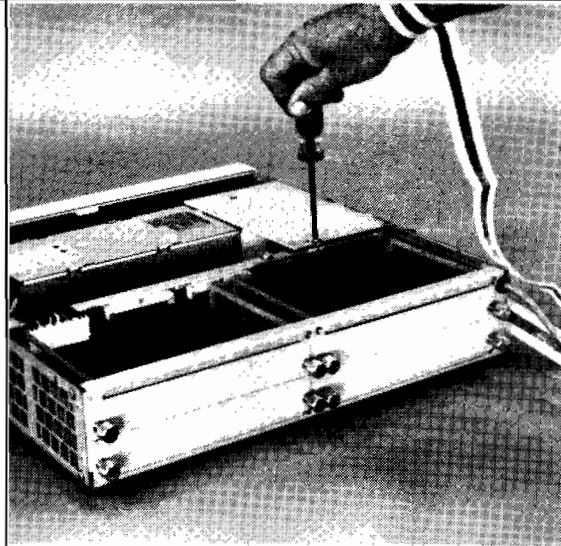

- 4** Remove the screw at the rear of the power supply.

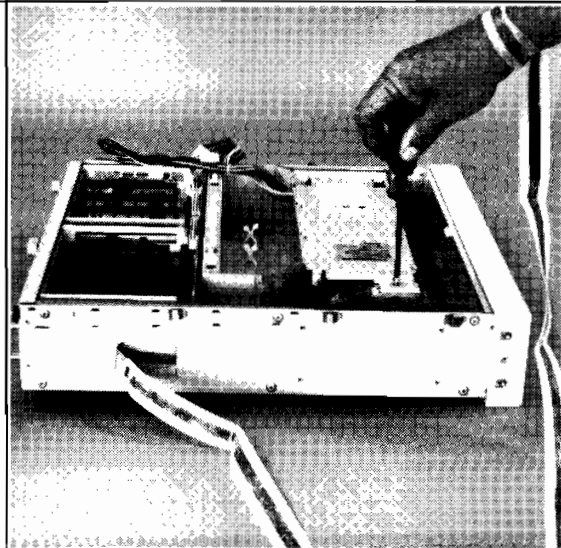

5 Pull the power supply to the right until the tabs on the chassis align with the notches in the supplies sheetmetal while removing the power cord.

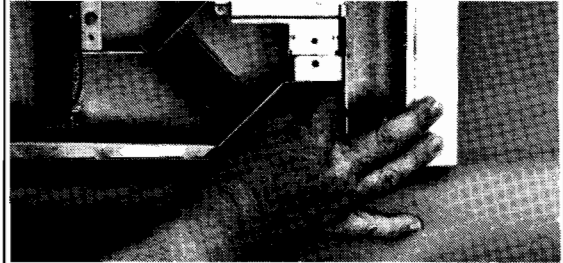
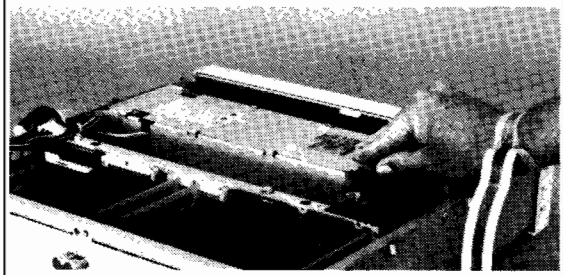

6 Lift the power supply out of the chassis.

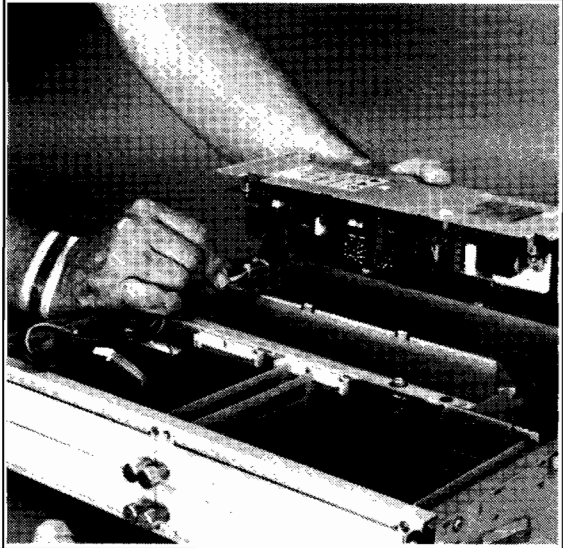

DIO-I Expander Card Cage and Backplane

Preliminary Requirements

Before you remove the DIO-I expander card cage:

1. Shut down the operating system.
2. Turn OFF the controller.
3. Remove all cables and cords attached to the controller.
4. If rack mounted, remove the units from the rack.
5. If an expander is attached, remove it.
6. Remove the top cover.

Removal and Installation

Installing the expander's card cage is the reverse of removing it.

Follow these steps to remove the expander's card cage:

- 1** Remove the six screws from the chassis' rear panel.

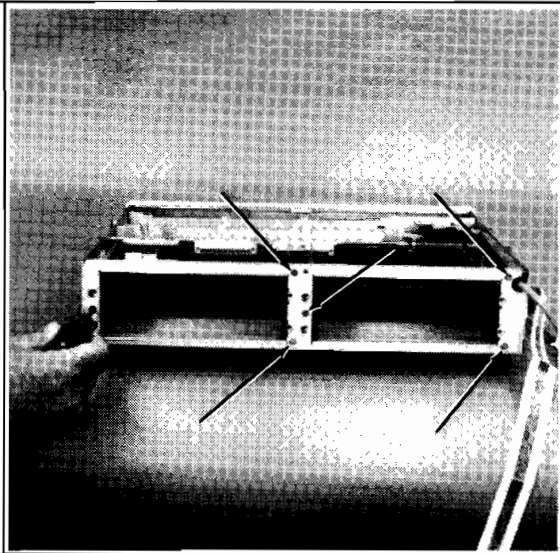

2 Remove the two screws that go through to the chassis floor.

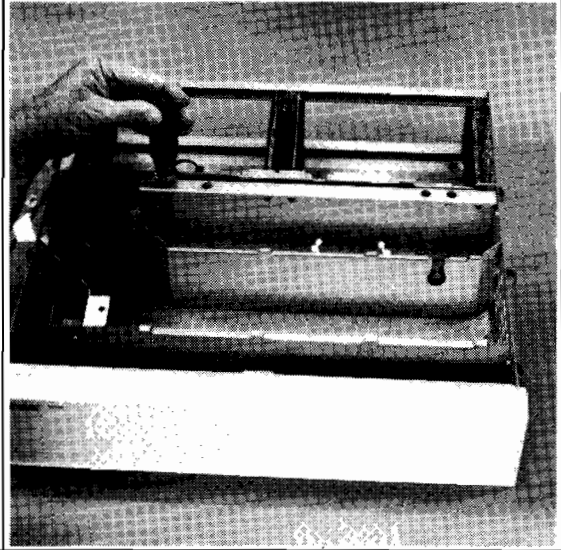

3 Remove the power cable shield by pushing down on five tabs that go through the chassis wall, then slide the shield forward and out.

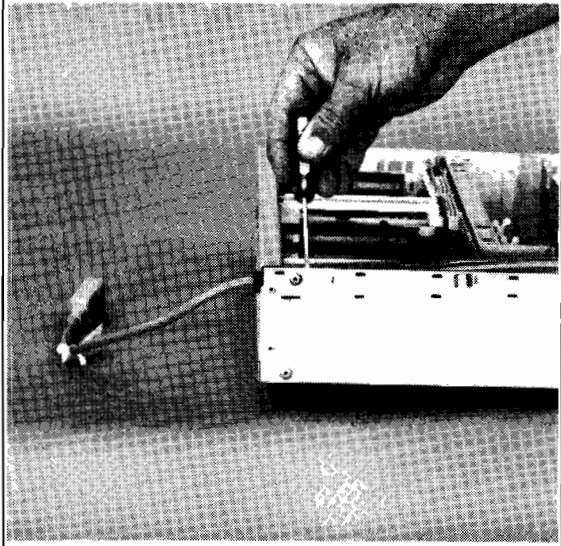

4 Lift the card cage assembly out of the chassis.

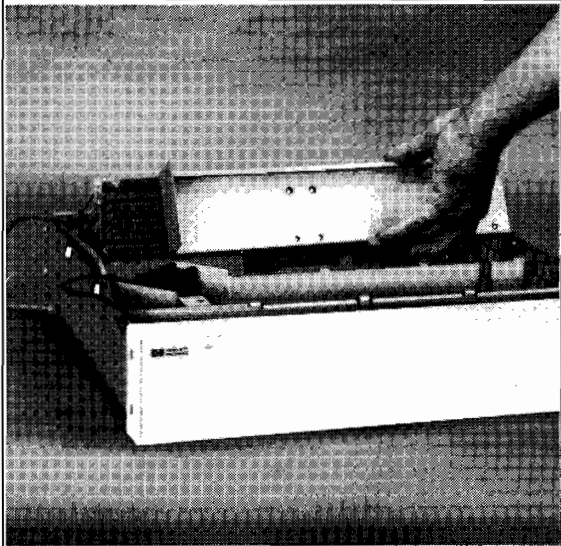

- 5** To remove the support from the backplane board, remove the six screws and set the support aside.

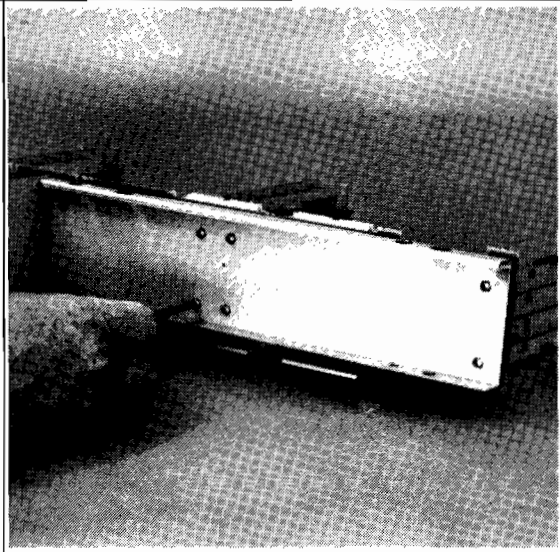

- 6** To remove the last card guide bracket, remove the two screws holding it to the board, then remove the board.

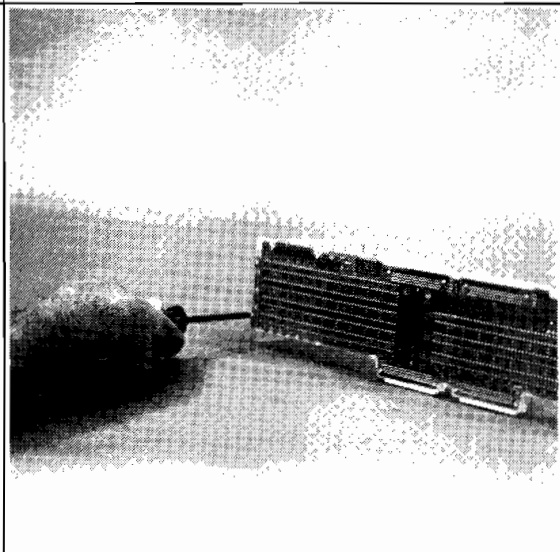

- 7** To remove a card guide from the bracket, invert the bracket so the card guide is on the back side and put your thumbs on the tabs and push out.

The guide will snap off.

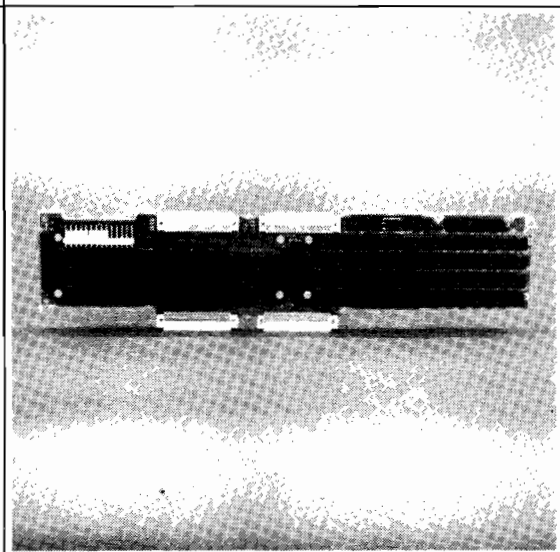

Front Panel

Preliminary Requirements

Before you remove the expander's front panel:

1. Shut down the operating system.
2. Turn OFF the controller.
3. Remove all cables and cords attached to the controller.
4. If rack mounted, remove the units from the rack.
5. If an expander is attached, remove the expander.
6. Remove the top cover.

Removal and Installation

Installing the expander front panel is the reverse of removing it.

Follow these steps to remove the expander front panel:

- 1** With your thumb nails or a small flat tipped screwdriver, lift the rear top of the front panel until the tabs release.

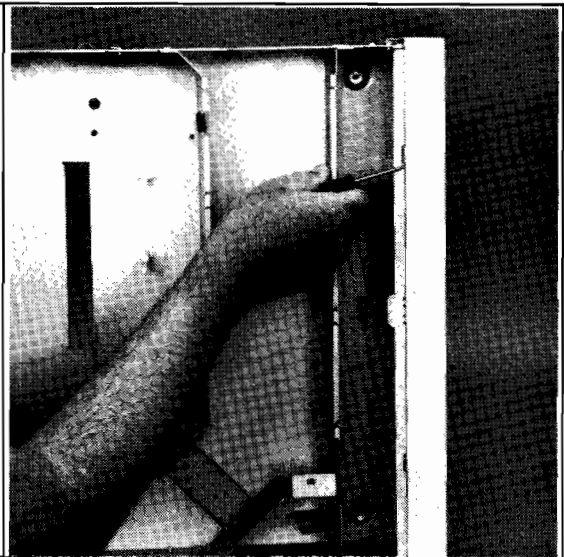

- 2** While holding them from reseating, use a screwdriver to release the bottom two tabs.

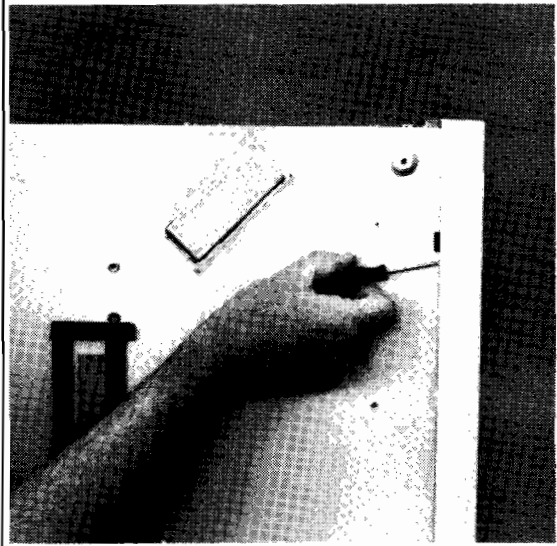

- 3** Pull the front panel off the chassis.

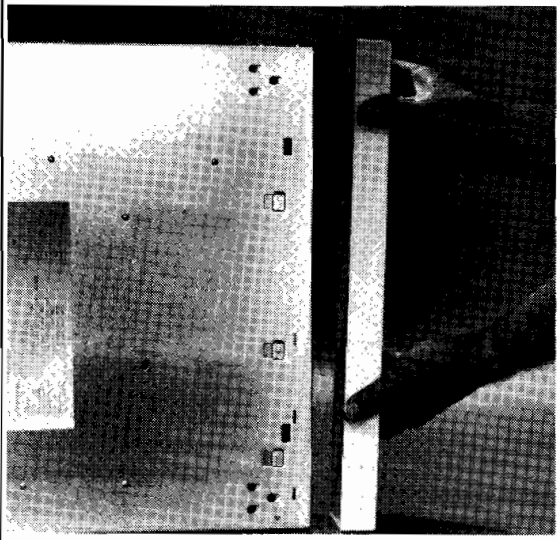

Power Cable Assembly

Preliminary Requirements

Before you remove the expander's power cable assembly:

1. Shut down the operating system.
2. Turn OFF the controller.
3. Remove all cables and cords attached to the controller.
4. If rack mounted, remove the units from the rack.
5. If an expander is attached, remove the expander.
6. Remove the top cover.

Removal and Installation

Installing the DIO-I expander power cable assembly is the reverse of removing it.

Follow these steps to remove the expander power cable assembly:

- 1** Remove the power cable shield by pushing down on five tabs that go through the chassis wall, then slide the shield forward and out.

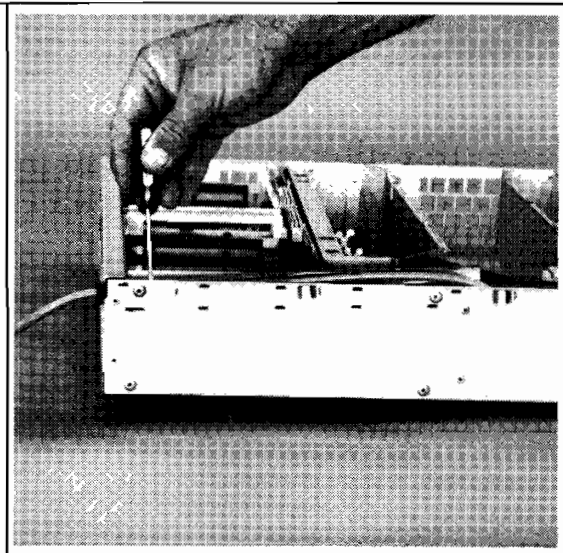

2 Squeeze the bushing and pull the clamp and cable out of the chassis.

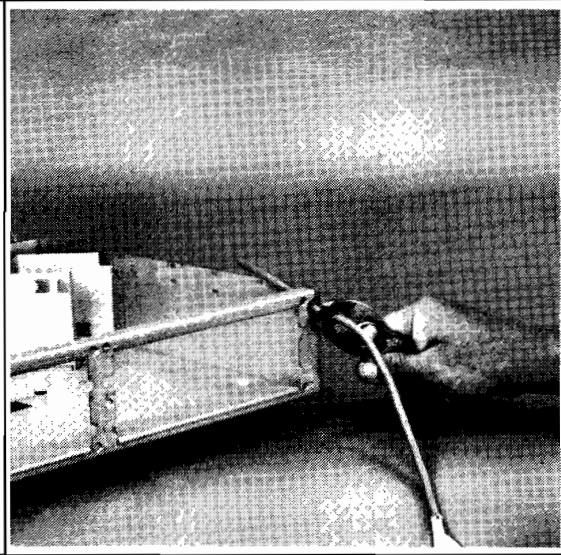

DIO-II Expander Power Supply

Preliminary Requirements

Before you remove the DIO-II expander power supply:

1. Shut down the operating system.
2. Turn OFF the controller.
3. Remove all cables and cords attached to the controller.
4. If rack mounted, remove the units from the rack.
5. If an expander is attached, remove it.
6. Remove the top cover.

Removal and Installation

Installing the DIO-II expander power supply is the reverse of removing it.

Follow these steps to remove the power supply:

- 1** Unplug the power distribution cable from its connector on the DIO-II flexible backplane.

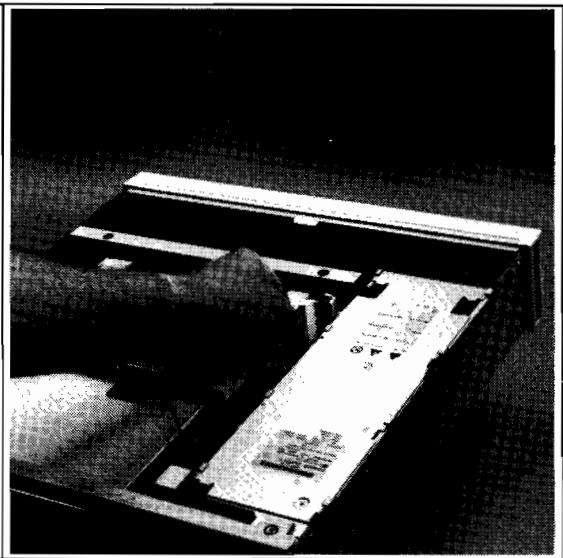

- 2** Unclasp the two cable ties and remove the power supply screw from the backplane.

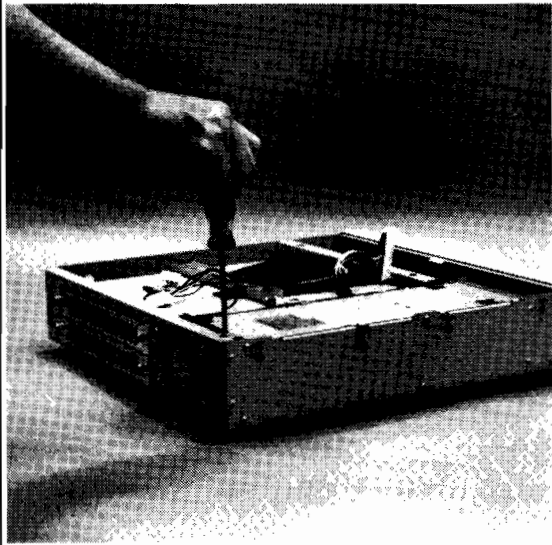

- 3** Slide the supply forward about 12 mm (0.5-in.) until its slots align with the chassis tabs.

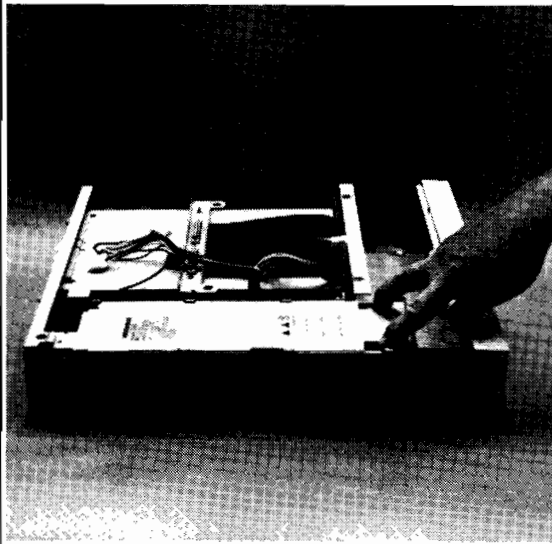

- 4** Lift the supply up and out of the unit, while feeding the cable through the slotted hole.

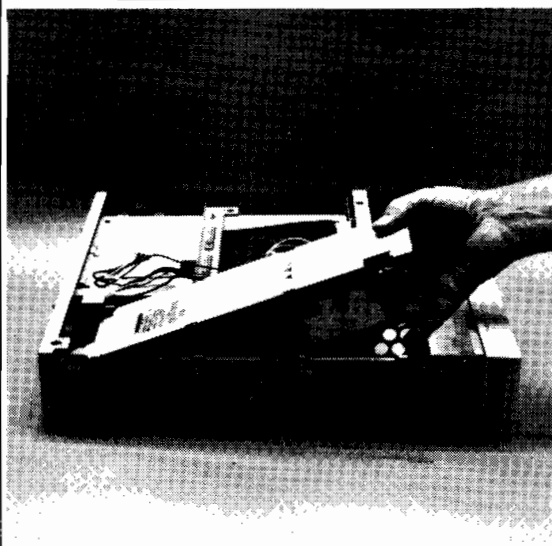

DIO-II Expander Fan

Preliminary Requirements

Before you remove the DIO-II expander fan:

1. Shut down the operating system.
2. Turn OFF the controller.
3. Remove all cables and cords attached to the controller.
4. If rack mounted, remove the units from the rack.
5. If an expander is attached, remove the expander.
6. Remove the:
 - a. Top cover.
 - b. Power supply.

Removal

Follow these steps to remove the DIO-II expander fan:

- 1** Unplug the fan cable connector from its flexible backplane connector.

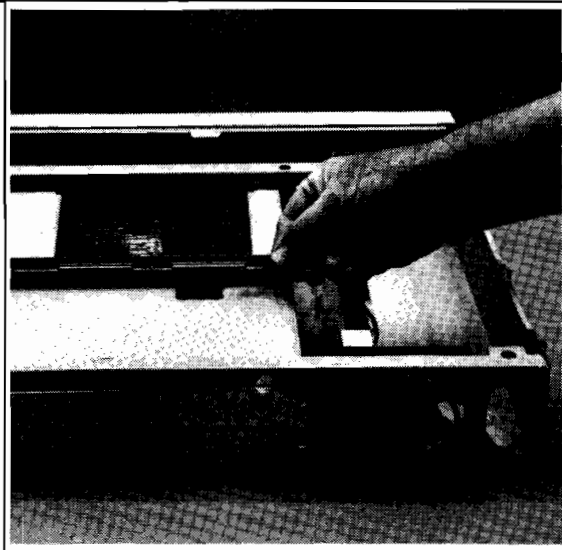

2 Slide the fan to the right, tilt it towards the front and work it out.

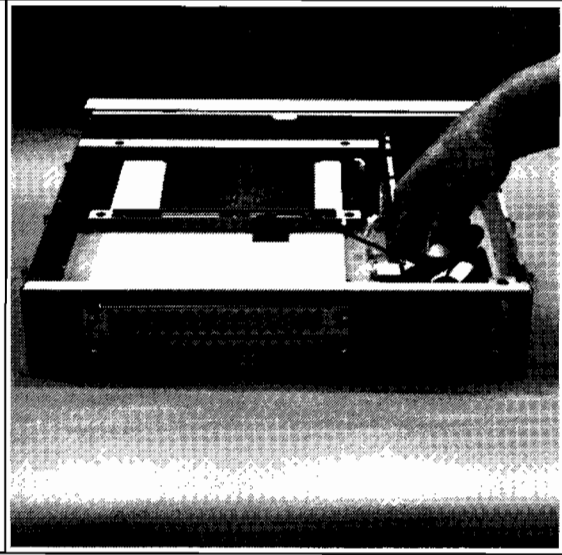

Installation

- 1** Note the arrow on the fan indication air flow direction. The fan must be installed with the arrow pointing towards the outside.

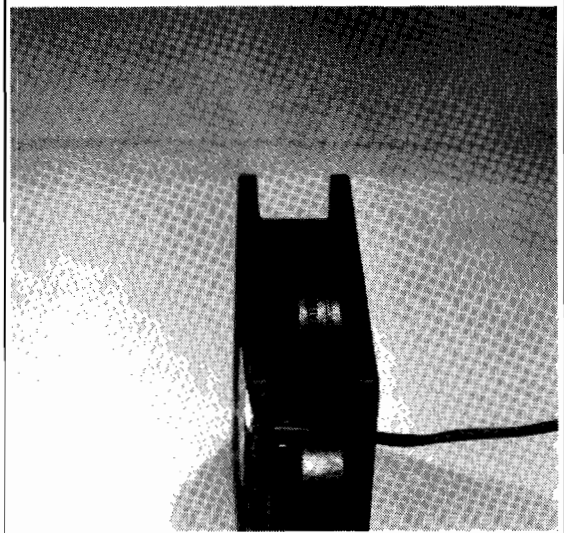

- 2** Install the fan with its wires at the top, arrow pointing out, and work it into its clips inside the fan well.

Then plug its wire connector into the one on the flexible backplane.

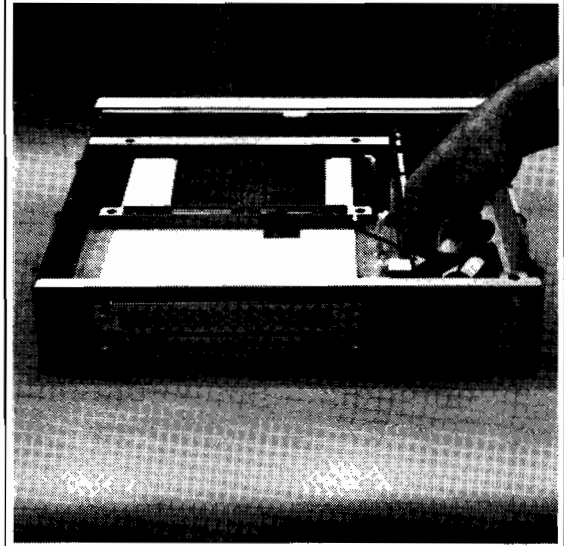

DIO-II Card Cage

Preliminary Requirements

Before you remove the DIO-II expander card cage:

1. Shut down the operating system.
2. Turn OFF the controller.
3. Remove all cables and cords attached to the controller.
4. If rack mounted, remove the units from the rack.
5. If an expander is attached, remove it.
6. Remove the top cover.
7. Unplug the fan wire from its flexible backplane connector.

Removal and Installation

Installing the DIO-II card cage is the reverse of removing it.

Follow these steps to remove the DIO-II card cage:

- 1** Remove the two screws on the backplane support bracket.

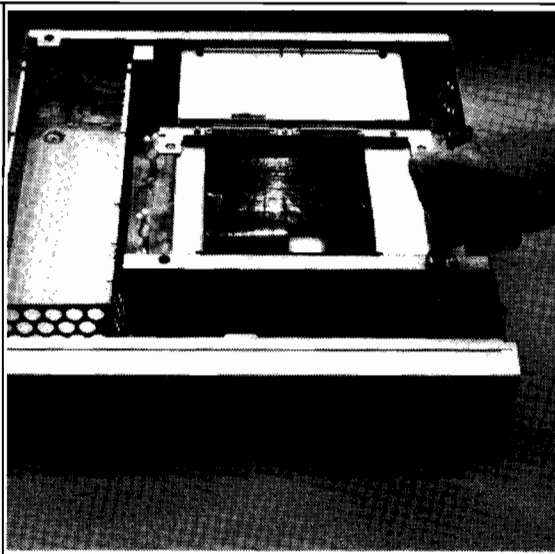

- 2** Remove the three screws holding the back of the card cage to the rear of the chassis.

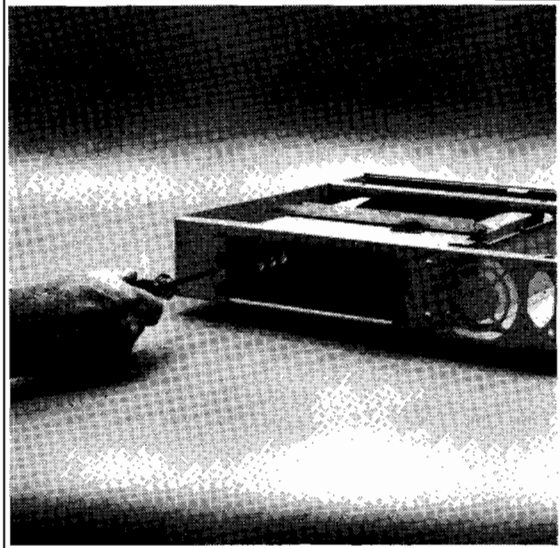

- 3** Lift the card cage out of the chassis, front end first.

Note the tabs on its bottom that fit into the slots in the chassis bottom.

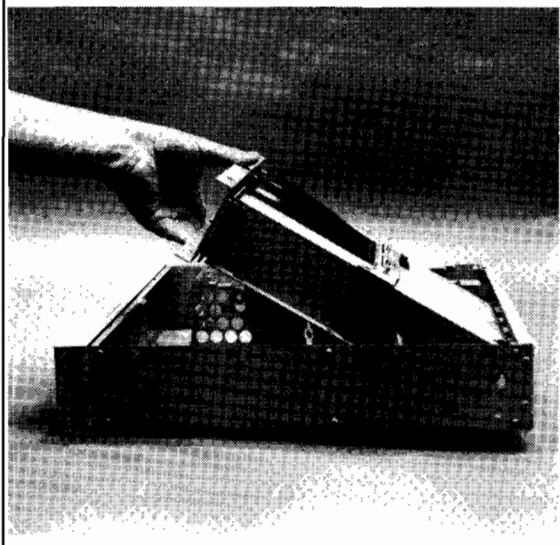

Flexible Backplane

Preliminary Requirements

Before you remove the expander's DIO-II flexible backplane:

1. Shut down the operating system.
2. Turn OFF the controller.
3. Remove all cables and cords attached to the controller.
4. If rack mounted, remove the units from the rack.
5. If an expander is attached, remove the expander.
6. Remove the:
 - a. Top cover.
 - b. DIO-II card cage.

Removal and Installation

Installing the flexible backplane is the reverse of removing it.

Follow these steps to remove the DIO-II flexible backplane:

- 1** Remove the three screws holding the bottom set of connectors to the cage.

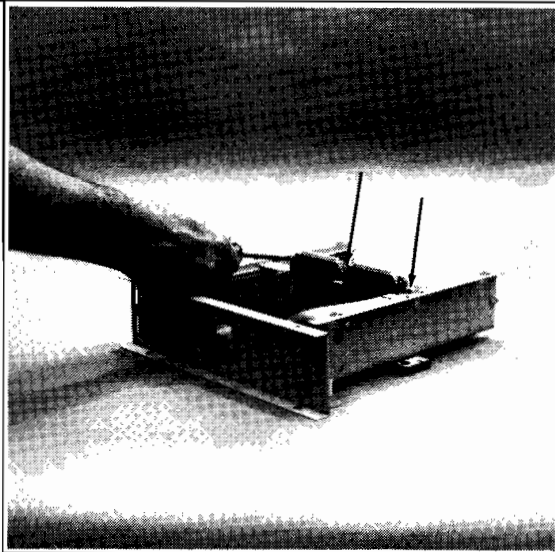

- 2** Remove the cross member by slightly spreading the sides of the cage apart.

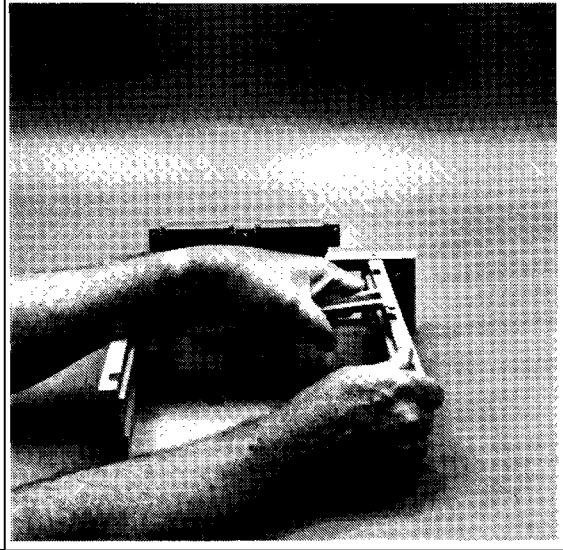

- 3** Then remove the three screws holding the top connector to the cage.
Set the metal bracket out of the way.

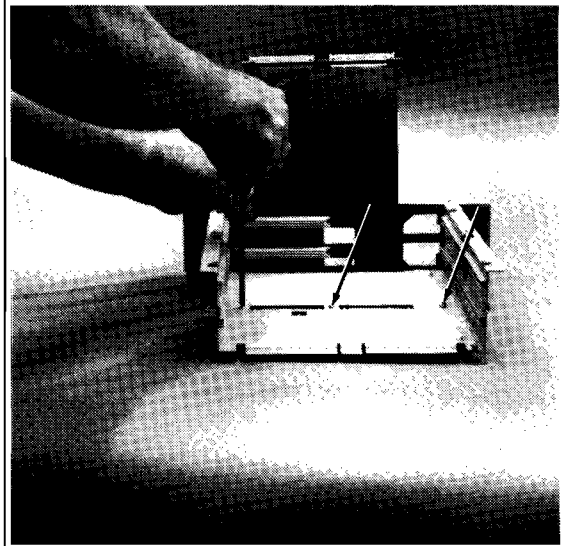

- 4** Remove the four screws on the support bracket holding the bracket to the cage, and sit the cage to the side.

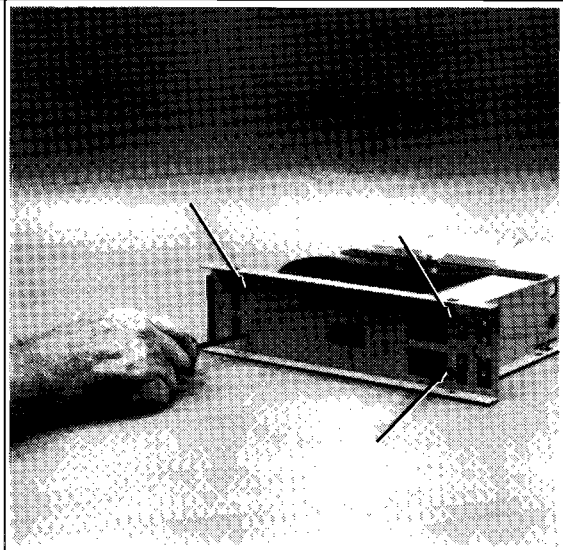

- 5** Turn the bracket on its face and remove the four screws holding the board to the bracket.

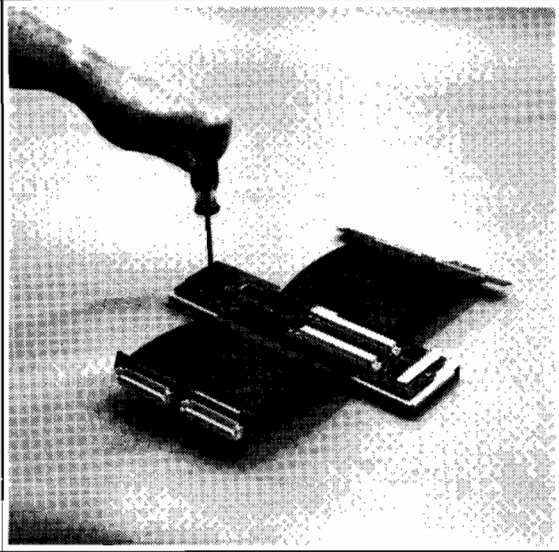

Functional Description

Overview

Model 362/382 controllers are compact and have these functional assemblies:

- Power supply.
- System board.
- RAM boards.
- LAN board.
- Backplane board.
- Mass storage devices.
- Fan assembly.



Figure 3-1 shows the relative positions of each functional assembly.

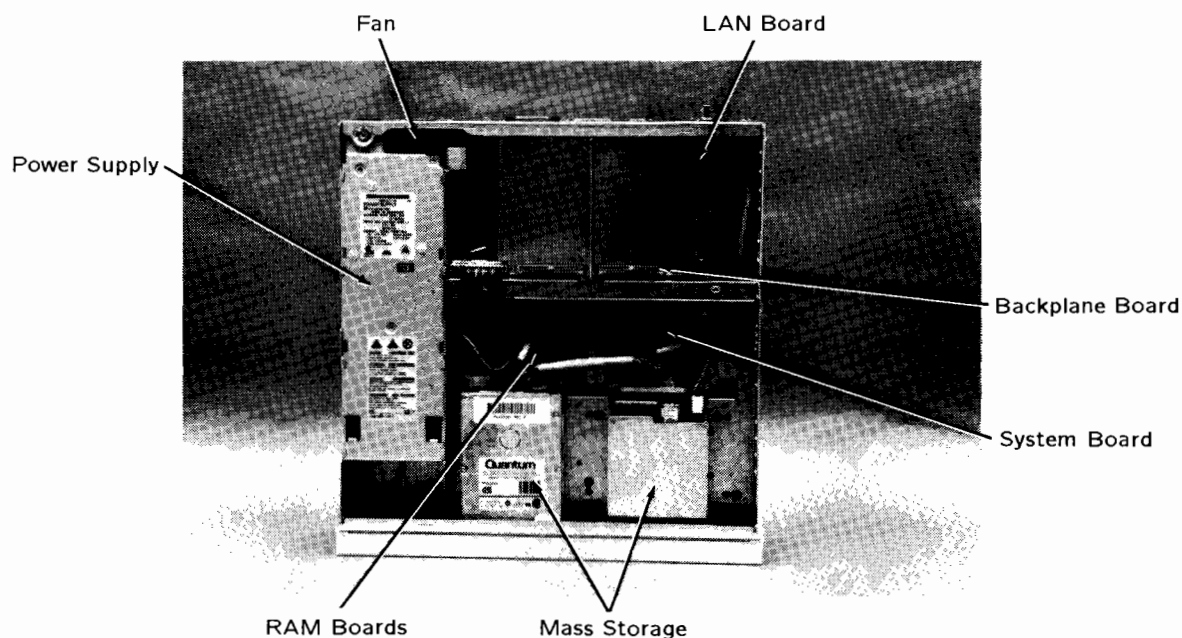

Figure 3-1. Model 362/382 Controller Functional Assemblies

Figure 3-2 is a block diagram of the functional assemblies.

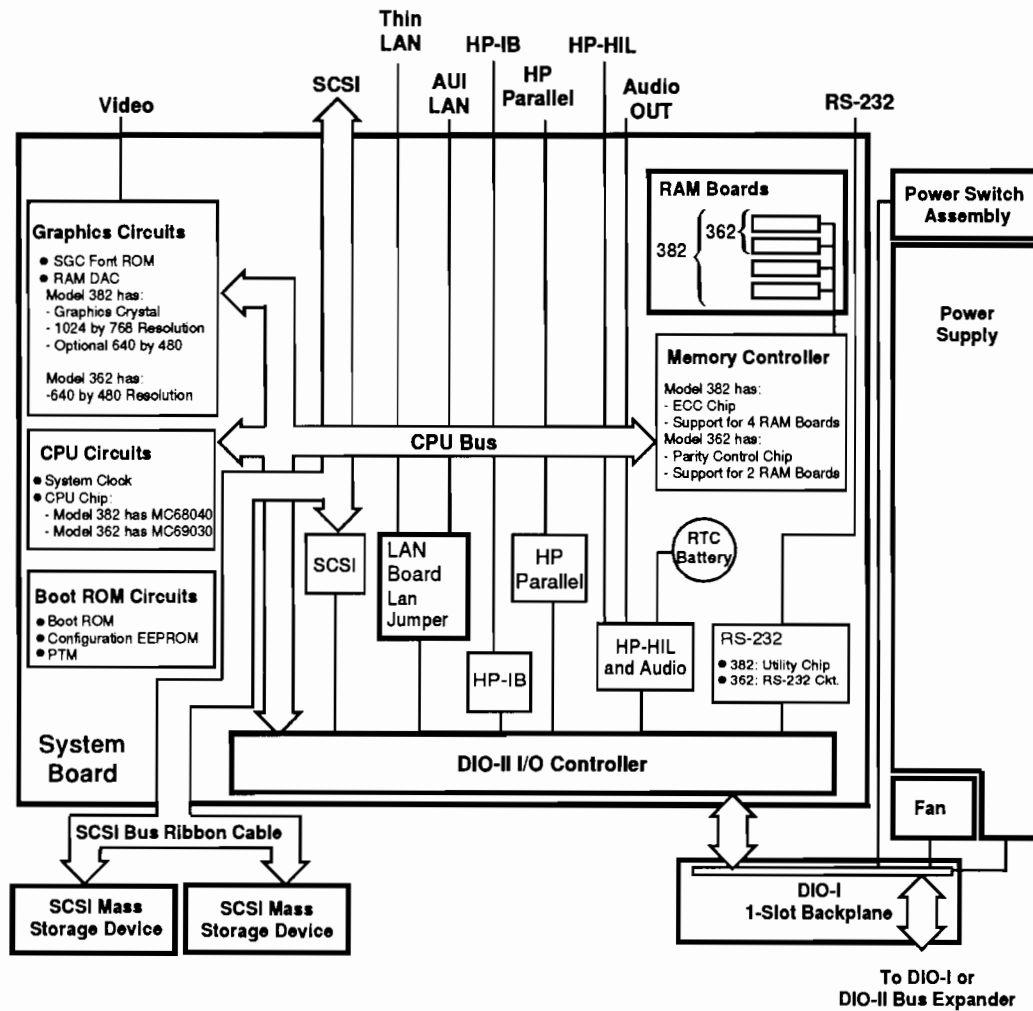

Figure 3-2. Model 362/382 Functional Block Diagram

Power Supply

The power supply is a sealed unit. If any one of its dc supplies fails, the entire power supply is replaced. No field replaceable fuse is provided. Figure 3-3 shows the power supply.

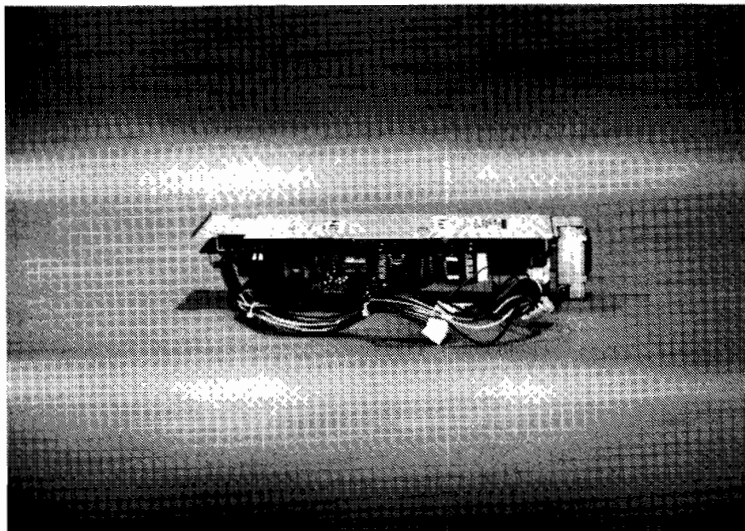

Figure 3-3. Power Supply

When the controller is plugged in, a +5 V dc auxiliary circuit is active. Its purpose is to sense the power switch on the LED/Switch board grounding one side of this circuit. When its remote on/off (ROO) circuit is grounded by the power switch being pushed ON, the switching circuits turn on and power the regulators.

Line voltage range is sensed by an auto-ranging circuit. Either 230 or 115 V ac line input is sensed and the auto-ranging circuit changes its configuration to supply the correct voltage to each voltage regulator.

Each distributed supply is made up in its own bridge network and voltage control circuits. Some dc supplies are tightly regulated for logic circuits on the system and memory boards, in addition to the mass storage devices. Other supplies are unregulated, such as that for the fan speed controller.

These supplies are provided and distributed:

- +5 V dc (regulated).
- +12 V dc (regulated).
- +5 V dc (regulated) for the SCSI interface circuit's active terminators and internal SCSI mass storage devices.
- +12 V dc (regulated) for the internal SCSI mass storage devices.
- -12 V dc (regulated) for the graphics and RS-232 circuits.
- +12 V dc (unregulated) for the fan speed controller.

A common ground connects all functional assemblies.

Refer to Chapter 6, the section on the power supply for voltage tolerances and test points.

A power distribution cable permanently attached to the power supply carries the required supplies to the:

- Backplane board through one 14-pin connector (the backplane board distributes power to the system board as well as the DIO slot).
- Hard disk and CD ROM drives through two 4-pin connectors.
- 3.5-in. flexible disk drive through one of the 4-pin connectors, then the flexible disk drive power cable to the drive.

The flexible disk drive has a different power connector than the other mass storage devices.

System Board

One system board is used in Model 362 controllers. It has a Motorola 68030 processor and low-resolution graphics with a pixel resolution of 640 by 480.

Two system boards are used in Model 382 controllers. Both have a Motorola 68040 and one of these graphics capabilities:

- Medium-resolution graphics with a pixel resolution of 1024 by 768.
- Low-resolution graphics with a pixel resolution of 640 by 480.

The system board has most of the controller's functions, which include circuits for the:

- CPU.
- Boot ROM.
- Graphics.
- Memory controller.
- DIO-II I/O controller, which controls these interface circuits:
 - SCSI.
 - LAN, both AUI and ThinLAN.
 - HP Parallel.
 - HP-IB.
 - HP-HIL.
 - Audio.
 - RS-232.

Figure 3-4 is a picture of the system board.

CPU Circuit

An MC68030 (Model 362) or MC68040 (Model 382) CPU chip is the heart of the CPU circuit. It executes instructions and controls the other circuits. A system clock crystal times most controller functions. A 32-bit CPU bus connects the CPU circuit to the graphics, memory controller and DIO-II I/O controller circuits.

3-4 Functional Description

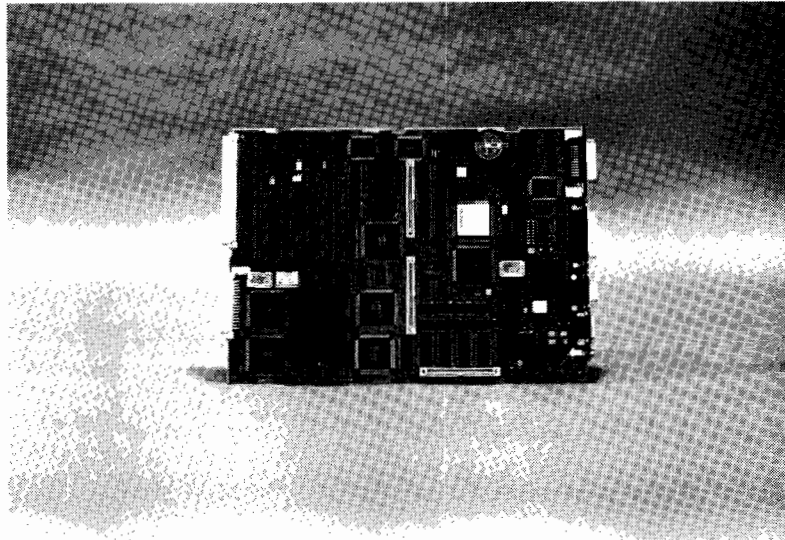

Figure 3-4. System Board

The CPU circuit has these functional features:

Table 3-1. CPU Functional Features

Function	Model 362	Model 382
Central Processor Type:	MC68030	MC68040
Clock Rate:	25 MHz	25 MHz
Integer Performance:	6 MIPS	22 MIPS
Floating-point Processor:	MC68882	Included
Floating-point Performance:	0.2 MFLOPS	2.4 MFLOPS

Data, status and control information for the CPU is transferred on the CPU bus with these circuits:

- DIO-II I/O Controller.
- Graphics Circuit.
- Memory Controller.

Boot ROM Circuit

The Boot ROM circuit has the Boot ROM containing 256 Kbytes of information required to:

- Start the CPU functions.
- Self-test the controller's main circuits.
- Search for and boot an operating system.
- Manage the internal interface configurations.

An EEPROM stores information for:

- Internal interface configurations.

A Program Timer Module contains the system clock. All controller timing is based on the system clock.

Because the Boot ROM circuit involves several important boot and configuration functions, they are explained in detail in:

- Chapter 4 for Boot ROM information.
- Chapter 6 for Troubleshooting information.
- Chapter 5 for Configuration information.

Graphics Circuit

A graphics circuit manages video information for the monitors. Two resolution levels are used. A low-resolution circuit which is compatible with VGA is available on both the Model 362 and the Model 382. A medium-resolution circuit is also available on the Model 382.

Graphics information is transferred on the graphics bus. Table 3-2 lists the graphics circuit technical information. Each graphics circuit type is described in the following subsections.

Low-Resolution Graphics

Low-resolution graphics has 4 Mbits of display RAM. Eight planes of memory provide 640 by 480 pixel resolution color information to the video connector on the rear panel. Red, green and blue video are supplied through a color video cable with three connectors that plug into color monitors. Although grayscale is not supported on Models 362/382, there is a monitor type jumper which selects either color or grayscale.

An SGC font ROM provides character shapes for display on monitors. A RAM Digital-Analog Converter (DAC) converts display RAM bits to an analog video signal. Video is sent to the video connector.

Table 3-2. Low-resolution Graphics Circuit Technical Information

Function	Data
Bus width:	Address 32 bits, Data - 32 bits
Bandwidth:	20 Mbytes/second
DMA channels:	2 dynamically assigned
Video signal:	VGA
Alphanumeric capacity:	80 characters by 30 lines
Character height and width:	2.24 mm by 4.48 mm
SGC Font ROM character set:	256
Character font:	6 by 14 char. in an 8 by 16 cell
Scan rate:	31.5 KHz
Video signal:	VGA

Medium-Resolution Graphics

Medium-resolution graphics have 6 Mbits of display RAM. Eight planes of memory provide 1024 by 768 pixel resolution color graphics information to the video connector on the rear panel. Red, green and blue video are supplied through a color video cable with three connectors that plug into color monitors. An SGC font ROM provides character shapes for display on monitors. No configuration switches are on the medium-resolution system board for graphics.

Both graphics circuits have two jumpers on the system board. One jumper disables the graphics circuit for use with a DIO graphics card. The other jumper selects between grey-scale and color. Note that although the Model 362/382 system boards are capable of producing grey-scale graphics, grey scale is not supported in them. Grey scale is only supported when the system board is used in some applications other than Models 362/382.

Memory Controller Circuit

Model 362 RAM Controller

Memory is managed by the memory controller circuit. Up to 16 Mbytes of RAM may be installed in the controller.

Two connectors each accept a RAM board of the Single Inline Memory Module type:

- 2 Mbyte RAM board.
- 4 Mbyte RAM board.
- 8 Mbyte RAM board.

The two slots for RAM boards are labeled RAM 0 and RAM 1. Each slot represent a memory block The first, or top memory block starts at address FFFFFFFF₁₆ and is the RAM board in slot RAM 0.

- Addresses FFFFFFFF₁₆ down through FF800000₁₆ are in slot RAM 0.
- Addresses FF7FFFFFFF₁₆ down through FF000000₁₆ are in slot RAM 1.

Table 3-3 lists the address range within each possible memory block for the Model 362 controller.

Table 3-3. Model 362 Controller RAM Addresses

Total RAM	Address Ranges Upper to Lower	HP D2152A 8 MB Boards	HP D2156A 4 MB Boards	HP D2381A 2 MB Boards
2 Mbytes	FFFFFFF - FFE00000	8 MB Block	4 MB Block	2 MB Block
4 Mbytes	FFDFFFF - FFC00000		4 MB Block	2 MB Block
6 Mbytes	FFBFFFF - FFA00000		4 MB Block	2 MB Block
8 Mbytes	FF9FFFF - FF800000		4 MB Block	2 MB Block
10 Mbytes	FF7FFFF - FF600000	8 MB Block	4 MB Block	2 MB Block
12 Mbytes	FF5FFFF - FF400000		4 MB Block	2 MB Block
14 Mbytes	FF3FFFF - FF200000		4 MB Block	2 MB Block
16 Mbytes	FF1FFFF - FF000000		4 MB Block	2 MB Block

Model 382 RAM Controller

Memory is managed by the memory controller circuit. Up to 32 Mbytes of RAM may be installed in the controller. An Error Checking and Correcting (ECC) chip checks memory word read/write operations. Both single-bit and double-bit errors are detected. If a single-bit error is detected, it will be corrected. Double-bit errors are detected but not corrected. Triple and quadruple bit errors are grouped in nybbles.

Four connectors each accept a RAM board of the Single Inline Memory Module type:

- 2 Mbyte RAM board.
- 4 Mbyte RAM board.
- 8 Mbyte RAM board.

The RAM boards must be installed in pairs.

The four slots for RAM boards are labelled 0A, 0B, 1A and 1B. Each pair represents a memory block. The first, or top memory block starts at address FFFFFFFF₁₆ and are the RAM boards in pair 0.

Table 3-4 lists the address range within each possible memory block for the Model 382 controller.

Table 3-4. Model 382 Controller RAM Addresses

Total RAM	Address Ranges Upper to Lower	HP A2202A 8 MB Boards	HP A2201A 4 MB Boards	HP A2200A 2 MB Boards
4 Mbytes	FFFFFFF - FFC00000	16 MB Block	8 MB Block	4 MB Block
8 Mbytes	FFBFFFFFF - FF800000		4 MB Block	
12 Mbytes	FF7FFFFFF - FF400000		8 MB Block	4 MB Block
16 Mbytes	FF3FFFFFF - FF000000		Not used	
20 Mbytes	FEFFFFFF - FEC00000	16 MB Block	8 MB Block	4 MB Block
24 Mbytes	FEBFFFFFF - FE800000		Not used	
28 Mbytes	FE7FFFFFF - FE400000		not used	Not used
32 Mbytes	FE3FFFFFF - FE000000		Not used	

DIO-II I/O Controller

All I/O operations are managed by the DIO-II I/O controller. Connected to the CPU bus, this controller handles interrupt and I/O functions for these system board interfaces:

- SCSI.
- LAN, both AUI and ThinLAN.
- HP Parallel.
- HP-HIL.
- HP-IB.
- Audio.
- RS-232.

SCSI Interface Circuit

The primary function of the SCSI interface circuit is to take data written in DIO-II format from the CPU bus, translate it to SCSI format, and transmit it down the SCSI bus to a mass storage device, and vice versa. A secondary function is to keep track of the status of the SCSI bus and inform the CPU of the status.

Model 362/382 controllers have space for two internal SCSI devices, and may have a rear-panel connector for attaching external devices. One space, or bay, has removable front-panel hardware for use with devices with removable media such as flexible disk drives. That bay is called the "Front Access Storage Bay". The other bay, called the "No Front Access Storage Bay", is intended for use with devices with non-removable media such as hard disk drives.

Model 362/382 controllers are equipped with either of two SCSI configurations:

- The “Internal” configuration includes a flat ribbon cable which connects the two internal device locations to the system board. There is no rear-panel SCSI connector.
- The “External” configuration includes a rounded shield cable which connects the two internal device locations and a rear-panel SCSI connector to the system board. A shielded, high-density connector is used on the rear panel.

If no SCSI configuration is specified in the order, the “Internal” cable will be used. There is an Upgrade Kit to allow “Internal” units to be upgraded for use with external devices.

Termination

SCSI circuits must have terminating resistors installed on them. Here is how the two configurations are terminated:

Internal Configuration. When using the Internal configuration, the device farthest away from the system board must be terminated. The other device, if present, must not be terminated. Note that if only one device is present, it should be placed in the Front Access Storage Bay (the right-hand location as you face the front of the unit) in order to minimize stub length.

External Configuration. When using the external SCSI configuration, you must use an active SCSI terminator at the last external device on the SCSI bus. All other devices, external or internal, must not be terminated. If your controller contains the external cable but you have no external devices, the terminator must be installed in the rear-panel SCSI connector. Use only HP K2291 terminators to ensure reliable system operation.

SCSI configuration is controlled by the Boot ROM’s Configure Mode after the Internal Interfaces mode is enabled and the SCSI Interface mode selected. Default SCSI configurations and allowable configurations are listed in Table 3-6. Refer to Chapter 5, for information on using Configure Mode. Recommended SCSI mass storage device bus addresses are listed in Table 3-5.

Table 3-5. Recommended SCSI Bus Addresses and Device Usage

Application	Unit or Mass Storage Device	Recommended Bus Address
High Use/Priority	CPU	7
	Root Internal Hard Disk Drive	6
	Most Used Hard Disk Drive	5
	Least Used Hard Disk Drive	4
Other devices	(varies)	3
Medium Use/Priority	CD ROM Disk Drives	2
	Tape drives	1
Low Use/Priority	Flexible Disk Drives	0

Table 3-6. SCSI Interface Default Configurations

Function	Default Configuration	Options
Select Code	14	0 to 31
Interrupt Level	3	3 to 6
CPU Address	7	0 to 7
Parity	Yes	No

SCSI interface technical information is listed in Table 3-7.

Table 3-7. SCSI Interface Technical Information

Function	Data
Type:	SCSI-I (ANSI X3.131-1986), single-ended
Data rate:	Synchronous - 4.5 Mbytes/second Asynchronous - 1.5 Mbytes/second
Device limits:	7; includes internal devices
Connector type:	50-pin high-density thumbscrew
Maximum cable length: (Internal plus external length, controller and all devices)	4.6 metres (15 feet)

Note Snap-on SCSI cable connectors should not be used. Hewlett-Packard only supplies screw-in SCSI cables.

LAN Interface Circuit

The LAN interface circuit is technically not a part of the system board, as it resides on a board which plugs into the system board. The LAN board is an optional item, and may not be in any particular system.

Local Area Network circuits use the Ethernet/IEEE 802.3 standard interface. A built-in media attachment unit (MAU) is part of the LAN board. The shared memory area has the memory controller circuits, 16 Kbytes of RAM, 64 nybbles of nonvolatile storage of the node address, and control, status, and ID registers. Multiplexing of CPU bus information and the LAN chip set is also part of the controller circuit. An insulator for the ThinLAN BNC connector is provided to protect data from grounding.

Frontplane circuits include the LAN chip set, timer, and the transceiver chip. The LAN chip set serves the dual function of a DMA controller and an Ethernet/IEEE 802.3 controller. Encoded data from the serial interface adaptor (SIA) is transmitted by the transceiver chip. Data from the network is sent by the transceiver chip to the SIA.

An AUI (attachment unit interface) connector enables connections to an external MAU. The MAU circuits used with the ThinLAN connector are not used. A replaceable fuse, located behind the AUI connector, protects the LAN circuits from MAU faults.

LAN configuration is controlled by the Boot ROM's Configure Mode after the Internal Interfaces mode is enabled and the LAN Interface mode selected. Default LAN configurations and allowable configurations are listed in Table 3-8. Refer to Chapter 5 for information on using Configure Mode.

Table 3-8. LAN Default Configurations

Function	Default Configuration	Options
Select Code	21	0 to 31
Interrupt Level	5	3 to 6

The LAN interface circuit connects to two LAN connectors. A jumper, located next to the AUI LAN connector on the LAN board selects one of the LAN interfaces for use:

- MAU circuits connect to the rear panel's BNC "T" connector, then connects directly to the external LAN coaxial cable. These circuits are enabled when the LAN jumper is in the 'ThinLAN' position.
- AUI circuits connect the rear panel's 15-pin connector; an external MAU is required. These circuits are enabled when the LAN jumper is in the 'AUI LAN' position.

LAN jumper positions are shown in Figure 3-5.

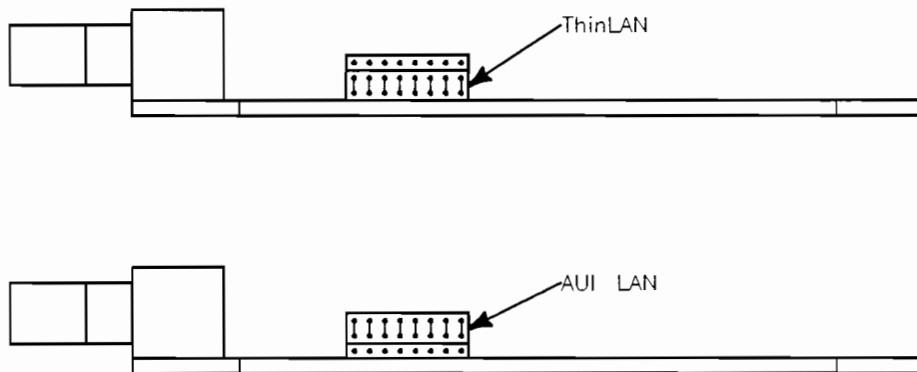

Figure 3-5. LAN Board Jumper Positions

The LAN interface technical information is listed in Table 3-9.

Table 3-9. LAN Interface Technical Information

Function	Data
Type:	IEEE 802.3, Ethernet 1.0
Data rate:	10 Mbits/second
Connector types:	ThinLAN - BNC AUI LAN - 15-pin
MAU types:	10BASE 2 on system board 10BASE 5 requires HP 30241A 10BASE T requires HP 28685A

HP Parallel Interface Circuit

In common with many personal controllers, the HP Parallel interface circuit uses a Centronics® interface standard. It provides an interface with external devices. Using an 8-bit direct memory addressing routine, up to 300 Kbytes per second transfer rates may be achieved. The HP Parallel interface circuit connects to the HP Parallel connector on the connector board.

HP Parallel configuration is controlled by the Boot ROM's Configure Mode after the Internal Interfaces mode is enabled and the HP Parallel Interface mode selected. Default HP Parallel configurations and allowable configurations are listed in Table 3-10. Refer to Chapter 5 for information on using Configure Mode.

Table 3-10. HP Parallel Interface Default Configurations

Function	Default Configuration	Options
Select Code	12	0 to 31
Interrupt Level	3	3 to 6

Technical information for the HP Parallel interface is listed in Table 3-11.

Table 3-11. HP Parallel Interface Technical Information

Function	Data
Type:	Centronics™, ACK, BUSY and HP ScanJet handshakes.
Data rate:	>300 Kbytes/second
Device limit:	1
Connector type:	25-pin female; PC standard

HP-HIL Interface Circuit

An Hewlett-Packard Human Interface Link (HP-HIL) is used for interfacing the controller to human input devices. Asynchronous serial communications protocol enables you to select a set of input devices, connect them to your controller, and work with many application programs.

A link control circuit controls the HP-HIL interface. Each HP-HIL device has an circuit to interface information to and from that device.

Limitations for the HP-HIL interface are:

- Up to seven devices can be on the link.
- Maximum distance between devices is 2.4 metres, total link maximum length is 16.8 metres. This does not include the 15 or 30 metre extensions.
- Maximum link current is 1 A.

Caution When configuring HP-HIL devices to Model 362/382 controllers, care must be used to ensure the total power drawn by all devices does not exceed 1 A.

Either of two keyboards connect to the rear panel HP-HIL connector:

- HP 46021A Integrated Terminal Format (ITF) Keyboard
- HP 98203C Keyboard

The HP 98203C Keyboard is supported only with the Basic operating systems.

HP-IB Interface Circuit

Hewlett-Packard Interface Bus (HP-IB) is HP's version of the IEEE 488 interface standard. HP-IB on this board is much like HP-IB implementations on other HP 9000 Series 200/300 controllers. It uses a TMS9914 HP-IB controller which allows data transfer rates up to 450 Kbytes/second. The TMS9914 is a memory-mapped I/O device which is multiple-mapped within a 64 Kbyte internal I/O device.

Two registers control hardware which can generate an interrupt as a result of a HP-IB device responding to a parallel poll. It has the ability to generate an interrupt from a parallel poll response. For this feature, two registers external to the TMS9914 are used. These registers are in addition to the two external registers that exist for internal HP-IB interfaces in other Series 200 controllers.

All registers associated with the HP-IB are multiple mapped within a 64 Kbyte block of memory in the internal I/O address range.

One configuration switch for HP-IB system controller is on the system interface board. Located on the HPIB/RS-232 configuration switch block, the SC switch is set to 1 if the controller is the system controller or 0 if not.

Information on the TMS9914A and its registers can be found in the *TMS9914A General Purpose Interface Bus (GPIB) Controller Data Manual*.

Audio Interface Circuit

Models 362/382 contain an audio output capability. Audio output is supplied to an internal speaker as well as a jack on the rear panel. Here are the specifications of the audio out:

Table 3-12. Audio Output Technical Information

Function	Data
Frequency range:	81.46 Hz to 83.3 KHz
Resolution:	Capable of approx. chromatic scale over 5 octaves
Duration:	0.01 sec to 2.55 sec/tone

RS-232 Interface Circuit

Model 362 RS-232 Interface

An RS-232 Interface section is part of the system interface board's electronics. Using an INS8250 UART, it's almost identical to the HP|t98644A RS-232 Serial Interface Card. It differs from the HP|t98644A Interface Card in that it:

- .bullet Allows interrupts at level 5 only. There are no switches to change the interrupt level is the same as the HP 98644 Card.
- .bullet Permanently sets the select code to 9. The HP 98644 card has switches which allow this address to be changed.
- .bullet Does not allow reconfiguration to change the RS-232's ID to that of the HP 98626 card.
- .exit

In addition to the registers built into the INS8250 UART, two external register have also been implemented. Both sets of registers are multi-mapped within a 64 Kbyte region of memory associated with I/O select code 9.

The RS-232 circuit connects to a 25-pin connector on the rear panel. Although this connector has the 25-pin configuration, it cannot be used with the external RS-232 multiplexer.

Model 382 RS-232 Interface

A utility chip is the center of the RS-232 serial interface circuit. It is connected to a 25-pin connector on the rear panel. When used with the external RS-232 multiplexer, three separate RS-232 connectors are provided.

Terminals cannot be used with Model 362/382 controllers. The utility chip does not provide for use with a terminal.

Unlike other RS-232 interface circuits in other Series 300 or Series 400 controllers, its configurations cannot be changed; neither by switches or in Configure Mode under Boot ROM control. Factory RS-232 configurations are fixed at:

- Select code 41.
- Interrupt level 3.

Table 3-13 lists technical information for the RS-232 interface.

Note Technical information listed herein should not be interpreted as specifications. Official specifications are listed in the HP 9000 Model 362/382 Technical Data Sheet.

Table 3-13. RS-232 Interface Technical Information

Function	Data
Type:	RS-232-C
Data rate:	19,200 bps
Device limit:	1 per interface connector
Connector type:	9-pin male

Another part of the RS-232 circuit is the Real-Time Clock (RTC). When the controller is turned off, a replaceable lithium battery powers the clock.

Warning Lithium batteries may explode if mistreated. Do not put lithium batteries in fires, try to recharge or disassemble them.

Replace battery with only a Matsushita Electric BR-2325 three-volt lithium battery (HP part number 1420-0314)! Use of any other battery may cause fire or explosion.

RAM Boards

Models 362 and 382 use different RAM boards. The boards used in each model are incompatible with the other model. The Model 362 uses PC-style RAM and the Model 382 uses the same RAM as the Model 425e.

Although different and incompatible, the two RAM types are physically similar. They are both of the SIMM configuration, and will physically fit in both models. They will not function, however, when installed in the wrong model.

Figure 3-6 shows a typical RAM board.

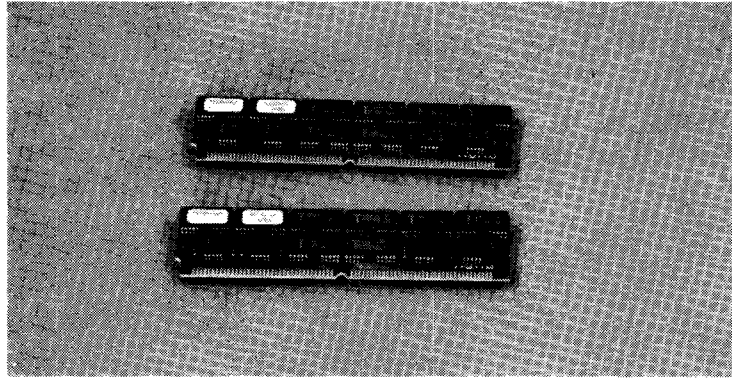

Figure 3-6. RAM Board

Model 362 Memory

Standard memory for Model 362 controllers is two Mbytes. Three RAM board upgrades include RAM boards as follows:

- HP D2381A; one 2 Mbyte RAM board which adds a 2 Mbyte block of memory.
- HP D2156A; one 4 Mbyte RAM board which adds a 4 Mbyte block of memory.
- HP D2152A; one 8 Mbyte RAM board which adds an 8 Mbyte block of memory.

RAM boards must be installed meeting these requirements:

- Slot RAM 0 must have a RAM board installed in it, and it must be the largest size RAM board.
- If there is a board in slot RAM 1 it must be equal to or smaller than the board in slot RAM 0.

Table 3-14 lists all supported RAM board configurations for the Model 362 controller.

Table 3-14. Total RAM vs. Slot Numbers and Board Sizes

Total Memory	Slot RAM 0	Slot RAM 1
2 MBytes	4 MB	
4 MBytes	2 MB	2 MB
4 MBytes	4 MB	
6 MBytes	4 MB	2 MB
8 MBytes	8 MB	
8 MBytes	4 MB	4 MB
10 MBytes	8 MB	2 MB
12 MBytes	8 MB	4 MB
16 MBytes	8 MB	8 MB

Model 382 Memory

Standard memory for the Model 382 controller is either 8 Mbytes or 16 Mbytes.

Three RAM board upgrades include RAM boards as follows:

- HP A2200A; two 2 Mbyte RAM boards that add a 4 Mbyte block of memory.
- HP A2201A; two 4 Mbyte RAM boards that add an 8 Mbyte block of memory.
- HP A2202A; two 8 Mbyte RAM boards that add an 16 Mbyte block of memory.

RAM boards must be installed meeting these requirements:

- Boards must be installed in pairs; each board in the pair must be the same size.
- Slots 0A and 0B must have the largest size RAM board pair.
- Slot 1A and 1B boards must be equal to, or smaller than boards in slots 0A and 0B.

Table 3-15 lists all supported RAM board configurations for Model 382 controllers.

Table 3-15. Total RAM vs. Slot Numbers and Board Sizes

Total Memory	Slots 0A & 0B	Slots 1A & 1B
8 MBytes	4 MB 4 MB	
8 MBytes	2 MB 2 MB	2 MB 2 MB
12 MBytes	4 MB 4 MB	2 MB 2 MB
16 MBytes	8 MB 8 MB	
16 MBytes	4 MB 4 MB	4 MB 4 MB
20 MBytes	8 MB 8 MB	2 MB 2 MB
24 MBytes	8 MB 8 MB	4 MB 4 MB
32 MBytes	8 MB 8 MB	8 MB 8 MB

Refer back to the section titled 'Memory Controller Circuit' for memory mapping and addressing information.

Backplane Board

The backplane board connects to the system board and receives DIO-II signals from it. It provides DIO-II signals to a pair of connectors which the DIO and DIO-II expanders connect to. It also provides DIO signals to a single DIO slot located in the rear panel.

The backplane board has a connector which the power supply cable connects to. It then passes power to the system board through the system board connectors.

The backplane board also contains these miscellaneous connectors:

- The power switch connector.
- The fan connector.
- A connector for an unspecified future use.

Figure 3-7 shows the backplane board.

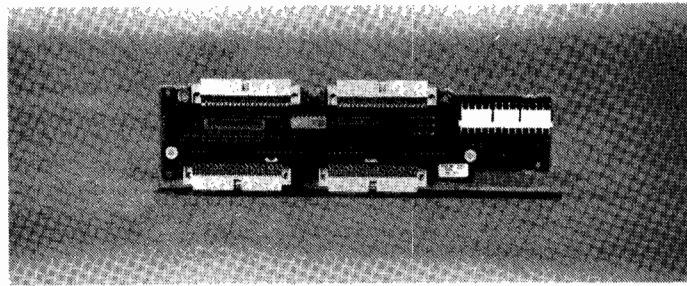

Figure 3-7. Controller DIO-I Backplane Board

Hard Disk Drives

Several hard disk drives are available for installation in Models 362-382. They are available both as an option at original purchase or as a separate product for upgrading the unit at a later date. Here is a chart with the specific information:

Table 3-16. Models 362/382 Hard Disk Drive Summary

Capacity in Megabytes	Option Number	Upgrade Product Number
52	AMR	HP A2257A
210	AMS	HP A2258A
420	AMT	HP A2259A

All hard disk drives are random access mass storage devices that contain a 3.5-inch nonremovable disk media. They use a rotary actuator to move read/write heads over the media. Read/write heads are used for reading data from and writing data to the disk. The heads also read embedded servo information on the data tracks to maintain head alignment during changes in operating temperature.

Figure 3-8 shows a hard disk drive. Each looks practically the same and differs only in the numbers of disks and heads.



Figure 3-8. Hard Disk Drives

Each hard disk drive has an attached controller PC board with a single-ended Small Controller System Interface (SCSI) interface.

52 Mbyte Hard Disk Drives

Here is the capacity and formatting information for the 52 MByte disk drive:

Table 3-17. 52 MByte Disk Drive

Formatted Capacity in Bytes	Track Density	Data Tracks	Max. Record Density	Heads Per Unit
52,000,000	1,330 tpi	2,438	29,307 bpi	2

Note Technical information listed herein should not be interpreted as specifications. Official specifications are listed in the HP 9000 Series 300 Model 362/382 Technical Data Sheet.

Performance

Data Transfer Rates.

Synchronous:	4.0 Mbytes/second
Asynchronous:	2.0 Mbytes/second

Maximum Error Rates.

Soft read errors:	10 errors per 10^{11} bits read
Defect read errors:	10 errors per 10^{13} bits read
Unrecoverable data errors:	10 errors per 10^{15} bits read
Seek errors:	10 errors per 10^7 seeks

Seek Times.

Average seek time, including settling:	\17 ms
Single-track seek:	5 ms
Full-stroke seek:	33 ms

Environmental Requirements

Ambient Temperature.

Operating:	4°C to 50°C (39°F to 122°F)
Non-operating	-40°C to 65°C (-40°F to 140°F)

Altitude.

Operating:	Maximum 4 572 metres (15,000 ft.)
Non-operating:	Maximum 12 000 metres (40,000 ft.)

Ambient Relative Humidity.

Operating:	8% to 85% (noncondensing)
Non-operating:	5% to 95% (noncondensing)

210 Mbyte and 420 Mbyte Hard Disk Drives

Here is the capacity and formatting information for the 210 and 420 MByte disk drives:

Table 3-18. Hard Disk Drive Formatted Capacity

Hard Disk Drive	Formatted Capacity in Bytes	Track Density	Data Cylinders	Spare Sectors Cylinder	Max. Record Density	Heads Per Unit
HP A2258A	209,000,000	1,695 tpi	1,520	2	37,146 bpi	7
HP A2259A	422,000,000	1,695 tpi	1,520	2	37,146 bpi	9

Note Technical information listed herein should not be interpreted as specifications. Official specifications are listed in the HP 9000 Series 300 Model 362/382 Technical Data Sheet.

Performance

Buffer to SCSI Bus Data Transfer Rate.

Synchronous burst: 5.0 Mbytes/second
Asynchronous burst: 4.0 Mbytes/second

SCSI Bus to Buffer Data Transfer Rates.

Inner zone: 1.53 Mbytes/second
Outer zone: 2.71 Mbytes/second

Maximum Error Rates.

Soft data: 10 errors per 10^{11} bits read
Hard data: 10 errors per 10^{13} bits read
Unrecoverable data: 10 errors per 10^{15} bits read
Miscorrection: 10 errors per 10^{20} bits read
Seek: 10 errors per 10^7 seeks

Functional.

Average spin-up time from start of spin-up to ready for access:	\20 seconds
Rotational speed:	3,605 RPM \pm 0.03%
Average seek time, including settling:	\14 ms
Single-track seek:	4 ms
Third-stroke seek:	15 ms
Full-stroke seek:	27 ms
Average rotational latency:	8.3 ms
Sequential head switch:	4 ms

Environmental Requirements

Ambient Temperature.

Operating:	4°C to 50°C (39°F to 122°F) 10°C/hr (18°F/hr gradient)
Non-operating	-40°C to 65°C (-40°F to 140°F) 20°C/hr (36°F/hr gradient)

Altitude.

Operating:	Minimum -61 metres (-200 ft.) Maximum 3 000 metres (10,000 ft.)
Non-operating:	Minimum -61 metres (-200 ft.) Maximum 12 000 metres (40,000 ft.)

Ambient Relative Humidity.

Operating:	20% to 80% (noncondensing)
Non-operating:	8% to 85% (noncondensing)
Maximum wetbulb temperature:	26°C (79°F)

CD ROM Disk Drive

Your HP A2253A CD ROM Drive is a random access read-only mass storage device that uses removable CD ROM disks. A semi-conductor laser is used for reading data optically. Controller data is sent from the drive through a single-ended Small Controller System Interface (SCSI). An audio jack on its front panel accepts a standard 3.5mm miniature stereo headphone jack for optional listening to audio compact discs. The drive has configuration jumpers for setting the device SCSI bus address, parity and eject mode.

Figure 3-9 shows a CD ROM disk drive.

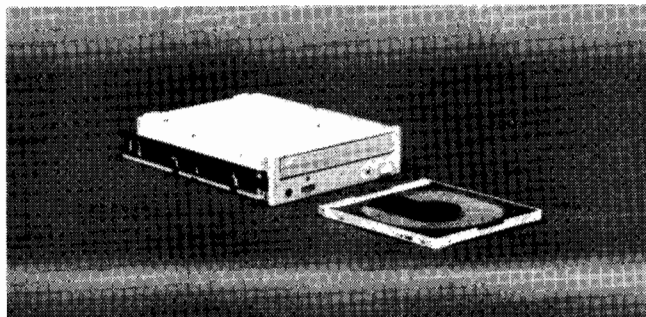

Figure 3-9. CD ROM Disk Drive

Caution

Do not open the shutter manually. Opening the shutter will expose the disk's data surface to dust and damage. If the data surface gets too much dust or damage, its readability by the laser read head will be reduced.

CD ROM disks are identical to audio compact discs except they store controller data. Both audio compact discs and CD ROM disks may be used in the drive. Disks are 120 mm (4.7-in.) in diameter and use one data surface. Up to 599 Mbytes of data or 74 minutes of audio can be stored on a disk. Pits and flat spots are arranged in a spiral track on the data surface. A laser beam is reflected off of the pits and spots as they are rotated at a constant speed. These reflections are decoded as digital data. Data is sent out on the SCSI interface for use in your controller. In audio mode, the digital data is converted to analog information and supplied to the headphone jack.

A rigid plastic caddy holds and protects the disk. The caddy with installed disk is inserted into the disk port and data is read through a shutter in the caddy. When you eject the caddy, the shutter closes to protect the disk's data surface.

Extra disk caddies are available by ordering part number C2293-80001.

Most Hewlett-Packard CD ROM software comes in a 'jewel case' like the audio compact discs are packaged in. You must remove the CD ROM from the jewel case and insert it into the caddy before you use it in your CD ROM drive.

Caution

The HP A2253A CD ROM Drive's disk caddy is not interchangeable with the HP C1707A CD ROM Drive's disk caddy. You can exchange the CD ROMs between these caddies. Refer to your controller's *Owner's Guide* for instructions.

Model 362/382 controllers with a CD ROM drive will properly function if the controller is oriented with:

- Top of controller up.
- Right side of controller up.

Note CD ROM drives are only supported with the HP A2256A SCSI External Interface Upgrade installed. If no external SCSI devices are used in the system, a terminator must be plugged into the rear panel SCSI connector.

Technical Information

Note Technical information listed herein should not be interpreted as specifications. Official specifications are listed in the HP 9000 Model 362/382 Technical Data Sheet.

Controller Data Transfer Rate (asynchronous)

Average:	153 kilobits/second
Maximum:	1400 kilobits/second

Access Time (including latency)

Track-to-track:	1 ms
Average random:	350 ms
Maximum:	700 ms

Functional

Load time:	6 seconds
Unload time:	3 seconds
Motor spin-up time:	1 second
Rotational speed ¹	530 to 200 rpm

¹ Decreases from inner track diameter to outer track diameter to maintain constant linear velocity at read head.

Media

Diameter:	120 mm (4.7-inches)
Number of read surfaces:	1
Data format type:	<i>Yellow Book</i>
Data capacity Mode 1:	599 Mbytes
Data capacity Mode 2:	683 Mbytes
User data per block mode 1	2,048 bytes
User data per block mode 2	2,336 bytes
Blocks per disk	292,500
Maximum audio playing time:	74 minutes (approximately)

Environmental Requirements

Temperature.

Operating:	5°C to 45°C (41°F to 113°F)
Non-operating	-10°C to 65°C (14°F to 149°F)

Altitude.

Operating	Minimum -305 metres (-1000 ft.) Maximum 12 500 metres (41,600 ft.)
Non-operating	Minimum -305 metres (-1000 ft.) Maximum 12 500 metres (41,600 ft.)





Boot ROM Functions

Boot ROM Functions

A Series 300 Boot ROM, Revision 3.X, is used in Model 362/382 controllers. Series 300 Boot ROMs are differentiated by the leading digit. A Revision 3.X boot ROM has different functionality than a Revision 2.X boot ROM. The numbers following the decimal point do not indicate different functionality. A Revision 3.01 boot ROM contains the same functionality as a Revision 3.0 boot ROM.

The Boot ROM is on the system board. When the controller is turned on, these Boot ROM instruction sets are executed by the CPU:

- Power-Up Sequence.
- Configure Mode. Configuring the controller's internal I/O and operating system selection information may be found in Chapter 5.
- Test Mode.
- Booting the Operating System.

Power-Up Display

When you turn your controller ON after the first time, the Boot ROM invokes the power-up display and starts its self-test. The Power-Up Display looks something like this with disks having bootable operating systems listed:

Copyright 1991	:QUANTUM PD210S, 1406, 0
Hewlett-Packard Company.	1H SYSHPUX
All Rights Reserved.	1D SYSDEBUG
	1B SYSBACKUP
BOOTROM Rev. 3.XX 2 MAY 91	1S SYSTEST
MC680X0 Processor	:LAN, 21, 0800090274A2 hostname
Configuration EEPROM	2H SYSHPUX
Utility Chip at 41	2D SYSDEBUG
HP-HIL.Keyboard	2B SYSBACKUP
HP-IB	
DMA-CO	
RAM xxxxxxx Bytes	
HP 98644 (RS-232) at 9	
HP PARALLEL at 12	
HP98265 (SCSI S 32) at 14	
HP98643 (LAN) at 21, THIN, 0800091XXXXX	
Bit Mapped Video at 132 (Console)	
System Search Mode	
RESET To Restart, SPACE clears input	Select System, type RETURN

Figure 4-1. Typical Power-Up Display

Note that information about the controller's internal functions is listed in the left-hand column, and information about systems available for booting is listed in the right-hand column. The systems information will vary from this figure, depending on which systems are accessible.

Power-Up Sequence

When the controller is turned on the CPU executes a power-up sequence of events before an operating system is booted. This is required to initialize and test hardware to make sure the controller is ready to boot an operating system. Power-up sequence is shown below.

1. Test the CPU chip.
2. Turn on test LEDs.
3. Determine processor type.
4. Initialize and test system/processor board timer.
5. Load configuration data from EEPROMs.
6. Reset all I/O.
7. Initialize the video circuits.
8. Display copyright notice.
9. Checksum the Boot ROM.
10. Display the Revision banners for Boot ROM
11. Display CPU type.
12. Display EEPROM status.
13. Test utility chip (RS-232).

4-2 Boot ROM Functions

14. Initialize audio I/O.
15. Initialize HP-HIL (keyboard) electronics.
16. Drop Interrupt level.
17. Preload for main RAM test.
18. Test DMA.
19. Test remaining RAM and set up bottom of memory.
20. Report any memory failures and the amount of memory found.
21. Find and report built-in interface circuits.
22. Test SCSI interface.
23. Test LAN interface.
24. Display LED code for boot mode selection type.
25. Output final LED value.

Human Interfaces

Several devices can act as the “console”, or primary human interface, for the Boot ROM. The list of possible console devices is explained in this section.

Output Devices

A bit-mapped video/graphics circuit on the system board is the only output device. Its address is in the range 20000000₁₆ to 2C000000₁₆ for SGC slots 0 through 3.

Input Devices

Normal input devices include the HP 46021A ITF and HP 98203C Keyboards. Keyboards may be directly connected to the HP-HIL interface port. Note that if the HP-HIL circuit fails, then it is considered to be “not present”. For example, if it fails, a “Keyboard Failed” message will be displayed. The Boot ROM always tests a device before choosing it as the console input device.

If the output device fails, but a keyboard is present, then that keyboard will still act as the console input device. If neither an input device nor an output device is present and working, the Boot ROM will go ahead and automatically boot the default operating systems as long as no errors are discovered during self test.

Booting Over the LAN

LAN interfaces are identified by its product number or circuit equivalent, then (LAN) then the select code, and link address of the interface as:

```
HP98643 (LAN) at 21, THIN, 0800091595F3
```

If a failure is detected in the power-up test, the following failure message will be displayed:

```
HP98643 (LAN) at 21, THIN, 0800091595F3 Failed
```

This shows that one of the internal tests on the interface failed. The tests include register operations, shared RAM, non-volatile RAM checksum and several different internal loopback tests.

If extended testing is selected from the Test Menu, the LAN interface is subject to the normal testing plus external loopback tests. Error messages listed in Table 4-1 may be displayed below the LAN identification message.

If no servers respond to the Boot ROM's attempts to initiate a boot session then the user will see no other indication of LAN activity. For each server that responds, display will show :LAN, followed by the select code, followed by its Link Address and server name. Under this will appear the list of systems provided by that server as shown in the following example:

```
:LAN, 21, 080009000008 hostname
  1H SYSTEM_HPUX
  2B SYSTEM_BKUP
```

Table 4-1. LAN Boot Errors

Error Message	Meaning
No Server	(M_FOPEN only) The server did not respond to a boot request.
Not Ready	(M_FOPEN or M_READ) LAN hardware power-up or reset failed, or M_FOPEN was called without calling M_INIT, or M_READ was called without calling M_FOPEN.
Read Error	For M_FOPEN, the open operation worked but the server has since then failed to respond to a read request or the server sent eof. For M_READ, the server failed to respond to a read request or the server sent eof.
Bad Hardware	(M_FOPEN or M_READ) the LAN hardware failed to respond to some operation or reported a catastrophic error.
Bad State	(M_FOPEN or M_READ) damaged bootROM code.

If a system calls the Boot ROM to boot/re-boot a system and a file name is specified and the mass storage unit specifier (msus) is for LAN, the Boot ROM will retry indefinitely to contact the server at the given link address. All other devices have a fixed number of retries/timeout and will report 'No Medium or System Not Found.'

Normal Power-Up Displays

At the first power-up after installation of a new controller, one of these situations should happen:

- This Configuration Control Main Menu will appear in the upper right-hand corner. If it does, you may continue configuring your controller by referring to the section titled Using Configure Mode.

```
Configuration Control
Keys Control Class
-----
1 I/O Configuration
2 Boot Mode Selection

A Abort without changes
-----
Type [key] RETURN ?
```

Note that the HP 98203C keyboard has an **Enter** key instead of a **Return** key.

Each is signified in this manual by **Enter**/**Return**. This means to use whichever key your particular keyboard has.

The controller will reset and the Configure Mode Main Menu should appear in the display's upper right-hand corner. Go on to the section titled Using Configuration Control Mode to continue configuring your controller.

Power-Up Display

```
Copyright 1991                               :QUANTUM PD210S, 1406, 0
Hewlett-Packard Company.                     1H SYSHPUX
All Rights Reserved.                         1D SYSDEBUG
                                              1B SYSBCKUP
                                              1S SYSTEST
BOOTROM Rev. 3.XX  2 MAY 91
MC680X0 Processor                             :LAN, 21, 0800090274A2 hostname
Configuration EEPROM                           2H SYSHPUX
Utility Chip at 41                             2D SYSDEBUG
HP-HIL.Keyboard                               2B SYSBCKUP
HP-IB
DMA-CO
RAM xxxxxxx Bytes
HP 98644 (RS-232) at 9
HP PARALLEL at 12
HP98265 (SCSI S 32) at 14
HP98643 (LAN) at 21, THIN, 0800091XXXXX
Bit Mapped Video at 132 (Console)

System Search Mode
RESET To Restart, SPACE clears input          Select System, type RETURN
```

Figure 4-2. Power-Up Display

Operating systems listed in the upper right-hand corner will only appear if the controller has a mass storage device or is installed as a diskless node on the LAN. The systems information will vary from this figure, depending on which systems are accessible.

Boot ROM Self-Tests

When the controller first powers up, the CPU starts executing Boot ROM code. Before code is executed to boot an operating system, several things need to be set up and tested. The Boot ROM has several code segments to manage these responsibilities.

Complete information on these tests can be found in Chapter 6.

Hardware Initialization Support

Some hardware, such as video circuit initialization which can not wait for a system to be booted, must be initialized at power-up as soon as possible to prevent improper operation.

Go/No-Go Self-Test Support

The primary objective is to tell the user that the controller is okay. This consists of indicating all such devices present and reporting all detectable failures.

Boot ROM self-tests are by no means guaranteed to handle all hardware failures correctly. Several things contribute to this. They include current hardware design, limited code space and the fact that testing for unknown or unexperienced failures is virtually impossible.

Several "UNEXPECTED" failure messages may be displayed at any time. When the CPU executes an instruction set, certain events are expected to occur. Should an interrupt (either internally from the CPU or externally from some other device) occur and cause a RAM or CPU address to be used out of sequence, the following error message is displayed:

```
UNEXPECTED USE OF (address)
```

Failure Indications

As the self-test progresses, the LEDs display the current state. At the end of the test, a power-up with no errors is indicated by all LEDs turned off and by immediate entry into the boot scanner.

If a failure occurred during the self-tests, then that failure will be indicated on the LEDs at the end of the tests. If there was more than one failure, the highest priority failure will be indicated on the LEDs. All the LED values are listed below.

The highest priority failure is also annunciated on the beeper. All 8 bits of the LED value are sounded off, most significant bit first, one second per bit, with a zero represented by a low tone and a one represented by a high tone. If no failure occurs, the beeper will not sound.

Boot ROM Messages

Table 4-2 lists the status messages displayed for Boot ROM functions. Each message is explained and if required, a procedure to resolve an indicated problem.

Table 4-2. Boot ROM Displayed Status Messages

Status Message	Meaning and What to Do
Configure Mode	Controller is in configure mode. Press 1 , 2 or A then Enter/Return .
Bit Mapped Video	Graphics circuit identified.
Booting A System	An operating system is booting
(n) Bytes	Memory amount in decimal. Message appears after memory test completes.
DMA	DMA circuit identified.
HP-HIL.Keyboard	system board HP-HIL circuit identified. Keyboard may now be used.
HPnnnnn (type) at (SC)	HP interface circuit identified: <ul style="list-style-type: none">■ nnnnn = product number■ type = interface type■ SC = select code Either the DIO-II accessory card or an equivalent circuit on the system board.

Table 4-2. Boot ROM Displayed Status Messages (continued)

Status Message	Meaning and What to Do
HP98265 (SCSI [E] SC)	HP SCSI interface circuit identified: <ul style="list-style-type: none"> ■ [E] = S for single-ended ■ [E] = D for differential ■ SC = select code Either the DIO accessory card or an equivalent circuit on the system board.
Loading Memory	Memory is loading with test data.
MC68030 Processor	MC68030 CPU identified.
MC68040 Processor	MC68040 CPU identified.
Reset To Restart	Press RESET to re-start the power-up sequence.
System Search Mode	Looking for an operating system. Press P then Enter/Return to pause.
Self-Test Mode	Controller is in Self-Test Mode testing interface circuits.
Testing Memory	Testing memory. Wait until it finishes.
Waiting 1 Minute (RETURN To Abort Wait)	Controller has failed checksum. Press Enter/Return to abort wait and continue.
Continue At Own Risk (RETURN To Continue)	A self-test of boot ROM checksum failed. You may continue but errors may occur. Press Enter/Return to restart power-up sequence.

Configuring the Controller

Introduction

Several configuration situations exist with the Model 362 and 382 controllers. Each is explained in these sections:

- Keyboard Differences
- Boot ROM Functions
- Finding HP-UX SCSI Bus Addresses
- Internal Mass Storage Devices
- External SCSI Cables
- Supported Accessory Cards
- Graphics Configuration



Keyboard Differences

The Models 362 and 382 support two keyboards:

- HP 46021B ITF Keyboard
- HP 98203C "BASIC" Keyboard

Key Difference

The three keyboards available for the Models 362 and 382 controllers have significantly different key layouts and key names. The function of each key is implicit with its name. The HP 98203C keyboard was designed for use with the BASIC operating system while the ITF keyboard was designed as a general purpose keyboard. The keyboards are all HP-HIL keyboards.

The most important difference is the names for the return or enter key. On the ITF keyboard, the key is **Return**, on the HP 98203C the key is **ENTER**. These keys perform the same function and will be identified in this document with the symbol **Return** **ENTER** to emphasize that name difference. To complete a statement or command, just press either the **Return**, **ENTER** or **Enter** key.

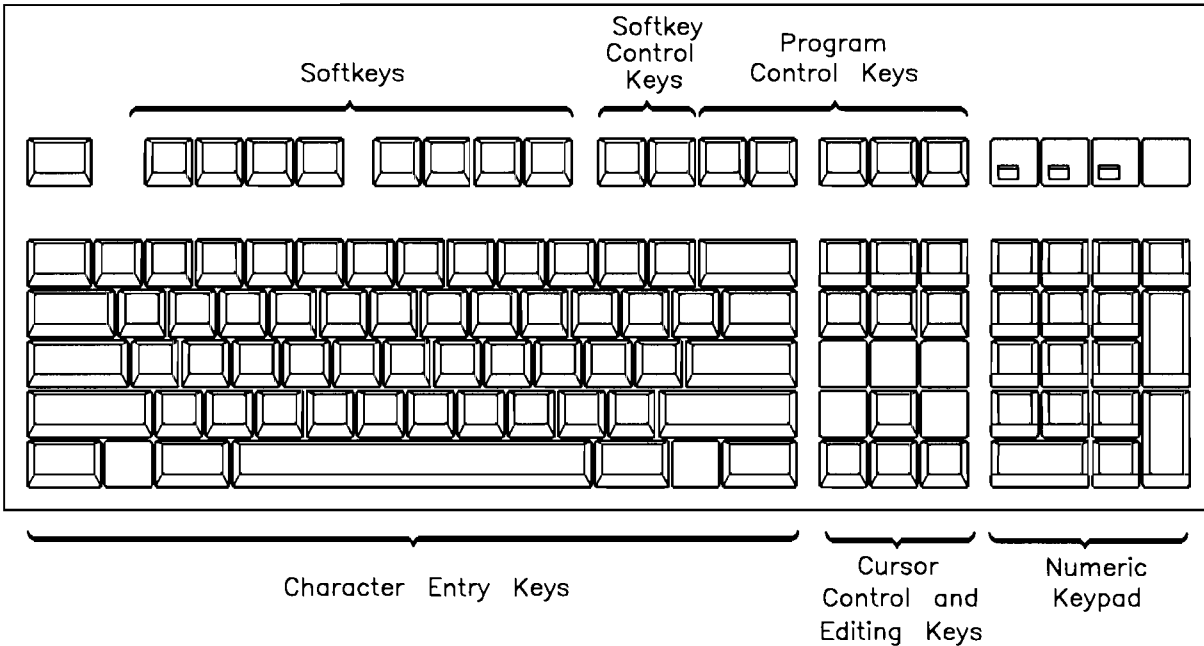

Figure 5-1. HP 46021B ITF Keyboard

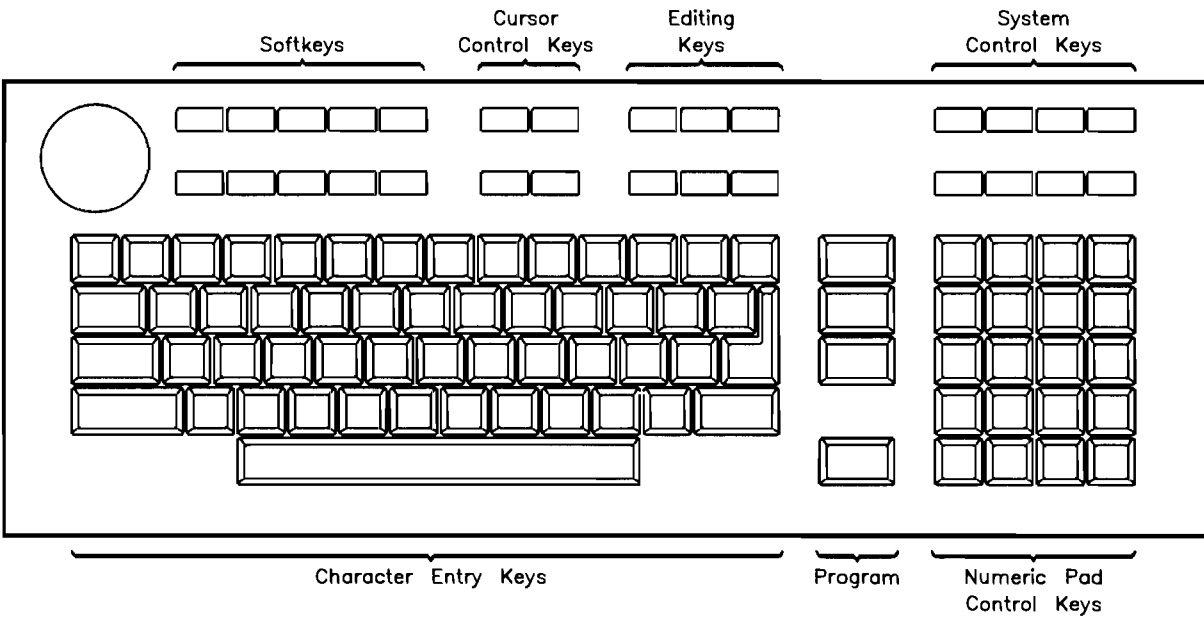

Figure 5-2. HP 98203C Keyboard

Boot ROM Functions

Power-Up Displays

When the controller is powered up, there are several messages displayed. Refer to your controller's *Owner's Guide* for information on these displays. To use the Boot ROM's configuration capabilities, Configuration Control Mode must be entered. This mode allows the Boot ROM to control and set several configuration settings stored in an EEPROM. These configurations include:

- Internal I/O Configurations: what select code, bus address, etc., the internal interfaces are set to.
- Auto System Select: which operating system will automatically be booted.

Configuration Control Mode

Configure Control Mode is run and controlled by your controller's Boot ROM. You do not need to have an operating system installed to use Configuration Control Mode. To enter Configuration Control Mode, do the following:

1. Turn on the monitor and the controller. The power-up messages will appear.
2. As soon as you hear two beeps or the line *HP-HIL.Keyboard* appears in the messages, press the **Space Bar** to prevent an operating system from booting.
3. Next, enter **C** **Return**/**ENTER** to enter Configuration Control Mode:
4. You should see this menu appear in the power-up display's upper right-hand corner:

```
Configuration Control
Keys Control Class
-----
1  I/O Configuration
2  Auto System Selection

A  Abort without changes
-----
Type [key] RETURN ?
```

5. You are now in Configuration Control Mode.

Configuration Control Mode Menu

You have three choices on the Configuration Control Menu:

- Press **1** and enter Configurable Interface Mode.
- Press **2** and enter OS Selection Mode.
- Press **A** and return to the boot up process

Configuring the Internal Interfaces

Press **1** to configure the internal I/O interfaces.

If you see error messages, refer to the section in this chapter titled 'Configuration Error Messages.'

The Configurable Interface Menu replaces the Configuration Control Menu and looks similar to the following.

```
Configurable Interfaces
Keys Interface  Select Code
-----
 1 LAN          21
 2 SCSI         14
 3 HP Parallel  12
 4 RS-232       9
 5 HP-IB

N store New values
D store Default values
  (then cycle SPU power)
A Abort without changes
-----
Type [key] RETURN ?
```

The order that interface identifiers appear and their respective number keys may be different on your controller. Only interfaces that are configurable from the Boot ROM's Configuration Control Mode will be listed. The Select Code currently assigned to the interfaces is shown in the column marked "Select Code".

- To change the configuration of an internal face, first press the appropriate identifying number. In our example, press **1** for LAN, **2** for SCSI, **3** for HP Parallel, **4** for RS-232, and **5** for HP-IB. Don't forget to press **Return**/**ENTER** to complete the command. For the HP-IB, there is no select code nor interrupt level, so the only change can be to make the internal HP-IB the System Controller.
- Make the appropriate changes on the interface menu presented.
- To store the new values, press **N**.
- To restore the original default values, press **D**.
- To abort the process, leaving the values unchanged, press **A**.
- Pressing **N**, or **D**, or **A** returns the system to the boot up process.

Internal Interface Default Values

Each of your controller's several internal interfaces is factory set to a default value. Table 5-1 lists the default configurations.

Table 5-1. Built-In Interface Default Configurations

Built-In Interface	Function	Default Configuration	Options
SCSI	Select Code	14	0 to 31
	Interrupt Level	3	3 to 6
	Bus Address	7	0 to 7
	Parity	Yes	No
LAN	Select Code	21	0 to 31
	Interrupt Level	5	3 to 6
HP Parallel	Select Code	12	0 to 31
	Interrupt Level	3	3 to 6
HP-IB	Select Code		n/a
	Interrupt Level		n/a

Example Interface Configuration

In this example, the SCSI interface will be reconfigured. Other interfaces use similar menus. To select and configure the SCSI Interface, do the following:

Start from Configuration Control Mode. That means the following Configuration Control menu is shown in your display's upper right-hand corner:

```
Configurable Interfaces
Keys Interface Select Code
-----
 1 LAN          21
 2 SCSI         14
 3 HP Parallel  12
 4 HP-IB        9

 N store New values
 D store Default values
   (then cycle SPU power)
 A Abort without changes
-----
Type [key] RETURN ?
```

Press **2** **Enter**/**Return** to get the SCSI interface menu:

The Configurable Interfaces Menu gets replaced with this SCSI Menu:

```
      SCSI
Key Feature          Value
-----
 1 Select Code      14
 2 Interrupt Level   3
 3 Parity            Y
 4 Bus Address       7
```

X to eXit menu

Type [key] RETURN ?

Use the specified keys to change the features listed. To change the Select Code, press **1**, or the change the bus address, press **4**. When you select a value to change, the prompt line changes. For example, to change the SCSI's Select Code, do the following:

Press **1** **Return**/**ENTER**

Then the command line changes to:

```
 1 Select Code      14
   used select codes are :
 12 14 15 21
Type 0.. 31 except used RETURN ?
```

- The select code function line shows the current information.
- Select codes already used and not available and are listed in the third line.
- The prompt line is next.

To change the SCSI select code to 23, enter **23** **Enter**/**Return**. The display would not look like the following:

```
 1 Select Code      23
   used select codes are :
 12 15 21 23
Type 0.. 31 except used RETURN ?
```

Other interfaces and features would be selected and changed the same way. After you have made interface configuration changes your controller needs, exit the interface menu by entering **X** **Enter**/**Return**. The Configurable Interfaces Menu will re-appear.

Select any other interface and configure it according to your application needs.

After configuring your controller's internal interfaces as required store the new interface values in memory by entering **N** **Enter**/**Return**.

The system will re-boot with the new values.

Auto System Selection Mode

Most users will leave this feature in the default setting, and can skip this section. To see if this feature is for you, ask yourself the following two questions:

1. Is my controller connected to a network that contains multiple operating systems?
2. Do I have a need to auto boot from a different operating system than the other people on the network?

Skip this section if you answered 'No' to either question. If you answered 'Yes' to both questions, follow these instructions to select your specific operating system to boot automatically.

1. Enter Auto System Selection Mode by entering **2** **Enter**/**Return** from the Configuration Control Mode.
2. The following menu will appear in the upper right corner:

```
Auto System Selection
Keys Option          Status
-----
1  Scan for System   Y
2  Selected System   N
3  Store Selected Sys. N

E  Execute
A  Abort without changes
-----
Type [key] RETURN ?
```

Note Keep this perspective in mind: When the Auto System Selection screen is selected, what you see first is the way the controller is currently set. As you change different key options, the menu shows what will be, as soon as you execute the changes by pressing **E**.

The Menu

While reading this section, remember that "Key" and "line" are used interchangeably; that is, you press **1** to select line 1. The letter *Y* means YES and *\$\$N\$\$* means NO.

- Default is Key 1 = Y, Key 2 = N and Key 3 = N.
- Pressing **1**, **2**, or **3** will change the way the autoboot selects and stores an operating system. Selecting a key also causes the Status value to toggle between Y and N.
- Pressing **E** executes the selected changes as the operating system re-boots.
- Pressing **A** will ignore any changes just made, and will re-start the Boot ROM using the previous setting.

Menu Options

- Key 1 = Y tells the controller to boot the first bootable operating system it finds.
- Key 2 = Y tells the controller to boot a specific operating system.
- Key 3 = Y causes the Boot ROM to store the specified operating system path in the EEPROM. This allows the selected system to auto-boot unattended.

Note that some key combinations are valid but others are either invalid or meaningless. The following are the valid combinations:

- Key 1 = Y and Key 2 = Y;

This will cause the Boot ROM to try auto-booting from the selected system once. If the selected system can not be accessed because its power switch is off or data cable is not connected, then the first bootable system will be booted. This is the most useful selected system option.

- Key 1 = N and Key 2 = Y;

This will cause the Boot ROM to try auto-booting from the selected system only, until it boots.

- Key 1 = Y and Key 2 = N;

This default mode causes the Boot ROM to boot the first bootable system it finds. No selected system specified.

Here are the invalid or meaningless combinations. The bootROM will toggle another line in order to produce a usable combination.

- Key 1 = N and Key 2 = N;

Key 1 or Key 2 must = Y. Trying to set both to N is not allowed and the opposite key will be automatically toggled.

- Key 2 = Y and Key 3 = N;

Changing Key 2 to Y will automatically set Key 3 to Y. This means a new system is to be selected, and Key 3 = Y says to store that new system in the EEPROM.

System Selection Example

Suppose that the operating system which you wish to select for automatic booting is labeled 2H in the list of bootable operating systems displayed when you do an attended boot (press **SPACE** before an operating system is booted). Furthermore, you want the controller to try to boot the system once, and if it is not accessible, to scan for and boot the default system.

This situation is listed as number one in the above list of valid combinations. To set it up, follow these steps:

1. Toggle Key 2 status to Y by entering **2** **Enter**/**Return**. Key 3 status will automatically toggle to Y.
2. Check to make sure Key 1 = Y.

3. Press: **E** **Enter**/**Return**

At this point the screen clears and the system starts re-booting. When HP- HIL.Keyboard is displayed or the beeper sounds, press **Space Bar** to invoke Attended Mode. Wait until all the devices are listed on the left and all bootable operating systems are listed on the right. The display now looks almost identical to an attended mode power-up display. The one difference is an additional message on the next to bottom line indicating that the Boot ROM will store the selection.

4. Select the number-letter combination listed in front of the operating system you want to select. For our example, enter **2 H Enter/Return**. The Boot ROM stores the selected system path information in the EEPROM while clearing the screen and re-booting. The selected system will now be booted.

This completes the process, and the selected system will continue to boot until a different unattended system is selected.

Error Messages

When you turn on your controller, one error condition is related to the internal interface configurations. If an error message appears, such as:

Configuration EEPROM Failed

Configure Mode Failed

one of several conditions may exist. A hardware problem with the Boot ROM or its associated circuits probably occurred. Refer to Table 5-2 for possible error messages you may see when entering Configuration Mode.

If the Boot ROM or EEPROM has problems after you enter one of the configuration commands, the mode lines display one of the error messages listed in Table 5-3.

Table 5-2. Configuration Mode Entry Error Messages

Error Message	Meaning and What To Do
<p>(No error message) Cannot enter Configuration Mode.</p> <p>Configure Mode Failed</p> <p>Configuration EEPROM Failed</p> <p>EEPROM Has Bad Information</p> <p>EEPROM Load Section Missing</p> <p>EEPROM Defaults Section Missing</p> <p>Too much data to save</p>	<p>If Configuration Mode does not start and no error message appears, a hardware failure probably occurred.</p> <p>One or more of these situations exists:</p> <p>All of the interface values have been set to their default (factory) values.</p> <p>Some default and some changed values have been set.</p> <p>All the interface values have been set to their changed values. Some minor error occurred that should not affect the interface's configurations.</p> <p>Check your controller's Boot Mode Selection and Interface Configuration Modes and verify they are correct for your application.</p> <p>Configuration Mode started, main menu may appear, but something failed. Try again.</p> <p>Could not load new configuration data. Hardware failure.</p> <p>Default configurations could not be found. Hardware failure.</p> <p>Too many interfaces for EEPROM to manage. Reconfigure controller with fewer interfaces.</p>

Table 5-3. Configuration Mode Exit Error Messages

Command	Error Message	Meaning and What To Do
N or D	Too many configuration saves	More than 64 000 saves were tried. Unlikely to occur.
N or D	Can not save new configuration	Something prevented saving the new configuration. Hardware failure.
N or D	EEPROM can not save information	EEPROM may not save any or all of the new configuration information. Hardware failure.
A	(No message should appear)	No error messages should appear when you abort configuration mode and reset your controller.

Finding the HP-UX SCSI Bus Addresses

Your system administrator should know what addresses your controller uses for each of its SCSI devices. Each SCSI device address must be unique. When adding a SCSI device, if the currently used values are not known, you can find out what bus addresses are already used by doing the following.

1. Type the 'SCSI Program' shown on the next page into a file called `check.c`:
2. Compile this program with the command: `cc check.c -o check` **Return**/**ENTER**
3. Run the program with root privileges, specifying the SCSI interface select code after the program name; e.g. `./check 14`. This will check select code 14.

HP-UX Program for SCSI Addresses

```
#include <stdio.h>
#include <fcntl.h>
#include <errno.h>
#include <sys/stat.h>
#include <sys/sysmacros.h>

main(argc, argv)
    int argc;
    char **argv;
{
    int fd, ba, sc;
    char *tmpfile = tempnam("/tmp", "scsi");
    mode_t fmode = S_IFCHR | S_IRUSR | S_IRGRP | S_IROTH;
    /* check for an argument */
    if (argc != 2 || (sc = strtol(argv[1], (char **)NULL, 0)) == 0) {
        fprintf(stderr, "usage: %s select_code\n", *argv);
        exit(1);
    }
    /* walk through bus addresses 0 through 7 */
    for (ba = 0; ba < 8; ba++) {
        /* make the device file */
        if (mknod(tmpfile, fmode, makedev(47, makeminor(sc, ba, 0, 0))) < 0) {
            perror("mknod"); /* exit if we can't make the device file; */
            exit(1); /* probably being run by non-root user */
        }
        /* open device, or check for other than "no such device or address" */
        if ((fd = open(tmpfile, O_RDONLY)) >= 0 || errno != ENXIO) {
            printf("Device at select code %d, bus address %d\n", sc, ba);
            close(fd);
        }
        unlink(tmpfile); /* remove the device file */
    }
    exit(0);
}
```

Internal Mass Storage Configurations

Hard Disk Drives

Setting the Hard Disk Drive Configuration Jumpers

This information is for:

- HPA2257A 52 Mbyte Hard Disk Drive.
- HPA2258A 210 Mbyte Hard Disk Drive.
- HPA2259A 420 Mbyte Hard Disk Drive.

Caution Although the device is well-protected from physical shock when installed in the controller, it is very easily damaged when separate. Avoid dropping or striking the device. Handle it gently at all times.

Note the jumpers in the back of the drive are installed as follows:

- Jumpers installed on pins = “in.”
- Jumpers removed from pins = “out.”

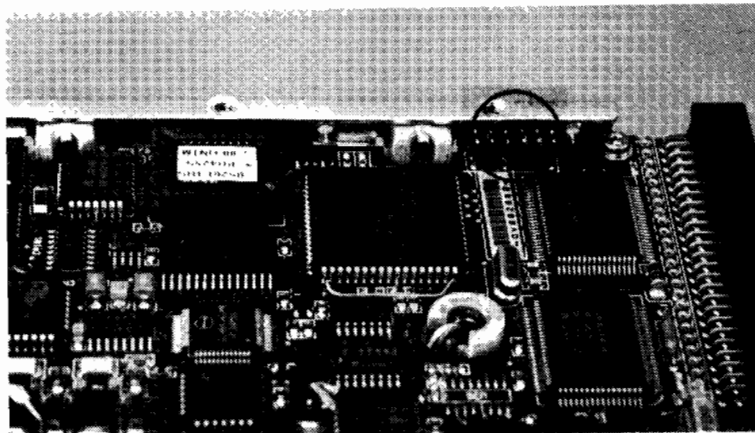

Figure 5-3. Hard Disk Drive Configuration Jumper Locations

Table 5-4. Hard Disk Drive Configuration Jumper Functions

Jumper Label	Function
SS	Self-Seek; In = disabled. Out = enabled. (Default) Drive self-tests at turn-on. LED is ON during test, OFF after self-test passes. Flashes if an error is detected.
EP	Enable Parity In = enabled. Out = disabled. (Default) Controls parity checking of data on SCSI bus.
WS	Wait/Spin In = enabled. Requires a stop/start unit command to spin drive motor. Out = disabled. (Default) Drive motor starts automatically at turn-on and is ready within 20 seconds.
A0, A1, A2	SCSI Bus Address; A0 is least significant bit. Shipped with address 6 set (jumpers on A1 and A2).

SCSI Bus Address Jumpers. The hard disk drive must be set to a unique SCSI bus address. Use a pair of needle-nose pliers to set the drive's SCSI address. The address is binary (jumper in = 1, out = 0) with jumper A0 the least significant bit.

The HP A2257A 52 Megabyte Hard Disk Drives

Setting the Drive Configuration Jumpers

Caution Although the device is well-protected from physical shock when installed in the controller, it is very easily damaged when separate. Avoid dropping or striking the device. Handle it gently at all times.

Figure 5-3 shows you the configuration jumper locations. Jumpers and their settings are explained in Table 5-5.

Note the jumpers in the back of the drive are installed as follows:

- Jumpers installed on pins = "in."
- Jumpers removed from pins = "out."

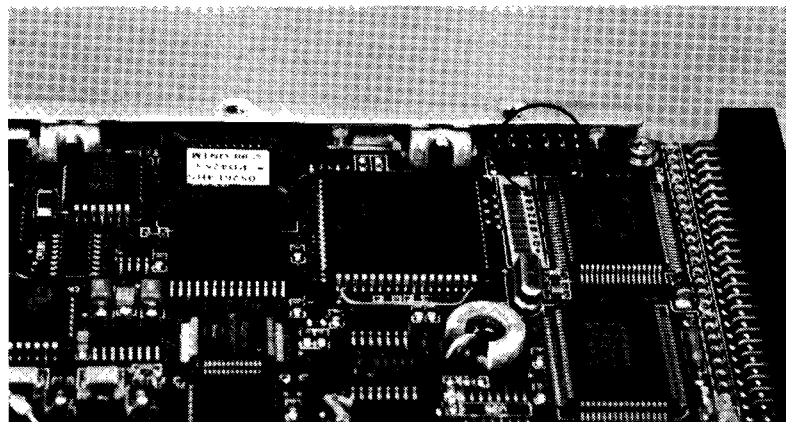

Figure 5-4. 52 Megabyte Hard Disk Drive Configuration Jumper Locations

Table 5-5. Hard Disk Drive Configuration Jumper Functions

Jumper Label	Function
SS	Self-Seek; In = disabled. Out = enabled. (Default) Drive self-tests at turn-on. LED is ON during test, OFF after self-test passes. Flashes if an error is detected.
EP	Enable Parity In = enabled. Out = disabled. (Default) Controls parity checking of data on SCSI bus.
WS	Wait/Spin In = enabled. Requires a stop/start unit command to spin drive motor. Out = disabled. (Default) Drive motor starts automatically at turn-on and is ready within 20 seconds.
A0, A1, A2	SCSI Bus Address; A0 is least significant bit. Shipped with address 6 set (jumpers on A1 and A2).

SCSI Bus Address Jumpers. The hard disk drive must be set to a unique SCSI bus address. Use a pair of needle-nose pliers to set the drive's SCSI address. The address is binary (jumper in = 1, out = 0) with jumper A0 the least significant bit.

3.5-in Flexible Disk Drive

Setting the Configuration Jumpers

Caution Although the device is well-protected from physical shock when installed in the controller, it is very easily damaged when separate. Avoid dropping or striking the device. Handle it gently at all times.

Figure 5-5 shows you the configuration jumper locations. Jumpers and their settings are explained in Table 5-6.

Note the flexible disk drive jumpers are installed as follows:

- Jumpers installed on pins = "in."
- Jumpers removed from pins = "out."

Caution Your flexible disk drive jumpers are used opposite to jumpers in your hard disk drives. For example, the three flexible disk drive bus address jumpers when set to bus address 0 are all 'in.' The same hard disk drive address jumpers set to bus address 0 are all 'out.'

Note

Jumpers 0, 2DS and A through F are factory set and must not be changed.

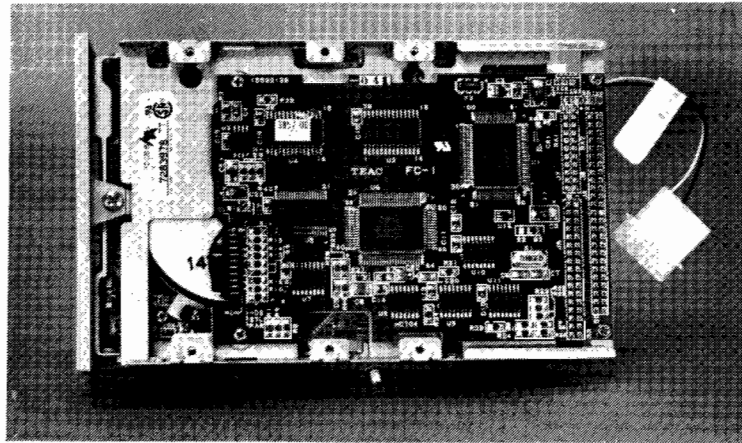

Figure 5-5. Flexible Disk Drive Configuration Jumper Locations

Table 5-6. Flexible Disk Drive Configuration Bottom Jumper Functions

Jumper Label	Function
ID2, ID1, ID0	SCSI Bus Address jumpers. ID2 is most significant bit. Default settings: Address 3. ID2 = out; ID1 = in; ID0 = in.
EJC	Eject mode In = Electrical eject mode (not used). Out = (default) Manual eject mode.
LEV	Pin 2 output of the density is enabled. In = enabled. (Default) Out = disabled.
HDS	In = enabled. (Default) Out = disabled.
STL	In = enabled. (Default) Out = disabled.
PAR	Enable Parity In = enabled. (Default) Controls parity checking of data on SCSI bus. Out = disabled.
MON	Motor ON In = disabled. Out = enabled. (Default) Drive motor is not turned on when the controller is turned on.

Function Jumpers. Only the SCSI address jumpers should be changed. You should not have to change the function jumpers. They should be left in their default condition.

SCSI Bus Address Jumpers. Your flexible disk drive must be set to a bus address that is different from other SCSI device bus addresses already used. The factory default setting is address 3. Use a pair of needle-nose pliers to remove and install the configuration jumpers. Set your drive's SCSI configuration jumpers for the SCSI bus address it will use.

Note that jumper ID 0 is next to the edge of the printed circuit board. For example, if you want to set your hard disk drive's address jumpers to address 5, you would set:

- Jumper ID 0 out.
- Jumper ID 1 in.
- Jumper ID 2 out.

SCSI Bus Address Jumpers. The hard disk drive must be set to a unique SCSI bus address. Use a pair of needle-nose pliers to set the drive's SCSI address. The address is binary (jumper in = 1, out = 0) with jumper A0 the least significant bit.

CD ROM Disk Drive

Note CD ROM drives are only supported with the HP A2256A SCSI External Interface Upgrade installed. If no external SCSI devices are used in the system, a terminator must be plugged into the rear panel SCSI connector.

Setting the Drive Configuration Jumpers

Figure 5-6 shows you the configuration jumper locations. Jumpers and their settings are explained in Table 5-7. Note the jumper positions that represent an 'out' and 'in.'

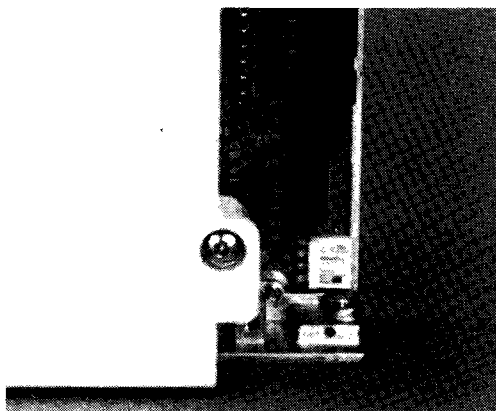

Figure 5-6. CD ROM Configuration Jumper Locations

Table 5-7. CD ROM Drive Configuration Jumper Functions

Jumper Label	Function
ID1,ID2,ID4	SCSI ID Address; Jumper ID1 is least significant bit. Shipped with address 2 set (default); jumper only on ID2
PRTY	Parity checking; Out = Disabled, In = Enabled.
PRV/ALW	Media removal; Out = eject button enabled, In = eject button ignored.
TEST	Test; for factory use only.
TERM	Termination power source; In = from drive, Out = from bus

SCSI Bus Address Jumpers. Your CD ROM drive's SCSI ID jumpers must be set to the bus address it will use. Your CD ROM has bus address 2 factory set. Set your CD ROM's SCSI ID configuration jumpers for SCSI bus address you will use in the range of 0 through 6. Refer to Table 5-8 for bus address settings

Table 5-8. CD ROM SCSI ID Addresses and Switch Settings

SCSI Address	ID1	ID2	ID4
0	0	0	0
1	1	0	0
2	0	1	0
3	1	1	0
4	0	0	1
5	1	0	1
6	0	1	1
7	1	1	1

Parity. You should leave the PRTY jumper in to enable parity checking of data.

Audio Use. 'Audio Only Mode' is not supported.

External SCSI Cables

The SCSI cables connected to external devices have limits on their length. Cables must meet certain type and length requirements.

- SCSI Cable Restrictions.
- Supported SCSI Cables.
- Determining Controller SCSI Cable Lengths

SCSI Cable Rules

Rules for external SCSI cables are:

- Only SCSI cables approved by Hewlett-Packard are supported.
- Use the shortest possible cables.
- All internal and external SCSI devices must be counted. A total of 7 devices are allowed.
- Although up to seven SCSI disk drives (hard and magneto-optical), a limit of five disk volumes per controller may be mounted on the operating system at any one time.
- When adding third party SCSI devices, total SCSI cable length is limited to 4.6 meters (15 feet). Both controller and device internal and external cable length are included.

Note When using external SCSI cabling, you must use an active SCSI terminator at the last external device on the SCSI bus. Use only HP K2291 terminators insure reliable system operation.

Supported Accessory Cards

DIO-I Accessory Cards

The HP A2247A 4-slot bus expander accepts DIO-II accessory cards. These cards are also used on other Series 300 controller. Refer to Table 5-9 for the supported accessory cards.

Table 5-9.

DIO-II Accessory Cards in HP A2247A 2-Slot DIO-II Bus Expander	HP-UX Support?	BASIC Support?
HP 98297A Real Time Interface Card	Yes	No
HP 98638A 8-Port Multiplexer Card	Yes	No
HP 98641A RJE 2780/3780 Interface Card	Yes	No

Supported DIO-I Accessory Cards

Model 362 and 382 controllers and the HP A2246A 4-slot bus expander accept DIO-I accessory cards. These cards are also used on other Series 300 and 200 controller. Refer to Table 5-10 for the supported accessory cards.

Table 5-10.

DIO-I Accessory Cards in Model 362 and 382 Controllers and HP A2246A 4-Slot DIO-I Bus Expander	HP-UX Support?	BASIC Support?
HP 98622A 16-Bit Parallel (GPIO) Interface Card	Yes	Yes
HP 98624A HP-IB (IEEE 488) Interface Card	Yes	Yes
HP 98625B High-Speed HP-IB (IEEE 488) Interface Card	Yes	Yes
HP 98626A RS-232-C Serial Interface Card	Yes	Yes
HP 98642A 4-Port Multiplexer Card	Yes	No
HP 98643A Local Area Network (IEEE 802.3) Interface Card	Yes	Yes
HP 98644A RS-232-C Serial Interface Card	Yes	Yes
HP 98658A Small Controller Systems Interface Card	Yes	Yes

Graphics Configuration

There are two jumpers on the system board for on-board graphics configuration. The jumpers are marked **COLOR** and **ENABLE**. The default condition is with both jumpers nearest the markings. Moving the **ENABLE** jumper causes the on-board graphics circuitry to be disabled, allowing a supported graphics board to be used in the DIO slot. Only the **COLOR** graphics type is supported on Model 362 and 382 controllers. Refer to Figure 5-7 for jumper positions.

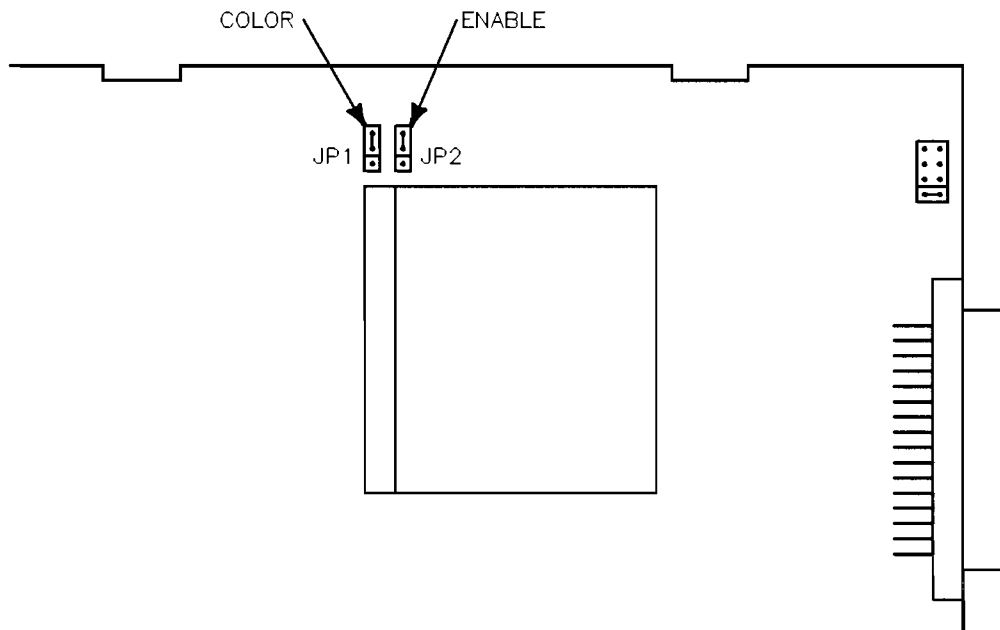

Figure 5-7. System Board Graphics Jumpers

LAN Type

A jumper on the top of the LAN board selects the LAN type. Figure 5-8 shows the two positions.

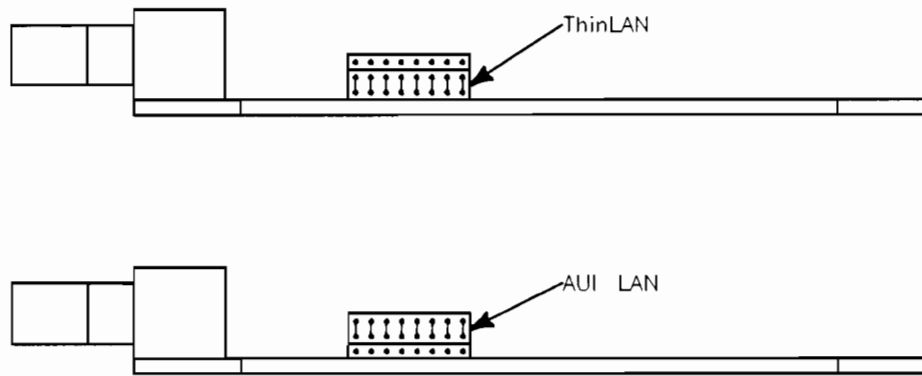

Figure 5-8. LAN Board Jumper Positions

Troubleshooting

Introduction to Troubleshooting

Troubleshooting information and procedures for Model 362/382 controllers are divided into these sections:

- Introduction to Troubleshooting
- Troubleshooting Procedures.
- Checkout Procedures.

The flowcharts contained in this chapter are logically structured to point you in the right direction (run diagnostics, replace assemblies, and so on). The remainder of the information in this chapter supports the directions in the flowcharts. Follow the assembly replacement procedures in Chapter 2 if the flowcharts call for assembly replacement.

Analytic Troubleshooting

Troubleshooting this controller is the process of getting answers to these five questions:

- What exactly is wrong, or what are the bad symptoms?
- Where are the bad symptoms appearing?
- When do the bad symptoms occur?
- How bad is the problem or to what extent does it occur?
- What actually caused the problem in the first place?

Getting the answers to these questions usually makes the troubleshooting process much more effective and less costly. When a failure in a system occurs, remember these questions and get the answers to each of them.

While going through the troubleshooting process, bear in mind that the Models 362/382 are highly integrated. That means that a large portion of many functions is located on the system board. Thus, if you come to the conclusion that a certain circuit is defective (such as RAM, SCSI or mass storage), remember that a large portion of that circuit is located on the system board. The defective part may well be on the system board rather than on the more apparent RAM board or SCSI device.

Operating Systems

The troubleshooting strategy for Model 362/382 controllers is in the form of a bottoms-up approach. That is, you note any error or status messages, and then you run the power-up boot ROM diagnostics known as Self Test. If the Self Test diagnostics fail, replace the assembly that is indicated. If the tests pass but you still suspect a problem, you should run the next level of diagnostics.

These diagnostics are in the offline Test Stimulus Code (TSC) tests, depending on the suspected problem. If the TSC diagnostics fail, replace the indicated assembly. If the controller does not report errors, the suspected problem is probably not hardware-related. Refer to the following sections for more information about Self Test and TSC.

After you have all answers possible, decide what's the most probable cause of the problem. Sometimes you'll arrive at several choices for a cause. For each choice, qualify it against the answers to the questions above. The most probable cause is the one that logically justifies the correct answers to these questions.

Most of the procedures presented in this section do not depend on any particular operating system being loaded. However, the material regarding ce.utilities requires that the operating system is HP-UX.

Troubleshooting in the HP-UX Environment

You must be familiar with the HP-UX operating system to troubleshoot Series 300 controllers that are running with HP-UX. You must be able to start and stop processes. You should also be familiar with the Boot ROM Test Mode, Series 300 Test Tools and the HP-UX ce.utilities. The Series 200/300 Test Tools Manual has instructions for running the Series 300 Test Tools. Instructions for using ce.utilities are found in the System Support Tape User's Guide.

In the HP-UX environment, you note any error or status messages, and then run the power-up boot ROM diagnostics, known as Self Test. If the Self Test diagnostics fail, replace the assembly that is indicated. Refer to the following sections for more information about Self Test.

Troubleshooting Procedures

Several levels of operations exist within Model 362/382 controllers. Each level has diagnostic or error-reporting capabilities:

- The Boot ROM level has:
 - Self Tests.
 - Test Mode.
- Series 300 Test Tools have:
 - Controller Tests.
 - System Functional Tests.
- HP-UX has ce.utilities.

Troubleshooting Flowcharts

This section provides flowcharts that route you through a series of standard troubleshooting procedures for Model 362/382 controllers.

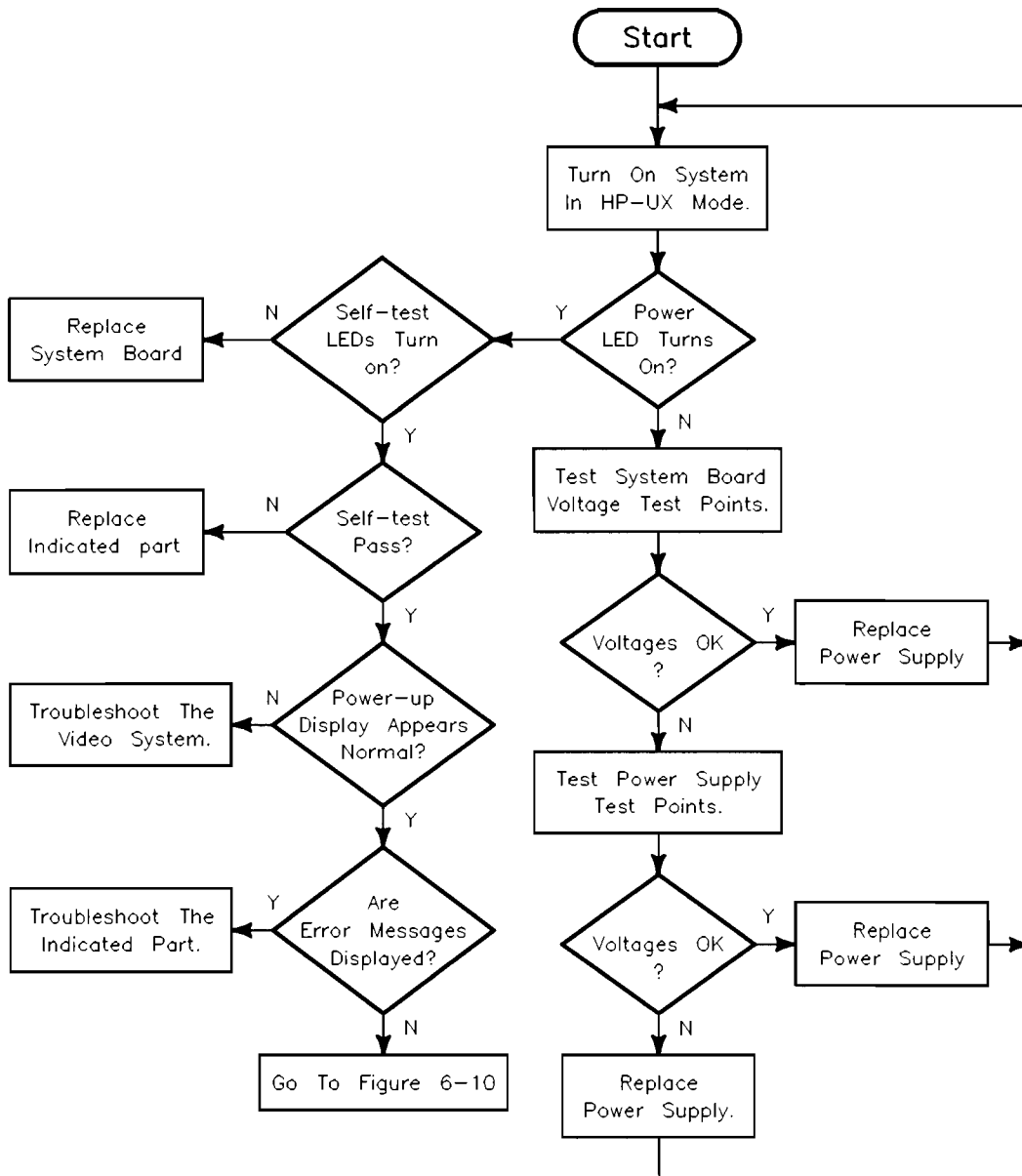

Figure 6-1. Troubleshooting: Main Flowchart

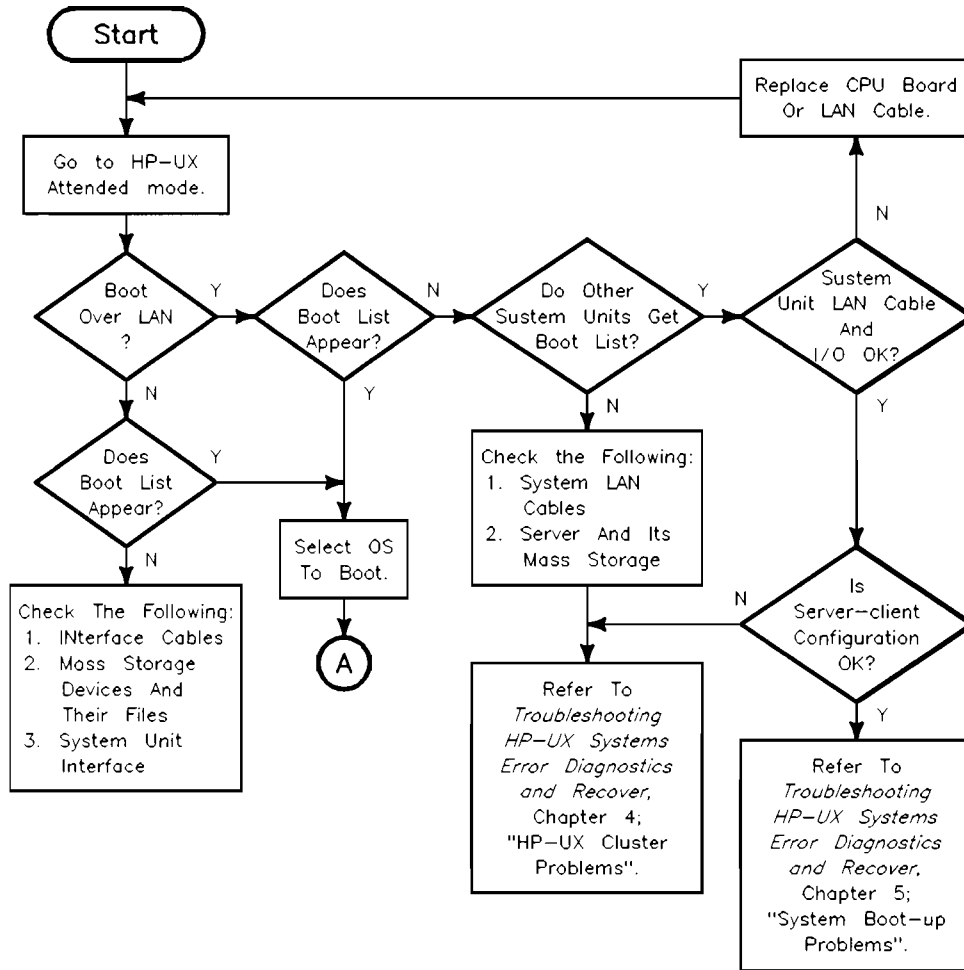

Figure 6-2. Troubleshooting: Problems While Booting

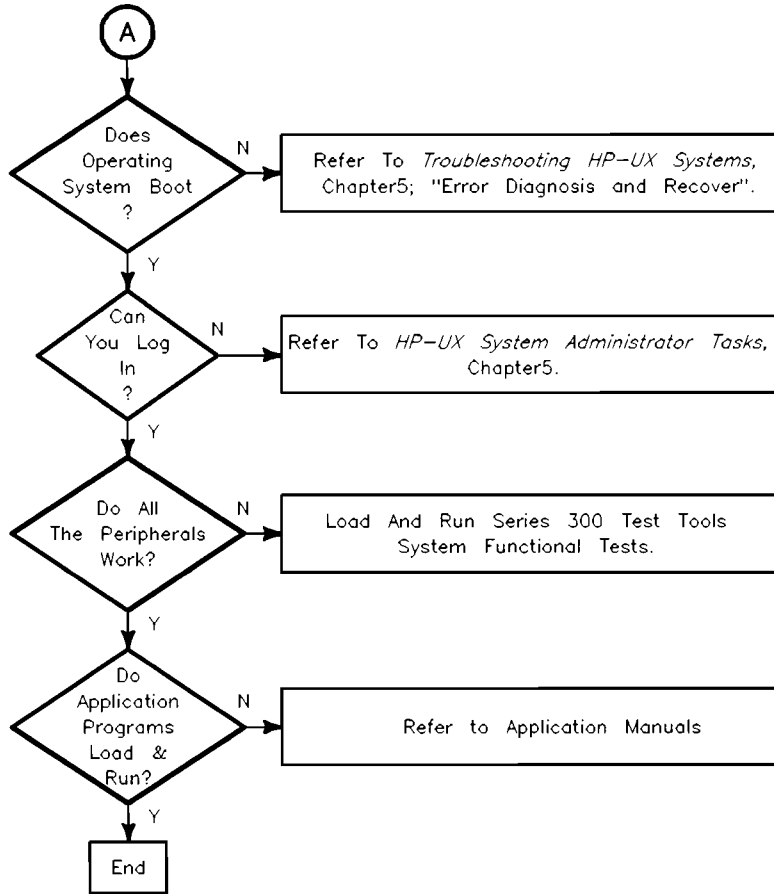

Figure 6-3. Troubleshooting: Problems While Booting (continued)

Boot ROM Self-Tests

When the controller first powers up, the CPU starts executing Boot ROM code. Before code is executed to boot an operating system, several things need to be set up and tested. The Boot ROM has several code segments to manage these responsibilities.

Hardware Initialization Support

Some hardware, such as video circuit initialization and floating RAM positioning, which can not wait for an operating system to be booted, must be initialized at power-up as soon as possible to prevent improper operation.

Go/No-Go Self-Test Support

The primary objective is to tell the user that the controller is okay. This consists of indicating all such devices present and reporting all detectable failures.

Boot ROM self-tests are by no means guaranteed to handle all hardware failures correctly. Several things contribute to this. They include current hardware design, limited code space and the fact that testing for unknown or unexperienced failures is virtually impossible.

Several UNEXPECTED failure messages may be displayed at any time. When the CPU executes an instruction set, certain events are expected to occur. Should an interrupt (either internally from the CPU or externally from some other device) occur and cause a RAM or CPU address to be used out of sequence, the following error message is displayed:

UNEXPECTED USE OF (address)

Table 6-1 lists these messages. The five most significant digits of the address are FFFFF₁₆ so only the three least significant digits (LSD) are listed in the table. When a range of addresses is shown, adjacent addresses are six addresses apart.

When an UNEXPECTED failure message equates to an interrupt level, vectored interrupt, or trap, the following situations normally exist:

- Interrupt level 1 through 7: Can happen at any time and are usually caused by an interface set to the indicated interrupt level. If the error repeats, the system board should be replaced.
- CPU traps: Usually occurs when the operating system is being used. A CPU trap indicates something in the processor circuits didn't go right. If the error repeats, the system board should be replaced.
- Other errors: Several things on the system board in an interface or CPU circuit can cause these errors. If the error repeats, the system board should be replaced.

Table 6-1. UNEXPECTED USE OF (address) Failure Messages

3 Hex LSDs	What Unexpected Event Occurred
FFA	Bus error
FF4	Address error
FFE	Illegal instruction
FE8	Zero by zero trap
FE2	check trap
FDC	TRAPV TRAP
FD6	Privilege violation
FD0	Trace trap
FCA	1010 Opcode
FC4	1111 Opcode
FBE	Interrupt level 1 (keyboard)
FB8	Interrupt level 2
FB2	Interrupt level 3
FAC	Interrupt level 4
FA6	Interrupt level 5
FA0	Interrupt level 6
F9A	Interrupt level 7 (RESET from keyboard)
F3A to F94	CPU Traps
F34	Reset from keyboard
F2E	Keyboard timeout (fast handshake)
F28	Battery backup interrupt
F22	NMI from the backplane
F1C	Spurious interrupt
EEC to F16	Vectored interrupts
EE6	Format error, co-processor violation or unknown.
EE0	Co-processor exception vectors.

Failure Indications

As the self-test progresses, the LEDs display the current state. At the end of the test, a power-up with no errors is indicated by all LEDs turned off and by immediate entry into the boot scanner.

If a failure occurred during the self-tests, then that failure will be indicated on the LEDs at the end of the tests. If there was more than one failure, the highest priority failure will be indicated on the LEDs. All the LED values are listed below.

The highest priority failure is also annunciated on the beeper. The lower 7 bits of the LED value are sounded off, most significant bit first, one second per bit, with a zero represented by a low tone and a one represented by a high tone. If no failure occurs, the beeper will not sound.

If the failure was a Boot ROM checksum error, the following message will be displayed:

CONTINUE AT OWN RISK (Press RETURN To Continue)

Once this message has been printed, the **Enter**/**Return** key must be pressed to continue to the boot scanner. The probability is fairly low that the error will adversely affect the user, but if it does, it could be catastrophic.

For all other failures, the message:

WAITING 1 MINUTE (Press RETURN To Abort Wait)

will be displayed. The Boot ROM will time out after approximately one minute and will then continue into the boot scanner. This allows time for the monitor or terminal to warm up and for the user to read the error messages. These failures are usually non-fatal, so in unattended mode, the Boot ROM will still boot the first operating system it finds. Typing the **Enter**/**Return** key will terminate the beeping error code and abort the one-minute wait. Typing the **Enter**/**Return** key will also make the controller go into attended mode. This means that the Boot ROM will display all operating systems found and will not boot one until one is chosen and entered by the user.

General Description of Failure Codes

Table 6-2 lists the general meaning of error codes. These codes are explained further in other tables. LED patterns are represented by a black dot for on and a white dot for off. A grey dot indicate the LED in that position is on or off, depending on the binary code used to represent the device or failure type.

The test LEDs are mounted near the rear edge of the system board. They may be viewed by looking through a slot near the center of the rear panel, just above the interface connectors. LED on/off values are as shown in the following figure.

Table 6-2. General Failure LED Indications

LED Display	System Status
● ● ● ● ● ● ● ●	LEDs never accessed; replace system board.
○ ● ● ● ● ● ● ●	LEDs failed to acknowledge data

State and Failure Codes

Table 6-3 and Table 6-4 lists the LED state and failure codes used by the Boot ROMs. Codes are listed here in numerical order for easy reference.

Table 6-3. Self-Test LED Special State and Failure Codes

LEDs A B C D E F G H	Explanation
o o o o o o o o	No failure
o o o o o o o ●	Failed CPU register test.
o o o o o o ● o	Testing top 16 Kbytes of RAM.
o o o o o o ● ●	Failure in top 16 Kbytes of RAM.
o o o o o ● o o	Top 16 Kbytes of RAM missing or not found by CPU.
o o o o o ● ● ●	Starting Test Vector list.
o o o o ● o o o	Resetting all interfaces.
o o o o ● ● o o	Internal console checksum error
o o o o ● o ● o	Testing RAM for I/O on-board test code.
o ● ● ● o o o o	SGC slot 0 error
o ● ● ● o o o ●	SGC slot 1 error
o ● ● ● o o o o	SGC slot 2 error
o ● ● ● o o o ●	SGC slot 3 error
o o o o ● ● ● o	Failed Boot ROM checksum.
o o o o ● ● ● ●	Pre-loading RAM for main test.
o o o ● o o o o	RAM Testing (main)
o o o ● o o o ●	Failure: Not enough RAM.
o o o ● o o o o	Failure: ROM system.
o o o ● o o o ●	Failure: Boot error.
o o o ● ● o o o	Failure: OS tried to start loading at too high of an address.
o o o ● ● o o ●	Failure: Not enough RAM to load OS.

Table 6-4. Self-Test LED State and Failure Codes for Interfaces

LEDs	Explanation
○ ○ ● ○ ○ ○ ○ ○	Failure: 4 μ sec timer.
○ ○ ● ○ ○ ○ ● ○	Failure: system board HP-HIL circuit.
○ ○ ● ○ ● ○ ○ ○	Failure: DMA circuit.
○ ○ ● ○ ● ● ○ ○	Failure - video font ROM.
○ ○ ● ○ ● ● ● ○	Failure: Video bit map circuit.
○ ● ○ ○ ○ ○ ○ ○	Failure: I/O circuit at indicated select code 0.
○ ● ○ ● ● ● ● ●	Failure: I/O circuit at select code 31.

Table 6-5. Boot ROM Displayed Error Messages

Error Message	Meaning and What to Do
DATA PARITY ERROR AT (address)	Parity error at (address). Replace memory module that has the indicated address.
Memory Failed At (address)	Memory failed at (address). Refer to memory address vs. memory block table and replace memory module.
Memory Gone At (address)	Memory not found at indicated address. Replace memory module that has the indicated address.
Not Enough Memory	Not enough memory to load operating system. Add more memory.
Parity Bit Error At (address)	Parity error at (address). Replace memory module that has the indicated address.
System Would Load Too High	An addressing error would make the operating system try to load at too high an address. Probable cause: <ul style="list-style-type: none"> ■ Bad media. ■ Data transfer error. ■ Bad system board or mass storage device. Try again. If error repeats, troubleshoot above items.
System Not Found	Selected operating system not found on mass storage devices. Verify operating system is available on a mass storage device, then try again. If error repeats, troubleshoot processor, interface and mass storage.
Unexpected Use Of (address)	Possible CPU related error. Refer to Table 6-3.
Configuration EEPROM Failed	Configuration EEPROM or associated circuits may not be working correctly. One of these situations may exist: <ul style="list-style-type: none"> ■ Some default and some new configuration value are set. ■ Some error occurred that should not affect operation. Try again. If error repeats, replace the system board.

Table 6-5. Boot ROM Displayed Error Messages (continued)

Error Message	Meaning and What to Do
EEPROM Has Bad Information	Configuration Mode started, main menu may appear, but something failed. Try again. Replace system board. If Configuration Mode does not start and no error message appears, a hardware failure probably occurred. Replace system board.
EEPROM Load Section Missing	Could not load new configuration data. Hardware failure. Replace system board.
EEPROM Defaults Section Missing	Default configurations could not be found. Hardware failure. Replace system board.
Too much data to save	Too many interfaces for EEPROM to manage. Reconfigure controller with fewer interfaces.

Test Mode

When your display's last lines show:

RESET to Restart, SPACE to clear input Waiting for System Selection ?

you may press **T** and this Test Mode display appears in the screen's upper right-hand corner:

```

Self Test Controls
Keys  Test Option  Selected
-----
  1    Continuous    N
  2    Extended      N
  3    Test Memory   Y

D     set Defaults
R     Run Tests
-----
Type [key] RETURN ?
    
```

Self Test Control Menu

A Self Test Controls menu has three columns to provide you with these controls:

- **Keys**; the keyboard keys used to select the test option you want to run.
- **Test Option**; the type of test to run.
- **Selected**; indicates the yes/no (Y/N) status of the option.

You will find explanations for each Self-Test Controls Menu item in the next few subsections.

Continuous Self-Tests

Continuous Self-Tests cause the Boot ROM to continuously repeat the self-tests. Entering configure mode while already in continuous self-test mode and choosing the Continuous option stops the continuous self-test and causes the Boot ROM to resume normal operation.

While in continuous mode, the Boot ROM will not wait or stop for most failures. It will just continue looping through self-test. The following failures will stop self-test looping:

- A memory failure in the top 16 KB of memory. The Boot ROM stops with the display blanked.
- Boot ROM checksum failure. The Boot ROM stops with these messages displayed:

```
Continue AT Own Risk
RETURN To Continue
```

Something in the Boot ROM has changed. It may have a bad instruction or cannot execute instructions properly. If you continue, something may not work correctly. The system board should be replaced.

Pressing **Enter**/**Return** causes the Boot ROM to continue self-test looping.

Extended Self-Tests

When you select Extended, the self-test starts over and the long memory test will be run. It takes about 4 seconds per megabyte. The standard, or default, memory test takes about 1 second per megabyte.

This mode also invokes extended testing on LAN by doing external loopback and cable testing.

With the LAN interface, all extended test functions will work. If an external Media Attachment Unit is not connected for AUI interfaces, the extended test will report a failure.

Test Memory

Memory tests are performed on main memory. Both read/write and parity tests are run. You will see error messages displayed if memory fails. Memory error messages are interpreted differently for each type of memory test.

For word-wide main memory error messages, these messages appear at the bottom of your display in this format:

```
Memory Failed at (address)
(W:BBCCDDEE, R:BBCCDDEF)
```

In the above message, the hex address had the hex data BBCCDDEE written (W) into and read (R) out of the address. If the read data is different than the write data as shown in the above example in the least significant hex digits, that indicates an error.

Parity error messages are of two types:

Parity Bit Error At (address)

means a failure was detected in the parity checking RAM for the address shown.

Data Parity Error AT (address)

means a RAM failure was detected at the indicated address. The address in parity error messages is the lowest of four consecutive addresses. Errors could have occurred in any or all of these four addresses. Parity errors will be displayed during the Test Memory phase of the self-test and testing will continue.

Memory Configurations and Addressing

Table 6-6 lists all supported memory configurations.

Model 362 Memory Troubleshooting. Here is a chart showing the address ranges and possible board combinations for a given total amount of memory:

Table 6-6. Model 362 Controller RAM Addresses vs. Boards

Total RAM	Address Ranges Upper to Lower	HP D2152A 8 MB Boards	HP D2156A 4 MB Boards	HP D2381A 2 MB Boards
2 Mbytes	FFFFFFF - FFE00000	8 MB Block	4 MB Block	2 MB Block
4 Mbytes	FFDFFFFFF - FFC00000		4 MB Block	2 MB Block
6 Mbytes	FFBFFFFFF - FFA00000		4 MB Block	2 MB Block
8 Mbytes	FF9FFFFFF - FF800000		Not used	Not used
10 Mbytes	FF7FFFFFF - FF600000	8 MB Block	4 MB Block	2 MB Block
12 Mbytes	FF5FFFFFF - FF400000		Not used	Not used
14 Mbytes	FF3FFFFFF - FF200000		Not used	Not used
16 Mbytes	FF1FFFFFF - FF000000		Not used	Not used

A least one RAM board must be placed in slot RAM 0. Slot RAM 1 may or may not have a board installed.

Example: Total Memory of 8 Mbytes. A controller having a total memory of 8 Mbytes with two RAM boards has:

- Two 4 Mbyte RAM boards; one in slot RAM 1 and one in slot RAM 0 that make up an 8 Mbyte block of memory with:
 - An upper block address of FFFFFFFF₁₆.
 - A lower block address of FF800000₁₆.

A memory failure at address FF90A7C4₁₆ is on the RAM board in slot J5.

Model 382 Memory Troubleshooting. Table 6-7 lists the address ranges and possible board combinations for a given total amount of memory:

Table 6-7. Model 382 Controller RAM Addresses

Total RAM	Address Ranges Upper to Lower	HP A2202A 8 MB Boards	HP A2201A 4 MB Boards	HP A2200A 2 MB Boards
4 Mbytes	FFFFFFF - FFC00000	16 MB Block	8 MB Block	4 MB Block
8 Mbytes	FFBFFFF - FF800000		8 MB Block	4 MB Block
12 Mbytes	FF7FFFF - FF400000		8 MB Block	4 MB Block
16 Mbytes	FF3FFFF - FF000000		Not used	Not used
20 Mbytes	FEFFFFFF - FEC00000	16 MB Block	8 MB Block	4 MB Block
24 Mbytes	FEBFFFF - FE800000		Not used	Not used
28 Mbytes	FE7FFFF - FE400000		Not used	Not used
32 Mbytes	FE3FFFF - FE000000		Not used	Not used

Slots labeled RAM PAIR 0 must contain a board pair. If there are two board pairs, the pair in slots RAM PAIR 0 must be as large as or larger than the pair in slots labeled RAM PAIR 1.

Example: Total Memory of 8 Mbytes. A controller having a total memory of 8 Mbytes with two RAM boards has:

- Two 4 Mbyte RAM boards located in slots **RAM PAIR 0** that make up an 8 Mbyte block of memory with:
 - An upper block address of $FFFFFFFF_{16}$.
 - A lower block address of $FF800000_{16}$.
- RAM slots **RAM PAIR 1** are empty.
- Block addresses whose LSD is:
 - F, E, D, C, 7, 6, 5, or 4 are on the RAM board in slot **RAM PAIR 0**, the slot closest to the controller's front.
 - B, A, 9, 8, 3, 2, 1, or 0 are on the RAM board in slot **RAM PAIR 0**, in the second slot back from the front.

A memory failure at address $FF90A7C4_{16}$ is on the RAM board in slot **RAM PAIR 0**, the slot closest to the front.

Example: Total Memory of 24 Mbytes. A controller having a total memory of 24 Mbytes with four RAM boards has:

- Two 8 Mbyte RAM boards located in slots **RAM PAIR 0** that make up a 16 Mbyte block of memory with:
 - An upper block address of $FFFFFFFF_{16}$.
 - A lower block address of $FF000000_{16}$.
- Two 4 Mbyte RAM boards located in slots **RAM PAIR 1** that make up an 8 Mbyte block of memory with:
 - An upper block address of $FEFFFFFF_{16}$.
 - A lower block address of $FE800000_{16}$.
- For each pair of RAM boards, or memory block, whose LSD is:
 - F, E, D, C, 7, 6, 5, or 4 are on the RAM board in the first slot closest to the front of the pair.
 - B, A, 9, 8, 3, 2, 1, or 0 are on the RAM board in the rear-most slot of the pair.
- $FE90A7C4_{16}$ is on the RAM board in slot **RAM PAIR 1** closest to the front.

Set Defaults

Typing the command **(D)** sets the 'Test Memory' default value to 'yes' for testing.

Run Tests

When you are ready to run the self-tests with the options you have selected, type the command **(R)**.

SCSI Interface and Device Testing

Two levels of SCSI testing can be used with Model 362/382 controllers.

- Normal testing can be done on controllers with internal SCSI mass storage devices.
- The SCSI exerciser can also be done.

Normal SCSI Testing

Normal testing is done at power-up or if the Boot ROM is in LOOPING test mode. This test only checks the general functionality of various registers on the interface. It will only detect gross failures.

The identification line may be followed by one of these error messages:

```
register test failed
```

```
fuse burned out
```

If either of these messages appear, no attempt will be made to use the interface as a boot source. The 'fuse' may be reset by resetting the controller or cycling controller power.

SCSI Exerciser Testing

The SCSI Disk Exerciser program can be used to verify the correct operation of SCSI direct access devices. Follow these steps to use the SCSI exerciser:

1. From the HP-UX prompt, type this command to access the directory with the SCSI exerciser file:

```
/usr/diag/CE.utilities/SCSIidisk  
```

2. Type this command to start the SCSI exerciser:

```
./exerciser  
```

3. Note the typical device file for a SCSI device:

```
crw-rw-rw-  1 root    sys      47 0x0e0400 Feb 22 10:12 4s0
```

which is for a SCSI interface at select code 14, and a disk at SCSI address 4.

If you need to create a device file, the following command should create a device file for a typical internal disk:

```
/etc/mknod /dev/rdisk/0s0 c 47 0x0e0000  
```

Here are the available SCSI exerciser functions:

Table 6-8. SCSI Exerciser Functions

Key	Exerciser Description
<input type="text" value="D"/>	Device selection: Allows a new device to be selected.
<input type="text" value="R"/>	Read check entire disk. Each pass can take a half hour or more, depending on the capacity and speed of the disk. The number of passes are determined by the 'N' command. This command reads 64K bytes in each read operation. A butterfly pattern is used, with successive read operations alternating from the next lowest unread address to the next highest unread address until the entire disk has been read tested. If an error occurs, the logical blocks within the 64K block are read successively. For each logical block that can not be read, an error is reported, and if autosparing has been selected, the block is spared.
<input type="text" value="B"/>	Block read. Display the contents of the disk block in hex.
<input type="text" value="N"/>	Select the number of passes that the read or Write function are to make.
<input type="text" value="I"/>	Display the inquiry data and the capacity of the disk.
<input type="text" value="L"/>	Display the drive's log information. This function is only available on HP fixed drives. It uses the Access Log HP specific SCSI command to report the data logged by the disk drive itself.
<input type="text" value="S"/>	Run Self-test. This can take up to a minute on some drives. Note that if it is run on the root disk, the controller will effectively lock up until the test completes. The operations performed by this self-test vary from drive to drive, but it is not destructive.
<input type="text" value="C"/>	Enter CE mode. The user is prompted for a password, which is the same as the password used to enter CE mode in the CS80 exerciser. This mode allows the user to perform tasks which can erase data on the disks.
<input type="text" value="Q"/>	Exit the program.

CE Mode Functions. CE Mode functions are listed in Table 6-9.

Table 6-9. SCSI Exerciser CE Mode Functions

Key	Exerciser Description
Ⓜ	Write pattern on entire disk, and then perform read check. The pattern is selected by the 'P' command. The number of passes made is determined by the 'N' command. Like the read command, writes are performed in 64K byte blocks. A butterfly pattern is used, with successive write operations alternating from the next lowest unwritten address to the next highest unwritten address until the entire disk has been write tested. If an error occurs, the logical blocks within the 64K block are written to successively. For each logical block that can not be written, an error is reported, and if autosparing has been selected, the block is spared. For each pass, the write operation described above is followed by the read test described under 'R' above.
Ⓟ	Select pattern for write test. The choices are: <ul style="list-style-type: none"> ■ Worst case: A pattern of C9E3 hex ■ Random: Random data ■ User defined: The user enters a 4 hex digit pattern
Ⓐ	Auto sparing enable. In this mode, if a read or write error occurs, the program automatically attempts to spare the block in which the error occurred. Note that this can potentially corrupt the root disk. The Reassign Block SCSI command is used.
Ⓣ	Test block. The data in the specified logical block is read, the current pattern is written and verified, and the original data is restored. Note that if the initial data can not be read, but if the final write is successful, bad data will be left in a block that is readable.
Ⓜ	Manually spare a block. The user is prompted for the logical address of the block to be spared. Note that this potentially corrupt the root disk. The Reassign Block SCSI command is used.
ⓧ	Display defect list. This is physical addresses of the disk blocks which have been spared. Both the primary spares made at disk manufacture, and the grown list of spares made since that time are displayed. The Read Defect Data SCSI command is used.
Ⓩ	Clear the drive logs. This applies to HP fixed drives only. The Access Logs HP specific SCSI command is used to clear the log information maintained within the drive.
ⓕ	Format media. Either all spares can be retained, or just the primary spares made when the disk was manufactured can be retained. The Format Unit SCSI command is used.

Controller Checkout Procedures

Checkout Procedures for Model 362/382 Controllers

This section provides the following hardware checkout procedures for Model 362/382 controllers:

- Power Supply Verification.
- CE.utilities.

Caution Make sure that you are properly grounded before you attempt any of the following procedures. Use an anti-static mat with anti-static wrist straps and other static prevention devices whenever possible.

You must remove the controller cover to perform the following procedures.

Note Always replace the controller cover during troubleshooting sessions if the controller is to run for an extended period of time. The controller cover is used to maintain proper air flow cooling within the controller.

With the controller having a system board and power supply as the minimum configuration, check the voltages at the power connector on the top edge of the backplane board. Table 6-10 lists the voltages and their tolerances.

Table 6-10.
Voltage Test Points and Tolerances
Red Wire to Pin 1

Pin	Voltage	Lower Limit	Upper Limit	Pin	Voltage	Lower Limit	Upper Limit
1	+5 Reg.	4.95	5.25	8	-12	-11.5	-13.2
2	+5 SCSI	4.95	5.25	9	+5 Reg.	4.95	5.25
3	Ground			10	Remote ON		
4	+12 Fan	11.4	13.2	11	Ground		
5	+5 Reg.	4.95	5.25	12	(Key)		
6	+12 Reg.	11.52	12.6	13	Ground		
7	+5 Aux.	4.75	5.25	14	Ground		

Note If any voltage is out of tolerance or not present, the entire power supply assembly is replaced. There are no field replaceable fuses in the controller.

Using The HP-UX ce.utilities

Follow these steps to use the HP-UX ce.utilities:

1. If not already connected, connect a tape drive on the controller for the System Support Tape.
2. From the Auto System Select Mode note the tape drive with the System Support Tape with these operating systems:

SYSTEM_SF

SYSTEM_S3

3. Select SYSTEM_SF as the temporary operating system to boot if you want to run the Series 300 System Functional Tests.
4. Select SYSTEM_S3 as the temporary operating system to boot if you want to run the Series 300 Controller Tests.
5. Refer to the System Support Tape User's Guide and the Series 300 Test Tools Manual for detailed instructions.
6. To continue and run specific CE.utilities tests, boot the HP-UX operating system. The remaining steps of this procedure can only be performed with the HP-UX operating system running.
7. To list all tests on the tape, type this command where drive is the device file name of the tape drive:

```
lifls /dev/drive /Return
```

8. To find out what files are available for a certain test, type this command:

```
lifcp -r /dev/drive: filename1 - | cpio -ictv /Return
```

where filename1 is one of these four CE.utility tests:

CRTADJ	FLOAT	ECC
	SFT	

Note CS/80, VME, HP 98720A and HP98730A tests are not supported on Model 362/382 controllers. Also, the ECC test only applies to the Model 382, as the Model 362 does not have ECC memory.

9. If you want to list the file names for a specific ce.utility test in a new file, type this command where filename2 is the name of the file you want to list the files in:

```
lifcp -r /dev/drive: filename1 - | cpio -ictv filename2 /Return
```

10. To list the files type the command:

```
more filename2 /Return
```

11. To find out what CE.utilities tests are already on the HP-UX operating system, type one of these command sets:

```
cd /usr/diag/CE.utilities  
```

```
ls  
```

or

```
cd /usr/diag/install  
```

```
ls  
```

12. If you want to run a test that is not already on HP-UX, you must first copy the test from the tape to the HP-UX file system. A new directory, /usr/CE.utilities, will automatically be created and the files from the tape will be copied into it. Type this command where test is one of the eight test files you want to copy from the tape to the file system:

```
lifcp -r /dev/drive:test - | cpio -icdvxm  
```

Information on each CE.utility test may be found as follows:

- a. CRTADJ: refer to System Support Tape User's Guide.
- b. FLOAT: type these commands

```
cd /usr/CE.utilities/Floatcard  
```

```
./help  
```

and a help file will appear on the screen.

- c. SFT: refer to the Series 300 Test Tools Manual.
- d. ECC: type these commands:

```
cd /etc  
```

```
man ecclogger  
```

for information on setting up and execution the ECC tests.

Refer to the *System Support Tape User's Guide* and the *Series 300 Test Tools Manual* for detailed information on running the CE.utilities.



Parts Lists

Introduction

Field replaceable parts are listed in this chapter for these products:

- Model 362 Controller.
- Model 382 Controller.
- HP A2246A DIO-I Bus Expander.
- HP A2247A DIO-II Bus Expander.



computer. Components, such as ICs, are not available for field repair.

Parts are available direct from:

Support Materials Organization
 Hewlett-Packard Company
 8050 Foothills Boulevard
 Roseville, California 95678 USA
 Telephone: (916) 786-8000

Parts may be ordered through your local Hewlett-Packard Sales and Service Office. To help get parts as soon as possible, please write the address and telephone number of your local Hewlett-Packard Office in the spaces below.

Name: _____

Address: _____

City, State ZIP: _____

Telephone No. _____

Exchange Parts

Exchange parts are available for some items at a reduced cost. When an exchange part is ordered, your account will be charged for a new part.

Place failed exchange parts in anti-static bags and package them securely in a sturdy container. It's a good idea to save the containers and static-free bags you receive parts in and use them to ship parts in. Please return failed exchange parts to your local HP Sales and Service Office as soon as possible. Customers have 15 days to return the failed part to receive credit for the difference between a new and exchange part.

Model 362 and 382 Controllers

The parts listed in this section apply to only the HP 9000 Series 300 Model 362 and 382 Controllers. Refer to Figure 7-1 for reference numbers and parts identification.

Table 7-1. Model 362 and 382 Controller Electrical Parts List

Ref. No.	Description	New Part Number	Exchange Part Number	Notes
1	Power supply	0950-2119		
2a	System board	A1473-66510	A1473-69510	for Model 362
2b	System Board, VGA graphics	A1474-66510	A1474-69510	for Model 382
2c	System Board, Med-res. graphics	A1474-66511	A1474-69511	for Model 382
3a	HP 98236A 2 Mbyte RAM board	98236-66520	98236-66520	for Model 382
3b	HP 98236B 4 Mbyte RAM board	98236-66522	98236-66522	for Model 382
3c	HP 98236C 8 Mbyte RAM board	98236-66524	98236-66524	for Model 382
4a	HP D2381A 2 Mbyte RAM board	D2381-63001		for Model 362
4b	HP D2156A 4 Mbyte RAM board	D2156-63001	D2156-69001	for Model 362
4c	HP D2152A 8 Mbyte RAM board	D2152-63001	D2152-69001	for Model 362
5	LAN board	A1473-66530		
6	DIO-I backplane board	A1473-66501		
7	3.5-in. flexible disk drive	0950-2118		
8	Flex disk drive power cable	A1499-62020		
9	210 Mbyte hard disk drive	0950-2223		
10	420 Mbyte hard disk drive	0950-2168		
11	CD ROM disk drive	1150-1832		
12	52 Mbyte hard disk drive	0950-2247		
13	Power switch assembly	A1473-61601		
14	HP Parallel ribbon cable	A1473-61604		
15a	SCSI cable, internal	A1473-61602		Internal drives only
15b	SCSI cable, internal/external	A1473-61603		Internal drives and rear panel
16	Fan	5180-0496		

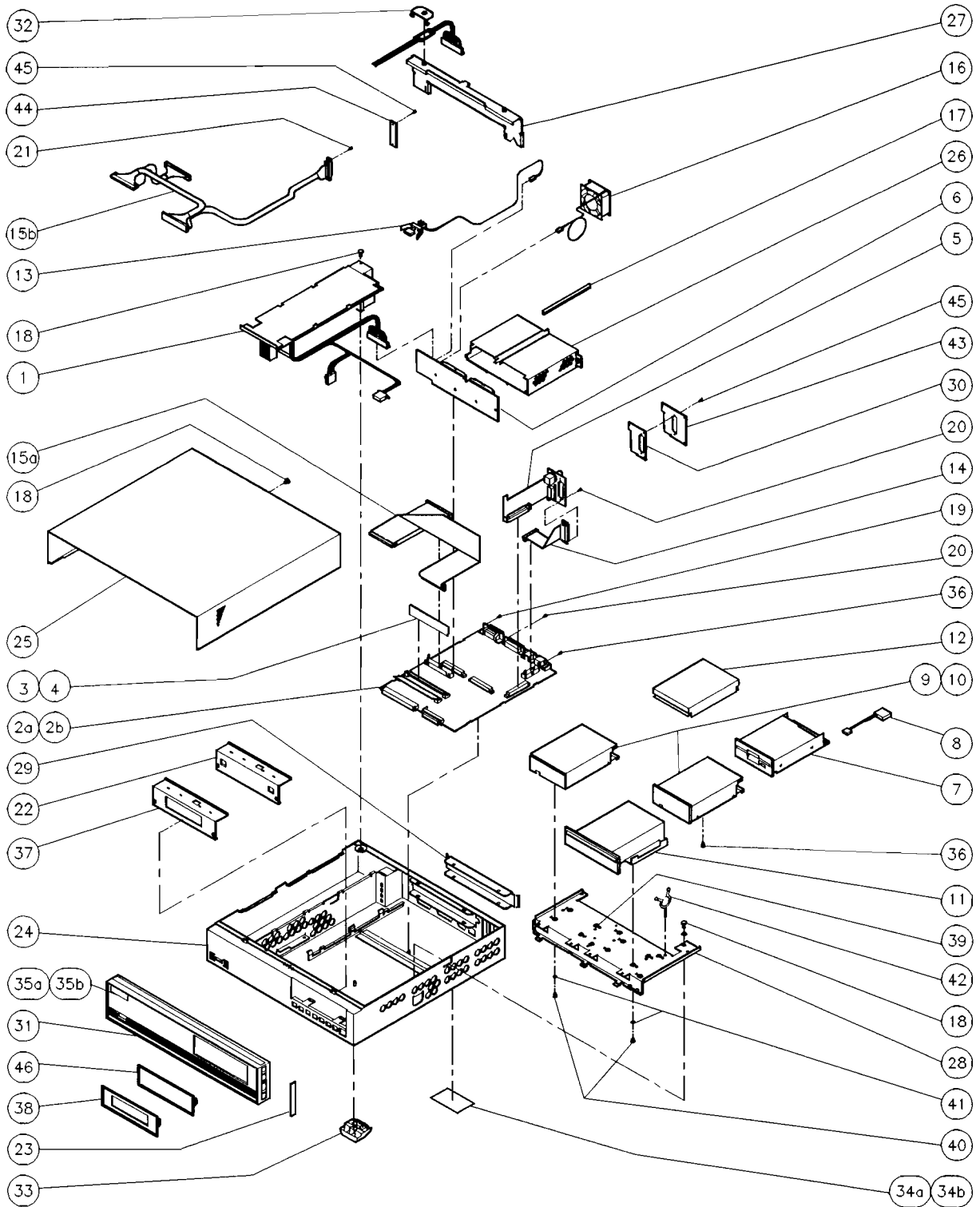

Figure 7-1. Model 362 and 382 Controller Exploded View

Table 7-2. Model 362 and 382 Controller Mechanical Parts List

Ref.	Description	Part Number	Notes
17	Card guide snap mount	007689	
18	Screw; M4X6 pan head	015933	
19	Jackscrew; HP-IB connector	0380-0643	
20	Jackscrew; interface connector	0380-3087	
21	SCSI jack screw	5180-1344	
22	Mass storage RFI cover plate	5001-7478	
23	Side trim	5001-0538	
24	Chassis	5001-7466	
25	Top cover	5001-7467	
26	DIO-I card cage	5001-7468	
27	DIO-I card cage support	5001-7469	
28	Mass storage tray	5001-7470	
29	DIO-I slot cover plate	5001-7473	
30	LAN RFI cover plate	5002-2107	
31	Front panel (bezel)	5041-2490	
32	Wire hold-down	5041-2497	
33	Foot	5041-8801	
34a	UL/CSA label; Model 362	A1473-84001	
34b	UL/CSA label; Model 382	A1474-84001	
34c	Regulatory label		
34d	Battery warning label		
35a	Nameplate (front panel)	A1473-84002	for Model 362
35b	Nameplate (front panel)	A1474-84002	for Model 382
36	Screw; M3X.0.5	0515-1146	
37	Flexible drive RFI cover plate	5001-7487	

Table 7-2. Model 362 and 382 Controller Mechanical Parts List (continued)

Ref.	Description	Part Number	Notes
38	Flex disk drive filler plate	5041-2493	
39	Hard disk isolation grommet	0400-0353	
40	Shoulder screw	3030-0994	
41	Washer	3050-0893	
42	Cable clamp	1400-1547	
43	SCSI/LAN RFI cover plate	5001-7474	
44	SCSI RFI cover plate	A1630-00028	
45	Screw, LAN/SCSI RFI cover plate	0380-3070	
46	Blank trim plate	5041-2492	

HP A2246A DIO-I Bus Expander

The parts listed in this section apply to only the HP A2246A DIO-i 4-Slot Bus Expander. Refer to Figure 7-2 for reference numbers and parts identification.

Table 7-3. HP A2246A DIO-I Bus Expander Parts List

Ref. No.	Description	New Part Number	Notes
1	Power supply	0950-2119	
2	Fan	5180-0496	
3	Power cord adapter	8120-1575	
4	DIO-I backplane	A1474-66501	
5	Screw, M4X6 #1 Phillips	015933	
6	Bushing	0400-0215	
7	Screw, M3X6 flat-head	0515-0219	
8	Screw, M3X12	0515-0408	
9	Chassis	5001-7481	
10	Top cover	5001-7482	
11	System board support	5001-7483	
12	Right card guide	5001-7484	
13	Left card guide	5001-7485	
14	Safety shield	5001-7486	
15	Cable shield	5001-7487	
16	Mounting standoff	5001-7495	
17	Gang card guide	5041-2414	
18	Front bezel, panel	5041-2491	
19	Wire hold down	5041-2497	
20	DIO-I slot blank cover	7101-0591	
21	Label ID/INFO/UL/CSA	A1474-84005	
22	Side trim panel	5001-0538	
23	Label; front panel	A1474-84004	
24	Cable clamp	1400-1547	
25	Screw; M3X0.5	0515-1146	

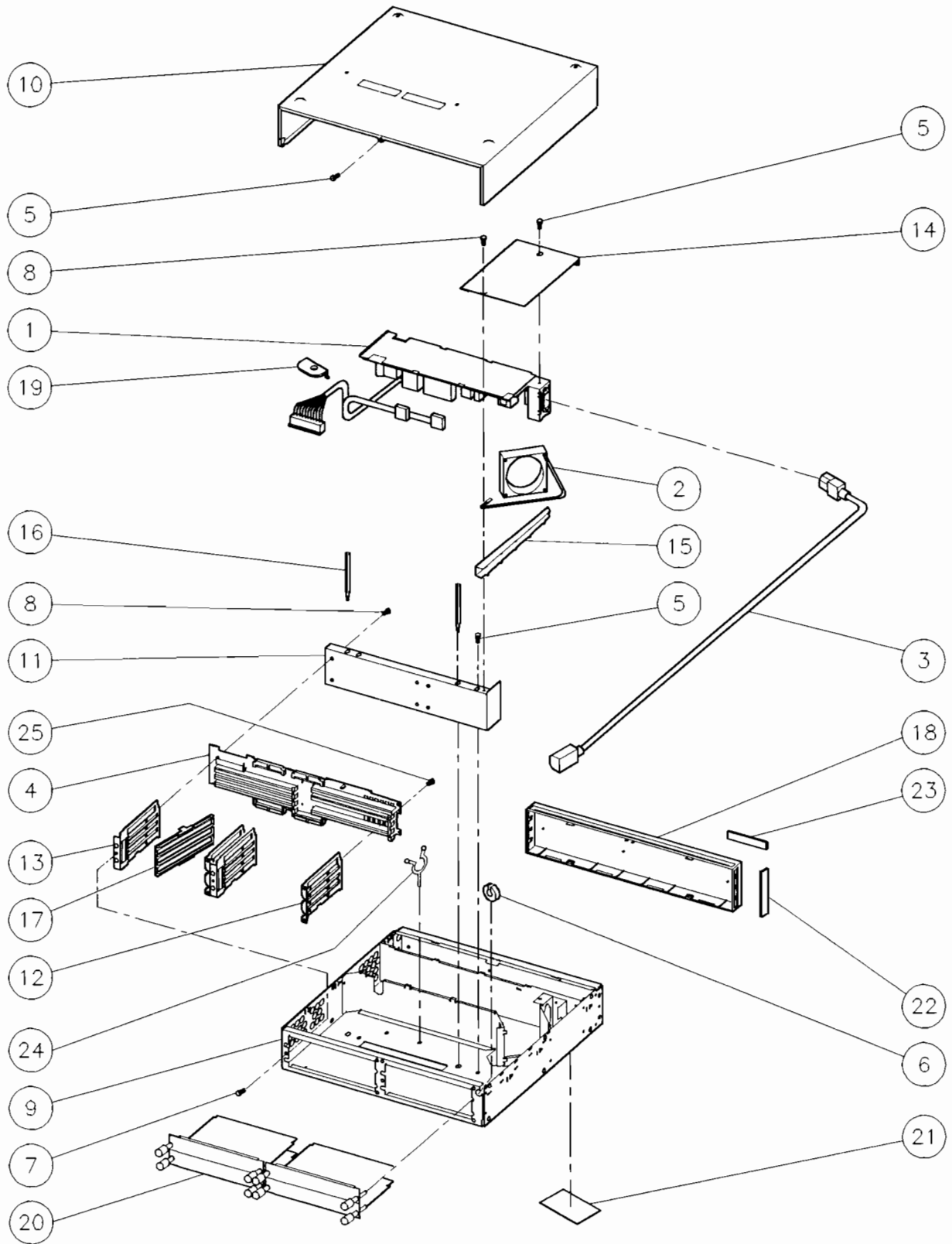

Figure 7-2. HP A2246A DIO-I Bus Expander Exploded View

HP A2247A DIO-II Bus Expander

The parts listed in this section apply to only the HP A2247A DIO-II 2-Slot Bus Expander. Refer to Figure 7-3 for reference numbers and parts identification.

Table 7-4. HP A2247A DIO-II Bus Expander Parts List

Ref. No.	Description	New Part Number	Notes
1	Power supply	0950-2119	
2	Fan	5180-5246	
3	Flex circuit	A1474-66502	
4	Screw, M3X6 flat-head	0515-0219	
5	Screw, M4X6 #1 Phillips	015933	
6	Screw, M3X.0.5	0515-1146	
7	Top cover	5001-7482	
8	Chassis	5001-7488	
9	Top flex support	5001-7489	
10	Screw; M3X12	0515-0418	
11	Card cage	5001-7491	
12	Bottom flex support	5001-7492	
13	Mounting standoff	5001-7495	
14	Label, front panel	A1474-84004	
15	DIO-II slot blank cover	98561-04107	
16	Label, ID/INFO/UL/CSA	A1474-84006	
17	Side trim panel	5001-0538	
18	Cable clamp	1400-1547	
19	Front panel	5041-2491	
20	Backplane support	5001-7490	

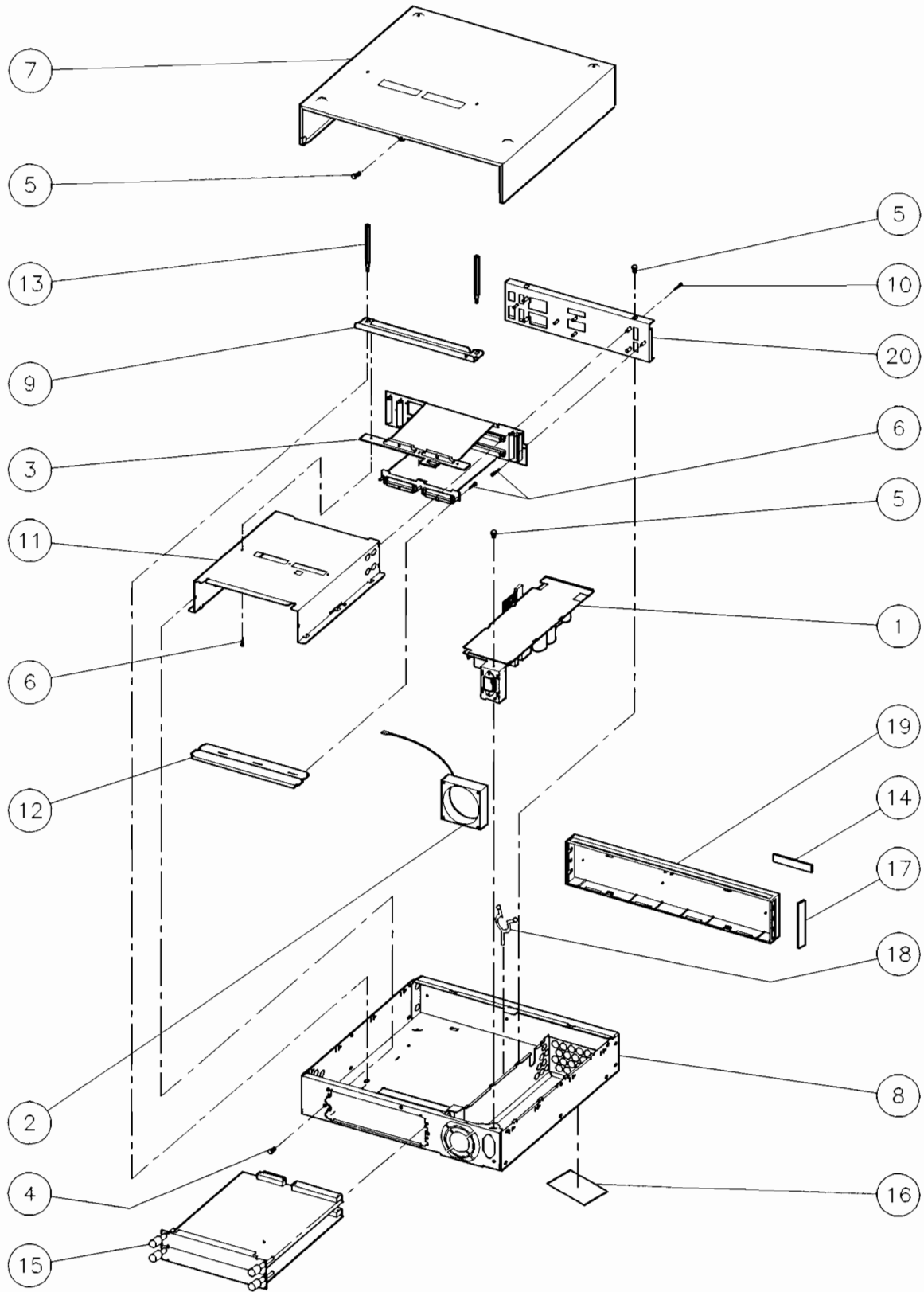

Figure 7-3. HP A2247A DIO-II Bus Expander Exploded View



Reference Documentation

Introduction

Information in this chapter should help you in various situations. The references include part numbers of many hardware documents relating to these products:

- System bundles
- Bus Expanders.
- Upgrades, including:
 - RAM.
 - Internal mass storage.
 - Interface.
 - Co-processor.

Service Documentation

Table 8-1. Related Service Documentation

Manual Title	Part Number
HP 9000 Model 362/382 Controller and HP A2246/7A Bus Expanders Service Manual	A1473-90030
HP 9000 Model 362/382 Controller and HP A2246/7A Bus Expanders Service Handbook	A1473-90039
HP 9000 Model 362/382 Controller and HP A2246/7A Bus Expanders Service Training Video Workbook	A1473+49A-90001
HP D1182A 14-in. VGA Color Monitor Service Manual	D1182-90002
Servicing Hewlett-Packard Workstation Monitors (for HP C1497A 16-in Color Monitor)	5960-1511

System Installation and Getting Started Documentation

Table 8-2. System Installation and Getting Started Documentation

Manual Title	Part Number
Installation Guide; Model 362/382 Controller and HP A2246/7 Bus Expanders	A1473-90010
Model 382 and R/382 Controller HP-UX Owner's Guide	A1473-90011
Installing & Maintaining BASIC/WS 6.2	98616-90100

Upgrade Documentation

Table 8-3. Upgrade Documentation

Manual Title	Part Number
HP A2252A 3.5-in. Flexible Disk Drive Upgrade Installation Guide	A2252-90010
HP A2253A CD ROM Disk Drive Upgrade Installation Guide	A2253-90010
HP A2254A DDS Tape Drive Upgrade Installation Guide	A2254-90010
HP A2255A LAN Interface Upgrade Installation Guide	A2255-90010
HP A2256A SCSI External Interface Upgrade Installation Guide	A2256-90010
HP A2257A 52 Mbyte Hard Disk Drive Upgrade Installation Guide	A2257-90010
HP A2258A 210 Mbyte and HP A2259A 420 Mbyte Hard Disk Drives Drive Upgrade Installation Guide	A2258-90010
Model 362 Controller Memory Installation Guide	A1473-90012
HP A2246A 4-Slot Bus Expander Installation Guide	A2246-90010
HP A2247A 2-Slot Bus Expander Installation Guide	A2247-90010
HP A2200/1/2A Memory Upgrade	A2200-90011
HP A2244A System Board Upgrade	A2244-90010
HP A2249A Floating-Point Accelerator Upgrade Installation Guide	A2249-90010



Index

A

- assembly access
 - controller accessory cards, 2-6
 - controller CD ROM disk drives, 2-23
 - controller DIO backplane board, 2-15
 - controller DIO-I card cage and backplane, 2-13
 - controller external SCSI cable, 2-41
 - controller fan, 2-39
 - controller feet, 2-38
 - controller flexible disk drives, 2-20
 - controller front panel, 2-36
 - controller hard disk drives, 2-17
 - controller LAN board, 2-28
 - controller mass storage trim plate, 2-45
 - controller overview, 2-3
 - controller parts reference, 2-4
 - controller power supply, 2-34
 - controller power switch assembly, 2-43
 - controller RAM boards, 2-9
 - controller RTC battery, 2-26
 - controller system board, 2-31
 - controller top cover, 2-7
 - DIO-I expander card cage, 2-62
 - DIO-I expander fan, 2-56
 - DIO-I expander front panel, 2-65
 - DIO-I expander parts reference, 2-46
 - DIO-I expander power supply, 2-59
 - DIO-II expander card cage, 2-74
 - DIO-II expander fan, 2-71
 - DIO-II expander parts reference, 2-49
 - DIO-II expander power supply, 2-69
 - DIO-II flexible backplane, 2-76
 - DIO-II power cable assembly, 2-67
 - expander accessory cards, 2-51
 - expander overview, 2-46
 - expander top cover, 2-52
 - removing an expander from a controller, 2-54

B

- Boot mode selection
 - auto system select, 5-7
- boot ROM
 - displayed messages, 4-7
 - functions, 4-1

- human interfaces, 4-3
- power up displays, 4-1
- power-up sequence, 4-2
- self-tests, 4-6

C

- configuration
 - A2258A and A2259A hard disk drive
 - configuration jumpers explained, 5-12
 - CD ROM disk drive jumpers, 5-16
 - determining HP-UX existing SCSI bus addresses, 5-11
 - external SCSI device cables, 5-18
 - flexible disk drive jumpers, 5-14
 - flexible drive configuration jumpers explained, 5-14
 - hard disk drive configuration jumpers
 - explained, 5-13
 - hard disk drive jumpers, 5-12, 5-13
 - HP-UX program to find SCSI bus addresses, 5-11
 - interfaces; HP-HIL restrictions, 3-14
 - interfaces; HP Parallel defaults, 3-13
 - interfaces; LAN defaults, 3-12
 - interfaces; SCSI defaults, 3-10
 - keyboard differences, 5-1
 - power-up displays, 5-3
 - RAM boards, 3-17, 3-18
 - SCSI address recommendations, 3-10
 - setting drive jumpers, 5-13
 - setting flexible drive bus address jumpers, 5-16
 - setting flexible drive function jumpers, 5-16
 - setting hard disk drive bus address jumpers, 5-13
 - setting PRTY jumpers, 5-17
 - setting SCSI bus address jumpers, 5-17
 - supported RAM, 3-17, 3-18
- configuration mode
 - error messages, 5-9
- configure mode
 - control menu explained, 5-3
 - entering, 5-3

D

- diagnostics
 - boot ROM state and failure LED codes, 6-9
 - LED failure code descriptions, 6-8
 - SCSI testing, 6-16
 - UNEXPECTED use of errors, 6-6
 - using ce.utilities, 6-20
- diagrams
 - controller exploded view, 7-3
 - DIO-I expander exploded view, 7-7
 - DIO-II expander exploded view, 7-9

E

- external SCSI cables
 - configuration information, 5-18

F

- features
 - audio interface, 1-5
 - BASIC keyboards, 1-4
 - built-in interfaces, 1-3
 - controller, 1-2
 - graphics, 1-3
 - hardware architecture, 1-6
 - HP-HIL interface, 1-4
 - HP-IB interface, 1-5
 - HP Parallel interface, 1-4
 - HP-UX keyboards, 1-4
 - HP-UX operating systems, 1-7
 - internal mass storage, 1-5
 - LAN, 1-4
 - memory, 1-3
 - RS-232 interface, 1-4
 - SCSI interface, 1-4
 - supported internal mass storage devices, 1-5
- functional description
 - audio interface, 3-15
 - backplane board, 3-19
 - CD ROM disk drive, 3-25
 - controller power distribution, 3-3
 - cpu, 3-4
 - DIO-II controller, 3-9
 - functional assemblies, 3-1
 - graphics, 3-6
 - hard disk drives, 3-20
 - HP-HIL interface, 3-14
 - HP-IB interface, 3-14
 - HP Parallel interface, 3-13
 - LAN interface, 3-11
 - memory controller, 3-7
 - overview, 3-1
 - power supply, 3-3
 - RAM boards, 3-16
 - RS-232 interface, 3-15

- SCSI interface, 3-9
- system board, 3-4

I

- internal interfaces
 - configuring, 5-4
 - default configurations, 5-5
 - example configuration, 5-5
 - menu explained, 5-4, 5-6

L

- LED displays
 - failure indications, 4-6

O

- operation
 - getting extra disk caddies, 3-25
 - opening the caddy shutter, 3-25

P

- parts lists
 - controller mechanical parts, 7-3
 - DIO-I expander, 7-6
 - DIO-II expander, 7-8
 - electrical parts, 7-2
 - exchange parts information, 7-1
 - parts availability, 7-1
- product
 - description, 1-1

R

- related documentation
 - installation and getting started, 8-2
 - service documentation, 8-1
 - upgrades, 8-2

S

- safety
 - electrical, 2-2
 - mechanical, 2-2
- SCSI cables
 - installation rules, 5-18
- self-tests
 - Overview, 6-6
- support
 - hardware support, 1-11
 - schematics, 1-11
 - support and repair philosophy, 1-11
- systems
 - BASIC; product numbers, 1-8
 - BASIC; product structured to, 1-8
 - bundles, 1-8
 - HP-UX; product numbers, 1-8
 - HP-UX; product structured to, 1-8

HP VEE-TEST; product numbers, 1-8
HP VEE-TEST; product structured to, 1-8

T

technical information

access time, 3-26
altitude requirements, 3-22, 3-24, 3-27
ambient relative humidity requirements, 3-22,
3-24
ambient temperature requirements, 3-21, 3-24
controller data transfer rate, 3-26
data transfer rate, 3-21, 3-23
electrical, 1-9
environmental, 1-10
functional, 3-24, 3-26
graphics circuit, 3-6
HP Parallel interface, 3-13
LAN interface, 3-13

media, 3-27
physical, 1-10
regulatory, 1-9
RS-232 interface, 3-16
SCSI interface, 3-11
seek times, 3-21
specifications, 3-26
temperature requirements, 3-27

tools

required for assembly replacement, 2-1

troubleshooting

analytic troubleshooting, 6-1
flowcharts, 6-3
HP-UX; booting problems, 6-4
introduction, 6-1
memory configurations/addressing, 6-13
operating system types, 6-2

