



# **HP 3000 Series III CE HANDBOOK**

**GENERAL SYSTEMS DIVISION  
19447 PRUNERIDGE AVE.  
CUPERTINO, CALIFORNIA 95014**

**Part No. 30000-90172  
3HDWR.320.30000-90172**

**Printed in U.S.A.  
12/79**

**HP Computer Museum**  
**[www.hpmuseum.net](http://www.hpmuseum.net)**

**For research and education purposes only.**

## PROPERTY OF

NAME \_\_\_\_\_

ADDRESS \_\_\_\_\_

CITY \_\_\_\_\_

STATE \_\_\_\_\_ ZIP \_\_\_\_\_

AREA CODE \_\_\_\_\_ TELEPHONE \_\_\_\_\_

### NOTICE

The information contained in this document is subject to change without notice.

HEWLETT-PACKARD MAKES NO WARRANTY OF ANY KIND WITH REGARD TO THIS MATERIAL, INCLUDING, BUT NOT LIMITED TO, THE IMPLIED WARRANTIES OF MERCHANTABILITY AND FITNESS FOR A PARTICULAR PURPOSE. Hewlett-Packard shall not be liable for errors contained herein or for incidental or consequential damages in connection with the furnishing, performance or use of this material.

This document contains proprietary information which is protected by copyright. All rights are reserved. No part of this document may be photocopied or reproduced without the prior written consent of Hewlett-Packard Company.

Copyright ©1979 by HEWLETT-PACKARD COMPANY

# MANUAL UPDATE

## MANUAL IDENTIFICATION

Part Number: 30000-90172  
Print Date: 12/79  
Title: HP 3000 Series III  
CE Handbook

## UPDATE IDENTIFICATION

Update Number: 2  
Print Date: 7/81

## THE PURPOSE OF THIS MANUAL UPDATE

is to accumulate all changes to the current edition of the manual. Earlier updates, if any, are contained herein. This update consists of: this cover letter, a revised "List of Effective Pages," and all new and changed pages (backup pages are provided when necessary).

## CHANGED PAGES ARE IDENTIFIED

by the date of the update at the bottom of the page and a vertical bar in the outside margin opposite the changed material.

## NEW PAGES ARE IDENTIFIED

by the date of the update at the bottom of the page. "New" pages are those which were not present in the original edition of the manual.

## TO UPDATE YOUR MANUAL,

replace change pages with the update pages and insert any new pages. Destroy all replaced pages. In the case of SECTION VII, DATA COMMUNICATIONS, remove all pages in the section, and replace them with new page 7-1 only.

## HOW TO OBTAIN MANUAL UPDATES

If you need copies of this update, or any other update, please give the name of the manual, its part number, number of copies, and state clearly that you require the update, not the complete manual. There is no charge for manual updates. Send your request to:

Manuals/Software Dept. (Computer Systems Division)  
Hewlett-Packard Company  
19447 Pruneridge Ave.  
Cupertino, CA 95014



HEWLETT-PACKARD COMPANY  
19447 PRUNERIDGE AVE., CUPERTINO, CALIFORNIA 95014



## LIST OF EFFECTIVE PAGES

The List of Effective Pages gives the date of the current edition and of any pages changed in updates to that edition. Within the manual, any page changed since the last edition is indicated by printing the date the changes were made on the bottom of the page. Changes are marked with a vertical bar in the margin. If an update is incorporated when an edition is reprinted, these bars are removed but the dates remain. No information is incorporated into a reprinting unless it appears as a prior update.

Front Cover .....	Original
Title Page .....	4/81
ii, iii .....	4/81
iv .....	4/81
v .....	Original
vi .....	4/81
1-1 thru 1-2 .....	Original
1-3 thru 1-4 .....	4/81
1-5 thru 1-6 .....	4/81
1-7 thru 1-8 .....	4/81
1-9 thru 1-31 .....	Original
1-32 .....	4/81
1-33 thru 1-56 .....	Original
2-1 thru 2-6 .....	Original
2-7 .....	4/81
2-8 thru 2-10 .....	Original
3-1 thru 3-10 .....	Original
4-1 .....	Original
4-1 .....	4/81
4-3 thru 4-4 .....	Original
4-5 .....	4/81
4-6 thru 4-22 .....	Original
5-1 .....	Original
5-2 .....	4/81
5-3 .....	3/80
5-4 .....	4/81
5-5 thru 5-24 .....	Original
5-25 .....	3/80
5-26 thru 5-28 .....	Original
6-1 .....	Original
6-2 .....	3/80
6-3 thru 6-8 .....	Original
6-9 thru 6-10 .....	4/81
6-11 thru 6-18 .....	Original
7-1 .....	4/81
7-2 .....	Blank
8-1 .....	Original
8-2 .....	4/81
8-3 thru 8-51 .....	Original
8-52 thru 8-52D .....	3/80
8-53 thru 8-64 .....	Original
8-65 thru 8-72 .....	4/81
9-1 .....	4/81
9-2 thru 9-40 .....	Original
10-1 thru 10-50 .....	Original
11-1 thru 11-20 .....	Original

## PRINTING HISTORY

New editions are complete revisions of the manual. Update packages, which are issued between editions, contain additional and replacement pages to be merged into the manual by the customer. The date on the title page and back cover of the manual changes only when a new edition is published. When an edition is reprinted, all the prior updates to the edition are incorporated. No information is incorporated into a reprinting unless it appears as a prior update. The edition does not change.

The software product part number printed alongside the date indicates the version and update level of the software product at the time the manual edition or update was issued. Many product updates and fixes do not require manual changes, and conversely, manual corrections may be done without accompanying product changes. Therefore, do not expect a one to one correspondence between product updates and manual updates.

First Edition .....	Dec 1979
Update No.1 .....	Mar 1980
Update No.2 .....	Jul 1981

## PREFACE

This handbook has been prepared for the Hewlett Packard Customer Engineer. It contains a collection of frequently used system and subsystem data items which are used in servicing and troubleshooting the HP 3000 Series III Computer System.

The content of this handbook is arranged into eleven logical sections. Each section is separated by an index tab. The first page of each section contains a table of contents for the section.

Throughout this handbook, some of the data items carry a three-letter reference code. This reference code is a directory to the manual in which the data item originally appeared. If you require additional information about a referenced data item, refer to the manual designated by the three-letter code. The following manuals are referenced from this handbook:

The following is an alphabetic listing of the manuals referenced from this handbook

EDS Engineering Diagrams Set, part no. 30000-90141  
OPR Console Operator's Guide, part no. 30000-90013  
RTM System Reference/Training Manual, part no. 30000-90143  
SIM System Installation Manual, part no. 30000-90147  
SML System Microprogram Listing, part no. 30000-90136  
SUP System Manager/System Supervisor Manual, part no. 30000-90014

The organization of this handbook is as follows:

Section I - System Information contains information relative to PCA slot assignments, flat cables, flat cable terminators, and system troubleshooting aids.

Section II - Central Processor Unit contains information relative to the CPU, its PCA jumper and switch locations, system startup and backup procedures, and some basic CPU/MPE information.

Section III - Memory contains information relative to the memory module, its PCA jumper and switch locations, and its error correction capabilities.



## PREFACE (continued)

Section IV - IOP/Channels contains information relative to the IOP, Multiplexer and Selector Channels, and the Selector Channel Maintenance PCA. Included are PCA jumper and switch locations, word formats, and LED indicator locations and functions.

Section V - I/O System Configuration contains both hardware and software configuration information for the system. Included in the hardware subsection are device number assignments, service request priorities, interrupt polling and clock jumper and terminator information, and power bus backplane connections. Included in the software subsection is a list of driver names, types, subtypes, and record widths, driver configuration information, term types, and a typical I/O configuration listing.

Section VI - Power Distribution contains information relative to system ac and dc power distribution, the system power supplies, and battery care.

Section VII

Section VIII - Peripherals contains information relative to the various subsystems and devices associated with the computer system. Included are the subsystem connections, PCA jumper locations, and word formats.

Section IX - Diagnostics contains information relative to the CPU diagnostics, on-line verification programs, and non-CPU cold load diagnostics.

Section X - Contributed SLEUTH Programs contains a collection of contributed SLEUTH program listings, as well as the supported SLEUTH batch program listings for SLEUTH01, SLEUTH03, SLEUTH04, SLEUTH06, SLEUTH07, SLEUTH08, SLEUTH11, SLEUTH12, SLEUTH13, and SLEUTH14.

Section XI - Error Messages contains cold load error messages, directory errors, a list of hardware halts, and SADUTIL, LISTLOG2, and MEMLOGAN error messages.

# SYSTEM INFORMATION

SECTION

I

## Table Of Contents



Topic	Page
System Block Diagram .....	1-2
PCA Slot Assignments .....	1-3
System Flat Cables .....	1-5
Flat Cable Terminators .....	1-7
Interface Voltage and Current Configurations .....	1-9
System Troubleshooting Flowchart .....	1-10
Microdiagnostics .....	1-16
Control Panel Tests and Functions .....	1-16
CPU Register Test .....	1-16
CPU Register Codes .....	1-17
Memory Pattern Test .....	1-18
Memory Address Test .....	1-18
I/O Test (TIO) .....	1-19
I/O Test (SIO) .....	1-19
Start I/O Test .....	1-20
Mag Tape Test .....	1-20
Asynchronous Terminal Controller Subsystem Test .....	1-22
Display Memory Logging Errors Function .....	1-23
Control Panel Read/Write Memory Function .....	1-27
Display Register Function .....	1-28
Cold Load Procedure (TAPE) .....	1-29
Maintenance Panel Set-Up .....	1-29
Cold Load Troubleshooting Flowchart .....	1-30
Cold Load Listing .....	1-31
FREE2 .....	1-44
LISTLOG2 .....	1-45
WORKOUT2 .....	1-46
IOCDPNO Commands .....	1-47
SPOOK .....	1-48
DISKED2 .....	1-48
Interrupts/Traps .....	1-49
Logical/Physical Sector Address Examples .....	1-50
7905A Disc Drive .....	1-50
7920A Disc Drive .....	1-51
7925A Disc Drive .....	1-52
ASCII Code Chart .....	1-53
ASCII Character Set/Collating Sequence .....	1-55

System Information

SYSTEM BLOCK DIAGRAM

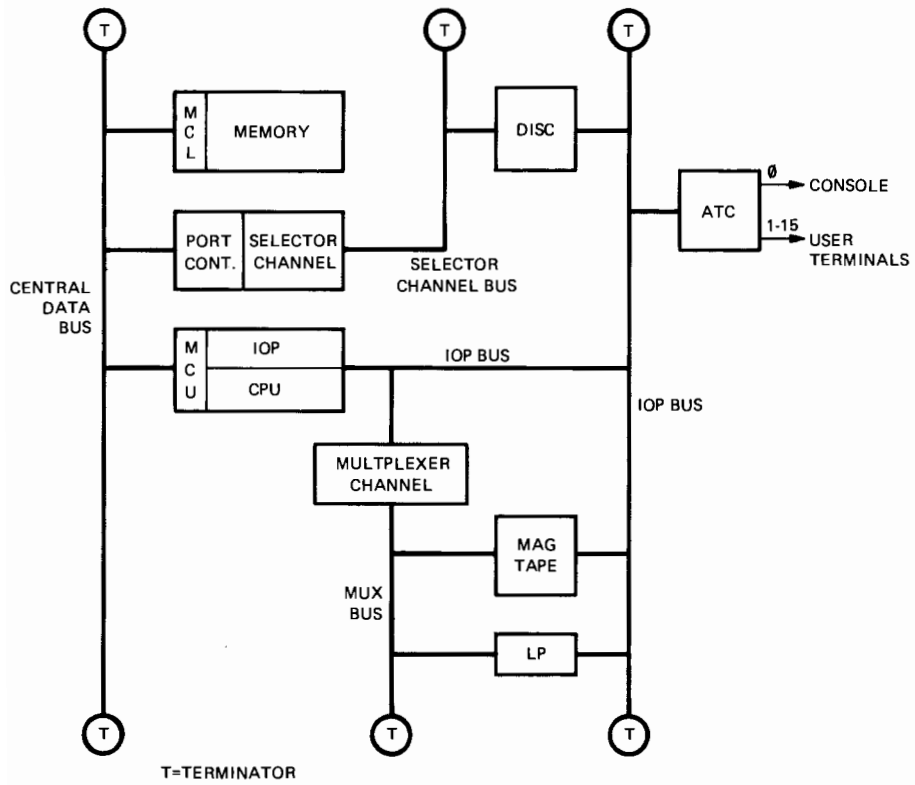

Reference: RTM

System Information

PCA SLOT ASSIGNMENTS

	Slot	PRINTED CIRCUIT ASSEMBLY
<b>CARD CAGE NO. 5</b>	A1	Available for programmed (SIO) or direct I/O
	A2	Available for programmed (SIO) or direct I/O
	A3	Available for programmed (SIO) or direct I/O
	A4	Available for programmed (SIO) or direct I/O
	A5	Available for programmed (SIO) or direct I/O
	A6	Available for programmed (SIO) or direct I/O
	A7	Available for programmed (SIO) or direct I/O
	A8	Available for programmed (SIO) or direct I/O
	A9	Available for programmed (SIO) or direct I/O
	A10	Available for programmed (SIO) or direct I/O
<b>CARD CAGE NO. 5</b>	A1	Available for programmed (SIO) or direct I/O
	A2	Available for programmed (SIO) or direct I/O
	A3	Available for programmed (SIO) or direct I/O
	A4	Available for programmed (SIO) or direct I/O
	A5	Available for programmed (SIO) or direct I/O
	A6	Available for programmed (SIO) or direct I/O
	A7	Available for programmed (SIO) or direct I/O
	A8	Available for programmed (SIO) or direct I/O
	A9	Available for programmed (SIO) or direct I/O
	A10	Available for programmed (SIO) or direct I/O

I/O BAY  
(OPTION 200)

	Slot	PRINTED CIRCUIT ASSEMBLY
<b>CARD CAGE NO. 1</b>	A1	Reserved for maintenance panel PCA.
	A2	30012-60001 Extended Instruction Set
	A3	30003-60021 Read Only Memory
	A4	30003-60022 Skip and Special Field
	A5	30003-60003 Arithmetic and Logic Unit
	A6	30003-60004 R Bus
	A7	30003-60025 S Bus
	A8	30003-60006 Current Instruction Register
	A9	30003-60007 Module Control Unit*
	A10	30003-60028 Input Output Processor
<b>CARD CAGE NO. 2</b>	A1	30008-60003 Memory Array (128K)
	A2	Available to add 128K
	A3	Available to add 128K
	A4	Available to add 128K
	A5	30007-60005 Mem. Control and Logging #1
	A6	Available to add Mem. Control and Logging #2
	A7	Available to add 128K
	A8	Available to add 128K
	A9	Available to add 128K
	A10	Available to add 128K
<b>CARD CAGE NO. 3</b>	A1	30135-60063 System Clock/FLI
	A2	30032-60001 Terminal Data Interface
	A3	30061-60001 Terminal Control Interface
	A4	30030-60020 Selector Channel Port Controller
	A5	30030-60021 Selector Channel Register
	A6	30030-60003 Selector Channel Control
	A7	30030-60011 Selector Channel Sequencer
	A8	Available for programmed (SIO) or direct I/O
	A9	Available for programmed (SIO) or direct I/O
	A10	Available for programmed (SIO) or direct I/O
<b>CARD CAGE NO. 4</b>	A1	Available for programmed (SIO) or direct I/O
	A2	Available for programmed (SIO) or direct I/O
	A3	Available for programmed (SIO) or direct I/O
	A4	Available for programmed (SIO) or direct I/O
	A5	Available for programmed (SIO) or direct I/O
	A6	Available for programmed (SIO) or direct I/O
	A7	30215-60002 Magnetic Tape Controller Processor
	A8	30215-60006 Magnetic Tape Controller
	A9	30036-60002 Multiplexer Channel
	A10	30229-60001 Disc Control Interface

CPU BAY

\* If the system includes an HP 3000 Series III 30341 A HP-IB Interface Module, the Module Control Unit PCA will have part no. 30003-60032.

Reference: EDS

JUL 1981

1-3/1-4





SYSTEM FLAT CABLES

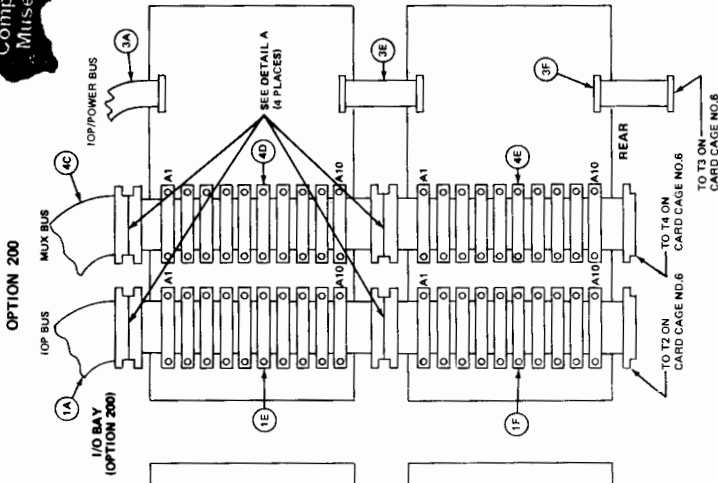

IOP BUS		PORT CONTROLLER BUS	
1A	30000-93066*	CLK/F	30000-93034
1B	30000-93034	SELECTOR CHANNEL BUS	6 30135-60029
1C	30000-93041	FRONT CABLES	7 30135-60025
1D	30000-93041*	CENTRAL CABLES	8 30000-93065
1E	30000-93041*	IOP/POWER BUS	9 30000-93053
1F	30000-93041*	TO IOP BUS INTERCONNECTION	10 30000-93053
2	30135-60029	TO IOP BUS INTERCONNECTION	11 30000-93053
3A	30000-93007	TO IOP/POWER BUS INTERCONNECTION	12 30000-93057
3B	30000-93007	TO IOP/POWER BUS INTERCONNECTION	13 30000-93052
3C	30000-93007	TO IOP/POWER BUS INTERCONNECTION	14 30000-93052
3D	30001-60034	MUX BUS	A 30229-60003
3E	30000-93005*	MUX BUS	B 30215-60003
3F	30001-60034*	MUX BUS	
4A	30135-60049		
4B	30135-60030		
4C	30000-93065*		
4D	30000-93065*		
4E	30000-93065*		

- NOTES:
1. MOVE TERMINATOR TO CARD CAGE NO. 6 FOR 2-BAY CONFIGURATION. INSTALL CABLE 1A FOR IOP BUS TO IOP BUS INTERCONNECTION.
  2. MOVE TERMINATOR TO CARD CAGE NO. 6 FOR 2-BAY CONFIGURATION. INSTALL CABLE 1A FOR IOP/POWER BUS TO IOP/POWER BUS INTERCONNECTION.
  3. MOVE TERMINATOR TO CARD CAGE NO. 6 FOR 2-BAY CONFIGURATION. INSTALL CABLE 3A FOR IOP/POWER BUS TO IOP/POWER BUS INTERCONNECTION.

BASIC SYSTEM

CPU BAY

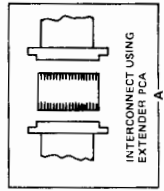
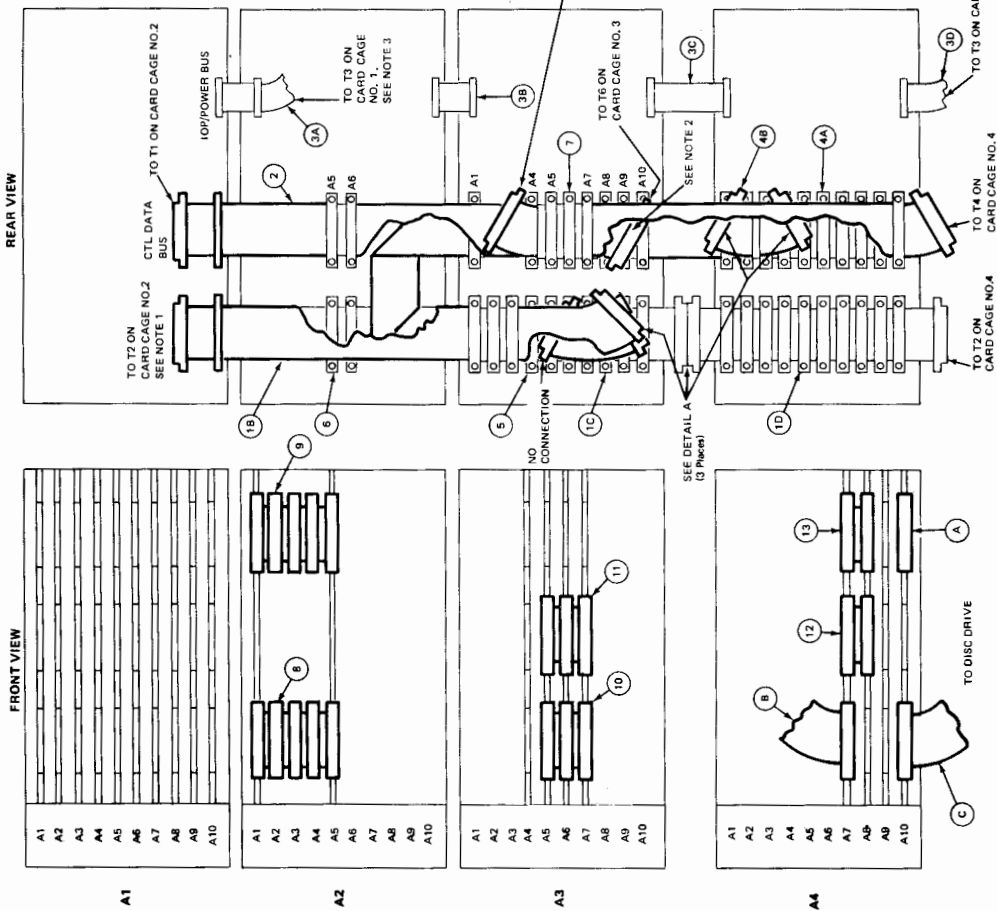

047001-23

Reference: EDS

JUL 1981

1-5/1-6

FLAT CABLE TERMINATORS

OPTION 200

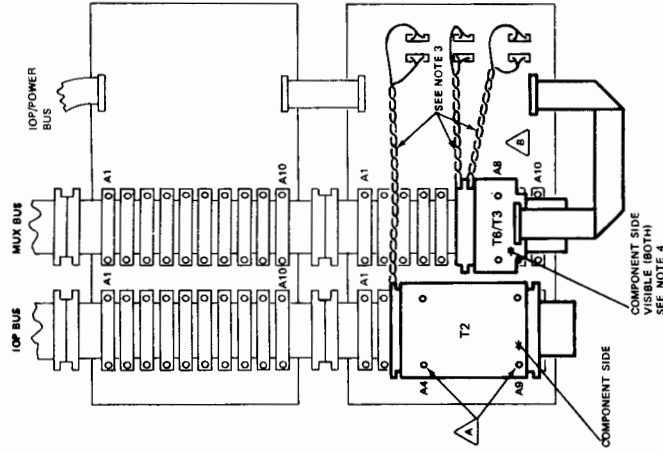

BASIC SYSTEM  
REAR VIEW

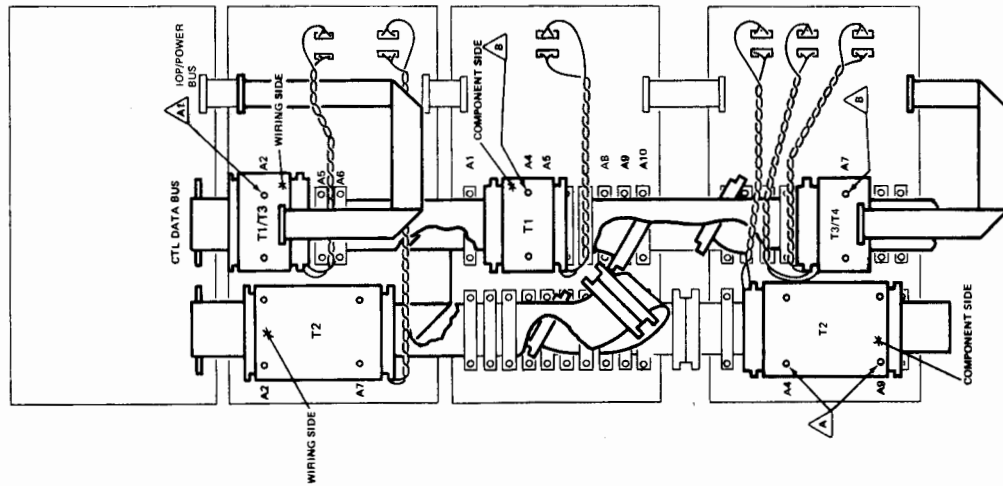

- NOTES:
- TERMINATORS ARE IDENTIFIED AS FOLLOWS:
 

TERMINATOR	QUANTITY	PART NUMBER
T1	2	30001-60016
T2	2	30001-60021
T3	1	30030-60015
T4	1	30035-60003
  - PRINTED CIRCUIT EDGE CONNECTOR (J1 OF A TERMINATOR PLUGS INTO A FLAT CABLE CONNECTOR TO TERMINATE THE CABLE RUN. CORRECT TERMINATOR ORIENTATION IS ASSURED IF YOU KEEP PINS 49 AND 50 OF THE CABLE TO THE LEFT WHEN TERMINATING THE FLAT CABLE.)
  - EACH TERMINATOR HAS A RED TWISTED PAIR CABLE WHICH CONNECTS FROM EDGE P1 OF THE TERMINATOR TO THE POWER BUS CONNECTOR. A BLACK TWISTED PAIR CABLE CONNECTS FROM THE PCA TO PINS 16 AND 15 OF THE SAME POWER BUS CONNECTOR.
  - T6/T3 - T6 IS BENEATH; T3 IS VISIBLE.
    - △ - DETAIL A, ITEMS 5,6,B
    - △ - DETAIL A, ITEMS 2,3,5,6,B
    - △ - DETAIL B
    - △ - DETAIL C
    - △ - FLAT CABLE CONNECTORS JOINED WITH EXTENDER BOARDS

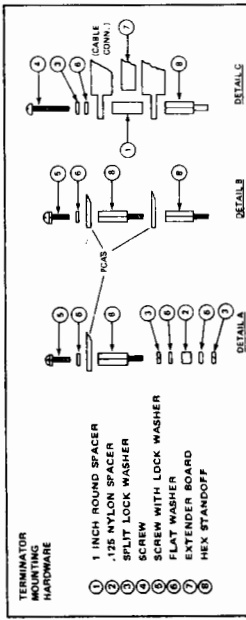

047001-22

System Information

INTERFACE VOLTAGE AND CURRENT CONFIGURATIONS

UNIT	PRODUCT NO.	+15V	+5V	-5V	-15V	TOTALS
----	-----	----	----	----	----	-----
TDI	30032	0.07	2.8	0.06	0.17	3.10A
TCI	30061	0.16	1.3	0.10	0.22	1.78A
SIO Multiplexer	30036		3.6	0.11		3.71A
Plotter Interface	30226	0.08	2.2			2.28A
SSLC	30055	0.2	3.5		0.20	3.90A
Card Reader	30206	0.1	3.3		0.006	3.406A
Disc Interface	30229		3.6			3.60A
Line Printer	30051		4.4			4.40A
Card Punch	30051		4.4			4.40A
Card Reader/Punch	30050		4.0			4.00A
Paper Tape Reader	30050		4.0			4.00A
Paper Tape Punch	30050		4.0			4.00A
Magnetic Tape Controller	30215		9.9			9.90A
HSI	30360	0.26	4.5		0.04	4.80A



SYSTEM TROUBLESHOOTING FLOWCHART

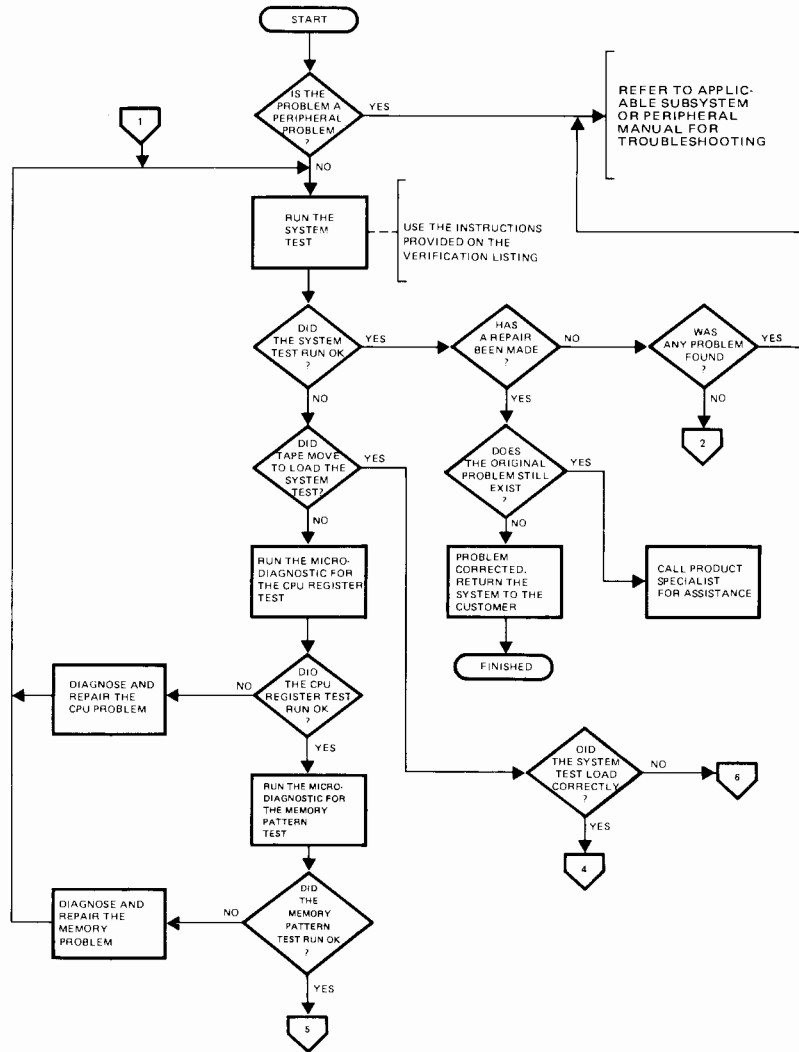

SYSTEM TROUBLESHOOTING FLOWCHART (Continued)

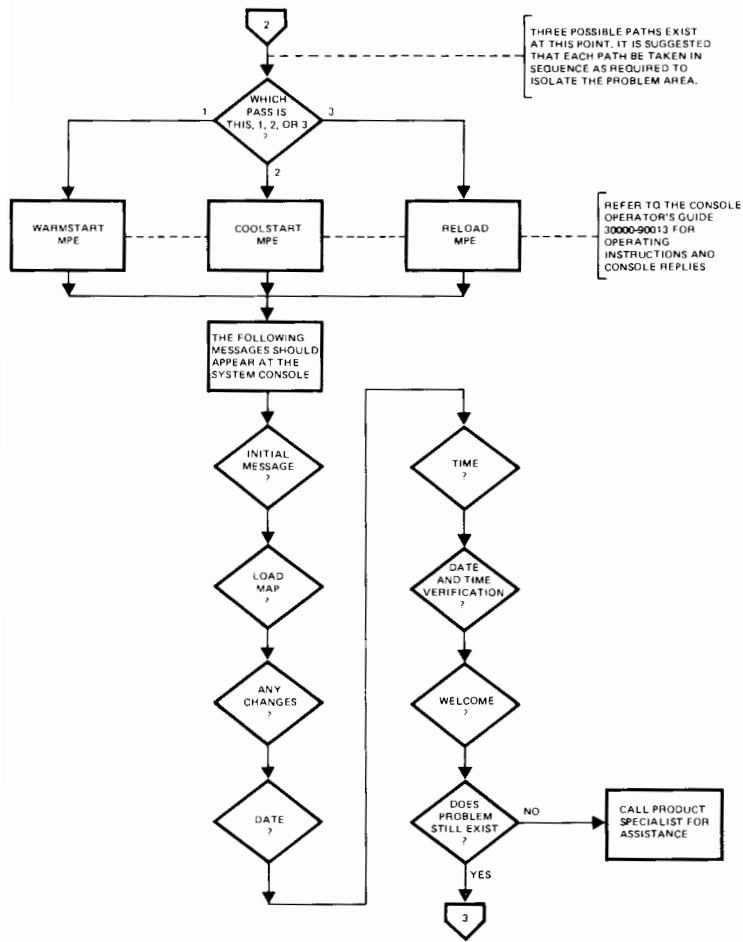

SYSTEM TROUBLESHOOTING FLOWCHART (Continued)

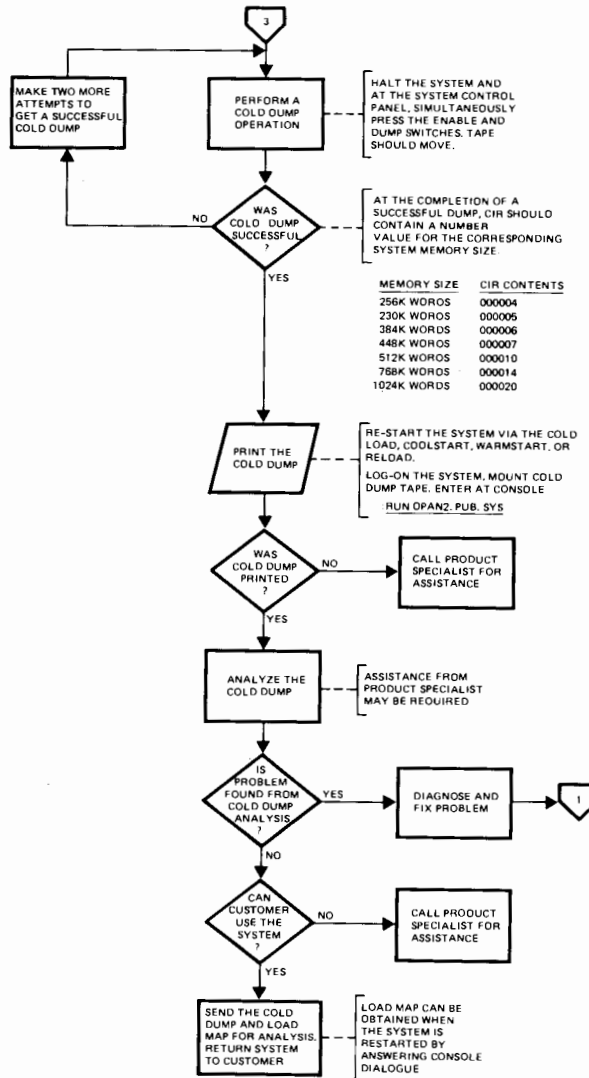

SYSTEM TROUBLESHOOTING FLOWCHART (Continued)

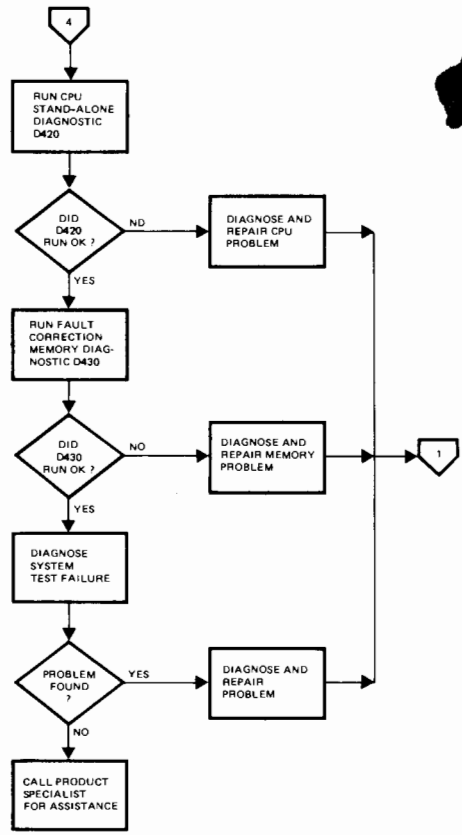

SYSTEM TROUBLESHOOTING FLOWCHART (Continued)

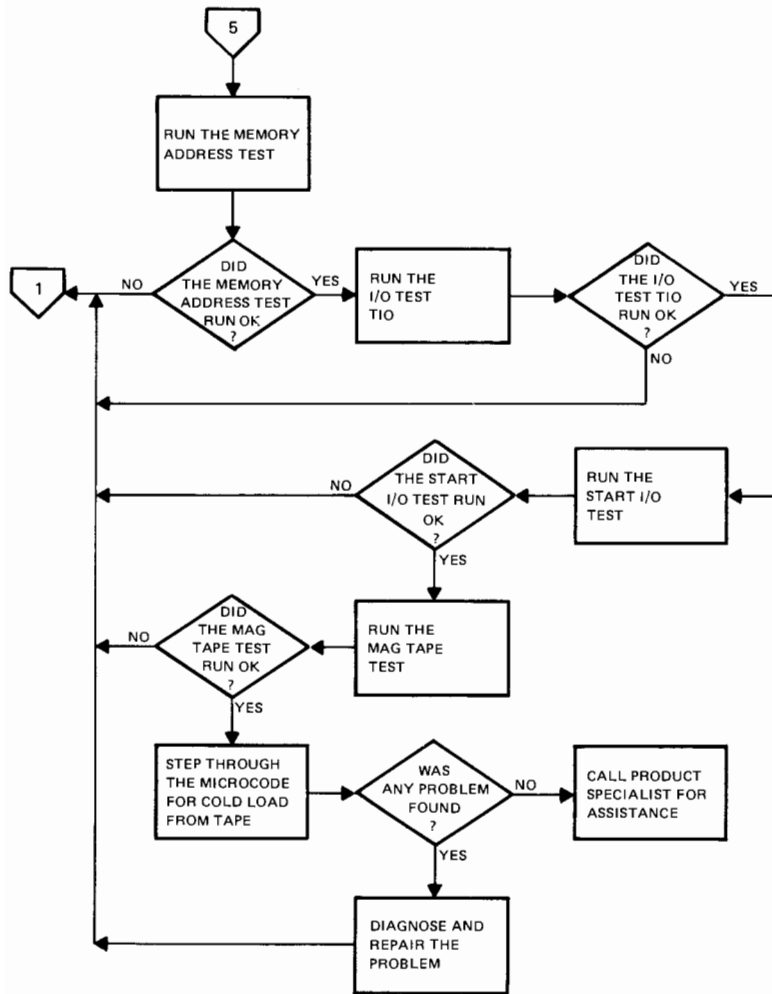

SYSTEM TROUBLESHOOTING FLOWCHART (Continued)

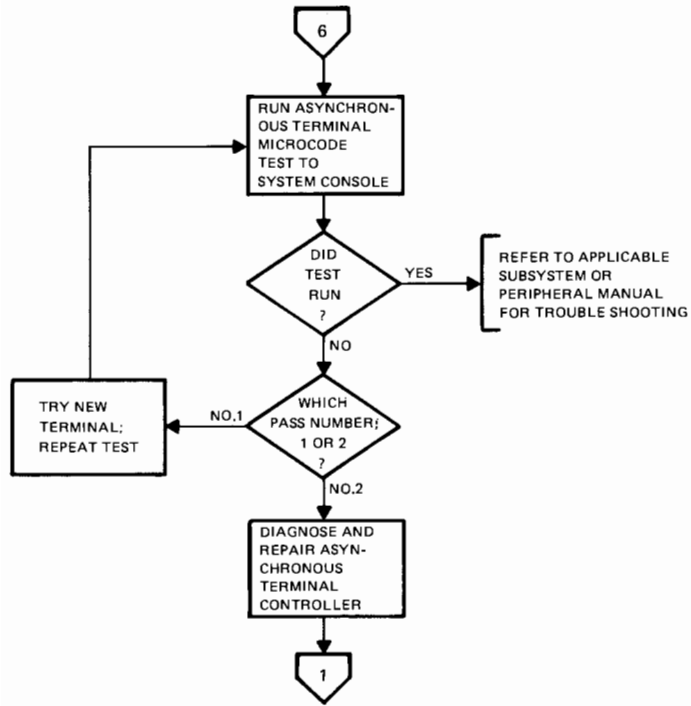

## System Information

### MICRODIAGNOSTICS

#### CONTROL PANEL TESTS AND FUNCTIONS

-----

Stored in the microcode are diagnostics to test the CPU registers, memory, I/O channels, magnetic tape subsystem, and the asynchronous terminal data PCA's. Diagnostics are executed from the system's control panel. The microcode also provides the following functions:

- a. Display Memory Logging Errors
- b. Read/Write Memory
- c. Display Register Contents

#### CPU REGISTER TEST

-----

Proceed as follows to test the various CPU registers.

- a. Set the SYSTEM SWITCH REGISTER to %000001.
- b. Press the ENABLE and LOAD switches.
- c. The program runs continuously until the HALT switch is pressed or until an error occurs.

Upon detection of an error, the test pauses in the run mode with the CURRENT INSTRUCTION REGISTER (CIR) displaying "bad bits". Press the RUN/HALT switch to obtain a code designating the failing register. Decode the display using the following table.

## CPU REGISTER CODES

CIR %	REGISTER	LOCATED ON
00	SP1 (Note)	R-Bus PCA
01	PL	R-Bus PCA
02	Z	R-Bus PCA
03	X	R-Bus PCA
04	RD (R-Bus)	R-Bus PCA
05	RC (R-Bus)	R-Bus PCA
06	RB (R-Bus)	R-Bus PCA
07	RA (R-Bus)	R-Bus PCA
10	SPO	R-Bus PCA
11	CRTL	S-Bus PCA
12	P	S-Bus PCA
13	Q	S-Bus PCA
14	DB	S-Bus PCA
15	SM	S-Bus PCA
16	STA	SSF and S-Bus PCA's
17	SP3	S-Bus PCA
20	OPND	CIR PCA
21	DL	S-Bus PCA
22	SP2	S-Bus PCA
23	PB	S-Bus PCA
24	PCLK	S-Bus PCA
25	RD (S-Bus)	S-Bus PCA
26	RC (S-Bus)	S-Bus PCA
27	RB (S-Bus)	S-Bus PCA
30	RA (S-Bus)	S-Bus PCA
31	CTRH	S-Bus PCA
32	ABS-BANK	SSF PCA
33	PB-BANK	SSF PCA
34	DB-BANK	SSF PCA
35	S-BANK	SSF PCA

NOTE

SP1 is the first register tested and the problem may not necessarily be in SP1 but somewhere previous in the data path (Store logic, Shifter, ALU, etc.)



## System Information

### MEMORY PATTERN TEST

-----

This test writes and then immediately reads back any bit pattern entered into the SYSTEM SWITCH REGISTER. The pattern pervades all of memory. The initial pattern is %100000. The current pattern is displayed in the CIR. Perform this test as follows:

- a. Set the SYSTEM SWITCH REGISTER to %100000.
- b. Press the ENABLE and LOAD switches.
- c. The test runs continuously until an error occurs or, if the RUN/HALT switch is pressed, until the end of a pass.

If an error is detected, the test halts and the CIR displays the error type as follows:

```
CIR = 0      Data Compare Error
CIR(4) = 1   System Parity Error
CIR(5) = 1   Address Parity Error
CIR(6) = 1   Multiple-Bit Error
```

Press the RUN/HALT switch for a CIR display of memory bank number, press again for address, and press again for expected data XOR actual data (bad bits).

### MEMORY ADDRESS TEST

-----

This test loads the memory with address dependent data and then checks it while reading it back. Perform this test as follows:

- a. Set the SYSTEM SWITCH REGISTER to %000000.
- b. Press the ENABLE and LOAD switches.
- c. The test runs continuously until an error occurs or, if the RUN/HALT switch is pressed, until the end of a pass.

If an error is detected, the test halts and the CIR displays the error type as follows:

```
CIR = 0      Data Compare Error
CIR(4) = 1   System Parity Error
CIR(5) = 1   Address/Data Bus Parity Error
CIR(6) = 1   Multiple-Bit Error
```

Press the RUN/HALT switch for a CIR display of memory bank number, press again for address, press again for actual data, and press again for expected data.

I/O TEST (TIO)  
-----

This test sends a TIO command to device numbers %2 through %177 in turn, and then pauses with the TIO status of each responding device in the CIR. Pressing the RUN/HALT switch advances to the next device. Perform this test as follows:

- a. Set the SYSTEM SWITCH REGISTER to %000002.
- b. Press the ENABLE and LOAD switches. The test pauses with %000002 in the CIR. This is the device number of the Sys-Clock/FLI PCA.
- c. Press the RUN/HALT switch to display TIO status of that device.
- d. Press the RUN/HALT switch for the device number of the next responding device, then once more for TIO status of that device.
- e. Repeat step d until the CIR displays %000200 and the SYSTEM HALT light is lighted.

I/O TEST (SIO)  
-----

This test executes an SIO program consisting of only an END-ORDER for all devices in turn that have the SIO OK bit set in the TIO status word. It pauses for each with the END-ORDER status in the CIR. Press the RUN/HALT switch to advance to the next device. Perform this test as follows:

- a. Set the SYSTEM SWITCH REGISTER to %100002.
- b. Press the ENABLE and LOAD switches.
- c. The CIR displays the device number of the first responding device that has the SIO OK bit set in its TIO status. Press RUN/HALT to display SIO END-ORDER status for that device.
- d. Press the RUN/HALT switch for the device number of the next responding device and then once more for SIO status of that device.
- e. Repeat step d until the CIR displays %000200 and the SYSTEM HALT light is lighted.

## System Information

### START I/O TEST

-----

This test issues a start I/O (SIO) command to a device and then waits for an interrupt from that device. An RIL is sent to any other interrupting devices. After receiving the interrupt, the function system-halts with the CIR displaying TIO status from the device if the command succeeded or %030370 if the command failed.

This test assumes that an SIO program is already in memory and that the DRT pointer at DEVNO\*4 has been initialized. Perform this function as follows:

- a. Set the SYSTEM SWITCH REGISTER to %005000.
- b. Press the ENABLE and LOAD switches. The system pauses with %005000 in the CIR.
- c. Set the SYSTEM SWITCH REGISTER bits 9 through 15 to the device number.
- d. Press the RUN/HALT switch to send the SIO command to the device.

### MAG-TAPE TEST

-----

This test writes a 4K-word record to tape from each memory bank, correcting for tape errors by issuing a backspace record followed by a write gap and then retrying. After this write operation, the tape is rewound and each 4K-word record is read into another area of its source memory bank. The data written is compared with the data read and the test halts if an error is detected. The test runs continuously if no error is found. If the SIO command to the tape unit fails, the test halts with %030370 in the CIR. Perform this test as follows:

- a. Set the SYSTEM SWITCH REGISTER to %006000.
- b. Press the ENABLE and LOAD switches. The test pauses with %006000 in the CIR.
- c. Set bits 7 through 15 of the SYSTEM SWITCH REGISTER to the device number of the tape drive to be tested.
- d. Press the RUN/HALT switch to start the test.

System Information

On a halt, the CIR displays the current bank in bits 0 through 3 and the mag tape command in bits 12 through 15. The test halts if an error is detected or, if the RUN/HALT switch is pressed, until a pass is completed. If the test halts on an error, subsequent pressing of the RUN/HALT switch causes the following sequence of displays.

1	STATUS	Privileged mode, enable interrupt, CST#1*
2	SP1	Data word written
3	SP2	Data word read
4	TOS	Not used
5	PB-BNK	Current I/O bank address
6	PB	SP1 XOR SP2 (failing bit)
7	P	Write buffer address
8	PL	Read buffer offset
9	DB-BNK	Not used
10	DB	Device number under test
11	S-BNK	Always 0
12	DL	CCPX parameter word
13	Q	Device number times 4 (DRT)
14	SM	Used as address pointer to build SIO program.
15	Z	I/O bank in bits 0, 1, and 2
16	INDEX(X)	Interrupting device number

\* 14001

## System Information

### ASYNCHRONOUS TERMINAL CONTROLLER SUBSYSTEM TEST

---

This test causes characters typed on a selected terminal to be echoed and the ASCII code of the character to appear in bits 7 through 15 of the CIR. A non-responding device halts the test with %030370 in the CIR. Perform this test as follows:

- a. Set the SYSTEM SWITCH REGISTER to %007000.
- b. Press the ENABLE and LOAD switches. The test pauses with %007000 in the CIR.
- c. Enter the device number of the asynchronous terminal controller in bits 7 through 15 and the port number in bits 3 through 6 of the SYSTEM SWITCH REGISTER.
- d. Press the RUN/HALT switch. The test pauses with the CIR equal to the switch register.
- e. Enter the character size parameter into bits 5 through 7 and the baud rate parameter into bits 8 through 15.
- f. Press the RUN/HALT switch. The test pauses with the CIR equal to the switch register.
- g. Press the RUN/HALT switch.
- h. Strike keys on the terminal's keyboard and observe that the characters are echoed correctly and the ASCII code for each character is displayed in bits 7 through 15 of the CIR.

The character size parameter is the three least significant bits of the sum of the number of start, parity, data, and stop bits in a transmitted character less one.

To calculate the baud rate parameter, divide decimal 14400 by the device bit rate, round off to the nearest integer, and subtract one. Convert the decimal answer to octal.

Some octal examples of character size and baud rate parameters are as follows:

DEVICE	CHARACTER PARAMETER	BAUD PARAMETER	OVERALL() SETTING
ASR 33 Teletype	2	202	1202
30-CPS Terminal	1	057	457
60-CPS Terminal	1	027	427
120-CPS Terminal	1	013	413
240-CPS Terminal	1	005	405

DISPLAY MEMORY LOGGING ERRORS FUNCTION

-----

This function transfers the contents of the error logging arrays (one error logging array is on each of up to two MCL PCA's) to the I/O logging array on the fault logging interface (FLI) PCA. It then interrogates the System Clock/FLI PCA and displays the diagnostic status word in the CIR for each error logged. The diagnostic status word shown below contains the information needed to find failing RAM's.

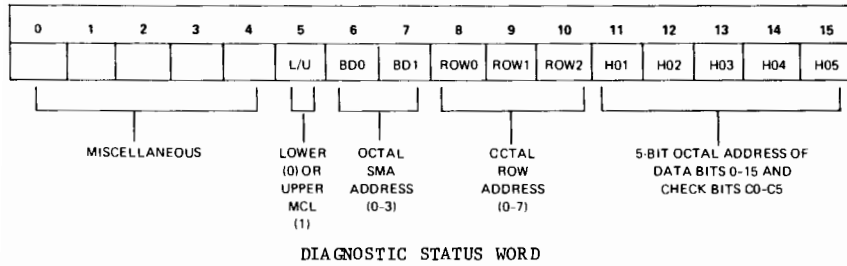

Perform this function as follows:

- a. Set the SYSTEM SWITCH REGISTER to %001000.
- b. Press the ENABLE and LOAD switches. The test pauses with %001000 in the CIR.
- c. Press the RUN/HALT switch to observe the RIO status word for the first error logged. If no errors are logged, the CIR display is 000000 and the SYSTEM HALT light is lighted.
- d. Press the RUN/HALT switch again for the next and subsequent errors. When the CIR display is 000000 and the SYSTEM HALT light is lighted, all errors have been observed.

The function system halts with %030370 in the CIR if the System Clock/FLI PCA does not respond. When an error is detected, use the following faulty chip locating flowchart and conversion table to isolate the error to a single-bit error, a double-bit error, or more than a double-bit error. Use the row and chip locator illustration to locate the failing RAM(s).

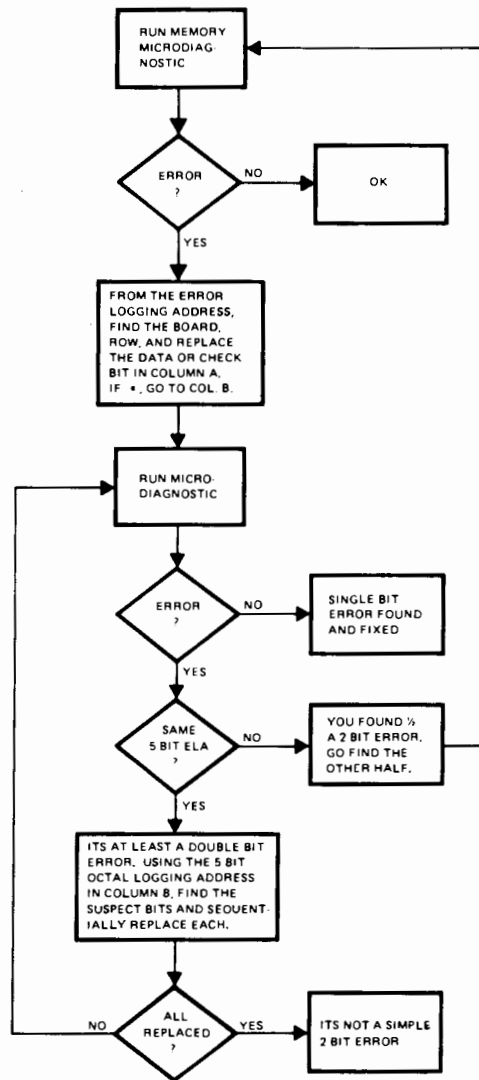

FAULTY CHIP LOCATING FLOWCHART

System Information

5-Bit Octal Error Logging Address To Data Or Check Bits Conversion (More than Single-Bit Errors)

H01-H05	A	B	
	BIT	BITS	
00	C0	- - - - -	
01	C5	D0,2,3,4,5,6,7	-
02	C4	D1,2,3,8,9,10,11	-
03	D3	D0,1,2,4,7	C5
04	C3	D0,4,5,9,12,13,14	-
05	*Note 1	D0,1,3,4,5,6,7	C5
06	D9	D0,1,2,8,10,11	C4
07	D0	D1,2,3,5,6,9	-
10	C2	D1,6,8,10,12,13,15	-
11	D6	D0,1,2,4,5,7	C5
12	*Note 2	D0,1,3,8,9,10,11	C4
13	D1	D0,2,3,4,6,7	-
14	D13	D0,4,8,12,14	C3
15	D4	D1,3,5,6,13	-
16	D8	D0,3,9,10,11,13	-
17	*	D0,1,2,3,4,5,6,8	-
20	C1	D2,7,11,12,14,15	-
21	D7	D1,2,3,4,5,6	C1
22	D11	D0,2,3,8,9,10	C1
23	D2	D0,1,3,5,6,7,11	-
24	D14	D0,5,8,9,12,13	C1
25	D5	D0,2,4,6,7,14	-
26	*	D0,3,8,9,10,11,14	-
27	*	D0,1,2,3,4,5,7	-
30	D15	D1,4,6,10,12,13	C1
31	*	D1,3,4,5,6,7,15	-
32	D10	D1,2,8,9,11,15	-
33	*	D0,1,2,3,5,6,10	-
34	D12	D12 D4,5,8,9,13,14,15	-
35	*	D0,2,4,5,6,7,12	-
36	*	D1,2,8,9,10,11,12	-
37	*	D1,2,3,4,7	-

COLUMN A IS FOR SINGLE CHECK OR DATA BIT ERRORS.  
 COLUMN B IS FOR MULTIPLE CHECK OR DATA BIT ERRORS.

Notes: 1. Forced Double Error Write  
 2. Missing Array Board



System Information

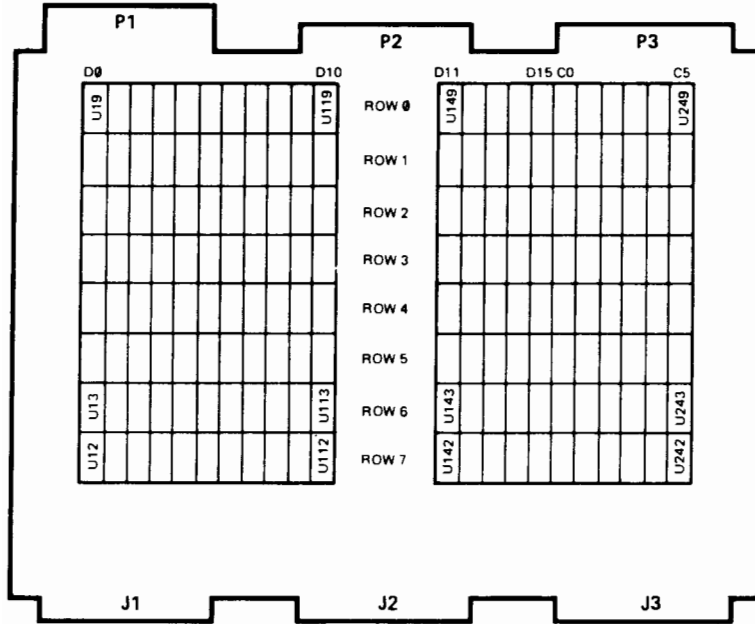

ROW AND CHIP LOCATOR

CONTROL PANEL READ/WRITE MEMORY FUNCTION

-----  
This function allows memory to be written or read from the system control panel on a word-by-word basis. This function allows reading and writing while incrementing or decrementing memory addresses. To use this function, set one of the following bit patterns into the SYSTEM SWITCH REGISTER.

- a. To write while incrementing memory: %002000
- b. To read while incrementing memory: %003000
- c. To write while decrementing memory: %102000
- d. To read while decrementing memory: %103000

Then proceed as follows:

- a. Press the ENABLE and LOAD switches. The system pauses with the CIR equal to the switch register.
- b. Enter the selected bank address (0 -%17) in bits 12 through 15 of the SYSTEM SWITCH REGISTER.
- c. Press the RUN/HALT switch. The system pauses with the bank number in the CIR.
- d. Enter the starting address (0 - %177777) in the SYSTEM SWITCH REGISTER.
- e. Press the RUN/HALT switch. The system pauses with the starting address of the read or write operation in the SYSTEM SWITCH REGISTER.

For a memory write, set the data word to be written into the SYSTEM SWITCH REGISTER. Press the RUN/HALT switch to write the first data word at the starting address. If required, change the data word in the SYSTEM SWITCH REGISTER and press the RUN/HALT switch to write the data word at the incremented or decremented memory address. The data word is displayed in the CIR after it is written into memory.

For a memory read, press the RUN/HALT switch to read the data word at the starting address. The data word is displayed in the CIR. Press the RUN/HALT switch again to read the data word at the incremented or decremented address.

Addresses do not cross bank boundaries, address 000000 follows address %177777.

A SYSTEM/HALT occurs if an attempt is made to read or write non-existent memory.

System Information

DISPLAY REGISTER FUNCTION  
-----

This function displays the contents of most of the CPU registers and the contents of the top-of-stack in memory. Pressing the RUN/HALT switch causes the CIR to display the contents of the following registers in the order shown below:

00 - STATUS	10 - DB-Bank
01 - SP1	11 - DB
02 - SP2	12 - S-Bank
03 - TOS = MEM(SM)	13 - DL
04 - PB-Bank	14 - Q
05 - PB	15 - SM
06 - P	16 - Z
07 - PL	17 - X

To use this function, proceed as follows:

- a. Set the SYSTEM SWITCH REGISTER to %004000.
- b. Press the ENABLE and LOAD switches. The system pauses with %004000 in the CIR.
- c. Press the RUN/HALT switch as needed to observe register contents.

The function will SYSTEM HALT when the Index Register (X) has been displayed.

COLD LOAD PROCEDURE (TAPE)

The following is the SIO program built by the microcode for a cold load from tape:

30 = 001430  
1430 = 014000  
1431 = 000000  
1432 = 040000  
1433 = 000006  
1434 = 077760  
1435 = 001400  
1436 = 000000  
1437 = 001400

MAINTENANCE PANEL SET-UP  
-----

- a. Place all switches down.
- b. Set TIMERS switch to INHIBIT.
- c. Press SYSTEM RESET switch.
- d. Set V-BUS COMPARE REGISTER to %7103.
- e. Set V-BUS COMPARE switches to ENABLE and HALT.
- f. Set SWITCH REGISTER on Mini Panel to 003006.
- g. Press ENABLE and LOAD switches on Mini Panel.

The panel will freeze with %7104 displayed in the V-BUS COMPARE REGISTER. The PANEL FREEZE and FREEZE lamps will be lighted.

- h. Set CLOCK switch to INHIBIT.
- i. Press and hold down the V-BUS COMPARE HALT EXIT switch.
- j. Press and count clocks using the CLOCK SINGLE CYCLE switch until the CPU LORQ indicator lights (3 clocks).
- k. Release the V-BUS COMPARE HALT EXIT switch.

The SINGLE CYCLE REGISTER DISPLAY switch must be in the REGISTER position (up) to display the Selected Registers given in the following listing. The following conventions are used throughout the listing:

- = don't care  
0 = zero in display

Clocks are counted in decimal, other numbers are in octal.

System Information

COLD LOAD TROUBLESHOOTING FLOWCHART  
(Using CPU Diagnostic)

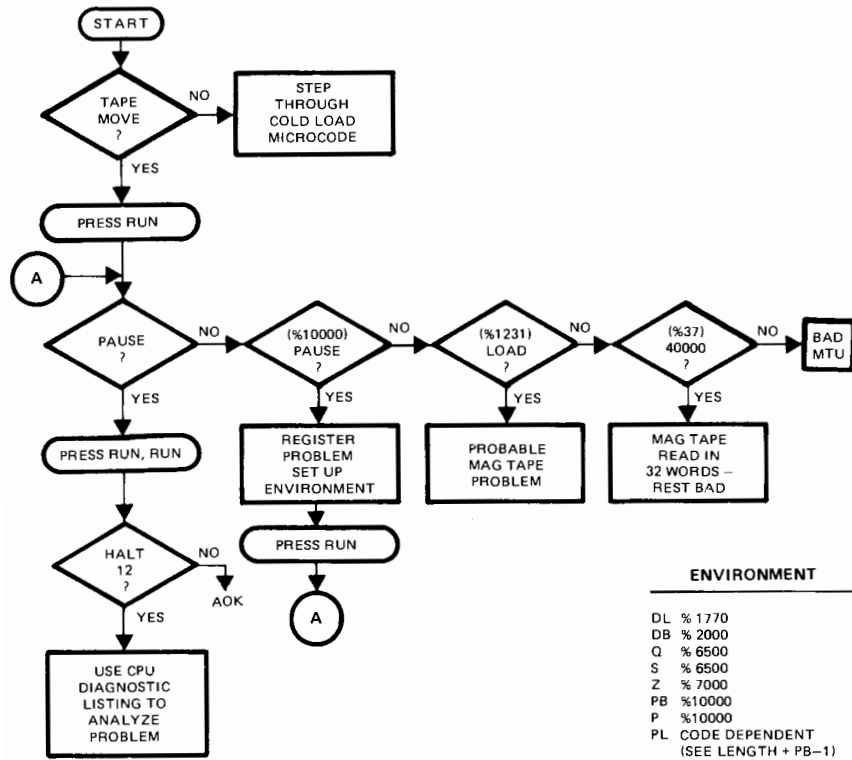

ENVIRONMENT

DL % 1770  
 DB % 2000  
 Q % 6500  
 S % 6500  
 Z % 7000  
 PB %10000  
 P %10000  
 PL CODE DEPENDENT  
 (SEE LENGTH + PB-1)

System Information

COLD LOAD LISTING

		SELECTED REGISTERS					
CLK	LAMPS ON	V-BUS ADDRESS	CMD DEV NO.	IOD	IOP	I/O DATA	CTL
3	CPU LORQ	—	—	—	—	—	—
9	DIRECT ACTIVE FREEZE	1726	1206	—	—	0	—
10	DIRECT ACTIVE SERVICE OUT FREEZE	1726	1206	—	—	0	—
11	DIRECT ACTIVE SERVICE OUT FREEZE	1726	1206	—	—	0	—
12	DIRECT ACTIVE SERVICE OUT FREEZE	1726	1206	—	—	0	—
13	DIRECT ACTIVE SERVICE IN FREEZE	1726	1206	—	—	0	—
14	DROP CPU FRZ DIRECT ACTIVE SERVICE IN	1726	0	—	—	0	—
15		1727	0	—	—	0	—
*16	DATA POLL	1730	0	—	—	0	—
17	DATA POLL	7110	0	—	—	30	—
18	DATA POLL	7111	1000	—	—	30	—
COMMENTS							
*16	<RESULTS OF HSREQ						

System Information

COLD LOAD LISTING (Continued)

		SELECTED REGISTERS					
CLK	LAMPS ON	V-BUS ADDRESS	CMD DEV NO.	IOD	IOP	I/O DATA	CTL
* 19	SERVICE IN SIO ACTIVE DRT REQ I/O LOW REQ	7112	1000	30	—	0	—
20	SIO ACTIVE DRT REQ I/O SELECT I/O WAIT	7113	1000	30	—	0	30**
21	SIO ACTIVE DRT REQ I/O WAIT	7114	1000	30	—	0	—
22	SIO ACTIVE DRT REQ I/O WAIT	7112	1000	30	—	0	—
23	SIO ACTIVE DRT REQ I/O WAIT	7113	1000	30	—	0	1430 ***
* 24	SIO ACTIVE DRT REQ IOB ENABLE DRT STORE	7114	1000	30	—	31	—
25	SERVICE OUT SIO ACTIVE DRT REQ IOB ENABLE DRT STORE I/O LOW REQ	7112	1000	30	1430	1430	—
COMMENTS							
* 19	<STATE >						
* 24	<NO DRT STORE, BAD IOP						
**	FROM = 5 TO = 0 MOP = 10						
***	FROM = 0 TO = 5 MOP = 00						

System Information

COLD LOAD LISTING (Continued)

SELECTED REGISTERS							
CLK	LAMPS ON	V-BUS ADDRESS	CMD DEV NO.	IOD	IOP	I/O DATA	CTL
* 26	SERVICE IN SIO ACTIVE DRT REQ IOB ENABLE DRT STORE I/O HIRQ I/O SELECT	7113	0	30	1432	1430	30**
* 27	SIO ACTIVE DRT REQ IOB ENABLE DRT STORE I/O SELECT	7114	0	30	1432	1430	1432***
28		7112	0	30	1432	0	—
29	DATA POLL	7113	0	30	1432	0	—
30	DATA POLL	7114	0	30	1432	0	—
31	DATA POLL	7112	0	30	1432	1430	—
32	SERVICE IN SIO ACTIVE I/O LORQ	7113	0	1430	1432	0	—
33	SIO ACTIVE I/O WAIT I/O SELECT	7114	0	1430	1432	0	1430****
34	SIO ACTIVE I/O WAIT	7112	0	1430	1432	0	—
COMMENTS							
* 26	<IOP NOT 1432, BAD IOP						
* 27	<DRT DOESN'T SET, BAD IOP						
**	FROM = 5 TO = 0 MOP = 01						
***	FROM = 5 TO = 0 MOP = 00						
****	FROM = 5 TO = 0 MOP = 10						



System Information

COLD LOAD LISTING (Continued)

		SELECTED REGISTERS					
CLK	LAMPS ON	V-BUS ADDRESS	CMD DEV NO.	IOD	IOP	I/O DATA	CTL
35	SIO ACTIVE I/O WAIT	7113	0	1430	1432	0	—
36	SIO ACTIVE I/O WAIT	7114	0	1430	1432	0	14000
37	SIO ACTIVE IOB ENABLE	7112	0	1430	1432	14000	—
38	SERVICE OUT SIO ACTIVE IOB ENABLE	7113	0	1430	1432	14000	—
39	SERVICE IN SIO ACTIVE IOB ENABLE	7114	0	1430	1432	14000	—
40		7112	0	1430	1432	0	—
41	DATA POLL	7113	0	1430	1432	0	—
42	DATA POLL	7114	0	1430	1432	0	—
43	DATA POLL	7112	0	1430	1432	1431	—
44	SERVICE IN SIO ACTIVE I/O LORQ	7113	0	1431	1432	0	—
45	SIO ACTIVE I/O WAIT I/O SELECT	7114	0	1431	1432	0	1431*
COMMENTS							
*	FROM - 5 TO - 0 MOP - 10						

System Information

COLD LOAD LISTING (Continued)

SELECTED REGISTERS							
CLK	LAMPS ON	V-BUS ADDRESS	CMD DEV NO.	IOD	IOP	I/O DATA	CTL
46	SIO ACTIVE I/O WAIT	7112	0	1431	1432	0	—
47	SIO ACTIVE I/O WAIT	7113	0	1431	1432	0	—
48	SIO ACTIVE I/O WAIT	7114	0	1431	1432	0	0*
49	SOI ACTIVE IOB ENABLE	7112	0	1431	1432	0	—
50	SERVICE OUT SIO ACTIVE IOB ENABLE	7113	0	1431	1432	0	—
51	SERVICE IN SIO ACTIVE IOB ENABLE	7114	0	1431	1432	0	—
52		7112	0	1431	1432	0	—
53	DATA POLL	7113	0	1431	1432	0	—
54	DATA POLL	7114	0	1431	1432	30	—
55	DATA POLL	7112	1000	1431	1432	30	—
56	SERVICE IN SIO ACTIVE DRT REQ I/O LORQ	7113	1000	30	1432	0	—
COMMENTS							
*	FROM - 0 TO - 5 MOP - 00						

System Information

COLD LOAD LISTING (Continued)

SELECTED REGISTERS							
CLK	LAMPS ON	V-BUS ADDRESS	CMD DEV NO.	IOD	IOP	I/O DATA	CTL
57	SIO ACTIVE DRT REQ I/O WAIT I/O SELECT	7114	1000	30	1432	0	30*
58	SIO ACTIVE DRT REQ I/O WAIT	7112	1000	30	1432	0	—
59	SIO ACTIVE DRT REQ I/O WAIT	7113	1000	30	1432	0	—
60	SIO ACTIVE DRT REQ I/O WAIT	7114	1000	30	1432	0	1432 **
61	SIO ACTIVE DRT REQ IOB ENABLE DRT STORE	7112	1000	30	1432	1432	—
62	SERVICE OUT SIO ACTIVE DRT REQ IOB ENABLE DRT STORE I/O LORQ	7113	1000	30	1432	1432	—
COMMENTS							
*	FROM=5 TO=0 MOP=10						
**	FROM=0 TO=5 MOP=00						

System Information

COLD LOAD LISTING (Continued)

		SELECTED REGISTERS					
CLK	LAMPS ON	V-BUS ADDRESS	CMD DEV NO.	IOD	IOP	I/O DATA	CTL
63	SERVICE IN SIO ACTIVE DRT REQ IOB ENABLE DRT STORE I/O HIRQ I/O SELECT	7114	0	30	1434	1432	30**
64	SIO ACTIVE DRT REQ IOB ENABLE DRT STORE I/O SELECT	7112	0	30	1434	1432	1434 ***
65		7113	0	30	1434	0	—
* 66	DATA POLL	7114	0	30	1434	0	—
67	DATA POLL	7112	0	30	1434	0	—
68	DATA POLL	7113	0	30	1434	1432	—
69	SERVICE IN SIO ACTIVE I/O LORQ	7114	0	1432	1434	0	
70	SIO ACTIVE I/O WAIT I/O SELECT	7112	0	1432	1434	0	1432****
71	SIO ACTIVE I/O WAIT	7113	0	1432	1434	0	—
COMMENTS							
*66	<STATE A>						
**	FROM = 5 TO = 0 MOP = 01						
***	FROM = 5 TO = 0 MOP = 00						
****	FROM = 5 TO = 0 MOP = 10						

System Information

COLD LOAD LISTING (Continued)

SELECTED REGISTERS							
CLK	LAMPS ON	V-BUS ADDRESS	CMD DEV NO.	IOD	IOP	I/O DATA	CTL
72	SIO ACTIVE I/O WAIT	7114	0	1432	1434	0	--
73	SIO ACTIVE I/O WAIT	7112	0	1432	1434	0	40000**
74	SIO ACTIVE IOB ENABLE	7113	0	1432	1434	40000	--
75	SERVICE OUT SIO ACTIVE IOB ENABLE	7114	0	1432	1434	40000	--
76	SERVICE IN SIO ACTIVE IOB ENABLE	7112	0	1432	1434	40000	--
77		7113	0	1432	1434	0	--
*78	DATA POLL	7114	0	1432	1434	0	--
79	DATA POLL	7112	0	1432	1434	0	--
80	DATA POLL	7113	0	1432	1434	1433	--
81	SERVICE IN SIO ACTIVE I/O LORQ	7114	0	1433	1434	0	--
82	SIO ACTIVE I/O WAIT I/O SELECT	7112	0	1433	1434	0	1433***
COMMENTS							
*78	<STATE B>						
**	FROM = 0 TO = 5 MOP = 00						
***	FROM = 5 TO = 0 MOP = 10						

System Information

COLD LOAD LISTING (Continued)

		SELECTED REGISTERS					
CLK	LAMPS ON	V-BUS ADDRESS	CMD DEV NO.	IOD	IOP	I/O DATA	CTL
83	SIO ACTIVE I/O WAIT	7113	0	1433	1434	0	—
84	SIO ACTIVE I/O WAIT	7114	0	1433	1434	0	—
85	SIO ACTIVE I/O WAIT	7112	0	1433	1434	0	6*
86	SIO ACTIVE IOB ENABLE	7113	0	1433	1434	6	—
87	SERVICE OUT SIO ACTIVE IOB ENABLE	7114	0	1433	1434	6	—
88	SERVICE IN SIO ACTIVE IOB ENABLE	7112	0	1433	1434	6	—
89		7113	0	1433	1434	0	—
90	DATA POLL	7114	0	1433	1434	0	—
91	DATA POLL	7112	0	1433	1434	30	—
92	DATA POLL	7113	1000	1433	1434	30	—
93	SERVICE IN SIO ACTIVE DRT REQ I/O LORQ	7114	1000	30	1434	0	—
COMMENTS							
*	FROM - 0 TO - 5 MOP - 00						

System Information

COLD LOAD LISTING (Continued)

SELECTED REGISTERS							
CLK	LAMPS ON	V-BUS ADDRESS	CMD DEV NO.	IOD	IOP	I/O DATA	CTL
94	SIO ACTIVE DRT REQ I/O WAIT I/O SELECT	7112	1000	30	1434	0	30*
95	SIO ACTIVE DRT REQ I/O WAIT	7113	1000	30	1434	0	—
96	SIO ACTIVE DRT REQ I/O WAIT	7114	1000	30	1434	0	—
97	SIO ACTIVE DRT REQ I/O WAIT	7112	1000	30	1434	0	1434**
98	SIO ACTIVE DRT REQ IOB ENABLE DRT STORE	7113	1000	30	1434	1434	—
99	SERVICE OUT SIO ACTIVE DRT REQ IOB ENABLE DRT STORE I/O LORQ	7114	1000	30	1434	1434	—
COMMENTS							
*	FROM - 5 TO - 0 MOP - 10						
**	FROM - 0 TO - 5 MOP - 00						

System Information

COLD LOAD LISTING (Continued)

		SELECTED REGISTERS					
CLK	LAMPS ON	V-BUS ADDRESS	CMD DEV NO.	IOD	IOP	I/O DATA	CTL
100	SERVICE IN SIO ACTIVE DRT REQ IOB ENABLE DRT STORE I/O HIRQ I/O SELECT	7112	0	30	1436	1434	30*
101	SIO ACTIVE DRT REQ IOB ENABLE DRT STORE I/O SELECT	7113	0	30	1436	1434	1436**
102		7114	0	30	1436	0	—
103	DATA POLL	7112	0	30	1436	0	—
104	DATA POLL	7113	0	30	1436	0	—
105	DATA POLL	7114	0	30	1436	1434	—
106	SERVICE IN SIO ACTIVE I/O LORQ	7112	0	1434	1436	0	—
107	SIO ACTIVE I/O WAIT I/O SELECT	7113	0	1434	1436	0	1434***
108	SIO ACTIVE I/O WAIT	7114	0	1434	1436	0	—
COMMENTS							
*	FROM - 5 TO - 0 MOP - 01						
**	FROM - 5 TO - 0 MOP - 00						
***	FROM - 5 TO - 0 MOP - 10						



System Information

COLD LOAD LISTING (Continued)

SELECTED REGISTERS							
CLK	LAMPS ON	V-BUS ADDRESS	CMD DEV NO.	IOD	IOP	I/O DATA	CTL
109	SIO ACTIVE I/O WAIT	7112	0	1434	1436	0	—
110	SIO ACTIVE I/O WAIT	7113	0	1434	1436	0	077760*
111	SIO ACTIVE IOB ENABLE	7114	0	1434	1436	077760	—
112	SERVICE OUT SIO ACTIVE IOB ENABLE	7112	0	1434	1436	077760	—
113	SERVICE IN SIO ACTIVE IOB ENABLE	7113	0	1434	1436	077760	—
114		7114	0	1434	1436	0	—
115	DATA POLL	7112	0	1434	1436	0	—
116	DATA POLL	7113	0	1434	1436	0	—
117	DATA POLL	7114	0	1434	1436	1435	—
118	SERVICE IN SIO ACTIVE I/O LORQ	7112	0	1435	1436	0	—
119	SIO ACTIVE I/O WAIT I/O SELECT	7113	0	1435	1436	0	1435**
COMMENTS							
*	FROM = 0 TO = 5 MOP = 00						
**	FROM = 5 TO = 0 MOP = 10						

System Information

COLD LOAD LISTING (Continued)

		SELECTED REGISTERS					
CLK	LAMPS ON	V-BUS ADDRESS	CMD DEV NO.	IOD	IOP	I/O DATA	CTL
120	SIO ACTIVE I/O WAIT	7114	0	1435	1436	0	—
121	SIO ACTIVE I/O WAIT	7112	0	1435	1436	0	—
122	SIO ACTIVE I/O WAIT	7113	0	1435	1436	0	1400*
123	SIO ACTIVE IOB ENABLE	7114	0	1435	1436	1400	—
124	SERVICE OUT SIO ACTIVE IOB ENABLE	7112	0	1435	1436	1400	—
125	SERVICE IN SIO ACTIVE IOB ENABLE INTRPT REQ	7113	0	1435	1436	1400	—
(TAPE SHOULD MOVE)							
126	INTRPT POLL	7114	6	1435	1436	0	—
127	INTRPT POLL INTRPT ACK	7112	6	1435	1436	0	—
128	INTRPT ACK EXT INTRPT	7113	0	1435	1436	0	—
129	EXT INTRPT	7114	0	1435	1436	0	—
130	EXT INTRPT INTRPT FF	7115	0	1435	1436	0	—
131	EXT INTRPT INTRPT FF	7116	0	1435	1436	0	—
OPERATION SHOULD BE COMPLETE							
COMMENTS							
*	FROM - 0 TO - 5 MOP - 00						

System Information

FREE2

FREE2 prints histograms of available disc space and the total number of entries in the Free-Space Table. In the listing, each disc configured in the system is identified by volume name and the histogram for that disc follows this name. The total number of Free-Space Table entries in the system appears at the end of the list.

To run FREE2, log on to the system and enter:

```
:RUN FREE2.PUB.SYS  
-----
```

LISTLOG2

LISTLOG2 prints the contents of any MPE Log Files existing in the system. These files are created under the user and account names MANAGER.SYS.

NOTE

The output from LISTLOG2 can be directed to any output file on any device. (LISTLOG2 recognizes this file by the formal designator LOGLIST, assigned the device class name LP.)

:RUN LISTLOG2.PUB.SYS

-----  
LIST LOG FILE PROGRAM VERSION 00.00 4/1/76  
ENTER FIRST AND LAST LOG FILE TO BE ANALYZED  
FIRST?2824

-----  
LAST?2825

-----  
ENTER EVENTS TO BE PRINTED  
TYPE NO.    EVENT

- 0 LOG FAILURE
- 1 SYSTEM UP
- 2 JOB INITIATION
- 3 JOB TERMINATION
- 4 PROCESS TERMINATION
- 5 FILE CLOSE
- 6 SYSTEM SHUTDOWN
- 7 POWER FAILURE
- 8 SPOOLING LOG RECORD
- 9 LINE DISCONNECTION
- 10 LINE CLOSE
- 11 I/O ERRORS

ENTER EVENT NUMBERS SEPARATED BY COMMAS  
A CARRIAGE RETURN ASSUMES ALL EVENTS WILL BE EVALUATED  
11

--  
DO YOU WANT TO PURGE LOG FILES?YES

---  
DO YOU WISH TO RUN AGAIN(Y OR N)?N

-  
END OF PROGRAM

System Information

WORKOUT2

:RUN FREE2.PUB.SYS (Checks available disc space.)  
(WORKOUT2 is 4096 sectors long and opens in 1024 sector blocks.)  
Restore WORKOUT2 into HP32230.SUPPORT  
Use SWITCHLOG to close current log file and start a new log file.  
:RUN WORKOUT2.PUB.SYS;PARAM=X

X=1 Will eliminate comparing of data buffers after each read and should not be used except for performance measurement.

X=2 Will cause END OF PASS messages to be displayed on the console as well as \$STDLIST.

X=3 Will give both 1 and 2 above.

If PARM is not specified, neither 1 or 2 above is executed.

NUMBER OF DISC FILES? (0 - 64) Note 1  
LDN FOR FILE #X? (0 - 255) Note 2  
IS A SORT TO BE DONE? (Y or N) Note 3  
NUMBER OF TAPE FILES? (0 - 4) Note 4  
NUMBER OF PASSES? (0 - 32,766) Note 5

NOTES

1. Default = 0. Refer to Notes 3 and 4.
2. Default = 0. Zero causes the extents of the file to be spread over all discs in device class DISC. Any other number causes all extents of the file to be on the disc specified.
3. Use of this function is not recommended. Default = no. This question will only be asked if reply to NUMBER OF DISC FILES? is greater than 1. A yes reply causes file #1 to be sorted and written to file #N where N is the last file specified.
4. Default = 0. If reply to NUMBER OF DISC FILES? is zero and this reply is zero, the program will terminate. Any other reply will be the number of tape files WORKOUT2 will attempt to open.
5. Default = 0. If reply is zero, the program will terminate immediately. Any other reply causes WORKOUT2 to perform that number of passes and then terminate.

:RUN LISTLOG2 .PUB.SYS (Outputs I/O errors from the log file.)

Reference: SIM

IOCDPNO COMMANDS

:RUN IOCDPNO.PUB.SYS

-----  
TEST IO 4/23/79           TYPE X FOR COMMAND LIST  
C?X  
COMMANDS ARE 1 OR MORE LETTERS, PARAMS ARE NUMBERS OR STRINGS IN  
QUOTES, PROGRAM STATEMENTS ARE PRECEDED BY A STATEMENT NUMBER

A	ASCII BUF FILL	EX	TERMINATE
B	OCTAL BUF FILL	F	SET FUNCTION
C	SET COUNT PARAM	FL	SET FLAGS
SH	PRINT DO & PROG	LI	LIST PROGRAM
GO	GO TO STATEMENT	CL	CLR PROGRAM
DE	CALL DEBUG	H	CALL HELP
DO	READ CMND FILE	CH	CHK RESULTS
DEC	DECIMAL CONVERT	O	OCTAL CONVERT
CM	CLR MNTR TABLE	I	INCRMT FILL
CIO	DO CIO INSTRUCT	L	SET LDEV
RIO	DO RIO	LD	SET LIST DEV
TIO	DO TIO	PA	SET P1
WIO	DO WIO	PB	SET P2
P	PRINT MNTR TABLE	M	MONITOR TERM
DD	DISPLAY DIT	MB	MODIFY BUFFR
DQ	DISPLAY IOQS	MQ	MODIFY IOQ
DSI	DISPLAY SIO PROG	MD	MODIFY DIT
D	DISPLAY PARAMS	Q	SET QMISC
DA	SHOW BUF ASCII	R	RUN PROGRAM
DB	SHOW BUF OCTAL	T	PRINT TIME
DS	DISPLAY STATUS	V	ADD RECORD #
E	CALL ATTACHIO	X	EXPLAIN

C?

SAMPLE IOCDPNO PROGRAM - WRITE ONES TO MAG TAPE

C?L 7  
C?C 4096  
C?B %177777,4096  
C?F 1                   (1 - WRITE, 0 - READ)  
C?E  
C?

## System Information

### SPOOK

SPOOK allows you to interrogate and operate on spooled device-files (spoolfiles) created and maintained by MPE. SPOOK runs under control of MPE and only in on-line (session) mode.

To run SPOOK, log on to the system and enter:

```
:RUN SPOOK.PUB.SYS  
-----
```

For an explanation of all SPOOK commands, enter either XPLAIN or HELP after the program prompt (>).

### DISKED2

DISKED2 allows you to modify or display the contents of a disc according to absolute sector addresses. To execute DISKED2 you must have System Manager capability. This program runs in Privileged Mode.

To run DISKED2, log on to the system and enter:

```
:RUN DISKED2.PUB.SYS  
-----
```

For an explanation of all DISKED2 commands, enter HELP after the program prompt (>).

System Information

INTERRUPTS/TRAPS

STT Entry Number	Interrupt	Parameter
	EXTERNAL INTERRUPT	DEV#
1	BOUNDS VIOLATION	100401
2	ILLEGAL MEMORY ADDRESS	101001
3	NON-RESPONDING MODULE	101401
4	SYSTEM PARITY ERROR	102001
5	ADDRESS PARITY ERROR	102401
6	DATA PARITY ERROR	103001
7	MODULE INTERRUPT	MODULE#
11	POWER FAIL	104401
20	UNIMPLEMENTED INSTRUCTION	110001
21	STT VIOLATION	110401
22	CST VIOLATION	111001
23	DST VIOLATION	111401
24	STACK UNDERFLOW	112001
25	PRIVILEGED MODE VIOLATION	112401
30	STACK OVERFLOW	114001
31	USER TRAPS	114401
	INTEGER OVERFLOW	1
	FLOATING-POINT OVERFLOW	2
	FLOATING-POINT UNDERFLOW	3
	INTEGER DIVIDE BY 0	4
	FLOATING-POINT DIVIDE BY 0	5
	EXT. PRECISION OVERFLOW	10
	EXT. PRECISION UNDERFLOW	11
	EXT. PRECISION DIVIDE BY 0	12
	DECIMAL OVERFLOW	13
	INVALID ASCII DIGIT	14
	INVALID DECIMAL DIGIT	15
	INVALID SOURCE WORD COUNT	16
	RESULT WORD COUNT OVERFLOW	17
	DECIMAL DIVIDE BY 0	20
37	ABSENT CODE SEGMENT	
	PCAL	P-LABEL
	EXIT	N
	IXIT	0
40	TRACE	
	PCAL	P-LABEL
	EXIT	N
	IXIT	0
41	STT ENTRY UNCALLABLE	P-LABEL
42	ABSENT DATA SEGMENT	DST#
43	POWER ON	121401
44	COLD LOAD	
	START I/O (SIO)	0
	DIRECT I/O (DIO)	122001

NOTE: If parameter not shown, parameter is external program label.



System Information

LOGICAL/PHYSICAL SECTOR ADDRESS EXAMPLES

The following examples convert a logical sector address into a physical sector address:

7905A DISC DRIVE

-----		-----	
DISCS	= 2	TOTAL DATA WORDS PER	
HEADS	= 3 DATA (0-2) 1 SERVO	SECTOR = 128	
		TRACK = 48(128) = 6144	
		HEAD = 406(6144) = 2 494 464	
CYLINDERS	= 415 (000 OUTER) (405 INNER)	DRIVE = 3(2 494 464) = 7 483 392	
	= 406 EFFECTIVE (10 SPARE)	-----	

SECTORS = 48/HEAD; UP TO 144/CYLINDER DEPENDING ON SUBTYPE

LOGICAL SECTOR ADDRESS = R1 + R2 WHERE R1 = 48(HEAD) + SECTOR  
R2 = 144(CYLINDER)

FIRST LOGICAL SECTOR = R1 + R2 WHERE R1 = 48(0) + 0 = 0  
= 0 + 0 R2 = 144(0) = 0  
= 0

LAST LOGICAL SECTOR = R1 + R2 WHERE R1 = 48(2) + 47 = 143  
= 143 + 58 320 R2 = 144(405) = 58 320  
= 58 463

TOTAL DATA WORDS = 58 463(128) = 7 483 264

TO CONVERT A LOGICAL SECTOR ADDRESS TO A PHYSICAL SECTOR ADDRESS:

CYLINDER + REMAINDER A		HEAD + REMAINDER B	
-----		-----	
144	LOGICAL SECTOR ADDRESS	48	REMAINDER A

REMAINDER B = SECTOR

USING THE LAST LOGICAL SECTOR ADDRESS THIS IS:

405 RA 143	2 RB 47	CYLINDER = 405
-----	-----	HEAD = 2
144   58463	48   143	SECTOR = 47

7920A DISC DRIVE

DISCS	= 3	TOTAL DATA WORDS PER	
HEADS	= 5 DATA (0-4) 1 SERVO	SECTOR = 128	
		TRACK = 48(128) = 6144	
		HEAD = 815(6144) = 5 007 360	
CYLINDERS	= 823 (000 OUTER) (822 INNER)	DRIVE = 5(5 007 360) = 25 036 800	
	= 815 EFFECTIVE (8 SPARE)		

SECTORS = 48/HEAD; 240/CYLINDER

LOGICAL SECTOR ADDRESS = R1 + R2 WHERE R1 = 48(HEAD) + SECTOR  
R2 = 240(CYLINDER)

FIRST LOGICAL SECTOR = R1 + R2 WHERE R1 = 48(0) + 0 = 0  
= 0 + 0 R2 = 240(0) = 0  
= 0

LAST LOGICAL SECTOR = R1 + R2 WHERE R1 = 48(4) + 47 = 239  
= 239 + 195 360 R2 = 240(814) = 195 360  
= 195 599

TOTAL DATA WORDS = 195 600(128) = 25 036 800

TO CONVERT A LOGICAL SECTOR ADDRESS TO A PHYSICAL SECTOR ADDRESS:

CYLINDER + REMAINDER A		HEAD + REMAINDER B	
240	LOGICAL SECTOR ADDRESS	48	REMAINDER A

REMAINDER B = SECTOR

USING THE LAST LOGICAL SECTOR ADDRESS THIS IS:

814	RA	239	4	RB	47	CYLINDER = 814
240		195599	48		239	HEAD = 4
						SECTOR = 47

System Information

7925A DISC DRIVE

DISCS	= 5	TOTAL DATA WORDS PER	
HEADS	= 9 DATA (0-8) 1 SERVO	SECTOR = 128	
		TRACK = 64(128) = 8192	
		HEAD = 815(8192) = 6 676 480	
CYLINDERS	= 823 (000 OUTER) (822 INNER)	DRIVE = 9(6 676 480) = 60 088 320	
	= 815 EFFECTIVE (8 SPARE)		

SECTORS = 64/HEAD; 576/CYLINDER

LOGICAL SECTOR ADDRESS = R1 + R2 WHERE R1 = 64(HEAD) + SECTOR  
R2 = 576(CYLINDER)

FIRST LOGICAL SECTOR = R1 + R2 WHERE R1 = 64(0) + 0 = 0  
= 0 + 0 R2 = 576(0) = 0  
= 0

LAST LOGICAL SECTOR = R1 + R2 WHERE R1 = 64(8) + 63 = 575  
= 575 + 468 864 R2 = 576(814) = 468 864  
= 469 439

TOTAL DATA WORDS = 469 440(128) = 60 088 320

TO CONVERT A LOGICAL SECTOR ADDRESS TO A PHYSICAL SECTOR ADDRESS:

CYLINDER + REMAINDER A		HEAD + REMAINDER B	
576   LOGICAL SECTOR ADDRESS	64	REMAINDER A	

REMAINDER B = SECTOR

USING THE LAST LOGICAL SECTOR ADDRESS THIS IS:

814 RA 575	8 RB 63	CYLINDER = 814
-----	-----	HEAD = 8
576   469439	64   575	SECTOR = 63

ASCII CODE CHART

HOW TO USE THIS TABLE

- The table is sorted by character code, each code being represented by its decimal, octal, and hexadecimal equivalent.
- Each row of the table gives the ASCII and EBCDIC meaning of the character code, the ASCII ↔ EBCDIC conversion code, and the Hollerith representation (punched card code) for the ASCII character.

The following examples describe several ways of using the table:

Example 1: Suppose you want to determine the ASCII code for the \$ character. Scan down the ASCII graphic column until you locate \$, then look left on that row to find the character code — 36 (dec), 044 (oct), and 24 (hex). This is the code used by an ASCII device (terminal, printer, computer, etc.) to represent the \$ character. Its Hollerith punched card code is 11-3-8.

Example 2: The character code 5B (hex) is the EBCDIC code for what character? Also, when 5B is converted to ASCII (for example, by FCOPY with the EBCDICIN option), what is the octal character code? First, locate 5B in the hex character code column and move right on that row to the EBCDIC graphic which is \$. The next column to the right gives the conversion to ASCII, 044. As a check, find 044 (oct) in the character code column, look right to the ASCII graphic column and note that \$ converted to EBCDIC is 133 (oct) which equals 5B (hex).

CHAR CODE			ASCII			EBCDIC	
Dec	Oct	Hex	Cntl/ Gph	to EBCDIC (Oct)	Hollerith	Cntl/ Gph	to ASCII (Oct)
0	000	00	NUL	000	12-0-1-8-9	NUL	000
1	001	01	SOH	001	12-1-9	SOH	001
2	002	02	STX	002	12-2-9	STX	002
3	003	03	ETX	003	12-3-9	ETX	003
4	004	04	EOT	067	7-9	PF	234
5	005	05	ENO	055	0-5-8-9	HT	011
6	006	06	AK	056	0-6-8-9	IFS	206
7	007	07	BEL	057	0-7-8-9	DEL	177
8	010	08	BS	026	11-6-9		227
9	011	09	HT	005	12-5-9		215
10	012	0A	LF	045	0-5-9	SMM	216
11	013	0B	VT	013	12-3-8-9	VT	013
12	014	0C	FF	014	12-4-8-9	FF	014
13	015	0D	CR	015	12-5-8-9	CR	015
14	016	0E	SO	016	12-6-8-9	SO	016
15	017	0F	SI	017	12-7-8-9	SI	017
16	020	10	DLE	020	12-11-1-8-9	DLE	020
17	021	11	DC1	021	11-1-9	DC1	021
18	022	12	DC2	022	11-2-9	DC2	022
19	023	13	DC3	023	11-3-9	TM	023
20	024	14	DC4	074	4-8-9	RES	235
21	025	15	NAK	075	5-8-9	NL	205
22	026	16	SYN	062	2-9	BS	010
23	027	17	ET8	046	0-6-9	IL	207
24	030	18	CAN	030	11-8-9	CAN	030
25	031	19	EM	031	11-1-8-9	EM	031
26	032	1A	SUB	077	7-8-9	CC	222
27	033	1B	ESC	047	0-7-9	CU1	217
28	034	1C	FS	034	11-4-8-9	IFS	034
29	035	1D	GS	035	11-5-8-9	IGS	035
30	036	1E	RS	036	11-6-8-9	IRS	036
31	037	1F	US	037	11-7-8-9	IUS	037
32	040	20	SP	100	Blank	DS	200
33	041	21	!	117	12-7-8	SOS	201
34	042	22	"	177	7-8	FS	202
35	043	23	#	173	3-8		203
36	044	24	\$	133	11-3-8	BYP	204
37	045	25	%	154	0-4-8	LF	012
38	046	26	&	120	12	ETB	027
39	047	27	'	175	5-8	ESC	033
40	050	28	(	115	12-5-8		210
41	051	29	)	135	11-5-8		211
42	052	2A	*	134	11-4-8	SM	212
43	053	2B	+	118	12-6-8	CU2	213
44	054	2C	,	153	0-3-8		214
45	055	2D	-	140	11	ENQ	005
46	056	2E	.	113	12-3-8	ACK	006
47	057	2F	/	141	0-1	BEL	007

CHAR CODE			ASCII			EBCDIC	
Dec	Oct	Hex	Cntl/ Gph	to EBCDIC (Oct)	Hollerith	Cntl/ Gph	to ASCII (Oct)
48	060	30		0			220
49	061	31		1			221
50	062	32		2		SYN	026
51	063	33		3			223
52	064	34		4		PN	224
53	065	35		5		PS	225
54	066	36		6		UC	226
55	067	37		7		EDT	007
56	070	38		8			230
57	071	39		9			231
58	072	3A		:			232
59	073	3B		:		CU3	233
60	074	3C		<		DC4	024
61	075	3D		=		NAK	025
62	076	3E		>			236
63	077	3F		?		SUB	032
64	100	40		@		SP	040
65	101	41		A			240
66	102	42		B			241
67	103	43		C			242
68	104	44		D			243
69	105	45		E			244
70	106	46		F			245
71	107	47		G			246
72	110	48		H			247
73	111	49		I			250
74	112	4A		J			133
75	113	4B		K			056
76	114	4C		L			074
77	115	4D		M			050
78	116	4E		N			053
79	117	4F		O			041
80	120	50		P			046
81	121	51		Q			251
82	122	52		R			252
83	123	53		S			253
84	124	54		T			254
85	125	55		U			255
86	126	56		V			256
87	127	57		W			257
88	130	58		X			260
89	131	59		Y			261
90	132	5A		Z			135
91	133	5B		[			044
92	134	5C		\			052
93	135	5D		]			051
94	136	5E		^			073
95	137	5F		_			136

System Information

ASCII CODE CHART (Continued)

CHAR CODE			ASCII		EBCDIC		
Dec	Oct	Hex	Cntl/ Gph	to EBCDIC (Oct)	Hollerith	Cntl/ Gph	to ASCII (Oct)
96	140	60		171	1-8	-	055
97	141	61	a	201	12-0-1	/	057
98	142	62	b	202	12-0-2		262
99	143	63	c	203	12-0-3		263
100	144	64	d	204	12-0-4		264
101	145	65	e	205	12-0-5		265
102	146	66	f	206	12-0-6		266
103	147	67	g	207	12-0-7		267
104	150	68	h	210	12-0-8		270
105	151	69	i	211	12-0-9		271
106	152	6A	j	221	12-1-1	:	174
107	153	6B	k	222	12-1-2	;	054
108	154	6C	l	223	12-1-3	%	045
109	155	6D	m	224	12-1-4		137
110	156	6E	n	225	12-1-5	>	076
111	157	6F	o	226	12-1-6	?	077
112	160	70	p	227	12-1-7		272
113	161	71	q	230	12-1-8		273
114	162	72	r	231	12-1-9		274
115	163	73	s	242	11-0-2		275
116	164	74	t	243	11-0-3		276
117	165	75	u	244	11-0-4		277
118	166	76	v	245	11-0-5		300
119	167	77	w	246	11-0-6		301
120	170	78	x	247	11-0-7		302
121	171	79	y	250	11-0-8		140
122	172	7A	z	251	11-0-9	:	072
123	173	7B	{	300	12-0	~	043
124	174	7C		152	12-11	@	100
125	175	7D	}	320	11-0		047
126	176	7E	~	241	11-0-1		206
127	177	7F	DEL	007	12-7-9		042
128	200	80		040	11-0-1-8-9		303
129	201	81		041	0-1-9	a	141
130	202	82		042	0-2-9	b	142
131	203	83		043	0-3-9	c	143
132	204	84		044	0-4-9	d	144
133	205	85		025	11-5-9	e	145
134	206	86		006	12-6-9	f	146
135	207	87		027	11-7-	g	147
136	210	88		050	0-3-9	h	150
137	211	89		051	0-1-8-9	i	151
138	212	8A		052	0-2-8-9		304
139	213	8B		053	0-3-8-9		305
140	214	8C		054	0-4-8-9		306
141	215	8D		011	12-1-8-9		307
142	216	8E		012	12-2-8-9		310
143	217	8F		033	11-3-8-9		311
144	220	90		060	12-11-0-1-8-9		312
145	221	91		061	1-9	j	152
146	222	92		032	11-2-8-9	k	153
147	223	93		063	3-9	l	154
148	224	94		064	4-9	m	155
149	225	95		065	5-9	n	156
150	226	96		066	6-9	o	157
151	227	97		010	12-8-9	p	160
152	230	98		070	8-9	q	161
153	231	99		071	1-8-9	r	162
154	232	9A		072	2-8-9	s	313
155	233	9B		073	3-8-9	t	314
156	234	9C		004	12-4-9		315
157	235	9D		024	11-4-9		316
158	236	9E		076	6-8-9		317
159	237	9F		341	11-0-1-9		320
160	240	A0		101	12-0-1-9		321
161	241	A1		102	12-0-2-9	~	176
162	242	A2		103	12-0-3-9	s	163
163	243	A3		104	12-0-4-9	t	164
164	244	A4		105	12-0-5-9	u	165
165	245	A5		106	12-0-6-9	v	166
166	246	A6		107	12-0-7-9	w	167
167	247	A7		110	12-0-8-9	x	170
168	250	A8		111	12-1-8	y	171
169	251	A9		121	12-11-1-9	z	172
170	252	AA		122	12-11-2-9		322
171	253	AB		123	12-11-3-9		323
172	254	AC		124	12-11-4-9		324
173	255	AD		125	12-11-5-9		325
174	256	AE		126	12-11-6-9		326
175	257	AF		127	12-11-7-9		327

CHAR CODE			ASCII		EBCDIC		
Dec	Oct	Hex	Cntl/ Gph	to EBCDIC (Oct)	Hollerith	Cntl/ Gph	to ASCII (Oct)
176	260	B0		130	12-11-8-9		330
177	261	B1		131	11-1-8		331
178	262	B2		142	11-0-2-9		332
179	263	B3		143	11-0-3-9		333
180	264	B4		144	11-0-4-9		334
181	265	B5		145	11-0-5-9		335
182	266	B6		146	11-0-6-9		336
183	267	B7		147	11-0-7-9		337
184	270	B8		150	11-0-8-9		340
185	271	B9		151	0-1-8		341
186	272	BA		160	12-11-0		342
187	273	BB		161	12-11-0-1-9		343
188	274	BC		162	12-11-0-2-9		344
189	275	BD		163	12-11-0-3-9		345
190	276	BE		164	12-11-0-4-9		346
191	277	BF		165	12-11-0-5-9		347
192	300	C0		166	12-11-0-6-9	{	173
193	301	C1		167	12-11-0-7-9	A	101
194	302	C2		170	12-11-0-8-9	B	102
195	303	C3		200	12-0-1-8	C	103
196	304	C4		212	12-0-2-8	D	104
197	305	C5		213	12-0-3-8	E	105
198	306	C6		214	12-0-4-8	F	106
199	307	C7		215	12-0-5-8	G	107
200	310	C8		216	12-0-6-8	H	110
201	311	C9		217	12-0-7-8	I	111
202	312	CA		220	12-11-1-8		350
203	313	CB		232	12-11-2-8		351
204	314	CC		233	12-11-3-8	J	352
205	315	CD		234	12-11-4-8		353
206	316	CE		235	12-11-5-8		354
207	317	CF		236	12-11-6-8		355
208	320	D0		237	12-11-7-8	}	175
209	321	D1		240	11-0-1-8	J	112
210	322	D2		252	11-0-2-8	K	113
211	323	D3		253	11-0-3-8	L	114
212	324	D4		254	11-0-4-8	M	115
213	325	D5		255	11-0-5-8	N	116
214	326	D6		256	11-0-6-8	O	117
215	327	D7		257	11-0-7-8	P	120
216	330	D8		260	12-11-0-1-8	Q	121
217	331	D9		261	12-11-0-1	R	122
218	332	DA		262	12-11-0-2		356
219	333	DB		263	12-11-0-3		357
220	334	DC		264	12-11-0-4		360
221	335	DD		265	12-11-0-5		361
222	336	DE		266	12-11-0-6		362
223	337	DF		267	12-11-0-7		363
224	340	E0		270	12-11-0-8	\	134
225	341	E1		271	12-11-0-9		237
226	342	E2		272	12-11-0-2-8	S	123
227	343	E3		273	12-11-0-3-8	T	124
228	344	E4		274	12-11-0-4-8	U	125
229	345	E5		275	12-11-0-5-8	V	126
230	346	E6		276	12-11-0-6-8	W	127
231	347	E7		277	12-11-0-7-8	X	130
232	350	E8		312	12-0-2-8-9	Y	131
233	351	E9		313	12-0-3-8-9	Z	132
234	352	EA		314	12-0-4-8-9		364
235	353	EB		315	12-0-5-8-9		365
236	354	EC		316	12-0-6-8-9		366
237	355	ED		317	12-0-7-8-9		367
238	356	EE		332	12-11-2-8-9		370
239	357	EF		333	12-11-3-8-9		371
240	360	F0		334	12-11-4-8-9	0	060
241	361	F1		335	12-11-5-8-9	1	061
242	362	F2		336	12-11-6-8-9	2	062
243	363	F3		337	12-11-7-8-9	3	063
244	364	F4		352	11-0-2-8-9	4	064
245	365	F5		353	11-0-3-8-9	5	065
246	366	F6		354	11-0-4-8-9	6	066
247	367	F7		355	11-0-5-8-9	7	067
248	370	F8		356	11-0-6-8-9	8	070
249	371	F9		357	11-0-7-8-9	9	071
250	372	FA		372	12-11-0-2-8-9		372
251	373	FB		373	12-11-0-3-8-9		373
252	374	FC		374	12-11-0-4-8-9		374
253	375	FD		375	12-11-0-5-8-9		375
254	376	FE		376	12-11-0-6-8-9		376
255	377	FF		377	12-11-0-7-8-9	EO	377

System Information

ASCII CHARACTER SET/COLLATING SEQUENCE

BYTE POSITION			
CHAR	Left	Right	Dec.
NUL	000000	000000	0
SOH	000400	000001	1
STX	001000	000002	2
ETX	001400	000003	3
EOT	002000	000004	4
ENO	002400	000005	5
ACK	003000	000006	6
BEL	003400	000007	7
BS	004000	000010	8
HT	004400	000011	9
LF	005000	000012	10
VT	005400	000013	11
FF	006000	000014	12
CR	006400	000015	13
SO	007000	000016	14
SI	007400	000017	15
OLE	010000	000020	16
DC1	010400	000021	17
DC2	011000	000022	18
DC3	011400	000023	19
DC4	012000	000024	20
NAK	012400	000025	21
SYN	013000	000026	22
ETB	013400	000027	23
CAN	014000	000030	24
EM	014400	000031	25
SUB	015000	000032	26
ESC	015400	000033	27
FS	016000	000034	28
GS	016400	000035	29
RS	017000	000036	30
US	017400	000037	31
SPACE	020000	000040	32
!	020400	000041	33
:"	021000	000042	34
=	021400	000043	35
\$	022000	000044	36
%	022400	000045	37
&	023000	000046	38
'	023400	000047	39
(	024000	000050	40
)	024400	000051	41
*	025000	000052	42
+	025400	000053	43
,	026000	000054	44

BYTE POSITION			
CHAR	Left	Right	Dec.
-	026400	000055	45
.	027000	000056	46
/	027400	000057	47
0	030000	000060	48
1	030400	000061	49
2	031000	000062	50
3	031400	000063	51
4	032000	000064	52
5	032400	000065	53
6	033000	000066	54
7	033400	000067	55
8	034000	000070	56
9	034400	000071	57
:	035000	000072	58
:	035400	000073	59
<	036000	000074	60
=	036400	000075	61
>	037000	000076	62
?	037400	000077	63
@	040000	000100	64
A	040400	000101	65
B	041000	000102	66
C	041400	000103	67
D	042000	000104	68
E	042400	000105	69
F	043000	000106	70
G	043400	000107	71
H	044000	000110	72
I	044400	000111	73
J	045000	000112	74
K	045400	000113	75
L	046000	000114	76
M	046400	000115	77
N	047000	000116	78
O	047400	000117	79
P	050000	000120	80
Q	050400	000121	81
R	051000	000122	82
S	051400	000123	83
T	052000	000124	84
U	052400	000125	85
V	053000	000126	86
W	053400	000127	87
X	054000	000130	88
Y	054400	000131	89
Z	055000	000132	90

BYTE POSITION			
CHAR	Left	Right	Dec.
[	055400	000133	91
\	056000	000134	92
]	056400	000135	93
^	057000	000136	94
_	057400	000137	95
`	060000	000140	96
a	060400	000141	97
b	061000	000142	98
c	061400	000143	99
d	062000	000144	100
e	062400	000145	101
f	063000	000146	102
g	063400	000147	103
h	064000	000150	104
i	064400	000151	105
j	065000	000152	106
k	065400	000153	107
l	066000	000154	108
m	066400	000155	109
n	067000	000156	110
o	067400	000157	111
p	070000	000160	112
q	070400	000161	113
r	071000	000162	114
s	071400	000163	115
t	072000	000164	116
u	072400	000165	117
v	073000	000166	118
w	073400	000167	119
x	074000	000170	120
y	074400	000171	121
z	075000	000172	122
{	075400	000173	123
	076000	000174	124
}	076400	000175	125
~	077000	000176	126
DEL	077400	000177	127

System Information

NOTES

# CENTRAL PROCESSOR UNIT

SECTION

II

## Table Of Contents

Topic	Page
System Startup Procedures .....	2-2
Disc Based System Startup .....	2-2
Magnetic Tape Based System Startup (From SYSDUMP Tape) .	2-2
System Backup .....	2-3
Startup Procedures Summary .....	2-3
Source of MPE System Components .....	2-4
ROM PCA Jumper Locations .....	2-5
Skip and Special Field PCA Jumper Locations .....	2-6
S-Bus PCA Switch Locations .....	2-7
CIR PCA Jumper Locations .....	2-8
System Control Panel Jumper Locations .....	2-9





## Central Processor Unit

### SYSTEM STARTUP PROCEDURES

There are two basic system startup procedures; one for a disc based system and one for a mag tape based system (from SYSDUMP Tape).

#### DISC BASED SYSTEM STARTUP

---

##### COOLSTART:

- a. Starts the system from disc.
- b. Does not recover current work (spoofiles).
- c. Second fastest way to start a system.

##### WARMSTART:

- a. Starts the system from disc.
- b. Recovers (saves) current spoofiles (spooled output or input information).
- c. Probably the fastest way to start a system.
- d. Only applies to crashes or if terminals hang up.

#### NOTE

You must reset the outfence to its appropriate level. Check with system manager to determine where it belongs.

#### MAGNETIC TAPE BASED SYSTEM STARTUP (FROM SYSDUMP TAPE)

---

##### COLDSTART:

- a. User files remain on disc.
- b. You get MPE and system configuration data from tape.

##### UPDATE:

- a. User files and configuration data remain on disc.
- b. You get MPE from tape.
- c. Replaces all drivers.

RELOAD:

- a. You get MPE.
- b. User files and configuration data from tape.
- c. Nothing comes from disc.

SYSTEM BACKUP  
-----

During SYSDUMP procedures, the following responses can be entered after the DUMP DATE? prompt:

- 0 Copies everything from day zero
- CR Copies SYS account, PUB group, and some MPE files to stay operational

Current Date Copies files changed on current date

Future Date Copies accounting structure

STARTUP PROCEDURES SUMMARY

TYPE	SOURCE	
	DISC	TAPE
COOLSTART	MPE User files Configuration	
WARMSTART	MPE User files Configuration Spoofiles	
COLDSTART	User files	MPE Configuration
UPDATE	User files Configuration	MPE
RELOAD		MPE User files Configuration

Central Processor Unit

SOURCE OF MPE SYSTEM COMPONENTS

MPE COMPONENT	WARMSTART	COOLSTART	UPDATE	COLDSTART	RELOAD*
MPE Programs System Library	disc	disc	tape	tape	tape
I/O & System Configuration	disc	disc	disc	tape	tape
Accounting Info, File Directory, Volume Table & User Files	disc	disc	disc	disc	tape
Spoolfiles & Jobs	disc	----	----	----	----

\* Certain information which may reside on the disc is checked for validity.

ROM PCA JUMPER LOCATIONS

NOTE

The ROM PCA is loaded with ROM's that have a capacity of 2K words. Therefore, jumpers W5 through W8 are always installed in the four positions nearest the 2K marking as shown below.

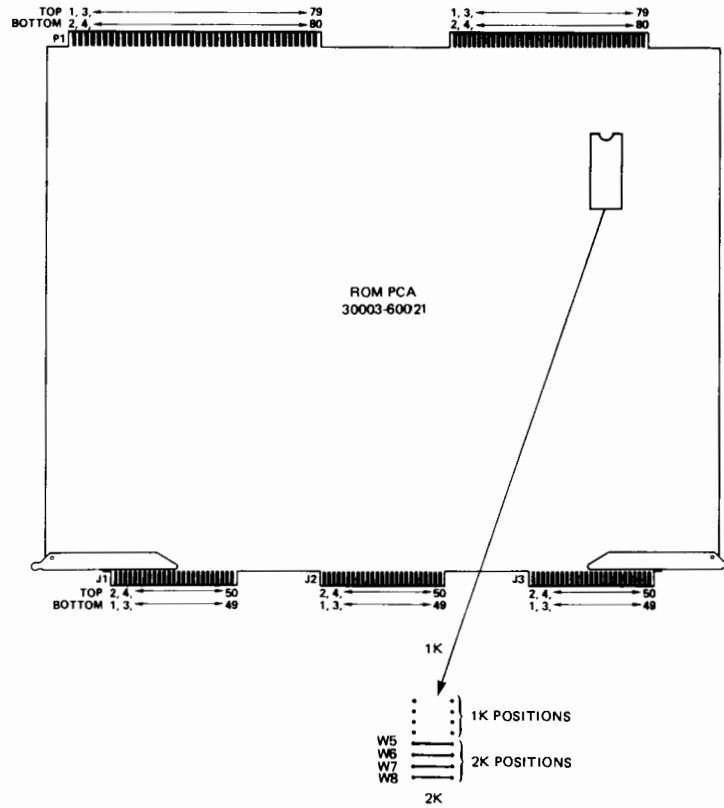

Reference: RTM

Central Processor Unit

SKIP AND SPECIAL FIELD PCA JUMPER LOCATIONS

NOTE

Sync jumpers W1 and W2 are always installed as shown below.

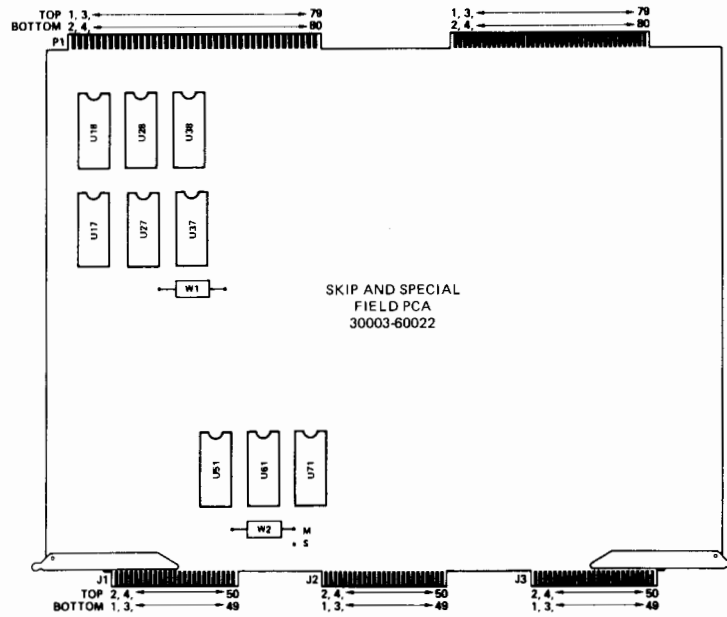

Reference: RTM

S-BUS PCA SWITCH LOCATIONS

NOTE

Memory Size Switch S3 is set to agree with the total size of semiconductor memory in thousands of words as shown below. Memory Interleaving Switches S1 and S2 must be configured for non-interleaving (i.e., positions 1 through 4 of S1 closed and all positions of S2 open). For additional memory interleaving information, refer to the Reference Training Manual.



MEMORY SIZE

(WORDS)	S1	S2
S3		
1 - 128K	1-4 CLOSED	
2 - 256K	5-7 OPEN	1-4 OPEN
3 - 384K		
4 - 512K		
5 - 768K		
6 - 1024K		

147006 21

Reference: RTM

JUL 1981

2-7

Central Processor Unit

CIR PCA JUMPER LOCATIONS

NOTE

If the EIS PCA is not installed in the system, jumpers W1 through W8 are all installed on the CIR PCA as shown below. When the EIS PCA is installed, jumpers W1 and W8 must be removed. Removing W1 enables the floating point instructions and removing W8 enables the decimal instruction set.

When APL (Product Number HP 32105A) is installed on the EIS PCA, jumper W2 on the CIR PCA must be removed to enable the APL instructions.

When COBOL II (Product Number HP 32234A) is installed on the EIS PCA, jumper W4 on the CIR PCA must be removed to enable the COBOL II instructions.

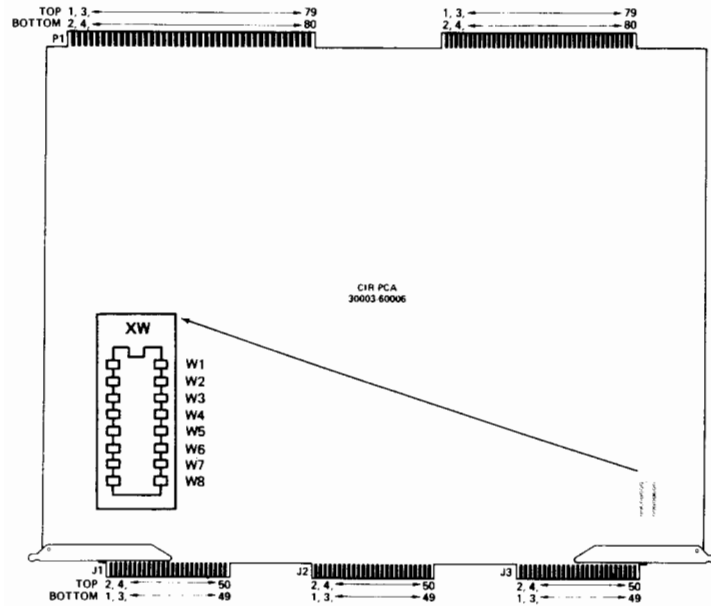

147006 22

Reference: RTM

Central Processor Unit

SYSTEM CONTROL PANEL JUMPER LOCATIONS

NOTE

The DRT NUMBER is shown configured for system dump device DRT #6 (usually the mag tape), and the CONTROL BYTE is shown configured for a WRITE control word.

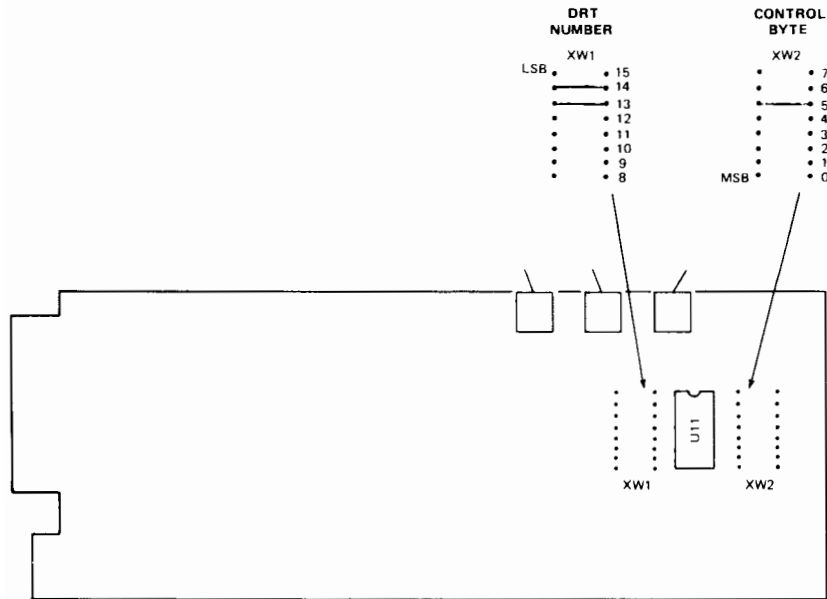

Reference: RTM



Central Processor Unit

NOTES

# MEMORY

SECTION

III

## Table Of Contents

Topic	Page
Memory Configurations .....	3-2
Memory Module Interface Diagram .....	3-3
MCU PCA Jumper Locations .....	3-4
SMA PCA Switch Location .....	3-5
MCL PCA Switch Locations .....	3-6
System Clock/FLI PCA Jumper Locations .....	3-7
Error Correction .....	3-8
Typical MEMLOGAN Printout .....	3-8



Memory

MEMORY CONFIGURATIONS

BANKS	SYSTEM WORD CAPACITY	PCA'S REQUIRED			
		MCL	SMA	FLI	TOTAL
2	128K	1	1	1	3
4	256K	1	2	1	4
6	384K	1	3	1	5
8	512K	1	4	1	6
12	768K	2	6	1	9
16	1024K	2	8	1	11

NOTE

When changing memory configuration, check that the switches on the MCL, SMA, S-Bus, IOP, and Selector Channel Register PCA's are set to the proper memory size.

Memory has the following operating modes and specifications:

- \* WRITE 700 nsec minimum cycle time.
- \* READ 350 nsec access, 700 nsec cycle time.
- \* NO OPERATION (NOP) 700 nsec cycle time.

Reference: RTM

MEMORY MODULE INTERFACE DIAGRAM

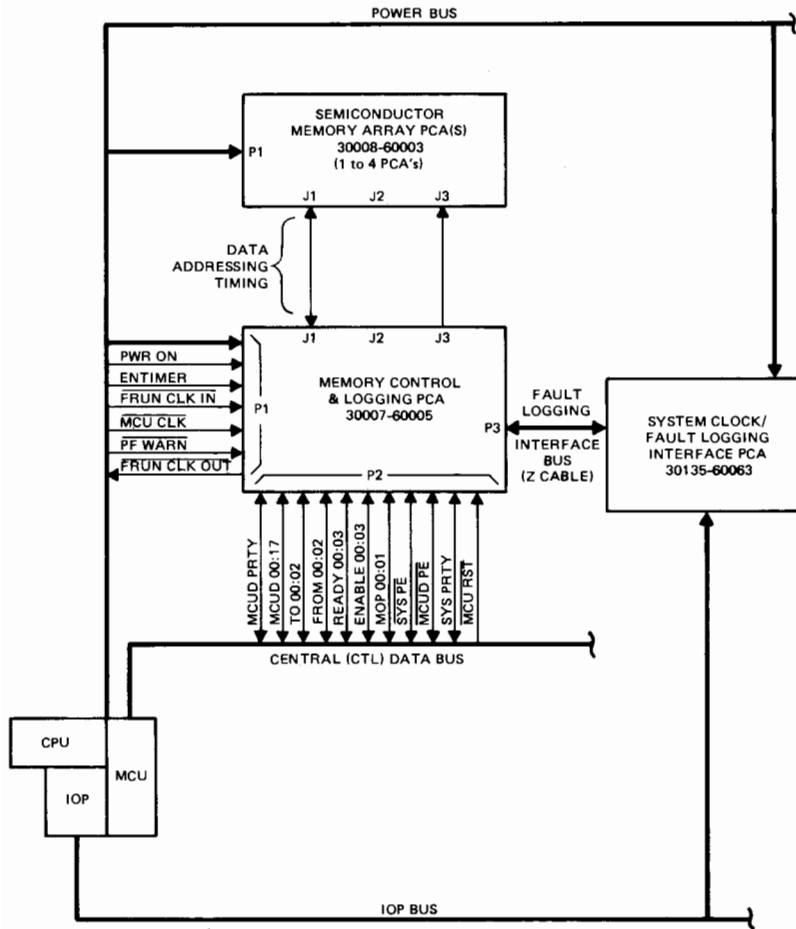

Reference: RTM

MCU PCA JUMPER LOCATIONS

NOTE

Jumpers W1 (ENABLE), W6 (READY 5), and W8 (MCU RESET) are always installed. The CPU must be designated as CPU number one and module number five by the insertion of jumpers W10 and W13, respectively as shown below.

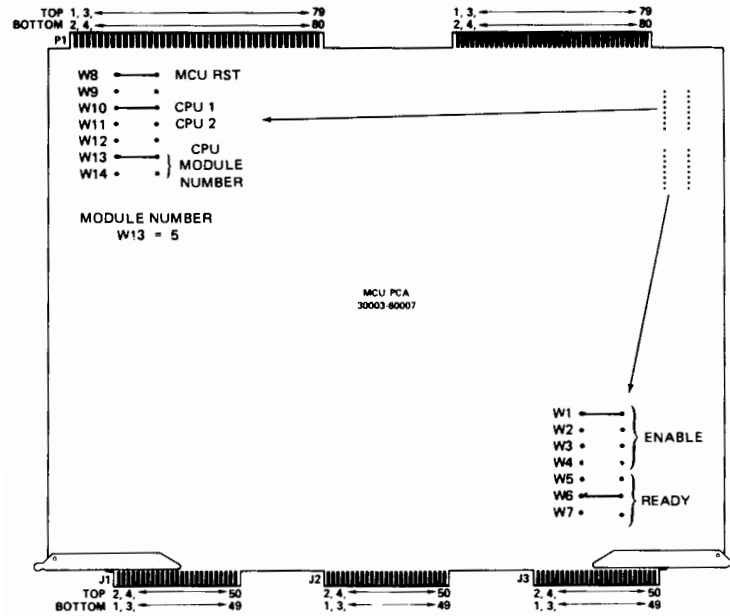

Reference: RTM

SMA PCA SWITCH LOCATION

NOTE

Each SMA PCA installed in the system must have switch S1 (SMA PCA SELECT) set to a position different from the positions selected by any other SMA PCA's associated with the same MCL PCA.

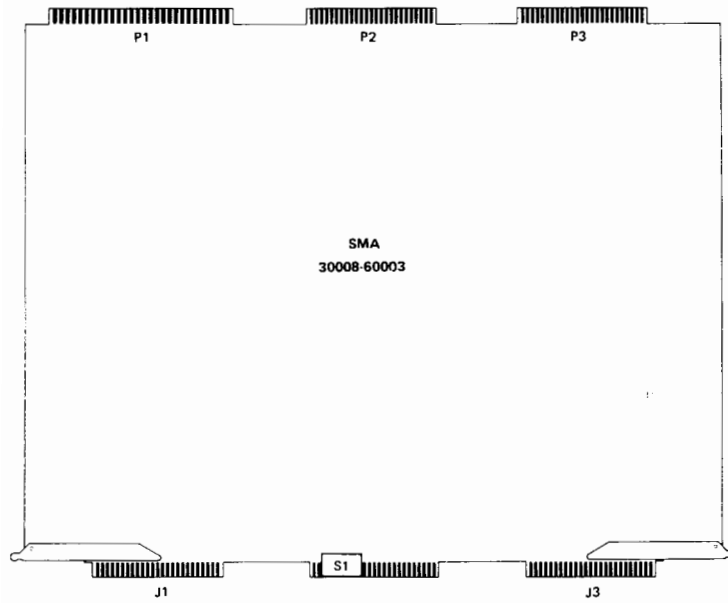

Reference: RTM

Memory

MCL PCA SWITCH LOCATIONS

NOTE

In systems with over 512K words of memory, switch S2 (MEMORY MODULE SELECT) is set to position A on one MCL PCA and to position B on the remaining MCL PCA. Switch S1 (ELA MANUAL CLEAR) clears the Error Logging Array.

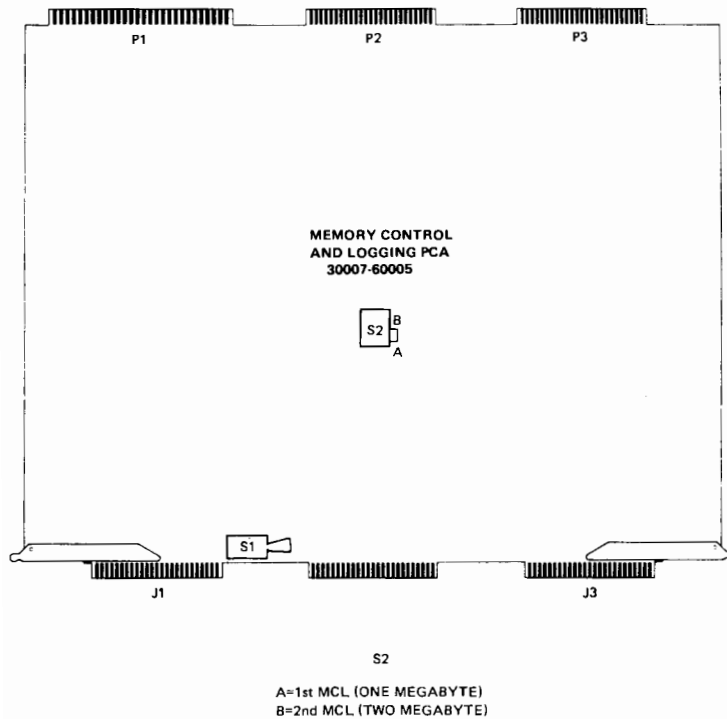

Reference: RTM

SYSTEM CLOCK/FLI PCA JUMPER LOCATIONS

NOTE

DRT 2 is hardwired on this PCA for the FLI and cannot be changed. Jumpers W6 and W7 are installed for system clock DRT 3 (positive logic used for DRT number).

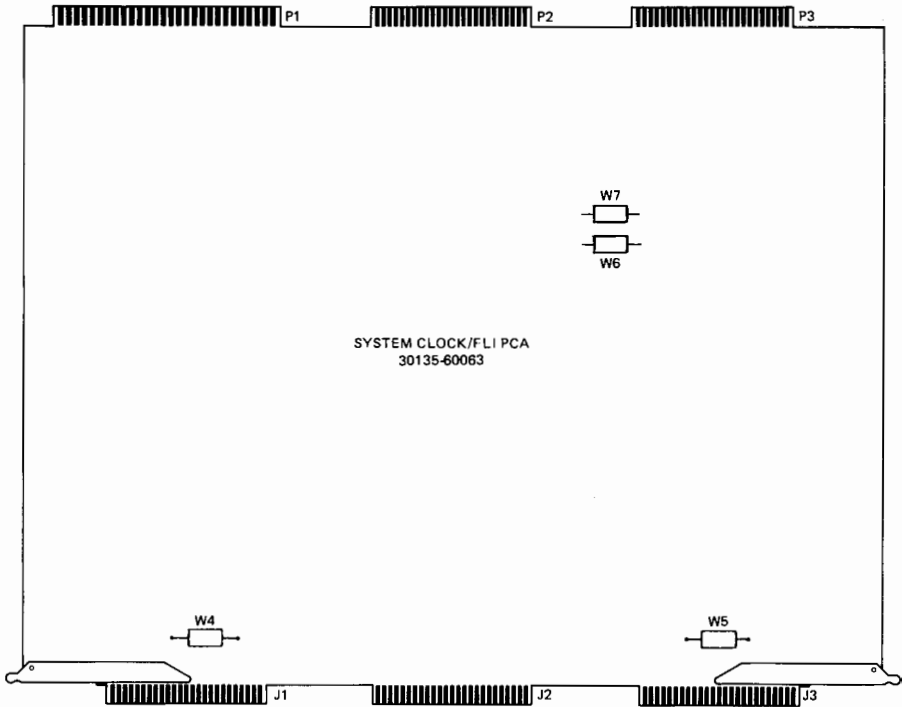



Memory

ERROR CORRECTION

Refer to "Display Memory Logging Errors Function" in Section I of this manual for additional error logging information.

```
:HELLO FIELD.SUPPORT,HP32230
:FILE OUT;DEV=LP
:RUN MEMLOGAN.PUB.SYS
```

Typical MEMLOGAN Printout

ADDRESS			*ERROR TYPE			*ERROR COUNT
CONTROLLER	BOARD	ROW	TYPE	BIT	CHIP	
CONTROLLER A	0	1	CHECK	0	U198	2
		6	DATA	9	U103	13
	1	0	DATA	0	U19	4
		0	MULTIPLE BIT ERROR			1
	2	0	DATA	11	U149	3
		7	DATA	14	U172	2
3	3	CHECK	5	U246	3	
CONTROLLER B	2	0	CHECK	2	U219	1
		6	DATA	11	U143	3
	3	2	DATA	15	U187	4

\*NOTES:

- CHECK TYPE = Check Bit Error. Bit refers to failing check bit; C0 through C5.
- DATA TYPE = Data Bit Error. Bit refers to failing data bit; 0 through 15.
- D.E.W. TYPE = Forced Double Error Write. Indicated data parity error on data transmitted to memory.
- MULTIPLE BIT ERROR TYPE = Error in more than one bit.

Error Count does not indicate the total number of times that an error occurred; it only indicates the total number of errors logged during successive memory log updates. The MEMTIMER utility program (MEMTIMER.PUB.SYS) is used to modify the time interval between successive memory log updates. The normal default interval is 60 minutes.

Reference: RTM

NOTES

Memory

NOTES

3-10

# IOP/CHANNELS

SECTION

IV

## Table Of Contents



Topic	
IOP PCA Jumper and Switch Locations .....	4-2
Multiplexer Channel PCA Jumper Locations .....	4-3
Selector Channel Register PCA Jumper and Switch Descriptions .....	4-4
Selector Channel Register PCA Jumper and Switch Locations .	4-5
Selector Channel Control PCA Indicators .....	4-6
Selector Channel Control PCA Switches .....	4-6
Selector Channel Control PCA Component Locations .....	4-7
Using The Trigger/Freeze Feature .....	4-8
Selector Channel Control PCA Error Logging Register .....	4-8
Selector Channel Cabling Configuration .....	4-9
Selector Channel Maintenance PCA (SCMB) Description .....	4-10
SCMB Jumper Descriptions .....	4-10
SCMB Jumper Locations .....	4-11
SCMB Selector Channel Installation .....	4-12
SCMB Multiplexer Channel Installation .....	4-12
SCMB Verification .....	4-13
Displaying SCMB Signals .....	4-14
SCMB State Display .....	4-14
SCMB Block Diagram .....	4-15
SCMB Programming .....	4-15
I/O Instructions .....	4-16
I/O Program Orders .....	4-16
Control Word .....	4-17
SCMB Control Word Format .....	4-18
Status Word .....	4-20
SCMB Status Word Format .....	4-21

IOP PCA JUMPER AND SWITCH LOCATIONS

NOTE

As shown below, jumper W1 (ENABLE/DISABLE) is not installed. Installation of jumper W1 disables the IOP PCA. Memory Size Switch S3 is set to agree with the total size of semiconductor memory in thousands of words as shown below. Memory Interleaving Switches S1 and S2 must be set for non-interleaving (i.e., positions 1 through 4 of S1 closed and position 6 of S2 closed). For additional memory interleaving information, refer to the Reference Training Manual.

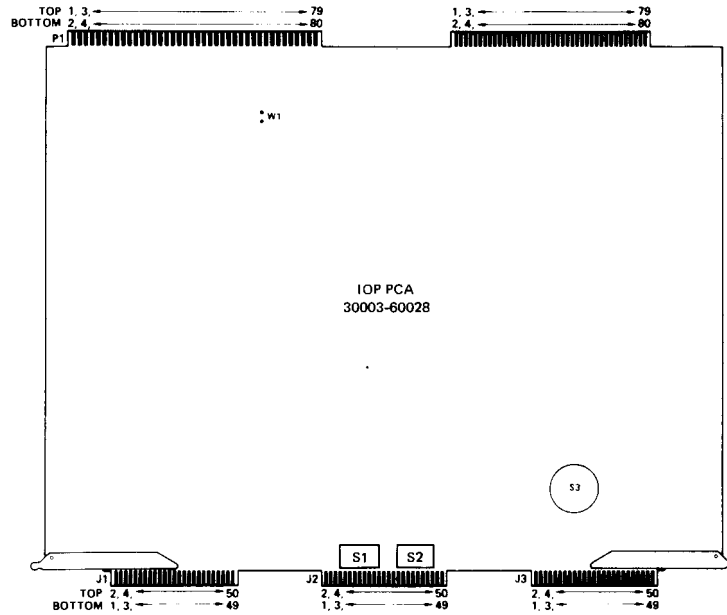

MEMORY SIZE

(WORDS) S3	S1	S2
1 - 128K	1-4 CLOSED	1-5 OPEN
2 - 256K	5-6 OPEN	6 CLOSED
3 - 384K		
4 - 512K		
5 - 768K		
6 - 1024K		

Reference: RTM



IOP PCA JUMPER AND SWITCH LOCATIONS

NOTE

As shown below, jumper W1 (ENABLE/DISABLE) is not installed. Installation of jumper W1 disables the IOP PCA. Memory Size Switch S3 is set to agree with the total size of semiconductor memory in thousands of words as shown below. Memory Interleaving Switches S1 and S2 must be set for non-interleaving (i.e., positions 1 through 4 of S1 closed and position 6 of S2 closed). For additional memory interleaving information, refer to the Reference Training Manual.

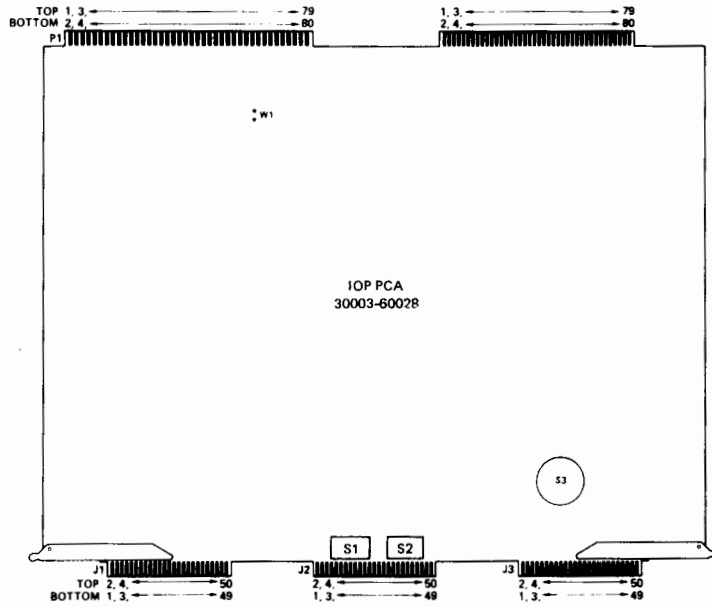

MEMORY SIZE

(WORDS)

S3

- 1 - 128K
- 2 - 256K
- 3 - 384K
- 4 - 512K
- 5 - 768K
- 6 - 1024K

S1

- 1-4 CLOSED
- 5-7 OPEN

S2

- 1-5 and 7 OPEN
- 6 CLOSED

147006-29

Reference: RTM

MULTIPLEXER CHANNEL PCA JUMPER LOCATIONS

NOTE

Jumpers W1 through W7 are Device Number jumpers. A logic "1" is represented by the absence of a jumper and a logic "0" is represented by the presence of a jumper. The Multiplexer Channel PCA's device number is normally %177 (no jumpers installed) as shown below.

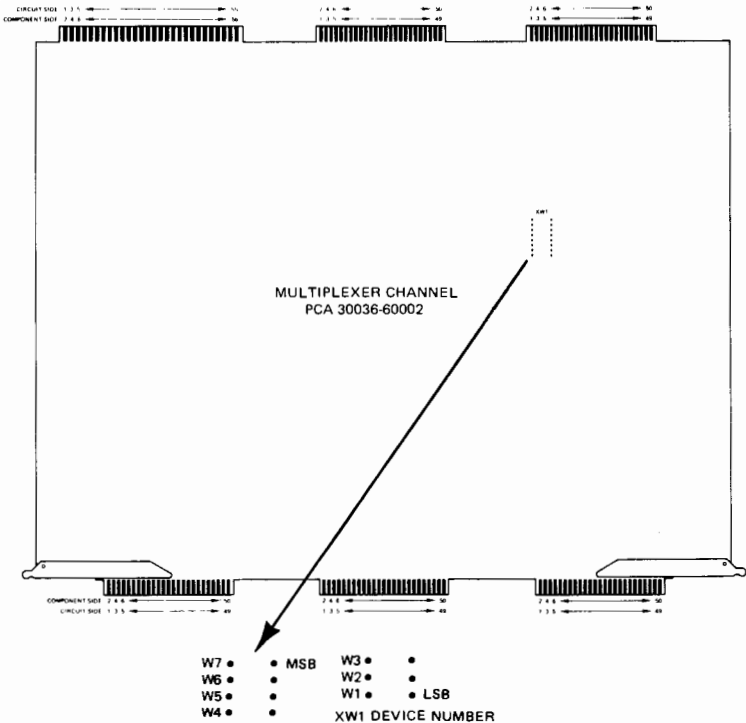

Reference: RTM



SELECTOR CHANNEL REGISTER PCA JUMPER AND SWITCH DESCRIPTIONS

Dual inline sockets XW1, XW3, and XW4 are used to select the channel number of the Selector Channel Register PCA. Installation of a jumper plug into one of the sockets determines the channel number as shown in the following illustration. Memory Size Switch S3 is set to agree with the total size of semiconductor memory in thousands of words as shown. Memory Interleaving Switches S1 and S2 must be configured for non-interleaving (i.e., positions 1 through 4 of S1 closed and all positions of S2 open). For additional memory interleaving information, refer to the Reference Training Manual.

SELECTOR CHANNEL REGISTER PCA JUMPER AND SWITCH LOCATIONS

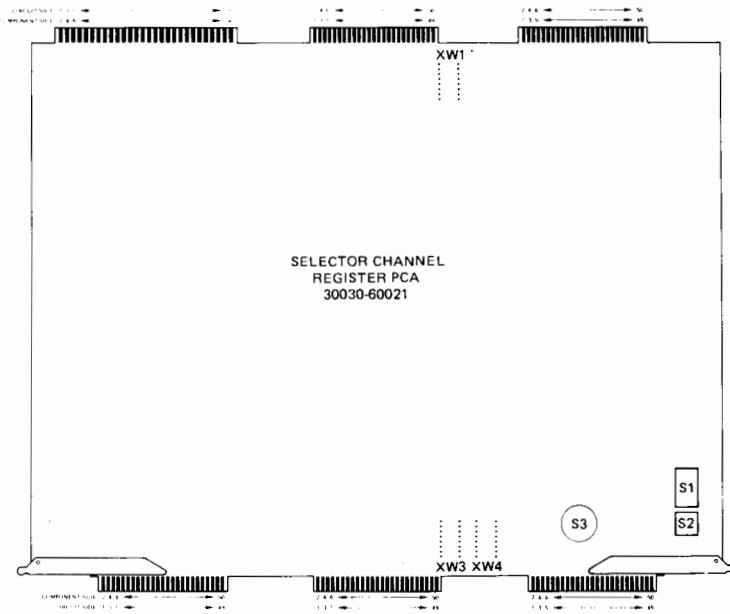

<u>CHANNEL NUMBER</u>	<u>MEMORY SIZE</u> (WORDS)	S2	S1
XW1 - CHANNEL 1	S3		
XW3 - CHANNEL 3	1 - 128K	1-4 OPEN	1-4 CLOSED
XW4 - CHANNEL 4	2 - 256K		5-6 OPEN
(SELECTOR CHANNEL 2 NOT AVAILABLE)	3 - 384K		
	4 - 512K		
	5 - 768K		
	6 - 1024K		

Reference: RTM

## IOP/Channels

## SELECTOR CHANNEL CONTROL PCA INDICATORS

LED	SIGNAL NAME	DESCRIPTION
CR1 thru CR5	IOCW4 thru IOCW0	Order code from Register PCA
CR6	ACTIVE	An order is currently executing
CR7	WCRO	Word count rollover
CR8	DEVEND	Device end from device controller
CR9	XERR	An error occurred
CR10	RR	State of RR (return residue) flip-flop
CR11	END	State of END flip-flop
CR12	JUMP	State of JUMP flip-flop
CR13	CTRL	State of CTRLR flip-flop
CR14	CHAN SR	Service request from device controller
CR15	CHAN SO	Service Out from channel
CR16	CHAN ACK	Channel Acknowledge from device controller
CR17	FREEZE	Clock is frozen by a selected condition

## SELECTOR CHANNEL CONTROL PCA SWITCHES

TRIGGER/FREEZE SELECTOR SWITCH S1. Switch S1 and standoff E2 (TRIG) provide the capability of triggering an oscilloscope each time a preselected condition occurs. Switch S1 can select one of eight orders or an error condition. For orders, the trigger occurs when the order begins to execute. A typical use of a selectable trigger might be to loop on an I/O program by means of a Jump Order while triggering on an order of interest.

NORMAL/FREEZE SWITCH S2. Switch S2 is used in conjunction with Switch S1 and the Error Logging Register during troubleshooting procedures. During normal system use, Switch S2 must be set to its normal position (opposite the FRZ position).



SELECTOR CHANNEL REGISTER PCA JUMPER AND SWITCH LOCATIONS  
 SELECTOR CHANNEL CONTROL PCA INDICATORS

LED	SIGNAL NAME	DESCRIPTION
CR1 thru CR5	IOCW4 thru IOCW0	Order code from Register PCA
CR6	ACTIVE	An order is currently executing
CR7	WCRO	Word count rollover
CR8	DEVEND	Device end from device controller
CR9	XERR	SELECTOR CHANNEL REGISTER PCA error occurred 30030-80021
CR10	RR	State of RR (return residue) flip-flop
CR11	END	State of END flip-flop
CR12	JUMP	State of JUMP flip-flop
CR13	CTRL	State of CTRLR flip-flop
CR14	CHAN SR	Service request from device controller
CR15	CHAN SO	Service out from channel
CR16	CHAN ACK	Channel Acknowledge from device controller
<b>CHANNEL NUMBER</b>	<b>MEMORY SIZE (WORDS)</b>	<b>Clock is frozen by a selected condition</b>
XW1 - CHANNEL 1	S3	S2 S1
XW3 - CHANNEL 3	1-128K	1-4 OPEN 1-4 CLOSED
XW4 - CHANNEL 4	2-256K	5-7 OPEN
(SELECTOR CHANNEL 2 NOT AVAILABLE)	3-384K	
	4-512K	
	5-640K	
	6-1024K	

SELECTOR CHANNEL CONTROL PCA SWITCHES

TRIGGER/FREEZE SELECTOR SWITCH S1. Switch S1 and standoff E2 (TRIG) provide the capability of triggering an oscilloscope each time a preselected condition occurs. Switch S1 can select one of eight orders or an error condition. For orders, the trigger occurs when the order begins to execute. A typical use of a selectable trigger might be to loop on an I/O program by means of a Jump Order while triggering on an order of interest.

NORMAL/FREEZE SWITCH S2. Switch S2 is used in conjunction with Switch S1 and the Error Logging Register during troubleshooting procedures. During normal system use, Switch S2 must be set to its normal position (opposite the FRZ position).

Reference: RTM

SELECTOR CHANNEL CONTROL PCA COMPONENT LOCATIONS

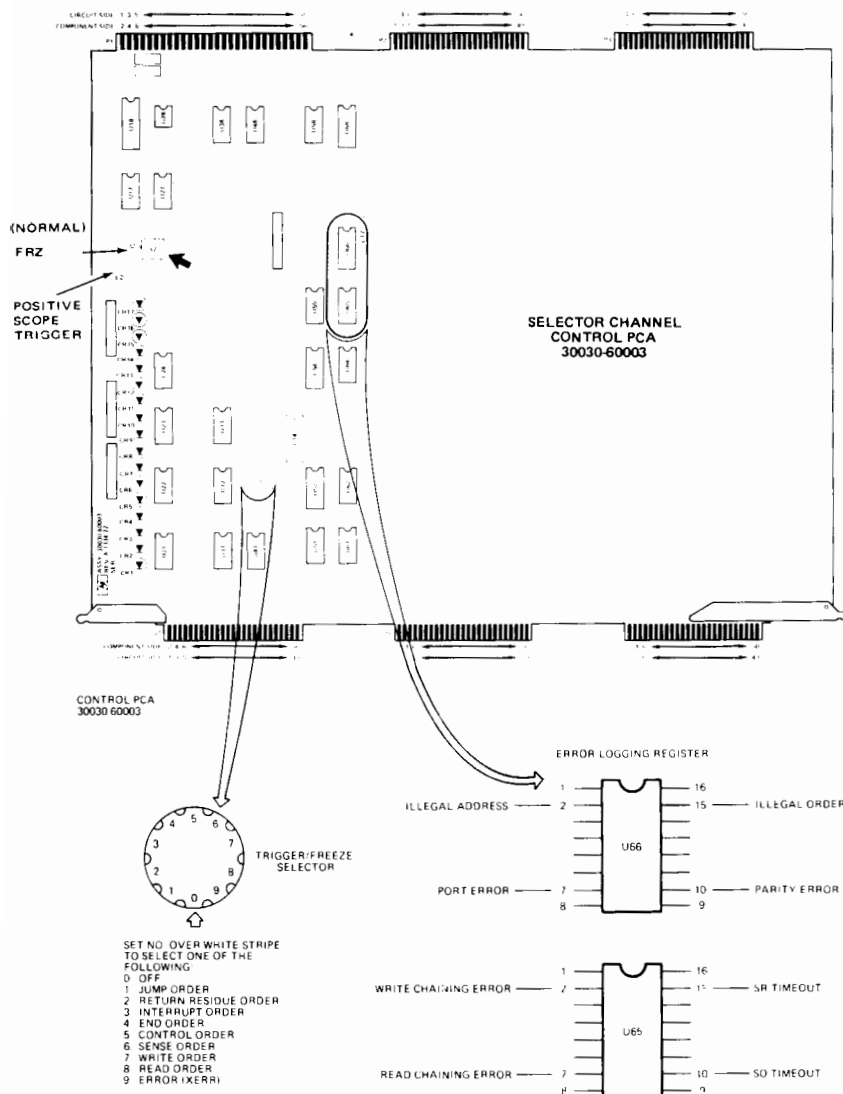

USING THE TRIGGER/FREEZE FEATURE

The trigger/freeze feature can only be used when the HP 30354A Maintenance Panel is connected to the system. To use this feature, proceed as follows.

- a. Set TRIGGER/FREEZE SELECTOR Switch S1 to the position corresponding to the desired condition.
- b. Set NORMAL/FREEZE Switch S2 to FRZ (freeze).
- c. Initiate program execution. The selector channel operation will freeze when the selected condition is decoded.
- d. Set the HP 30354A Maintenance Panel for single-cycle operation.
- e. Set NORMAL/FREEZE Switch S2 to its normal (opposite FRZ) position.
- f. Single-cycle the system through the execution sequence for the desired order while observing the Selector Channel Control PCA's various LED's.

SELECTOR CHANNEL CONTROL PCA ERROR LOGGING REGISTER

The Error Logging Register provides a means for determining the type of error that prematurely terminates the execution of an I/O program. When an error occurs, the error type sets a corresponding bit in the Error Logging Register. To observe the Error Logging Register contents, proceed as follows:

- a. Observe the Error Logging Register contents with a logic probe or clip.
- b. Set TRIGGER/FREEZE SELECTOR Switch S1 to position 9.
- c. Set NORMAL/FREEZE Switch S2 to FRZ (freeze). The Error Logging Register contents are cleared immediately after an error occurs during the clear sequence. Therefore, the register contents are valid when the error occurs causing the freeze.

SELECTOR CHANNEL CABLING CONFIGURATION

FRONT VIEW

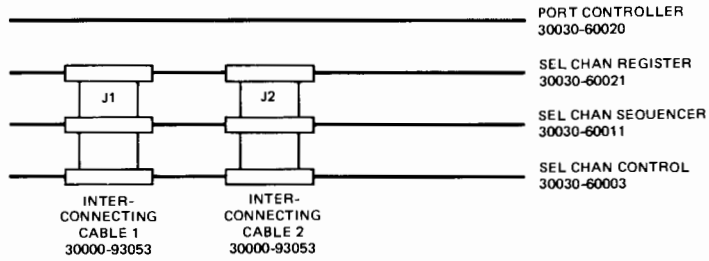

REAR VIEW

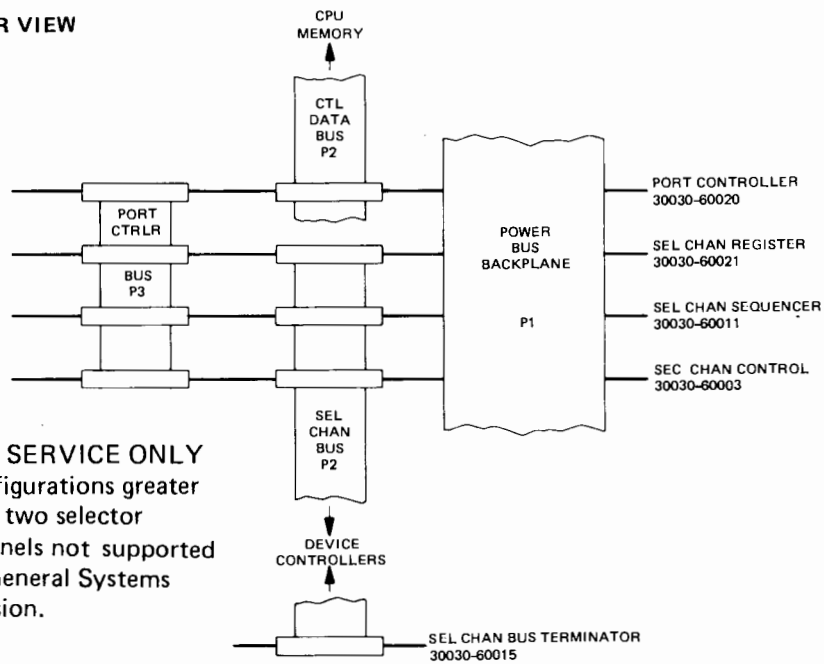

**FOR SERVICE ONLY**  
Configurations greater than two selector channels not supported by General Systems Division.



SELECTOR CHANNEL MAINTENANCE PCA (SCMB) DESCRIPTION

The SCMB is a maintenance aid for servicing the selector channel and multiplexer channel. Under software control (usually the selector channel diagnostic), the SCMB can exercise all selector channel data paths and control circuits. All I/O program orders can be executed and device dependent sequences such as conditional jump, device end, and clear interface can be exercised selectively. Also, device timeout conditions can be simulated causing a timeout error in the selector channel.

SCMB JUMPER DESCRIPTIONS

The XW1 jumpers select whether the SCMB is to be used with the selector channel or the multiplexer channel. If the plug-in socket (contains two jumper wires) is installed in XW1 so that it is aligned with the SC placarding, the SCMB is enabled for use with the selector channel. If the plug-in socket is installed so that it aligned with MX, the SCMB is enabled for use with the multiplexer channel.

NOTE

When XW1 is configured for multiplexer channel use (jumpers aligned with MX) and the SCMB is installed in the multiplexer channel, the selector channel diagnostic is used to verify the operation of the SCMB.

The MUX SR jumper selects a service request number when the SCMB is used with a multiplexer channel. This 16-position jumper should be installed to provide a service request number not used by any other device controller in the system. Service request number zero is reserved for the SCMB.

The XW2 jumpers select the SCMB device number. An installed jumper wire selects a "0" in that position. Use a device number not already assigned.

SCMB JUMPER LOCATIONS

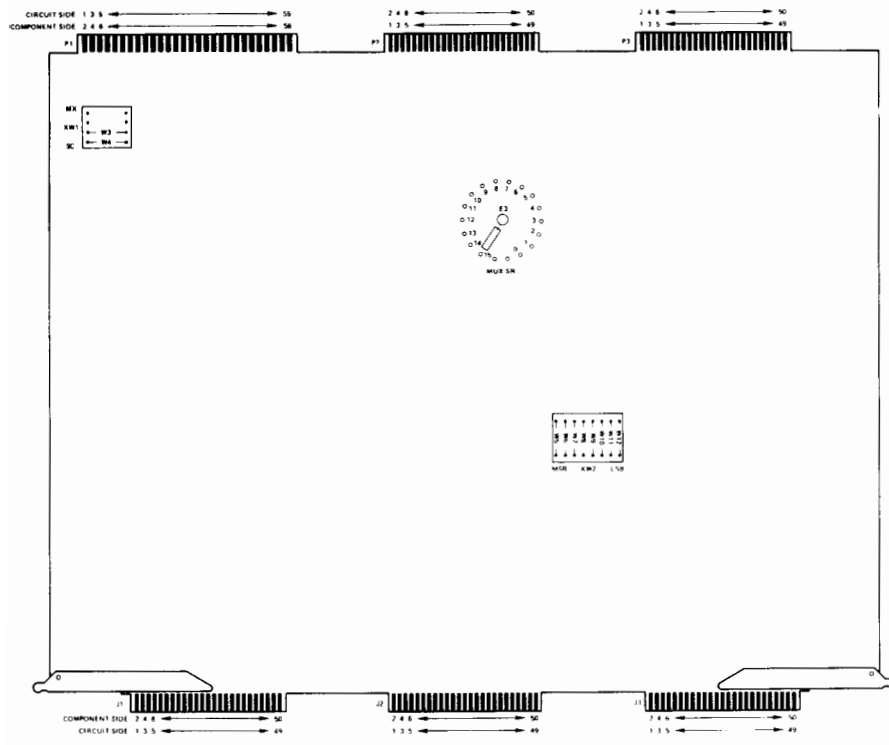

SCMB SELECTOR CHANNEL INSTALLATION

To install the SCMB in a selector channel, proceed as follows:

- a. Set the DC POWER LOGIC switch to DISABLE.
- b. Ensure that the SCMB XW1 jumpers are aligned with SC.
- c. Refer to the System Support Log and ensure that the selected SCMB device number is not used by any other device.
- d. Install the SCMB in an empty slot on the selector channel bus for the channel to be used.
- e. Install the interrupt poll for the SCMB.
- f. Set the DC POWER LOGIC switch to ENABLE.

SCMB MULTIPLEXER CHANNEL INSTALLATION

To install the SCMB in a multiplexer channel, proceed as follows:

- a. Set the DC POWER LOGIC switch to DISABLE.
- b. Ensure that the SCMB XW1 jumpers are aligned with MX.
- c. Refer to the System Support Log and ensure that the selected SCMB device number is not used by any other device.
- d. Install the SCMB in an empty slot on the multiplexer channel bus.
- e. Install the interrupt poll for the SCMB.
- f. If a second SCMB is to be installed, repeat steps a through e.
- g. Set the DC POWER LOGIC switch to ENABLE.

## SCMB VERIFICATION

To verify the SCMB, perform the following procedure.

OPERATOR ACTION/COMMENTS	CONSOLE MESSAGE
Install SCMB XW1 jumpers in the MX positions.	
Install SCMB in multiplexer channel and ensure that DRT number and interrupt poll are correctly wired.	
Cold load selector channel diagnostic (D429) from the stand-alone diagnostic tape. Press RETURN.	D100 HP30030B SELECTOR CHANNEL DIAG (D429X.YY.Z)
X=Version	Q104 SELECT OPTIONS
YY=Update Level	
Z=Fix Level	
Set SYSTEM SWITCH REGISTER bit 0 to off. Press RETURN.	Q110 SELECT SECTION OPTIONS
Press RETURN.	Q101 SET MAINT CARD DEV NUM?
Enter in decimal the DRT number of the SCMB. Press RETURN.	Q102 SET TIMER/CONSOLE DEV NUM?
Enter in decimal the number of the system timer (usually 3). Press RETURN.	Q108 ENTER UPPER BANK # (DECIMAL)=
Enter in decimal the number of the highest memory bank in the system. Press RETURN.	
Enter in octal the highest memory address available. Press RETURN.	Q105 ERR PRINT LIMIT?
Enter in decimal the maximum number of error messages to be received. Press RETURN.	D110 DIRECT I/O TEST D127 DIRECT I/O TEST COMPLETED D130 CONTROL ORDER TEST

DISPLAYING SCMB SIGNALS

The state of pertinent SCMB signals can be displayed on the maintenance panel by making the connections shown below with a flat cable and then setting the maintenance panel CLOCK switch to INHIBIT. It should be noted that although the system can be permitted to run in the free-run mode with this setup, that the display is valid only in the single-cycle mode.

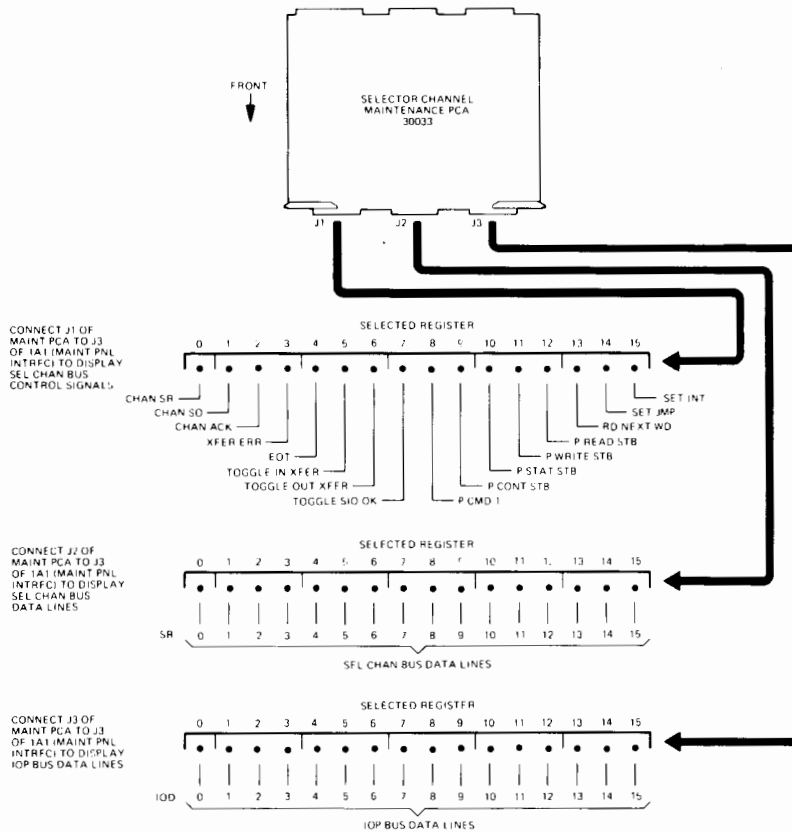

SCMB STATE DISPLAY

SCMB PROGRAMMING

Like any device controller, the SCMB is programmed through the use of direct I/O instructions from the CPU/IOP and through I/O program orders executed by the selector channel as shown in the block diagram below. SCMB operation is initially configured when a control word is issued by a direct control I/O instruction. To initiate execution of an I/O program (and therefore channel operation), an SIO instruction is issued to the SCMB. The SCMB also provides a 16-bit status word for various SCMB and selector channel operating conditions.

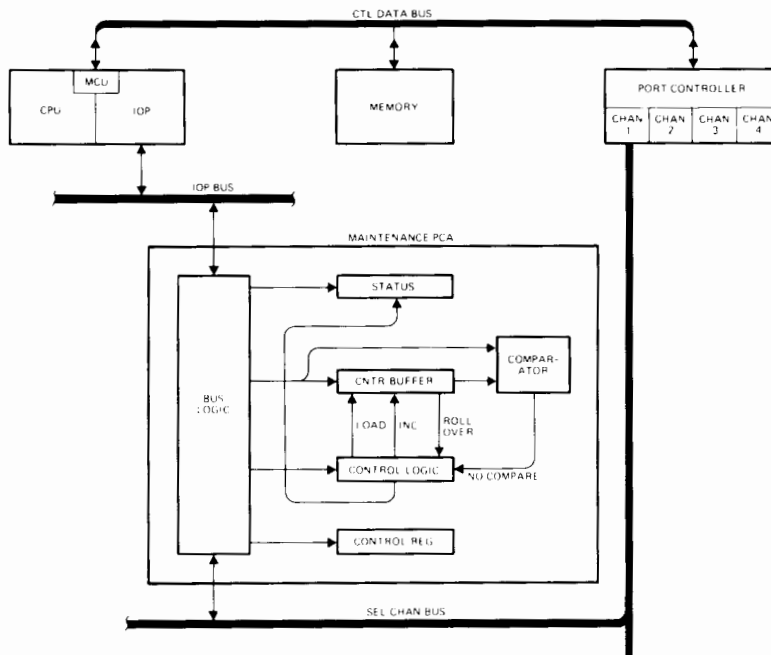

SCMB BLOCK DIAGRAM

## IOP/Channels

I/O INSTRUCTIONS. The following is list of applicable I/O instructions and their effect on the SCMB.

- SIN Instruction - Sets the SCMB Interrupt Request flip-flop.
- CIO Instruction - Loads a control word from TOS into the SCMB Control Register.
- SIO Instruction - Initiates I/O program execution if the channel is inactive. If the channel is active, the SIO instruction is rejected.
- WIO Instruction - Loads a data word from TOS into the SCMB Counter/Buffer.
- RIO Instruction - Sends contents of the Counter/Buffer to TOS.
- TIO Instruction - Returns the SCMB status word to TOS.
- SMSK Instruction - No effect. The SCMB has no Mask flip-flop.

I/O PROGRAM ORDERS. The following is a list of applicable I/O program orders and their effect on the SCMB.

- Control - Selects operational states/test modes of the SCMB.
- Write - If IOCW bit 11 is "0", loads a data word from memory into SCMB Counter/Buffer. If bit 11 is "1", compares data word from memory with Counter/Buffer contents.
- Read - Sends contents of the SCMB Counter/Buffer to memory.
- End - Returns the SCMB status word to the End order IOAW location and terminates I/O program execution. If bit 4 is "1", an interrupt occurs.
- Interrupt - Sets the SCMB Interrupt Request flip-flop.
- Sense - Returns the SCMB status word to the Sense order IOAW location in memory.
- Jump - If bit 4 of the order is "1" and bit 2 of the current IOCW is "1" or if bit 4 of the current control word is "0" (i.e., set jump met), this instruction causes an I/O program jump to occur.
- Return Residue - If bit 4 of the IOCW is "0", causes the residue of the count to be returned to the IOAW.
- Set Bank - If bit 4 of the IOCW is "1", loads the Bank Register for that device with IOAW bits 14 and 15.

CONTROL WORD. A control word can be issued to the SCMB through a direct control I/O instruction or through an I/O program control order. If a control order is used, the control word is located in the control order IOAW location (the control order IOCW is ignored by the SCMB). The control word is stored in the SCMB Control Register. The following is a list of control word bit functions and their effect on the SCMB.

Master Reset Bit 0. If "1", issues a reset signal to the SCMB which clears the Control Logic, Control Register, and Counter/Buffer. If the channel is active (i.e., SIO ENABLE =0), then a clear interface (i.e., REQ) is issued to the channel. This feature can be used to stop a runaway channel or another device controller's I/O program execution.

Reset Interrupt Bit 1. If "1", clears the SCMB Interrupt Request flip-flop.

Set Jump Met Bit 2. If "1", sets the SCMB Jump flip-flop. Then, if the selector channel executes a conditional jump order, the SCMB returns the Jump Met signal to the channel which causes an I/O program jump to occur.

Device End Bit 3. If "1", causes the SCMB to issue the Device End signal to the channel at the beginning of any data transfer. This results in no data transferred between the channel and the SCMB.

Inhibit Channel Acknowledge Bit 4. If "1", causes the SCMB to inhibit the Channel Acknowledge signal to the channel, following the current control order. This results in an SO Timeout error in the channel if the channel timers are enabled.

Inhibit Service Request Bit 5. If "1", causes the SCMB to inhibit the Channel Service Request signal to the channel. This results in an SR timeout error in the channel if a subsequent Read, Write, or Control order is executed.

Control Code Bits 6 and 7. These bits define how the two control words sent during channel execution of a Control order are used. The normal mode loads the IOAW into the Control Register to be used as a control word. The other modes load either or both the IOCW and IOAW into the Counter/Buffer leaving the Control Register contents unchanged.

High Speed Service Request Bit 8. If "1", overrides the SCMB service request delay (normally 200 kHz) to force continuous CHAN SR signals (when required) to the channel. The resulting transfer rate will be approximately 950 kHz outbound and 1140 kHz inbound.



SCMB CONTROL WORD FORMAT

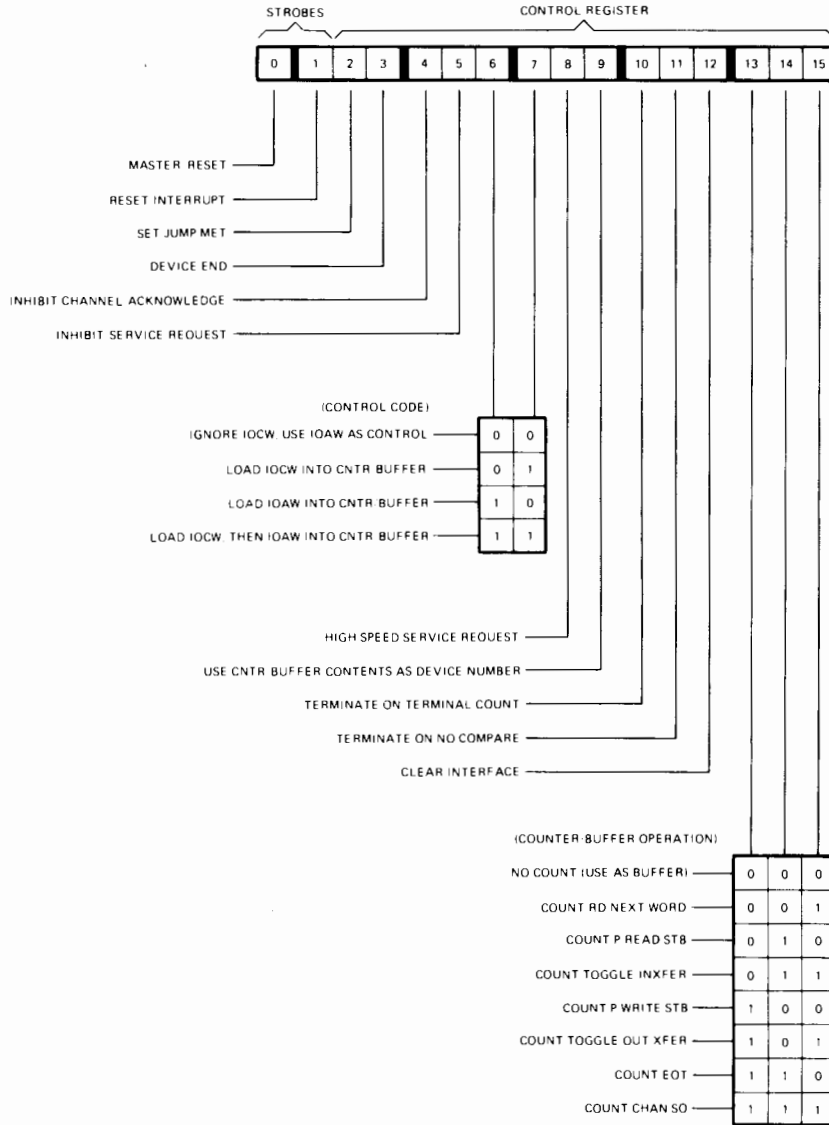

Device Number Bit 9. If "1", supplies the Counter/Buffer content as the device number at I/O program initiation instead of the hardwired device number. By preloading the Counter/Buffer using a direct WIO instruction, an I/O program can be executed to any device number.

Terminate On Terminal Count Bit 10. If "1", causes a Device End or clear interface (i.e., REQ) to be issued to the channel if the Counter/Buffer contents rollover (i.e., past count capacity). Whether Device End or clear interface is issued is determined by the state of bit 12.

Terminate On No Compare Bit 11. If "1", causes the contents of the Counter/Buffer to be compared with data words issued to the SCMB during channel execution of a Write order. (Normally, data received during execution of a Write order is loaded into the Counter/Buffer. When bit 11 is "1", the Counter/Buffer contents remain unchanged.) If a compare failure occurs, the SCMB issues either a Device End or clear interface (i.e., REQ) to the channel depending on the state of bit 12.

Clear Interface Bit 12. If "1", causes a clear interface (i.e., REQ) to be issued to the channel if either of the conditions controlled by bits 10 or 11 occur. If "0", causes a Device End to be issued if either condition occurs.

Counter/Buffer Operation Bits 13-15. These bits control the operation of the Counter/Buffer. When used as a buffer, the Counter/Buffer is loaded with data words received during channel execution of a Write order (unless bit 11 is "1"). The buffer contents are sent to the channel as data during channel execution of a Read order. Upon receipt of an I/O Reset signal, the Counter/Buffer and Control Word Storage Registers are cleared. Therefore, the initial operating state of the SCMB is as follows:

The Counter/Buffer contents equal zero.

If a Control order is executed, the Control order IOAW will be used as a Control word.

The SCMB wired device number will be sent if an SIO instruction is executed to the SCMB.

The Counter/Buffer will be used as a buffer.

## IOP/Channels

STATUS WORD. The status word results from various signals and flip-flops on the SCMB. The conditions reported by the status word are reset each time I/O program execution is initiated by an SIO instruction. Transfer related functions (e.g., no compare) are reset at the beginning of data transfers. The following is a list of the status word bits and their definitions.

SIO Ok Bit 0. If "1", the SCMB is not currently executing an I/O program and the channel is inactive.

RIO/WIO Ok Bit 1. This bit is always a "1".

Interrupt Pending Bit 2. If "1", the SCMB is attempting to interrupt the CPU.

Interrupt Active Bit 3. If "1", the SCMB interrupt circuits are currently in the active state.

Transfer Error Bit 4. If "1", the channel has sent the Transfer Error signal. Bit 4 is cleared by the next SIO instruction or I/O Reset.

SIO Enable Bit 5. If "1", the channel is asserting the SIO ENABLE signal (i.e., channel inactive).

Device End Bit 6. If "1", the SCMB has asserted the Device End signal to the channel. Bit 6 is cleared at the beginning of a new data transfer, the next SIO instruction, or an I/O Reset.

EOT Bit 7. If "1", the channel has asserted the End Of Transfer signal to the SCMB. Bit 7 is cleared at the beginning of a new data transfer, the next SIO instruction, or an I/O Reset.

IN XFER FF Bit 8. If "1", the most current data transfer operation was a Read order.

OUT XFER FF Bit 9. If "1", the most current data transfer operation was a Write order.

Terminal Count Bit 10. If "1", a condition counted by the Counter/Buffer caused a rollover (i.e., past count capacity). Bit 10 is cleared at the beginning of a new data transfer, the next SIO instruction, or an I/O Reset.

No Compare Bit 11. This bit is enabled if control word bit 11 is "1". If this bit is "1", a data word received from the channel during Write order execution did not match the word contained in the Counter/Buffer. Bit 11 is cleared at the beginning of a data transfer by the next SIO instruction to the SCMB or by an I/O Reset.

Clear Interface Bit 12. If "1", the SCMB has asserted the Clear Interface signal (i.e., REQ) to the channel. Bit 12 is cleared at the beginning of the next SIO instruction or by an I/O Reset.

SCMB STATUS WORD FORMAT

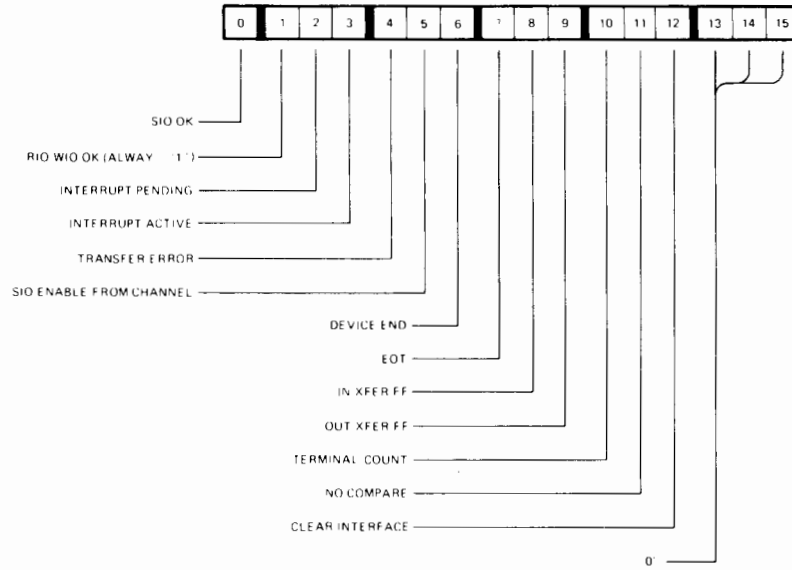

IOP/Channels

NOTES

# I/O SYSTEM CONFIGURATION

SECTION

V

## Table Of Contents

Topic	Page
Device Number Assignments .....	5-2
Multiplexer Channel Service Request Priority .....	5-3
Interrupt Polling Sequence .....	5-4
Typical Interrupt Poll Cabling .....	5-5
CPU Bay Clock Jumpers and Terminators .....	5-6
I/O Bay Clock Jumpers and Terminators .....	5-7
Power Bus Backplane Connections .....	5-8
Driver Names, Types, Sub-Types, and Record Widths .....	5-9
Asynchronous Terminal Controller Driver (IOTERMO) .....	5-13
Nine-Channel Magnetic Tape Unit Driver (IOTAPEO) .....	5-13
7905A/7920A/7925A Disc Driver (IOMDISC1) .....	5-14
Card Reader Driver (IOCDRDO) .....	5-15
Line Printer Driver (IOLPRTO) .....	5-15
Plotter Driver (IOPLOTO) .....	5-16
Printing Reader/Punch Driver (IOPRPNO) .....	5-16
Synchronous Single-Line Controller Driver (CSSBSCO, CSSBSCL, CSSMRJEO) .....	5-17
Hardwired Serial Interface Driver (CSHBSCO) .....	5-20
DS/3000 Communications Line Driver (IODSO) .....	5-20
DS/3000 Pseudo Terminal Driver (IODSTRMO) .....	5-21
MRJE/3000 Pseudo Devices (IOMRJE0, IOMRJE1, IOMCONSO, IOMPNLPO, IOMRDRO) .....	5-22
Multipoint Terminal (IOMPTRMO) .....	5-23
Multipoint Supervisor (IOMPSO) .....	5-23
Term Types .....	5-24
Typical I/O Configuration Listing .....	5-25
Using The :SYS DUMP Command .....	5-26

I/O System Configuration

DEVICE NUMBER ASSIGNMENTS

DRT Number		PCA Part No. or Product No.	Description	Logical Device Number
Dec	Oct			
3/2	3/2	30135-60063	System Clock/FLI	None
4	4	7920M or 7925M	System Disc	1
6	6	30215A	Mag Tape Controller	7-10
7	7	30032B	Asyn. Term Controller (With	20-35
8	10	30032B Opt.001	System Console as Unit 0)	
9	11	30032B Opt.002	103/202 Modem Capabilities	
10	12	30032B	Async. Term Controller	40-55
11	13	30032B Opt.001	103 Modem Cap.	
12	14	30032B Opt.002	202 Modem Cap.	
13	15	30106/107A	Card Reader	5
14	16	2608/13/17/18/19	Line Printer	6
15	17	2608/13/17/18/19	Line Printer	19
16	20	30360A	HSI	11
17	21	30360A	HSI	12
18	22	30055A	SSLC	13
19	23	30055A	SSLC	14
20	24	30104A	Paper Tape Reader	15
21	25	30105A	Paper Tape Punch	16
22	26	30119A	Card Reader/Punch	17
23	27	30126A	Cal Comp Plotter	18
24	30	-----	(Unassigned)	--
25	31	30010A	Intelligent Network Proc.	57
26	32	30010A	Intelligent Network Proc.	58
27	33		For use as needed for de-	
	Thru		vices which have no stand-	
			ard number, or additional	
			devices over the standard	
			allocation.	59
31	37			T
				h
				r
32	40		For peripherals connected	
	Thru		to 30341A HP-IB Interface	
			Module.	o
39	47			u
				g
				h
40	50		For use as needed for de-	
	Thru		vices which have no stand-	
			ard number, or additional	
			devices over the standard	
			allocation.	225
124	174			
125	175	30341A	HP-IB Interface Module	None
126	176	30036A	2nd Mux Channel	None
127	177	30036A	1st Mux Channel	None

Reference: SIM

I/O System Configuration

MULTIPLEXER CHANNEL SERVICE REQUEST PRIORITY

SR NO.	DEVICE	PRODUCT NUMBER	TRANSMISSION MODE
0	Reserved for Selector Channel Maintenance PCA	30033A	S,C
1	7920M/7925M Cartridge Disc	30129A	C
2			S
3	7970B/E Magnetic Tape Drive	30215A	S
4,5	Hardwired Serial Interface	30360A	S
6	Card Reader	30106A	S
7	Synchronous Single-Line Controller	30055A	S
8	Intelligent Network Prcssr.	30010A	S
9	CalComp Plotter	30126A	S
10	Paper Tape Punch	30105A	A
11			
12,13	Line Printer	A11	A
14	Paper Tape Reader	30104A	D
15	Reader/Punch	30119A	D

Transmission Mode

C = Selector Channel  
S = Synchronous I/O Mode  
A = Asynchronous I/O Mode  
D = Direct I/O Mode Only

Reference: SIM



## RECOMMENDED I/O SYSTEM INTERRUPT POLLING SEQUENCE

Product Number	Device Name
30032B (HIGHEST Priority)	Terminal Data Interface
30135-60063	System Clock/FLI
30104A	Paper Tape Reader
30055A	Sync. Single-Line Controller
30229B	7920M/7925M Disc Interface
30032B--001,--002	Terminal Control Interface
30360A	Hardwired Serial Controller
30341A	HP-IB Interface Module
30126A	Plotter
30300/1A	Programmable Controller
30215A	7970 Magnetic Tape
30010A	Intelligent Network Processor
-----	All Line Printers
30106/7A	Card Reader
30119A	Card Reader/Punch
30105A (LOWEST Priority)	Paper Tape Punch

Reference: SIM

TYPICAL INTERRUPT POLL CABLING

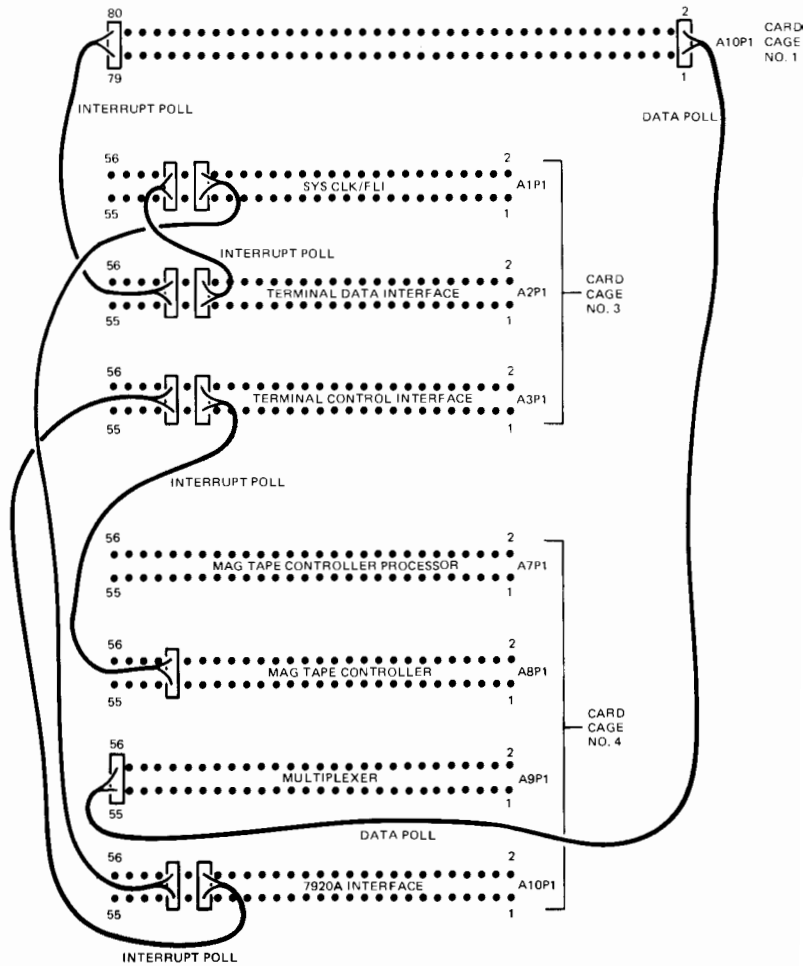

NOTES: WHITE OF INTERRUPT POLL AND DATA POLL  
TWISTED PAIRS IS UP (EVEN PIN) AT A10P1  
AND DOWN (ODD PIN) AT I/O INTERFACES.

Reference: EDS

I/O System Configuration

CPU BAY CLOCK JUMPERS AND TERMINATORS

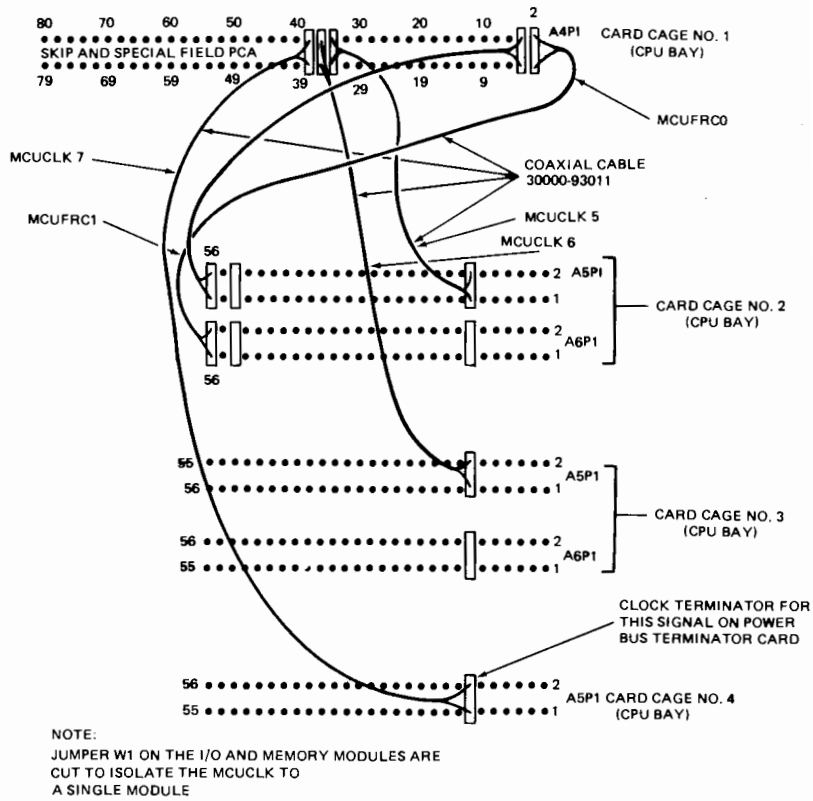

Reference: SIM

I/O System Configuration

I/O BAY CLOCK JUMPERS AND TERMINATORS

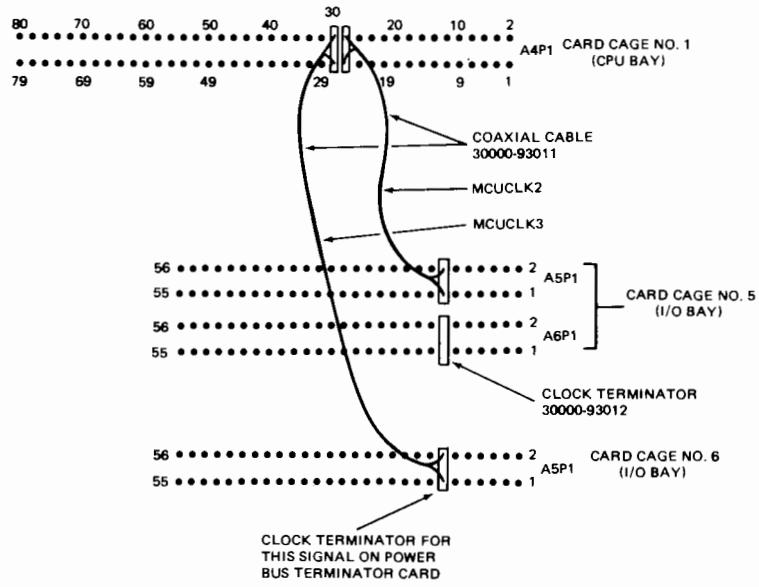

Reference: SIM

I/O System Configuration

POWER BUS BACKPLANE CONNECTIONS

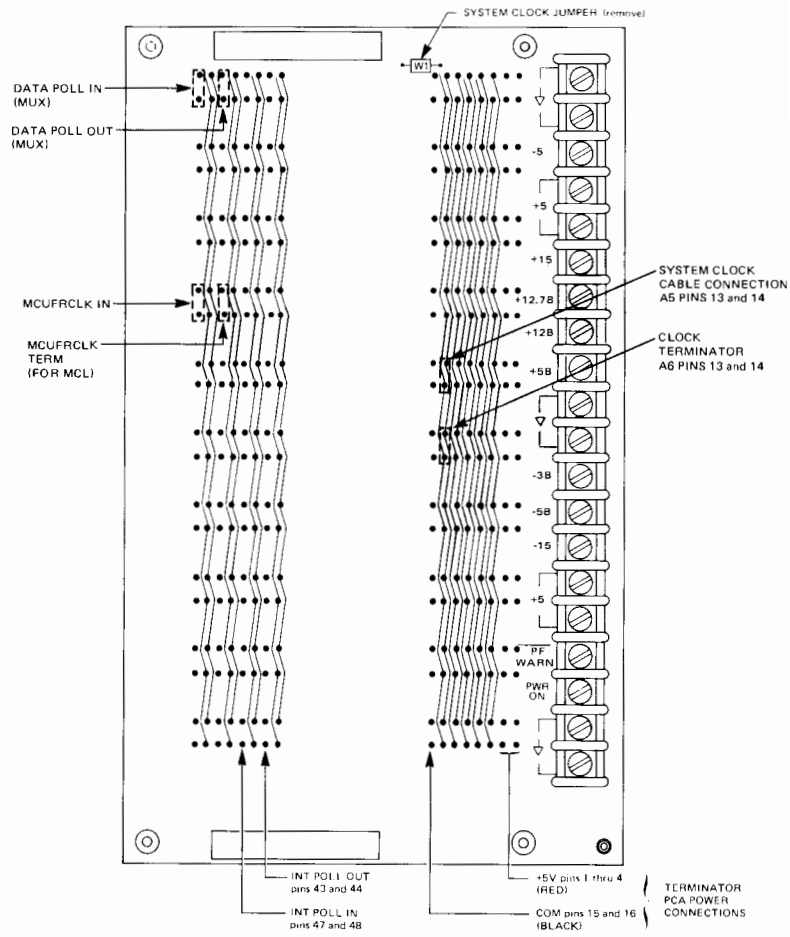

I/O System Configuration

DRIVER NAMES, TYPES, SUB-TYPES, AND RECORD WIDTHS

DEVICE	PART NO.	DRIVER NAME	TYPE	SUB-TYPE	RECORD WIDTH (Decimal Words)
Asynchronous Terminal Controller	30032B	IOTERMO	16		40
Hardwired Terminal speed sensing				0*	
Full duplex modem (103 or V.21), speed sensing				1	
Asynchronous half-duplex modem (202 or V.23), Data Rate Select ON, speed sensing				2	
Asynchronous half-duplex modem (202 or V.23), Data Rate Select OFF, speed sensing				3	
Hardwired Terminal speed specified				4	
Full duplex modem (103 or V.21), speed specified				5	
Asynchronous half-duplex modem (202 or V.23), Data Rate Select ON, speed specified				6	
Asynchronous half-duplex modem (202 or V.23), Data Rate Select OFF, speed specified				7	
* These terminals should be configured with SUB-TYPE = 1 when hardwired: ASR37, Memorex 1240.					

I/O System Configuration

DRIVER NAMES, TYPES, SUB-TYPES, AND RECORD WIDTHS (Continued)

DEVICE	PART NO.	DRIVER NAME	TYPE	SUB-TYPE	RECORD WIDTH (Decimal Words)
Nine-channel Magnetic Tape Unit (7970B/E)	30215A	IOTAPE0	24	0	128
Disc Drive (7905A) (7920A/7925A) 7920A (Cylinder Mode Only) 7925A (Cylinder Mode Only)	30229A	IOMDISC1	0	4-7	128
				8	
				9	
Card Reader (2893A) Katakana/Roman	30106A	IOCDRDO	8	0 1	40
Paper Tape Reader (2748B)	30104A	IOPTRDO	9	0	40
Paper Tape Punch (2895A)	30105A	IOPTPNO	34	0	128
Line Printer (2607/08/10/13/14/17/18/19) 2610/14 2607 2613/17/18/19 2617J-Katakana 2608	30108A	IOLPRT0	32		66
	30109A				
				0	
				1	
				2	
				3	
	4				
Plotter Series 500 Series 600 Series 700 0.010 in. 0.005 in. 0.0025 in. 0.00125 in. 0.002 in. 0.1 mm 0.05 mm 0.025 mm	30126A	IOPLOT0	35		128
			36		
			37		
				0	
				1	
				2	
				3	
				4	
				5	
				6	
	7				

## I/O System Configuration

## DRIVER NAMES, TYPES, SUB-TYPES, AND RECORD WIDTHS (Continued)

DEVICE	PART NO.	DRIVER NAME	TYPE	SUB-TYPE	RECORD WIDTH (Decimal Words)
Printing Reader/ Punch (2894A)	30119A	IOPRPNO	20	0	40
DS/3000					
Synchronous Single-Line Controller	30055A	CSSBSCO	18		N/A
Switched line with modem (dial up)				0	
Non-switched line with modem (private or leased)				1	
HSI	30360A	CSHBSCO	19	3	N/A
Comm Drivers		IODSO	41	0	128
Pseudo terminal		IODSTRMO	16	0	36
MRJE/3000					
Synchronous Single-Line Controller	30055A	CSSBSCO	18		N/A
Switched line with modem (dial up)				0	
Non-switched line with modem (private or leased)				1	
Pseudo Line Monitor No. 1		IOMRJE0	22	0	40
Pseudo Line Monitor No. 2		IOMRJE1	22	0	40
Pseudo Console		IOMCONSO	22	0	40
Pseudo Line Printer		IOMPNIPO	22	0	67
Pseudo Card Punch		IOMPNIPO	22	0	40
Pseudo Card Reader		IOMRIR0	22	0	40



I/O System Configuration

DRIVER NAMES, TYPES, SUB-TYPES, AND RECORD WIDTHS (Continued)

DEVICE	PART NO.	DRIVER NAME	TYPE	SUB-TYPE	RECORD WIDTH (Decimal Words)
2780/3780 Emulator					
Synchronous Single-Line Controller	30055A	CSSBSCO	18		N/A
Switched line with modem (dial up)				0	
Non-switched line with modem (private or leased)				1	
MTS/3000					
Synchronous Single-Line Controller	30055A	CSSBSCO CSSBSC1	18		N/A
Sync Switched Line w/modem (dial up)				0	
Sync Switched Line w/modem (private or leased)				1	
Sync Hardwired Line				3	
Async Hardwired Line				7	
Multipoint Supervisor		IOMPSO	16	0	N/A
Multipoint Terminal		IOMPTRMO	16	0	40

## ASYNCHRONOUS TERMINAL CONTROLLER DRIVER (IOTERM0)

CONFIGURATOR STEP NO.	CONFIGURATOR OUTPUT	USER RESPONSE
3.9	TYPE?	16
3.10	SUB TYPE?	See table on page 5-9.
3.11	TERM TYPE?	See table on page 5-24.
3.12	SPEED IN CHARACTERS PER SECOND	(Varies with terminal) 10/14/15/30/60/120/240
3.40	REC WIDTH?	(Varies with terminal)
3.41	OUTPUT DEVICE?	Idn or class name of listing device.
3.42	ACCEPT JOBS/SESSIONS?	YES
3.43	ACCEPT DATA?	YES
3.44	INTERACTIVE?	YES
3.45	DUPLICATIVE?	YES
3.46	INITIALLY SPOOLED?	NO
3.50	DRIVER NAME?	IOTERM0
10.1	ENTER PROGRAM NAME, REPLACEMENT FILE NAME?	IOTERM0, <prepared file name>

## NINE-CHANNEL MAGNETIC TAPE UNIT DRIVER (IOTAPE0)

CONFIGURATOR STEP NO.	CONFIGURATOR OUTPUT	USER RESPONSE
3.9	TYPE?	24
3.10	SUB TYPE?	0
3.40	REC WIDTH?	128
3.41	OUTPUT DEVICE?	0
3.42	ACCEPT JOBS/SESSIONS?	YES or NO
3.43	ACCEPT DATA?	NO
3.44	INTERACTIVE?	NO
3.45	DUPLICATIVE?	NO
3.46	INITIALLY SPOOLED?	YES or NO
3.47	INPUT OR OUTPUT?	IN (asked only if initially spooled)
3.50	DRIVER NAME?	IOTAPE0
10.1	ENTER PROGRAM NAME, REPLACEMENT FILE NAME?	IOTAPE0, <prepared file name>

Reference: SUP

I/O System Configuration

7905/7920A/7925A DISC DRIVER (IOMDISC1)

CONFIGURATOR STEP NO.	CONFIGURATOR OUTPUT	USER RESPONSE
3.9	TYPE?	0
3.10	SUB TYPE?	See table on page 5-9.
3.40	REC WIDTH?	128
3.41	OUTPUT DEVICE?	0
3.42	ACCEPT JOBS/SESSIONS?	NO
3.43	ACCEPT DATA?	NO
3.44	INTERACTIVE?	NO
3.45	DUPLICATIVE?	NO
3.46	INITIALLY SPOOLED?	NO
3.50	DRIVER NAME?	IOMDISC1
10.1	ENTER PROGRAM NAME, REPLACEMENT FILE NAME?	IOMDISC1, <prepared file name>

Reference: SUP

I/O System Configuration

CARD READER DRIVER (IOCDRDO)

CONFIGURATOR STEP NO.	CONFIGURATOR OUTPUT	USER RESPONSE
3.9	TYPE?	8
3.10	SUB TYPE?	0
3.40	REC WIDTH?	40
3.41	OUTPUT DEVICE?	Idn or class name of listing device.
3.42	ACCEPT JOBS/SESSIONS?	YES
3.43	ACCEPT DATA?	YES
3.44	INTERACTIVE?	NO
3.45	DUPLICATIVE?	NO
3.46	INITIALLY SPOOLED?	YES or NO
3.50	DRIVER NAME?	IOCDRDO
10.1	ENTER PROGRAM NAME, REPLACEMENT FILE NAME?	IOCDRDO, <prepared file name>

LINE PRINTER DRIVER (IOLPRT0)

CONFIGURATOR STEP NO.	CONFIGURATOR OUTPUT	USER RESPONSE
3.9	TYPE?	32
3.10	SUB TYPE?	See table on page 5-9.
3.40	REC WIDTH?	66
3.41	OUTPUT DEVICE?	0
3.42	ACCEPT JOBS/SESSIONS?	NO
3.43	ACCEPT DATA?	NO
3.44	INTERACTIVE?	NO
3.45	DUPLICATIVE?	NO
3.46	INITIALLY SPOOLED?	YES or NO
3.50	DRIVER NAME?	IOLPRT0
10.1	ENTER PROGRAM NAME, REPLACEMENT FILE NAME?	IOLPRT0, <prepared file name>

Reference: SUP

I/O System Configuration

PLOTTER DRIVER (IOPLOT0)

CONFIGURATOR STEP NO.	CONFIGURATION OUTPUT	USER RESPONSE
3.9	TYPE?	35
3.10	SUB TYPE?	See table on page 5-9.
3.40	REC WIDTH?	128
3.41	OUTPUT DEVICE?	0
3.42	ACCEPT JOBS/SESSIONS?	NO
3.43	ACCEPT DATA?	NO
3.44	INTERACTIVE?	NO
3.45	DUPLICATIVE?	NO
3.46	INITIALLY SPOOLED?	YES or NO
3.50	DRIVER NAME?	IOPLOT0
10.1	ENTER PROGRAM NAME, REPLACEMENT FILE NAME?	IOPLOT0, <prepared file name>

PRINTING READER/PUNCH DRIVER (IOPRPNO)

CONFIGURATOR STEP NO.	CONFIGURATOR OUTPUT	USER RESPONSE
3.9	TYPE?	20
3.10	SUB TYPE?	0
3.40	REC WIDTH?	40
3.41	OUTPUT DEVICE?	Idn or class name of listing device.
3.42	ACCEPT JOBS/SESSIONS?	YES
3.43	ACCEPT DATA?	YES
3.44	INTERACTIVE?	NO
3.45	DUPLICATIVE?	NO
3.46	INITIALLY SPOOLED?	YES or NO
3.47	INPUT OR OUTPUT?	IN or OUT
3.50	DRIVER NAME?	IOPRPNO
10.1	ENTER PROGRAM NAME, REPLACEMENT FILE NAME?	IOPRPNO, <prepared file name>

Reference: SUP

SYNCHRONOUS SINGLE-LINE CONTROLLER DRIVER  
(CSSBSCO, CSSBSC1, CSSMRJEO)

CONFIGURATOR STEP NO.	CONFIGURATOR OUTPUT	USER RESPONSE
3.7	UNIT#?	0
3.8	CHANNEL #?	0
3.9	TYPE?	18
3.10	SUB TYPE?	See table on page 5-9.
3.14	PROTOCOL?	1 (DS/3000, 2780/3780, MTS/3000) 1-255 (MRJE/3000) Use any value not used.
3.15	LOCAL MODE?	1 or 2 (DS/3000, 2780/3780) 1-15 MRJE/3000. Only use values not used.
3.16	TRANSMISSION CODE?	1, 2, or 3 (DS/3000, 2780/3780) 1-63 (MRJE/3000, MTS/ 3000) Only use values not used.
3.17	RECEIVE TIMEOUT?	Carriage Return (MRJE/ 3000, MTS/3000) 20sec is default value. 0-32000 (DS/3000, 2780/3780)
3.18	LOCAL TIMEOUT?	Carriage Return (MRJE/ 3000, MTS/3000) 60sec is default value. 0-32000 (DS/3000, 2780/3780)
3.19	CONNECT TIMEOUT?	Carriage Return (MRJE/ 3000) Always override with 0 to disable this timeout. 0-32000 (DS/3000, MTS/ 3000, 2780/3780)
3.20*	DIAL FACILITY?	YES or NO (DS/3000, 2780/3780, MTS/3000) Carriage Return (MRJE/3000)
3.21*	ANSWER FACILITY?	YES or NO (DS/3000, 2780/3780, MTS/3000) Carriage Return (MRJE/3000)

\* This question is asked only if SUB-TYPE is 0.

I/O System Configuration

SYNCHRONOUS SINGLE-LINE CONTROLLER DRIVER (Continued)

CONFIGURATOR STEP NO.	CONFIGURATOR OUTPUT	USER RESPONSE
3.22*	AUTOMATIC ANSWER?	YES or NO (DS/3000, 2780/3780, MTS/3000) Carriage Return (MRJE/3000)
3.23	DUAL SPEED?	YES (European) NO (All others)
3.24**	HALF SPEED?	YES or NO
3.25***	SPEED CHANGEABLE?	NO (2780/3780) YES (DS/3000,MRJE/3000, MTS/3000)
3.26	TRANSMISSION SPEED?	250, 300, 600, or 1200
3.27	TRANSMISSION MODE?	0 (Full duplex) 1 (Half duplex)
3.28	PREFERRED BUFFER SIZE?	0-4096 (1024 or 4096 is recommended for DS/3000) M>0 (MRJE/3000,MTS/3000 2780/3780-any value, response not used.
3.29	DRIVER CHANGEABLE?	NO (DS/3000, 2780/3780) YES (MTS/3000,MRJE/3000)
3.30	DRIVER OPTIONS?	0
3.50	DRIVER NAME?	CSSBSCO (All subsys.)
3.51*	CONTROL LENGTH?	0
3.52*	PHONELIST?	YES or NO (DS/3000, 2780/3780, MTS/3000) NO (MRJE/3000)
3.53	PHONE NUMBER?	number- A telephone number of not more than 20 characters.
3.54*	LOCAL ID SEQUENCE?	Carriage Return or ID. (DS/3000) Carriage Return (MRJE/ 3000, 2780/3780, MTS/3000)
3.55*	REMOTE ID SEQUENCE?	Carriage Return or ID. (DS/3000) Carriage Return (MRJE/ 3000, 2780/3780, MTS/3000)

\* This question is asked only if SUB-TYPE is 0.  
 \*\* This question is asked only if modem is dual speed.  
 \*\*\* This question is asked only if modem is single speed.

I/O System Configuration

SYNCHRONOUS SINGLE-LINE CONTROLLER DRIVER (Continued)

CONFIGURATOR STEP NO.	CONFIGURATOR OUTPUT	USER RESPONSE
3.70	DEVICE CLASSES?	Class name or return (DS/3000, MTS/3000, MRJE/3000)
3.94	ADDITIONAL DRIVER CHANGES?	RJLINE (2780/3780) NO (DS/3000, 2780/3780)
3.98	ADD DRIVERS?	YES (MTS/3000,MRJE/3000)
3.99	DRIVER NAME?	YES (MTS/3000,MRJE/3000) CSSMRJE0 (MRJE/3000) CSSBSC1 (MTS/3000)

Reference: SUP



## I/O System Configuration

## HARDWIRED SERIAL INTERFACE DRIVER (CSHBSCO)

CONFIGURATOR STEP NO.	CONFIGURATOR OUTPUT	USER RESPONSE
3.7	UNIT #?	0
3.8	CHANNEL #?	0
3.9	TYPE?	19
3.10	SUB TYPE?	3
3.13	PORTMASK?	8 (chan0), 4 (chan1), 2 (chan2), 1 (chan3)
3.14	PROTOCOL?	1
3.15	LOCAL MODE?	1
3.16	TRANSMISSION CODE?	2
3.17	RECEIVE TIMEOUT?	Carriage Return or 0-32000
3.18	LOCAL TIMEOUT?	Carriage Return or 0-32000
3.19	CONNECT TIMEOUT?	Carriage Return or 0-32000
3.25	SPEED CHANGEABLE?	YES
3.26	TRANSMISSION SPEED?	250000 or 125000
3.27	TRANSMISSION MODE?	0
3.28	PREFERRED BUFFER SIZE?	0-4096 (1024 or 4096 recommended)
3.29	DRIVER CHANGEABLE?	NO
3.30	DRIVER OPTIONS?	0
3.50	DRIVER NAME?	CSHBSCO

## DS/3000 COMMUNICATIONS LINE DRIVER (IODSO)

CONFIGURATOR STEP NO.	CONFIGURATOR OUTPUT	USER RESPONSE
3.7	UNIT #?	0
3.8	CHANNEL #?	0
3.9	TYPE?	40
3.10	SUB TYPE?	0
3.40	REC WIDTH?	128
3.41	OUTPUT DEVICE?	0
3.42	ACCEPT JOBS/SESSIONS?	NO
3.43	ACCEPT DATA?	NO
3.44	INTERACTIVE?	NO
3.45	DUPLICATIVE?	NO
3.46	INITIALLY SPOOLED?	NO
3.50	DRIVER NAME?	IODSO

## DS/3000 PSEUDO TERMINAL DRIVER (IODSTRM0)

CONFIGURATOR STEP NO.	CONFIGURATOR OUTPUT	USER RESPONSE
3.7	UNIT #?	a unique number
3.8	CHANNEL #?	0
3.9	TYPE?	16
3.10	SUB TYPE?	0
3.11	TERM TYPE?	Carriage Return
3.12	SPEED IN CHARACTERS PER SECOND?	Carriage Return
3.40	REC WIDTH?	36
3.41	OUTPUT DEVICE?	(Idn or class name of listing device)
3.42	ACCEPT JOBS/SESSIONS?	YES
3.43	ACCEPT DATA?	NO
3.44	INTERACTIVE?	YES
3.45	DUPLICATIVE?	YES
3.46	INITIALLY SPOOLED?	NO
3.50	DRIVER NAME?	IODSTRM0

Reference: SUP

## I/O System Configuration

MRJE/3000 PSEUDO DEVICES  
(IOMRJE0, IOMRJE1, IOMCONSO, IOMPNLPO, IOMRDR0)

CONFIGURATOR STEP NO.	CONFIGURATOR OUTPUT	USER RESPONSE
3.7	UNIT #?	0 (line monitor No. 1) 1 (line monitor No. 2) 2 (console) 3-9 (line printers) 10-16 (card punches) 17-23 (card readers)
3.8	CHANNEL #?	0
3.9	TYPE?	22
3.10	SUBTYPE?	0
3.40	RECORD WIDTH?	40 (line monitors, card readers and punches) 67 (line printers and console)
3.41	OUTPUT DEVICE?	0
3.42	ACCEPT JOBS/SESSIONS?	NO
3.43	ACCEPT DATA?	NO
3.44	INTERACTIVE?	NO
3.45	DUPLICATIVE?	NO
3.46	INITIALLY SPOOLED?	YES (one pseudo card reader only) NO (all other pseudos)
3.47	INPUT OR OUTPUT?	OUTPUT (one pseudo card reader only)
3.50	DRIVER NAME?	IOMRJE0(line monitor 1) IOMRJE1(line monitor 2) IOMCONSO (console) IOMPNLPO(line printers and punches) IOMRDR0 (card readers)
3.70	DRIVER CLASSES?	class name or RETURN (spooled card reader) RETURN (all other pseudo devices)

## I/O System Configuration

## MULTIPOINT TERMINAL (IOMPTRMO)

CONFIGURATOR STEP NO.	CONFIGURATOR OUTPUT	USER RESPONSE
3.7	UNIT #?	Unique group/device ID
3.8	CHANNEL #?	0
3.9	TYPE?	16
3.10	SUBTYPE?	0
3.11	TERM TYPE?	14
3.12	SPEED IN CHARACTERS PER SECOND?	0
3.40	RECORD WIDTH?	40
3.41	OUTPUT DEVICE?	(Idn or class name)
3.42	ACCEPT JOBS/SESSIONS?	YES
3.43	ACCEPT DATA?	YES
3.44	INTERACTIVE?	YES
3.45	DUPLICATIVE?	YES
3.46	INITIALLY SPOOLED?	NO
3.50	DRIVER NAME?	IOMPTRMO

## MULTIPOINT SUPERVISOR (IOMPSO)

CONFIGURATOR STEP NO.	CONFIGURATOR OUTPUT	USER RESPONSE
3.7	UNIT #?	0
3.8	CHANNEL #?	0
3.9	TYPE?	16
3.10	SUBTYPE?	0
3.11	TERM TYPE?	14
3.12	SPEED IN CHARACTERS PER SECOND?	0
3.40	RECORD WIDTH?	nn (nn has no meaning)
3.41	OUTPUT DEVICE?	0
3.42	ACCEPT JOBS/SESSIONS?	NO
3.43	ACCEPT DATA?	NO
3.44	INTERACTIVE?	NO
3.45	DUPLICATIVE?	NO
3.46	INITIALLY SPOOLED?	NO
3.50	DRIVER NAME?	IOMPSO
3.70	DEVICE CLASSES?	class name or RETURN

I/O System Configuration

TERM TYPES

TERM TYPE? This question is asked only if TYPE is 16. To specify a default terminal type to be used at log-on, enter a number as follows:

TERMINAL TYPE	DESCRIPTION
0	HP 2749B (ASR-33 EIA-compatible) Terminal (10 cps).
1	ASR-37 Teleprinter Terminal with Paper Tape Reader/Punch (10 cps).
2	ASR-35 EIA-compatible Terminal (10 cps).
3	Execuport 300 Data Communications Transceiver Terminal (10/15/30 cps).
4	HP 2600A or Datapoint 3300 Keyboard-Display Terminal (10/15/30/60/120/240 cps).
5	Memorex 1240 Communication Terminal (10/15/30/60 cps). Terminal must use even parity-check option.
6	HP 2762A/B (General Electric Terminet 300 or 1200), or Data Communications Terminal, Model B (10/15/30/120 cps) with Paper Tape Reader/Punch, Option 2. Terminal must be equipped for "ECHO PLEX".
7 & 8	Reserved
9	HP 2615A Terminal (Beehive MiniBee) (10/15/30/60/120/240 cps).
10	HP 2621A/P, HP 2640A/B, HP 2641A, HP 2644A, HP 2645A, or HP 2648A. Character Mode or full program control of block mode transmission. (10-240 cps.)
11	HP 2621/40/41/44/45. Allows user to use block mode without program control of block mode transmission. Requires to position cursor before pressing ENTER. Recommended for speeds exceeding 30 cps when you expect to switch between character mode and block/line mode. May not be used in block/page mode. (10-240 cps.)
12	HP 2645K Katakana/Roman Data Terminal (8-bit)

TERM TYPES (Continued)

TERMINAL TYPE	DESCRIPTION
13	TELENET message switching network.
14	Multipoint Terminal and Multipoint Supervisor.
15	HP 2635A Printer Terminal (8-bit environment)
16	HP 2635A Printer Terminal (7-bit with parity)

TYPICAL I/O CONFIGURATION LISTING

LOG DEV #	DRT #	U N I T	C H A P T E R	SUB TYPE	TERM TYPE	TERM SPEED	REC WIDTH	OUTPUT DEV	MODE	DRIVER NAME	DEVICE CLASSES	
1	4	0	0	0	6		128	0		*IOMDISC1	DISC	
2	4	1	0	0	8		128	0		*IOMDISC1	SPool DISC	
6	14	0	0	32	2		66	0	S	IOLPRT0	LP	
7	6	0	0	24	0		128	LP		IOTAPE0	TAPE	
8	6	1	0	24	0		128	LP		IOTAPE0	TAPE	
9	6	2	0	24	0		128	LP		IOTAPE0	TAPE	
10	6	3	0	24	0		128	LP	JA	IOTAPE0	JOBTAPE	
20	7	0	0	16	0	10	40	40	20	JAID	IOTERMO	CONSOLE
21	7	1	0	16	0	11	40	40	21	JAID	IOTERMO	TERM
22	7	2	0	16	0	11	40	40	22	JAID	IOTERMO	TERM
23	7	3	0	16	0	11	40	40	23	JAID	IOTERMO	TERM
24	7	4	0	16	0	11	40	40	24	JAID	IOTERMO	TERM
25	7	5	0	16	0	11	40	40	25	JAID	IOTERMO	TERM
26	7	6	0	16	0	11	40	40	26	JAID	IOTERMO	TERM
27	7	7	0	16	0	11	40	40	27	JAID	IOTERMO	TERM
28	7	8	0	16	0	11	40	40	28	JAID	IOTERMO	TERM
29	7	9	0	16	0	11	40	40	29	JAID	IOTERMO	TERM
30	7	10	0	16	0	11	40	40	30	JAID	IOTERMO	TERM
31	7	11	0	16	0	11	40	40	31	JAID	IOTERMO	TERM
32	7	12	0	16	0	11	40	40	32	JAID	IOTERMO	TERM
33	7	13	0	16	0	11	40	40	33	JAID	IOTERMO	TERM
34	7	14	0	16	0	11	40	40	34	JAID	IOTERMO	TERM
35	7	15	0	16	0	11	40	40	35	JAID	IOTERMO	TERM

## I/O System Configuration

### USING THE :SYSDUMP COMMAND

The :SYSDUMP command can be entered at any time during a session. Prior to entering the command, a file reference to a serial storage device must be made. (If a disc drive is used, it must be an HP 7920 or HP 7925.) A file reference to a list device can also be made (optional).

#### NOTE

:SYSDUMP requires System Supervisor (OP) capabilities.

To begin dialog with the Configurator, enter:

```
:FILE DUMP;DEV=TAPE  
:SYSDUMP*DUMP
```

You will be asked if you want to make any configuration changes. If your reply is NO, the Configurator copies the running system to the specified device (mag tape in the above example). If your reply is YES, the Configurator continues its interactive dialog with you.

If \$NULL is specified as the output file, SYSDUMP will not write to any device. This may be useful in displaying the current system configuration.

I/O System Configuration

NOTES



I/O System Configuration

NOTES

# POWER DISTRIBUTION

SECTION

VI

## Table Of Contents

Topic	Page
CPU Bay Component Locations .....	6-2
I/O Bay (Option 200) Component Locations .....	6-3
CPU Bay Wiring Diagram .....	6-5
Ac Power Distribution .....	6-7
Dc Power Connections .....	6-9
Cable Harness 30235-60007 (Option 200) Wiring Diagram .....	6-11
Dc Power Supply Specifications .....	6-12
Power Supply Control and Display Assembly .....	6-13
DC STATUS/DC POWER Indicators and Switches .....	6-14
Battery, PON, and PFW Circuits .....	6-15
Battery Care .....	6-16

### NOTE

The contents of this section pertains specifically to the HP 3000 Series III product no. HP 32435A. Power distribution information for the HP 3000 Series III product no. HP 32421A is contained in the HP 3000 Series II CE Handbook, part no. 30000-90099.



Power Distribution

CPU BAY COMPONENT LOCATIONS

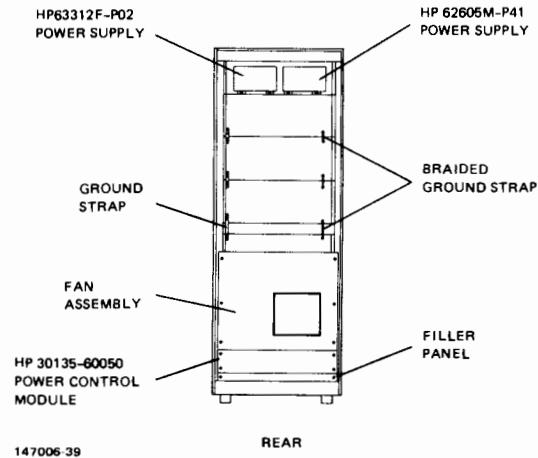
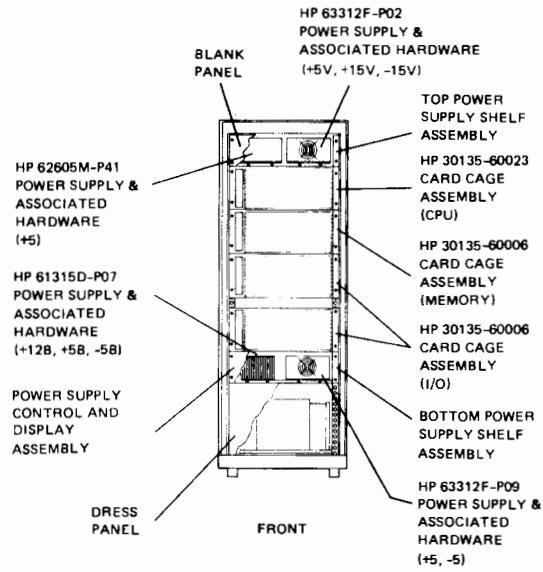

147006 39

I/O BAY (OPTION 200) COMPONENT LOCATIONS

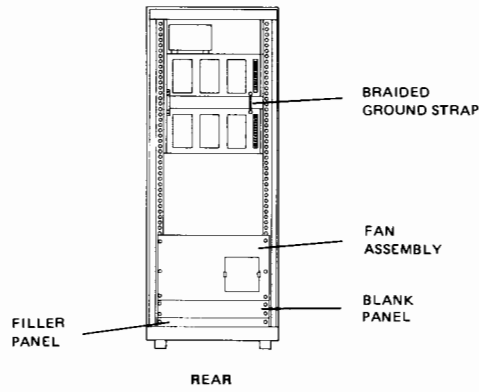
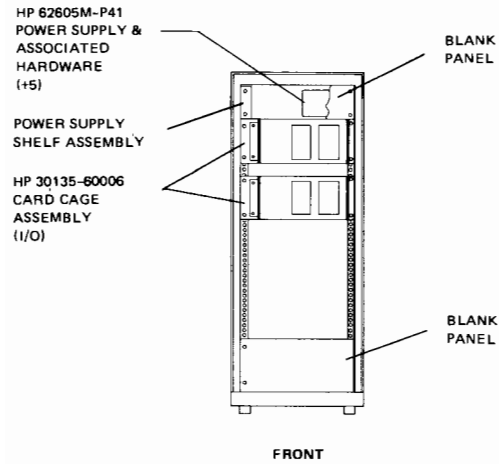



CPU BAY WIRING DIAGRAM

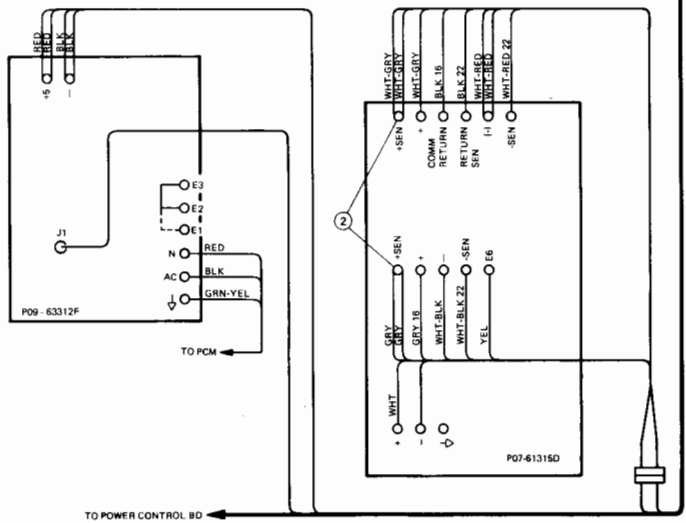
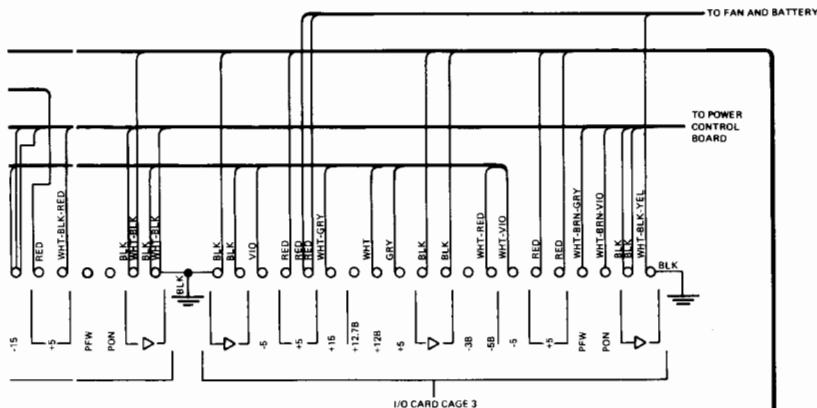

Reference: EDS



AC POWER DISTRIBUTION

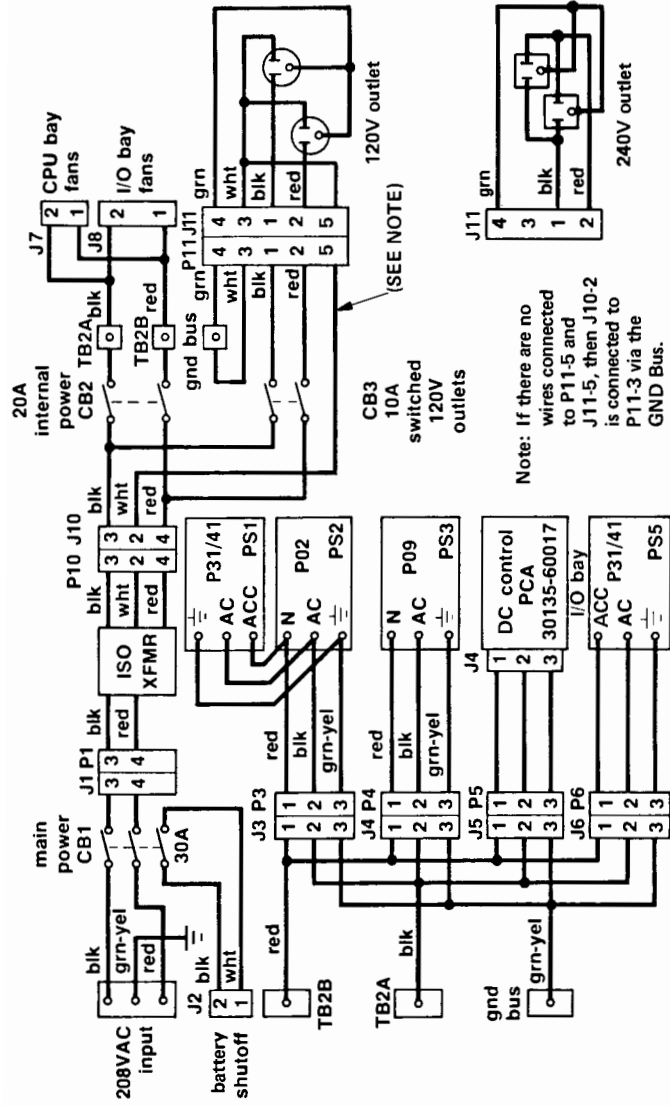

Note: If there are no wires connected to P11-5 and J11-5, then J10-2 is connected to P11-3 via the GND Bus.





Power Distribution

DC POWER CONNECTIONS

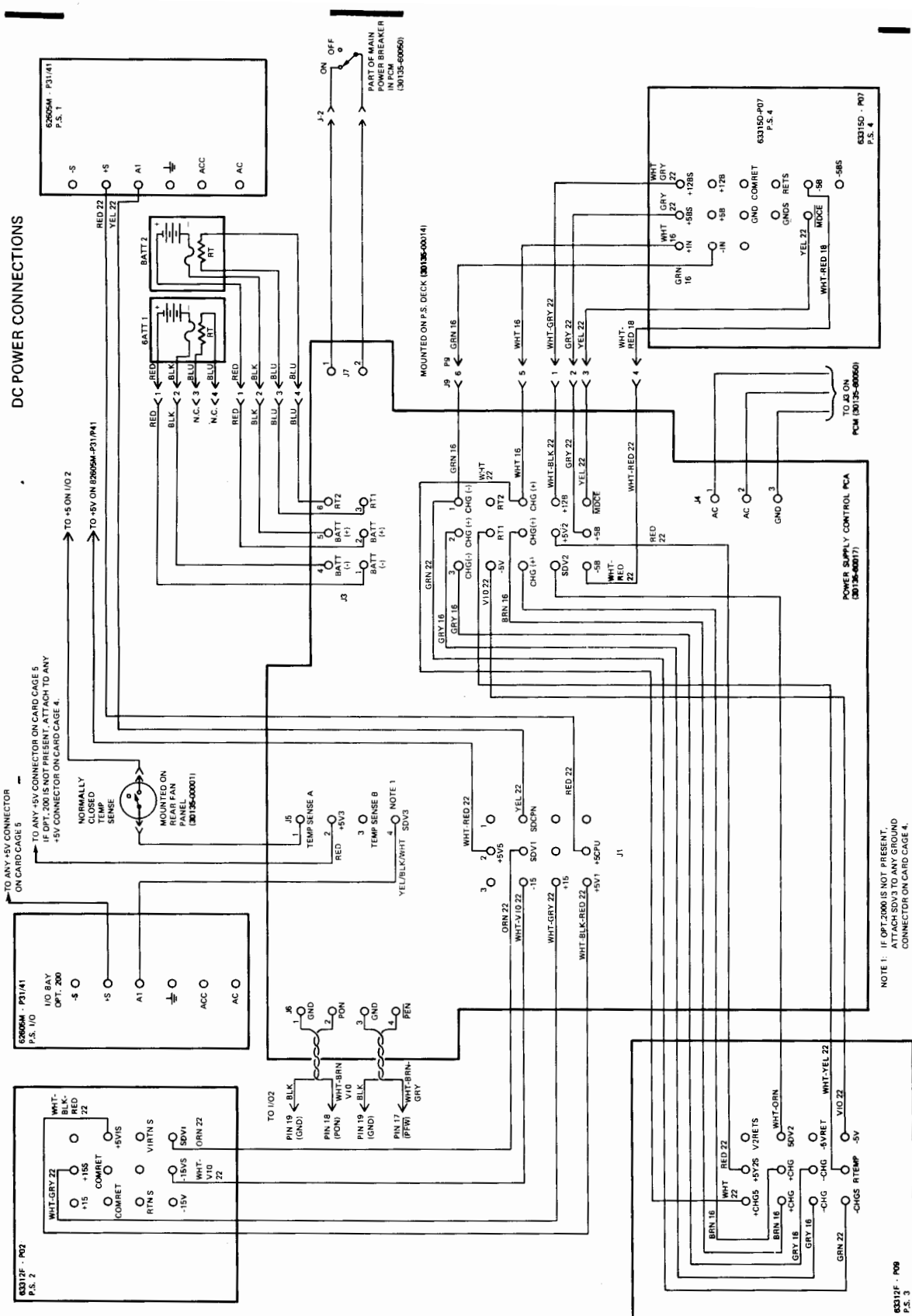

TO ANY +5V CONNECTOR ON CARD CAGE 5  
IF OPT. 200 IS NOT PRESENT, ATTACH TO ANY  
+5V CONNECTOR ON CARD CAGE 4.

NORMALLY  
CLOSED  
TEMP  
SENSE

TO +5V ON I/O 2  
TO +5V ON 62605M-P31/41

TO ANY +5V CONNECTOR ON CARD CAGE 5  
IF OPT. 200 IS NOT PRESENT, ATTACH TO ANY  
+5V CONNECTOR ON CARD CAGE 4.

TO I/O 2

NOTE 1: IF OPT. 2000 IS NOT PRESENT,  
ATTACH SDV3 TO ANY GROUND  
CONNECTOR ON CARD CAGE 4.

63317F - P08  
P.S. 3

Reference: EDS

JUL 1981

6-9/6-10

047001-28

Power Distribution

CABLE HARNESS 30235-60007 (OPTION 200) WIRING DIAGRAM

NOTE: This figure does not show the existing wires on the power bus, only the 30235-60007 cable harness connections.

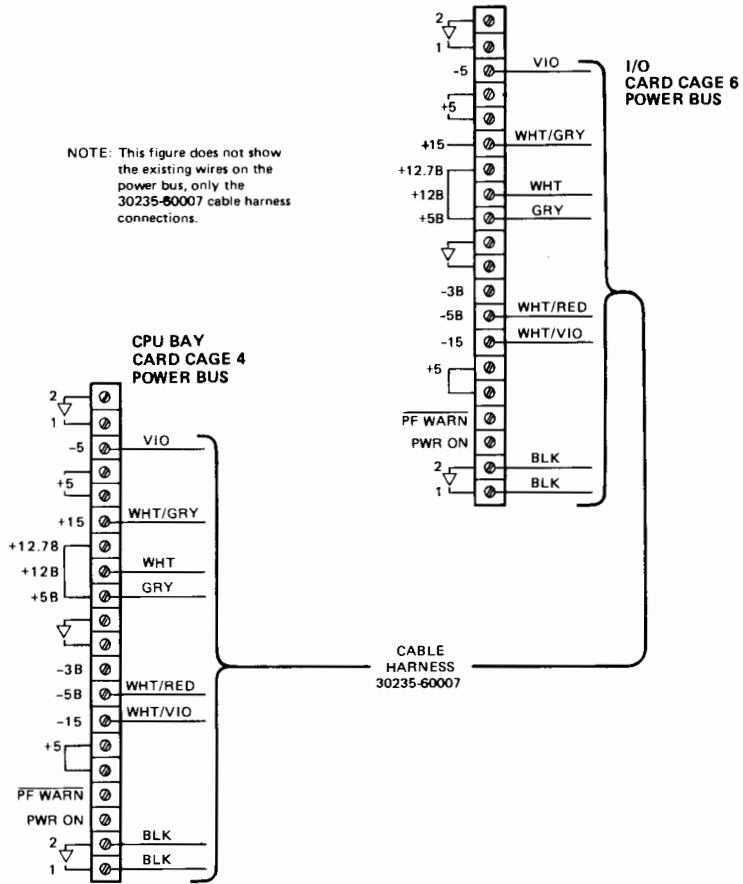

Reference: EDS

Power Distribution

DC POWER SUPPLY SPECIFICATIONS

LED and Test Point	Voltage Range		Power Supply Source	Supplies Dc Voltage To
	Minimum	Maximum		
+15	+14.5V	+16.5V	HP 63312F-P02	Card Cage 3-6
+12B	+11.9V	+12.1V	HP 61315D-P07	Card Cage 2-6
+5 CPU	+5.17V	+5.17V	HP 62605M-P41	Card Cage 1-2
+5B	+5.0V	+5.25V	HP 61315D-P07	Card Cage 2
+5-V1	+5.0V	+5.25V	HP 63312F-P02	Card Cage 3
+5-V2*	+5.0V	+5.25V	HP 63312F-P09	Card Cage 5
+5-V3*	+5.0V	+5.25V	HP 62605M-P41	Card Cage 5-6
TEMP	N/A	N/A	See Note	See Note
-5B	-5.0V	-5.25V	HP 61315D-P07	Card Cage 2-6
-5	-4.5V	-5.5V	HP 63312F-P09	Card Cage 3-6
-15	-14.5V	-15.5V	HP 63312F-P02	Card Cage 3-6

Note: The sense line for TEMP goes through a thermal switch in the equipment cabinet fan panel to +5-V2 in Card Cage No. 4. High temperatures open the thermal switch which simulates a power failure. If +5-V2 fails, the +5-V2 and TEMP LED's may both be lighted. However, the TEMP LED may remain lighted with the +5-V2 LED not lighted.

\* On the standard 1-bay model, +5-V2 is internally connected to +5-V3. If +5-V2 fails, one or both +5-V2 and +5-V3 LED's may be lighted.

Reference: RTM

## POWER SUPPLY CONTROL AND DISPLAY ASSEMBLY

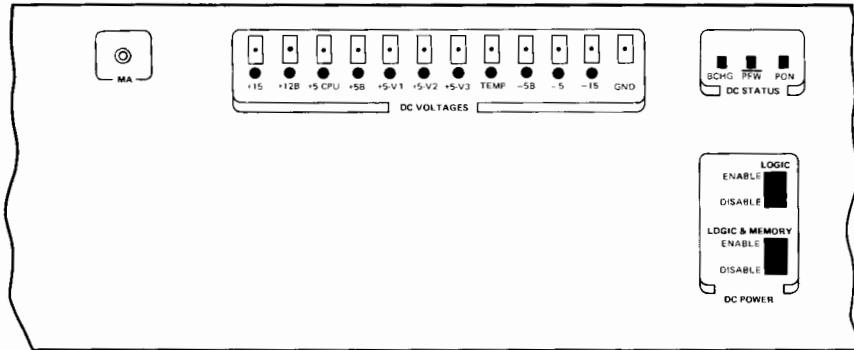

If the DC POWER LOGIC switch is set to DISABLE, a power failure is simulated so that the contents of memory will not be destroyed and first the PFW indicator and then the PON indicator will no longer be lighted. In addition, the DC VOLTAGES LED's will be reset to their lighted status.

When the DC POWER switches are set to ENABLE, the PFW indicator will light immediately if the system's input AC power is within specifications. After approximately one or two seconds, the PON indicator will light if all the system's DC voltages are present. If the PON indicator does not light, one or more of the DC voltages has failed and the DC VOLTAGES LED(s) that is lighted indicates the DC voltage that has failed. If this occurs, all power supplies except memory backup are shut down and their supply voltages are not available at the DC VOLTAGES test points.

If one or more of the DC voltages fail during normal system operation, the PON indicator will no longer be lighted and the faulty DC voltage(s) will be indicated by the lighted DC VOLTAGES LED(s). The PFW indicator will remain lighted.

The shutdown circuits of the Power Supply Control PCA can be disabled either by jumpering pins E5 and E8 on the PCA or by jumpering the Power Supply Control and Display Assembly MA (Maintenance Aid) and GND (Ground) test points. If a suspected power supply operates properly when these circuits are disabled, then the trouble is probably due to a malfunction in the Power Supply Control PCA and not in the power supply.

Reference: RTM

Power Distribution

DC STATUS/DC POWER INDICATORS AND SWITCHES

Indicator or Switch	Function
DC STATUS BCHG Indicator	When fully lighted, indicates that the system's battery is fully charged. When slowly blinking, indicates that the battery is charging. When rapidly blinking, indicates that the battery is discharging. When not lighted, indicates that the battery is completely discharged or that the battery is not installed in the system.
DC STATUS PFW Indicator	When lighted, indicates that the system's input AC power is within specifications. When not lighted, indicates that the AC power has dropped below specifications and that DC power from the power supplies may begin to decay.
DC STATUS PON Indicator	When lighted, indicates that AC power is applied to the power supplies and that the power supplies are operating properly. When not lighted, indicates that one or more power supplies are not operating properly or that the DC voltages from the power supplies has begun to decay due to loss of input AC power.
DC POWER LOGIC Switch	When set to DISABLE, removes DC power from all PCA's except memory to permit removal and replacement of the I/O and CPU PCA's without destroying the contents of memory. When set to ENABLE, applies DC power to all PCA's except memory PCA's.
DC POWER MEMORY Switch	When set to DISABLE, removes all DC power from all PCA's. When set to ENABLE, applies DC power to all PCA's provided that the LOGIC switch is also set to ENABLE.

Reference: RTM

BATTERY, PON, AND PFW CIRCUITS

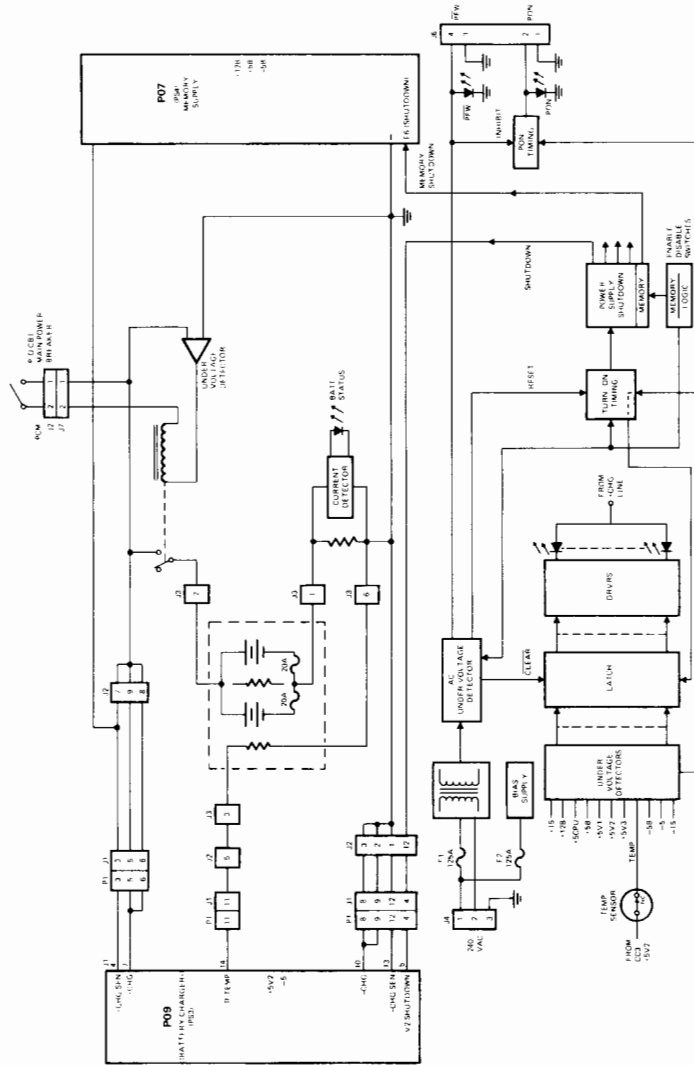

## Power Distribution

### BATTERY CARE

#### ENVIRONMENT

The useful life of the battery is shortened if it is exposed to prolonged excessive heat or cold. Deterioration is greatest at temperatures over 60 degrees Centigrade or less than -20 degrees Centigrade. When the battery is being charged, cold temperatures hinder recovery and warm temperatures (approximately 35 to 40 degrees Centigrade) speed recovery.

#### SHELF LIFE

Shelf life is defined as storage life whether the battery is stored on a shelf or installed in an unused system. Typically, a battery stored on a shelf at room temperature will lose 50 percent of its charge in six months.

#### DISCHARGED BATTERY

A discharged battery has an extremely short life. Therefore, leaving a battery in a discharged state is by far the most frequent and serious cause of cell damage. Some degrees of cell damage are as follows:

- a. A discharged cell left for one or two days will probably begin to accept a charge within a few seconds or minutes.
- b. A discharged cell left for several weeks may take several days to begin to accept a charge. It will charge somewhat slower than normal, but will eventually become fully charged after one or two days.
- c. A discharged cell left for six months or longer may never accept a charge or, if it does, it will be after several weeks of continuous charging.

#### RESTORING DAMAGED CELLS

When a fully discharged cell is left for a week or two, it will look almost like an open circuit to the charging source. Therefore, a neglected battery pack in the system will appear as a fully charged battery when first turned on. The charging current detector detects no charging current and immediately indicates a fully charged condition. The battery backup capability in this case is nonexistent. The battery pack can be restored if put on a constant-current-limited power supply (0.15 to 0.25 amperes) with the charging voltage set to 150 percent of the normal float voltage. Once the battery starts to accept the charge, apply 130 to 150 percent of its ampere-hour capacity. The cells used in the battery pack are rated at 5.0 ampere-hours.



SHIPPING

It is recommended that the connector leads of the battery pack be wrapped with electrical tape or some other non-conducting material when the battery pack is to be shipped or stored to prevent accidental shorting.

Power Distribution

NOTES

# DATA COMMUNICATIONS

SECTION

VII

## Table Of Contents

Topic	Page
Data Communications Documentation .....	7-2
Hardwired Serial Interface (HSI) Connector Numbering Scheme .....	7-3
HSI PCA Jumper and Switch Locations .....	7-4
HSI Connector Fabrication .....	7-5
HSI Cable Assembly, Schematic Diagram .....	7-6
HSI Status Word Format .....	7-7
Synchronous Single-Line Controller (SSLC) Connector Numbering Scheme .....	7-8
SSLC PCA Jumper and Switch Locations .....	7-9
SSLC 30055-60010 Cable and Test Connector, Schematic Diagram .....	7-10
SSLC 30055-60011 Cable and Test Connector, Schematic Diagram .....	7-11
SSLC Status Word Format .....	7-12



Data Communications

DATA COMMUNICATIONS DOCUMENTATION

HP 3000 Computer Systems Communications Handbook, part no. 30000-90105

Guidebook to Data Communications, part no. 5955-1715.

HP Distributed Systems Network 3000 to 3000 Reference Manual, part no. 32190-90001.

HP 30360A Hardwired Serial Interface Installation and Service Manual, part no. 30360-90001.

HP 30360A Hardwired Serial Interface Stand-Alone Diagnostic Program (D432) Manual, part no. 30360-90007.

HP 30055A Synchronous Single-Line Controller Installation and Service Manual, part no. 30055-90001.

Stand-Alone HP 30055A Synchronous Single-Line Controller Diagnostic Program (D434) Manual, part no. 30055-90008.

HARDWIRED SERIAL INTERFACE (HSI) CONNECTOR NUMBERING SCHEME

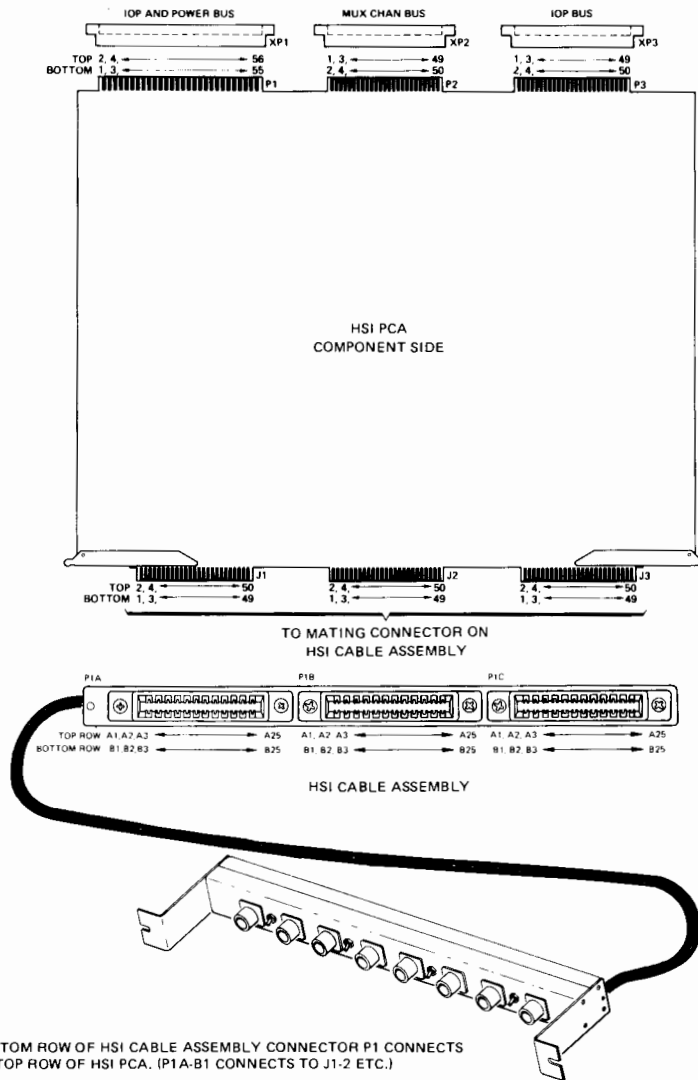

HSI PCA JUMPER AND SWITCH LOCATIONS

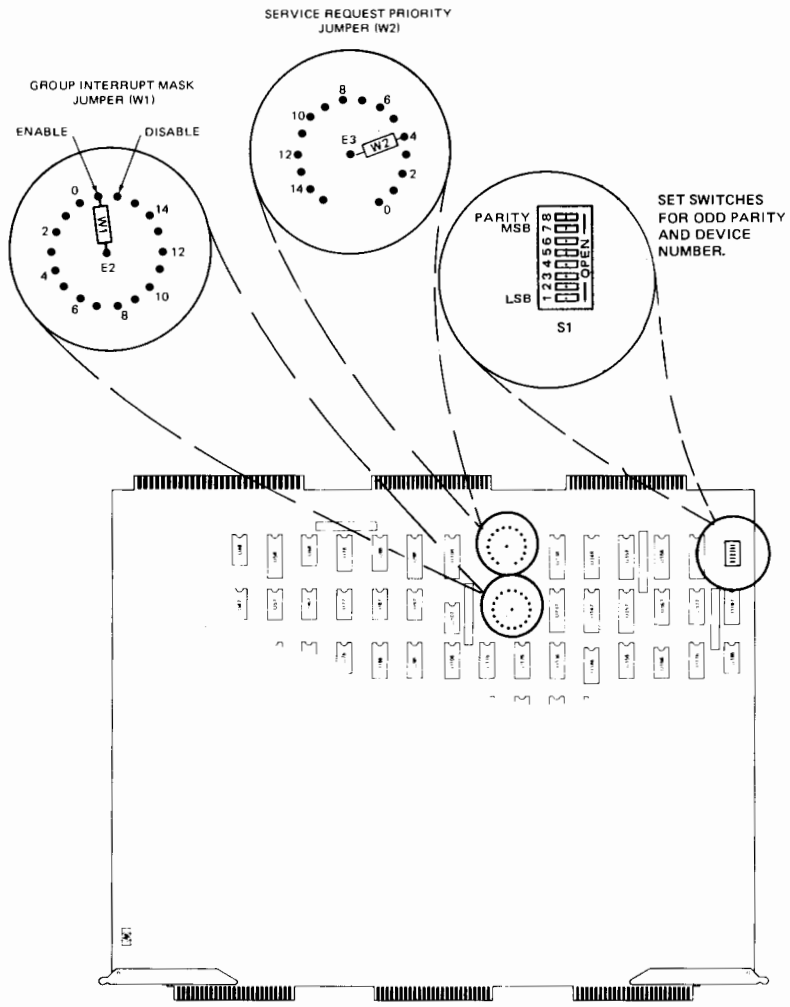

Reference: SIM

HSI CONNECTOR FABRICATION

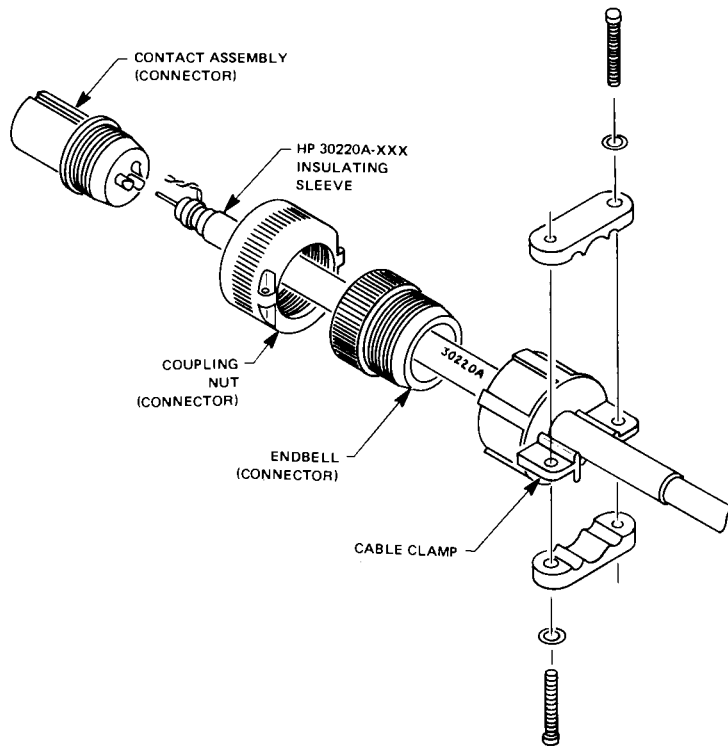

OPTION (HP 30220-XXX)	LENGTH		INSULATING SLEEVE PART NO.
	FEET	METERS	
Standard	25	7.62	30220-80001
-001	100	30.48	30220-80002
-002	250	76.20	30220-80003
-003	500	152.40	30220-80004
-004	1000	304.80	30220-80005
-005	2000	609.60	30220-80006

Data Communications

HSI CABLE ASSEMBLY, SCHEMATIC DIAGRAM

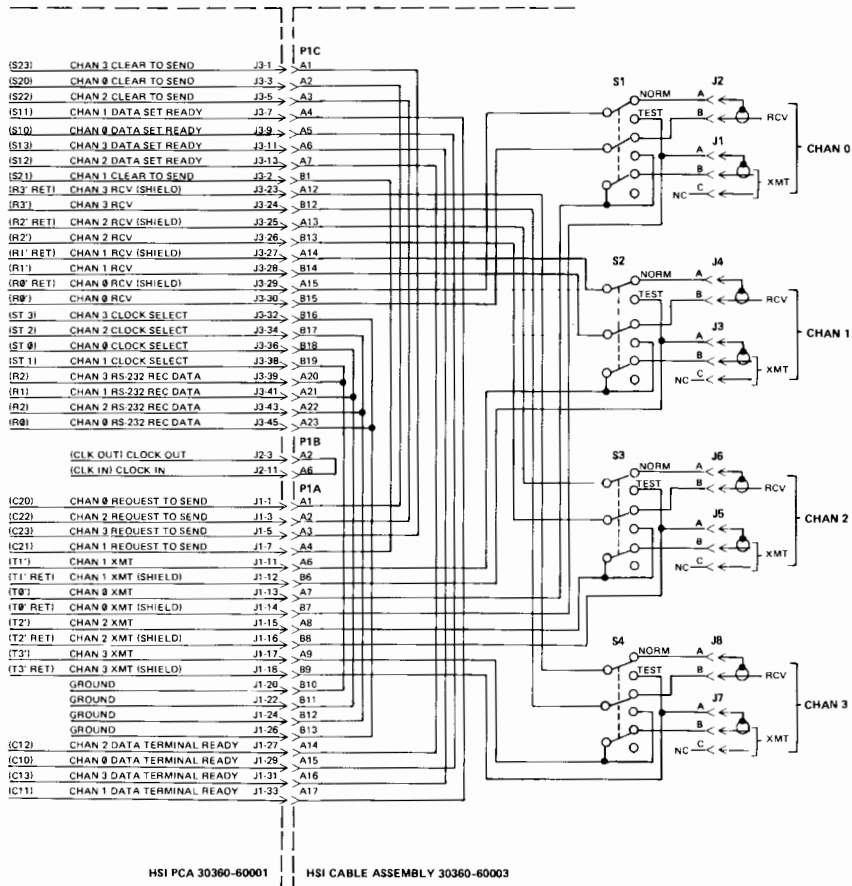

NOTE: SCHEMATIC REFERENCE DESIGNATIONS ARE SHOWN IN PARENTHESIS.



## HSI STATUS WORD FORMAT

```
-----
|0|1|2|3|4|5|6|7|8|9|10|11|12|13|14|15|
-----
```

- Bit 0 SIO OK. A logic 1 indicates the HSI PCA is ready to execute an SIO program. A logic 0 indicates an SIO program is being executed.
- Bit 1 Read/Write OK. A logic 1 indicates the receive or transmit section is not busy. Bits 3 and 4 are read to form this status bit.
- Bit 2 Interrupt Pending. A logic 1 indicates a condition for an interrupt exists.
- Bit 3 Read Buffer Ready. A logic 1 indicates the receive buffer has data present and is ready for processing.
- Bit 4 Write Buffer Ready. A logic 1 indicates the write buffer is ready to receive more data.
- Bit 5 Transfer Error. A logic 1 indicates a transfer error has occurred between the IOP and the HSI PCA.
- Bit 6 Time Out. A logic 1 indicates the time-out generator has timed out after approximately 15 msec because of a lack of data transfer.
- Bit 7 Service Request Valid (SRVAL). A logic 1 indicates that a Data Set Ready (DSR) input is asserted (positive) and that the Receive Data signal from the selected channel is in a high (space) state with receive enabled.
- Bit 8, Channel Service. Bits 9 and 10 indicate which channel 9, and (0-3) is requiring service. Bit 8 determines if the interrupt is from a DSR or Data-In condition (DSR = 0).
- Bit 11 Sense. A logic 1 indicates one of the four channels is in service.
- Bit 12 CRC Error. A logic 1 indicates a CRC check error.
- Bit 13 Over-Run Error. A logic 1 indicates another word has been received before the first word was serviced.
- Bit 14 Tag Bit Detected. A logic 1 indicates a detected tag bit.
- Bit 15 Compare Detected. A logic 1 indicates that either a six-bit address compare of a tag or a broadcast bit has been detected.

SYNCHRONOUS SINGLE-LINE CONTROLLER (SSLC)  
CONNECTOR NUMBERING SCHEME

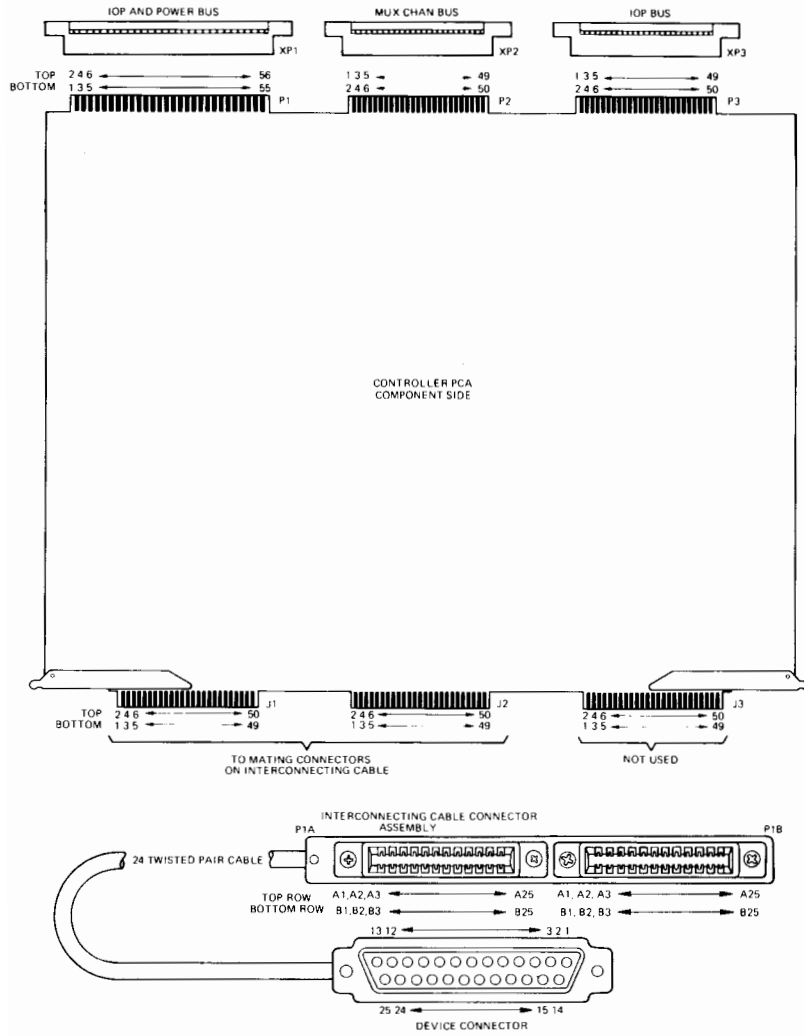

SSLC PCA JUMPER AND SWITCH LOCATIONS

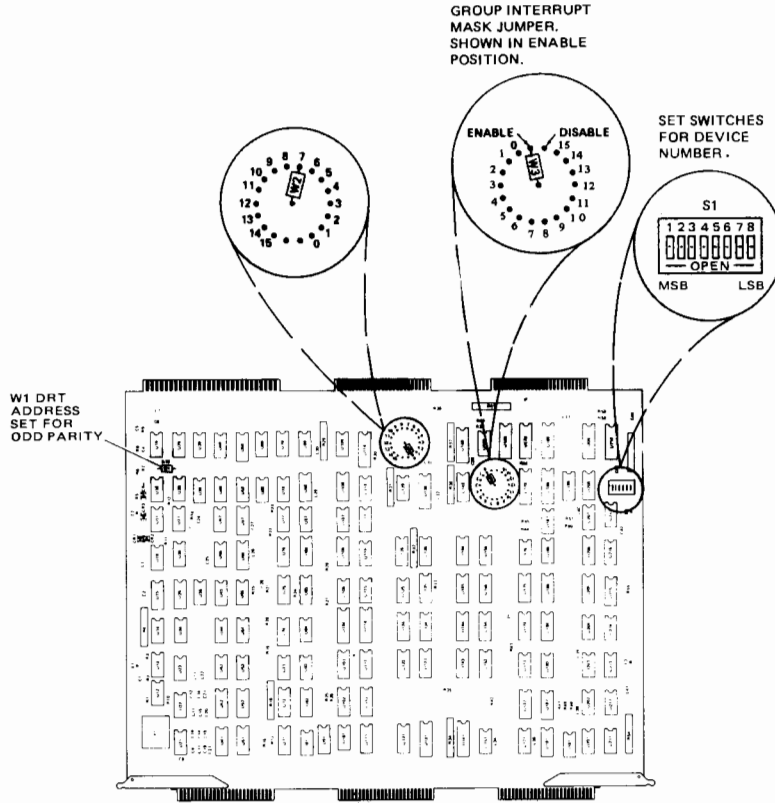

Reference: SIM

Data Communications

SSLC 30055-60010 CABLE AND TEST CONNECTOR, SCHEMATIC DIAGRAM

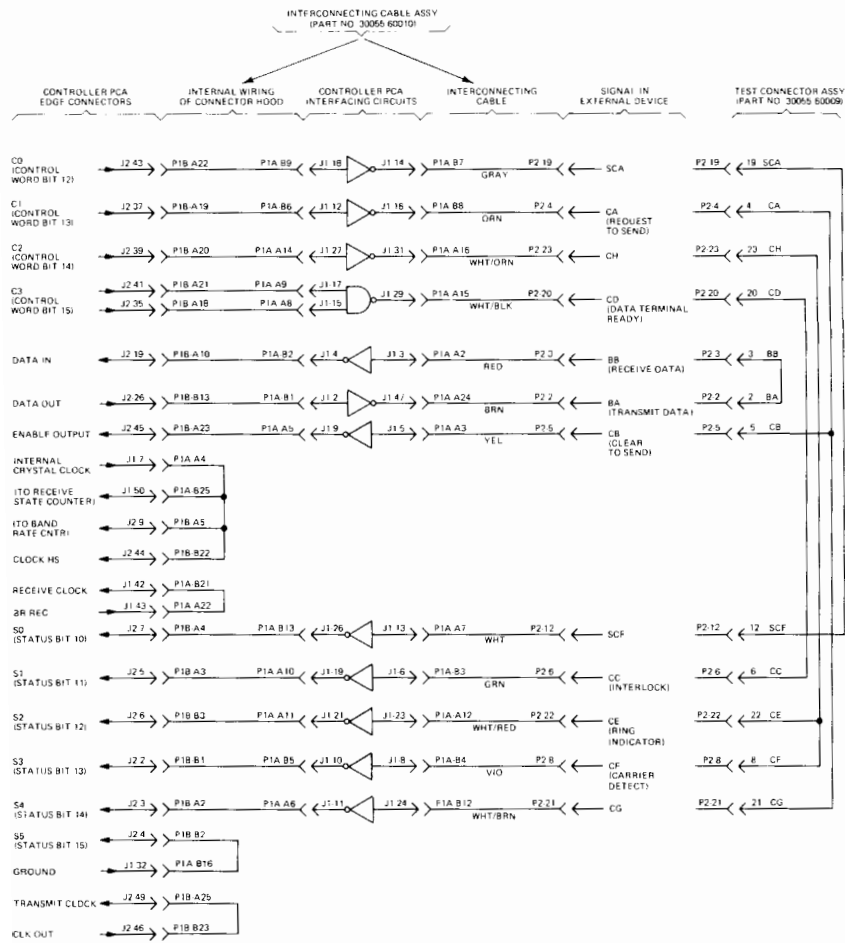

Data Communications

SSIC 30055-60011 CABLE AND TEST CONNECTOR, SCHEMATIC DIAGRAM



SSIC STATUS WORD FORMAT

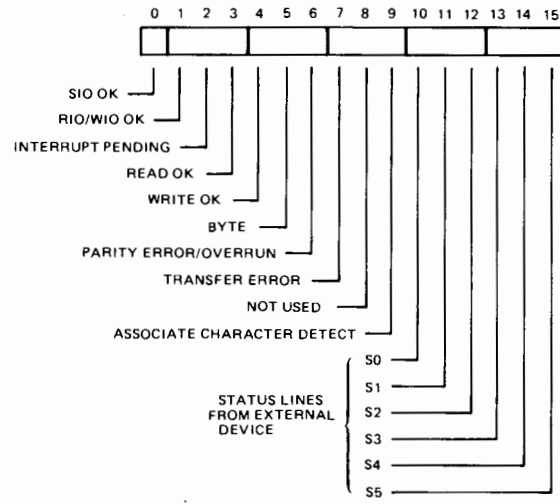

NOTES

Data Communications

NOTES



# PERIPHERALS

SECTION

VIII

## Table Of Contents

Topic	Page
2613/17/18/19 Line Printers Subsystem Connections .....	8-3
2608 Line Printer Subsystem Connections .....	8-4
Line Printers Interface PCA Jumper and Switch Locations ...	8-5
Line Printers Control Word Format .....	8-6
2608 Line Printer Command Word Formats .....	8-7
Line Printers Data/Format Word Formats .....	8-8
2613/17/18/19 Line Printers Status Word Formats .....	8-9
2608 Line Printer Status Word Formats .....	8-10
2748B Paper Tape Reader Subsystem Connections .....	8-11
Paper Tape Reader Interface PCA Jumper and Switch Locations	8-12
Paper Tape Reader Control Word Formats .....	8-13
Paper Tape Reader Status Word Formats .....	8-14
Paper Tape Data Word Formats .....	8-15
Paper Tape Format .....	8-15
2893A Card Reader Subsystem Connections .....	8-16
Card Reader Interface PCA Jumper Locations .....	8-17
Card Reader Control Word Format .....	8-18
Card Reader Status Word Format .....	8-18
Card Column Binary Coding Example .....	8-19
2894A Card Reader/Punch Subsystem Connections .....	8-20
Card Reader/Punch Interface PCA Jumper and Switch Locations	8-21
Card Reader/Punch Control Word Formats .....	8-22
Card Reader/Punch Status Word Formats .....	8-24
Card Reader/Punch Data Word Formats .....	8-26
Connections Between Card Reader/Punch and Interface PCA ...	8-27
2895A Paper Tape Punch Subsystem Connections .....	8-29
Paper Tape Punch Interface PCA Jumper and Switch Locations.	8-30
Paper Tape Punch Control Word Format .....	8-31
Paper Tape Punch Status Word Formats .....	8-32
7905A/7920A/7925A Disc Drive Data Cable Connections .....	8-33
Disc Drive Multi-Unit Cable Connections .....	8-34
Disc Drive Interface PCA Jumper and Switch Locations .....	8-35
Disc Drive Subtype List .....	8-36
Disc Drive Subtype Parameters .....	8-36
Disc Drive Control Word Format .....	8-37
Disc Drive Status Word Format .....	8-37
Disc Drive Status - 1 Word Format .....	8-38
Disc Drive Status - 2 Word Format .....	8-38
Disc Drive Command Descriptions .....	8-39
7970B/E Magnetic Tape Drive Interface PCA Position and Connector Details .....	8-41
Magnetic Tape Drive Master Unit (7970E) Cable Connections .	8-42
Magnetic Tape Drive Slave Unit (7970E) Cable Connections ..	8-43

Peripherals

Table Of Contents (Continued)

Topic	Page
Magnetic Tape Drive Controller PCA Jumper and Switch	
Locations .....	8-44
Magnetic Tape Drive Control Word (P CONT STB) Format .....	8-45
Magnetic Tape Drive Status Word Format .....	8-46
Tape Format For 800 BPI Tape .....	8-47
Tape Format For 1600 BPI Tape .....	8-47
30032B/30061A Asynchronous Terminal Controller Subsystem	
Block Diagram .....	8-48
Asynchronous Terminal Controller Interconnection Diagram ..	8-49
Asynchronous Terminal Controller TDI PCA Connector	
Numbering Scheme .....	8-50
Asynchronous Terminal Controller TCI PCA Connector	
Numbering Scheme .....	8-51
TDI PCA Jumper and Switch Locations .....	8-52
TCI PCA Jumper and Switch Locations .....	8-53
TDI Control Word Format .....	8-54
TDI Status Word Format .....	8-54
TCI Control Word Format .....	8-55
TCI Status Word Format .....	8-55
Asynchronous Terminal Controller RS232C Signal Descriptions	8-56
Asynchronous Terminal Controller Modem Cable Pin	
Connections .....	8-57
Asynchronous Terminal Controller Hardware/Extension Cable	
Pin Connections .....	8-58
30226A Plotter Interface Subsystem Connections .....	8-59
Plotter Interface PCA Jumper and Switch Locations .....	8-60
Plotter Interface Control Word Format .....	8-61
Plotter Interface Status Word Format .....	8-61
Plotter Interface Diagnostic Test Hood Wiring Diagram .....	8-62
Plotter Interface Diagnostic Test Hood Jumper Functions ...	8-63
HP 30341A Series III HP-IB Interface Module	
IMBA PCA Cable Connections .....	8-65
Self-Test .....	8-66
Decoding BIC PCA Self-Test Led's .....	8-67
I/O Instructions .....	8-69
Modified HP-IB I/O DRT Format .....	8-69
Direct I/O Command Definitions .....	8-70
DIO Status .....	8-71
I/O Status Block .....	8-72

2613/17/18/19 LINE PRINTERS SUBSYSTEM CONNECTIONS

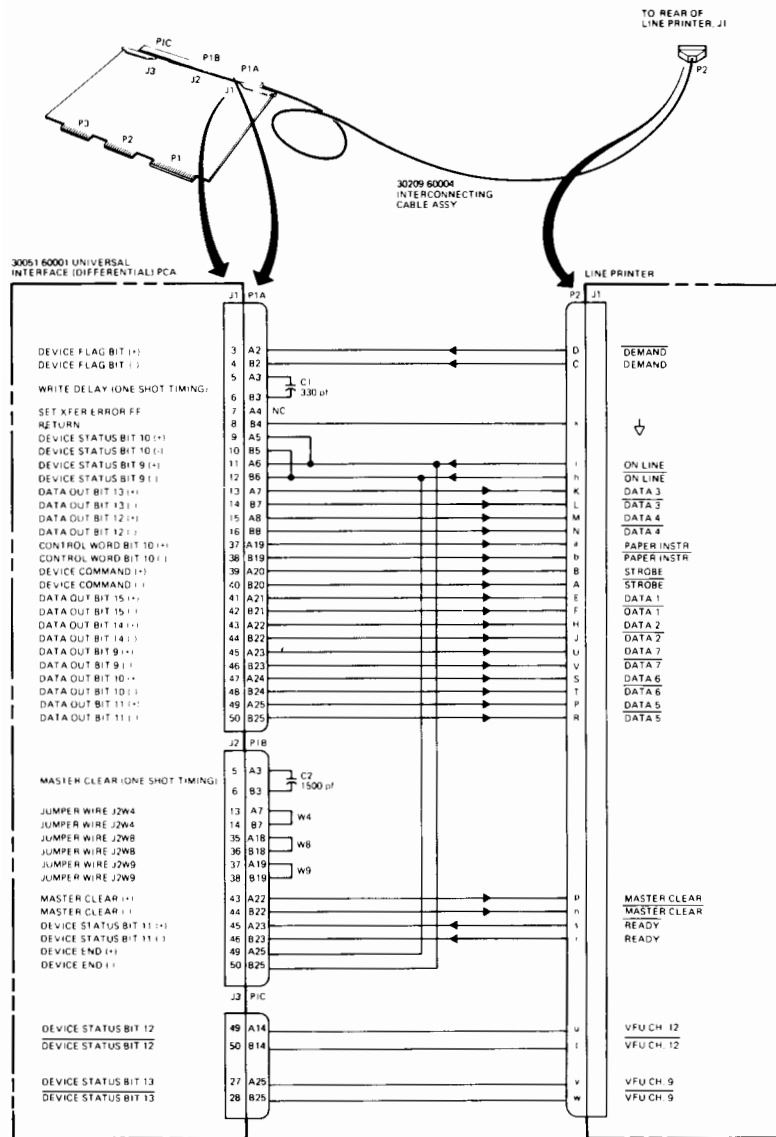

Peripherals

2608 LINE PRINTER SUBSYSTEM CONNECTIONS

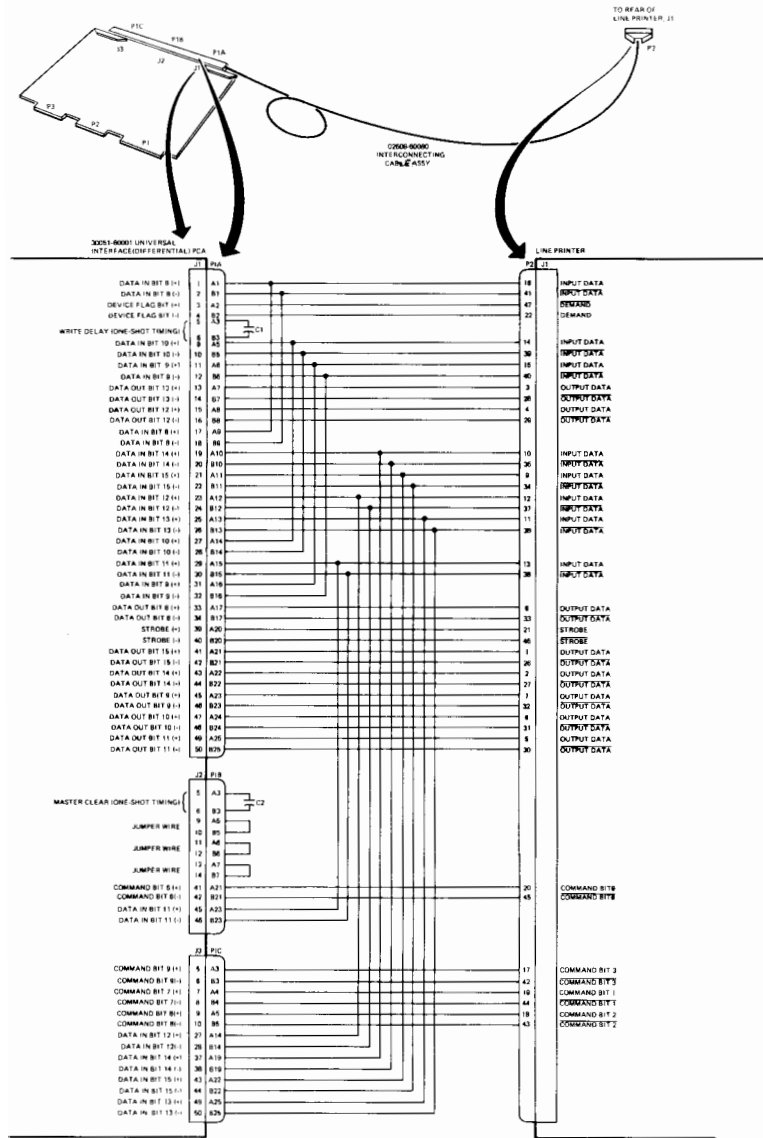

LINE PRINTER INTERFACE PCA JUMPER AND SWITCH LOCATIONS

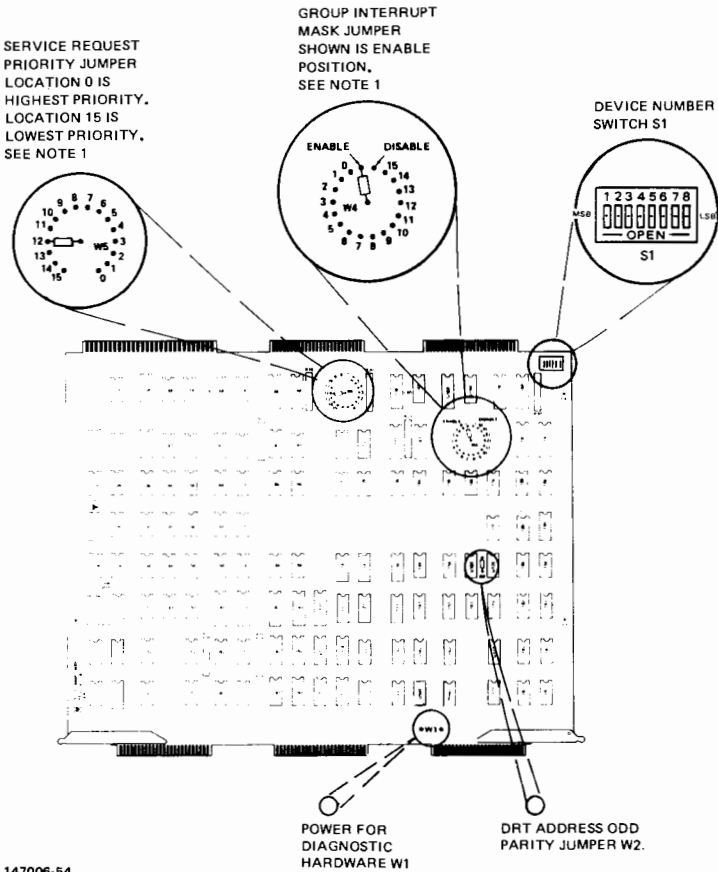

147006-54

NOTE 1: ON PCA'S WITH A DATE CODE OF 47-2125 OR NEWER, THE WHEEL JUMPERS HAVE BEEN REPLACED WITH ROCKER SWITCHES, NUMBERED AS:

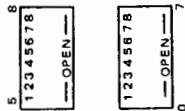

Peripherals

LINE PRINTERS CONTROL WORD FORMAT

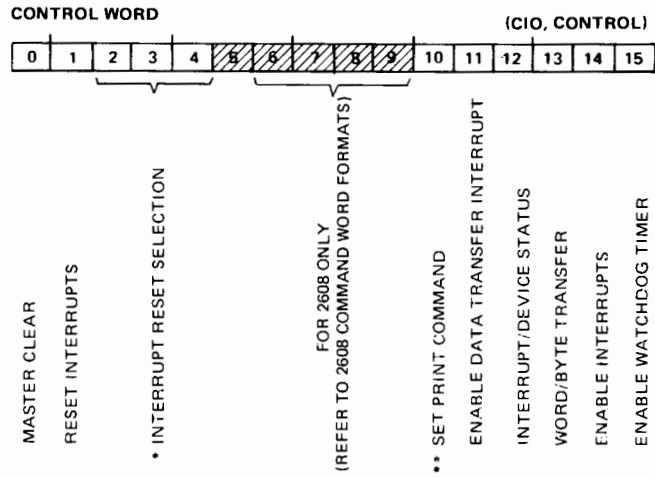

\* INTERRUPT RESET SELECTION

1	2	3	4	
0	0	0	0	NO RESET
0	0	0	1	WATCHDOG TIMER AND TRANSFER ERROR
0	0	1	0	I/O SYSTEM
0	0	1	1	CLEAR INTERFACE
0	1	0	0	DATA TRANSFER COMPLETION
0	1	0	1	LINE READY
0	1	1	0	READY
0	1	1	1	NOT READY

\*\*Control Word (bit 10) sets Print Command FF.  
 The next WIO (format word) initiates a print.

147006-55

## 2608 LINE PRINTER COMMAND WORD FORMATS

<u>Command</u>	<u>Control Word</u> <u>Bits 6 - 9</u>
Data	0 0 0 0
Character Set Change	0 0 0 1
VFC Set/Reset	0 0 1 0
(n - even)	0 0 0 0
(n - odd)	0 0 0 0
On/Off Line	0 0 1 1
Self Test	0 1 0 0
Master Clear	0 1 0 1
Ping - Pong	0 1 1 0
Buffer Clear	0 1 1 1
Print	1 0 0 0
Status Read	1 0 1 0
Print Mode	1 0 1 1

Peripherals

LINE PRINTERS DATA/FORMAT WORD FORMATS

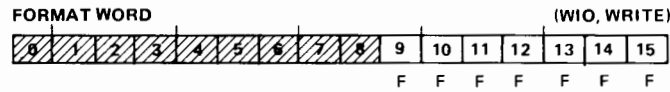
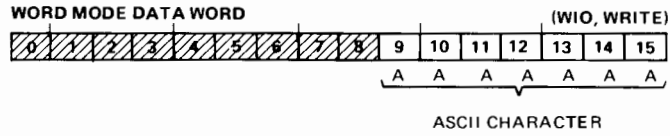
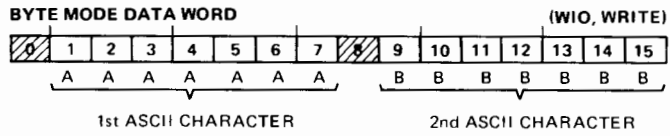

A LINE PRINTER FORMAT WORD FOLLOWS A CONTROL WORD HAVING BIT 10 SET, AND CAUSES THE PRINTER TO PRINT AND FORMS CONTROL.

**DEVICE STATUS (ALL)**

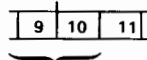

- 0    0    NOT READY
- 0    1    PAPER OUT
- 1    0    READY TO PRINT
- 1    1    POWER OFF



2613/17/18/19 LINE PRINTER STATUS WORD FORMATS

INTERRUPT STATUS WORD (TIO, SENSE END)

0	1	2	3	4	5	6	7	8	9	10	11	12	13	14	15
---	---	---	---	---	---	---	---	---	---	----	----	----	----	----	----

SIO OK  
 RIO/WIO OK  
 INTERRUPT REQUEST  
 SEQUENCE FLIP-FLOP 1  
 SEQUENCE FLIP-FLOP 2  
 DEVICE FLAG  
 INTERRUPT STATUS = 0  
  
 ON-LINE INTERRUPT  
 ON-LINE INTERRUPT  
 DATA TRANSFER INTERRUPT  
  
 DIAGNOSTIC INTERRUPT  
 TRANSFER ERROR INTERRUPT  
 WATCHDOG TIMER INTERRUPT

DEVICE STATUS WORD (TIO, SENSE END)

0	1	2	3	4	5	6	7	8	9	10	11	12	13	14	15
---	---	---	---	---	---	---	---	---	---	----	----	----	----	----	----

SIO OK  
 RIO/WIO OK  
 INTERRUPT REQUEST  
 SEQUENCE FLIP-FLOP 1  
 SEQUENCE FLIP-FLOP 2  
 DEVICE FLAG  
 DEVICE STATUS = 1  
  
 ON-LINE  
 READY  
 VFU CHANNEL 12  
 VFU CHANNEL 9  
 DEV STATUS

Peripherals

2608 LINE PRINTER STATUS WORD FORMATS

INTERRUPT STATUS WORD (TIO, SENSE END)

0	1	2	3	4	5	6	7	8	9	10	11	12	13	14	15
---	---	---	---	---	---	---	---	---	---	----	----	----	----	----	----

SIO OK	RIO/WIO OK	INTERRUPT REQUEST	SEQUENCE FLIP-FLOP 1	SEQUENCE FLIP-FLOP 2	DEVICE FLAG	INTERRUPT STATUS = 0		ON-LINE/OFF-LINE					DIAGNOSTIC INTERRUPT	TRANSFER ERROR INTERRUPT	WATCHDOG TIMER INTERRUPT
--------	------------	-------------------	----------------------	----------------------	-------------	----------------------	--	------------------	--	--	--	--	----------------------	--------------------------	--------------------------

DEVICE STATUS WORD (TIO, SENSE END)

0	1	2	3	4	5	6	7	8	9	10	11	12	13	14	15
---	---	---	---	---	---	---	---	---	---	----	----	----	----	----	----

SIO OK	RIO/WIO OK	INTERRUPT REQUEST	SEQUENCE FLIP-FLOP 1	SEQUENCE FLIP-FLOP 2	DEVICE FLAG	DEVICE STATUS = 1		ON-LINE/OFF-LINE	READY	**VFC CHANNEL 9	**VFC CHANNEL 12	DEFAULT VFC ACTIVE	6/8 LPI		*POWER FAIL OR RESET
--------	------------	-------------------	----------------------	----------------------	-------------	-------------------	--	------------------	-------	-----------------	------------------	--------------------	---------	--	----------------------

- \* CAN BE RESET SWITCH ON UNIT
- \*\* REFLECT CURRENT PAPER POSITION WHICH IS NOT NECESSARILY THE SAME AS PAPER POSITION WHICH WILL RESULT AFTER ALL BUFFERED COMMANDS ARE EXECUTED.

2748B PAPER TAPE READER SUBSYSTEM CONNECTIONS

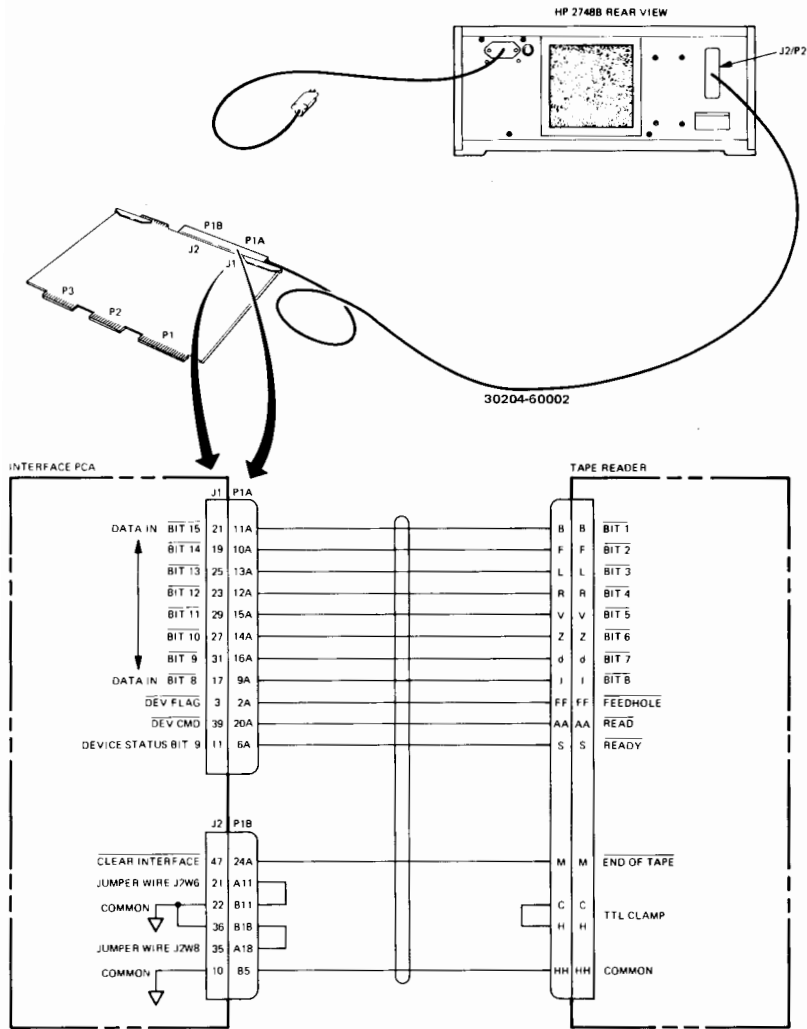

Peripherals

PAPER TAPE READER INTERFACE PCA JUMPER AND SWITCH LOCATIONS

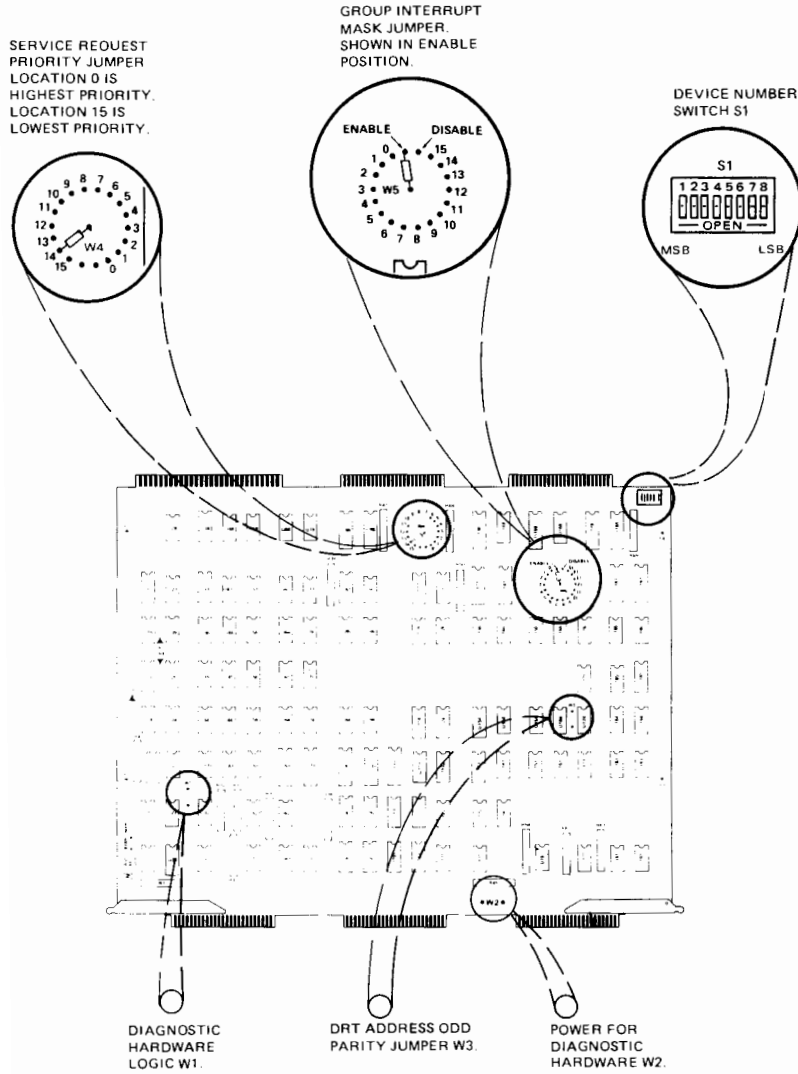

PAPER TAPE READER CONTROL WORD FORMATS



MASTER CLEAR												INTERRUPT STATUS = 0			
RESET INTERRUPTS												WORD TRANSFER = 0			
												ENABLE INTERRUPTS			
												TRIGGER TRANSFER TIMER			



MASTER CLEAR												DEVICE STATUS = 1			
RESET INTERRUPTS												BYTE TRANSFER = 1			
												ENABLE INTERRUPTS			
												TRIGGER TRANSFER TIMER			

Peripherals

PAPER TAPE READER STATUS WORD FORMATS

INTERRUPT STATUS WORD										(TIO, SENSE, END)					
0	1	2	3	4	5	6	7	8	9	10	11	12	13	14	15

SIO OK	RIO/WIO OK	INTERRUPT REQUEST	SEQUENCE FLIP-FLOP 1	SEQUENCE FLIP-FLOP 2	DEVICE FLAG	INTERRUPT STATUS = 0			READY			END OF TAPE	PROGRAMMED INTERRUPT	TRANSFER ERROR	TIMEOUT
--------	------------	-------------------	----------------------	----------------------	-------------	----------------------	--	--	-------	--	--	-------------	----------------------	----------------	---------

DEVICE STATUS WORD										(TIO, SENSE, END)					
0	1	2	3	4	5	6	7	8	9	10	11	12	13	14	15

SIO OK	RIO/WIO OK	INTERRUPT REQUEST	SEQUENCE FLIP-FLOP 1	SEQUENCE FLIP-FLOP 2	DEVICE FLAG	DEVICE STATUS = 1			READY						
--------	------------	-------------------	----------------------	----------------------	-------------	-------------------	--	--	-------	--	--	--	--	--	--

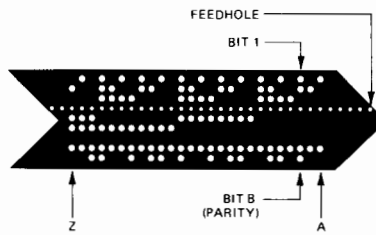
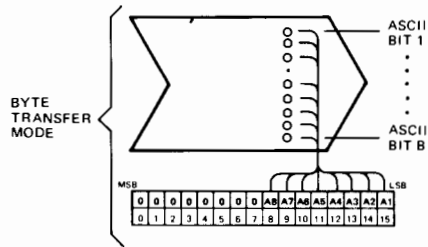
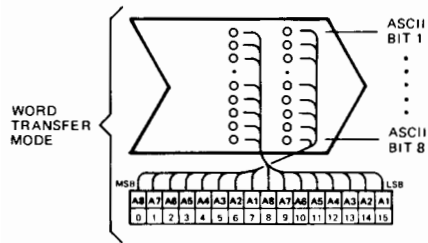

NOTE: ARROW SHAPE OF TAPE INDICATES DIRECTION OF TRAVEL THROUGH TAPE READER. ASCII CHARACTERS A THROUGH Z PUNCHED.

PAPER TAPE FORMAT

Peripherals

2893A CARD READER SUBSYSTEM CONNECTIONS

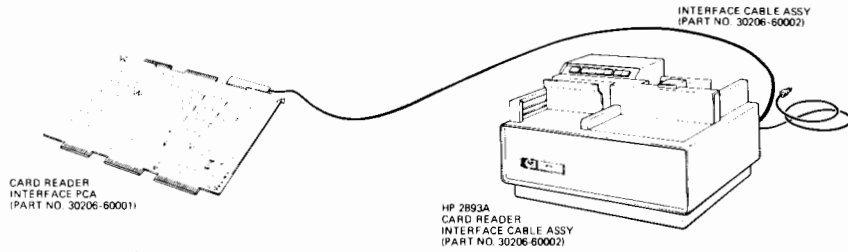

CARD READER INTERFACE PCA			CARD READER	
J1	P1		P2	J2
CARD ROW 12	45 23A	WHT BRN-BLU		A CARD ROW 12
CARD ROW 12	46 23B	WHT		E CARD ROW 12
CARD ROW 11	27 17B	WHT		B CARD ROW 11
CARD ROW 11	22 11A	WHT-BLK-BRN		F CARD ROW 11
CARD ROW 0	29 15B	WHT		C CARD ROW 0
CARD ROW 0	30 15A	WHT-BLK-GRN		H CARD ROW 0
CARD ROW 1	39 20B	WHT		D CARD ROW 1
CARD ROW 1	40 20A	WHT-BRN-ORN		J CARD ROW 1
CARD ROW 2	35 18B	WHT		K CARD ROW 2
CARD ROW 2	36 18A	WHT-BLK-GRY		P CARD ROW 2
CARD ROW 3	25 13A	WHT-BLK-ORN		L CARD ROW 3
CARD ROW 3	26 13B	WHT		R CARD ROW 3
CARD ROW 4	43 27B	WHT		M CARD ROW 4
CARD ROW 4	44 27A	WHT-BRN-GRN		S CARD ROW 4
CARD ROW 5	47 24B	WHT		N CARD ROW 5
CARD ROW 5	48 24A	WHT-BRN-VIO		T CARD ROW 5
CARD ROW 6	41 21A	WHT-BRN-YEL		U CARD ROW 6
CARD ROW 6	42 21B	WHT		V CARD ROW 6
CARD ROW 7	33 17A	WHT-BLK-VIO		Z CARD ROW 7
CARD ROW 7	34 17B	WHT		W CARD ROW 7
CARD ROW 8	37 19A	WHT-BRN-RED		a CARD ROW 8
CARD ROW 8	38 19B	WHT		d CARD ROW 8
CARD ROW 9	49 25A	WHT-BRN-GRY		i CARD ROW 9
CARD ROW 9	50 25B	WHT		c CARD ROW 9
ERROR(LIGHT/DARK)	31 16A	WHT-BLK-BLU		h ERROR(LIGHT/DARK)
ERROR(LIGHT/DARK)	32 16B	WHT		e ERROR(LIGHT/DARK)
HOPPER EMPTY	17 9B	WHT		k HOPPER EMPTY
HOPPER EMPTY	18 9A	WHT-VIO		p MOTION/PICK CHECK
MOTION/PICK CHECK	7 4A	WHT-RED		u MOTION/PICK CHECK
MOTION/PICK CHECK	8 4B	WHT		f PICK COMMAND
PICK COMMAND	3 2A	WHT-BLK		i PICK COMMAND
PICK COMMAND	4 2B	WHT		m PICK COMMAND
NC	NC			n BUSY
NC	NC			l BUSY
INDEX MARK	19 10B	WHT		r INDEX MARK
INDEX MARK	20 10A	WHT-GRY		v INDEX MARK
STACKER FULL	9 5B	WHT		y STACKER FULL
STACKER FULL	10 5A	WHT-ORN		CC STACKER FULL
END OF FILE CLEAR	5 3B	WHT		w END OF FILE CLEAR
END OF FILE CLEAR	6 3A	WHT-BRN		AA END OF FILE CLEAR
END OF FILE	27 14B	WHT		x END OF FILE
END OF FILE	28 14A	WHT-BLK-YEL		BB END OF FILE
OFF LINE	13 7B	WHT		z OFF LINE
OFF LINE	14 7A	WHT-GRN		DD OFF LINE
+5 VOLTS	NC			HH +5 VOLTS
COMMON	11 6A	WHT-YEL		i COMMON
COMPARE	16 8B	WHT		FF COMPARE
COMPARE	15 8A	WHT-BLU		EE COMPARE
READY	23 12A	WHT-BLK-RED		X READY
READY	24 12B	WHT		b READY

PINS NOT LISTED ARE NOT CONNECTED



CARD READER INTERFACE PCA JUMPER LOCATIONS

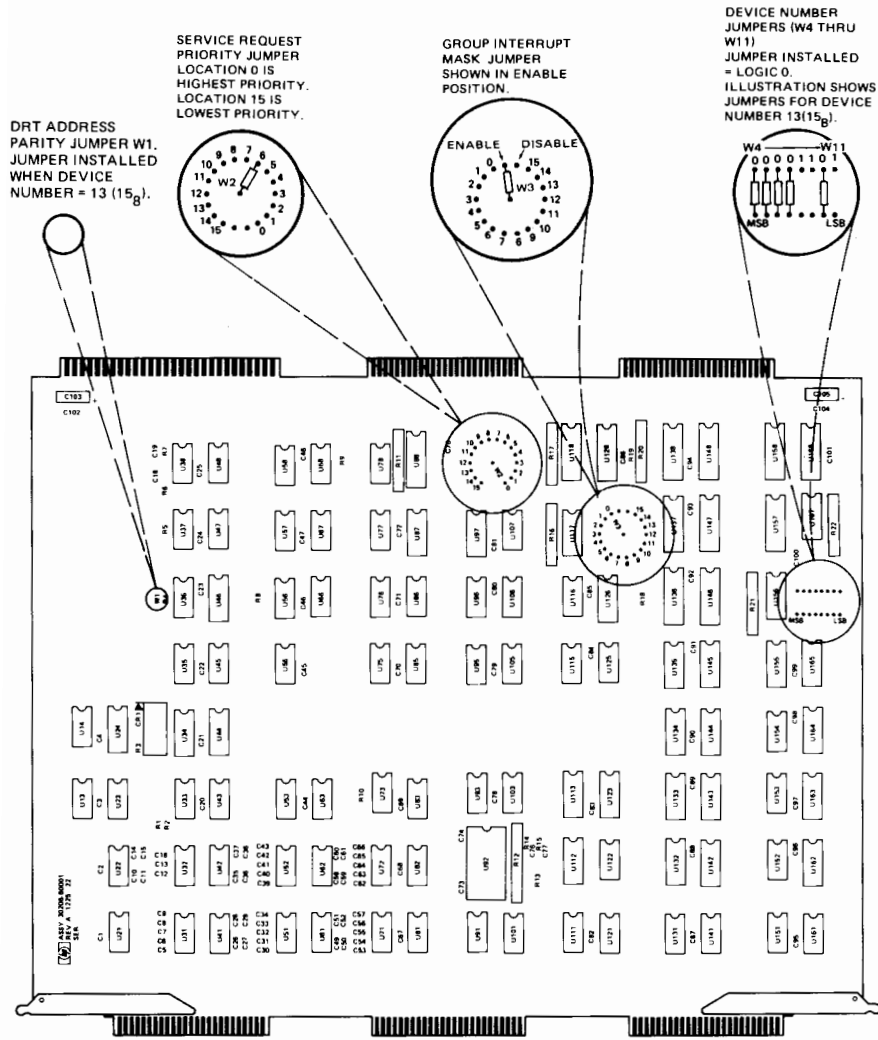

Peripherals

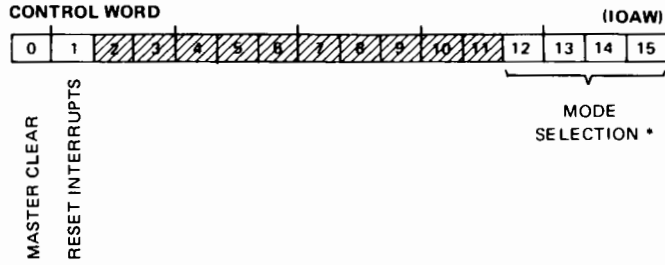

**MODE SELECTION**

10	11	12	13	14	15			WORD COUNT
		0	1	0	1		COLUMN BINARY	7660 (% 120)
x		1	0	0	1		PACKED BINARY	7704 (% 74)
x		1	0	1	0		ASCII CONVERTED HOLLERITH	7730 (% 50)
x		0	0	0	0		NO MODE CHANGE	
1	x	x	x	x	x		OFFSET CARD	

CARD READER CONTROL WORD FORMAT

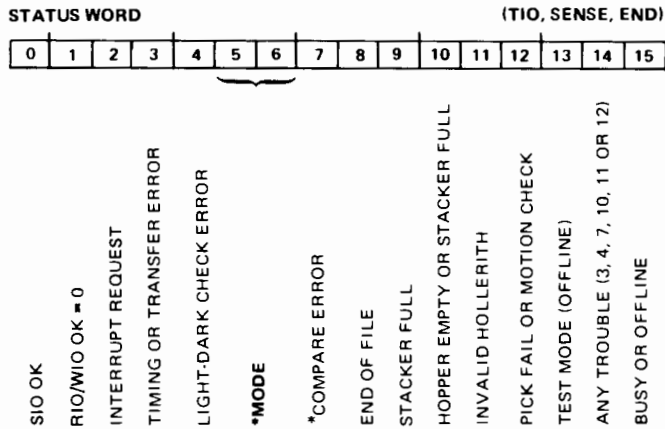

**\*MODE**

5	6	
0	0	COLUMN BINARY
0	1	N/A
1	0	PACKED BINARY
1	1	ASCII

CARD READER STATUS WORD FORMAT

CARD COLUMN BINARY CODING EXAMPLE

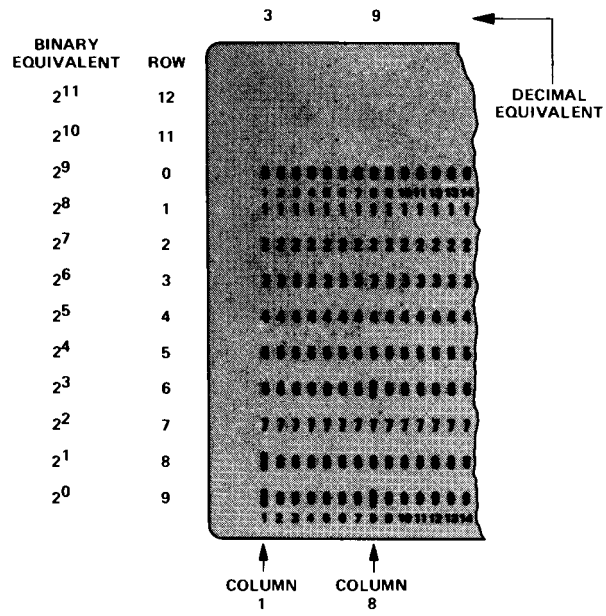

Peripherals

2894A CARD READER/PUNCH SUBSYSTEM CONNECTIONS

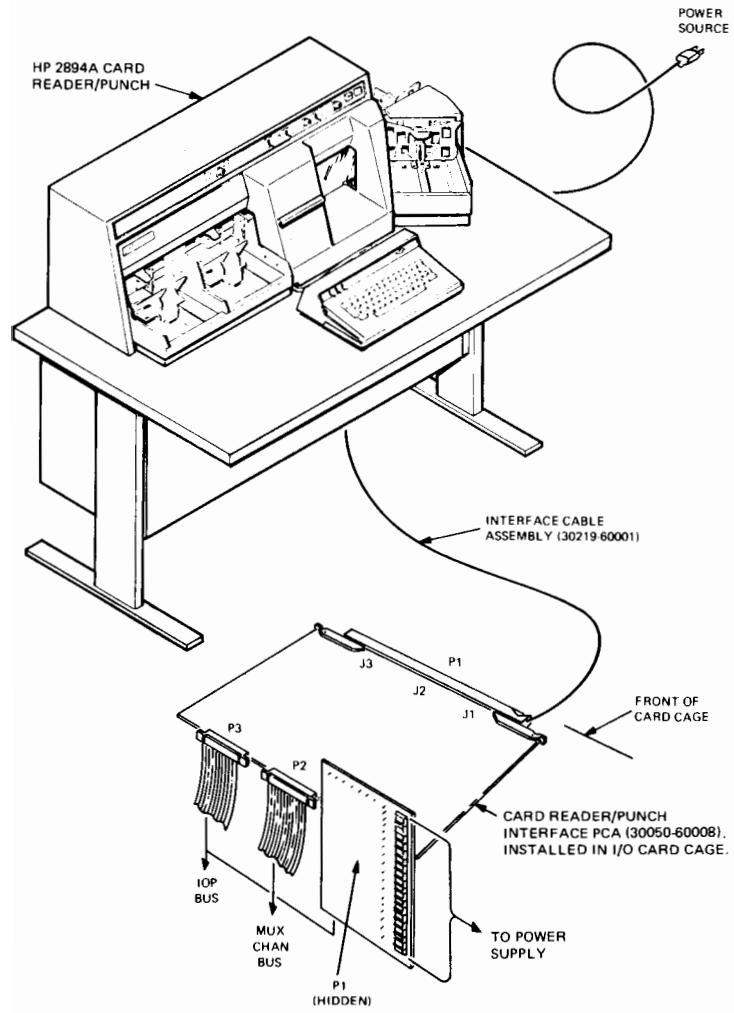

CARD READER/PUNCH INTERFACE PCA JUMPER AND SWITCH LOCATIONS

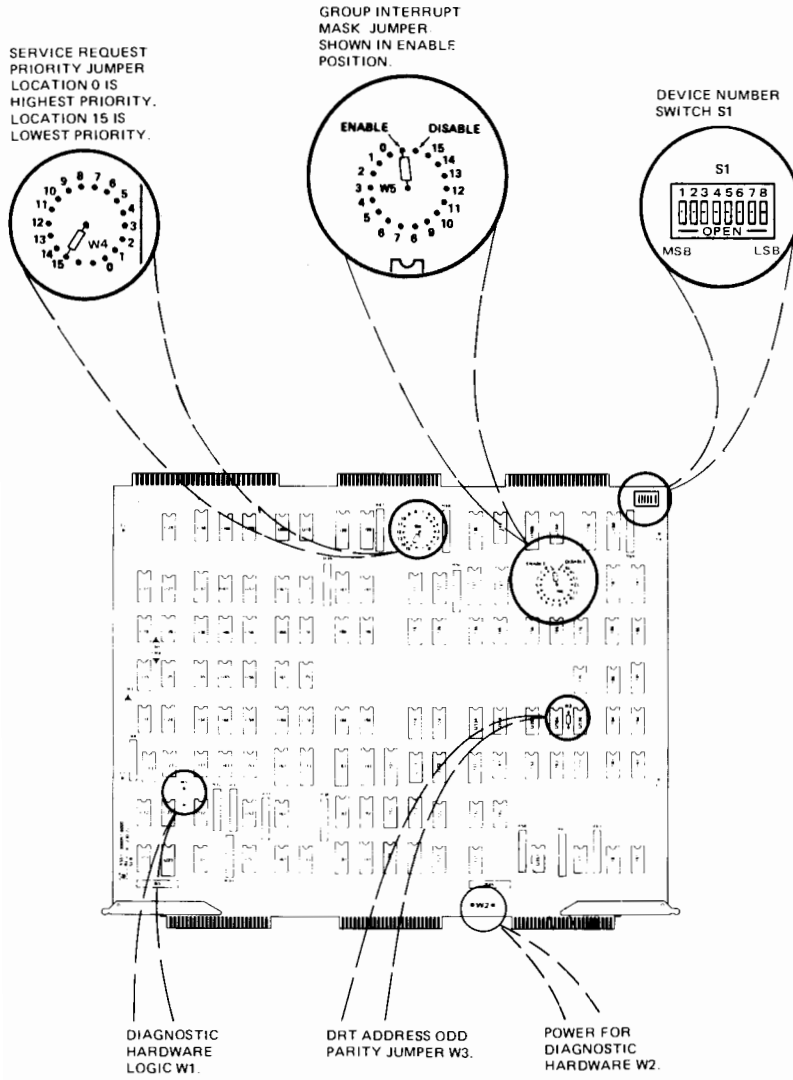

Peripherals

CARD READER/PUNCH CONTROL WORD FORMATS

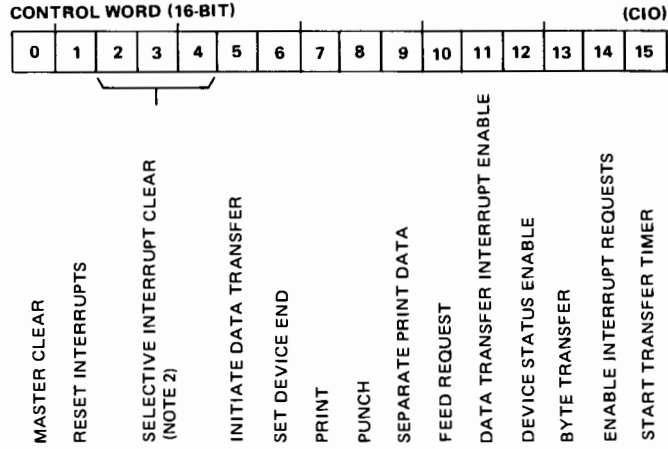

NOTES:

- The 16-bit control word is transferred to the interface PCA by a CIO instruction. The control word is stored on the interface PCA until bits are cleared as follows:
  - Control word bits 0, 1, 2, 3, 4, and 5 always become clear immediately after performing their function.
  - The entire control word is cleared to zero when either of the following takes place:
    - An I/O reset occurs.
    - Another control word which has 1 in position 0 is sent to the interface PCA by a CIO instruction.
  - A particular bit of the control word is cleared when another control word, with 0 in that bit position, is sent to the interface PCA by a CIO instruction.
- Selective Interrupt Clear functions as follows:

CONTROL WORD BITS			INTERRUPT STATUS BIT CLEARED	INTERRUPT CONDITION CLEARED
2	3	4		
0	0	0	None	None
0	0	1	Bits 14 and 15	Clear transfer error Interrupt and timeout interrupt.
0	1	0	Bit 13	Clear programmed interrupt.
0	1	1	Bit 12	Clear input buffer full interrupt.
1	0	0	Bit 11	Clear data transfer interrupt.
1	0	1	Bit 8	Clear ready-for-command interrupt.
1	1	0	Bit 9	Clear ready interrupt.
1	1	1	Bit 10	Clear not-ready interrupt.

- Also terminates the 5-second I/O timeout cycle without an interrupt, if issued during the 5-second cycle.

CARD READER/PUNCH CONTROL WORD FORMATS (Continued)



CLEAR BUFFER FULL  
 STACKER CONTROL MODE  
 SELECT STACKER TWO  
 SECONDARY HOPPER SELECT  
 INHIBIT INPUT FEED

NOTE:

The 5-bit control word is transferred to the interface PCA by a WIO instruction. The control word is stored on the interface PCA until one of the following occurs:

- a. Another WIO instruction is executed. (However, bit 1 is not affected.)
- b. A CIO instruction transfers a 16-bit control word to the interface PCA in which bit 0 (Master Clear) is 1. (Bit 1 is not affected.)
- c. An I/O reset occurs. (Bit 1 is not affected.)

Peripherals

CARD READER/PUNCH STATUS WORD FORMATS

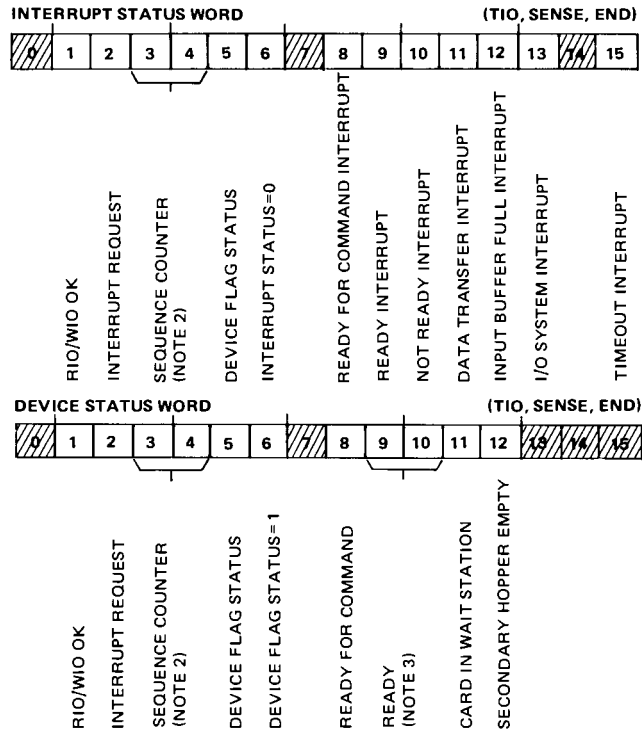

NOTES:

1. The status word is acquired by a TIO instruction.
2. These bits are for equipment test and troubleshooting. They indicate the state of the data-transfer sequence counter on the interface PCA. States are as follows:

STATUS WORD BITS	COUNTER STATE	INTERFACE PCA CONDITION
3 0	4 0	0 No data transfer in progress.
1 1	0 1	1 DEV CMD signal sent to card reader/punch to initiate data transfer.
1 1	1 2	2 DEV FLAG signal received from card reader/punch to indicate that data transfer is complete.
0 1	1 3	3 This counter state is never attained with card reader/punch, except momentarily when passing from 11 to 00.

3. Both bits are 1 when the card reader/punch is on-line and the READY lamp is lighted. Both bits are 0 when off-line or not ready.



CARD READER/PUNCH STATUS WORD FORMATS (Continued)

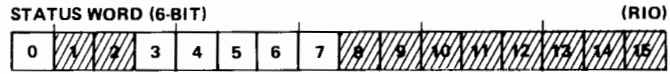

INPUT BUFFER FULL

READ CHECK

INPUT CHECK

OUTPUT CHECK

NOTE: The 6-bit status word is acquired by an RIO instruction. When the instruction is executed, the card reader/punch input memory must be empty.

Peripherals

CARD READER/PUNCH DATA WORD FORMATS

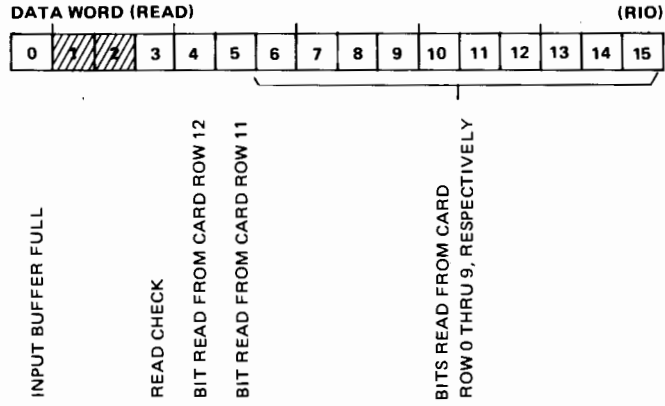

NOTE: When this word is acquired by an RIO instruction, the card reader/punch input memory must not be empty (Bit 0=1).

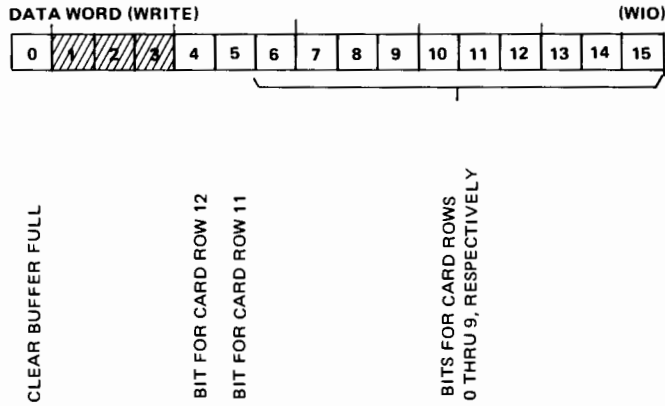



CONNECTIONS BETWEEN CARD READER/PUNCH AND INTERFACE PCA

CARD READER PUNCH			INTERFACE PCA		
SIGNAL ABBREVIATION	SIGNAL NAME	PCA PIN	SIGNAL ABBREVIATION	SIGNAL NAME	PCA PIN
CBF	Clear Buffer Full LO	J14-R	BIT 0	Data Out Bit 0	J3-25
CWS*	Card In Wait Station LO	J14-T	BIT 11*	Status Bit 11	J2-45
FRQ	Feed Request LO	J14-P	BIT 10	Control Bit 10	J1-37
IBF*	Input Buffer Full LO	J14-U	BIT 0*	Data In Bit 0, Input Buffer Full Interrupt	J3-41, J2-47
OBA*, PBA*, IDA*	Output Buffer Available LO, Print Buffer Available LO, Input Data Available LO	J15-d, J15-c, J14-V	DEV FLAG*	Device Flag	J1-3
I00*/PHE*	Input Data 0 LO/Primary Hopper Empty LO	J14-X	BIT 6*	Data In Bit 6	J3-31
I01*/STF*	Input Data 1 LO/Stacker Full LO	J14-N	BIT 7*	Data In Bit 7	J3-29
I02*	Input Data 2 LO	J14-A	BIT 8*	Data In Bit 8	J1-17
I03*	Input Data 3 LO	J14-B	BIT 9*	Data In Bit 9	J1-31
I04*	Input Data 4 LO	J14-D	BIT 10*	Data In Bit 10	J1-27
I05*	Input Data 5 LO	J14-f	BIT 11*	Data In Bit 11	J1-29
I06*	Input Data 6 LO	J14-e	BIT 12*	Data In Bit 12	J1-23
I07*	Input Data 7 LO	J14-d	BIT 13*	Data In Bit 13	J1-25
I08*	Input Data 8 LO	J14-b	BIT 14*	Data In Bit 14	J1-19
I09*	Input Data 9 LO	J14-c	BIT 15*	Data In Bit 15	J1-21
I11*/OCH*	Input Data 11 LO/Output Check LO	J14-a	BIT 5*	Data In Bit 5	J3-35
I12*/ICH*	Input Data 12 LO/Input Check LO	J14-L	BIT 4*	Data In Bit 4	J3-33
LOB, NDR	Load Output Buffer LO, New Data Request LO	J15-U, J14-S	DEV CMD	Device Command	J1-39
O00	Output Data 0 LO	J15-B	BIT 6	Data Out Bit 6	J3-23
O01	Output Data 1 LO	J15-A	BIT 7	Data Out Bit 7	J3-19
O02	Output Data 2 LO	J15-f	BIT 8	Data Out Bit 8	J1-33
O03	Output Data 3 LO	J15-e	BIT 9	Data Out Bit 9	J1-45
O04	Output Data 4 LO	J15-Y	BIT 10	Data Out Bit 10	J1-47
O05	Output Data 5 LO	J15-X	BIT 11	Data Out Bit 11	J1-49
O06	Output Data 6 LO	J15-a	BIT 12	Data Out Bit 12	J1-15
O07	Output Data 7 LO	J15-b	BIT 13	Data Out Bit 13	J1-13

Peripherals

CONNECTIONS BETWEEN CARD READER/PUNCH AND INTERFACE PCA (Con't)

CARD READER PUNCH			INTERFACE PCA		
SIGNAL ABBREVIATION	SIGNAL NAME	PCA PIN	SIGNAL ABBREVIATION	SIGNAL NAME	PCA PIN
O08	Output Data 8 LO	J15-W	BIT 14	Data Out Bit 14	J1-43
O09	Output Data 9 LO	J15-Z	BIT 15	Data Out Bit 15	J1-41
O11	Output Data 11 LO	J15-H	BIT 5	Data Out Bit 5	J3-21
O12/IIF	Output Data 12 LO/Inhibit Input Feed LO	J15-V	BIT 4	Data Out Bit 4	J3-3
PR1	Print LO	J15-P	BIT 7	Control Bit 7	J3-9
PUN	Punch LO	J15-N	BIT 8	Control Bit 8	J3-7
REA*	Ready LO	J14-K	BIT 9*, BIT 10*	Status Bit 9, Status Bit 10	J1-11, J1-9
RFC*	Ready for Command LO	J14-W	BIT 8*	Status Bit 8	J1-1
SCM	Stacker Control Mode LO	J14-F	BIT 1	Data Out Bit 1	J3-15
SHE*	Secondary Hopper Empty LO	J15-S	BIT 12	Status Bit 12	J3-27
SPD	Separate Print Data LO	J15-J	BIT 9	Control Bit 9	J2-41
SST	Select Stacker Two LO	J14-J	BIT 2	Data Out Bit 2	J3-1
--	(Not connected)	--	W2	Jumper 2, Jumper 2	J2-9, J2-10
--	(Not connected)	--	W4	Jumper 4, Jumper 4	J2-13, J2-14
--	(Not connected)	--	W5	Jumper 5, Jumper 5	J2-15, J2-16
--	(Not connected)	--	W6	Jumper 6, Jumper 6	J2-21, J2-22
--	(Not connected)	--	W7	Jumper 7, Jumper 7	J2-35, J2-36
--	(Not connected)	--	W8	Jumper 8, Jumper 8	J2-37, J2-38
--	(Not connected)	--	SDE	Control Bit 6, Device End	J3-5, J2-49

Notes: An asterisk indicates signal origin is in card reader punch. Otherwise, signal origin is in the interface PCA.

In the PCA PIN columns, a comma indicates connection (in the plug) to the pin listed on the line beneath.

Each signal in this table has a signal-return wire. The return wire is connected to the pin matching that listed for the signal. Matching pins are on opposite sides of the PCA. For instance, the return wire for signal SST connects to pin J14-8 in the card reader punch. The other end of the same return wire connects to J3-2 on the interface PCA. On the card reader punch the return wires connect to *numbered* pins. On the interface PCA the return wires connect to *even*-numbered pins.

2895A PAPER TAPE PUNCH SUBSYSTEM CONNECTIONS

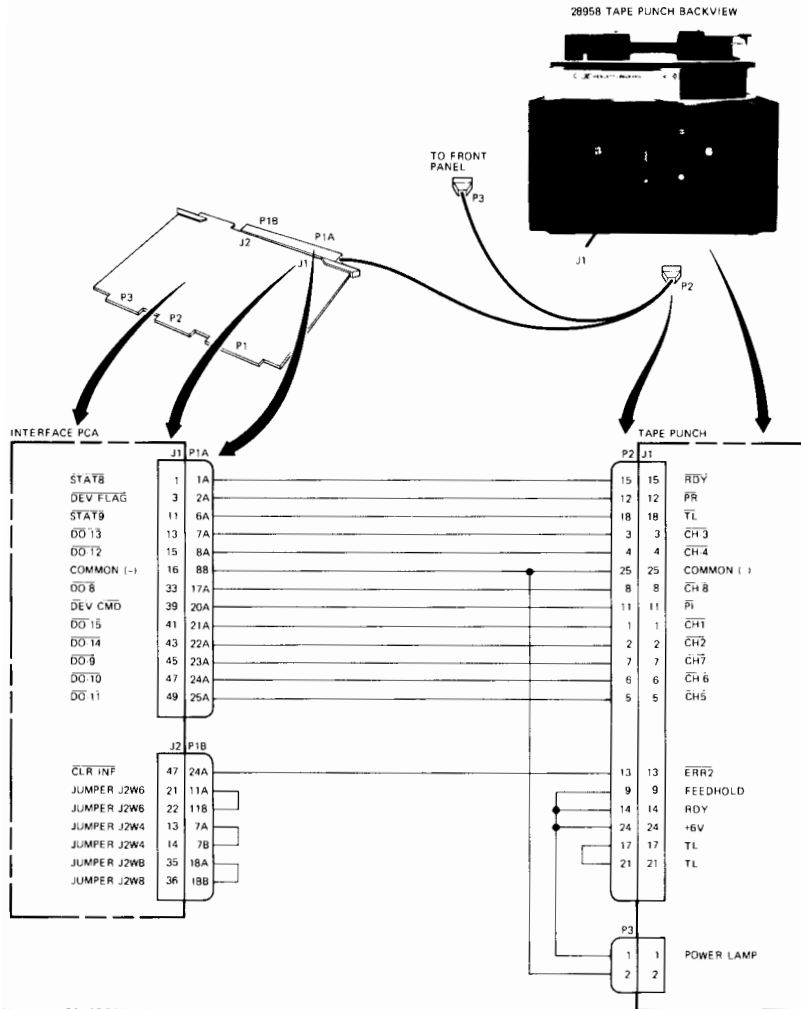

Note: INTERFACE PCA J1 PINS 2, 4, 12, 14, 16, 34, 40, 42, 44, 46, 48 AND 50 ARE TIED TOGETHER TO COMMON (-). ONLY PIN 16 IS SHOWN FOR SIMPLICITY.

Peripherals

PAPER TAPE PUNCH INTERFACE PCA JUMPER AND SWITCH LOCATIONS

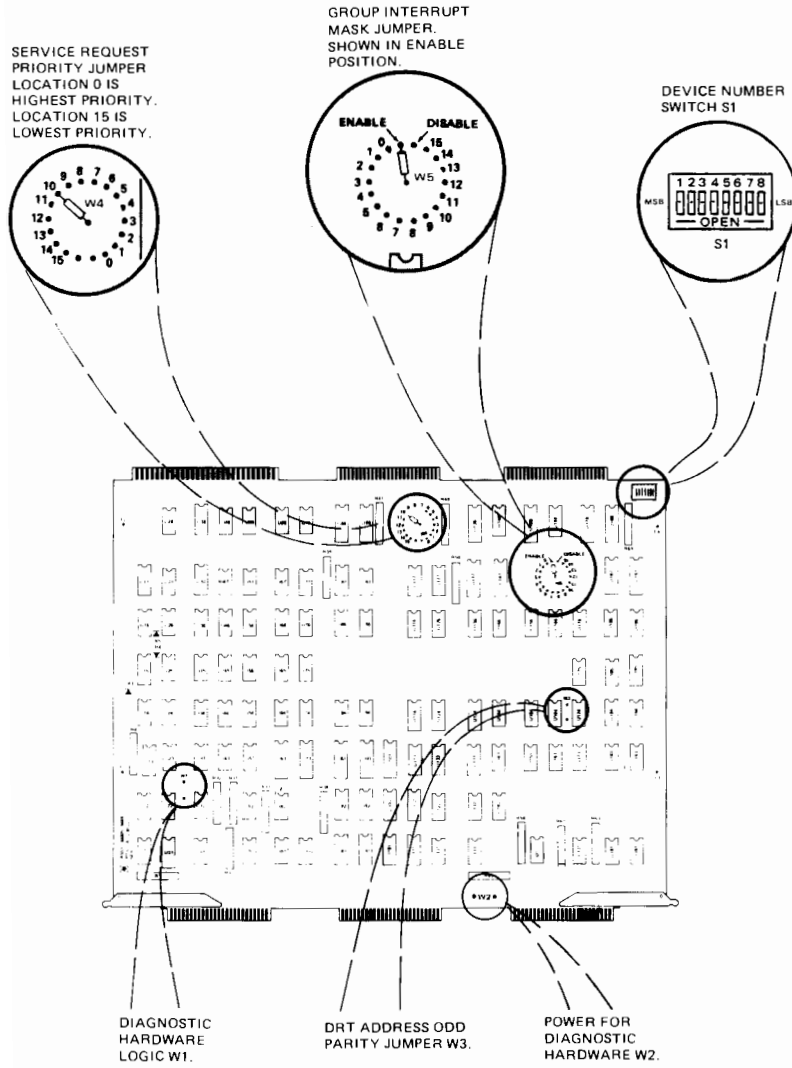

PAPER TAPE PUNCH CONTROL WORD FORMAT

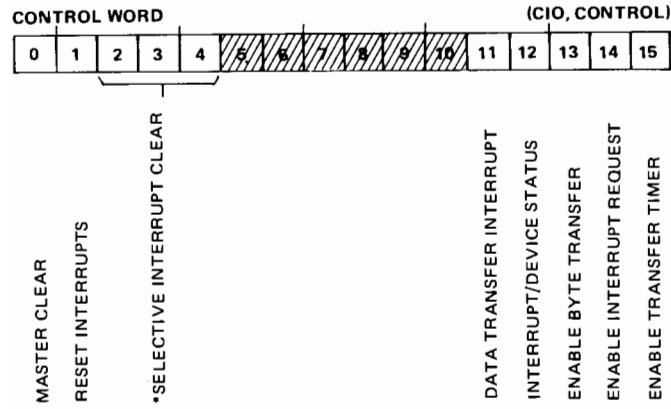

\*SELECTIVE INTERRUPT CLEAR

2	3	4
---	---	---

- 0 0 0 INACTIVE STATE – NO ACTION.
- 0 0 1 TRANSFER TIMER AND TRANSFER ERROR – INTERRUPT STATUS BITS 15 AND 14.
- 0 1 0 I/O SYSTEM, INTERRUPT STATUS BIT 13.
- 0 1 1 CLEAR INTERFACE – INTERRUPT STATUS BIT 12.
- 1 0 0 DATA TRANSFER – INTERRUPT STATUS BIT 11.
- 1 0 1 DEVICE STATUS BIT 8 – INTERRUPT STATUS BIT 8.
- 1 1 0 DEVICE STATUS BIT 9 – INTERRUPT STATUS BIT 9.
- 1 1 1 DEVICE STATUS BIT 10 – NOT USED.

Peripherals

PAPER TAPE PUNCH STATUS WORD FORMATS

INTERRUPT STATUS WORD (TIO, SENSE, END)

0	1	2	3	4	5	6	7	8	9	10	11	12	13	14	15
---	---	---	---	---	---	---	---	---	---	----	----	----	----	----	----

SIO OK  
 RIO/WIO OK  
 INTERRUPT REQUEST  
 SEQUENCE FLIP-FLOP 1  
 SEQUENCE FLIP-FLOP 2  
 DEVICE FLAG  
 INTERRUPT STATUS=0  
 POWER ON  
 TAPE SUPPLY LOW  
 DATA TRANSFER INTERRUPT  
 \*CLEAR INTERFACE INTERRUPT  
 I/O SYSTEM INTERRUPT  
 TRANSFER ERROR INTERRUPT  
 TRANSFER TIMER INTERRUPT

\*BIT 12 = 1 INDICATES A TAPE PROBLEM - BINDING, SLACK, OR BROKEN

DEVICE STATUS WORD (TIO, SENSE, END)

0	1	2	3	4	5	6	7	8	9	10	11	12	13	14	15
---	---	---	---	---	---	---	---	---	---	----	----	----	----	----	----

SIO OK  
 RIO/WIO OK  
 INTERRUPT REQUEST  
 SEQUENCE FLIP-FLOP 1  
 SEQUENCE FLIP-FLOP 2  
 DEVICE FLAG  
 DEVICE STATUS=1  
 POWER ON  
 TAPE SUPPLY LOW



7905A/7920A/7925A DISC DRIVE DATA CABLE CONNECTIONS

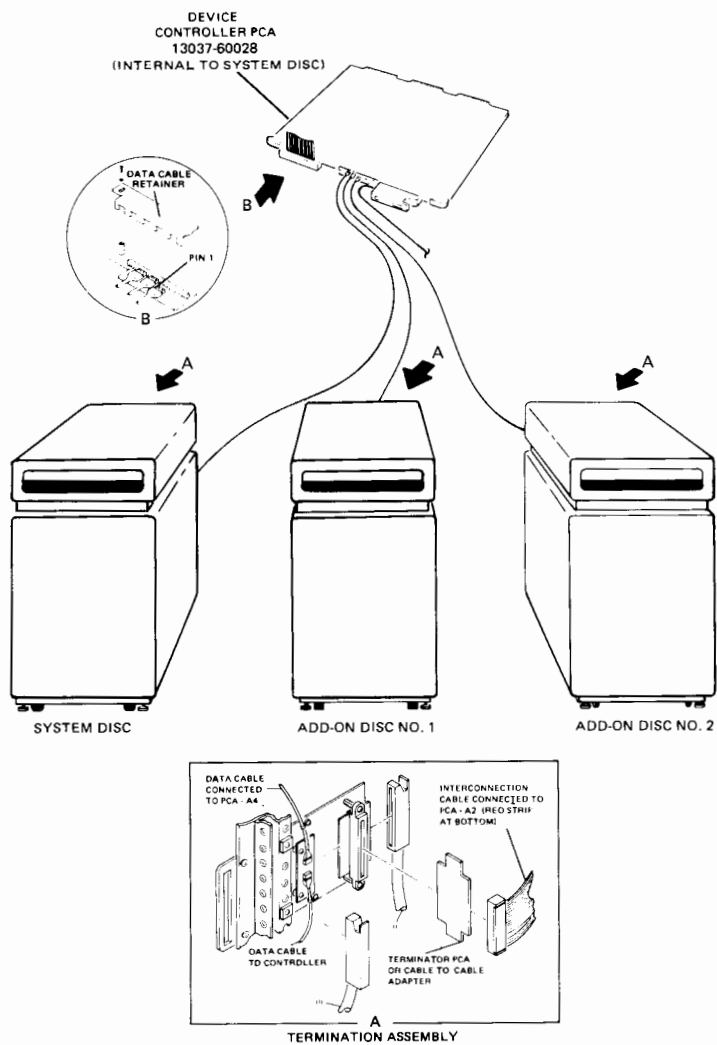

Reference: SIM

DISC DRIVE MULTI-UNIT CABLE CONNECTIONS

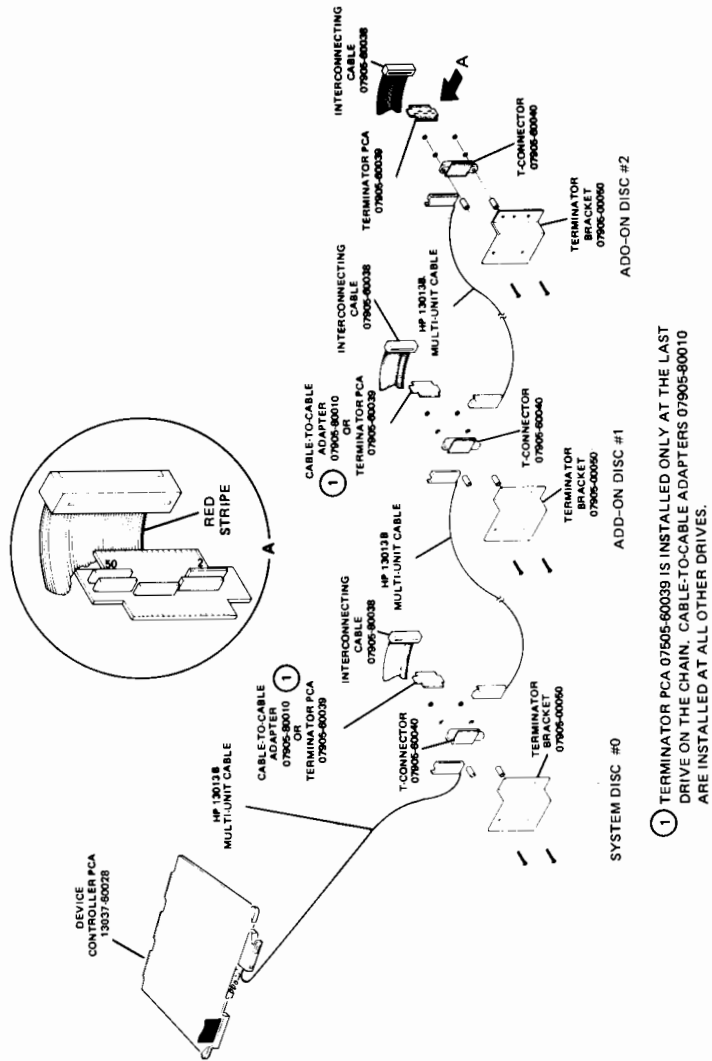

Reference: SIM

DISC DRIVE INTERFACE PCA JUMPER AND SWITCH LOCATIONS

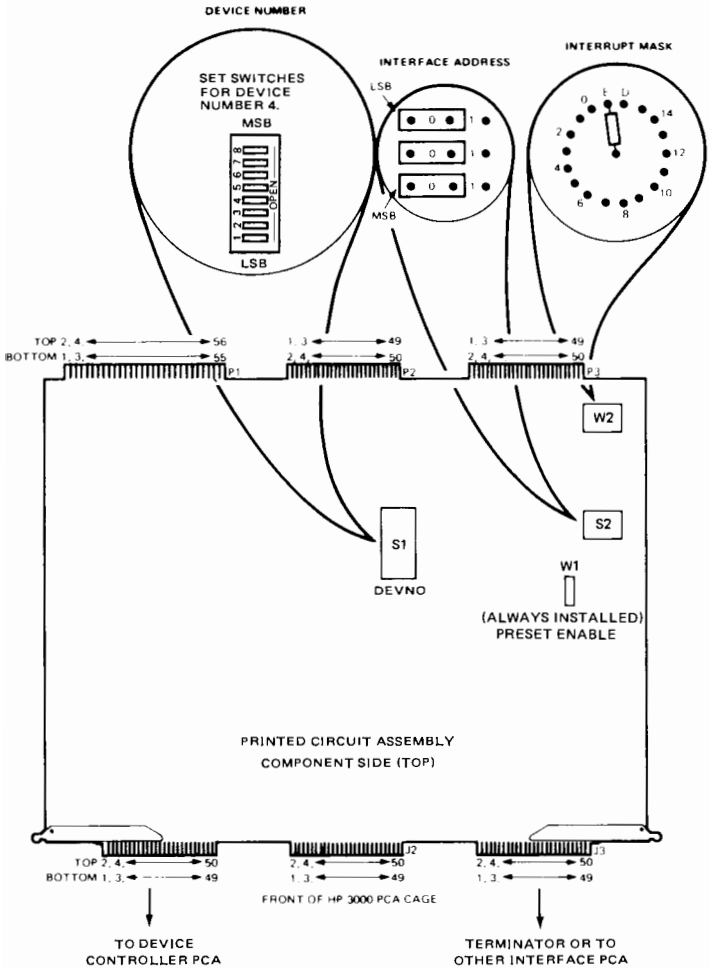

Peripherals

DISC DRIVE SUBTYPE LIST

SUBTYPE	USER
4	7905 Removable Platter
5	7905 Fixed Platter
6	7905 Cylinder Mode
7	7905 FHD Replacement (120 cylinders only)
8	7920 Cylinder Mode Only
9	7925 Cylinder Mode Only

DISC DRIVE SUBTYPE PARAMETERS

SUBTYPE	4	5	6	7	8	9
SEC/CYL	96	48	144	144	240	576
HEADBASE	0	%1000	0	0	0	0
FILEMASK	%7426	%7425	%7427	%7427	%7427	%7427

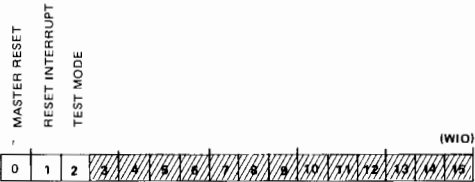

Diagnostic Uses W10 to load/check Data Buffer Reg.  
 Note: Data Buffer Reg. is used for Data or Status.

**DISC DRIVE CONTROL WORD FORMAT**

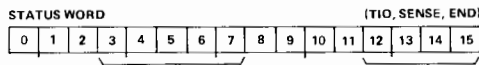

**\*ENCODED TERMINATION STATUS**

3	4	5	6	7
---	---	---	---	---

- 0 0 0 0 0 NORMAL COMPLETION
- 0 0 0 0 1 ILLEGAL OPCODE < %26
- 0 0 0 1 0 SET WAKEUP
- 0 0 1 1 1 CYLINDER COMPARE ERROR } TRACK
- 0 1 0 0 0 UNCORRECTABLE DATA ERROR } SPECIFIC
- 0 1 0 0 1 HEAD-SECTOR COMPARE ERROR } ERRORS
- 0 1 0 1 0 I/O PROGRAM ERROR
- 0 1 1 0 0 END OF CYLINDER
- 0 1 1 1 0 OVERRUN (TRANSFER ERROR)
- 0 1 1 1 1 POSSIBLY CORRECTABLE DATA ERROR
- 1 0 0 0 0 ILLEGAL ACCESS TO SPARE TRACK
- 1 0 0 0 1 DEFECTIVE TRACK
- 1 0 0 1 0 ACCESS NOT READY DURING DATA OPERATION (HEADS STILL MOVING)
- 1 0 0 1 1 STATUS-2 ERROR
- 1 0 1 1 0 WRITE ATTEMPT TO PROTECTED OR DEFECTIVE TRACK
- 1 0 1 1 1 UNIT UNAVAILABLE
- 1 1 1 1 1 DRIVE ATTENTION (SEEK COMPLETE)

**DISC DRIVE STATUS WORD FORMAT**

Peripherals

STATUS-1 WORD

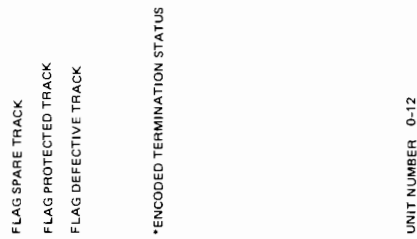
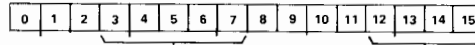

\* ENCODED TERMINATION STATUS

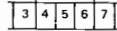

0 0 0 0 0	NORMAL COMPLETION	
0 0 0 0 1	ILLEGAL OP CODE < %26	
0 0 0 1 0	SET WAKEUP	
0 0 1 1 1	CYLINDER COMPARE ERROR	} TRACK SPECIFIC ERRORS
0 1 0 0 0	UNCORRECTABLE DATA ERROR	
0 1 0 0 1	HEAD-SECTOR COMPARE ERROR	
0 1 0 1 0	I/O PROGRAM ERROR	
0 1 1 0 0	END OF CYLINDER	
0 1 1 1 0	OVERRUN (TRANSFER ERROR)	
0 1 1 1 1	POSSIBLY CORRECTABLE DATA ERROR	
1 0 0 0 0	ILLEGAL ACCESS TO SPARE TRACK	
1 0 0 0 1	DEFECTIVE TRACK	
1 0 0 1 0	ACCESS NOT READY DURING DATA OPERATION (HEADS STILL MOVING)	
1 0 0 1 1	STATUS-2 ERROR	
1 0 1 1 0	WRITE ATTEMPT TO PROTECTED OR DEFECTIVE TRACK	
1 0 1 1 1	UNIT UNAVAILABLE	
1 1 1 1 1	DRIVE ATTENTION (SEEK COMPLETE)	

DISC DRIVE STATUS - 1 WORD FORMAT

STATUS - 2 WORD (REQUEST STATUS)  
 (STATUS - 1 WORD IS SAME AS STATUS WORD BITS 3-15)

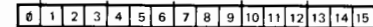

STATUS - 2 ERROR (ANY * TRUE)	DRIVE TYPE		0 ATTENTION PROTECTED FORMAT * FAULT (SEE NOTE) INVALID CYL. ADR. INVALID HD. ADR. INVALID SECT. ADR. MULTIPLE SEEKS * DRIVE NOT READY * DRIVE BUSY
	TYPE	BITS 1-6	
	7905	02	
	7906	00	
	7920	01	
7925	03		

DISC DRIVE STATUS - 2 WORD FORMAT

DISC DRIVE COMMAND DESCRIPTIONS

	0	7	10	15	(SIO)											
000	0	0	0	0	0	H	S	E	C	T	O	R	COLD LOAD READ			
001	0	0	0	0	0	0	1	H	U	N	I	T	N	O.	RECALIBRATE *	
002	0	0	0	0	0	0	1	0	H	U	N	I	T	N	O.	SEEK *
003	0	0	0	0	0	0	1	1	/	U	N	I	T	N	O.	REQUEST STATUS
004	0	0	0	0	0	0	1	0	/	U	N	I	T	N	O.	REQUEST SECTOR ADDRESSES
005	0	0	0	0	0	1	0	1	/	U	N	I	T	N	O.	READ
006	0	0	0	0	0	1	1	0	H	U	N	I	T	N	O.	READ FULL SECTOR
007	0	0	0	0	0	1	1	1	H	U	N	I	T	N	O.	VERIFY
010	0	0	0	0	1	0	0	0	H	U	N	I	T	N	O.	WRITE
011	0	0	0	0	1	0	0	1	H	U	N	I	T	N	O.	WRITE FULL SECTOR
012	0	0	0	0	1	0	1	0	/	/	/	/	/	/	/	CLEAR
013	0	1	2	3	7	9	15									INITIALIZE
	S	P	D	0	1	0	1	1	H	U	N	I	T	N	O.	
014	0	0	0	0	1	1	0	0	/	/	/	/	/	/	/	ADDRESS RECORD

\*13037A Will Disconnect After Execution.

Peripherals

DISC DRIVE COMMAND DESCRIPTIONS (Continued)

(SIO)

015	0 7 0 0 0 0 1 1 0 1	REQUEST SYNDROME
016	0 7 9 15 0 0 0 0 1 1 1 0 H U N I T N O.	READ WITH OFFSET
017	0 7 12 13 14 15 0 0 0 0 1 1 1 1 R E T R Y C O U N T 1/2 S S A C S	SET FILE MASK
020	0 7 9 15 0 0 0 1 0 0 0 0 U N I T N O.	CLEAR UNIT BUSY
021	0 7 9 15 0 0 0 1 0 0 0 1 U N I T N O.	REQUEST UNIT ALLOCATION
022	0 7 9 15 0 0 0 1 0 0 1 0 H U N I T N O.	READ WITHOUT VERIFY
023	0 7 0 0 0 1 0 0 1 1	LOAD TIO REGISTER
024	0 7 0 0 0 1 0 1 0 0	REQUEST DISC ADDRESS
025	0 7 0 0 0 1 0 1 0 1	POLL DISCONNECT*
026	0 7 9 15 0 0 0 1 0 1 1 0 U N I T N O.	WAKEUP

\*13037A Will Disconnect After Execution.



7970B/E MAGNETIC TAPE DRIVE INTERFACE PCA  
POSITION AND CONNECTOR DETAILS

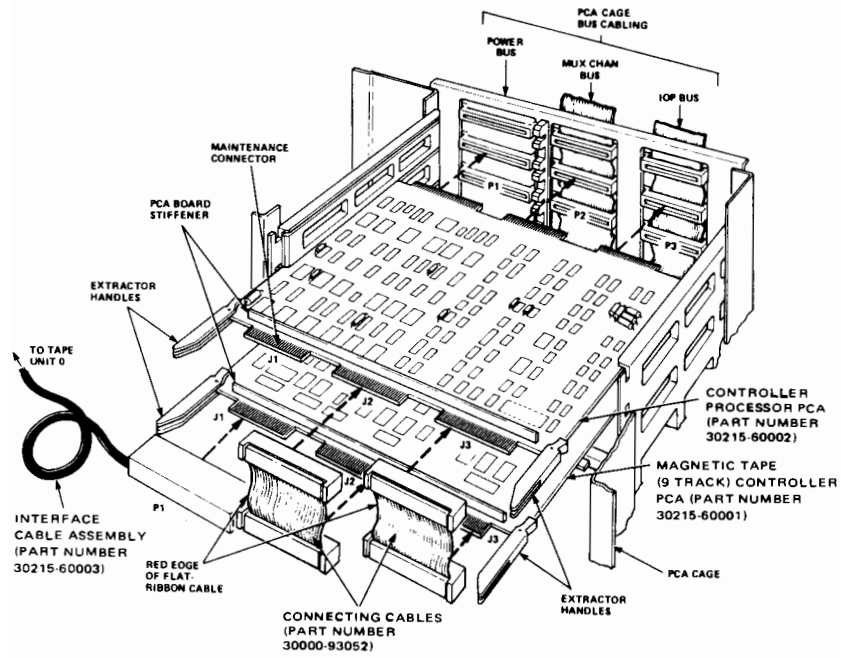

NOTES: 1. VIEW FROM FRONT OF CABINET.  
2. VERTICAL SPACING EXAGGERATED FOR ILLUSTRATION CLARITY.

Peripherals

MAGNETIC TAPE DRIVE MASTER UNIT (7970E) CABLE CONNECTIONS

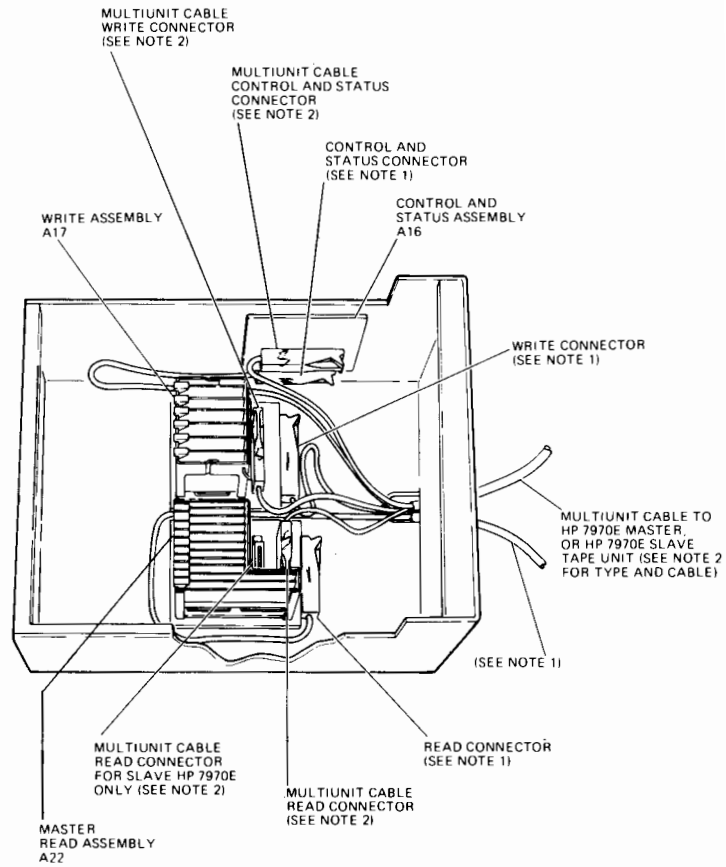

- NOTES
- 1 IF THE HP 7970E MASTER TAPE UNIT SHOWN IS UNIT 0, THIS WILL BE INTER FACE CABLE PART NO. 30215 60003. OTHERWISE IT WILL BE AN HP 13194A MULTIUNIT CABLE COMING FROM HP 7970B OR ANOTHER HP 7970E MASTER TAPE UNIT.
  - 2 IF THE FOLLOWING UNIT IS ANOTHER HP 7970E MASTER TAPE UNIT, THIS CABLE WILL BE AN HP 13194A MULTIUNIT CABLE WITH READ CONNECTOR INSTALLED AS SHOWN. IF FOLLOWING UNIT IS AN HP 7970E SLAVE TAPE UNIT, THIS MUST BE AN HP 13194A 001 MULTIUNIT CABLE WITH READ CON NECTOR INSTALLED IN SLAVE READ POSITION AS DESIGNATED IN DRAWING.

MAGNETIC TAPE DRIVE SLAVE UNIT (7970E) CABLE CONNECTIONS

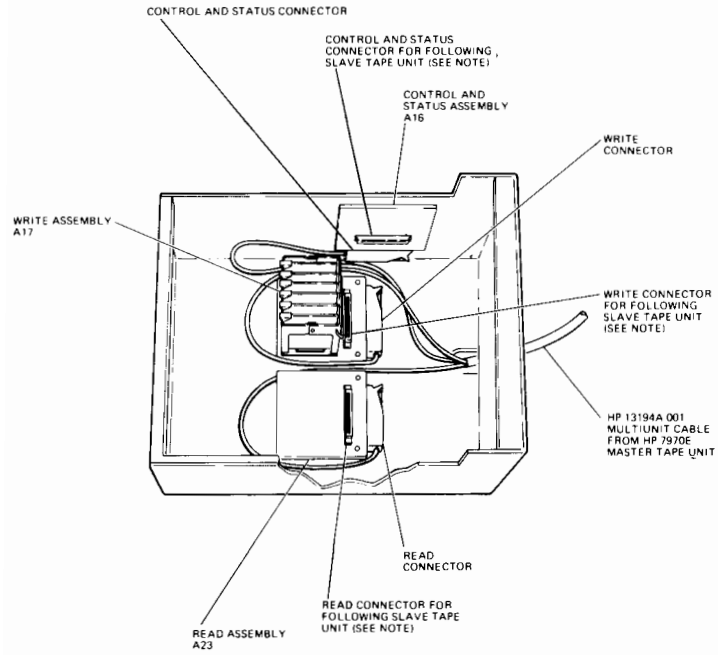

NOTE IF ADDITIONAL HP 7970E SLAVE TAPE UNIT IS USED, HP 13194A 001 MULTIUNIT CABLE MUST BE USED TO CONNECT TO THE FOLLOWING UNIT.

Peripherals

MAGNETIC TAPE DRIVE CONTROLLER PCA JUMPER AND SWITCH LOCATIONS

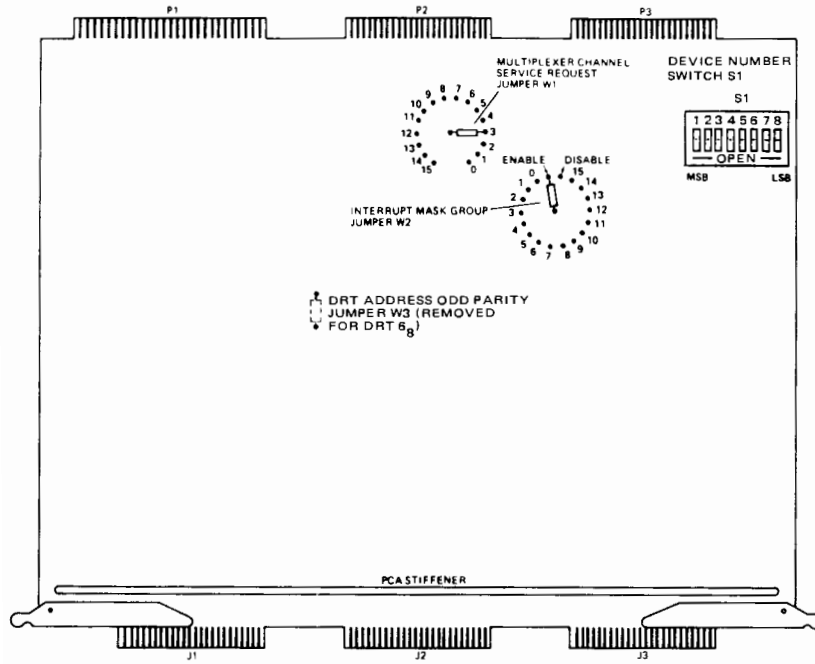

MAGNETIC TAPE DRIVE CONTROL WORD (P CONT STB) FORMAT

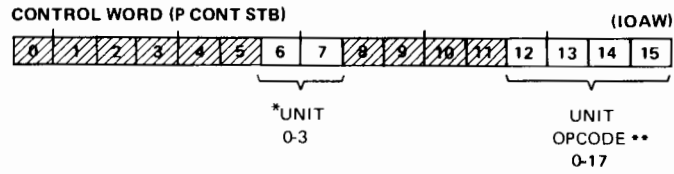
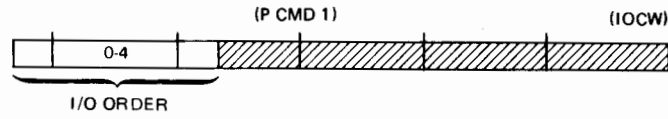

\*Used for a 'Unit Select' opcode only

\*\* UNIT OPCODE

	12	13	14	15	
SEL	0	0	0	0	UNIT SELECT
WRR	0	1	0	0	WRITE RECORD
GAP	0	1	0	1	WRITE GAP
RDR	0	1	1	0	READ RECORD
FSR	0	1	1	1	FORWARD SPACE RECORD
REW	1	0	0	0	REWIND
RST	1	0	0	1	REWIND AND RESET (OFF LINE)
BSR	1	0	1	0	BACKSPACE RECORD
BSF	1	0	1	1	BACKSPACE FILE
ΔWRZ	1	1	0	0	WRITE RECORD WITH ZERO PARITY
WFM	1	1	0	1	WRITE FILE MARK
ΔRDC	1	1	1	0	READ RECORD WITH CRCC
FSF	1	1	1	1	FORWARD SPACE FILE

ΔUsed for diagnosing purposes.

Peripherals

MAGNETIC TAPE DRIVE STATUS WORD FORMAT

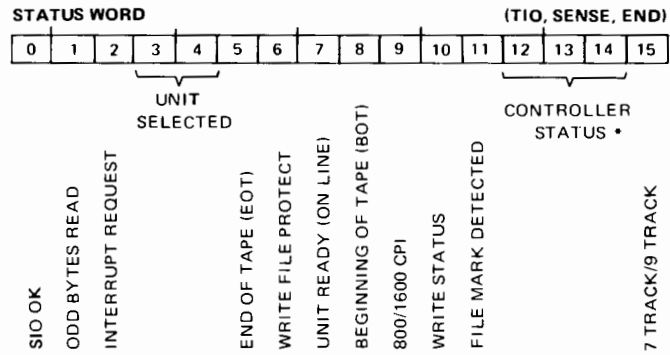

\* CONTROLLER STATUS

12	13	14
----	----	----

0	0	0	UNIT READY TO READY INTERRUPT
0	0	1	TRANSFER ERROR
0	1	0	COMMAND REJECTED
0	1	1	TAPE RUNAWAY (25 FEET)
1	0	0	TIMING ERROR
1	0	1	TAPE ERROR (PARITY, CRC, etc.)
1	1	1	ERROR FREE

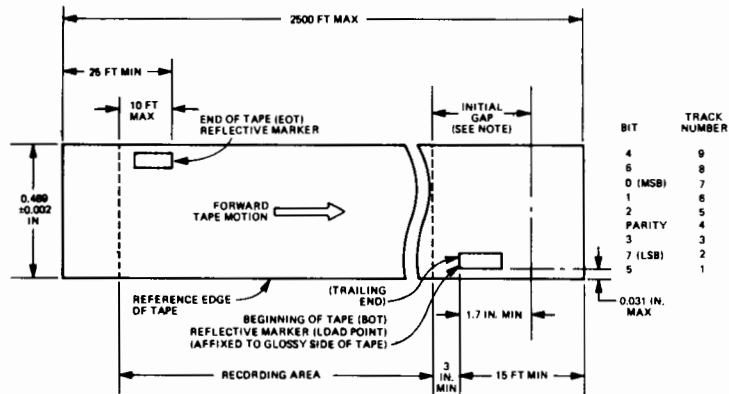

NOTE: IN THIS SUBSYSTEM THE GAP IS 3.75 IN. LONG.

TAPE FORMAT FOR 800 BPI TAPE

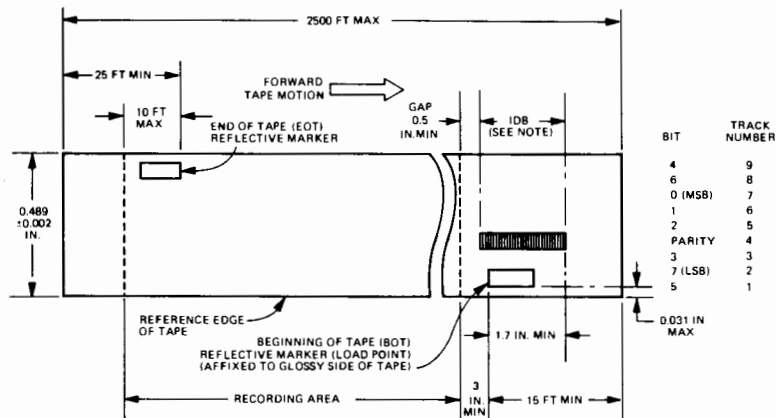

NOTE: IN THIS SUBSYSTEM THE IDENTIFICATION BURST (IDB) IS 2 IN. LONG FOLLOWED BY A GAP (RESET FLUX STATE AREA) OF 3.75 IN.

TAPE FORMAT FOR 1600 BPI TAPE

Peripherals

30032B/30061A ASYNCHRONOUS TERMINAL CONTROLLER  
SUBSYSTEM BLOCK DIAGRAM

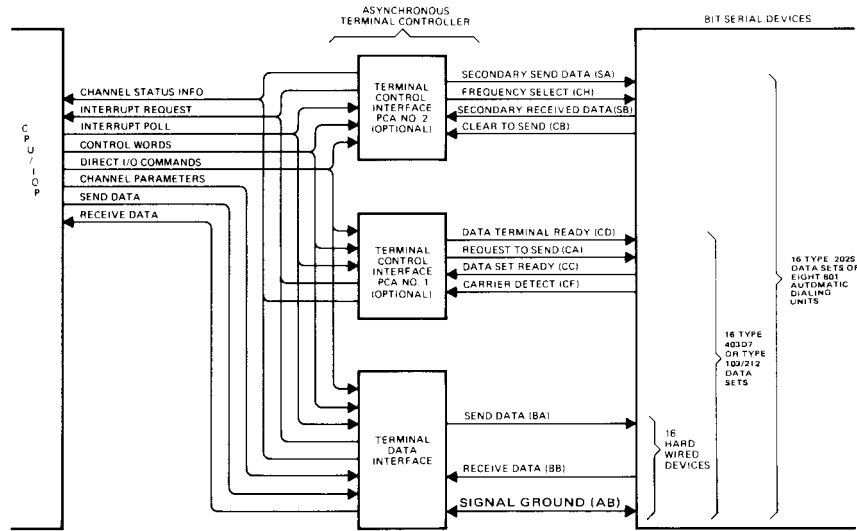



ASYNCHRONOUS TERMINAL CONTROLLER INTERCONNECTION DIAGRAM

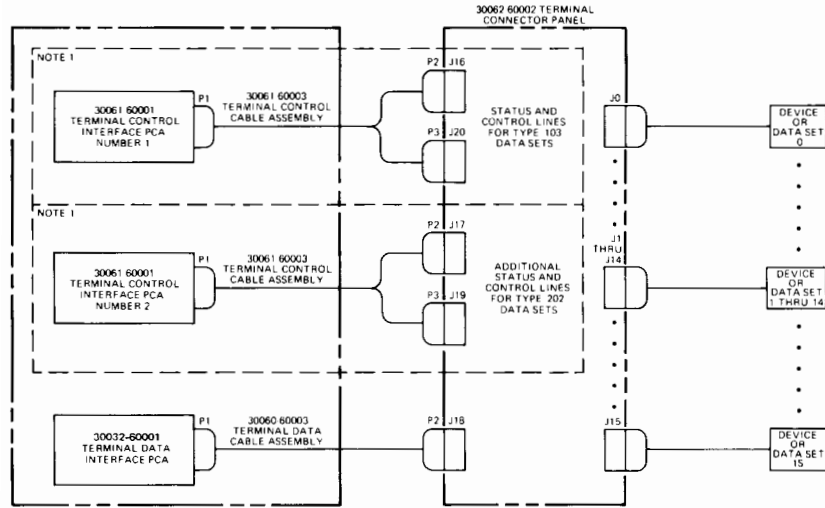

NOTES:

1. ONE TERMINAL CONTROL INTERFACE PCA ADDED BY 30032B-001 AND TWO PROVIDED BY 30032B-002.
2. THE ASYNCHRONOUS TERMINAL CONTROLLER TEST CABLE PART NO. 30062-60004 IS CONNECTED BETWEEN ANY TWO DEVICE CONNECTORS J0 THRU J15 TO PROVIDE A LOOP WHEN RUNNING DIAGNOSTICS.

Peripherals

ASYNCHRONOUS TERMINAL CONTROLLER TDI PCA  
CONNECTOR NUMBERING SCHEME

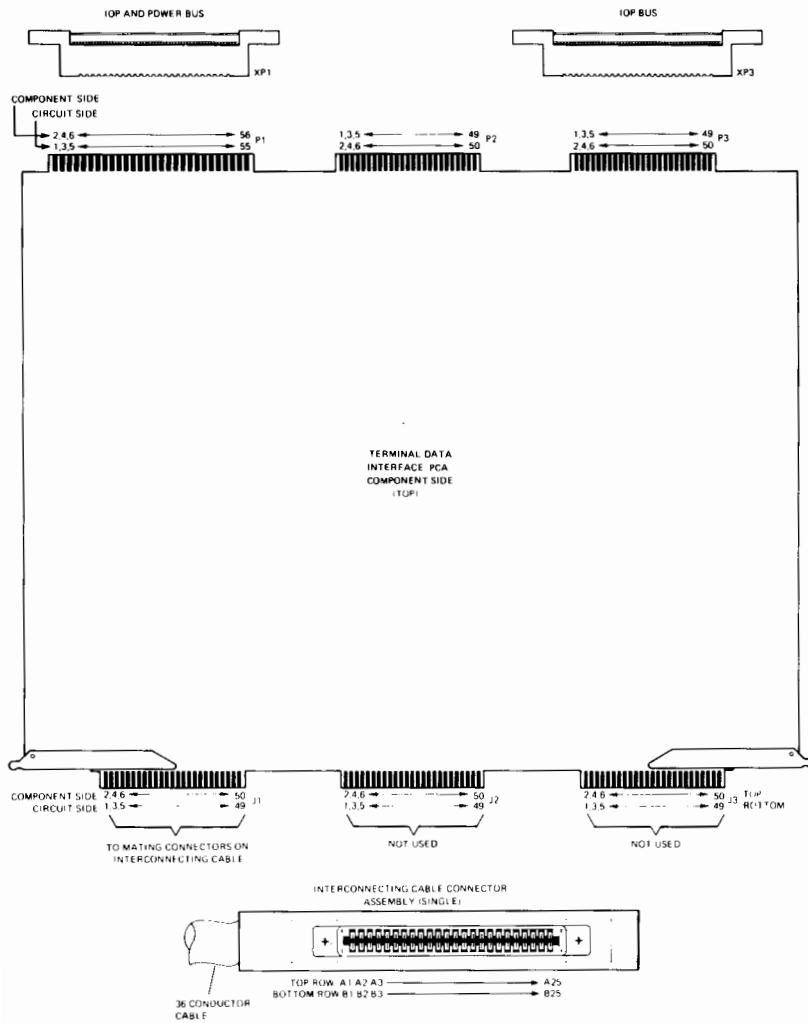

Peripherals

ASYNCHRONOUS TERMINAL CONTROLLER TCI PCA  
CONNECTOR NUMBERING SCHEME

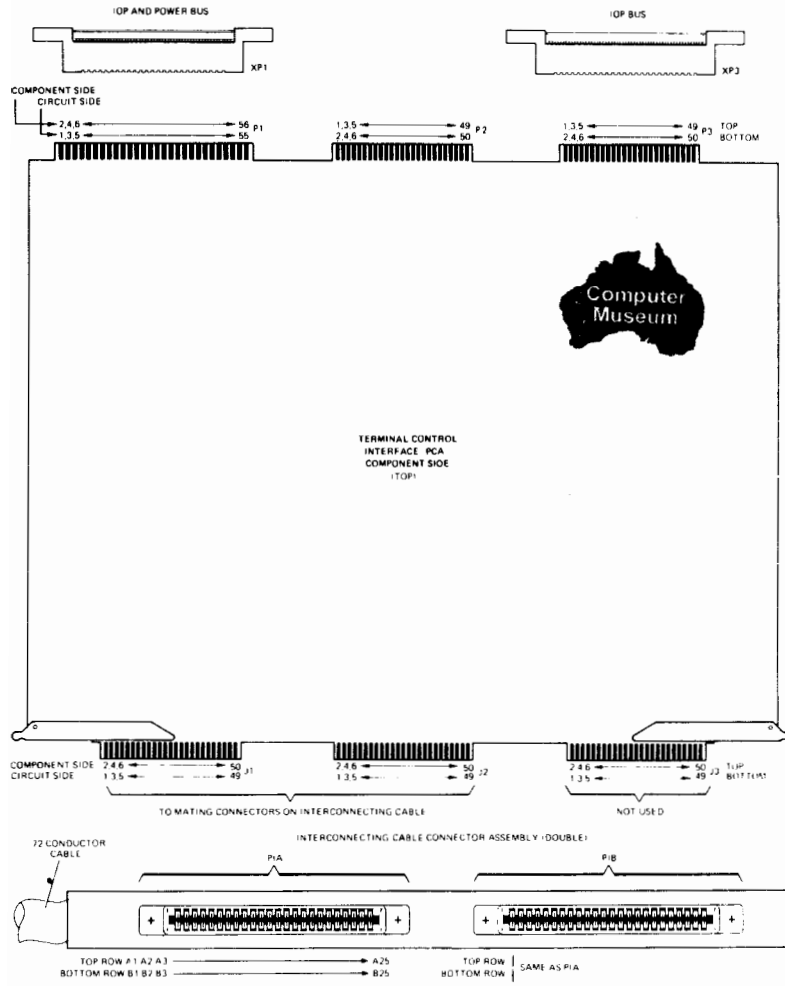

147006-97

TDI PCA JUMPER AND SWITCH LOCATIONS

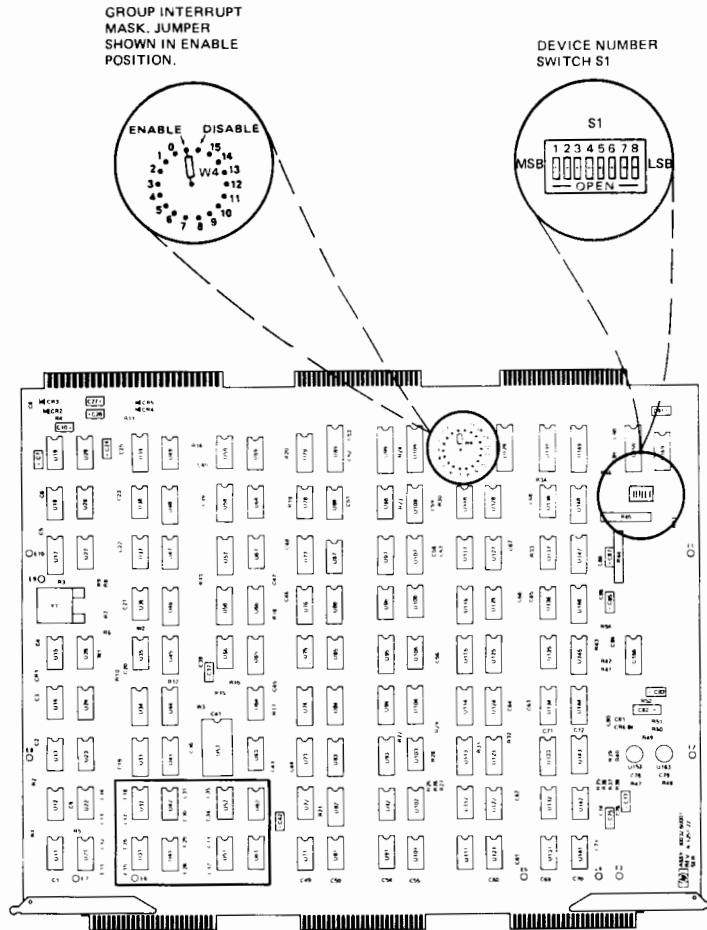

- NOTES:
1. JUMPERS W1, W2, AND W3 ARE FOR FACTORY USE ONLY.
  2. THERE IS NO PARITY JUMPER LOCATED ON THIS PCA.
  3. ON PCAs WITH DATE CODE 2002 OR NEWER, UNITS 31, 32, 41, 42, 51, 52, 61 AND 62 (SHOWN BOXED-IN) ARE ON SOCKETS, AS A LIGHTNING-PROTECTION MEASURE. PAGE 8-52A SHOWS WHICH OF THESE UNITS MAY BE CAUSING A FAILURE OF A PERIPHERAL CONNECTED TO THE MUX PANEL.

147006-98

## TDI PCA Chips Related to MUX Panel Ports

If a peripheral connected to one of the ports on the MUX Panel fails, you may begin troubleshooting by matching the part with the TDI PCA Unit shown below, and replacing the Unit with a new chip. (The Units are on sockets, as shown on page 8-52.)

FAILED PORT ON MUX PANEL	TDI PCA CHIP PART NUMBER							
	1820-0509				1820-0990			
	U31	U32	U41	U42	U51	U52	U61	U 62
0,1	X					X		
2,3,4,5		X			X			
6,7	X					X		
8,9			X					X
10,11,12,13				X			X	
14,15			X					X

## Peripherals

### MUX Panel TranZorb Locations

This illustration shows the locations of the TranZorbs (diodes) on the MUX Panel (30032-60007) of all Series III systems that shipped starting in February 1980. To replace one of the diodes, use part number 1902-0976, orderable from CPC.

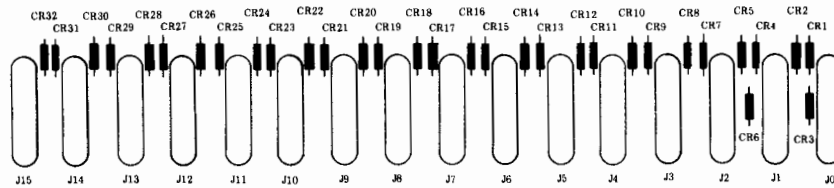

047006-109

MUX Panel TranZorbs Related to Connectors

J0-2 in CR1	J8-2 in CR17
-3 out CR3	-3 out CR18
J1-2 in CR2	J9-2 in CR19
-3 out CR4	-3 out CR20
J2-2 in CR6	J10-2 in CR21
-3 out CR5	-3 out CR22
J3-2 in CR7	J11-2 in CR23
-3 out CR8	-3 out CR24
J4-2 in CR9	J12-2 in CR25
-3 out CR10	-3 out CR26
J5-2 in CR11	J13-2 in CR27
-3 out CR12	-3 out CR28
J6-2 in CR13	J14-2 in CR29
-3 out CR14	-3 out CR30
J7-2 in CR15	J15-2 in CR31
-3 out CR16	-3 out CR32

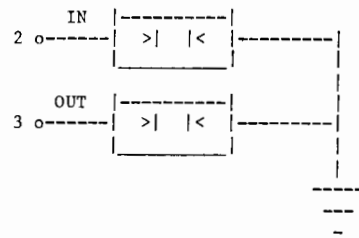

Peripherals

MAR 1980

8-52D

I



TCI PCA JUMPER AND SWITCH LOCATIONS

GROUP INTERRUPT MASK JUMPER. SHOWN IN ENABLE POSITION.

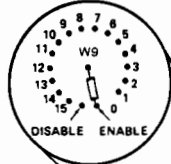

DEVICE NUMBER SWITCH S1

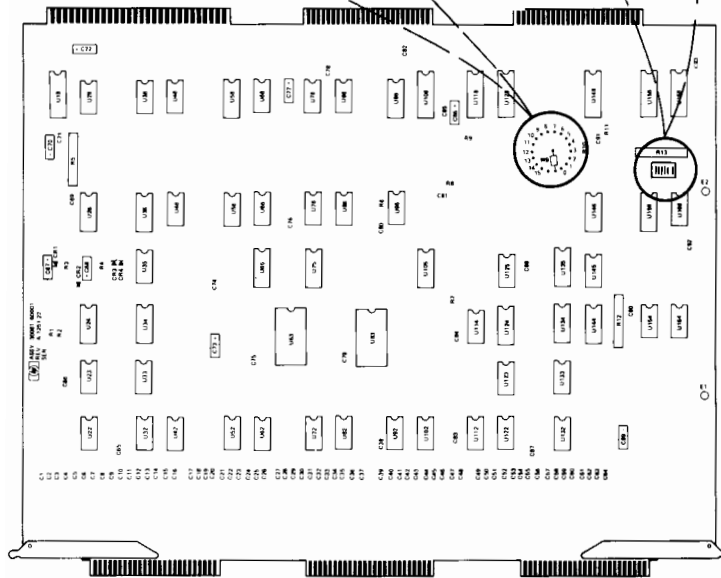
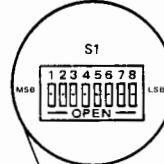

NOTE: THERE IS NO PARITY JUMPER LOCATED ON THIS PCA.

Peripherals

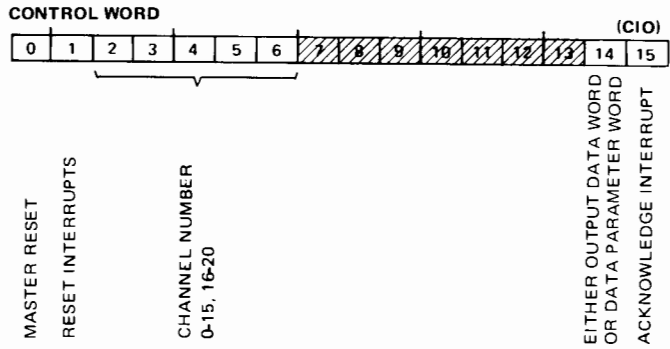

TDI CONTROL WORD FORMAT

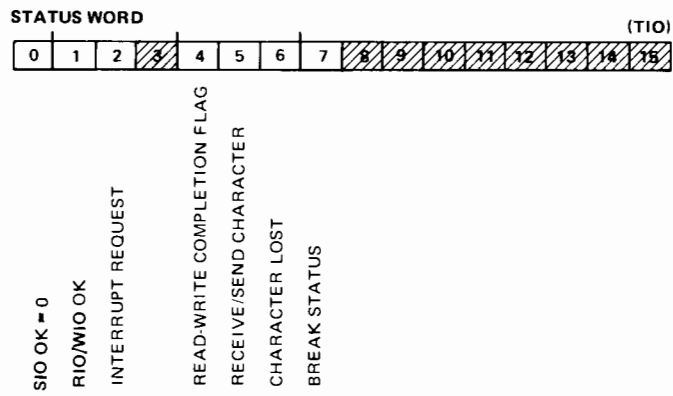

TDI STATUS WORD FORMAT

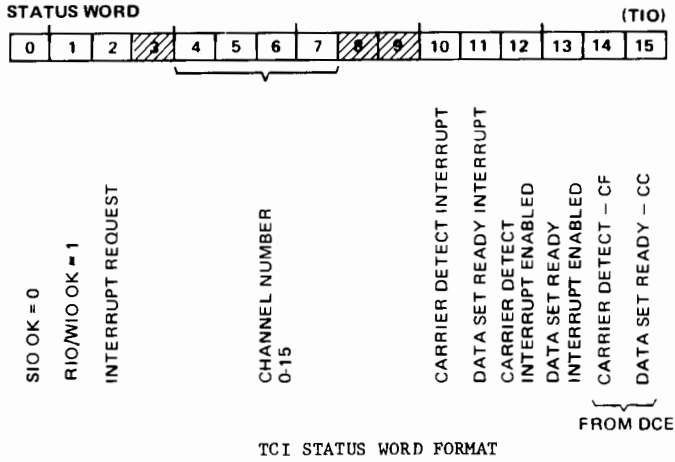
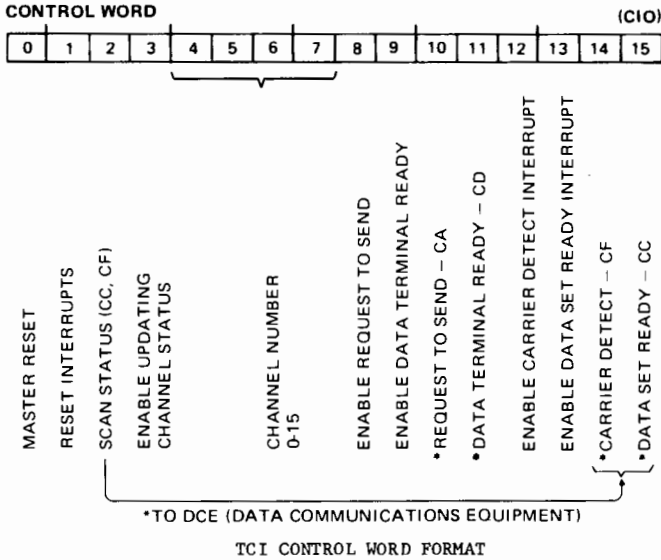

Peripherals

ASYNCHRONOUS TERMINAL CONTROLLER RS232C SIGNAL DESCRIPTIONS

PIN NO.	CIRCUIT	SIGNAL DESCRIPTION	GND	DATA		CONTROL		TIMING	
				FROM DCE	TO DCE	FROM DCE	TO DCE	FROM DCE	TO DCE
1	AA	Protective Ground Signal Ground/Common Return	X						
7	AB		X						
2	BA	Transmitted Data			X				
3	BB	Received Data		X					
4	CA	Request to Send					X		
5	CB	Clear to Send				X			
6	CC	Data Set Ready				X			
20	CD	Data Terminal Ready					X		
22	CE	Ring Indicator				X			
8	CF	Carrier Detect				X			
21	CG	Signal Quality Director				X			
23	CH	Data Signal Rate Selector (DTE)					X		
23	CI	Data Signal Rate Selector (DCE)				X			
24	DA	Transmitter Signal Ele- ment Timing (DTE)							X
15	DB	Transmitter Signal Ele- ment Timing (DCE)						X	
17	DD	Receiver Signal Ele- ment Timing (DCE)						X	
14	SBA	Secondary Transmitted Data			X				
16	SBB	Secondary Received Data		X					
19	SCA	Secondary Request to Send					X		
13	SCB	Secondary Clear to Send				X			
12	SCF	Secondary Carrier Detect				X			
9	-	(Reserved for Data Set Timing)							
10	-	(Reserved for Data Set Timing)							
11	-	Unassigned							
18	-	Unassigned							
25	-	Unassigned							

DTE (Data Terminal Equipment)  
DCE (Data Communications Equipment)

ASYNCHRONOUS TERMINAL CONTROLLER MODEM CABLE PIN CONNECTIONS

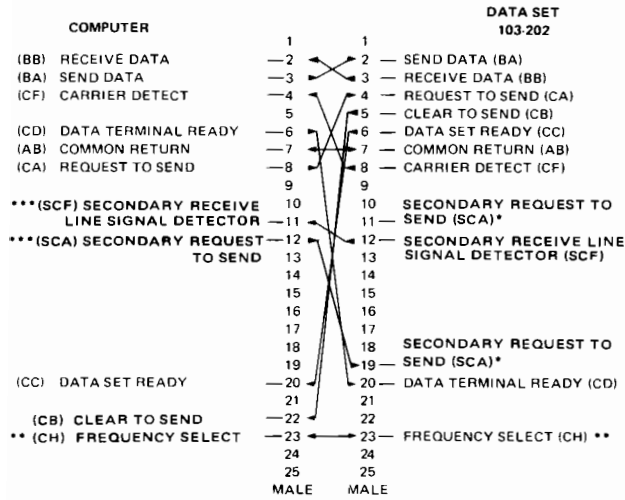

\* Required for 202S data sets only - physically strapped together in the modem. The DTE can control SCA from either pin 11 or pin 19.

\*\* European modems only.

\*\*\* For 202C modems; Pin 11 is Supervisory Transmitted Data (SBA) at the DCE. Pin 12 is Supervisory Receive Data (SBB) at the DCE. Cross connect pins 11-12 and 12-11 for 202C.

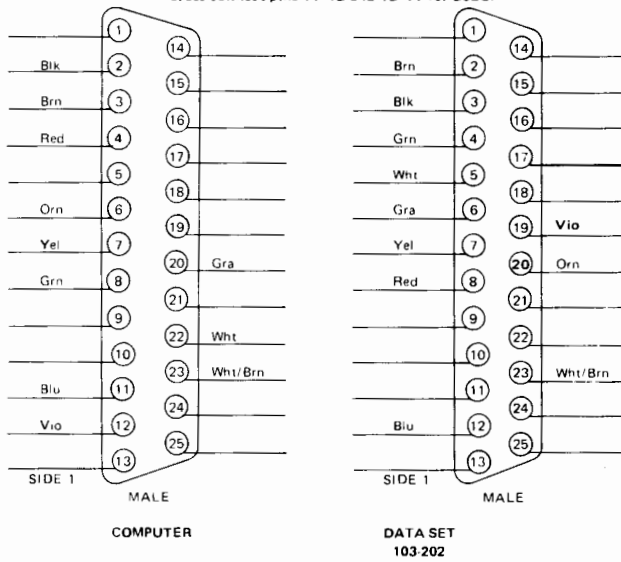

Peripherals

ASYNCHRONOUS TERMINAL CONTROLLER HARDWARE/EXTENSION CABLE  
PIN CONNECTIONS

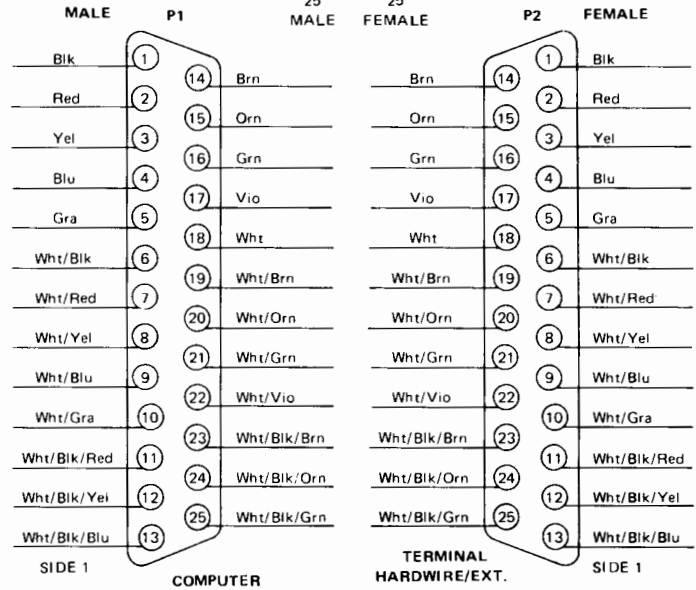
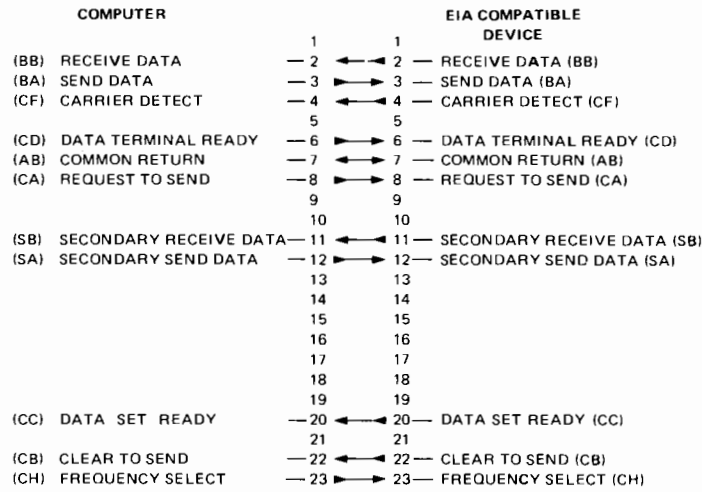

30226A PLOTTER INTERFACE SUBSYSTEM CONNECTIONS

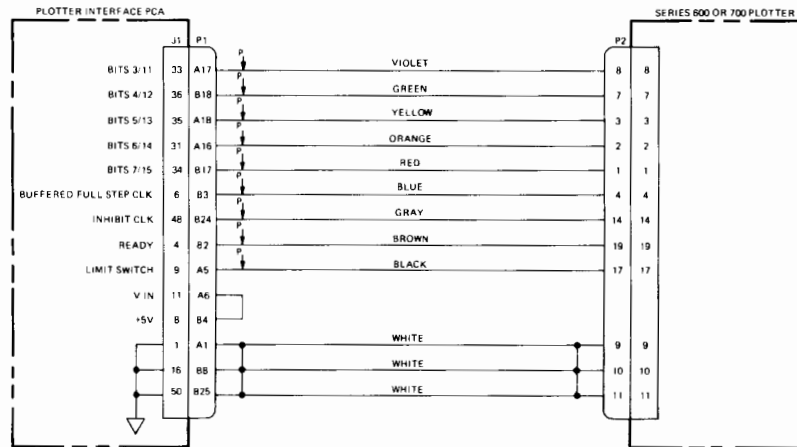
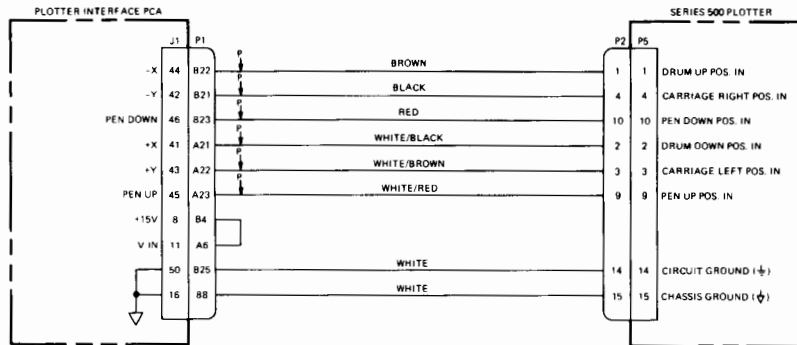

- NOTES: 1 "P" INDICATES A TWISTED PAIR  
 2 SERIES 500 PLOTTER  
 P1 a WHITE WIRES OF TWISTED PAIRS P1 B21, P1 B22, AND P1 B23 ARE TERMINATED AT P1 B25.  
 b WHITE WIRES OF TWISTED PAIRS P1 A21, P1 A22, AND P1 A23 ARE TERMINATED AT P1 B8.  
 P2 a WHITE WIRES OF TWISTED PAIRS P2 1, P2 4, AND P2 10 ARE TERMINATED AT P2 14.  
 b WHITE WIRES OF TWISTED PAIRS P2 2, P2 3, AND P2 9 ARE TERMINATED AT P2 15.  
 3 SERIES 600 OR 700 PLOTTER  
 P1 a WHITE WIRES OF TWISTED PAIRS P1 A17, P1 A18, AND P1 A16 ARE TERMINATED AT P1 B8.  
 b WHITE WIRES OF TWISTED PAIRS P1 B18, P1 B17, AND P1 B24 ARE TERMINATED AT P1 B25.  
 c WHITE WIRES OF TWISTED PAIRS P1 B3, P1 B2, AND P1 A5 ARE TERMINATED AT P1 A1.  
 P2 a WHITE WIRES OF TWISTED PAIRS P2 8, P2 14, AND P2 17 ARE TERMINATED AT P2 10.  
 b WHITE WIRES OF TWISTED PAIRS P2 3, P2 7, AND P2 19 ARE TERMINATED AT P2 11.  
 c WHITE WIRES OF TWISTED PAIRS P2 1, P2 2, AND P2 4 ARE TERMINATED AT P2 9.

Peripherals

PLOTTER INTERFACE PCA JUMPER AND SWITCH LOCATIONS

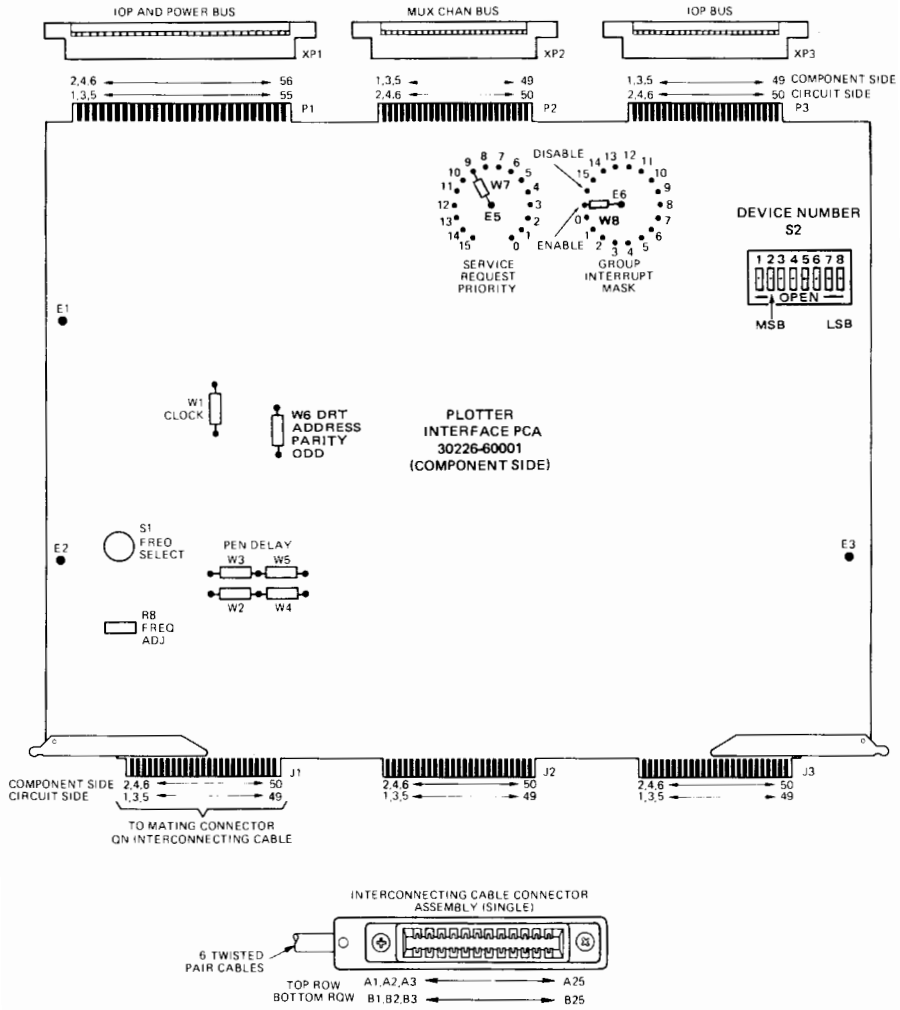

Reference: SIM



CONTROL WORD (CIO)

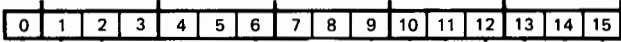

- 0 MASTER CLEAR
- 1 CLEAR ALL INT
- 2 SELECT DIAG TEST 1
- 3-5 NOT USED
- 6 SELECT RIGHT BYTE
- 7 TEST LIMIT SWITCH INT
- 8 TEST I/O TIMEOUT ERROR INT
- 9 TEST READY INT
- 10 SELECT DIAG TEST 2
- 11 TEST XFER ERROR INT
- 12 SUSPEND PLOT
- 13 CONTINUE PLOT
- 14 RESET INT MASK
- 15 SET INT MASK

PLOTTER INTERFACE CONTROL WORD FORMAT

STATUS WORD (TIO, END, SENSE)

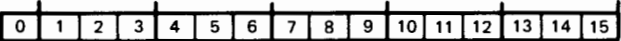

- 0 SIO OK
  - 1 RIO/WIO OK
  - 2 INTERRUPT REQUEST
  - 3-9 LAST PLOT COMMAND ISSUED
  - 10 PLOTTER READY
  - 11 SUSPEND PLOT
  - 12 XFER ERROR INT
  - 13 I/O TIMEOUT ERROR INT
  - 14 ABORT INT
  - 15 LIMIT SWITCH INT
- ANY ERROR INT

PLOTTER INTERFACE STATUS WORD FORMAT

Peripherals

PLOTTER INTERFACE DIAGNOSTIC TEST HOOD WIRING DIAGRAM

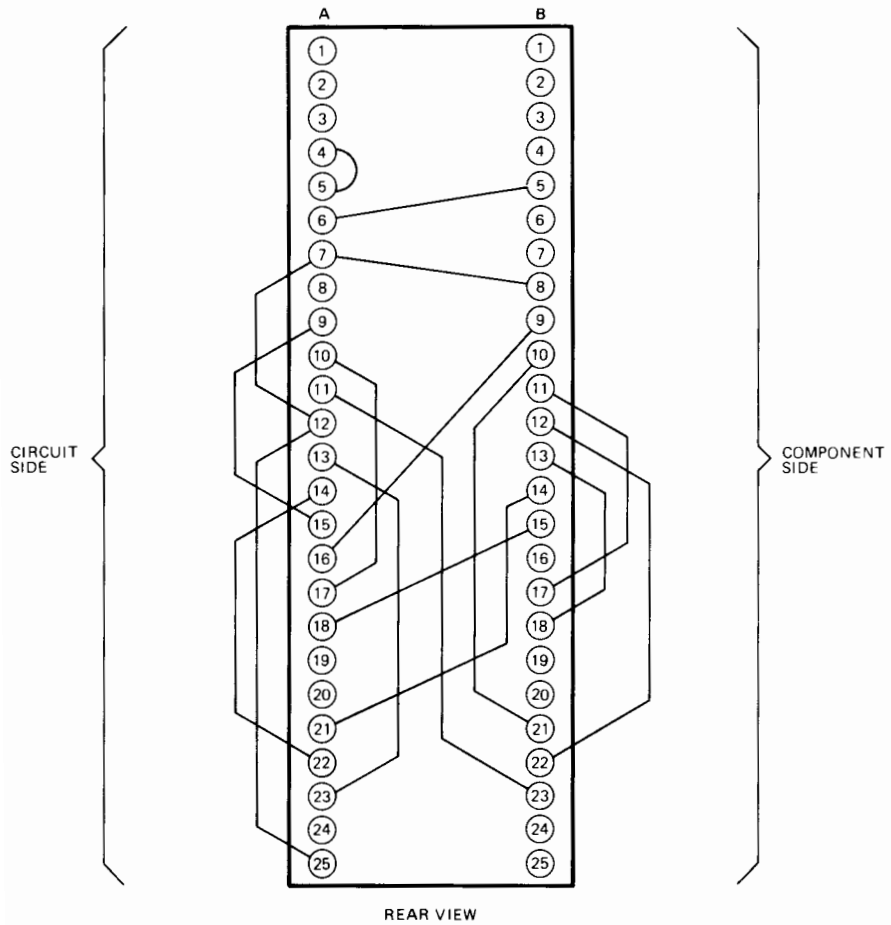

## PLOTTER INTERFACE DIAGNOSTIC TEST HOOD JUMPER FUNCTIONS

JUMPER CONNECTION		FUNCTION
FROM	TO	
A4 (J1-7)	A5 (J1-9)	Connects the clear-side of the Limit Switch Diagnostic flip-flop (U141B) to the clock input of the Limit Switch Interrupt flip-flop (U38B). Permits the diagnostics to check the limit switch interrupt function.
B5 (J1-10)	A6 (J1-11)	Connects the +5V supply to the VIN (J1-11) pin on the plotter interface PCA to provide +5V plotter input signals rather than the normal +15V signals.
B8 (J1-16)	A7 (J1-13)	Grounds the input to inverter (U26D) to force the Good Data Clock signal active. This enables all plot command data transfer circuitry decoders.
A7 (J1-13)	A12 (J1-23)	Grounds one input to the diagnostic multiplexer (U154) to cause bit 3 of the diagnostic status word to be a "0" when series 600/700 plot command data is selected, ie, when the select line is inactive.
A12 (J1-23)	A25 (J1-49)	Grounds the enable line of the diagnostic multiplexer (U154 and U164). This allows either series 500 or series 600/700 plot command data to be provided as part of the diagnostic status word (bits 3 through 8).
A9 (J1-17)	A15 (J1-29)	Simulates the clock jumper W1 to ensure that the full step clock output will be used during all diagnostic testing.
A10 (J1-19)	A17 (J1-33)	Connects data out bits 3 or 11 (series 600/700) to the input of the diagnostic multiplexer (U154) to provide bit 4 of the diagnostic status word when the select line is inactive.
A11 (J1-21)	B23 (J1-46)	Connects the pen down plot command (series 500) to the input of the diagnostic multiplexer (U154) to provide bit 4 of the diagnostic status word when the select line is active.
A13 (J1-25)	A23 (J1-45)	Connects the pen up plot command (series 500) to the input of the diagnostic multiplexer (U154) to provide bit 3 of the diagnostic status word when the select line is active.
A14 (J1-27)	A22 (J1-43)	Connects the +Y plot command (series 500) to the input of the diagnostic multiplexer (U164) to provide bit 7 of the diagnostic status word when the select line is active.
A16 (J1-31)	B9 (J1-18)	Connects data out bits 6 or 14 (series 600/700) to the input of the diagnostic multiplexer (U164) to provide bit 7 of the diagnostic status word when the select line is inactive.
A18 (J1-35)	B15 (J1-30)	Connects data out bits 5 or 13 (series 600/700) to the input of the diagnostic multiplexer (U164) to provide bit 6 of the diagnostic status word when the select line is inactive.
A21 (J1-41)	B14 (J1-28)	Connects the +X plot command (series 500) to the input of the diagnostic multiplexer (U164) to provide bit 6 of the diagnostic status word when the select line is active.
B10 (J1-20)	B21 (J1-42)	Connects the -Y plot command (series 500) to the input of the diagnostic multiplexer (U164) to provide bit 8 of the diagnostic status word when the select line is active.
B11 (J1-22)	B17 (J1-34)	Connects data out bits 7 or 15 (series 600/700) to the input of the diagnostic multiplexer (U164) to provide bit 8 of the diagnostic status word when the select line is inactive.
B12 (J1-24)	B22 (J1-44)	Connects the -X plot command (series 500) to the input of the diagnostic multiplexer (U164) to provide bit 5 of the diagnostic status word when the select line is active.
B13 (J1-26)	B18 (J1-36)	Connects data out bits 4 or 12 (series 600/700) to the input of the diagnostic multiplexer (U164) to provide bit 5 of the diagnostic status word when the select line is inactive.

Peripherals

NOTES

HP 30341A SERIES III HP-IB INTERFACE MODULE  
IMBA PCA CABLE CONNECTIONS

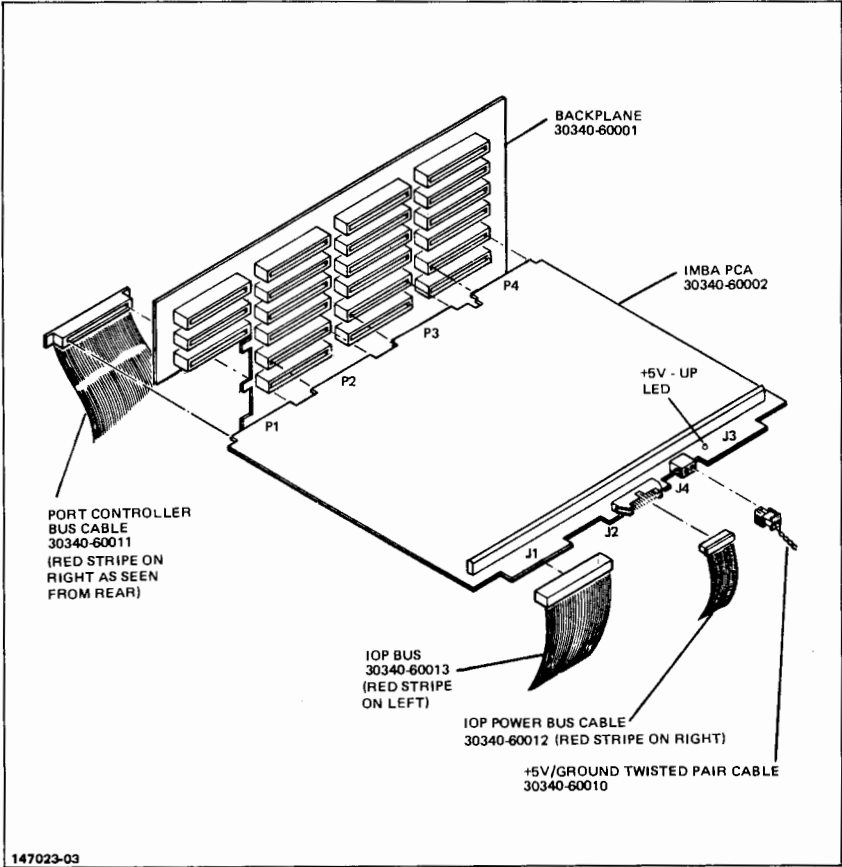

Peripherals

HP 30341A SERIES III HP-IB INTERFACE MODULE  
SELF-TEST

- a. Depress BIC PCA's CPU TEST Switch.
- b. The "\*" LED will light and remain lighted as long as the test runs. When the test finishes successfully, or an error is detected, the "\*" LED will extinguish, and the "A" through "I" LED's will indicate results, as follows.
  - (1) If NO peripherals are attached to the Interface Module and the test is successful, the code %740 will appear on the "A" through "I" LED's. (The %740 will flash a few times, then stay lighted.) If any other pattern appears, an error has been detected; use the following table as a troubleshooting guide. For example, if the "B," "C," and "F" LED's are lighted, error code %310 is indicated. The table shows that error code %310 means Processor PCA ROM Unit U141 is suspect.
  - (2) If a peripheral is attached, analyzing the LED display depends on whether the peripheral is a valid cold load device. If the peripheral IS a valid cold load device and the test is successful, all the LED's will go off. If the peripheral is NOT a valid cold load device and the test is successful, the code %750 will appear on the LED's. (It will flash a few times, then stay lighted.)

HP 30341A SERIES III HP-IB INTERFACE MODULE  
 DECODING BIC PCA SELF-TEST LED'S

```

-----
Error Code   *           Suggested Action
-----
*
*
100 through  *           (1) Replace Processor PCA
240          *           (2) Replace BIC PCA
*****
250 through  *           (1) Replace BIC PCA
270          *           (2) Replace Processor PCA
*****
300 through  *           (1) Replace Processor PCA ROM indicated
470:         *           below (if available).
*
300          *           ROM Unit U 131
310          *           U 141
320          *           U 151
330          *           U 161
340          *           U 132
350          *           U 142
360          *           U 152
370          *           U 162
400          *           U 133
410          *           U 143
420          *           U 153
430          *           U 163
440          *           U 134
450          *           U 144
460          *           U 154
470          *           U 164
*
*           (2) Replace entire Processor PCA.
*****
600 through  *           (1) Replace IMBA PCA
630          *           (2) Verify Series III Port Controller is
*           functioning correctly.
*           (3) Replace Processor PCA
*           (4) Replace BIC PCA
*****
650 through  *           (1) Replace GIC PCA
730          *           (2) Replace IMBA PCA
*           (3) Replace BIC PCA
*           (4) Replace Processor PCA
*****

```

Peripherals

HP 30341A SERIES III HP-IB INTERFACE MODULE  
DECODING BIC PCA SELF-TEST LED'S, CONTINUED

-----  
740           \*       Warning: No device attached to GIC,  
              \*       or GIC cable not attached. (Will  
              \*       flash a few times, then stay lighted.)  
\*\*\*\*\*  
750           \*       (1) If it FLASHES a few times before  
              \*       staying lighted, means Warning: No  
              \*       valid cold load device is attached to  
              \*       GIC.  
              \*       (2) If it does NOT flash a few times  
              \*       before staying lighted, (a) replace GIC  
              \*       PCA, (b) check peripheral.  
\*\*\*\*\*  
760           \*       (1) Check peripheral  
              \*       (2) Replace GIC PCA  
-----



HP 30341A SERIES III HP-IB INTERFACE MODULE  
I/O INSTRUCTIONS

Instruction	I/O Opcode	Function
SIOP	0	Start I/O channel program
RIOC	2	Read I/O channel
WIOC	3	Write I/O channel
SED25	4	Enable/disable 25A interrupts
INIT	6	Initialize I/O channel
SLFT	7	Initiate self test

HP 30341A SERIES III HP-IB INTERFACE MODULE  
MODIFIED HP-IB I/O DRT FORMAT

DRT Word	Contents
DRT0	Channel Program Pointer
DRT1	Interrupt Label
DRT2	Channel Program Variable Area Pointer
DRT3	Channel Program Status

Peripherals

HP 30341A SERIES III HP-IB INTERFACE MODULE  
DIRECT I/O COMMAND DEFINITIONS

I/O Command	IOCMD Decode	IMBA PCA Operation
CIO %100000	001	Causes a master clear of the IMBA PCA
TIO	101	Causes the IMBA PCA to return a 3-bit status word (IOD0-IOD2) to the computer system. The status word format is listed below. (Bits IOD3-IOD15 are undefined.)  IOD0 - SIO OK Bit. When set to 1, indicates that any previous SIO to the IMBA PCA is not active.  IOD1 - RIO OK Bit. Always set to 1.  IOD2 - +5V OK Bit. When 1, indicates that +5 V from the power supply is available on the IMB.
SIO	010	Causes the IMBA PCA to generate the Channel Service Request (CSRQ1) signal on the IMB. The operator running the SIO microdiagnostic should note that the status returned by the 30341A will be %177.
RIL	100	Causes the IMBA PCA interrupt logic to be reset. This command can only be issued as part of the IEXIT instruction.

7976A HP-IB INTERFACE CONTROLLER  
DIO STATUS

## WORD 1

-----  
| 1 | 2 | 3 | 4 | 5 | 6 | 7 | 8 |  
-----

Bit 1: On-line  
2: unrecovered data check (MTE)  
3: File protected (not write-enabled; no write ring)  
4: Command rejected (REJECT)  
5: Recovered data check (STE)  
6: End of tape  
7: Load point/ Beginning of tape  
8: End of file

## WORD 2

-----  
| 1 | 2 | 3 | 4 | 5 | 6 | 7 | 8 |  
-----

Bit 1: Busy  
2: (Reserved)  
3: Rewinding  
4: Tape runaway  
5: Data error (timing)  
6: (Reserved)  
7: (Reserved)  
8: GCR (6250 bpi) mode

## WORD 3

-----  
| 1 | 2 | 3 | 4 | 5 | 6 | 7 | 8 |  
-----

Bit 1: Interface Controller Unit error (incl PHI s.m.)  
2: Interface Controller Unit error (incl FCU s.m.)  
3: FCU/MTU error (isolation)  
4: Position unrecovered  
5: Parity error  
6: Power has been restored  
7: (Reserved)  
8: (Reserved)

2680 LINE PRINTER  
I/O STATUS BLOCK

WORD 1

-----  
|0|1|2| 3 | 4 | 5 | 6 | 7 | 8 | 9 | 10 | 11 | 12 | 13 | 14 | 15 |  
-----

Bit 0: 0=Online, 1=Offline  
1: Transmission error occurred  
2: Power up completed since last I/O Status read  
3: (Reserved)  
4: Out of data buckets; data will be lost  
5: (Reserved)  
6: 0=Print mode, 1=stop mode  
7: Parity error on Phi Command  
8: Hardware malfunction, printer needs repair  
9: Error condition, operator attention needed  
10: Advisory is displayed on printer  
11: Warning! Hardware failure imminent  
12: Invalid spoolfile record size  
13-15: (Reserved)

WORD 2

-----  
|0|1|2| 3 | 4 | 5 | 6 | 7 | 8 | 9 | 10 | 11 | 12 | 13 | 14 | 15 |  
-----

Bit 0: No room for attempted character set load  
1: No room for attempted form load  
2: No room for attempted VFC load  
3: Attempt to select an undefined character set  
4: Attempt to select an undefined form  
5: Attempt to select an undefined VFC  
6: Attempt to select an illegal logical page entry  
7: Attempt to move the pen off the logical page  
8: Character block processor hardware saturated; data will be lost  
9: Maximum no. of copies per physical page exceeded  
10: Invalid recovery block received from host CPU  
11-15: (Reserved)

# DIAGNOSTICS

SECTION

IX

## Table Of Contents

Topic	Page
CPU Stand-Alone Diagnostic (D420) .....	9-2
CPU Diagnostic Error Analysis .....	9-3
List Of On-Line Verification Programs .....	9-4
26XX Line Printers (D466) .....	9-5
2635A/2635K Printer Terminal (D474) .....	9-6
2645K Display Terminal (D476) .....	9-7
2893A Card Reader (D465) .....	9-8
2680A Page Printer .....	9-8a
7976 A Magnetic Tape Unit .....	9-8b
2894A Card Reader/Punch (D479) .....	9-9
7260A Optical Mark Reader (D480) .....	9-9
List Of Non-CPU Stand-Alone Diagnostics .....	9-10
7905A/7920A/7925A Disc Drive (SLEUTH07) .....	9-11
Multiplexer Channel (D422) .....	9-13
System Clock/FLI (D426A) .....	9-14
Terminal Data Interface (D427) .....	9-16
Selector Channel (D429) .....	9-18
Memory (D430) .....	9-20
Extended Instruction Set (D431) .....	9-22
Hardwired Serial Interface (D432) .....	9-24
7970B/E Magnetic Tape Drive (D433) .....	9-26
Synchronous Single-Line Controller (D434) .....	9-28
Universal Interface and 30219A Card Reader/Punch Interface (D435) .....	9-30
Terminal Controller Interface (D438) .....	9-33
Plotter Interface (D439) .....	9-35
COBOL II Firmware (D441 and D442) .....	9-37

Diagnostics

CPU STAND-ALONE DIAGNOSTIC (D420)

Section	1	D420A
	2	A1
	3	A2
	4	A3
	5	A4
	6	A5
	7	A6
	8	A7
	9	A8
	10	A9
	11	A10
	12	A11
	13	A12
	14	A13

CPU Cold Load Tape Part Numbers:

30000-10016 (800 BPI tape)  
30000-11016 (1600 BPI tape)

For use with a configured tape.

SECTION I

Cold Load and Run - CIR = Pause (%030020)  
Press Run/Halt - Should Halt  
Press Run/Halt - Should Run  
Halt %15 indicates END of pass.

SECTION II THROUGH V

Cold Load and Run.  
Halt %15 indicates END of Pass.  
Repeat for Sections III thru V.

SECTION VI THROUGH XIV

Cold Load and Run - System Halt should occur.  
Repeat for Sections VII thru XIV

SECTION NO.	CIR	SP2	SPI (Memory Data)
-----	---	---	-----
6	-	%120001	< > 0
7	-	%120001	< > 0
8	-	% 1	-
9	-	%117401	< > 0
10	IXIT	%000000	-
11	PSEB	% 3	-
12	-	%120001	0
13	-	%117401	0
14 (30003A)	-	% 6	0
14 (30003B)	-	%117401	0

## CPU DIAGNOSTIC ERROR ANALYSIS

1. Halt 1's are unexpected internal interrupts.  
CIR = %030361.
2. Halt 2's are unexpected external interrupts.  
CIR = %030362.
3. Halt %12's are error halts.  
CIR = %030372.
4. Halt %13's are halted at step number.  
CIR = %030373.  
DB + 5 contains current step number.  
X-Register contains current step number.
5. Halt %15 is halted after complete cycle.  
CIR = %030375.
6. Halt %16 - Halt to modify selection select register.  
CIR = %030376.
7. Halt %17 - Halt to restore switch register.  
CIR = %030377.
8. A BR\* is used to indicate errors in user mode.  
CIR = %140000.

Diagnostics

LIST OF ON-LINE VERIFICATION PROGRAMS

DESCRIPTION	DIAGNOSTIC NUMBER	DIAGNOSTIC MANUAL PART NUMBER
26XX Line Printers	D466	30209-90007
2635A/K Printer Terminal	D474	32230-90004
2645K Terminal	D476	30000-90104
2893A Card Reader	D465	30106-90008
2894A Card Reader/Punch	D479	30119-90007
7260A Optical Mark Reader	D480	07260-90013



26XX LINE PRINTERS  
ON-LINE VERIFICATION PROGRAM - D466

:HELLO FIELD.SUPPORT

:RUN PD466A

Enter Model Number

Enter Number Of Characters

Enter Logical Device Number

Select Section Flags

(For Looping and Status Checks - Use SLEUTH)

FLAG OPTIONS

-----

Flag 1 - Section 1 - On/Off Line Test

- 2 - VFU Tests (Default VFC for 2608)
- 3 - Character Test
- 4 - Ripple Test
- 5 - Triangle Test
- 6 - Horizontal, Vertical Test
- 7 - Nonprinting Character Codes  
(Not for 2608)
- 8 - Character Backspace, Shift-Out/  
Shift-In (Character Set Switching),  
Line Overprint Test (2608 only)
- 9 - Download VFC Test (2608 only)
- 10 - Download Left Margin Test (2608 only)

Press RETURN

Diagnostics

2635A/2635K PRINTER TERMINAL  
ON-LINE VERIFICATION PROGRAM - D474

Set the HP 2635A switches as follows:

AC POWER to ON  
DUPLEX to FULL  
PARITY to NONE  
If using a modem, set BAUD RATE to required position.  
If terminal is hardwired, set BAUD RATE to any position.  
DISPLAY FUNCTIONS to unlatched  
REMOTE to latched  
CAPS LOCK to unlatched  
AUTO LF to unlatched

:HELLO FIELD.SUPPORT,HP32230;TERM=15 or TERM=16

NOTE

When logging on, you must select either TERM type 15 or 16. Terminal type 15 allows the HP 2635A to be used in an 8-bit environment. Terminal type 16 allows the HP 2635A to be used as a 7-bit terminal with parity.

:RUN PD474A

\*\*\*\*\*THIS IS THE 2635A ON-LINE VERIFIER PROGRAM\*\*\*\*\*  
\*\*\*\*'CAPS LOCK' SHOULD BE DISABLED THROUGHOUT ALL TESTS!\*\*\*\*

WHAT TESTS?---YOU MAY SELECT ONLY ONE OR ALL---ENTER 1,2,3,4,  
OR 'ALL' (See below)

?all

Test Descriptions

TEST	Description
1	Roman character set
2	Alternate character set
	1 French
	2 German
	3 Swedish/Finnish
	4 Danish/Norwegian
	5 Spanish
	6 British
	7 Katakana
3	8-bit Protocol/Escape Control Modes
4	Vertical Format Channels

2645K TERMINAL  
ON-LINE VERIFICATION PROGRAM - D476

Set the HP 2645K switches as follows:

AC POWER to ON  
CAPS LOCK to unlatched  
DUPLEX to HALF and disable echo function with ESC;C  
(This is not a mandatory switch setting. If DUPLEX is set to FULL, you will have to manually invoke the Roman character set before responding after a Katakana display.)

:HELLO FIELD.SUPPORT,HP32230;TERM=12  
:RUN PD476A

\*\*\*\*\*THIS IS THE 2645K ON-LINE VERIFIER PROGRAM\*\*\*\*\*  
\*\*\*\*'CAPS LOCK' SHOULD BE DISABLED THROUGHOUT ALL TESTS!\*\*\*\*  
WHAT TESTS?---YOU MAY SELECT ONLY ONE OR ALL---ENTER 1,2,3,4,  
OR 'ALL' (See below)

?all

## Test Descriptions

TEST	Description
1	Roman character set
2	Katakana character set
3	8-bit Protocol/Escape Control Modes
4	Cartridge tape

Diagnostics

2893A CARD READER  
ON-LINE VERIFICATION PROGRAM - D465

=SPOOL 6, STOP  
=REFUSE 6  
:RUN PD465A

D1 ONLINE CARD READER VERIFIER (HP D465A.XX.X)

Q2 INSTRUCTIONS ?

Q3 LOGICAL DEVICE ?6

D7 PLACE TEST DECK IN READER, PRESS RESET  
THEN TYPE A CARRIAGE RETURN

D6 END OF SECTION 1

D6 END OF SECTION 2

D5 THE NEXT CARD SHOULD PRINT ON THE CONSOLE

INVALID HOLLERITH COL #58

THEN REPLACE CARD IN HOPPER CORRECTLY, PRESS RESET

IO/1:11/LDEV#6 INVALID HOLLERITH COL #58

D6 END OF SECTION 4

D4 PRESS EOF BUTTON THEN TYPE A CARRIAGE RETURN

D6 END OF SECTION 5  
END OF PROGRAM

:

=ACCEPT 6

=SPOOL 6, STARTIN

HP 2680A PAGE PRINTER  
ONLINE VERIFIER  
MINI-OPERATING INSTRUCTIONS

1. Verify proper online operation.
2. Enter the following system commands:

```
:HELLO FIELD.SUPPORT,HP32340A  
:RUN PD467A.HP32340A.SUPPORT
```

3. Perform procedures requested by the verifier.

Note

Use the printer self-test function (on top panel keyboard) to run the complete set of printer diagnostics.

4. To run printer self tests, enter 1 ENT on the printer keyboard.

Diagnostic

HP 7976A MAGNETIC TAPE UNIT  
DIAGNOSTIC LOADER  
MINI-OPERATING INSTRUCTIONS

Log and enter the following:

:HELLO FIELD.SUPPORT,HP32340  
:RUN PD470A or  
:RUN PD470A, MANUAL

If the Loader is run in Auto mode, minimal user interaction is necessary. In Manual mode the Loader prompts the user for the desired operation:

Routing (RTssrree). Selftest, Loopback, Auto, Exit?

Where:

ss is the section designator in OCTAL  
rr is the routine designator in OCTAL  
ee is the routine extension field in OCTAL

Refer to HP 7976A Subsystem Diagnostic Manual (p/n 07976-90906) for test routine descriptions, error codes and messages.

2894A CARD READER/PUNCH  
ON-LINE VERIFICATION PROGRAM - D479

:HELLO HP32230.SUPPORT  
SESSION NUMBER = S#XX  
TUES, SEP 16, 1975, 10:30 A.M.  
HP 32000.00.XX

:RUN PD479A

Enter Logical Device Number.

Select Section Flags.

(For Looping and Status Checks - Use SLEUTH)

7260A OPTICAL MARK READER  
ON-LINE VERIFICATION PROGRAM - D480

NOTE

Refer to the HP 7260A Optical Mark Reader  
Reference Manual, part no. 07260-90013,  
for further information on this product.

## Diagnostics

## LIST OF NON-CPU STAND-ALONE DIAGNOSTICS

DESCRIPTION	DIAGNOSTIC NUMBER	DIAGNOSTIC MANUAL PART NUMBER
SLEUTH	D411	03000-90123
7905/20/25 Disc Drive	SLEUTH07	32230-90002
Multiplexer Channel	D422	30036-90001
System Clock/FLI	D426	32230-90005
Terminal Data Interface	D427	30032-90011
Selector Channel	D429	30030-90011
Memory	D430	30000-90004
Extended Instruction Set	D431	30012-90001
Hardwired Serial Interface	D432	30360-90007
7970B/E Magnetic Tape Drive	D433	30115-90014
Synchronous/Single-Line Controller	D434	30055-90008
Universal and 30219A Card Reader/Punch Interface	D435	30050-90012
Terminal Controller Interface	D438	30061-90003
Plotter Interface	D439	30226-90009
COBOL II Firmware	D441 & D442	32234-90002



7905A/7920A/7925A DISC DRIVE  
STAND-ALONE DIAGNOSTIC - SLEUTH07

NOTE

If you are not familiar with SLEUTH (D411) and SLEUTH07, refer to the Disc Drive Verifier Stand-Alone SLEUTH Program SLEUTH07 Manual, part no. 32230-90002 for additional information.

If you intend to use the customer's disc packs for running SLEUTH07, check that a SYSDUMP with a 0 dump date was performed. Ensure that all disc surfaces have been backed up before running SLEUTH07.

Obtain the disc controller DRT number from the System Support Log or from the list of I/O devices that was printed at SYSDUMP.

Ensure that the SLEUTH utility (D411) is present on a cold loadable I/O stand-alone magnetic tape and shutdown the MPE Operating System.

Set the disc drive READ ONLY switch to OFF and, if formatting is planned, set the FORMAT switch to ON. Set the System Control Panel PF/ARS switch to ENBL.

Mount the SLEUTH utility I/O stand-alone tape on a magnetic tape drive, select unit 0, place the tape at load point, and place the unit on-line.

Set the System Control Panel Switch Register to %003006 and simultaneously press the ENABLE and LOAD switches.

Place the location that SLEUTH occupies on the I/O stand-alone tape into the Switch Register.

Press the RUN switch and, on the console, press RETURN to start SLEUTH execution.

Remove the I/O stand-alone tape and mount the tape that contains SLEUTH07 on the magnetic tape drive. Place the tape at load point and the unit on-line.

```
>10 BA E
>900 RUN
7905/7920/7925 VERIFIER, ENTER DRT #
4
-
UNIT SELECT SWITCH TEST? (0=N, 1=Y)
1
-
ENTER UNIT#, SET SWITCH TO UNIT# ENTERED, PRESS RUN
0
-
```

## Diagnostics

The computer halts with %030377 displayed in the CIR. Set the disc drive UNIT SELECT switch to 0 and press the System Control Panel RUN switch.

ENTER UNIT#, SET SWITCH TO UNIT# ENTERED, PRESS RUN

1  
-

Repeat switch tests until eight numbers have been tested.

ENTER UNIT# TO BE TESTED

0  
-

I NEED UNIT# ONE MORE TIME

0  
-

FORMAT PACK? (0=N, 1=Y)

1  
-

VERIFY PACK? (0=N, 1=Y)

1  
-

VERIFY LONG PASS? (0=N, 1=Y)

0  
-

BEGIN FORMAT

END FORMAT

BEGIN VERIFY

VERIFY PASS #

1  
-

END VERIFY

BEGIN MAIN

END HEAD TEST

END TRACK SWITCH TEST

END WRITE/READ TEST

>900 (Halt the computer to end SLEUTH execution.)

You may terminate SLEUTH07 execution with a control-A or by setting Switch Register switches 0 and 13. Following termination, you can: (1) type RUN to repeat tests, (2) type any other SLEUTH command, or (3) press the computer HALT switch.

Refer to Section X of this manual for SLEUTH07 program listing.

MULTIPLEXER CHANNEL  
STAND-ALONE DIAGNOSTIC - D422

1. Cold Load Diagnostic File from Non-CPU Cold Load Tape.
2. Respond to Speed-Sense by typing "CR" on the Console.
3. Respond to the dialogue on the Console.

## SWITCH REGISTER OPTIONS:

BIT ---	FUNCTION -----
0	Select External Switch Register
1	Set to Change Section Selection Register
2	Set to Bypass Section (AREG)
3	Set to Bypass Section (OREG)
4	Set to Bypass SIOTEST Section (Steps 63 and 68)
5	Loop Current Section
6	Set to Bypass SIOTEST (Steps 75 thru 78)
7	Output to Line Printer (If configured in SDUP)
8	Spare
9	Suppress Non-Error Messages
10	Suppress Error Messages
11	Loop on Last Step
12	Halt on Error
13	Halt at End of Step
14	Halt at End of Section
15	Halt After Complete Program Cycle

## HALT ASSIGNMENTS:

NO. (OCTAL) -----	FUNCTION -----
0	Halt for External Switch Register Entry
1	Halt for Section Switch Register Entry
2	Halt to Restore External Switch Register Entry
3	Halt on Error Count Reached
4-10	Spares
11	Abnormal Interrupt
12	Halt on Error
13	Halt After Step
14	Halt After Section
15	Halt After Complete Program Cycle
16	Spare
17	Spare

Diagnostics

SYSTEM CLOCK/FLI  
STAND-ALONE DIAGNOSTIC - D426

1. Cold Load Diagnostic File from Non-CPU Cold Load Tape.
2. Respond to Speed-Sense by typing "CR" on the Console.
3. Respond to dialogue on the Console.

SWITCH REGISTER OPTIONS:

BIT	FUNCTION
---	-----
0	Select External Switch Register
1	Set to Change Section Switch Register
2	Spare
3	Spare
4	Spare
5	Loop Current Section
6	Spare
7	Output to Line Printer (If configured in SDUPII)
8	Spare
9	Suppress Non-Error Messages
10	Suppress Error Messages
11	Loop on Last Executed Step
12	Halt on Error
13	Halt at End of Step
14	Halt at End of Section
15	Halt After Complete Program Cycle

SECTION SWITCH REGISTER OPTIONS:

BIT	FUNCTION
---	-----
0	Reconfigure
1	Select Section 1
2	Select Section 2
3	Select Section 3
4	Select Section 4
5-15	Spare

## SYSTEM CLOCK/FLI DIAGNOSTIC (Continued)

## HALT ASSIGNMENTS:

NO. (OCTAL) -----	FUNCTION -----
0	Halt for External Switch Register Entry
1	Halt for Section Switch Register Entry
2	Halt to Restore External Switch Register Entry
3	Halt on Error Count Reached
4-11	Spare
12	Halt on Error
13	Halt After Step
14	Halt After Section
15	Halt After Complete Program Cycle
16-17	Spare

Diagnostics

TERMINAL DATA INTERFACE (TDI)  
STAND-ALONE DIAGNOSTIC - D427

1. Remove and label all connectors from Terminal Controller/Multiplexer Connector Panel.

NOTE

In order to make a complete test of the interface (all 16 channels), 8 successive channel selections should be made.

2. Connect test cable (30062-60002) to the two channels to be tested.
3. Cold load Diagnostic D427A from stand-alone diagnostic tape. Program will halt with a HALT 6.
4. Select switch register options. (See below.)

NOTE

To run diagnostic with preset configuration, set switch register bit 0 OFF.

5. Press RUN. The program halts for channel selection with a HALT 7.
6. Select channel pair to be tested (the two channels connected in step 2).
  - a. Enter the lower numbered channel to be tested (octal value) in the first byte (right justified) of the switch register.
  - b. Enter the upper numbered channel to be tested (octal value) in the second byte (right justified) of the switch register.
7. Press RUN. HALT 6 occurs. Channel numbers have now been entered.
8. Press RUN. Test Sections 1 through 7 will be executed.
  - a. If a HALT %16 occurs, the test executed without errors. Repeat steps 2 and 6 through 8 for the next channel pair to be tested.
  - b. If HALT %12 is displayed, an error has been encountered.

## TERMINAL DATA INTERFACE DIAGNOSTIC (Continued)

## SWITCH REGISTER OPTIONS:

BIT ---	FUNCTION -----
0	Select External Switch Register
1	Set to Change Section Selection Register (switch 0 also set)
2-4	Spare
5	Move Select - OFF: Automatic/ON: Manual
6-10	Spare
11	Loop on Last Pass
12	Halt on Error
13	Halt at End of Pass
14	Halt at End of Section
15	Halt After Complete Program Cycle

## HALT ASSIGNMENTS:

NO. (OCTAL) -----	FUNCTION -----
0	Halt for Reconfiguration
1	In Section 8, Halt to Enter DRT# of /Test Interface
2-4	Spare
5	Halt for Section Switch Register Entry
6	Halt to Restore External Switch Register Entry
7	Halt to Enter Channel Pair Numbers/Manual
10-11	Spare
12	Error Halt
13	Halt After Pass
14	Halt After Section
15	Halt After Complete Program Cycle/Automatic
16	Halt After Complete Program Cycle/Manual
17	Spare

Diagnostics

SELECTOR CHANNEL  
STAND-ALONE DIAGNOSTIC - D429

1. Cold Load Diagnostic File from Non-CPU Cold Load Tape.
2. Respond to Speed-Sense by typing "CR" on the Console.
3. Respond to the dialogue on the Console.

SWITCH REGISTER OPTIONS:

BIT ---	FUNCTION -----
0	Select External Switch Register
1	Set to Change Section Select Register
2-4	Spare
5	Loop on Current Section
6	Run on MUX mode (For SCMB verification only. Refer to Message Q104)
7	Output to Line Printer (If configured in SDUPII.)
8	Spare
9	Suppress Non-Error Messages
10	Suppress Error Messages
11	Loop on Last Step
12	Halt on Error
13	Halt at End of Step
14	Halt at End of Section
15	Halt After Complete Program Cycle

SECTION SWITCH REGISTER OPTIONS:

BIT ---	FUNCTION -----
0	Re-Configure
1	Select Section 1
2	Select Section 2
3	Select Section 3
4	Select Section 4
5	Select Section 5
6	Select Section 6
7	Select Section 7
8-15	Spare



## SELECTOR CHANNEL DIAGNOSTIC (Continued)

## HALT ASSIGNMENTS:

NO. (OCTAL) -----	FUNCTION -----
0	Halt for External Switch Register Entry
1	Halt for Section Switch Register Entry
2	Halt to Restore External Switch Register Entry
3	Halt on Error Count Reached
4-11	Spare
12	Halt on Error
13	Halt After Step
14	Halt After Section
15	Halt After Complete Program Cycle
16-17	Spare

Diagnostics

MEMORY STAND-ALONE DIAGNOSTIC - D430

Cold Load Diagnostic File from Non-CPU Cold Load Tape. After halt, set switch register options and type "CR" on the console. The following diagnostic heading message will appear on the system console. The example memory configuration display shown below is for a system that has 512K words of memory installed.

HP 3000 SERIES III ERROR CORRECTING MEMORY TEST D430B (0.00)

SYSTEM MEMORY CONFIGURATION

LOWER MCL

SMA	0	1	2	3
ROW	01234567	01234567	01234567	01234567
	XXXXXXXX	XXXXXXXX	XXXXXXXX	XXXXXXXX

UPPER MCL

SMA	0	1	2	3
ROW	01234567	01234567	01234567	01234567
	.....	.....	.....	.....

X = 16K WORDS OF MEMORY PRESENT  
. = NO MEMORY PRESENT  
? = DATA PARITY ERROR DETECTED IN WORD 16380  
(This is a normal message.)

MEMORY CONTAINED IN THIS SYSTEM = 512K WORDS

Q0.00 DO YOU WANT THE ERROR LOG PRINTED (Y/N)?

Note

The above messages will appear only once unless the diagnostic is restarted. They are provided to allow the user an opportunity to view the error log before it is modified by the diagnostic. This current error log provides useful previous history of the system, including the results of any catastrophic errors such as

## MEMORY DIAGNOSTIC (Continued)

## SWITCH REGISTER OPTIONS:

BIT ---	FUNCTION -----
0	Select External Switch Register
1	Change Switch Register or Restart Program
2	Reserved
3	List Error Log
4	Reserved
5	Loop On Current Section
6-7	Reserved
8	Skip Current Section or Step
9	Suppress Non-Error Messages
10	Suppress Error Messages
11	Loop On Last Executed Step
12	Halt On Error
13	Halt At End Of Current Step
14	Halt At End Of Current Section
15	Halt After Diagnostic Pass

## HALT ASSIGNMENTS:

BITS 12-15 -----	FUNCTION -----
00	Action Required
01	Illegal Interrupt to STT
05	Parity Error In Program Area
07	Maximum Error Count (99) Exceeded
14	Error Halt
15	End Of Step
16	End Of Section
17	End Of Test

Diagnostics

EXTENDED INSTRUCTION SET  
STAND-ALONE DIAGNOSTIC - D431

1. Cold Load Diagnostic File from Non-CPU Cold Load Tape.
2. Respond to Speed-Sense by typing "CR" on the Console.
3. Respond to the dialogue on the Console.

SWITCH REGISTER OPTIONS:

BIT	FUNCTION
---	-----
0	Select External Switch Register
1	Set to Change Section Register
2-6	Spare
7	Output to Line Printer (If configured in SDUP)
8	Halt on Error Count Reached
9	Suppress Non-Error Messages
10	Suppress Error Messages
11	Loop on Last Step
12	Halt on Error
13	Halt on End of Step
14	Halt on End Section
15	Halt After Complete Program Cycle

SECTION SWITCH REGISTER OPTIONS:

BIT	FUNCTION
---	-----
0	Re-Configure
1	Select Extended Floating Point Diagnostic
2	Select Decimal Diagnostic
3-15	Spare

## EXTENDED INSTRUCTION SET DIAGNOSTIC (Continued)

## HALT ASSIGNMENTS:

NO. (OCTAL)	FUNCTION
0	Spare
1	Irrecoverable Unexpected Trap
2	Irrecoverable Unexpected Trap in Trap STT 1, 16, 24 and 25 (Not in Extended-Instruction Set).
3	Halt on Error Count Reached
4	Spare
5	Halt for Section Switch Register Entry
6	Halt for External Switch Register Entry
7	Halt to Restore External Switch Register Entry
10	Irrecoverable Error After Execution of Instruction Set



With this halt, TOS contains the error code as follows:

ERROR CODE (TOS)	DEFINITION
1	DB Changed
2	Code Segment # in Status (8:8) Changed
3	S-Bank Changed
4	Q Changed
11	Irrecoverable Halts for "DB Changed" in the following Trap STT #: <ul style="list-style-type: none"> <li>*) Trap #25 (User Trap)</li> <li>*) Trap #24 (Stack Overflow)</li> <li>*) Trap #16 (Unimplemented Instruction)</li> <li>*) Trap # 1 (Bounds Violation)</li> </ul> For above halt, the Trap STT # is displayed as an error code in TOS.
12	Recoverable Error Halt If Switch-Register Bit (12) was selected. TOS (0:8)=ERROR CODE;TOS(8:8)=STEP#.
13	Halt After Step
14	Halt After Section
15	Halt After Complete Program Cycle
16-17	Spare

Diagnostics

HARDWIRED SERIAL INTERFACE (HSI)  
STAND-ALONE DIAGNOSTIC - D432

1. For the channel to be tested, set the corresponding TEST/NORMAL switch on the HSI Cable Assembly Panel to the TEST position.
2. Cold load the D432 diagnostic program from a stand-alone diagnostic tape. Press RETURN. The program halts (HALT %6) to allow for entering options.
3. To run the diagnostic program when it has been preconfigured (using SDUPII), ensure bit 0 of the System Control Panel switch register is OFF (0). Press RUN.
4. The program executes each test section (tests 1 through 9) and prints an End-of-Section message after the test completes successfully. If a hardware error occurs, an error message is printed and execution terminates.
5. After all nine test sections execute, the program prints an End-of-Diagnostic message and halts (HALT %15).

NOTE

The preset baud rate is 2.5 Mbits/sec and the preset channel is 0. For a complete test, these values must be changed. Channel and baud selection is part of the preconfiguration procedure.

SWITCH REGISTER OPTIONS:

BIT ---	FUNCTION -----
0	Update Switch Register Options
1	Change Section Select Options
2-6	Not Used
7	Send Messages to Line Printer
8	Not Used
9	Suppress Non-Error Messages
10	Suppress Error Messages
11	Loop on Step
12	Halt on Error
13	Halt After Step
14	Halt After Section
15	Halt After Complete Program Cycle

## HARDWIRED SERIAL INTERFACE DIAGNOSTIC (Continued)

## HALT ASSIGNMENTS:

NO. (OCTAL) -----	FUNCTION -----
1	Unexpected Trap
5	Halt to Enter Section Selection Options
6	Halt to Enter Switch Register Options
10	Halt for Synchronization in Double-Computer Configuration
12	Error Halt
13	Halt After Step
14	Halt After Section
15	Halt After Complete Program Cycle
17	Maximum Error Limit Reached

Diagnostics

7970B/E MAGNETIC TAPE DRIVE  
STAND-ALONE DIAGNOSTIC - D433

1. Cold Load Diagnostic File From Non-CPU Cold Load Tape.
2. HP 30115A 9-TRACK MAGNETIC TAPE (D433X,YY,Z)

Where: X = Version  
      YY = Update Level  
      Z = Fix Level

- Q010 TAPE DEVICE NUMBER? (DRT #)
3. Q011 TIMER DEVICE NUMBER? (DRT #)
  4. Q012 MAXIMUM ERROR PRINT COUNT?
  5. P005 TYPE FOLLOWING CONTROL  
      A'CR'-AUTO,       R'CR'-RESTART  
      M'CR'-MANU,      'CR'-RESUME,   YOUR CODE?
  6. D015 PRESENT SECTION REGISTER:%077414 DO YOU WISH TO  
   CHANGE? (YES/NO)

SWITCH REGISTER OPTIONS:

BIT	FUNCTION
---	-----
0	Select External Switch Register
1	Set to Change Section Register
2-6	Not Used
7	D, E-Class Messages to Line Printer
8	Not Used
9	Suppress E-Class Messages
10	Suppress D-Class Messages
11	Loop on Current Step
12	Halt on Error
13	Halt at End of Current Step
14	Halt After Current Section
15	Halt After Pass Through Diagnostic



## 7970B/E MAGNETIC TAPE DRIVE DIAGNOSTIC (Continued)

## SECTION REGISTER OPTIONS:

BIT ---	FUNCTION -----
0	Not Used
1	Execute Section 1 (Auto - Basic Control)
2	Execute Section 2 (Auto - Control, Dev, Status, Space)
3	Execute Section 3 (Auto - File Mark - 800 CPI Only)
4	Execute Section 4 (Auto - CRCC, Drop-Out)
5	Execute Section 5 (Auto - Timing)
6	Execute Section 6 (Auto - BOT, EOT, Creeping)
7	Execute Section 7 (Auto - Read/Write)
8	Not Used
11	Execute Section 11 (Manu - Head Test)
12	Execute Section 12 (Manu - Start/Stop)
13	Execute Section 13 (Manu - Reel Protection)
14	Execute Section 14 (Manu - Tape Test)
15	Execute Section 15 (Manu - Write/Read)

Diagnostics

SYNCHRONOUS SINGLE-LINE CONTROLLER (SSLC)  
STAND-ALONE DIAGNOSTIC - D434

1. For running the first six test sections in synchronous mode, attach interface cable 30055-60011 to the SSLC and terminate the free end with the 30055-60009 test connector. For running the first six test sections in asynchronous (hardwired) mode, attach interface cable 30055-60010 to the SSLC and terminate the free end with the 30055-60009 test connector.
2. Cold Load diagnostic D434 from the stand-alone diagnostic tape. Type "CR" on console.
3. Program halts (HALT 6). Set bit 0 of the operating panel switch register OFF. Press RUN.

In case of hardware error, error messages will be printed.

PRESET CONFIGURATION

DB+0	Switch Register	0
DB+1	Section Select Options	%177000 1,2,3,4,5,6
DB+2	Version Update	
DB+3	Device Number	
DB+4	Max Error Number	200
DB+5	Clock DRT	3

## SYNCHRONOUS SINGLE-LINE CONTROLLER DIAGNOSTIC (Continued)

## SWITCH REGISTER OPTIONS:

BIT	FUNCTION
---	-----
0	Update Switch Register
1	Section Selection
2-6	Spare
7	Use Line Printer
8	Spare
9	Suppress Non-Error Messages
10	Suppress Error Messages
11	Loop on Step
12	Halt on Error
13	Halt After Step
14	Halt After Section
15	Halt After Complete Program Cycle

## HALT ASSIGNMENTS:

NO. (OCTAL)	FUNCTION
-----	-----
0-4	Spare
5	Enter Section Select Options
6	Enter Switch Register Options
7-11	Spare
12	Error Halt
13	End of Step or End of Section
14	Spare
15	End of Test Cycle
16	Spare
17	Maximum Error Limit Reached

Diagnostics

UNIVERSAL INTERFACE AND 30219A CARD READER/PUNCH INTERFACE  
STAND-ALONE LOAD DIAGNOSTIC - D435

1. Install Diagnostic Hardware PCA (HP 30049C)
2. Cold Load Diagnostic File from Non-CPU Cold Load Tape.
3. D100 UNIV. INTERFACE TEST (HP D435A.00.0)
4. Q110 DEVICE NUMBER? (DRT # (DECIMAL))
5. Q112 INTERRUPT MASK (ENABLED)
6. Q113 NEGATIVE TRUE? (YES OR NO)
7. Q114 CHANGE INTERNAL SWITCH REGISTER?

Bit 9 of Internal Switch Register is preset to suppress non-error messages.

Halts to allow switch register setting.

- |    |                              |
|----|------------------------------|
| 0  | Use External Switch Register |
| 1  | Change Section Flag Register |
| 7  | Line Printer                 |
| 9  | Suppress Non-Error Messages  |
| 10 | Suppress Error Message       |
| 11 | Loop on Step                 |
| 12 | Halt After Error             |
| 13 | Halt After Step              |
| 14 | Halt at End of Section       |
| 15 | Halt at End of Pass          |

8. Q115 SECTION LIST? Enter Sections to be tested. (1 thru 10)
9. Q116 READER-PUNCH INTERFACE? (YES OR NO)

SWITCH REGISTER OPTIONS:

BIT	FUNCTION
---	-----
0	Used only in the System Switch Register to override the Internal Switch Register settings made when the program was prepared or started.
1	Change Section Flag Register
4-6	Spare
7	Use the Line Printer
8	Spare
9	Suppress Non-Error messages
10	Suppress Error messages
11	Loop one repeat to Current Step
12	Halt on Error
13	Halt After Step
14	Halt at End of Section
15	Halt at End of Pass

## UNIVERSAL IF &amp; 30219A CARD READER/PUNCH IF DIAGNOSTIC (Continued)

## SECTION NUMBER TABLE:

SECTION NUMBER	NAME	STEPS
-----	----	-----
(none)	None. These are secondary steps that can be part of primary steps in the following sections or part of other secondary steps.	1 thru 22
(none)	Control	100 thru 106
0	Configuration	110 thru 114
1	HP 30049C Diagnostic	120 thru 122,
	Hardware User Checks	124
2	HP 30049C Diagnostic	130 thru 140
	Hardware Program Tests	
3	Data Transfer and Device Status Byte Tests	150 thru 155
4	Device Status Interrupt Bit Tests	160 thru 174
5	Interface Interrupt Status Bit Tests	200 thru 211
6	Interrupt Tests	220 thru 224
7	SIO Tests	230 thru 233
8	SIO-Device End Tests	240 thru 245
9	Jumper Option Tests	250 thru 271
10	Basic Functions	300 and 301

## HALT ASSIGNMENTS:

HALT NUMBER	%0303XX (IN CIR)	SEGMENT NUMBER*	DEFINITION
-----	-----	-----	-----
N/A	N/A	06	Cold load is finished; press RUN-HALT.
00	60	20	An unexpected external interrupt has occurred; irrecoverable error.
01	61	22	Stand-alone relocating loader requests a program number.
02	62	22	Stand-alone relocating loader request the program origin.
04	64	20	A system clock error has occurred; irrecoverable error.
05	65	N/A	Spare
06	66	20	Set the Internal Switch Register.
07	67	20	Observe lamps on the HP 30049C Diagnostic Hardware.
10	70	20	Check jumpers on the HP 30049C Diagnostic Hardware.
11	71	20	Check DEV END on the HP 30049C

Diagnostics

UNIVERSAL IF & 30219A CARD READER/PUNCH IF DIAGNOSTIC (Continued)

HALT ASSIGNMENTS (Continued):

HALT NUMBER	%0303XX (IN CIR)	SEGMENT NUMBER*	DEFINITION
12	72	20	Diagnostic Hardware. Press I/O RESET, check that lamps CONT6 and 7 on the HP 30049C Diagnostic Hardware turn off, then press RUN-HALT.
13	73	20	Check pins on the HP 30049C Diagnostic Hardware.
14**	74	20	Section uu has finished; see uu or a related step number in the RA Register; also see the RB, RC and RD Registers**. Change Switch Register Options, etc., then press RUN-HALT.
13	75	20	Step sss or ppp has finished; see the RA Register, bits 1 through 6 for the secondary step number sss, and bits 8 through 15 for the primary step number ppp; also see the RB, RC, and RD Registers**. Change Switch Register Options, then press RUN-HALT.
12	76	20	This program has found an error; the RA, RB, RC, and RD Registers are as defined for HALT 15**. Change Switch Register Options, etc., then press RUN-HALT.
15	77	20	This program has completed a pass. To run it again, decide whether or not to change Switch Register Options, then press RUN-HALT.

\* The segment number can be seen in the Computer's Status Register bits 8 through 15.

\*\* At HALTs 14, 15, and 16 these Registers contain data:

- RB - Interface/Interrupt Status Word (see the Maintenance Manual for the interface being tested).
- RC - The data word read, where applicable.
- RD - The data word written, where applicable.

TERMINAL CONTROLLER INTERFACE (TCI)  
STAND-ALONE DIAGNOSTIC - D438

1. Remove all connectors from HP 30062A Terminal Controller/Multiplexer connector panel, 30062-60002. Connection will be made between channel pairs by test cable 30062-60003 during the test.
2. Cold load diagnostic D438 from stand-alone diagnostic tape. Program will halt (HALT 6). Press RUN with switch register bit 0 OFF, to run diagnostic with preset configuration. In the preset configuration, the channel selection is manual.
3. Channel Selection -- The program halts for channel selection with HALT 7 before the execution of the first test and with HALT %16 after the completion of the test for any channel pair. The test will be executed between the two channels whose channel number is entered through the switch register. One channel number should be entered to the first byte of the switch register and the other in the second byte. Both numbers are octal (0-17) and right justified in their respective byte position. The connection should be made between the two specified channels by the test cable.

In order to make a complete test of the interface (all 16 channels), 8 successive channel selections should be made. The following convenient order is recommended by: Channel 0 channel 1 first, channel 2 channel 3 second and so on until channel 14, channel 15.

4. After each channel selection, the program will halt again with HALT 6 for switch register option selection. Press RUN (with switch register bit 0 kept OFF).
5. The program will halt after each channel pair test with HALT %16, if the interface is error free. Errors will be indicated by error halts (HALT %12). Error information will be displayed on the "TOS."

Diagnostics

TERMINAL CONTROLLER INTERFACE DIAGNOSTIC (Continued)

SWITCH REGISTER OPTIONS:

BIT ---	FUNCTION -----
0	Select External Switch Register
1	Set to Change Section Selection Register (Switch Bit 0 Also Set)
2-4	Spare
5	Mode Select Off: Automatic/On: Manual
6	Inhouse Use Only
7-10	Spare
11	Loop on Last Pass
12	Halt on Error
13	Halt at End of Pass
14	Halt at End of Section
15	Halt After Complete Program Cycle

HALT ASSIGNMENTS:

BIT ---	FUNCTION -----
0	Halt for Reconfigure - Enter DRT
1-4	Spare
5	Halt for Section Switch Register Entry
6	Halt to Restore External Switch Register Entry
7	Halt for Channel Selection (Manual Mode)
10	Spare
11	Spare
12	Error Halt
13	Halt After Pass
14	Halt After Section
15	Halt After Complete Program Cycle/Automatic
16	Halt After Complete Program Cycle/Manual
17	Spare



PLOTTER INTERFACE  
STAND-ALONE DIAGNOSTIC - D439

1. Cold Load Diagnostic File from Non-CPU Cold Load Tape.
2. On console device, press "Carriage Return". Enter switch register options. Program halts (HALT 6).
3. To run diagnostic with preset configuration, press RUN with operating panel switch register bit 0 OFF.
4. The diagnostic will start to execute. Messages on the console device will instruct the operator when intervention is necessary. The preconfigured section selection is only for test section 1. In this test section, the only operator intervention is the installation of the test connector (30226-60003). The program prints a corresponding message on the console and halts (HALT 7). Install test connector and press RUN.
5. The program either runs to completion and halts with HALT %15 indicating that the interface is error-free or in case of error it will print error message(s).

## SWITCH REGISTER OPTIONS

BIT ---	FUNCTION -----
0	Update Switch Register
1	Change Section Selection
2-4	Spare
5	Suppress "PEN UP" and "PEN DOWN" delay messages
6	Spare
7	Use Line Printer
8	Spare
9	Suppress Non-Error Messages
10	Suppress Error Messages
11	Loop on Test Step
12	Halt on Error
13	Halt at End of Step
14	Halt After Section
15	Halt After Complete Program Cycle

Diagnostics

PLOTTER INTERFACE DIAGNOSTIC (Continued)

HALT ASSIGNMENTS:

NO. (OCTAL) -----	FUNCTION -----
0	Spare
1	Unexpected Traps
2-4	Spare
5	Halt for Section Switch Register Entry
6	Halt for External Switch Register Entry
7	Halt for Installing Test Connector
10	Spare
11	Spare
12	Error Halt
13	Halt After Step
14	Halt After Section
15	Halt After Complete Program Cycle
16	Spare
17	Maximum Error Limit Reached

HP 32234A COBOL II FIRMWARE  
 STAND-ALONE DIAGNOSTIC - D441A AND D442A

1. Cold load diagnostic file from non-CPU cold load tape.
2. Enter number corresponding to the diagnostic's position on the cold load tape (%26 or %27) into the Switch Register.
3. Press CPU front panel RUN switch and assert "CR" on system console.

## NOTE

Both diagnostics will loop indefinitely unless Switch Register bit 15 is set.

## SWITCH REGISTER OPTIONS:

BIT# -----	FUNCTION -----
0	When set, causes SWREG1 to be loaded with the configuration set into the Switch Register.
1	When set, causes program execution to stop for re-configuration.
2-6	Unused
7	When set, directs messages to line printer.
8	Unused
9	When set, suppresses non-error messages.
10	When set, suppresses error messages.
11	Unused
12	When set, causes program execution to stop with HALT %12 in the CIR if a recoverable error is detected.
13-14	Unused
15	When set, causes program execution to stop with HALT %15 in the CIR after one complete pass through the diagnostic.

Diagnostics

COBOL II FIRMWARE DIAGNOSTIC (Continued)

HALT ASSIGNMENTS:

BITS 12-15

HALT CODE

ASSIGNMENT

-----

-----

01	Irrecoverable error. Recold-load program to continue.
05	Select instruction test.
12	Recoverable error. Press RUN to continue.
15	End of pass through complete program.

NOTES

Diagnostics

NOTES

# CONTRIBUTED SLEUTH PROGRAMS

SECTION

X

## Table Of Contents

Topic	Page
Supported SLEUTH Batch Programs .....	10-2
Commonly Used SLEUTH Commands .....	10-3
SLEUTH01 - 2893A Card Reader .....	10-5
SLEUTH03 - 2608/13/17/18/19 Line Printers .....	10-8
SLEUTH04 - 7905A Disc Drive .....	10-11
SLEUTH06 - 2894A Card Reader/Punch .....	10-12
SLEUTH07 - 7905A/7920A/7925A Disc Drives .....	10-14
SLEUTH08 - 7920A Disc Drive .....	10-18
SLEUTH11 - 2893A Card Reader (Section I) .....	10-23
SLEUTH12 - 2893A Card Reader (Section II) .....	10-26
SLEUTH13 - 2893A Card Reader (Section III) .....	10-28
SLEUTH14 - 2893A Card Reader (Section IV) .....	10-31
2608/13/17/18/19 Line Printers Miscellaneous Programs .....	10-34
2893A Card Reader Miscellaneous Programs .....	10-34
2895A Paper Tape Punch Miscellaneous Programs .....	10-35
7905A/7920A/7925A Disc Drive Miscellaneous Program .....	10-36
7905A Disc Drive Miscellaneous Programs .....	10-37
7920A Disc Drive Miscellaneous Programs .....	10-42
7925A Disc Drive Miscellaneous Programs .....	10-45
7970B/E Magnetic Tape Drive Miscellaneous Programs .....	10-48



Contributed SLEUTH Programs

SUPPORTED SLEUTH BATCH PROGRAMS

PERIPHERAL TESTED	DIAGNOSTIC NAME
2893A Card Reader	SLEUTH01
Line Printers	SLEUTH03
7905 Disc Drive	SLEUTH04
2894A Card Reader/Punch	SLEUTH06
7905A/20A/25A Disc Verifier	SLEUTH07
7920A Disc Drive	SLEUTH08
2893A Card Reader *	SLEUTH11
2893A Card Reader *	SLEUTH12
2893A Card Reader *	SLEUTH13
2893A Card Reader *	SLEUTH14

\* SLEUTH11 through SLEUTH14 are sectionalized versions of On-Line Card Reader Verification No. D465.



## COMMONLY USED SLEUTH COMMANDS

Command Name (MNEMONIC)	Syntax
Auto Numbering Resumed (AUTO)	> AUTO [step n]
Backspace Flie (BSF)	> BSF lun
Backspace Record (BSR)	> BSR lun
Batch (BA)	> BA [record] or [E]
Bump Pass Counter (BUMP)	> BUMP [P]
Change Buffer (CHB)	> CHB buf,type
Compare Buffer (CB)	> CB lun,buf 1,buf 2,errcount[,max-count]
Configure (CONF)	> CONF
Decremental Seek (DS)	> DS lun[,cylinder,head,sector]
Define Buffer (DB)	> DB name,length,datatype
Device (DEV)	> DEV lun,drt,type,errs,unit[,baud]
End (END)	> END
Erase Program (EP)	> EP[S]
Flag Track Defective (FTD)	> FTD lun[,cylinder,head,sector]
Flag Track Defective Immediate (FTDI)	> FTDI lun
For (FOR)	> FOR simple variable=initial value TO final value
Format (FMT)	> FMT lun[,retry]
Forward Space File (FSF)	> FSF lun
Forward Space Record (FSR)	> FSR lun
Gap (GAP)	> GAP lun
Get (GET)	> GET [var] or [lun,D or T or E or B or U]
Go (GO)	> GO stepn,status,mask
Go To (GOTO)	> GOTO stepn
If (IF)	> IF <pri><relop><pri>THEN<step>
Incremental Track (IT)	> IT lun[,cylinder,head,sector]
Initialize Data (ID)	> ID lun,buf[,mask[,flag[,cylinder,head,sector]]]
Initialize Data Immediate (IDI)	> IDI lun,buf[,mask[,flag]]
Let (LET)	> LET <var>=<expr>
List (LIST)	> LIST var[,base]
Loop (LOOP)	> LOOP stepn,count
Make Test Tape (MAKT)	> MAKT A or MAKT N
Master Clear (MC)	> MC lun
Next (NEXT)	> NEXT var
Put (PUT)	> PUT "string"
Randomize (RAND)	> RAND var
Random Seek (RS)	> RS lun
Read (READ)	> READ buf[,C]

## Contributed SLEUTH Programs

## COMMONLY USED SLEUTH COMMANDS (Continued)

Command Name (MNEMONIC)	Syntax
Read Data (RD)	> RD lun,buf[,mask[,cylinder,head,sector]] (7905/7920/7925 discs) > RD lun,buf,mode (card readers, SEL CHAN MAINT card, and paper tape readers) > RD lun,buf (mag tape and devices connected to Asynchronous Mux) > RD lun,buf[,mode[,hopper[,stacker]]] (Reader/Interpreter/Punch)
Read Data Immediate (RDI)	> RDI lun,buf[,mask]
Rewind (REW)	> REW lun
Rewind and Reset (RST)	> RST lun
Ripple (RP)	> RP lun,linelength
Run (RUN)	> RUN
Seek (SEEK)	> SEEK lun[,cylinder,head,sector]
Seek Read Data (SKRD)	> SKRD lun,buf[,mask[,cylinder,head,sector]]
Seek Write Data (SRWD)	> SRWD lun,buf[,mask[,cylinder,head,sector]]
Set Mask (SMSK)	> SMSK maskword
Test I/O (TIO)	> TIO lun
Verify (VER)	> VER lun,seccount[,cylinder,head,sector]
Verify Immediate (VERI)	> VERI lun,seccount
Write Data (WD)	> WD lun,buf[,mask[,cylinder,head,sector]] (7905/7920/7925 discs) > WD lun,buf,linelength (terminal devices connected to Asynchronous Multiplexer) > WD lun,buf,mode,linelength (line-printers) > WD lun,buf,mode (paper tape punch and SEL CHAN MAINT card) > WD lun,buf (mag tape and plotter) > WD lun,buf[,mode[,print[,hopper[,stacker]]]] (reader/punch)
Write Data Immediate (WDI)	> WDI lun,buf[,mask]
Write File Mark (WFM)	> WFM lun
Zero Buffer (ZBUF)	> ZBUF buf

## SLEUTH01 - 2893A CARD READER

THIS PROGRAM TESTS THE BASIC FUNCTIONS OF THE 2893A CARD READER. THE TEST DECK MAY BE GENERATED USING THE READER/PUNCH SLEUTH GENERATED TEST. THE TEST DECK CONSISTS OF THE FOLLOWING CARDS.

1 - DOUBLE CARD  
 1 - INVALID HOLLERITH CARD  
 1 - COLUMN BINARY CARD  
 1 - PACKED BINARY CARD  
 56 - ASCII CARDS (BASIC CHARACTER SET)  
 1 - BLANK CARD

THE STEPS AND FUNCTIONS PERFORMED ARE AS FOLLOWS:

STEPS -----	FUNCTION -----
40/410	CHECKS CORRECT OPERATION OF MANUALLY OPERATED SWITCHES AND BUTTONS.
420	TESTS INTERRUPT CAPABILITY WITH SIN.
430/490	CHECKS THROAT GAP ALIGNMENT.
530/570	TESTS INVALID HOLLERITH READ.
580/590	CHECKS COLUMN BINARY READ.
600/610	CHECKS PACKED BINARY READ.
620/750	TESTS DATA PATTERN AND CHARACTER SET.
760	PRINTS END OF PASS MESSAGE.

```

10 DEV 0,8,2,200,0
10 DB AA,40,0
10 DB CC,80,0
10 DB DD,40,0
10 DB EE,40,0
10 DB FF,60,%125252
10 DB GG,60,0
10 DB BB,80,W
1(%777),1(0),1(%5252),1(%2525)
10 PUT "30106/30107 CARD READER STANDALONE (00.0)"
20 PUT "ENTER DRT NUMBER"
30 GET 0,D
40 MC 0
50 PUT "SET OFFLINE SWITCH TO OFFLINE"
60 HALT
70 TIO 0
80 LET A=TIO
90 IF A=%2045 THEN 140
100 PUT " "
110 STAT T
120 PUT "          EXPECTED 0 000 010 000 100 101"
130 PUT " "
140 PUT "SET OFFLINE SWITCH TO ONLINE"
150 HALT
160 TIO 0

```

Contributed SLEUTH Programs

SLEUTH01 (Continued)

```
170 LET A=TIO
180 IF A=%2041 THEN 230
190 PUT " "
200 STAT T
210 PUT "          EXPECTED 0 000 010 000 100 001"
220 PUT " "
230 PUT "EXTEND STACKER ARM"
240 HALT
250 TIO 0
260 LET A=TIO
270 IF A=%2141 THEN 320
280 PUT " "
290 STAT T
300 PUT "          EXPECTED 0 000 010 001 100 001"
310 PUT " "
320 PUT "RELEASE STACKER ARM"
330 PUT "PRESS EOF BUTTON"
340 HALT
350 TIO 0
360 LET A=TIO
370 IF A=%2241 THEN 420
380 PUT " "
390 STAT T
400 PUT "          EXPECTED 0 000 010 010 100 001"
410 PUT " "
430 PUT "PLACE DOUBLE CARD IN READER, PRESS RESET"
440 SED 0
450 HALT
460 MC 0
470 SED 1
480 ESTA %13,0
490 RD 0,AA,A
500 PUT "REMOVE DOUBLE CARD"
510 PUT "PLACE TEST DECK IN READER, PRESS RESET"
520 SED 0
530 HALT
540 MC 0
550 SED 1
560 ESTA %103022,0
570 RD 0,AA,A
580 RD 0,CC,C
590 CB 0,BB,CC,4
600 RD 0,GG,P
610 CB 0,FF,GG,4
620 CHB DD,%21042
630 FOR I=0 TO 55
640 RD 0,EE,A
650 CB 0,DD,EE,4
660 IF I<>9 THEN 680
670 CHB DD,%26054
680 CHB DD,I
690 FOR J=0 TO 7
700 CHB DD,S
```

Contributed SLEUTH Programs

SLEUTH01 (Continued)

```
710 NEXT J
720 CHB DD,I
730 NEXT I
740 ESTA Z2041,0
750 RD 0,EE,A
760 BUMP P
770 END
```

Contributed SLEUTH Programs

SLEUTH03 - 2608/13/17/18/19 LINE PRINTERS

THIS PROGRAM TESTS THE BASIC FUNCTIONS OF 2608/13/17/18/19 LINE PRINTERS. THE STEPS AND FUNCTIONS PERFORMED ARE AS FOLLOWS:

STEPS -----	FUNCTIONS -----
215/255	CHECKS ABILITY TO PRINT USING DIRECT I/O.
260/575	CHECKS VERTICAL SPACING AND TIMING.
580/640	PRINTS THE BASIC CHARACTER SET.
645	PRINTS A RIPPLE PRINT PATTERN.
650/665	PRINTS E PATTERN.
670/680	PRINTS M PATTERN.
685/695	PRINTS H PATTERN.
700/755	PRINTS TRIANGULAR M PATTERN.

```
10 DEV 0,12,5,150,0
10 DB SS,6,S
SINGLE SPACE
10 DB DS,6,S
DOUBLE SPACE
10 DB TS,6,S
TRIPLE SPACE
10 DB TF,6,S
TOP OF FORMS
10 DB BF,7,S
BOTTOM OF FORM
10 DB HP,4,S
1/2 PAGE
10 DB QP,4,S
1/4 PAGE
10 DB SP,4,S
1/6 PAGE
10 DB AX,13,S
DONE IN      MILLISECONDS
10 DB XX,66,0
10 DB PE,1,%20040
5 PUT "2608/2613/2617/2618/2619 LINE PRINTER STANDALONE (00.0)"
10 PUT "ENTER DRT NUMBER"
20 GET 0,D
200 MC 0
205 CIO 0,%40000
210 SED 1
215 CIO 0,4
220 WIO 0,%41511
225 WIO 0,%47440
230 WIO 0,%40516
235 WIO 0,%42040
240 WIO 0,%53511
245 WIO 0,%47440
250 WIO 0,%47513
255 CIO 0,%60
```

## SLEUTH03 (Continued)

```
260 WIO 0,%102
285 WD 0,PE,%100,1
290 SCLK 0
295 WD 0,TF,%100,12
300 RCLK A
305 LET A=A+A/1000
310 ASC A,AX(8),10
315 WD 0,AX,%100,26
320 LOOP 290,1
325 WD 0,PE,%101,1
330 SCLK 0
335 WD 0,BF,%101,14
340 RCLK A
345 LET A=A+A/1000
350 ASC A,AX(8),10
355 WD 0,AX,%101,26
360 LOOP 330,1
365 WD 0,PE,%100,1
370 SCLK 0
375 WD 0,SS,%102,12
380 RCLK A
385 LET A=A+A/1000
390 ASC A,AX,(8),10
395 WD 0,AX,%102,26
400 LOOP 370,29
405 SCLK 0
410 WD 0,DS,%103,12
415 RCLK A
420 LET A=A+A/1000
425 ASC A,AX,(8),10
430 WD 0,AX,%103,26
435 LOOP 405,14
440 SCLK 0
445 WD 0,TS,%104,12
450 RCLK A
455 LET A=A+A/1000
460 ASC A,AX,(8),10
465 WD 0,AX,%104,26
470 LOOP 440,9
475 SCLK 0
480 WD 0,HP,%105,8
485 RCLK A
490 LET A=A+A/1000
495 ASC A,AX,(8),10
500 WD 0,AX,%105,26
505 LOOP 475,3
510 SCLK 0
515 WD 0,QP,%106,8
520 RCLK A
525 LET A=A+A/1000
530 ASC A,AX(8),10
535 WD 0,AX,%106,26
```

Contributed SLEUTH Programs

SLEUTH03 (Continued)

```
540 LOOP 510,1
545 SCLK 0
550 WD 0,SP,%107,8
555 RCLK A
560 LET A=A+A/1000
565 ASC A,AX,(8),10
570 WD 0,AX,%107,26
575 LOOP 545,2
580 CHB XX,%21042
585 FOR I=0 TO 55
590 WD 0,XX,%102,132
595 IF I<>9 THEN 605
600 CHB XX,%26054
605 CHB XX,I
610 FOR J=0 TO 7
615 CHB XX,S
620 NEXT J
625 CHB XX,I
630 NEXT I
635 WD 0,PE,%100,1
640 LOOP 640,10000
645 RP 0,132
650 WD 0,PE,%100,1
655 CHB XX,%42505
660 WD 0,XX,%102,132
665 LOOP 660,59
670 CHB XX,%46515
675 WD 0,XX,%102,132
680 LOOP 675,59
685 CHB XX,%44110
690 WD 0,XX,%102,132
695 LOOP 690,59
700 LET A=131
705 FOR I=0 TO 131
710 CIO 0,0
715 FOR L=0 TO A
720 WIO 0,%115
725 TIO 0
730 GO 725,%40000,%137777
735 NEXT L
740 CIO 0,%60
745 WIO 0,1
746 TIO 0
747 GO 746,%40000,%137777
750 LET A=A-1
755 NEXT I
760 END
```



## SLEUTH04 - 7905A DISC DRIVE

THIS PROGRAM EXERCISES A 7905 DISK DRIVE. IT IS PRIMARILY DESIGNED TO CHECK CORRECT FUNCTIONING OF THE SERVO SYSTEM. SINCE ONLY SEEKS AND READS ARE ISSUED, ANY DATA ON THE DISK IS LEFT STILL INTACT. IF A TEST FAILS, THE STEPS INVOLVED IN GENERATING THAT TEST MAY BE TYPED IN AND LOOPED ON FOR TROUBLESHOOTING PURPOSES.

```
DEV 0,5,15,400,0
10 DEV 0,5,15,400,0
10 DB AA,128,0
10 DB BB,6144,0
10 PROC
20 RS 0
30 LOOP 20,2000
40 IS 0
50 DS 0
60 LOOP 40,2000
70 IS 0
80 RDI 0,BB
90 DS 0
100 RDI 0,BB
110 LOOP 70,3000
120 LET D=400
130 RAND I
140 LET A=I MOD 10
150 LET B=D+A
160 SKRD 0,AA,7,B,0,A
170 LET D=D-5
180 IF D>10 THEN 130
190 LOOP 120,200
200 SEEK 0
210 SEEK 0,410,0,0
230 LOOP 200,500
240 LET D=0
250 RAND I
260 LET A=I MOD 50
270 LET B=D+A
280 SKRD 0,AA,7,B,0,0
290 LET D=D+20
300 IF D<360 THEN 250
310 LOOP 240,200
320 LET D=2
330 SKRD 0,AA,D,0,24
340 LET D=D+D
350 IF D<400 THEN 330
360 LOOP 320,100
370 BUMP P
380 LOOP 20,1
390 END
```

Contributed SLEUTH Programs

SLEUTH06 - 2894A CARD READER/PUNCH

THIS PROGRAM TESTS THE PUNCH AND READ FUNCTIONS OF THE 2894A CARD READER/PUNCH

```
10 DEV 0,15,10,500,0
10 DB IH,1,%1777
10 DB CB,80,W
1(%7777),1(0),1(%5252),1(%2525)
10 DB PB,60,%5252
10 DB WD,40,0
10 DB RD,80,0
10 PUT "THE TRIVIAL READER/PUNCH STANDALONE (00.0)"
20 PUT "ENTER IRT NUMBER"
30 GET 0,D
40 SED 0
50 MC 0
60 CIO 0,%40000
70 SED 1
80 PUT "PLACE 60 CARDS IN THE PRIMARY HOPPER"
90 PUT "SET PUNCH READY"
100 HALT
110 WD 0,IH,C
120 WD 0,CB,C
130 WD 0,PB,C
140 CHB WD,%21042
150 FOR I=0 TO 55
160 WD 0,WD
170 IF I<>9 THEN 190
180 CHB WD,%26054
190 FOR J=0 TO 7
200 CHB WD,S
210 NEXT J
220 CHB WD,I
230 NEXT I
240 PUT "TEST DECK 1 PUNCHED"
250 PUT "REMOVE PUNCHED DECK FROM STACKER"
260 PUT "PLACE DECK IN SECONDARY HOPPER"
270 HALT
280 RD 0,RB,C
290 CB 0,IH,RB,1
300 RD 0,RB,C
310 CB 0,CB,RB,3
320 RD 0,RB,C
330 CB 0,PB,RB,3
340 CHB WD,%21402
350 FOR I=0 TO 55
360 RD 0,RB
365 CHB WD,I
370 IF I<>9 THEN 390
380 CHB WD,%26054
390 FOR J=0 TO 7
400 CHB WD,S
410 NEXT J
```

SLEUTH06 (Continued)

```
420 CHB WD,I
430 PUT "TEST DECK 1 VERIFIED"
440 END
```

Contributed SLEUTH Programs

SLEUTH07 - 7905A/7920A/7925A DISC DRIVES

NOTE

Additional information for running SLEUTH07 is contained in Section IX of this manual.

THIS PROGRAM TESTS WHETHER THE DISC DRIVE RESPONDS TO UNIT NUMBER TYPED ON THE CONSOLE, PERMITS DISC PACK FORMATTING AND VERIFICATION, AND TESTS WHETHER THE DISC HEADS CAN READ AND WRITE BOTH WITH AND WITHOUT TRACK SWITCHING.

```
5 DEV 0,4,12,999,0
5 DB AA,3072,W
1(%155555),1(%133333),1(%066666)
5 DB BB,3072,0
5 DB CC,4096,W
1(%155555),1(%133333),1(%066666)
5 DB DD,4096,0
5 DB CY,4,W
1(410),1(822),1(410),1(822)
5 DB HD,4,W
1(3),1(4),1(2),1(8)
5 DB SC,4,W
1(47),1(47),1(47),1(63)
5 DB SR,2,0
5 NAME ST
5 CONT 1,%1400
5 READ SR
5 ENDS,I
5 PUT "7905/7920/7925 VERIFIER, ENTER DRT#"
10 GET 0,D
15 MC 0
20 TIO 0
25 GO 5,%100000,7
30 PUT "UNIT SELECT SWITCH TEST? (0=N,1=Y)"
35 GET A
40 IF A=0 THEN 95
45 FOR I=0 TO 7
50 PUT "ENTER UNIT#, SET SWITCH TO UNIT# ENTERED, PRESS RUN"
55 GET 0,U
60 NOPR
65 HALT
70 LOOP 70,200
75 PR
80 RC 0
85 GO 50,%117400,7
90 NEXT I
95 PUT "ENTER UNIT# TO BE TESTED"
100 GET 0,U
105 RC 0
110 GO 95,%117400,7
115 PUT "I NEED UNIT# ONE MORE TIME"
```

## SLEUTH07 (Continued)

```

120 GET A
125 ACB D=ST(1)
130 LET D=D AND %177770 OR A
135 ACB ST(1)=D
140 SIO 0,ST,1,10,%100000,7
145 ACB D=SR(1)
150 LET T=D LSR 9 AND %17
155 ACB C=CY(T)
160 ACB H=HD(T)
165 PUT "FORMAT PACK? (0=N,1=Y)"
170 GET X
175 PUT "VERIFY PACK? (0=N,1=Y)"
180 GET Y
185 IF Y=0 THEN 200
190 PUT "VERIFY, LONG PASS? (0=N,1=Y)"
195 GET Z
200 IF X=0 THEN 410
205 PUT "BEGIN FORMAT"
210 SEEK 0
215 FOR I=0 TO 1
220 IDI 0,AA,3,N
225 GO 235,%100000,7
230 GOTO 260
235 IF I=1 THEN 875
240 PUT "DISC IS READ ONLY OR FORMAT SWITCH OFF"
245 PUT "CORRECT CONDITION, PRESS RUN"
250 HALT
255 NEXT I
260 ACB S=SC(T)
265 LET S=(S+1)/2
270 FOR I=0 TO C
275 FOR J=0 TO H
280 SEEK 0,I,J,0
285 IF T<>3 THEN 305
290 IDI 0,CC
295 ID 0,CC,2,N,I,J,S
300 GOTO 315
305 IDI 0,AA
310 ID 0,AA,2,N,I,J,S
315 NEXT J
320 NEXT I
325 ACB D=HD(T)
330 ACB E=SC(T)
335 LET S=(D+1)*(E+1)
340 FOR I=0 TO C
345 SEEK 0,I,0,0
350 VERI 0,S
355 LET D=TIO AND %177770
360 IF D=%100000 THEN 400
365 SS
370 RDA 0
375 ES
380 DISP 0,D

```

Contributed SLEUTH Programs

SLEUTH07 (Continued)

```
400 NEXT I
405 PUT "END FORMAT"
410 SEEK 0
415 FOR I=0 TO 1
420 WDI 0,AA,7
425 GO 435,%100000,7
430 GOTO 455
435 IF I=1 THEN 875
440 PUT "DISC IS READ ONLY, CORRECT CONDITION, PRESS RUN"
445 HALT
450 NEXT I
455 IF Y=0 THEN 645
460 PUT "BEGIN VERIFY"
465 LET P=1
470 IF Z=0 THEN 480
475 LET P=3
480 FOR N=1 TO P
485 CHB AA,S
490 CHB CC,S
495 FOR I=0 TO C
500 FOR J=0 TO H
505 IF T<>3 THEN 565
510 SKWD 0,CC,6,I,J,0
515 SKRD 0,DD,6,I,J,0
520 GO 530,%100000,7
525 GOTO 535
530 CB 0,CC,DD,3
535 SKWD 0,CC,6,I,J,32
540 SKRD 0,DD,6,I,J,32
545 GO 555,%100000,7
550 GOTO 615
555 CB 0,CC,DD,3
560 GOTO 615
565 SKWD 0,AA,6,I,J,0
570 SKRD 0,BB,6,I,J,0
575 GO 585,%100000,7
580 GOTO 590
585 CB 0,AA,BB,3
590 SKWD 0,AA,6,I,J,24
595 SKRD 0,BB,6,I,J,24
600 GO 610,%100000,7
605 GOTO 615
610 CB 0,AA,BB,3
615 NEXT J
620 NEXT I
625 PUT "VERIFY, PASS#"
630 LIST N
635 NEXT N
640 PUT "END VERIFY"
645 PUT "BEGIN MAIN"
650 RC 0
655 FOR J=0 TO H
660 RAND D
```

Contributed SLEUTH Programs

SLEUTH07 (Continued)

```

665 LET I=D MOD (C+1)
670 ACB S=SC(T)
675 RAND D
680 LET K=D MOD S
685 SKWD 0,AA,7,I,J,K
690 SKRD 0,BB,7,I,J,K
695 CB 0,AA,BB,3
700 NEXT J
705 LOOP 655,40
710 PUT "END HEAD TEST"
715 LET S=S-2
720 FOR J=0 TO H
725 RAND D
730 LET I=D MOD (C+1)
735 SKWD 0,CC,7,I,J,S
740 SKRD 0,DD,7,I,J,S
745 CB 0,CC,DD,3
750 NEXT J
755 LOOP 720,40
760 PUT "END TRACK SWITCH TEST"
765 RAND D
770 LET I=D MOD (C+1)
775 LET J=D MOD (H+1)
780 LET K=D MOD (S+2)
785 SKWD 0,AA,7,I,J,K
790 RS 0
795 SKRD 0,BB,7,I,J,K
800 GO 810,%100000,7
805 GOTO 815
810 CB 0,AA,BB,3
815 RS 0
820 SKWD 0,CC,7,I,J,K
825 RS 0
830 SKRD 0,DD,7,I,J,K
835 GO 845,%100000,7
840 GOTO 850
845 CB 0,CC,DD,3
850 CHB AA,S
855 CHB CC,R
860 LOOP 765,250
865 PUT "END WRITE/READ TEST"
870 GOTO 890
875 RQST 0
880 DISP 0,R
885 PUT "STATUS ERROR"
890 END

```

Contributed SLEUTH Programs

SLEUTH08 - 7920A DISC DRIVE

THIS PROGRAM IS A MULTIPLE DISC EXERCISER. THE EXERCISER WILL SEQUENCE THROUGH DISC UNIT 0 THROUGH DISC UNIT N, PERFORMING RANDOM WRITE/READ OPERATIONS.

```
3 DEV 0,4,15,999,0
6 DEV 1,4,15,999,1
9 DEV 2,4,15,999,2
12 DEV 3,4,15,999,3
15 DEV 4,4,15,999,4
18 DEV 5,4,15,999,5
21 DEV 6,4,15,999,6
24 DEV 7,4,15,999,7
27 DB AA,3072,W
1(%155555),1(%133333),1(%066666)
30 DB BB,3072,0
33 DB EE,1024,R
36 DB FF,1024,0
39 PUT "START OF 7920 EXERCISER"
42 PUT "ENTER NUMBER OF UNITS TO BE TESTED"
45 GET X
48 RAND D
51 LET A=D MOD 813
54 LET C=D MOD 47
57 RC 0
60 FOR B=0 TO 4
63 SKWD 0,EE,7,A,B,45
66 RDI 0,FF,7
69 GO 75,%100000,0
72 IF X=X THEN 78
75 CB 0,EE,FF,3
78 RS 0
81 SKWD 0,AA,7,A,B,C
84 RS 0
87 SKRD 0,BB,7,A,B,C
90 GO 96,%100000,0
93 IF X=X THEN 99
96 CB 0,AA,BB,3
99 RS 0
102 SKWD 0,EE,7,A,B,C
105 RS 0
108 SKRD 0,FF,7,A,B,C
111 GO 117,%100000,0
114 IF X=X THEN 120
117 CB 0,EE,FF,3
120 NEXT B
123 IF X<2 THEN 606
126 RC 1
129 FOR B=0 TO 4
132 SKWD 1,EE,7,A,B,45
135 RDI 1,FF,7
```



## SLEUTH08 (Continued)

```
138 GO 144,%100001,0
141 IF X=X THEN 147
144 CB 1,EE,FF,3
147 RS 1
150 SKWD 1,AA,7,A,B,C
153 RS 1
156 SKRD 1,BB,7,A,B,C
159 GO 165,%100001,0
162 IF X=X THEN 168
165 CB 1,AA,BB,3
168 RS 1
171 SKWD 1,EE,7,A,B,C
174 RS 1
177 SKRD 1,FF,7,A,B,C
180 GO 186,%100001,0
183 IF X=X THEN 189
186 CB 1,EE,FF,3
189 NEXT B
192 IF X<3 THEN 606
195 RC 2
198 FOR B=0 TO 4
201 SKWD 2,EE,7,A,B,45
204 RDI 2,FF,7
207 GO 213,%100002,0
210 IF X=X THEN 216
213 CB 2,EE,FF,3
216 RS 2
219 SKWD 2,AA,7,A,B,C
222 RS 2
225 SKRD 2,BB,7,A,B,C
228 GO 234,%100002,0
231 IF X=X THEN 237
234 CB 2,AA,BB,3
237 RS 2
240 SKWD 2,EE,7,A,B,C
243 RS 2
246 SKRD 2,FF,7,A,B,C
249 GO 255,%100002,0
252 IF X=X THEN 258
255 CB 2,EE,FF,3
258 NEXT B
261 IF X<4 THEN 606
264 RC 3
267 FOR B=0 TO 4
270 SKWD 3,EE,7,A,B,45
273 RDI 3,FF,7
276 GO 282,%100003,0
279 IF X=X THEN 285
282 CB 3,EE,FF,3
285 RS 3
288 SKWD 3,AA,7,A,B,C
291 RS 3
```

Contributed SLEUTH Programs

SLEUTH08 (Continued)

```
294 SKRD 3,BB,7,A,B,C
297 GO 303,%100003,0
300 IF X=X THEN 306
303 CB 3,AA,BB,3
306 RS 3
309 SKWD 3,EE,7,A,B,C
312 RS 3
315 SKRD 3,FF,7,A,B,C
318 GO 324,%100003,0
321 IF X=X THEN 327
324 CB 3,EE,FF,3
327 NEXT B
330 IF X<5 THEN 606
333 RC 4
336 FOR B=0 TO 4
339 SKWD 4,EE,7,A,B,45
342 RDI 4,FF,7
345 GO 351,%100004,0
348 IF X=X THEN 354
351 CB 4,EE,FF,3
354 RS 4
357 SKWD 4,AA,7,A,B,C
360 RS 4
363 SKRD 4,BB,7,A,B,C
366 GO 372,%100004,0
369 IF X=X THEN 375
372 CB 4,AA,BB,3
375 RS 4
378 SKWD 4,EE,7,A,B,C
381 RS 4
384 SKRD 4,FF,7,A,B,C
387 GO 393,%100004,0
390 IF X=X THEN 396
393 CB 4,EE,FF,3
396 NEXT B
399 IF X<6 THEN 606
402 RC 5
405 FOR B=0 TO 4
408 SKWD 5,EE,7,A,B,45
411 RDI 5,FF,7
414 GO 420,%100005,0
417 IF X=X THEN 423
420 CB 5,EE,FF,3
423 RS 5
426 SKWD 5,AA,7,A,B,C
429 RS 5
432 SKRD 5,BB,7,A,B,C
435 GO 441,%100005,0
438 IF X=X THEN 444
441 CB 5,AA,BB,3
444 RS 5
447 SKWD 5,EE,7,A,B,C
```

## SLEUTH08 (Continued)

```
450 RS 5
453 SKRD 5,FF,7,A,B,C
456 GO 462,%100005,0
459 IF X=X THEN 465
462 CB 5,EE,FF,3
465 NEXT B
468 IF X<7 THEN 606
471 RC 6
474 FOR B=0 TO 4
477 SKWD 6,EE,7,A,B,45
480 RDI 6,FF,7
483 GO 489,%100006,0
486 IF X=X THEN 492
489 CB 6,EE,FF,3
492 RS 6
495 SKWD 6,AA,7,A,B,C
498 RS 6
501 SKRD 6,BB,7,A,B,C
504 GO 510,%100006,0
507 IF X=X THEN 513
510 CB 6,AA,BB,3
513 RS 6
516 SKWD 6,EE,7,A,B,C
519 RS 6
522 SKRD 6,FF,7,A,B,C
525 GO 531,%100006,0
528 IF X=X THEN 534
531 CB 6,EE,FF,3
534 NEXT B
537 IF X<8 THEN 606
540 RC 7
543 FOR B=0 TO 4
546 SKWD 7,EE,7,A,B,45
549 RDI 7,FF,7
552 GO 558,%100007,0
555 IF X=X THEN 561
558 CB 7,EE,FF,3
561 RS 7
564 SKWD 7,AA,7,A,B,C
567 RS 7
570 SKRD 7,BB,7,A,B,C
573 GO 579,%100007,0
576 IF X=X THEN 582
579 CB 7,AA,BB,3
582 RS 7
585 SKWD 7,EE,7,A,B,C
588 RS 7
591 SKRD 7,FF,7,A,B,C
594 GO 600,%100007,0
597 IF X=X THEN 603
600 CB 7,EE,FF,3
603 NEXT B
```

Contributed SLEUTH Programs

SLEUTH08 (Continued)

```
606 CHB AA,S
609 CHB EE,R
612 LOOP 48,100
615 BUMP P
618 IF X=X THEN 48
621 END
```

## Contributed SLEUTH Programs

## SLEUTH11 - 2893A CARD READER (SECTION I)

READY/NOT READY STATUS CHECK - THIS PROGRAM TESTS THE OPERATION OF THE RESET, STOP, AND END-OF-FILE MOMENTARY SWITCHES, THE ON-LINE/OFF-LINE TOGGLE SWITCH, AND THE HOPPER/STACKER STATUS BITS.

```
10 DEV 0,126,2,999,0
10 DB AA,80,W
80(0)
10 DB BB,8,W
1(%7777),1(0),1(%3777),1(%5777),1(%6777),1(%7377),1(%7577),1(%7677)
10 DB CC,7,W
1(%7737),1(%7757),1(%7767),1(%7773),1(%7775),1(%7776),1(%4000)
10 DB DD,9,W
1(%2000),1(%1000),1(%400),1(%200),1(%100),1(%40),1(%20),1(%10),1(%4)
10 DB EE,2,W
1(%2),1(%1)
10 DB FF,14,W
1(%5252),1(%2525)
10 DB GG,10,W
1(%15040),6(%15032),1(%23055),1(%30061),1(%31063)
10 DB HH,10,W
1(%32065),1(%33067),1(%34071),7(%15032)
10 DB II,5,W
1(%177760),1(%177),1(%175777),1(%157776),1(%177767)
10 DB JJ,5,W
1(%177677),1(%176777),1(%167777),1(%77773),1(%177737)
10 DB KK,5,W
1(%177200),1(%2000),1(%20001),1(%10),1(%100)
10 DB LL,5,W
1(%1000),1(%10000),1(%100004),1(%40),1(%652)
10 DB MM,10,W
1(%122525),1(%125245),1(%52652)
10 DB NN,40,W
40(0)
10 DB OO,20,%20040
10 DB YY,80,0
10 NAME XX
10 JUMP *+4,C
10 JUMP *+6
10 CONT 0,%11
10 READ YY
10 ENDS,I
20 SED 0
25 PUT "SLEUTH11(00.0) 2893A/30206A DIAG"
30 PUT "SECTION 1"
40 PUT "POWER ON,PRESS RUN ON COMPUTER"
45 HALT
46 MC 0
47 SED 1
```

Contributed SLEUTH Programs

SLEUTH11 (Continued)

```
50 PUT "PRESS RESET, WAIT FOR STOP LIGHT LIT, PRESS RUN ON
COMPUTER"
60 HALT
70 TIO 0
80 LET A=TIO
90 IF A=%2041 THEN 140
110 STAT T
120 PUT "                EXPECTED 0 000 010 000 100 001"
140 PUT "LOAD HOPPER WITH ONE CARD, PRESS RESET"
150 PUT "WHEN RESET LIGHT LIT, PRESS RUN ON COMPUTER"
160 SED 0
170 HALT
180 TIO 0
190 LET A=TIO
200 IF A=%122000 THEN 250
220 STAT T
230 PUT "                EXPECTED 1 010 010 000 000 000"
250 MC 0
260 SED 1
270 PUT "EXTEND STACKER ARM TO LIMIT, PRESS RUN ON COMPUTER"
280 HALT
290 TIO 0
300 LET A=TIO
310 IF A=%2141 THEN 360
330 STAT T
340 PUT "                EXPECTED 0 000 010 001 100 001"
360 MC 0
370 PUT "RELEASE STACKER ARM, PRESS RUN ON COMPUTER"
380 HALT
390 TIO 0
400 LET A=TIO
410 IF A=%2001 THEN 460
430 STAT T
440 PUT "                EXPECTED 0 000 010 000 000 001"
460 PUT "SWITCH CARD READER TO OFFLINE, PRESS RUN ON COMPUTER"
465 HALT
470 TIO 0
475 LET A=TIO
480 IF A=%2005 THEN 505
490 STAT T
495 PUT "                EXPECTED 0 000 010 000 000 101"
505 MC 0
510 PUT "SWITCH CARD READER TO ONLINE, PRESS RUN ON COMPUTER"
515 HALT
520 TIO 0
525 LET A=TIO
530 IF A=%2001 THEN 555
540 STAT T
545 PUT "                EXPECTED 0 000 010 000 000 001"
555 MC 0
560 PUT "PRESS RESET, WHEN RESET LIGHT LIT, PRESS RUN ON COMPUTER"
565 SED 0
```

SLEUTH11 (Continued)



```
570 HALT
575 TIO 0
580 LET A=TIO
585 IF A=%122000 THEN 610
595 STAT T
600 PUT "          EXPECTED 1 010 010 000 000 000"
610 MC 0
615 SED 1
620 PUT "PRESS STOP ON CARD READER,PRESS RUN ON COMPUTER"
625 HALT
630 TIO 0
635 LET A=TIO
640 IF A=%2001 THEN 655
645 STAT T
650 PUT "          EXPECTED 0 000 010 000 000 001"
655 MC 0
660 PUT "PRESS RESET.WHEN RESET LIGHT LIT,PRESS RUN ON COMPUTER"
663 SED 0
665 HALT
670 TIO 0
675 LET A=TIO
680 IF A=%122000 THEN 695
685 STAT T
690 PUT "          EXPECTED 1 010 010 000 000 000"
695 MC 0
700 SED 1
705 PUT "PRESS EOF.WHEN EOF LIGHT LIT,PRESS RUN ON COMPUTER"
710 HALT
715 SIO 0,XX,1,1000,%2241,0
720 PUT "PRESS EOF.PRESS RUN ON COMPUTER"
725 HALT
730 TIO 0
735 LET A=TIO
740 IF A=%2041 THEN 755
745 STAT T
750 PUT "          EXPECTED 0 000 010 000 100 001"
755 PUT "END SECTION 1"
760 END
```

Contributed SLEUTH Programs

SLEUTH12 - 2893A CARD READER (SECTION II)

STATUS INDICATORS CHECK - THIS PROGRAM USES THE TEST DECK OF CARDS (P/N 30206-60006) TO TEST MOTION CHECK, PICK CHECK, AND READ CHECK ERROR CIRCUITS OF THE CARD READER.

```
10 DEV 0,126,2,999,0
10 DB YY,80,0
20 SED 0
21 PUT "SLEUTH12(00.0) 2893A/30206A DIAG."
22 PUT "SECTION 2"
25 PUT "POWER ON.PRESS RUN ON COMPUTER"
27 HALT
30 MC 0
35 SED 1
40 PUT "PRESS EOF.PRESS RUN ON COMPUTER"
45 HALT
50 TIO 0
55 LET A=TIO
60 IF A=%2241 THEN 75
65 STAT T
70 PUT "          EXPECTED 0 000 010 010 100 001"
75 PUT "PRESS RESET.WAIT FOR STOP LIGHT LIT,PRESS RUN ON
COMPUTER"
80 SED 0
85 HALT
90 TIO 0
95 LET A=TIO
100 IF A=%2041 THEN 115
105 STAT T
110 PUT "          EXPECTED 0 000 010 000 100 001"
115 MC 0
120 SED 1
125 PUT "PRESS EOF.WHEN LIGHT LIT,PRESS RUN ON COMPUTER"
130 HALT
135 TIO 0
140 LET A=TIO
145 IF A=%2241 THEN 160
150 STAT T
155 PUT "          EXPECTED 0 000 010 010 100 001"
160 MC 0
165 TIO 0
170 LET A=TIO
175 IF A=%2041 THEN 190
180 STAT T
185 PUT "          EXPECTED 0 000 010 000 100 001"
190 DELY 15
195 SIN 0
200 MC 0
205 PUT "LOAD ERROR DECK.PRESS RESET"
210 PUT "WHEN RESET LIGHT LIT,PRESS RUN ON COMPUTER"
212 SED 0
```



## SLEUTH12 (Continued)

```
215 HALT
216 MC 0
217 SED 1
220 DELY 15
221 RD 0,YY,P
222 ESTA %2013,0
223 DELY 15
224 RD 0,YY,P
225 PUT "CLEAR STACKER.PRESS RESET"
230 PUT "WHEN RESET LIGHT LIT,PRESS RUN ON COMPUTER"
232 SED 0
235 HALT
240 MC 0
245 SED 1
246 ESTA %2013,0
247 DELY 30
250 RD 0,YY,P
255 PUT "CLEAR HOPPER OF DOUBLE CARD.PRESS RESET"
260 PUT "WHEN RESET LIGHT LIT,PRESS RUN ON COMPUTER"
265 SED 0
270 HALT
275 MC 0
280 SED 1
285 DELY 15
290 RD 0,YY,P
292 ESTA %6003,0
294 DELY 15
295 RD 0,YY,P
300 PUT "PRESS RESET.WHEN RESET LIGHT LIT,PRESS RUN ON COMPUTER"
305 SED 0
310 HALT
315 MC 0
320 SED 1
325 LET I=0
330 DELY 30
335 RD 0,YY,P
340 LET I=I+1
345 IF I<3 THEN 330
350 PUT "END SECTION 2"
360 END
```

Contributed SLEUTH Programs

SLEUTH13 - 2893A CARD READER (SECTION III)

WORST CASE DATA CHECK - THIS PROGRAM USES THE TEST DECK OF CARDS (P/N 30206-60006) WHICH CONTAINS THE THEORETICAL WORST CASE HOLE PATTERNS, USING ALL THREE MODES: PACKED BINARY, COLUMN BINARY, AND HOLLERITH-TO-ASCII.

```
10 DEV 0,126,2,999,0
10 DB AA,80,W
80(0)
10 DB BB,8,W
1(%7777),1(0),1(%3777),1(%5777),1(%6777),1(%7377),1(%7577),1(%7677)
10 DB CC,7,W
1(%7737),1(%7757),1(%7767),1(%7773),1(%7775),1(%7776),1(%4000)
10 DB DD,9,W
1(%2000),1(%1000),1(%400),1(%200),1(%100),1(%40),1(%20),1(%10),1(%4)
10 DB EE,2,W
1(%2),1(%1)
10 DB FF,14,W
1(%5252),1(%2525)
10 DB GG,10,W
1(%15040),6(%15032),1(%23055),1(%30061),1(%31063)
10 DB HH,10,W
1(%32065),1(%33067),1(%34071),7(%15032)
10 DB II,5,W
1(%177760),1(%177),1(%175777),1(%157776),1(%177767)
10 DB JJ,5,W
1(%177677),1(%176777),1(%167777),1(%77773),1(%177737)
10 DB KK,5,W
1(%177200),1(%2000),1(%20001),1(%10),1(%100)
10 DB LL,5,W
1(%1000),1(%10000),1(%100004),1(%40),1(%652)
10 DB MM,10,W
1(%122525),1(%125245),1(%52652)
10 DB NN,40,W
40(0)
10 DB OO,20,%20040
10 DB YY,80,0
10 NAME XX
10 JUMP *+4,C
10 JUMP *+6
10 CONT 0,%11
10 READ YY
10 ENDS,I
20 SED 0
21 PUT "SLEUTH13(00.0) 2893A/30206A DIAG."
22 PUT "SECTION 3"
23 PUT "PLACE TEST DECK IN READER.PRESS RESET"
24 PUT "WHEN RESET LIGHT LIT,PRESS RUN ON COMPUTER"
25 HALT
26 MC 0
```

## SLEUTH13 (Continued)

```
27 SED 1
28 DELY 15
30 LET I=0
31 RD 0,AA,C
32 LET N=0
35 CB 0,BB,AA,1,1
37 LET N=N+1
39 CHB BB,W
40 CHB AA,W
41 IF N<8 THEN 35
45 LET N=0
46 CB 0,CC,AA,1,1
47 LET N=N+1
48 CHB CC,W
49 CHB AA,W
50 IF N<7 THEN 46
54 LET N=0
55 CB 0,DD,AA,1,1
56 LET N=N+1
57 CHB DD,W
58 CHB AA,W
60 IF N<9 THEN 55
62 LET N=0
65 CB 0,EE,AA,1,1
66 LET N=N+1
67 CHB EE,W
68 CHB AA,W
69 IF N<2 THEN 65
74 LET N=0
75 CB 0,FF,AA,1,1
76 LET N=N+1
77 CHB FF,W
78 CHB AA,W
79 IF N<14 THEN 75
84 LET N=0
85 CB 0,NN,AA,1,40
86 ZBUF AA
87 LET I=I+1
90 IF I<5 THEN 31
95 CHB AA,%20040
96 ESTA %103022,0
97 DELY 25
100 RD 0,AA,A
105 CB 0,GG,AA,1,1
106 LET N=N+1
107 CHB GG,W
108 CHB AA,W
109 IF N<10 THEN 105
110 LET N=0
115 CB 0,HH,AA,1,1
116 LET N=N+1
117 CHB HH,W
```

Contributed SLEUTH Programs

SLEUTH13 (Continued)

```
118 CHB AA,W
119 IF N<10 THEN 115
120 LET N=0
125 CB 0,00,AA,1,20
126 LET I=I+1
127 IF I<10 THEN 95
128 ZBUF AA
129 DELY 15
130 RD 0,AA,P
135 CB 0,II,AA,1,1
136 LET N=N+1
137 CHB II,W
138 CHB AA,W
139 IF N<5 THEN 135
144 LET N=0
145 CB 0,JJ,AA,1,1
146 LET N=N+1
147 CHB JJ,W
148 CHB AA,W
149 IF N<5 THEN 145
154 LET N=0
155 CB 0,KK,AA,1,1
156 LET N=N+1
157 CHB KK,W
158 CHB AA,W
159 IF N<5 THEN 155
164 LET N=0
165 CB 0,LL,AA,1,1
166 LET N=N+1
167 CHB LL,W
168 CHB AA,W
169 IF N<5 THEN 165
174 LET N=0
175 CB 0,MM,AA,1,1
176 LET N=N+1
177 CHB MM,W
178 CHB AA,W
179 IF N<10 THEN 175
180 LET N=0
181 CB 0,NN,AA,1,30
182 LET I=I+1
185 IF I<15 THEN 128
190 PUT "END SECTION 3"
200 END
```

Contributed SLEUTH Programs

SLEUTH14 - 2893A CARD READER (SECTION IV)

DATA PATTERN CHECK - THIS PROGRAM USES THE TEST DECK OF CARDS  
(P/N 30206-60006) IN THE PACKED BINARY AND HOLLERITH-TO-ASCII  
MODES.

```
10 DEV 0,126,2,999,0
10 DB AA,80,W
80(0)
10 DB BB,8,W
1(%7777),1(0),1(%3777),1(%5777),1(%6777),1(%7377),1(%7577),1(%7677)
10 DB CC,7,W
1(%7737),1(%7757),1(%7767),1(%7773),1(%7775),1(%7776),1(%4000)
10 DB DD,9,W
1(%2000),1(%1000),1(%400),1(%200),1(%100),1(%40),1(%20),1(%10),1(%4)
10 DB EE,2,W
1(%2),1(%1)
10 DB FF,14,W
1(%5252),1(%2525)
10 DB GG,10,W
1(%15040),6(%15032),1(%23055),1(%30061),1(%31063)
10 DB HH,10,W
1(%32065),1(%33067),1(%34071),7(%15032)
10 DB II,5,W
1(%177760),1(%177),1(%175777),1(%157776),1(%177767)
10 DB JJ,5,W
1(%177677),1(%176777),1(%167777),1(%77773),1(%177737)
10 DB KK,5,W
1(%177200),1(%2000),1(%20001),1(%10),1(%100)
10 DB LL,5,W
1(%1000),1(%10000),1(%100004),1(%40),1(%652)
10 DB MM,10,W
1(%122525),1(%125245),1(%52652)
10 DB NN,40,W
40(0)
10 DB OO,20,%20040
10 DB YY,80,0
10 NAME XX
10 JUMP **4,C
10 JUMP **6
10 CONT 0,%11
10 READ YY
10 ENDS,I
20 SED 0
21 PUT "SLEUTH14(00.0) 2893A/30206A DIAG."
22 PUT "SECTION 4"
25 PUT "PLACE TEST DECK IN READER,PRESS RESET"
26 PUT "WHEN RESET LIGHT LIT,PRESS RUN ON COMPUTER"
28 HALT
29 MC 0
```

Contributed SLEUTH Programs

SLEUTH14 (Continued)

```
30 SED 1
31 LET A=%1
32 LET N=0
33 LET I=0
34 LET B=%20040
35 CHB AA,%20040
40 DELY 15
41 RD 0,AA,A
50 ACB YY(N)=A
60 LET N=N+1
70 LET A=A+%1002
80 IF N<32 THEN 50
82 ACB YY(N)=B
83 LET N=N+1
84 IF N<39 THEN 82
90 CB 0,YY,AA,1,39
100 LET N=0
105 LET I=I+1
110 IF I<4 THEN 40
120 LET A=%15032
130 ESTA %103022,0
131 DELY 15
132 RD 0,AA,A
140 ACB YY(N)=A
150 LET N=N+1
160 IF N<39 THEN 140
170 CB 0,YY,AA,1,39
180 LET N=0
185 LET I=I+1
190 IF I<6 THEN 130
200 ZBUF AA
210 LET A=%377
215 LET I=I+1
216 DELY 15
220 RD 0,AA,P
230 ACB YY(N)=A
240 LET N=N+1
250 LET A=NOT A
255 IF N=57 THEN 300
260 ACB YY(N)=A
270 LET N=N+1
280 LET A=(NOT A)+%377
290 IF N<57 THEN 230
300 CB 0,YY,AA,1,57
305 LET N=0
306 IF I=15 THEN 400
310 LET I=I+1
311 IF I=15 THEN 392
315 RD 0,AA,P
320 IF I=8 THEN 260
330 IF I=9 THEN 230
340 IF I=10 THEN 260
```

SLEUTH14 (Continued)

```
350 IF I=11 THEN 230
360 IF I=12 THEN 260
370 IF I=13 THEN 230
380 IF I=14 THEN 260
392 ESTA %2041,0
393 DELY 15
395 RD 0,AA,P
396 GOTO 230
400 PUT "END SECTION 4"
410 END
```

Contributed SLEUTH Programs

2608/13/17/18/19 LINE PRINTERS  
MISCELLANEOUS PROGRAMS

RIPPLE PRINT

```
>10 DEV 0,DRT#,5,100,0
>10 RP 0,132
>10 END
```

PRINTS SINGLE LINES OF "H"

```
>10 DEV 0,DRT#,5,100,0
>10 DB AA,66,S
>H
>10 WD 0,AA,1,132
>20 LOOP 10,1000
>30 END
```

2893A CARD READER  
MISCELLANEOUS PROGRAMS

READS A DECK OF 20 IDENTICAL CARDS  
(ALL CARDS MUST BE THE SAME)

```
>10 DEV 0,DRT#,2,10,0
>10 DB AA,80,0
>10 DB BB,80,0
>10 RD 0,AA,C
>20 LOOP 20,10
>30 RD 0,BB,C
>40 CB 0,AA,BB,1
>50 LOOP 30,19
>60 END
```

READS CARD AND PRINTS THE PATTERN ON LP

```
>10 DEV 0,DRT#,2,10,0
>10 DEV 1,DRT#,XX,10,0
>10 DB AA,80,0
>10 RD 0,AA,A
>20 WD 1,AA,001,66
>30 LOOP 10,10
>40 END
```

XX=DEVICE TYPE OF LINE PRINTER



Contributed SLEUTH Programs

2895A PAPER TAPE PUNCH  
MISCELLANEOUS PROGRAMS

PUNCHES PATTERN ON TAPE. (HOLD TAPE UP TO LIGHT. IT SHOULD READ  
GSD.)

```
>10 DEV 0,DRT#,21,15,0
>10 DB AA,33,W
1(%076201),1(%100601),1(%047000),1(0),1(%060621),1(%105104),
1(0),1(%000377),1(%100502),1(%022030),1(0)
>10 WD 0,AA,B
>20 END
```

TEST WILL PUNCH PAPER TAPE, THEN READ  
ON TAPE READER

```
>10 DEV 0,DRT#,21,15,0
>10 DEV 1,DRT#,20,15,0
>10 DB AA,300,R
>10 DB BB,300,0
>10 WD 0,AA,B
>20 HALT
>30 RD 1,BB
>40 CB 1,AA,BB,5
>50 END
```

Contributed SLEUTH Programs

7905A/7920A/7925A DISC DRIVE  
MISCELLANEOUS PROGRAM

THIS PROGRAM WILL ALLOW ONE TO REWRITE THE DISC VOLUMN NAME AND SIO COLD LOAD PROGRAM. \*\*\*\*CAUTION\*\*\*\* THIS PROGRAM SHOULD BE USED WITH CAUTION AND ONLY AS A LAST RESORT. BEFORE USING, YOU MUST KNOW THE COMPLETE CONTENTS OF CYLINDER ZERO, HEAD ZERO, AND SECTOR ZERO.

```
>10 DEV 0,DRT#,(11,12, OR 15),10,0
>10 DB AA,128,0
>10 DB BB,128,0
>10 FOR A=0 TO 15
>20 PUT "ENTER IN OCTAL (%), WORD #"
>30 LIST A
>40 GET B
>50 ACB AA(A)=B
>60 NEXT A
>70 NOPR
>80 RC 0
>90 PR
>100 WDI 0,AA
>110 RC 0
>120 RDI 0,BB
>130 CB 0,AA,BB,1
>140 FOR A=0 TO 15
>150 PUT "WORD NUMBER"
>160 LIST A
>170 ACB B=BB(A)
>180 PUT "CONTAINS A OCTAL VALUE OF "
>190 LIST B
>200 LOOP 200,10000
>210 NEXT A
>220 END
```

7905A DISC DRIVE  
MISCELLANEOUS PROGRAMS

FORMATTING DISC PACK

```
>10 DEV 0,DRT#,15,100,0
>10 FMT 0,9
>20 END
```

FORMATTING AND VERIFYING DISC PACK

```
>10 DEV 0,DRT#,15,10,0
>10 DB AA,3072,W
1(%155555),1(%133333),1(%066666)
>10 RC 0
>20 FOR A=0 TO 410
>30 FOR B=0 TO 2
>40 SEEK 0,A,B,0
>50 IDI 0,AA,3,N
>60 ID 0,AA,3,N,A,B,24
>70 NEXT B
>80 NEXT A
>90 FOR A=0 TO 410
>100 FOR B=0 TO 2
>110 SEEK 0,A,B,0
>120 VER 0,48,A,B,0
>130 NEXT B
>140 NEXT A
>150 END
```

Contributed SLEUTH Programs

7905A DISC DRIVE  
MISCELLANEOUS PROGRAMS (Continued)

RANDOM WRITE/READ

```
>10 DEV 0,DRT#,15,10,0
>10 DB AA,3072,W
1(%155555),1(%133333),1(%066666)
>10 DB BB,3072,0
>10 RAND D
>20 LET A=D MOD 400
>30 LET B=D MOD 2
>40 LET C=D MOD 47
>50 SKWD 0,AA,7,A,B,C
>60 RS 0
>70 SKRD 0,BB,7,A,B,C
>80 GO 100,%100000,7
>90 IF X=X THEN 10
>100 CB 0,AA,BB,3
>110 END
```

THIS PROGRAM WILL MEASURE THE SEEK TIME AND DISPLAY THIS TIME ON THE CONSOLE. THE DSU IS NOT NEEDED FOR THIS MEASUREMENT.

```
>10 DEV 0,DRT#,15,10,0
>10 PUT "FOR 7905 TYPE 410"
>20 GET A
>30 FOR X=0 TO 100
>40 SCLK 0
>50 SEEK 0,A,0,0
>60 SEEK 0,0,0,0
>70 LOOP 50,49
>80 RCLK B
>90 SCLK 0
>100 SEEK 0,0,0,0
>110 LOOP 100,99
>120 RCLK C
>130 LET B=B-C
>140 LET B=B/101
>150 IF X<2 THEN 160
>160 PUT "SEEK TIME IS"
>170 LIST B
>180 NEXT X
>190 END
```

7905A DISC DRIVE  
MISCELLANEOUS PROGRAMS (Continued)

READ/WRITE TEST

```
>10 DEV 0,DRT#,15,999,0
>10 DB AA,128,R
>10 DB BB,128,0
>10 DB CC,128,R
>10 DB DD,128,0
>10 IS 0
>20 WDI 0,AA
>30 RDI 0,BB
>40 CB 0,AA,BB,1
>50 CHB AA,R
>60 LOOP 10,5
>70 RS 0
>80 DS 0
>90 WDI 0,CC
>100 IS 0
>110 WDI 0,AA
>120 DS 0
>130 RDI 0,DD
>140 CB 0,CC,DD,1
>150 IS 0
>160 RDI 0,BB
>170 CB 0,AA,BB,1
>180 CHB AA,R
>190 CHB CC,R
>200 LOOP 70,450
>210 LOOP 10,50
>220 END
```

TESTS SPARING FUNCTION

```
>10 DEV 0,DRT#,15,100,0
>10 DB AA,6144,0
>10 SEEK 0,10,0,0
>20 ID 0,AA,3,D,400,0,0
>30 SEEK 0,400,0,0
>40 ID 0,AA,3,S,10,0,0
>50 SEEK 0,10,0,0
>60 RDI 0,AA,7
>70 LOOP 60,10
>80 END
```

Contributed SLEUTH Programs

7905A DISC DRIVE  
MISCELLANEOUS PROGRAMS (Continued)

THIS PROGRAM SEARCHES A 7905A DISC FOR THE LOCATION OF A SPECIFIED FILE NAME.

```
>10 DEV 0,DRT#,15,100,0
>15 PUT "FIND FILE LABELS"
>20 DEV 1,7,6,10,0,2400
>25 PUT "WHAT IS THE BAUD RATE OF YOUR CONSOLE?"
>30 DB AA,6144,0
>35 GET 1,B
>40 DB BB,16,0
>45 PUT "WHAT IS THE UNIT # OF THE 7905 YOU WANT TO SEARCH?"
>50 GET 0,U
>60 PUT "FILE NAME (LEFT JUSTIFIED,UPPERCASE,NO CONTROL-X OR H)?"
>70 CHB BB,%20040
>80 RD 1,BB,8
>90 PUT " "
>100 ACB W=BB(0)
>110 ACB X=BB(1)
>120 ACB Y=BB(2)
>130 ACB Z=BB(3)
>140 GOTO 160
>150 PUT "STRIP OFF PARITY BIT"
>160 LET W=W AND %77577
>170 LET X=X AND %77577
>180 LET Y=Y AND %77577
>190 LET Z=Z AND %77577
>200 FOR C=0 TO 399
>210 FOR H=0 TO 2
>220 SEEK 0,C,H,0
>230 RDI 0,AA,%67
>240 FOR S=0 TO 47
>250 LET J=S*128
>260 ACB E=AA(J)
>270 IF W<>E THEN 590
>280 LET J=J+1
>290 ACB E=AA(J)
>300 IF X<>E THEN 590
>310 LET J=J+1
>320 ACB E=AA(J)
>330 IF Y<>E THEN 590
>340 LET J=J+1
>350 ACB E=AA(J)
>360 IF Z<>E THEN 590
>370 GOTO 400
>380 PUT "FILE FOUND. MOVE GROUP AND ACCOUNT INTO"
>390 PUT "BUFFER AND PRINT"
>400 FOR K=4 TO 11
>410 LET J=J+1
>420 ACB E=AA(J)
>430 ACB BB(K)=E
```

7905A DISC DRIVE  
MISCELLANEOUS PROGRAMS (Continued)

```
>440 NEXT K
>450 WD 1, BB, 32
>460 PUT "IS THE FILE, GROUP, ACCOUNT CORRECT? (Y/N)"
>470 RD 1, AA, 1
>480 ACB E=AA(0)
>490 GOTO 510
>500 PUT "UPSHIFT, MASK OFF PARITY & SECOND BYTE"
>510 LET E=E AND %57400
>520 IF E=%47000 THEN 590
>530 IF E<>%54400 THEN 450
>540 PUT "CYL, HEAD, SECTOR WHERE FILE FOUND:"
>550 LIST C
>560 LIST H
>570 LIST S
>580 GOTO 60
>590 NEXT S
>600 NEXT H
>620 NEXT C
>630 PUT "FILE NOT FOUND, SORRY"
>640 GOTO 60
>650 END
```

Contributed SLEUTH Programs

7920A DISC DRIVE  
MISCELLANEOUS PROGRAMS

FORMATTING AND VERIFYING DISC PACK

```
>10 DEV 0,DRT#,12,10,0
>10 DB AA,3072,W
1(%155555),1(%133333),1(%066666)
>10 RC 0
>20 FOR A=0 TO 822
>30 FOR B=0 TO 4
>40 SEEK 0,A,B,0
>50 IDI 0,AA,3,N
>60 ID 0,AA,3,N,A,B,24
>70 NEXT B
>80 NEXT A
>90 FOR A=0 TO 822
>100 FOR B=0 TO 4
>110 SEEK 0,A,B,0
>120 VER 0,48,A,B,0
>130 NEXT B
>140 NEXT A
>150 END
```

FLAGS DEFECTIVE TRACKS

```
>10 DEV 0,DRT#,12,10,0
>10 DB AA,6144,0
>10 RC 0
>20 PUT "CYLINDER # TO BE FLAGGED DEFECTIVE?"
>30 GET A
>40 PUT "HEAD #?"
>50 GET B
>60 SEEK 0,A,B,0
>70 IDI 0,AA,3,D
>80 PUT "CONTINUE?"(0=N/1=Y)
>90 GET C
>100 IF C=1 THEN 10
>110 END
```



7920A DISC DRIVE  
MISCELLANEOUS PROGRAMS (Continued)

## SERVO TEST

```
>10 DEV 0,DRT#,12,99,0
>10 LET A=822
>20 RC 0
>30 SEEK 0,A,0,0
>40 LOOP 20,50
>50 FOR A=0 TO 822
>60 LET B=823-A
>70 SEEK 0,A,0,0
>80 SEEK 0,B,0,0
>90 NEXT A
>100 LOOP 50,30
>110 RAND B
>120 LET B=B MOD 821
>130 SEEK 0,B,0,0
>140 RC 0
>150 LOOP 110,10
>160 END
```

## RANDOM WRITE/READ

```
>10 DEV 0,DRT#,12,10,0
>10 DB AA,3072,W
1(%155555),1(%133333),1(%066666)
>10 DB BB,3072,0
>10 RAND D
>20 LET A=D MOD 813
>30 LET B=D MOD 4
>40 LET C=D MOD 47
>50 SKWD 0,AA,7,A,B,C
>60 RS 0
>70 SKRD 0,BB,7,A,B,C
>80 GO 100,%100000,7
>90 IF X=X THEN 10
>100 CB 0,AA,BB,3
110 END
```

Contributed SLEUTH Programs

7920A DISC DRIVE  
MISCELLANEOUS PROGRAMS (Continued)

TESTS SPARING FUNCTION

```
>10 DEVO,DRT#,12,100,0
>10 DB AA,6144,0
>10 LET A=815
>10 SEEK 0,10,0,0
>20 ID 0,AA,3,D,A,0,0
>30 SEEK 0,A,0,0
>40 ID 0,AA,3,S,10,0,0
>50 SEEK 0,10,0,0
>60 RDI 0,AA,7
>70 LOOP 60,10
>80 END
```

THIS PROGRAM WILL MEASURE THE SEEK TIME AND DISPLAY THIS SEEK TIME ON THE CONSOLE. THE DSU IS NOT NEEDED FOR THIS MEASUREMENT.

```
>10 DEV 0,DRT#,12,10,0
>10 PUT "FOR 7920 TYPE 822"
>20 GET A
>30 FOR X=0 TO 100
>40 SCLK 0
>50 SEEK 0,A,0,0
>60 SEEK 0,0,0,0
>70 LOOP 50,49
>80 RCLK B
>90 SCLK 0
>100 SEEK 0,0,0,0
>110 LOOP 100,99
>120 RCLK C
>130 LET B=B-C
>140 LET B=B/101
>150 IF X<2 THEN 160
>160 PUT "SEEK TIME IS"
>170 LIST B
>180 NEXT X
>190 END
```

7925A DISC DRIVE  
MISCELLANEOUS PROGRAMS

## FORMATTING DISC PACK

```
>10 DEV 0,DRT#,11,10,0
>10 FMT 0,9
>20 END
```

## FORMATTING AND VERIFYING DISC PACK

```
>10 DEV 0,DRT#,11,10,0
>10 DB AA,4096,W
1(%155555),1(%133333),1(%066666)
>10 RC 0
>20 FOR A=0 TO 822
>30 FOR B=0 TO 8
>40 SEEK 0,A,B,0
>50 IDI 0,AA,3,N
>60 ID 0,AA,3,N,A,B,32
>70 NEXT B
>80 NEXT A
>90 FOR A=0 TO 822
>100 FOR B=0 TO 8
>110 SEEK 0,A,B,0
>120 VER 0,64,A,B,0
>130 NEXT B
>140 NEXT A
>150 END
```

## FLAGS DEFECTIVE TRACKS

```
>10 DEV 0,DRT#,11,10,0
>10 DB AA,4096,0
>10 RC 0
>20 PUT "CYLINDER # TO BE FLAGGED DEFECTIVE?"
>30 GET A
>40 PUT "HEAD #?"
>50 GET B
>60 SEEK 0,A,B,0
>70 IDI 0,AA,3,D
>80 ID 0,AA,3,D,A,B,32
>90 PUT "CONTINUE?"(0=N/1=Y)
>100 GET C
>110 IF C=1 THEN 10
>120 END
```

Contributed SLEUTH Programs

7925A DISC DRIVE  
MISCELLANEOUS PROGRAMS (Continued)

SERVO TEST

```
>10 DEV 0,DRT#,11,99,0
>10 LET A=822
>20 RC 0
>30 SEEK 0,A,0,0
>40 LOOP 20,50
>50 FOR A=0 TO 822
>60 LET B=823-A
>70 SEEK 0,A,0,0
>80 SEEK 0,B,0,0
>90 NEXT A
>100 LOOP 50,30
>110 RAND B
>120 LET B=B MOD 821
>130 SEEK 0,B,0,0
>140 RC 0
>150 LOOP 110,10
>160 END
```

RANDOM WRITE/READ

```
>10 DEV 0,DRT#,11,10,0
>10 DB AA,4096,W
1(%155555),1(%133333),1(%066666)
>10 DB BB,4096,0
>10 RAND D
>20 LET A=D MOD 813
>30 LET B=D MOD 8
>40 LET C=D MOD 64
>50 SKWD 0,AA,7,A,B,C
>60 RS 0
>70 SKRD 0,BB,7,A,B,C
>80 Q 100,%100000,7
>90 IF X=X THEN 10
>100 CB 0,AA,BB,3
110 END
```

Contributed SLEUTH Programs

7925A DISC DRIVE  
MISCELLANEOUS PROGRAMS (Continued)

THIS PROGRAM WILL MEASURE THE SEEK TIME AND DISPLAY THIS SEEK TIME ON THE CONSOLE. THE DSU IS NOT NEEDED FOR THIS MEASUREMENT.

```
>10 DEV 0,DRT#,11,10,0
>10 PUT "FOR 7925 TYPE 822"
>20 GET A
>30 FOR X=0 TO 100
>40 SCLK 0
>50 SEEK 0,A,0,0
>60 SEEK 0,0,0,0
>70 LOOP 50,49
>80 RCLK B
>90 SCLK 0
>100 SEEK 0,0,0,0
>110 LOOP 100,99
>120 RCLK C
>130 LET B=B-C
>140 LET B=B/101
>150 IF X<2 THEN 160
>160 PUT "SEEK TIME IS"
>170 LIST B
>180 NEXT X
>190 END
```

Contributed SLEUTH Programs

7970B/E MAGNETIC TAPE DRIVE  
MISCELLANEOUS PROGRAMS

7970B-MAG TAPE

WRITES 20 RECORDS - THEN BACK SPACES 19 OF THEM - THEN READS.

```
>10 DEV 0,DRT#,18,20,0
>10 DB AA,4000,R
>10 WD 0,AA
>20 WFM 0
>30 LOOP 10,19
>40 REW 0
>50 FSF 0
>60 LOOP 50,18
>70 END
```

7970E-MAG TAPE

WRITES 20 RECORDS - THEN BACK SPACES 19 OF THEM - THEN READS.

```
>10 DEV 0,DRT#,19,20,0
>10 DB AA,4000,R
>10 WD 0,AA
>20 WFM 0
>30 LOOP 10,19
>40 REW 0
>50 FSF 0
>60 LOOP 50,18
>70 END
```

7970B/E-MAG TAPE

WRITES ENTIRE TAPE WITH ONES PATTERN

```
>10 DEV 0,DRT#,18/19,100,0
>10 DB AA,4096,%177777
>10 NAME RR
>10 CONT 0,0
>10 CONT 0,4
>10 WRIT AA,C
>10 JUMP *-2
>10 ENDS
>10 SIO 0,RR,0,2,0,%177777
>20 TIO 0
>30 QD 20,%2000,%175777
>40 MC 0
>50 REW 0
>60 END
```

Contributed SLEUTH Programs

NOTES

Contributed SLEUTH Programs

NOTES



# ERROR MESSAGES

SECTION

XI

## Table Of Contents

Topic	Page
Cold Load Error Messages .....	11-2
Cold Load Directory Errors .....	11-9
Cold Load Hardware Halts List .....	11-10
SADUTIL I/O Error Messages .....	11-12
SADUTIL Operation Error Messages .....	11-13
LISTLOG2 Error Messages .....	11-17
MEMLOGAN Error Messages .....	11-19



Error Messages

COLD LOAD ERROR MESSAGES

While cold loading the system, one of the following cold load error messages may appear. MPE will output a special message on the operator console and halt. There are hardware halts that also occur while cold loading the system. In this case, refer to the Cold Load Hardware Halts List.

MESSAGE	MEANING	RECOVERY PROCEDURE
BAD DISC ADDRESS	An address greater than the available number of sectors on the disc driver. This indicates an error internal to the system.	Attempt to COLDSTART from another tape. If this fails, attempt a RELOAD; if this fails, use the disc diagnostic to re-format all discs and try to RELOAD again.
BAD FILE ADDRESS	You attempted to write outside the range of one of the system files.	You should attempt a RELOAD. If this is unsuccessful, use the disc diagnostic to re-format all discs and try to RELOAD again.
COLD LOAD TAPE READ ERROR	A tape-read error was detected during the cold load operation.	You should clean the tape heads and retry. If this is unsuccessful, try a different tape (any tape produced by :SYSDUMP with the current version of the operating system being cold loadable).
DIRECTORY ERROR A=<A>,B=<B>	An error occurred while accessing the directory. Refer to table of Directory Errors.	

## COLD LOAD ERROR MESSAGES (Continued)

MESSAGE	MEANING	RECOVERY PROCEDURE
DISC SPACE ERROR	A conflict exists between the disc free-space map and the space used as defined in the directory.	You should attempt a RELOAD. If RELOAD is unsuccessful, use the disc diagnostic to re-format all discs, then attempt to RELOAD again.
DISC DRIVER DOES NOT EXIST	You attempted a transfer to a disc with a type or subtype unknown to the system, which indicates a disc error has occurred on the specified logical device.	You should attempt to cold load again. If any non-standard drivers (non-HP I/O Drivers) are in the configuration, they should be deleted. If this fails, attempt to cold load from a different tape. If this fails, try to RELOAD. If this fails, run the disc diagnostic to format all discs and try to RELOAD again.
READ DISC WRITE ERR ON SEEK	A disc error has occurred on the specified ldn.	You should cold load again as you will be prompted to take action on the bad track.
LDEV#<LDEV>STATUS= %<STATUS>ADDR=% <ADDR>WORDS=<WORDS>		
EOF	An attempt has been made to read past the end of one of the system files.	You should attempt a RELOAD. If this fails, use a different system tape and try again.
FILE name .PUB.SYS NOT ON DISC	This specified file was needed but was not found in the directory.	Obtain another tape containing the system and UPDATE. If no current system tape is available, attempt UPDATE to an obsolete version of the system as a temporary measure.

Error Messages

COLD LOAD ERROR MESSAGES (Continued)

MESSAGE	MEANING	RECOVERY PROCEDURE
IMPROPER TAPE FORMAT	The information on the tape you used for RELOAD does not agree with the format of tapes produced by the :STORE and :SYS DUMP commands.	You should locate the correct tape set and start the RELOAD operation again. If you are sure the tape set you are using was produced by :SYS DUMP, go back to a previous generation of back up tapes and try again. Use a different tape drive if possible.
IOP ERROR	An impossible status indication was returned by the tape controller, indicating a failure in the controller or the input/output processor.	This message is always caused by a hardware problem and is not usually recoverable. (It can indicate IOP, controller, or memory errors.) Retry the cold load operation.
MOUNT CORRECT VOLUMES OR RELOAD	On a COOLSTART, COLDSTART or UPDATE, not all of the previously-defined volumes were found.	You should either mount the correct volumes and start the COOLSTART, COLDSTART or UPDATE over, or you should RELOAD.
OUT OF BOOTSTRAP DISC SPACE	The 30 sectors of the system disc allocated to the bootstrap program and certain tables have been exceeded; this is an error internal to the system.	You should attempt to RELOAD the system. If this fails, attempt to RELOAD from a different tape set.
OUT OF CST ENTRIES	The Initiator has run out of code segment table entries for the system.	Re-build the system tape (through the :SYS DUMP command), increasing the number of entries in this table.

## COLD LOAD ERROR MESSAGES (Continued)

MESSAGE	MEANING	RECOVERY PROCEDURE
OUT OF DST ENTRIES	The Initiator has run out of data segment table entries for the system.	Re-build the system tape (through the :SYSDUMP command), increasing the number of entries in this table.
OUT OF MEMORY	The amount of space needed to build the main-memory resident portion of the system, and contain one segment of the Initiator program and its associated tables, has exceeded the available memory size (usually 64K).	The Initiator program requires a minimum of 64K words (128K bytes) to run. If the system has been configured incorrectly below this value during a cold load, correct the error and try again. If the tables configured have memory sizes greater than 64K words, then all resident tables must reside in bank 0. If the system tape you are using for cold load was configured in error, it can be corrected by changing the memory size via the Initiator dialog.
OUT OF PCB ENTRIES	The Initiator has run out of process control block table entries for the system.	Re-build the system tape (through the :SYSDUMP command), increasing the number of entries in this table.

Error Messages

COLD LOAD ERROR MESSAGES (Continued)

MESSAGE	MEANING	RECOVERY PROCEDURE
OUT OF SYSTEM DISC SPACE	The virtual mem- ory,directory,and system file disc space required ex- ceeds that avail- able on the system disc. Usually, the system disc is cluttered with us- er files and an attempt is made to update to a new system.	The System Manager/ Supervisor must create a new system tape to correct the problem. It may be necessary to use the previous system tape to bring up MPE, then delete the files on system disc.
OUT OF WSTAB ENTRIES	The Initiator has run out of working set table entries for the system.	Re-build the system tape (through the :SYSDUMP command), increasing the maxi- mum number of con- currently running programs allowed on the system.
PREVIOUS RELOAD ABORTED;MUST RELOAD	The last cold load was a RELOAD that was aborted.	You must cold load again with a RELOAD.
PREVIOUS TAPE COLD LOAD ABORTED; MUST COLD LOAD FROM TAPE	The last cold load was a COLDSTART or an aborted UPDATE.	You must cold load again with COLDSTART UPDATE or RELOAD.
READING BLANK TAPE	There is either a defective tape or a defective tape controller. (Re- ported by the magnetic tape controller.)	You should try to cold load using a known good system tape.
SYSTEM TABLE ON DEFECTIVE TRACKS - CANNOT WARMSTART	At least one of the tables (DST Descriptor table, JMAT, IDD or ODD) which must be re- covered for a WARMSTART is lo- cated on defective tracks.	You may attempt either a COOLSTART, COLDSTART, or RE- LOAD. You will be requested to take some action on the defective track.

## COLD LOAD ERROR MESSAGES (Continued)

MESSAGE	MEANING	RECOVERY PROCEDURE
TAPE I/O CMD REJECTED	There is a defective tape controller. (Reported by the magnetic tape controller.)	If possible, you should try another tape drive.
TAPE PARITY ERROR	A parity error was detected while reading the magnetic tape.	You should clean the tape heads and try again. If the problem persists, try another system tape, or try another tape drive if possible.
TAPE TRANSFER ERROR	There is either a defective tape or a defective tape controller. (Reported by the magnetic tape controller.)	You should clean the tape heads and try again. If the problem persists, try another system tape, or try another tape drive if possible.
TAPE UNIT WENT NOT READY	There is either a bad tape controller or you switched the tape off-line during an operation.	You should make sure the unit is selected and ready. If the HP 3000 Control Panel and Maintenance Panel are available, select the P register and display; set the SYSTEM SWITCH REGISTER to the P value plus 2 and load P register. Press the RUN/HALT switch. If the panels are not available, the error is not recoverable.
TIMING ERROR	Bad tape controller.	Checkout the tape controller.
VOLUME TABLE DESTROYED, MUST RELOAD	Volume table on system disc is overwritten.	RELOAD the system and format the disc consider problems power/gnd related.

Error Messages

COLD LOAD ERROR MESSAGES (Continued)

MESSAGE	MEANING	RECOVERY PROCEDURE
DIFFERENT PROCESSES SPECIFIED FOR DRT num	Different processes mentioned for the specified DRT.	Check the device drivers, reconfigure the system, retry.
INITIATOR/COMPLETER FOR LDEV# ldn SUPPOSED TO BE CORE RESIDENT	Driver not specified as core resident during a :SYSDUMP.	Reconfigure the system and retry.
MORE THAN ONE PRIMARY INTERRUPT HANDLER FOR DRT num	You specified more primary interrupt handler for the specified DRT.	Check the device drivers for conflict, reconfigure, and retry.
BANK WRAP-AROUND	Too many devices were configured in I/O configuration.	Delete unneeded devices during I/O configuration.
HALT PARM = num	This halt is implemented to allow printing of the STACK MARKER TRACE as follows:  STACK MARKER TRACE --- --- --- --- --- --- --- --- --- --- --- --- 0 0 0 0	Information only. (Aid to user to analyze a dump.)



## COLD LOAD DIRECTORY ERRORS

A = 1 DUPLICATE FILENAME DETECTED	B = NOT RELEVANT
A = 2 NON-EXISTENT NAME AT SOME POINT IN THE SEARCH	B = THE NON-EXISTENT NODE IN THE FORM OF A NUMBER AS FOLLOWS:  0 = FILE 1 = GROUP 2 = ACCOUNT 3 = USER
*A = 3 USER DOES NOT HAVE "SAVE" ACCESS	B = THE ACCESS LEVEL TO WHICH USER DOES NOT HAVE ACCESS IN THE FORM OF A NUMBER AS FOLLOWS:  1 = GROUP 2 = ACCOUNT
A = 4 NO ROOM. CANNOT ACCOMMODATE ANY MORE ENTRY BLOCKS IN DIRECTORY	B = PERCENTAGE OF TOTAL ENTRY SPACE ACTUALLY IN USE.
*A = 5 NO ROOM. MORE THAN 65K ENTRIES IN DIRECTORY	B = NOT RELEVANT
A = 6 NO ROOM. CANNOT ACCOMMODATE MORE CONTINGUOUS BLOCKS IN DIRECTORY	B = NUMBER OF CONTINGUOUS BLOCKS BEING REQUESTED
*A = 7 ENTRY CANNOT BE PURGED BECAUSE IT IS BUSY	B = NOT RELEVANT
*A = 8 FILE SPACE LIMIT EXCEEDED	B = THE PERMANENT FILE SPACE REQUESTED HAS BEEN EXCEEDED FOR THE NODE IN THE FORM OF A NUMBER AS FOLLOWS:  1 = GROUP 2 = ACCOUNT
*Invalid error conditions for the Initiator only.	

Error Messages

COLD LOAD HARDWARE HALTS LIST

SEGMENT NAME OR CST NUMBER (snum)	APPROX. DELTA-P (snum)	HALT ARGUMENT	PROCEDURE NAME	OFFSET IN PROCEDURE	CAUSE	ACTION
1		1			Power fail	Cold load
1		2			Power on	Cold load
1		3			Stack overflow	Run diagnostic
1		4			Module interrupt	Run diagnostic
1		0			Console interrupt	Cold load
1		0			Cold load	Run diagnostic
1		0			(Unused internal interrupt)	Run diagnostic
1		0			(Unused internal interrupt)	Run diagnostic
1		11			Module error	Run diagnostic
1		12			Parity error	Run diagnostic
1		13			Stack underflow or CST/SST violation	Run diagnostic
1		14			Code seg- ment absent before code segment swapping started.	Run diagnostic
1		15			STT entry uncallable	Run diagnostic
1		0			Trace trap	Run diagnostic
1		0			Traps	Run diagnostic

Error Messages

COLD LOAD HARDWARE HALTS LIST (Continued)

SEGMENT NAME OR CS1 NUMBER (snum)	APPROX. DELTA-P (snum)	HALT ARGUMENT	PROCEDURE NAME	OFFSET IN PROCEDURE	CAUSE	ACTION
DIRECTORY2 (26)	223	0	USERCLEAN	23	Bad call from DIRECSAN.	Reload
DIRECTORY2 (26)	554	0	DIRECTORY-CLEAN	314	Bad call from DIRECSAN.	Reload
SETUP (32)	1062	0	DIRERROR	127	Halts after printing error message*	Cold load
RESIDENT (36)	1142	0	DISCERROR	220	Halts after printing error message*	Cold load
BOOT-STRAP (37)	114	5	BOOTSTRAP	62	Bad disc cold load information table	Reload
BOOT-STRAP (37)	2616	0	MHDISK	523	Disc seek error while in bootstrap.	Run diagnostic on system disc.
BOOT-STRAP (37)	3043	0	MHDISK	1050	Disc read/write error while in bootstrap.	Run diagnostic on system disc.
BOOT-STRAP (37)	1460	0	MH7905	1257	Disc read/write error while in bootstrap.	Run diagnostic on system disc.
BOOT-STRAP (37)	3433	0	FHDISK	222	Disc error while in bootstrap.	Run diagnostic on system disc.
BOOT-STRAP (37)	3617	4	ERRMESSAGE	7	Halts after printing error message.*	Cold Dump

\*Cold load error message printed on console.

Error Messages

SADUTIL I/O ERROR MESSAGES

Error messages are issued by SADUTIL when an I/O operation fails or when an error occurs during SADUTIL operation.

Disc errors resulting from sectors outside the directory, absence of required account entries, bad tracks, or invalid label comparisons can be investigated with the EDIT function.

When an error occurs on magnetic tape, one of the following SADUTIL I/O Error Messages will be issued. The SAVE operation is terminated and SADUTIL prompts for the next function.

MESSAGE	MEANING	ACTION
UNIT WENT OFF-LINE	Magnetic tape unit is off-line.	
NOT READY INTERRUPT		
TRANSFER ERROR		
CMD REJECT		
TAPE RUN AWAY		
TIMING ERROR		
TAPE PARITY ERROR		

Following each of the messages, SADUTIL prints:

```
      /           \  
      | WRITE      |  
*TAPE < EOF      > ERROR*  
      | BACKSPACE |  
      \           /
```

## SADUTIL OPERATION ERROR MESSAGES

When an error occurs during operation of SADUTIL, one of the following SADUTIL Operation Error Messages will appear at the system console. SADUTIL continues after using the message and you are prompted for further input.

MESSAGE	MEANING	ACTION
*ACCOUNT NOT IN DIRECTORY	In a PFIL function request, a referenced file belongs to an account not present in the System File Directory.	Re-enter the file reference with the correct account name.
DIRECTORY ERROR	During a COND operation, an error was found in the System File Directory.	Use the EDIT function of SADUTIL to analyze the problem or see your system manager.
READ DISC WRITE ERR ON SEEK LDEV # ldn STATUS=%statusval ADDR=%sectoraddr	SADUTIL was unable to complete the particular I/O operation to or from disc. ldn is the logical device number of the volume, statusval is the hardware status word of the device after operation, sectoraddr is the address of the disc sector where the error occurred.	If the error occurs on a removable disc, remove the disc and replace it with a new scratch disc; rerun SADUTIL.
*FILE NOT IN DIRECTORY*	In a PFIL operation, a referenced file is not present in the System File Directory, although the account and group names were valid and present.	Re-enter the file reference with the correct file name.

Error Messages

SADUTIL OPERATION ERROR MESSAGES (Continued)

MESSAGE	MEANING	ACTION
*FUNCTION NOT COMPLETED*	The function in process encounters an irrecoverable error, such as disc I/O error, and terminates. The requested operation is not completed. (This message typically follows a message explaining the error.)	
*GROUP NOT IN DIRECTORY*	In a PFIL request, a referenced file belongs to a group not present in the System File Directory, although the account name was valid and present.	Re-enter the file reference with the correct group name.
ILLEGAL DEVICE SPECIFICATION	An input/output device was specified for a function (such as EDIT, PFIL, SAVE, or STOP) that does not use a device specification.	Re-enter the function keyword correctly.
*INVALID*	The response to a prompt was not recognizable.	At next prompt, re-enter response correctly.
*INVALID COMMAND*	An invalid (unrecognizable) EDIT command was encountered.	At next prompt, re-enter command correctly.
INVALID DEVICE SPECIFICATION	The function keyword is correct but the input/output device specification is invalid, for instance a special character or an unrecognizable number.	At next prompt, re-enter device specification correctly.

## SADUTIL OPERATION ERROR MESSAGES (Continued)

MESSAGE	MEANING	ACTION
INVALID DISC ADDRESS	In the MODIFY command of the EDIT function, an invalid disc address is encountered, or a disc read or write operation attempted to access a sector address not on the volume.	If invalid disc address, enter valid address in response to next prompt; if sector address not on volume, a system problem exists and you should notify your system manager.
LDEV ldn NOT DEFINED	A specified logical device (ldn) has not been configured through the SADUTIL cold-load dialogue or the CONF function.	Configure the device or specify another device.
LDEV ldn NOT READY	You requested a function that performs disc I/O but the disc drive is not ready, for example, a removable cartridge has been removed.	Ready the disc drive or reference another disc.
MISSING DEVICE SPECIFICATION FOR volumename VOLUME	The System Volume Table contains the name volumename but no such volume has been mounted and configured into the system.	Configure the device.

Error Messages

SADUTIL OPERATION ERROR MESSAGES (Continued)

MESSAGE	MEANING	ACTION
SYSTEM DISC NOT CONFIGURED	This message appears during initial configuration dialogue when the system disc (ldn=1) has not been configured.	Proceed with the configuration.
VOLUME volumename FOR LDEV ldn NOT IN VOLUME TABLE	This message appears when a configured disc is not represented in the System Volume Table. The message appears only for functions that require all volumes to be mounted, such as COND, PFIL, and SAVE.	



## LISTLOG2 ERROR MESSAGES

If an error occurs in the LISTLOG2 utility program, one of the following LISTLOG2 error messages will be printed on the standard list device. Fatal errors call the QUIT intrinsic (intrinsic 99) after the error message is printed, terminating the program.

MESSAGE	MEANING	ACTION
BINARY INTRINSIC ERROR	Binary intrinsic did not return a CCE condition. Program may terminate.	Enter alphanumeric characters in response to prompt (after re-running program if it terminated)
FATAL FGETINFO ERROR ERROR NUMBER xx	FGETINFO intrinsic did not return a CCE condition. Program terminates.	Check FCHECK error number (xx). Correct and run again.
FATAL FREAD ERROR ON LOGFILE xxxx ERROR	An FREAD intrinsic failed to read log file number xxxx. Program terminates.	
FATAL FPOINT ERROR ERROR NUMBER xx	FPOINT error caused program to terminate.	Check FCHECK error number (xx). Correct and run again.
FCLOSE ERROR ON LINE PRINTER ERROR NUMBER xx	FCLOSE intrinsic did not return a CCE condition. Program continues.	Warning only.
FCLOSE FAILED TO LOGFILE xxxx ERROR NUMBER xx	FCLOSE intrinsic did not return a CCE condition. Program moves on to next selected log file	Check FCHECK error number (xx).
FIRST RECORD NOT HEADER RECORD FOR LOGFILE xxxx	First record in log file xxxx was not a header record. Program prints contents of first record and continues.	Warning only.

Error Messages

LISTLOG2 ERROR MESSAGES (Continued)

MESSAGE	MEANING	ACTION
FOPEN ERROR TO LOGFILE xxxx ERROR NUMBER xx	FOPEN intrinsic did not return a CCE condition. Program closes log file xxxx and moves on to open next selected log file.	Warning only. Check error number xx and correct in order to run program again and open log file xxxx.
FREAD FAILED FROM LOGFILE xxxx ERROR NUMBER xx	FREAD intrinsic did not return a CCE condition. Program closes file number xxxx and moves on to next selected log file.	Check FCHECK error number (xx).
FWRITE FAILED TO LINE PRINTER ERROR NUMBER xx	FWRITE intrinsic did not return a CCE condition. Program closes this line printer file and attempts to open another.	Check FCHECK error number (xx).
TOO MANY CHARACTERS - TRY AGAIN	Too many characters entered. Program asks the question again.	Respond with fewer characters.
FOPEN TO LINEPRINTER FAILED FATAL ERROR NUMBER xx	FOPEN intrinsic did not return a CCE condition. Program tried to open lineprinter file a second time and since it failed, the program terminates.	Check FCHECK error number (xx).
FPOINT ERROR ON LOGFILE xxxx ERROR NUMBER xx	FPOINT intrinsic did not return a CCE condition for file number xxxx.	Check FCHECK error number (xx).
FREAD ERROR ON LOGFILE xxxx ERROR NUMBER xx	An FREAD intrinsic failed to read log file xxxx.	Check FCHECK error number (xx).
The error number (xx) is the FCHECK error code and the log file number (xxxx) identifies the log file of the error.		

MEMLOGAN ERROR MESSAGES

If an operational error is encountered by MEMLOGP, the process will print an error message on the console and terminate. The message printed on the occurrence of such an error is:

ST/<TIME>/MEMORY LOGGING ERROR #<ERRNUM>. LOGGING STOPPED.

The ranges and value for <ERRNUM> are:

1-10 - Internal MEMLOGP errors.

1 - FLOCK error on MEMLOG file.

2 - FUNLOCK error on MEMLOG file.

3 - TIO error. Error logging hardware not ready.

4 - CIO error during copy operation from logging array.

5 - RIO error during scan of logging array.

6-10 - Reserved for future use.

20-500 - File system errors involving MEMLOG file.

File system errors are described in the MPU Reference Manual. Unlike the system logging facility, all file system errors encountered by MEMLOGP are fatal to the process and will cause it to terminate.

Error Messages

NOTES

11-20