

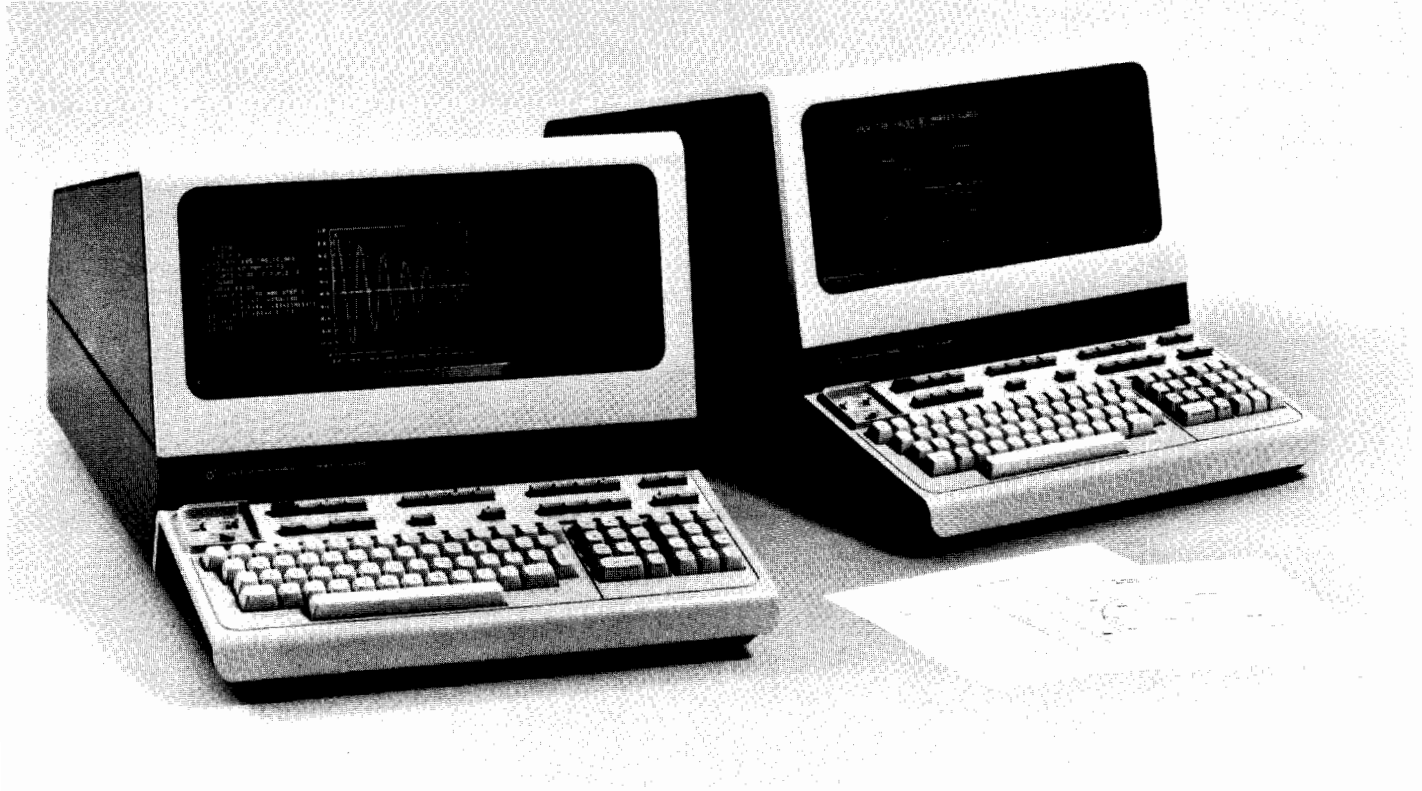

Model 2647A



The 2647 is the intelligent solution to a host of applications that require both an on-line capability and local programmability. In addition to being user programmable in BASIC, the 2647 offers a raster scan display and a full interactive alphanumeric capability.

FEATURES

User Programmability

- BASIC, on-line and local
- BASIC, graphic extensions
- BASIC, control of terminal functions
- Calculate mode

High Level Graphics Commands

- English-like graphics commands
- Control over graphics functions
- CPU or local BASIC program control

Graphics Memory Input/Output

- Graphics memory contents to cartridge tape, hardcopy devices or CPU

Simple User Interface

- English-like terminal commands
- Eight user-defined soft keys
- Graphics key pad

Shared Peripherals

- Multiple terminals share compatible plotters, printers, etc.

Dual Cartridge Tapes

- Mass storage to 110K bytes each

Multiple Automatic Plotting

- Terminal based software
- Pie charts
- Bar charts
- Cartesian X-Y charts, linear and logarithmic
- Menu driven operation
- Interface to color plotter (opt.)

High Resolution Alphanumeric Display

- Raster scan technology
- Multiple character sets
- Display enhancements

Reliability, Modularity, Self-Test

- Self contained diagnostics
- Aid for fault analysis

Independent Graphics and Alphanumeric Display

Zoom and Pan

Rubber Band Line

Graphics Text Composition

BASIC LANGUAGE PROGRAMMABILITY

The 2647A can be used with a host CPU that is executing canned programs or as a local programmable graphics work station. The BASIC language used with the 2647A provides an extensive facility for solving a wide variety of business, engineering and scientific applications. An impressive array of commands, statements, functions and graphics make the 2647A a complete problem solving tool.

```
100 PLOT (0,1)
110 FXD (1)
120 LOCATE (80,199,20,85)
130 SCALE (-10,10,-10,10)
140 LGRID (1,1,0,0,1,1)
150 FRAME
```

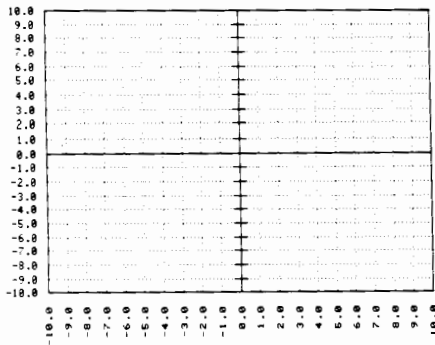

```
10 PLOT
20 FXD (1)
30 LOCATE (85,190,10,90)
40 SCALE (0,480,-1,1)
50 LGRID (-30.,2,0,0,2,1)
60 FRAME
70 MOVE (0,0)
80 FOR I=1 TO 480 STEP 1
90 X=I*3.14159/180
100 Z=EXP(-.25*X)*COS(X)
110 Y=Z*SIN(20*X)
120 PLOT (60*X,Y,-1)
130 NEXT I
140 SETGU
150 MOVE (0,0)
160 END
```

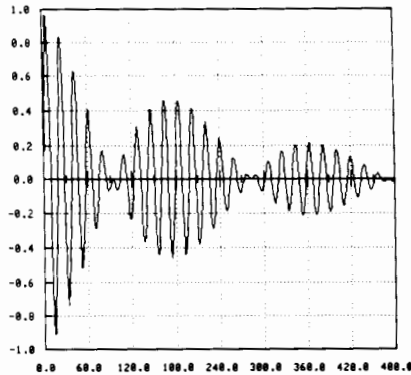

```
10 PLOT
20 FXD (1)
30 LOCATE (85,190,10,90)
40 SCALE (0,480,-1,1)
50 LGRID (-30.,2,0,0,2,1)
60 FRAME
70 MOVE (0,0)
75 FOR I=1 TO 480 STEP 2
80 X=I*3.14159/180
90 Y=EXP(-X/5)*SIN(5*X)
100 PLOT (60*X,Y,-1)
110 NEXT I
120 END
```

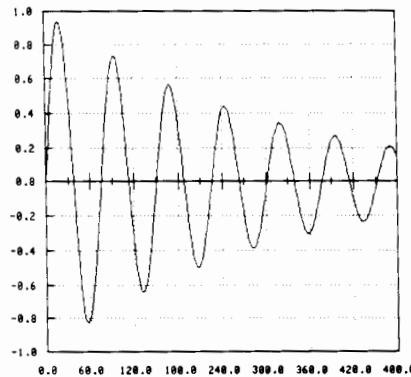

```
10 PLOT
20 GCLR
30 LOCATE (85,190,10,90)
40 FRAME
50 SCALE (1,12,100,600)
60 LGRID (-1,50,1,100,1,1)
70 FOR I=1 TO 12
80 READ X,Y
90 PLOT (X,Y)
100 NEXT I
110 DATA 1,150,2,200,3,200
120 DATA 4,300,5,350,6,400
130 DATA 7,425,8,450,9,475
140 DATA 10,500,11,525,12,550
```

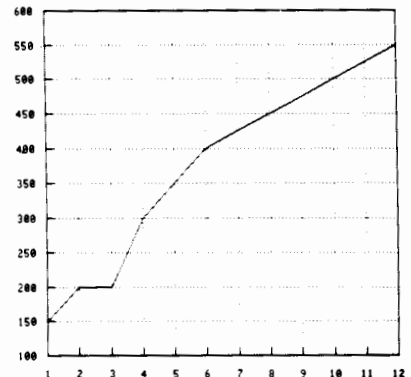

COMMANDS

AUTO	MERGE
CSAVE	REMOVE
DELETE	RENUM
EXIT	RUN
GET	SAVE
GO	SCRATCH
LIST	SET

FUNCTIONS

Numeric	String	Print	Input/Output	Other
ABS	CHR#	LIN	GETKBD	ERRL
CSENA	LEN	SPA	DSPIN#	ERRN
CSENS	NUM	TAB	GETDCM	FRE
EXP	POS	MOVCS	PUTDCM	
INT	VAL	MOVCA		
LOG	VAL#	MOVCR		
LONG	RPT#			
RND	TRIM#			
SGN	UPC#			
SHORT	PROC#			
SQR				
ATN				
COS				
SIN				
TAN				

STATEMENTS

ASSIGN	INTEGER	PRINT USING
CALL	KEYCODE	READ
COMMAND	LET	READ#
DATA	LINPUT	REMARK
DIM	LINPUT#	RESTORE
END	LONG	RESTORE#
ERROR	OFF KEY#	RESUME
FOR...NEXT	ON END#	RETURN
GETDCM ON/OFF	ON...GOSUB	SHORT
GETKBD ON/OFF	ON...GOTO	SLEEP
GOSUB	ON ERROR	STOP
GOTO	ON KEY#	SUB
IF...THEN...ELSE	PRINT	SUBEND
IMAGE	PRINT#	WAKE UP
INPUT		

HIGH LEVEL GRAPHICS COMMANDS

The graphics features of the 2647A may be controlled by high level English-like commands. These commands control the 2647A graphics functions in either on-line or off-line environments. This high level control extends to: graphic set up functions, axes and labeling, plotting and interactive graphic functions. The result is that the user has effective control over the terminal graphics features.

AGL FUNCTIONS

Interactive	Set-Up	Plotting	Axis/Labeling
WHERE	PLOT	PENUP/PENDN	XAXIS
POINT	GPON	PEN	YAXIS
CURSOR	SETAR	LINE	LXAXIS
DIGITIZE	LIMIT	PLOT	LYAXIS
GPM	GCLR	MOVE	AXES
DSIZE	LOCATE	DRAW	LAXES
DSTAT	MARGIN	RPLDT	GRID
GSTAT	SCALE	IPLOT	LGRID
	SHOW	PDIR	FRAME
	MSCALE	PORG	FXD
	CLIP		LRG
	CLIPOFF		LDIR
	CLIPON		CSIZE
	SETGU/SETUU		

MULTIPLE AUTOMATIC PLOTTING

The 2647A offers sophisticated local graphing capability while requiring little or no programming knowledge. Menu driven, the 2647A can plot columnar data in multiple formats chosen by the user. Pie charts, bar charts and X-Y Cartesian and logarithmic graphs can all be created without any host CPU graphics software. Different types of area shading are available for highlighting various areas of bar charts. This capability is implemented with a simple BASIC program.

Data may be submitted to the 2647A from one of three sources; host computer, tape cartridge or display memory. A simple menu is provided to lead the user through a question and answer session about the data. Once the data parameters are defined, the data can then be plotted with a single keystroke. This powerful feature makes graphs friendly, easy to create, and system software independent.

Pie Charts

Title		Subtitle		
SALES BY MARKET AREAS		MODEL YEAR 1977		
Label	Value	Explode	Shade	Pen
SOUTH AMERICA	8.8	Y	█	█
EUROPE	20.2	█	█	█
UNITED STATES	28.1	█	█	█
CANADA	10	█	█	█
JAPAN	20.5	█	█	█
ASIA	1	█	█	█
AFRICA	17.1	█	█	█

Plotter ?
 AUTO-SORT?

SALES BY MARKET AREAS

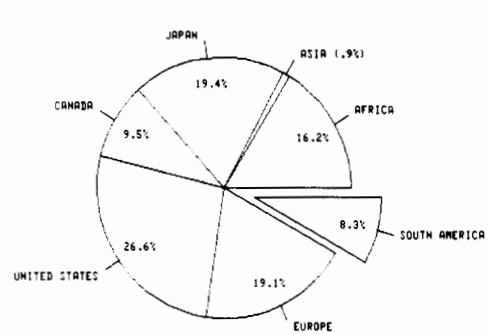

Bar Charts

Main		Titles		Type	
DIVISIONAL PRODUCTION		1973-1977		Normal, Stacked, Comparative	
Sub		SOURCE AUDITED 1978 MARKET DATA BOOK		MILLIONS	
Labels	Value 1	Value 2	Value 3	Value 4	Value 5
1973	11.4	9.8	4.2	1.6	
1974	9.7	7.3	3.8	1.8	
1975	9.1	6.8	4.6	2.0	
1976	11.7	8.6	5.1	2.0	
1977	11.4	9.3	5.5	2.0	

LEGENDS? CHEMICALS & PAINTS & TEXTILES HEAVY ROAD
 GRID? COSMETICS & SOLVENTS EQUIPMENT

Plotter? Y MIN Y MAX Y LABEL SPACING

CAR PRODUCTION

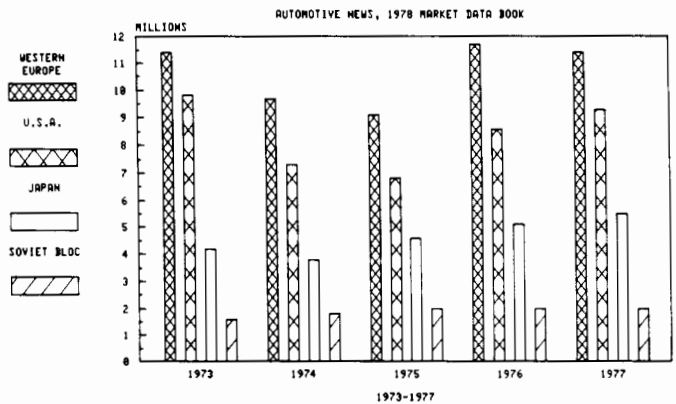

Linear Charts

A. PLOT SPECIFICATION		ID. DEVICE SPECIFICATION	
NO. OF COLUMNS	5	SOURCE	DT
X IS COLUMN(S)	1,1,1,1	PLOTTER ?	<input checked="" type="checkbox"/>
Y IS COLUMN(S)	2,3,4,5		
PEN & LINE TYPE	1,2,3,4		
SKIP FIRST			
STOP AFTER	12		

B. AXES SPECIFICATION		GRID(Y OR N)	
X AXES	LINEAR	UNITS BETWEEN X LABELS	1
Y AXES	LINEAR	UNITS BETWEEN X TICS	.25
MIN X	M-1	UNITS BETWEEN Y LABELS	5000
MAX X	M-12	UNITS BETWEEN Y TICS	1000
MIN Y	0		
MAX Y	15000		

C. ANNOTATION		Titles	
Main	WORLDWIDE DIVISIONAL SALES	Xaxis	MONTHS
Sub	FISCAL YEAR ENDING 1978	Yaxis	MILLIONS

LEGENDS STEEL FABRICATION CONSTRUCTION EQUIPMENT PRECISION BEARINGS MACHINE PARTS

WORLDWIDE DIVISIONAL SALES

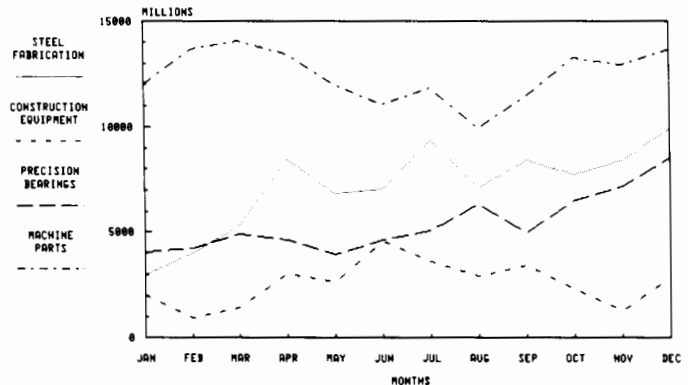

GRAPHICS MEMORY IMAGE OUTPUT

In addition to handling vector information for graphics pictures, the 2647A can input and output binary image data to and from graphics memory. The 2647A can output this image data to the dual cartridge tapes which are provided standard or to any compatible hardcopy device or host computer. This provides a very convenient facility to create pictures locally and store them. The stored pictures can be read back, edited, and stored on cartridge tape again, sent to a hardcopy device, or transmitted to a host computer. The dual mini-cartridges can give you up to 110K bytes of mass storage and a pocket full of pictures.



SIMPLE USER INTERFACE

Data paths between terminal facilities and peripherals are controlled by English-like commands. The user is guided by a friendly command line that utilizes soft keys and screen labels to control terminal activities. Once the user specifies an operation to be performed, the terminal presents on the screen the logical alternatives to complete the intended operation. This easy to use interface controls data flow between such terminal facilities as the screen, tape cartridges, printers, plotters, tablets, and other peripherals.

COMMAND

```

next COPY SHOW ASSIGN 1 2 REMIND MARK FIND
*ASSIGN DESTINATION TO LEFT TAPE, DISPLAY
more 1 41 D:LTAPE D:RTAPE D:DISPLY D:SH PTR
*REMIND LEFT TAPE, RIGHT TAPE
1 29 L TAPE R TAPE
*COPY FILE FROM LEFT TAPE TO RIGHT TAPE
L TAPE R TAPE DISPLAY GRAPHICS 1 40 EX PRNTR SH PRNTR HP-IB
*COPY FILE FROM LEFT TAPE TO RIGHT TAPE, DISPLAY
L TAPE R TAPE DISPLAY GRAPHICS 1 48 EX PRNTR SH PRNTR HP-IB
*MARK FILE HEADER ON LEFT TAPE
1 31 L TAPE RTAPE
    
```

COMMUNICATIONS GROUP

TERMINAL CONTROL GROUP

COMMAND AND SPECIAL FUNCTIONS GROUP

EDIT GROUP



CHARACTER SET GROUP

GRAPHICS CONTROL GROUP

DISPLAY CONTROL GROUP

RASTER SCAN TECHNOLOGY

The 2647A can be used in bright, ambient light environments because raster scan provides a bright, easy-to-read display. This bright display also helps to minimize eye fatigue during extended sessions at the terminal.

With refreshed raster scan technology, the ability to modify selected portions of a picture is a natural feature. Portions of the picture can be modified without completely erasing and redrawing the entire display. This minimizes the system software overhead, user wait-time, and communication costs.

INDEPENDENT GRAPHICS AND ALPHANUMERIC DISPLAY MEMORIES

The Graphics and Alphanumeric display each have their own independent random access memory (RAM). The alphanumeric display memory can typically contain up to 75 lines each containing 80 characters. The independent graphics memory, consisting of sixteen 16K RAMs and has 720 by 360 displayable points. Because these two separate memories are independent, computer transactions do not have to obscure the graphics picture. Either the graphics or alphanumeric memory display can be suppressed without disturbing the other. This improves the readability of the display. The graphics and alphanumeric displays each have their own separate cursor control keypad.

SHARED HARDCOPY AND PERIPHERAL DEVICES

Multiple 2647A terminals may share the same compatible hardcopy devices such as plotters and printers. Each 2647A may transmit to a compatible plotter the necessary vector information to obtain high quality plots. When one user completes plotter operations any other user on the same line may initiate subsequent plots on the same device.

Vector information may originate from host computer, local BASIC program, or dual tape cartridge. Sharing also applies to devices that accept raster formatted information where the contents of graphics memory are output directly to the hard copy device.

For alphanumeric output, the 2647A can also share compatible printers. So whatever your requirements are, graphs or alphanumeric, the 2647A can make HP hardcopy devices more cost effective.

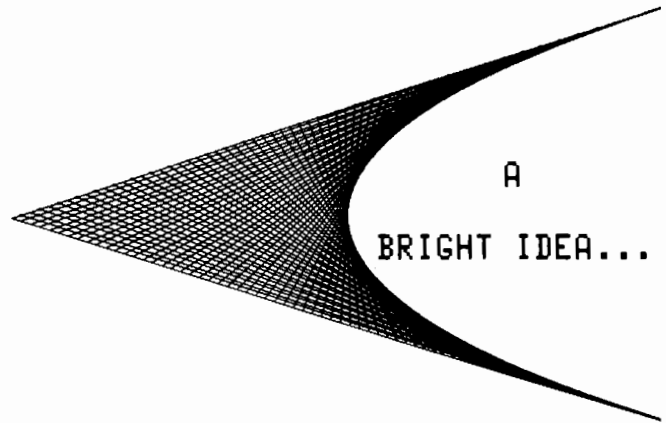

HELLO TD.HRMG;TERM=9



ALPHA MEMORY

SESSION NUMBER = #589
 MDN, MAY 2, 1977, 5:14 PM
 HP32002A.01.00

:BASIC

HP32101B.00.05(4WD) BASIC (C)HEWLETT-PACKARD CO 1976

>GET GDEMO.PUB.MKTG
 >RUN

SPECIFY PLOT

PRESSURE/TEMPERATURE vs TIME

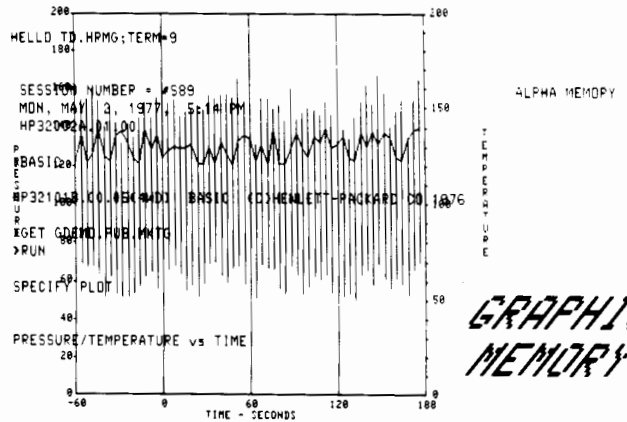

GRAPHIC MEMORY

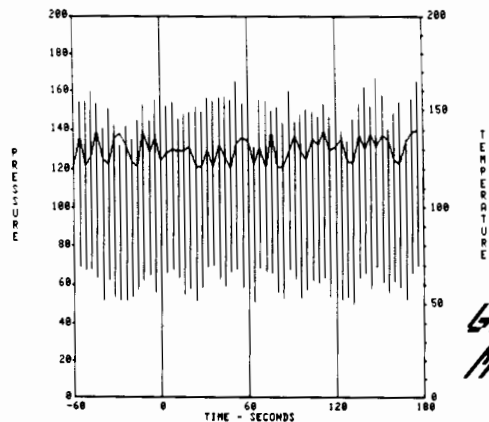

GRAPHIC MEMORY

HARDWARE ZOOM AND PAN

The graphics display can be magnified incrementally from one to sixteen times (16X). This feature allows the user to make full use of the 720 by 360 dot resolution. This allows investigation and/or modification of dense display areas such as parallel lines separated by only a single dot spacing. Panning can then be used to view any area of the magnified display not in the viewing window. The complete display can be panned through without affecting the graphics display memory.

ZOOM

ZOOM

RUBBER BAND LINE

Trial graphics can be performed with or without computer support using the Rubber Band Line. This provides quick, user initiated picture generation or modification. This feature allows the user to draw a line segment between a predetermined position and the graphics cursor. Through a simple set of keystrokes, one end of a line segment is fixed into position while the other is automatically drawn to the graphics cursor. As the graphics cursor moves to a desired position, the line segment automatically stretches with directional changes of the cursor. After the graphics cursor reaches its final position, a fixed line segment can be drawn.

RUBBER BAND LINE

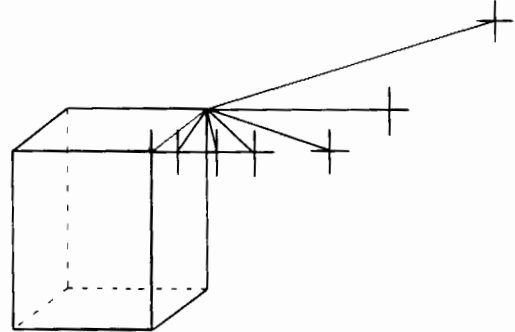

GRAPHICS TEXT COMPOSITION

Characters entered into the graphics display memory can be varied in shape, size, and orientation. This feature allows the user to select an incremental character size, orientation (90-degree multiples), and slant (italic). In addition, it lets the user left/right justify or center graphics text automatically. This feature helps the user label axes and makes it easy to add notes or comments to a graph after it is displayed.

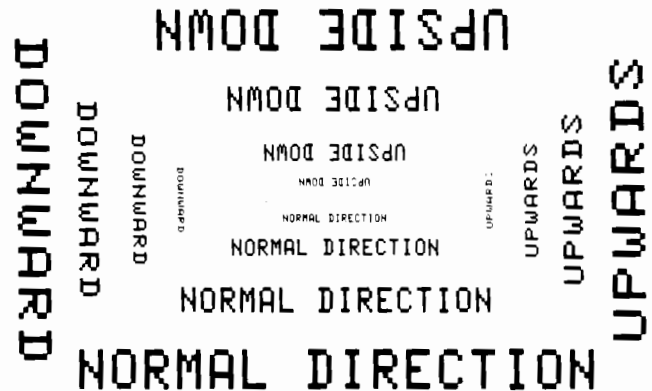

FULL ALPHANUMERIC CAPABILITY

The 2647A has the same alphanumeric capability as the 2645A terminal. Forms for data entry, text editing, program preparation and interactive computer sessions are all easy.

Features such as character and line insert or delete with or without character wraparound make text editing and program preparation easy. Store the final text on tape cartridge for later transmission to a computer.

Protected fields, numeric and alpha checking, forms and block mode make the data entry a snap. Store your forms on cartridge, enter the data, edit and then store the data locally for later transmission to a computer. When the 2647A isn't being used as a powerful graphics workstation, it's a productive alphanumeric workstation.

```

*** ORDER PROCESSING ***

ORDER NUMBER  SECTION  B/L NUMBER  SHIP DATE
000760341    003          [REDACTED]    31 JAN 9

M-CODE       METHOD      C-CODE      CARRIER
[REDACTED]   TRUCK      [REDACTED]   H P

FREIGHT      COD CHARGE  DD250 PARTIAL
2652        [REDACTED]  [REDACTED]

CARRIER'S ADDRESS
[REDACTED]

-----
ITEM/SUB/CD  QUANTITY  ENT #  ADVISE PRICE
01005       4         01     36373

SERIAL NUMBERS          BOX  WEIGHT
1. [REDACTED] [REDACTED] [REDACTED] 1. [REDACTED] [REDACTED]
2. [REDACTED] [REDACTED] [REDACTED] 2. [REDACTED] [REDACTED]
3. [REDACTED] [REDACTED] [REDACTED] 3. [REDACTED] [REDACTED]
4. [REDACTED] [REDACTED] [REDACTED] 4. [REDACTED] [REDACTED]
    
```

Ordering Example

This is an example of ordering four 2647A Intelligent Graphic Terminals and a 7245 Printer/Plotter. The four terminals can share the Printer/Plotter and can independently communicate to the CPU remotely over a modem.

4 — 2647A	Intelligent Graphics Terminal
—096	Shared Peripheral Interface Option
4 — 13232N	RS232 cable to modem
1 — 7245B	Printer Plotter
—001	Graphics Option

PRODUCT NUMBER	DESCRIPTION	PRICE
2647A	INTELLIGENT GRAPHICS TERMINAL 720 × 360 Dot Graphics Image Memory and random access alphanumeric memory, BASIC interpreter with graphics commands, multiple automatic plotting, 128 character Roman, inverse video, 8 user-defined soft keys, 75 lines of display memory, RS232C communications, integrated dual cartridge tapes, 1 option slot.	
-003	DISPLAY ENHANCEMENTS Adds blinking, half-bright, underline, and Line Drawing character set; and provides for addition of two 128 character sets. (Requires 1 option slot.)	
-004	DISPLAY ENHANCEMENTS WITH MATH AND LARGE CHARACTER SETS Adds blinking, half-bright and underline; and Line Drawing, Math (integral signs, Greek letters, etc.) and Large Character sets. (Requires 1 option slot.)	
-013	5 mini cartridges	
-015	50 Hz, 230V	
-016	50 Hz, 115V	
-032	EXTENDED ASYNCHRONOUS COMMUNICATIONS Upgrade which provides either RS232C or 20mA current loop communications for the 2647A. Has split speed and custom baud rates.	
-033	ASYNCHRONOUS MULTIPOINT COMMUNICATIONS Provides asynchronous multipoint communications interface for the 2647A allowing daisy chained line sharing. Monitor Mode capability is included.	
-034	SYNCHRONOUS MULTIPOINT COMMUNICATIONS Provides synchronous multipoint communications interface for the 2647A allowing daisy chained line sharing. Monitor Mode capability is included.	
-054	VIDEO OUTPUT INTERFACE Provides video signal for a compatible monitor or hardcopy unit. (Requires 1 option slot.)	
-096	SHARED PERIPHERAL INTERFACE Provides shared interface for compatible devices, includes cable. (Requires 1 option slot.)	
ACCESSORIES		
13250B	SERIAL PRINTER INTERFACE Adds interface for connecting RS232C printing devices (requires 1 option slot). No interface cable included (local only, not shared).	
98200A	Mini-cartridge (available in boxes of fives from Corporate Parts Center).	
CABLES		
13232A	103/202 Modem (male, 15 ft.)	
13232B	12880A/12531D (50 ft.)	
13232C	RS232 Connector (female, 5 ft.)	
13232F	Current Loop Connector Kit (5 ft.)	
13232G	13250 to RS232C Printer (male, 15 ft.)	
13232H	13250 to RS232C Printer (female, 25 ft.)	
13232J	13238 to 9871 Printer (6 ft.)	
13232K	13254 to video hardcopy printer (15 ft.)	
13232L	13254 to compatible TV monitor (15 ft.)	
13232M	13250B to European modems	
13232N	103/202/201/208/209 modem (male, 15 ft.)	
13232P	Modem/Multipoint Cable, male RS232C, male multipoint connector, 30 ft. total	
13232Q	Multipoint Cable, male multipoint, female multipoint connector, 30 ft. total	
13232R	Multipoint Extension Cable, male multipoint/female multipoint connector, 100 ft.	
13232S	13238 to 9866 line printer (6 ft.)	
13232T	Power Protect Multipoint Cable, male multipoint connector with relays/female multipoint connector, 30 ft. total	
13232U	Modem bypass (5 ft.)	
13232Y	Electromagnetic Pulse Protect Cable, male RS232C, 15 ft.	
TRAINING		
2647AT	2647A User Training Course	
2647AP	2647A System Training Course	

POWER REQUIREMENTS

Input Voltage: 115V (+10%, -23%) at 50/60 Hz ($\pm 0.2\%$)
230V (+10%, -15%) at 50 Hz ($\pm 0.2\%$)

Power Consumption: 140W to 170W maximum

PHYSICAL SPECIFICATIONS

Display Monitor Weight: 21.9 kg (48.2 lbs.)

Keyboard Weight: 3.2 kg (7 lbs.)

Display Monitor Dimensions: 444 mm (W) \times 457 mm (D) \times 342 mm (H), (17.5 inches (W) \times 18 inches (D) \times 13.5 inches (H)); depth including keyboard is 648 mm (25.5 inches).

Keyboard Dimensions: 444 mm (W) \times 216 mm (D) \times 90 mm (H), (17.5 inches (W) \times 8.5 inches (D) \times 3.5 inches (H)).

ENVIRONMENTAL CONDITIONS

Temperature (Free Space Ambient): -10° to 60°C (14°F to 140°F); Non-operating
5° to 40°C (41°F to 104°F); Operating

Humidity: 20% to 80%; Non-condensing

Altitude: Sea level to 7620 m (25,000 ft.); Non-operating
Sea level to 4572 m (15,000 ft.); Operating

Vibration*: 0.37 mm (0.012 inch) pp, 10 Hz to 55 Hz, 3 axis

Shock*: 30 g, 11 ms, 1/2 sine

*Type tested to qualify for normal shipping and handling in original shipping container.

PRODUCT SAFETY

Product Meets: United States: UL requirements for EDP equipment, office appliances, and teaching machines.
Canada: CSA requirements for EDP equipment.
Switzerland: SEV
Germany: VDE, (Data Comm), FTZ (RFI).
United Kingdom: GPO (Data Comm).

PRODUCT SUPPORT

Hardware Supplied: 2647A Intelligent Graphics Terminal
2 blank tape cartridges
1 system tape cartridge

Documentation Supplied: 2647A User's Manual (02647-90001)
2647A User Instructions Tapes (qty. = 2)
2647A Reference Manual (02647-90002)
2647A Terminal BASIC Manual (02647-90005)
2647A Quick Reference Guide (02647-90006)

Customer Training: 2647A User Training Course (2647AT)
2647A System Training Course (2647AP)

Hard Copy Interface: RS232 serial printer interface (opt.)
HP parallel printer interface (opt.)
Video interface (opt.)
Shared peripheral interface (opt.)

Installation: All product preparation can be performed by the owner/user. Refer to reference manual supplied with unit for detailed instructions. HP assistance is provided for installation upon request and at prevailing rates.

HP Systems Support: Refer to appropriate HP system data sheet for use and support of 2647A in these systems. When this product is used in a customer-assembled system, the overall operational responsibility of the system rests with the customer.

Warranty: The HP 2647A is warranted against defects in materials and workmanship. Contact your local HP Sales Office for terms and conditions.

Specifications

GENERAL

Screen Size:	127 mm (5 inches) × 254 mm (10 inches)
Screen Capacity:	24 lines × 80 columns [A], 720 dots × 360 dots [G]
Character Generation:	7 × 9 enhanced dot matrix, 9 × 15 dot character cell, non-interlaced raster scan.
Character Size:	2.46 mm (0.097 inches) × 3.175 mm (0.125 inches) [A], 5 × 7 dot character cell [G]
Character Set:	128 characters upper/lower case, control codes
Cursor:	Blinking-underline [A], Crosshair [G]
Display Enhancements:	White on black, black on white (inverse video), half-bright (opt.), underline (opt.) and blinking (opt.)
Refresh Rate:	60 Hz or 50 Hz
Tube Phosphor:	P4
Implosion Protection:	Bonded implosion panel
Memory:	75 lines of 80 characters max. [A], 720 dots × 360 dots of displayable points [G], typically 9K–15K bytes basic work space.
Keyboard:	Detachable, user-defined soft keys, 18 control and editing keys, Graphics pad, cursor pad, auto-repeat, n-key rollover, 1.2 m (4 ft.) cable.
Option Slots:	1 available
Dual Cartridge Tapes:	Read/write speed: 10 ips. Search/rewind speed: 60 ips. Recording: 800 bits per inch. Storage capacity: 110K bytes max.

[A] Alphanumeric, [G] Graphics

DATA COMMUNICATIONS

Data Rate:	110, 150, 300, 1200, 2400, 4800, 9600 baud external switch selectable. Operations above 1200 baud may require nulls or handshake protocol to ensure data integrity. External clocking requires a TTL signal 16 × bps.
Vector Drawing Time:	9600 baud (typical), 7 ms half screen, 10 ms full screen.
Communication Interface:	Asynchronous, point-to-point, RS232C; compatible with Bell 103A modems; limited compatibility with Bell 202/D/S/T modems. Choose either main or reverse channel line turn-around for half duplex operation; CCITT V.24. Current loop, split speed, custom baud rates (opt.). Asynchronous multipoint communications (opt.). Synchronous multipoint communications (opt.).
Transmission Modes:	Full or half duplex, asynchronous.
Operating Modes:	On-line, off-line, character, block.
Parity:	Even, odd, none; switch selectable.
Peripheral Support:	The optional shared peripheral interface allows the user to connect up to a total of 8 of the following qualified peripheral devices only: 2631B/G, 7225A, 7245B, 7310A, 9872B/S, 9874A, 9876A, and 2647A terminals. The maximum overall interconnecting cable allowed is 15 m. The permissible overall interconnecting cable between the 2647A and any peripheral device is 2 meters of cable. System performance is a function of the application device type and the number of attached peripherals. Please refer to the examples given below.

Examples of Shared Peripherals Configurations

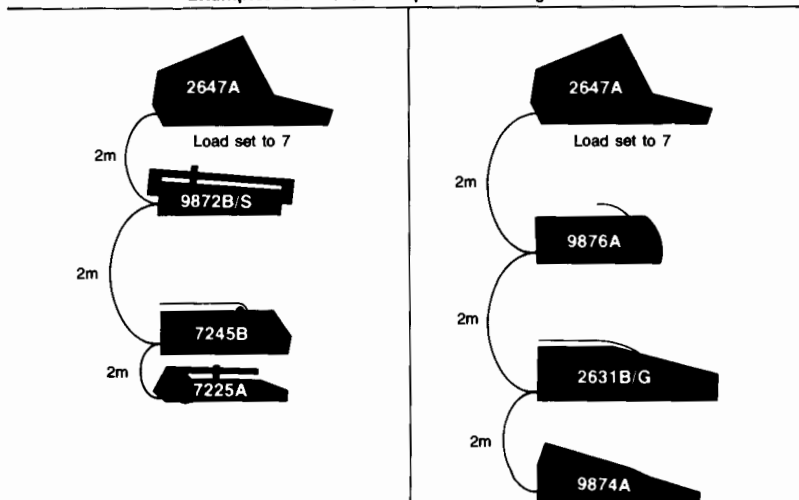

Contact Hewlett-Packard

We'll introduce you to our whole family of data terminals.

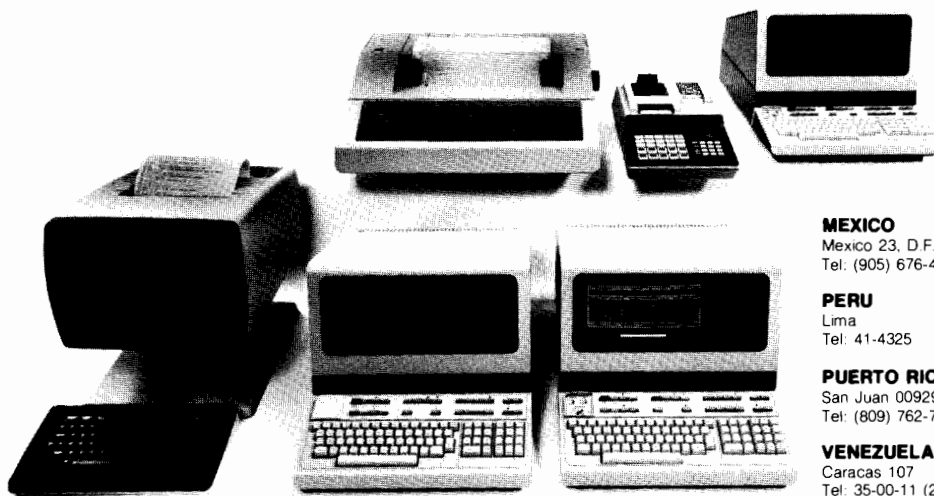

United States

ALABAMA

Huntsville
Tel: (205) 881-4591

ARIZONA

Phoenix
Tel: (602) 244-1361

CALIFORNIA

Fullerton
Tel: (714) 870-1000
Los Angeles
Tel: (213) 970-7500
Santa Clara
Tel: (408) 249-7000
Sacramento
Tel: (916) 929-7222
San Diego
Tel: (714) 279-3200

COLORADO

Englewood
Tel: (303) 771-3455

CONNECTICUT

New Haven
Tel: (203) 389-6551

FLORIDA

Ft. Lauderdale
Tel: (305) 973-2600
Orlando
Tel: (305) 859-2900

GEORGIA

Atlanta
Tel: (404) 955-1500

HAWAII

Honolulu
Tel: (808) 955-4455

ILLINOIS

Rolling Meadows
Tel: (312) 255-9800

INDIANA

Indianapolis
Tel: (317) 842-1000

IOWA

Iowa City
Tel: (319) 338-9466

LOUISIANA

Kenner
Tel: (504) 443-6201

MARYLAND

Baltimore
Tel: (301) 944-5400
Rockville
Tel: (301) 948-6370

MASSACHUSETTS

Lexington
Tel: (617) 861-8960

MICHIGAN

Farmington Hills
Tel: (408) 249-7000

MINNESOTA

Roseville
Tel: (612) 636-0700

MISSOURI

Kansas City, Tel: (816) 763-8000
Maryland Heights
Tel: (314) 878-0200

NEW JERSEY

Paramus
Tel: (201) 265-5000

NEW MEXICO

Albuquerque
Tel: (505) 292-1330
Las Cruces
Tel: (505) 526-2484

NEW YORK

New York City
Manhattan, Bronx
Contact Paramus,
NJ Office
Tel: (201) 265-5000

NEW YORK

Brooklyn, Queens,
Richmond
Contact Woodbury Office
Tel: (516) 921-0300

NEW YORK

Fairport
Tel: (716) 223-9950
Syracuse
Tel: (315) 454-2486
Woodbury
Tel: (516) 921-0300

NORTH CAROLINA

High Point
Tel: (919) 885-8101

OHIO

Cleveland
Tel: (216) 243-7300
Dayton
Tel: (513) 859-8202

OKLAHOMA

Oklahoma City
Tel: (405) 721-0200
Tulsa
Tel: (918) 665-3300

OREGON

Tualatin
Tel: (503) 620-3350

PENNSYLVANIA

Pittsburgh
Tel: (412) 782-0400
King of Prussia
Tel: (215) 265-7000

TEXAS

Richardson
Tel: (214) 231-6101
Houston
Tel: (713) 776-6400

UTAH

Salt Lake City
Tel: (801) 972-4711

VIRGINIA

Richmond
Tel: (804) 285-3431

WASHINGTON

Bellevue
Tel: (206) 454-3971

WISCONSIN

West Allis
Tel: (414) 541-0550

Canada

ALBERTA

Calgary
Tel: (403) 253-2713

BRITISH COLUMBIA

Vancouver
Tel: (604) 254-0531

NOVA SCOTIA

Dartmouth
Tel: (902) 469-7820

ONTARIO

Ottawa
Tel: (613) 820-6483
Mississauga
Tel: (416) 678-9430

QUEBEC

Pointe Claire
Tel: (514) 697-4232

Central and South America

ARGENTINA

Buenos Aires
Tel: 31-6063, 4, 5, 6

BRAZIL

06400 Barueri-SP
Tel: 429-3222
90000-Porto Alegre-RS
Tel: (0512) 22-2998, 22-5621
20000-Rio de Janeiro-GB
Tel: 257-80-94-DDD (021)

EL SALVADOR

San Salvador
Tel: 252787

GUATEMALA

Guatemala City
Tel: 63627, 64786,
66471-5, Ext. 9

IRELAND

Hewlett-Packard Ltd.
King Street Lane
Winnersh Wokingham
GB-Berkshire RG11 5AR
Tel: (0734) 78 47 74

CYPRUS

CY-Nicosia
Tel: 45628/29

HONG KONG

Hong Kong
Tel: H-255291-5

ITALY

1-20100 Milano
Tel: (2) 6251 (10 lines)
1-35100 Padova
Tel: (49) 66 48 88
1-00143 Roma
Tel: (06) 54 69 61

LUXEMBURG

B-1170 Brussels
Tel: (02) 672 22 40

NETHERLANDS

Amstelveen
Tel: (020) 47 20 21

NORWAY

N-1344 Haslum
Tel: (02) 17 11 80

SPAIN

E-Madrid 16
Tel: (1) 458 26 00 (10 lines)
E-Barcelona 17
Tel: (3) 203 6200 (5 lines)

SWEDEN

S-161 20 Bromma 20
Tel: (08) 730 05 50

SWITZERLAND

CH-8952 Schlieren Zurich
Tel: (01) 730 52 40
CH-1219 LeLignon-Geneva
Tel: (022) 96 03 22

UNITED KINGDOM

GB-Winnersh, Wokingham
Berks RG11 5AR
Tel: (0734) 78 47 74
GB-Altrincham
Cheshire WA14 1NU
Tel: (061) 928 6422
GB-Thornton Heath CR4 6XL
Surrey
Tel: (01) 684 0103/8

USSR

Moscow 101000
Tel: 207 59 24

Africa, Asia, Australia

AUSTRALIA

Fyshwick A.C.T. 2609
Tel: 95-2733
Pymble, New South Wales
Tel: 449-6566
Doncaster East, Victoria
Tel: 89-6351
Parkside, S.A.
Tel: 272-5911
Nedlands, W.A.
Tel: 86-5455

MEXICO

Mexico 23, D.F.
Tel: (809) 762-4600

PERU

Lima
Tel: 41-4325

PUERTO RICO

San Juan 00929
Tel: (809) 762-7255

VENEZUELA

Caracas 107
Tel: 35-00-11 (20 lines)

Europe

AUSTRIA

A-1205 Vienna
Tel: (0222) 351620 - 29

BELGIUM

B-1170 Brussels
Tel: (02) 672 22 40

DENMARK

DK-3460 Birkerød
Tel: (02) 81 66 40

FINLAND

SF-00211 Helsinki 21
Tel: 6923031

FRANCE

F-91401 Orsay
Tel: (1) 907 78 25
F-69130 Ecully
Tel: (78) 33 81 25
F-31300 Toulouse-Le Mirail
Tel: (61) 40 11 12
F-13721 Marignane
Tel: (91) 89 12 36

GERMAN FEDERAL REPUBLIC

D-6000 Frankfurt 56
Tel: (0611) 50 04-1
D-7030 Boblingen,
Wurttemberg
Tel: (0703) 667-1
D-4000 Dusseldorf
Tel: (0211) 59711
D-2000 Hamburg 1
Tel: (040) 24 13 93
D-3000 Hannover
Tel: (0511) 46 60 01
D-8012 Ottobrunn
Tel: (089) 601 30 61/7

GREECE

GR-Athens
Tel: 3237731