

HP

# 260084 LINE PRINTER



OPERATOR'S MANUAL

# OPERATOR'S MANUAL 2608A



Manual Part No. 02608-90901

Microfiche No. 02608-90801



HEWLETT-PACKARD COMPANY  
P.O. BOX 15, BOISE, IDAHO, U.S.A.

# Publication History

Changes in text to document updates subsequent to the initial release are supplied in manual update notices and/or complete revisions to the manual. The history of any changes to this edition of the manual is given below. The last update itemized reflects the machine configuration documented in the manual.

Any changed pages supplied in an update package are identified by an update number adjacent to the page number. Changed information is specifically identified by a vertical line (revision bar) on the outer margin of the page.

First Edition .....	MAR 79
Revised .....	NOV 81

## NOTICE

The information contained in this document is subject to change without notice.

HEWLETT-PACKARD MAKES NO WARRANTY OF ANY KIND WITH REGARD TO THIS MATERIAL, INCLUDING, BUT NOT LIMITED TO, THE IMPLIED WARRANTIES OF MERCHANTABILITY AND FITNESS FOR A PARTICULAR PURPOSE. Hewlett-Packard shall not be liable for errors contained herein or for incidental or consequential damages in connection with the furnishing, performance, or use of this material.

This document contains proprietary information which is protected by copyright. All rights are reserved. No part of this document may be photocopied or reproduced without the prior written consent of Hewlett-Packard Company.

Copyright ©1981 by Hewlett-Packard Company

**HP Computer Museum**  
**[www.hpmuseum.net](http://www.hpmuseum.net)**

**For research and education purposes only.**

**U.S.A. ONLY**

**FEDERAL COMMUNICATIONS COMMISSION  
RADIO FREQUENCY INTERFERENCE  
STATEMENT**

---

The Federal Communications Commission (IN 47 CFR 15.805) has specified that the following notice be brought to the attention of the users of this product.

**Warning:** This equipment generates, uses, and can radiate radio frequency energy and if not installed and used in accordance with the instructions manual, may cause interference to radio communications. As temporarily permitted by regulation it has not been tested for compliance with the limits for Class A computing devices pursuant to Subpart J of Part 15 of FCC Rules, which are designed to provide reasonable protection against such interference. Operation of this equipment in a residential area is likely to cause interference in which case the user at his own expense will be required to take whatever measures may be required to correct the interference.

5951-9004



# Table Of Contents



MEET THE HP 2608A PRINTER .....	1
SOME USEFUL INFORMATION .....	2
Options .....	2
Supplies and Accessories .....	3
Specifications .....	3
Service .....	5
Operator Safety .....	5
PREPARING YOUR PRINTER FOR USE .....	6
Environment .....	6
Unpacking and Inspection .....	6
Power .....	8
Installation .....	8
Ribbon Cartridge Loading and Removal .....	10
Paper Loading and Adjustment .....	12
Self Test .....	15
OPERATING YOUR PRINTER .....	18
Operator Controls and Indicators .....	18
Power On and Reset .....	24
On-Line/Off-Line .....	24
Print Mode Selection .....	24
Character Set Selection .....	24
Character Overstrike and Underlining .....	26
Vertical Line Spacing .....	26
Fault Conditions .....	26
Power Failure .....	27
OPERATOR MAINTENANCE .....	28
Preventive Maintenance .....	28
In Case Of Difficulty .....	28
COMMAND CODE SUMMARY .....	30
APPENDIX A. ASCII TABLES .....	34

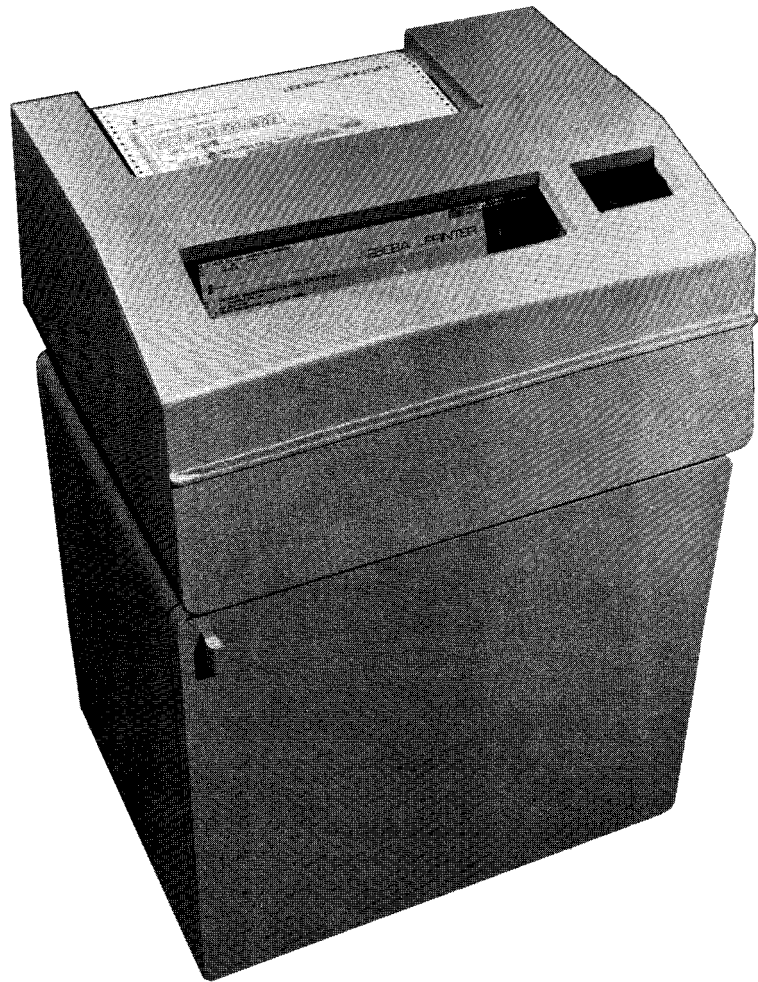



# Section I.

## Meet The HP 2608A Printer

Your HP 2608A Printer may be used in a wide range of applications. It is easy to operate, quiet and very reliable. Features of this printer which you will find particularly attractive include:

- Microprocessor control for flexibility and functional capabilities including an internal self test mode.
- Operator convenience with an easy-to-load, no-mess ribbon cartridge and conveniently located controls.
- High-resolution dot-matrix printing provides clean, crisp copies even with multi-part forms.
- Standard, Double Size, and Graphics print modes with program control of printing format. Sixteen channel programmable electronic VFC. Line spacing may be varied between 6 or 8 LPI via program control or from the control panel. The HP 2608A also has character overstrike capability which gives you the ability to construct special characters or underline selected portions of your output. Overstrike may be performed either a character at a time or a line at a time.
- Multiple character sets with up to 16 sets available under program control. Mechanical font changes are not required.

These features and more incorporated into the HP 2608A provide an investment in flexible, usable and low-cost printing capability. This manual will help you to get maximum return on your investment.

## Section II.

# Some Useful Information

### OPTIONS

The HP 2608A Printer is available in different configurations to match your applications and needs. These configurations are stated as options — three digit suffixes to the model number. These option numbers are marked on an identification tag which is located above the control panel under the access cover.

The standard HP 2608A is a 400 line per minute printer that features dot-matrix printing, a 128 UASACII character set and a 16-channel programmable Vertical Format Control (VFC). It is configured for 120 Vac operation. A parallel interface with differential line driver/receivers is standard for use with the 26099A interface in the HP 21XX family of computers or the 30209A interface in the HP 3000 computer family.

The printer comes equipped with a power cord, a stand assembly, one ribbon cartridge, a paper basket, three top-of-form adjustment scales, and one pad of printer layout forms.

Following is a list of available options for the HP 2608A Printer.

#### OPTION 001

Adds Arabic, Cyrillic, Katakana and Draw character sets.

#### OPTION 002

Adds European subset languages: French, German, Swedish/Finnish, Danish/Norwegian, Spanish, British; plus Japanese ASCII, Roman Extension Set, and APL (*A Programming Language.*)

#### OPTION 015

220 Vac, 50/60 Hz.

#### OPTION 016

100 Vac, 50/60 Hz.

#### OPTION 017

240 Vac, 50/60 Hz.

**OPTION 046**

Standard interface is replaced with Hewlett-Packard Interface Bus (*HP-IB*). Signal characteristics meet IEEE 488-1975.

**OPTION 090**

Replaces standard 11-inch VFC ROM assembly with 12-inch VFC ROM assembly.

**OPTION 106**

Adds ribbon cartridge six pack.

**OPTION 110**

Adds sound abatement cover and static eliminator bar.



Supplies and accessories recommended for use with your printer and available from Hewlett-Packard are listed below.

## SUPPLIES AND ACCESSORIES

**RIBBON CARTRIDGE**

P/N 02608-60038 (*single*)  
P/N 02608-60061 (*6-pack*)

**TOP OF FORM ADJUSTMENT SCALE**

P/N 7120-7364

**HP PRINTER LAYOUT FORM**

P/N 02608-90040 (*50-sheet pad*)

**PAPER**

The following are just a few commonly used papers. Others are available from paper suppliers. When designing custom forms, refer to the paper specifications in this manual. All forms listed below measure 11 × 14.87 inches.

P/N	DESCRIPTION	QUANTITY
9320-0331	one-part, white	one box, 3000 sheets
9320-1659	one-part, green bar	one box, 3000 sheets
9320-2417	two-part, green bar	one box, 1500 sheets
9320-2419	four-part, green bar	one box, 500 sheets

**SAFETY COMPLIANCE**

The HP 2608A is Listed by Underwriter's Laboratories, Inc. in the following categories with respective guide designations: Electronic Data Processing Equipment (*EMRT*), Teaching and Instruction Equipment (*WYFW*), and Office Appliances and Business Equipment (*QAOT*).

The Canadian Standards Association has certified this line printer as Data Processing Equipment.

Finally, this printer was designed to meet most European Safety and RFI/EMC standards for Electronic Data Processing Equipment effective prior to 1 June 1978. Any questions concerning regulatory agency compliance should be directed to the local Hewlett-Packard Sales Office.

## SPECIFICATIONS

## PHYSICAL

Width:	679.5 mm (26.75 inches)
Depth: (paper basket not attached)	554.6 mm (21.8 inches)
Height:	1042 mm (41 inches)
Weight:	97 kg (215 pounds)

## CLEARANCE REQUIREMENTS

Front and Rear:	Adequate for operator access — front: stand door rear: paper stack
Bottom:	Adequate to allow air flow for cooling.

## ELECTRICAL CHARACTERISTICS

	Input (Vac)	Frequency (Hz)
Voltage Source:	100 (+5%, -10%)	50/60 (+10%, -5%)
	120 (+5%, -10%)	50/60 (+10%, -5%)
	220 (+5%, -10%)	50/60 (+10%, -5%)
	240 (+5%, -10%)	50/60 (+10%, -5%)

Power Cable Length: 1.8 metres (6 feet)

Power Consumption: 225 VA non-printing  
700 VA printing (typical)  
1500 VA printing (maximum)

## PERFORMANCE

Character Formation:	Dot Matrix (5×7), (5×9), and (7×9)	
Line Length:	Up to 132 characters (66 characters maximum in double size letters).	
Print Speed:	<b>Lines Per Minute</b>	<b>Matrix Size</b>
	400	5×7
	320	5×9
	250	7×9
	40 dot rows per second with 924 dots per line maximum in Graphics Mode.	
Line Feed Rate 6/8 LPI:	15 ms	
Form Feed Rate 6/8 LPI:	14 inches/sec.	
Copies:	1 - 6 (up to 0.61 mm [0.025 inches] pack thickness)	

## VERTICAL FORMAT CONTROL

Number of Channels: 16 programmable

## ENVIRONMENTAL

Temperature	
Operating ( <i>Printer</i> ):	0 to 55 degrees C (32 to 131 degrees F)
Non-operating ( <i>Printer</i> ):	-40 to 75 degrees C (-40 to 167 degrees F)
Operating ( <i>Ribbon</i> ):	10 to 50 degrees C (50 to 122 degrees F)
Storage ( <i>Ribbon</i> ):	10 to 32 degrees C (50 to 90 degrees F)
Relative Humidity ( <i>Printer</i> ):	5% to 95% non-condensing
Audible Noise	Measured per ISO standard
Standard	
Standby:	55 db
Operating:	72 db
With low noise option	
Standby:	50 db
Operating:	68 db

## PAPER

The HP 2608A will accommodate continuous fan-fold edge-perforated paper varying in width from 130 mm (5 inches) to 375 mm (15 inches) edge to edge. It will accommodate forms thickness variations up to a total pack thickness of 0.61 mm (0.025 inches). Forms thicker than 0.61 mm should be tested to verify that they will print successfully. Recommended paper weights are: 15 to 20 pounds single part and 11 pounds multi-part forms. Forms and card stock should be tried for satisfactory feeding, registration, and print quality. Multi-part forms must be held together without the use of metal or plastic fasteners.

Forms should be tried at high humidity for satisfactory feeding and handling; and at low humidity to determine if static buildup must be eliminated for proper stacking.

Hewlett-Packard offers both service contracts and "time and material" service for the HP 2608A Printer. HP Sales and Service Offices are listed at the back of this manual. If you have a need for service or questions regarding service, contact the HP office nearest you.

Close the access cover when the printer is in a ready-to-operate condition and when it is operating. Keep hands, long hair, necklaces and articles of clothing such as long sleeves out of the printer when ready-to-operate or operating conditions exist.

## SERVICE

## OPERATOR SAFETY

## Section III.

# Preparing Your Printer For Use

The following procedures should be followed closely so that your printer will perform with maximum efficiency.

### ENVIRONMENT

Your printer should be located in a clean, traffic free environment, preferably an area not subjected to excessive shocks, vibrations or wide ranges of ambient temperature. Air conditioning is not required to ensure reliable operation of the HP 2608A; however, under no circumstances should the environmental specifications be exceeded.

The location must provide adequate operator access to both the front and rear of the printer. Air flow for cooling the printer must also be maintained through air intakes in the base of the printer stand; therefore nothing should be placed under the stand base, and this area should be clean and dust free at all times. Deep pile and shag carpeting should not be used under the printer.

If the printer will be operated in either high or low humidities, check with your HP representative for options or accessories which will help optimize paper handling.

### UNPACKING AND INSPECTION

#### PERFORM THE FOLLOWING STEPS TO UNPACK YOUR PRINTER:

- a. Remove metal clamps and straps; then lift the top of the packing crate clear of the unit.
- b. Remove the unloading ramp which is taped to the printer stand assembly.
- c. The four stand levellers are clamped to the packing crate base. Loosen the bolts on the right side of the printer and remove the bolts, clamps, and wood blocks on the left side of the printer.
- d. Position the ramp as shown, and roll the printer off the packing crate base. Some force will be required to move the printer at first because the right side levellers are resting on the wooden base.
- e. Remove all hold-down taping from the printer and stand assembly.
- f. Attach the paper basket to the rear of the stand.
- g. Open the printer access cover and remove the core bar lock and mounting hardware.

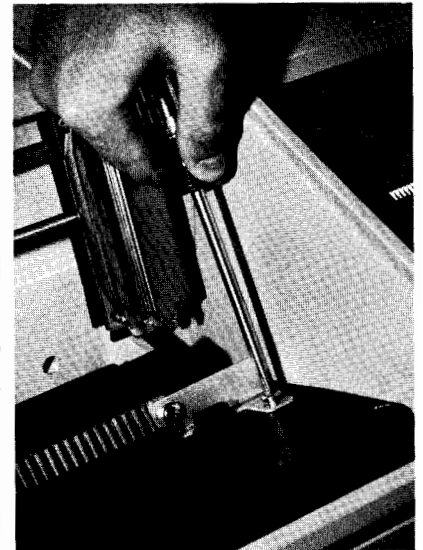
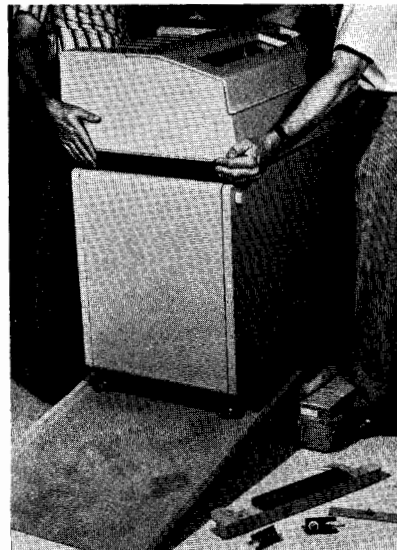
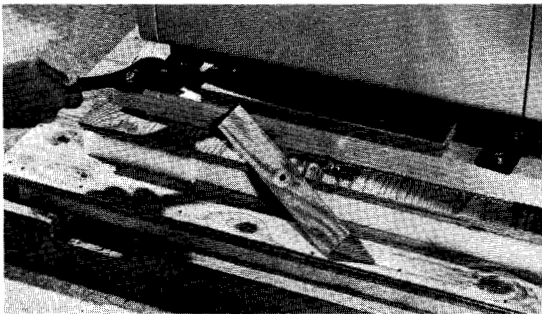
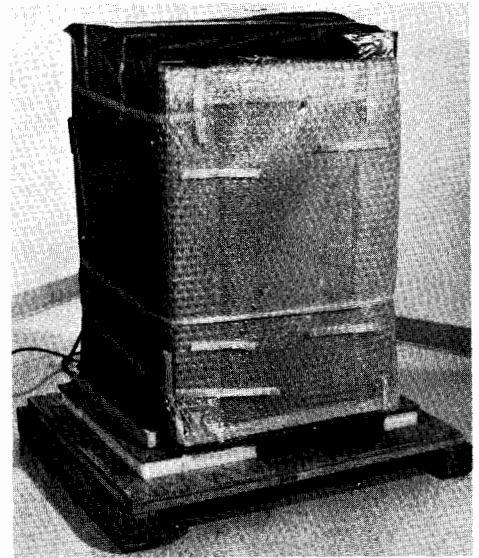
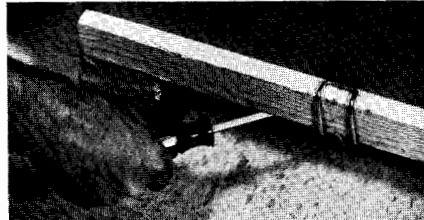
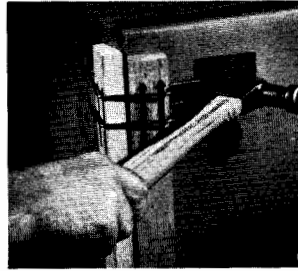

## NOTE

**Do not destroy or discard the shipping container or any packing material. They will be required in case of a damage claim, and will be needed for reshipment of the printer if it should be necessary to return the printer to the factory.**

Inspect the unit for signs of physical damage (*cracks, broken parts, etc.*). If the printer or the stand appear to have been damaged in shipment, notify the carrier and your HP Sales and Service Office immediately. An HP representative will arrange for repair or replacement of the damaged unit.

After you have completed unpacking your printer, check all shipping documents and the identification tags on the back of the printer and under the access cover to make certain that the printer conforms to your purchase specifications.

## POWER

The HP 2608A has a maximum power requirement of 1500 VA. One of the following power sources must be available for operating the printer: 100, 120, 220, or 240 volts ac. Your printer has been shipped to match the power source at your location. If it becomes necessary to change to a different power source, contact your HP Service Representative.

The main power switch on the back of the printer also functions as a circuit breaker. The circuit breaker will be tripped by excessive current. To restore normal operation, turn the switch on again.

### CAUTION

**If the circuit breaker trips repetitively, contact your HP Service Representative.**

## INSTALLATION

### PERFORM THE FOLLOWING STEPS TO INSTALL THE PRINTER:

- a. Make certain the operating location you have selected provides sufficient clearance as specified in Section 1 of this manual.
- b. Make certain that the main power switch located on the back of the printer is turned off.

### CAUTION

**The power cable must be plugged into the power source before connecting the interface cable to the printer. Failure to do so may cause possible damage to internal circuitry.**

- c. Connect the power cable to the printer and to the power source. Connect the interface cable to the printer and to the system interface.
- d. Unscrew the four levellers until the printer stand no longer rests on the casters.
- e. Install ribbon cartridge and load paper in accordance with the instructions on pages 10 and 12.

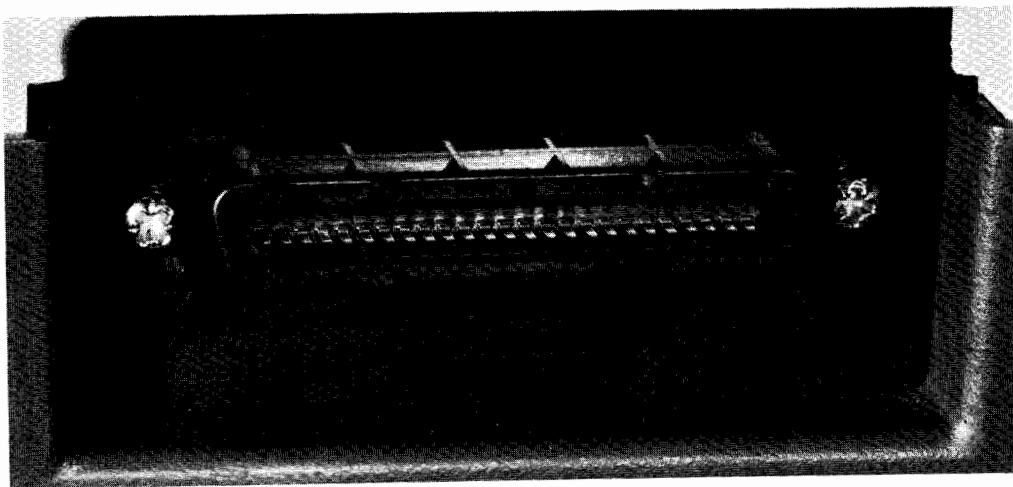

**PARALLEL DIFFERENTIAL INTERFACE CONNECTION**



If your printer has been configured for HP-IB operation, a five switch module located on the back of the printer is used to establish the printer's system address. Address bits are set (1 = high) when toggled to the on position. Switch settings for address selection are illustrated in the following sketch.

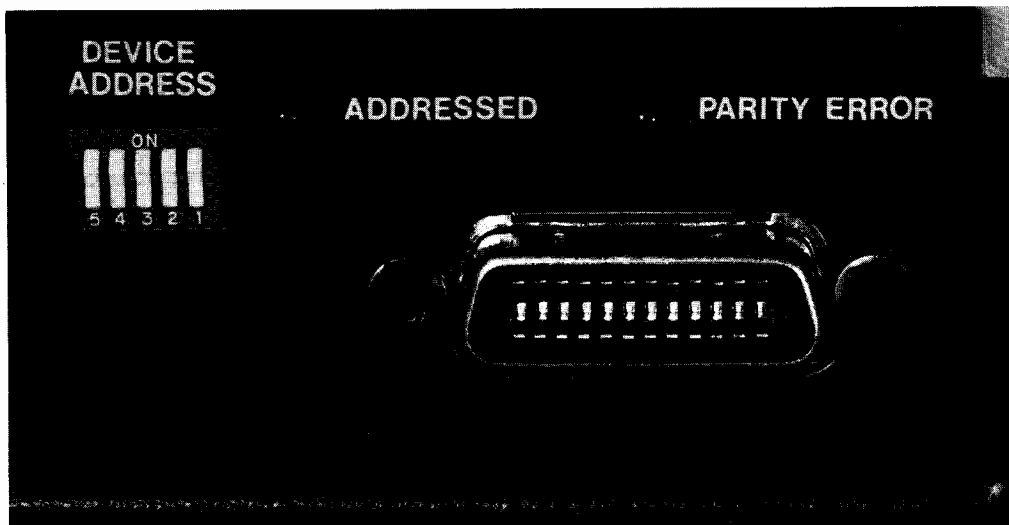

### HP-IB CONNECTION

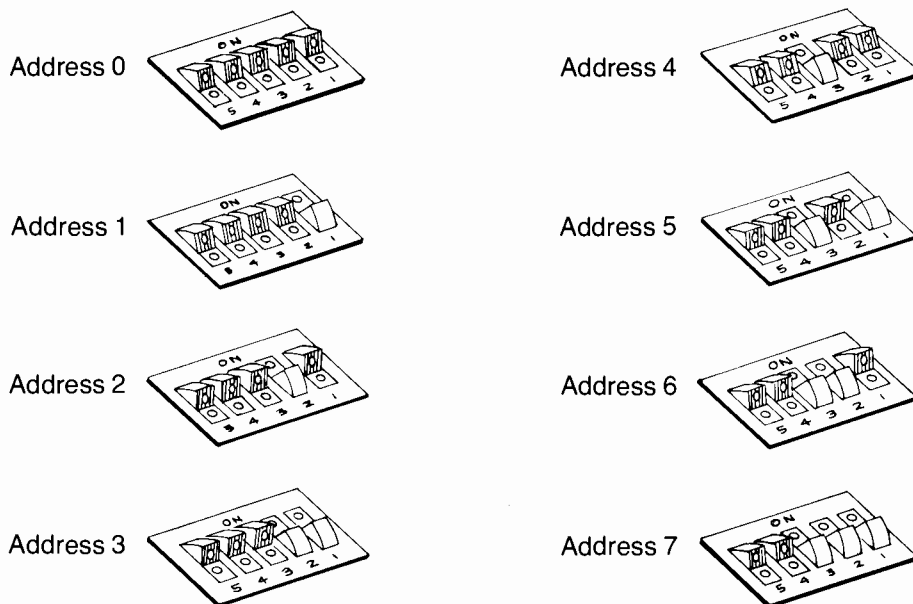

### NOTE

The HP 2608A can be configured to respond to any one of 31 usable addresses.

## **RIBBON CARTRIDGE LOADING AND REMOVAL**

Tools are not required to install or remove the ribbon cartridge.

### **NOTE**

An interlock prevents printing when either the ribbon cartridge is removed or the platen is open. A fault indication will be displayed on the control panel by the PLATEN/RIBBON Fault Indicator during ribbon removal and installation and also when a paper jam has been detected.

Following a paper jam condition, replace paper in the tractors, close the platen, and realign the top-of-form. This should reset the error condition. If, however, the PLATEN/RIBBON LED does not extinguish, give the printer four line feeds to clear the error.

### **TO INSTALL THE RIBBON CARTRIDGE:**

- a. Pull the platen release lever toward you to open the platen.
- b. Slide the ribbon into place between the print mechanism and the metal ribbon shield, as shown in the sketch.
- c. Fit the mounting lug on the lower left underside of the ribbon cartridge into the mounting slot on the metal base.
- d. Use the knurled knob on the top right side of the cartridge to tension the ribbon, and then align the cartridge on the drive shaft.
- e. Make certain the cartridge is secured on both the left and right ends, and that the ribbon is completely positioned in front of the print mechanism
- f. Close the platen.

### **TO REMOVE THE RIBBON CARTRIDGE:**

- a. Pull the platen release lever toward you to open the platen.
- b. Lift the back side of the ribbon cartridge until you have removed it from the drive shaft and the mounting slot in the metal base.
- c. Use the knurled knob on the top right side of the cartridge to maintain tension on the ribbon and remove the ribbon from the print mechanism by pushing it slightly forward and then lifting it upward and out of the printer.
- d. Discard the used ribbon cartridge.
- e. Close the platen and clean any paper, dust or residue from the area under the ribbon cartridge.

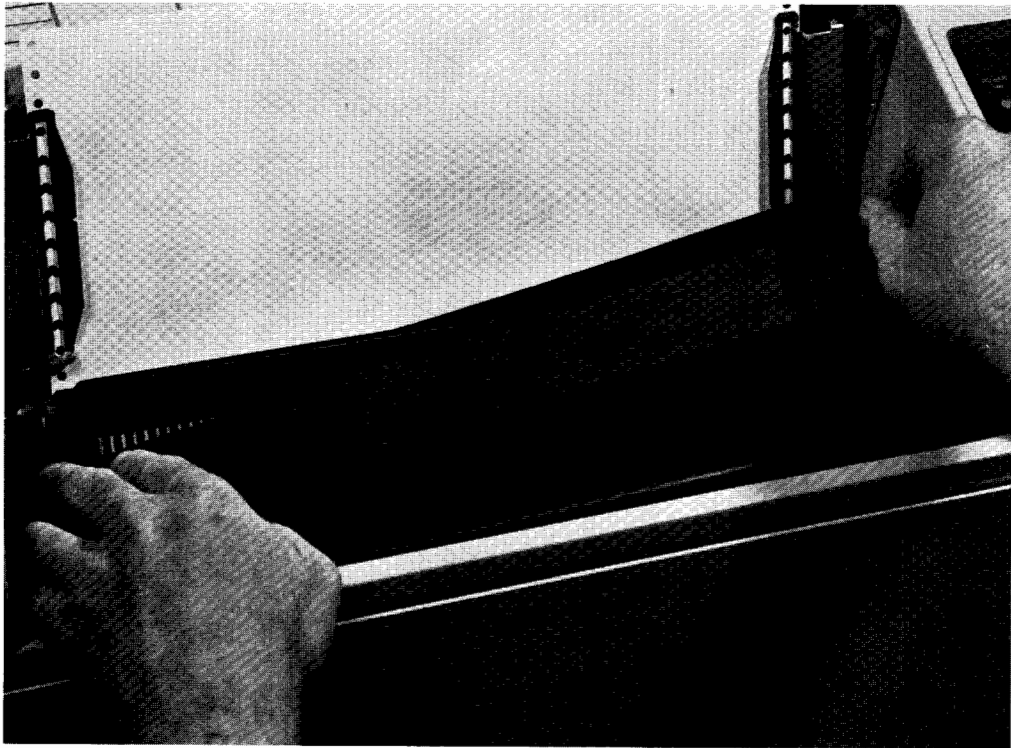
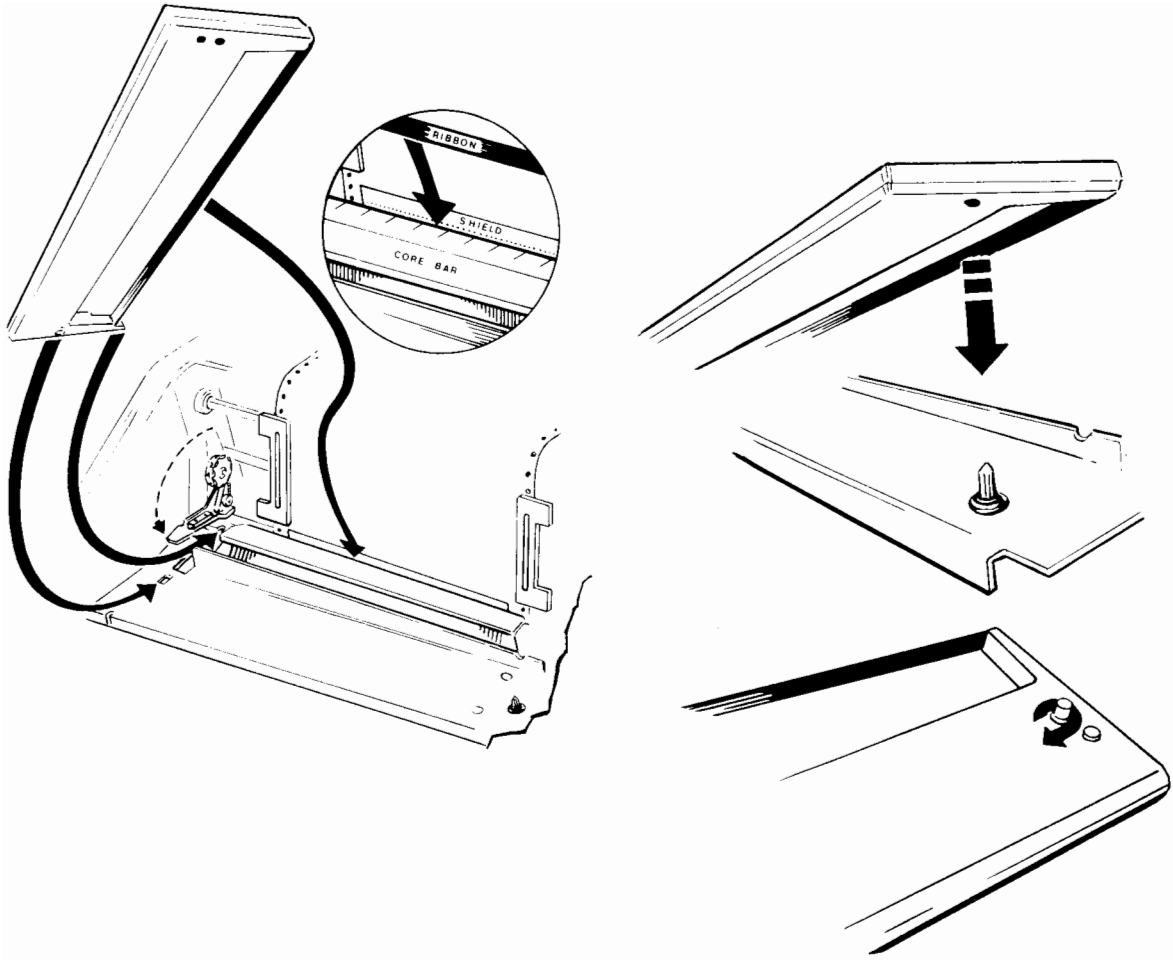

**RIBBON LOADING**

## PAPER LOADING AND ADJUSTMENT

Paper is loaded through the bottom of the HP 2608A. To load paper:

- a. Position the paper supply inside the printer stand against the left side alignment bracket.
- b. Pull the platen release lever toward you to open the platen.
- c. Open the access cover; then open both tractors. If a different form or horizontal position is required, unclamp both tractors so they may be adjusted to a different width. The tractors should be positioned so that paper may be pushed up into the printer without hitting the open tractor doors.

### NOTE

An interlock prevents printing when the platen is open. A fault indication will be displayed on the control panel by the PLATEN/RIBBON Fault Indicator during paper loading and adjustment.

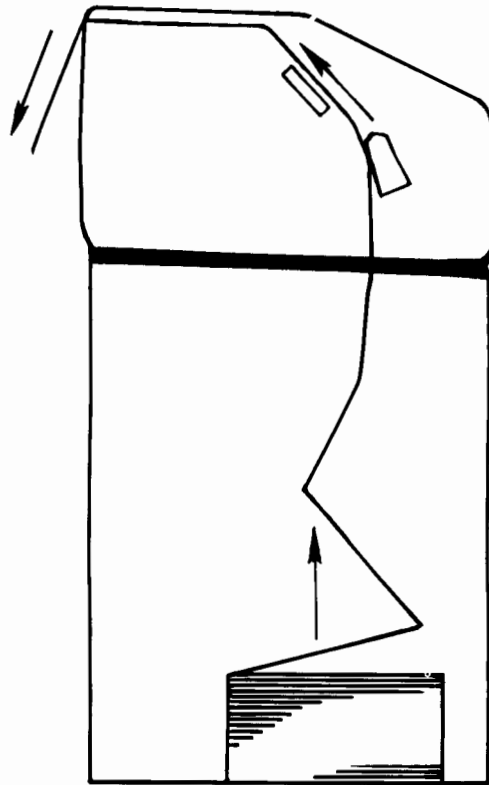

- d. Push the paper up into the printer from below until it appears above the print mechanism; then pull the paper up until the holes can be matched to the tractor lugs. Make certain the paper is not skewed to either side. Close the tractors. Push the platen release lever to close the platen. If the forms thickness has been changed, use the Platen Adjust Knob to adjust the gap for maximum print quality.
- e. Clamp the tractors in place on the tractor guide shaft if previously released.
- f. When the printer runs out of paper, it stops at Top Of Form. It is only necessary to use the FORM FEED switch to advance the printer to the Top Of Form position if paper out did not occur.

## NOTE

**Pressing the RESET switch will clear all pre-established or programmatically controlled conditions of the printer to power-on status. Therefore, it is recommended that the RESET switch not be used to define Top Of Form. Refer to the Power On and Reset discussion on page 24 of this manual.**

- g. One of two methods may be used to move the paper to the desired Top Of Form position as explained in the following paragraphs:

Use the LINE FEED switch to advance the paper one line at a time and align the horizontal paper perforation with the desired form length on the scale (*8-inch through 12-inch*) which is located on the top of the printer. For example, if you want to print on an 11-inch form, advance the form until the desired first print position is aligned with the 11-inch mark on the scale. Use of the LINE FEED switch does not change logical Top of Form when paper out has occurred.

OR

For more exact adjustment of the paper, use the plastic Top Of Form adjustment scale which is supplied with the printer. This scale will provide precise adjustment for forms from one to 12 inches in length.

Open the left paper tractor. Align the desired form length (*form length is indicated on the left edge of the scale*) with the horizontal paper perforation and match the holes in the adjustment scale to the tractor lugs. Close the paper tractor.

Use the LINE FEED switch or the UP/DOWN forms adjust switches to align the desired measurement increment (*located on the right edge of the scale*) with the v-notch on the left paper tractor. For example, if you want the first line of print to be one inch from the perforation on an 11-inch form, align the one inch measurement on the right side of the scale with the v-notch on the left paper tractor.

Use the UP and DOWN Forms Adjust switches to make the final fine adjustment for locating the first line of print. The UP switch advances paper one dot row at a time. If the switch is held down, paper will continue to advance. The DOWN switch retracts paper; however, if the platen is not open, you must tension the paper below the printer (*or release the platen*) to allow it to move in the reverse direction. Use of these Forms Adjust switches never changes logical Top Of Form. Final forms adjustment must be made by moving the paper upward with the platen closed to ensure proper tensioning of the paper.

- h. A horizontal scale located on the top of the core bar provides column locations for each of the 132 print columns. Horizontal adjustments may be made by unclamping both tractors and moving both tractors and paper to the desired position.

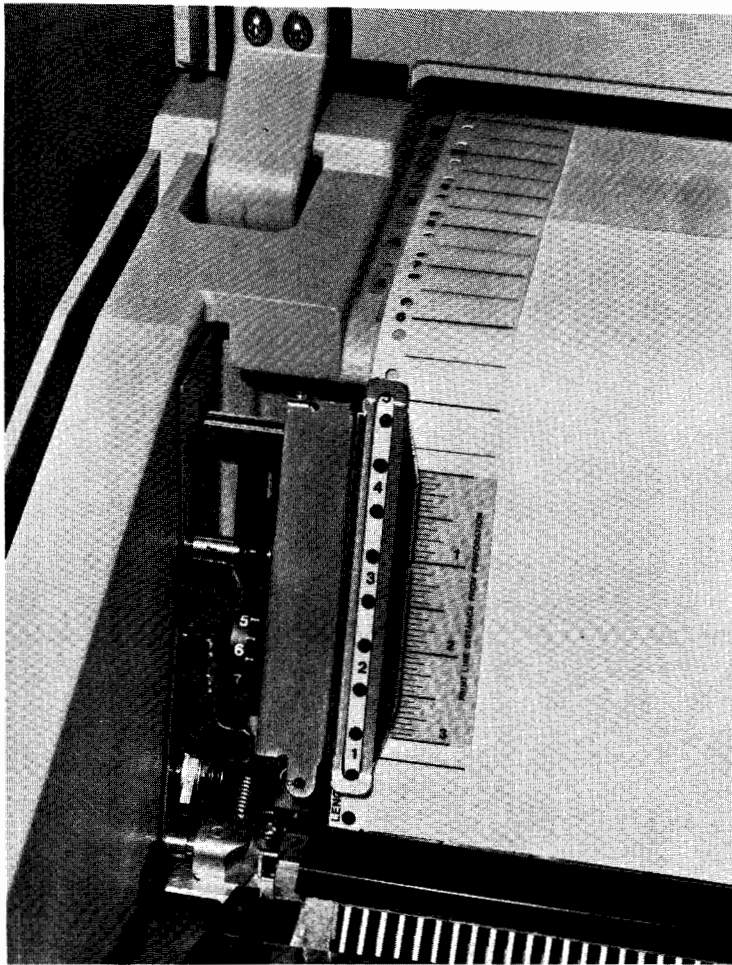
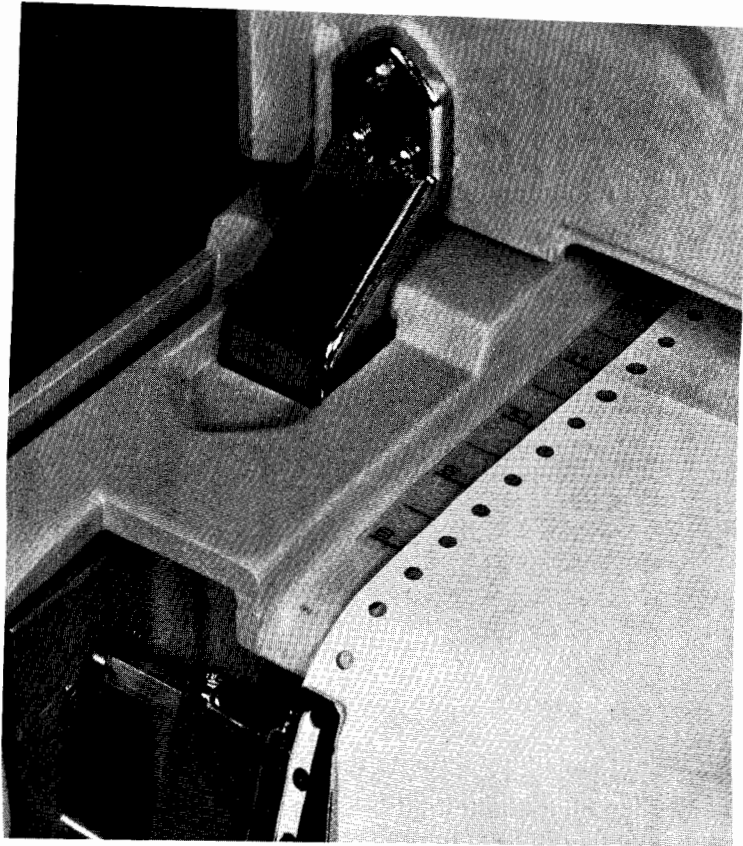

- i. Close the access cover. Be certain that the leading edge of the paper protrudes through the paper exit without binding.
- j. Logical Top Of Form is defined as the present paper position when the printer is put On-Line after a paper-out condition has occurred.
- k. To remove paper, tear below the machine (inside the stand) and operate the FORM FEED switch until all paper is clear of the machine.

**CAUTION**

**Do not pull paper down through the printer because perforations may catch and damage the ribbon shield or paper out switches.**



The SELF TEST switch on the operator control panel is used to initiate a routine which tests the printer to verify its operational status. This self test function may also be performed under program control.

**SELF TEST**

To perform self test from the operator control panel, the printer must be off-line. If a paper out or platen/ribbon fault condition exists, none of the printing tests will be performed. Push the SELF TEST switch to activate the self test routine. When the switch is pressed, the following tests are performed:

Test Performed	Test Number
Processor Direct Control and Interrupt	001
Input Bus	010
Output Bus	011
RAM	100
Character Generation	101
Servo Loop	110

Next, a one page self test printout is completed as shown on page 17. Note that in the first portion of the printout, only the character sets which are installed in your machine are printed.

When self test has been completed, the printer is returned to its prior status and ready for normal operation.

If a detectable problem exists within the printer, the TEST FAIL indicator will light. To help you determine the nature of the problem, the HP 2608A has been designed to provide you with the number of the test which fails.

Depress and hold down the SELF TEST switch. With the switch held down a binary number will be displayed by the PRINT MECH, PAPER OUT, and PLATEN/RIBBON indicators. For example, if self test has failed and the Fault Indicators for PLATEN/RIBBON and PAPER OUT are lighted, the printer has failed the Output Bus test (011). Refer to the Test Number column in the above table and the illustration on page 16. The printer must be reset to clear the TEST FAIL fault condition.

If you cannot restore operating status after a Self Test failure, report the test number of the failure to your HP Service Representative.

**BINARY DISPLAY  
INDICATION FOR A  
SELF TEST FAILURE**

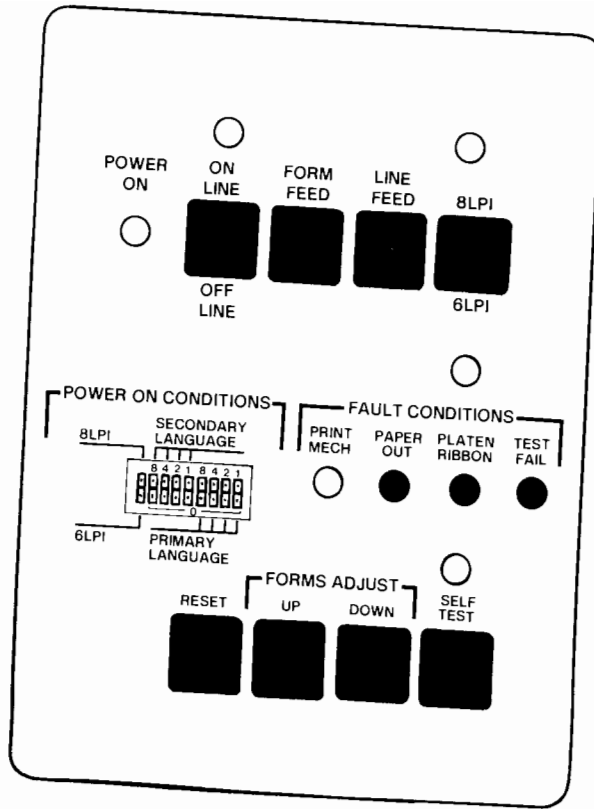

Output Bus Test Failure  
(Test No. 011)

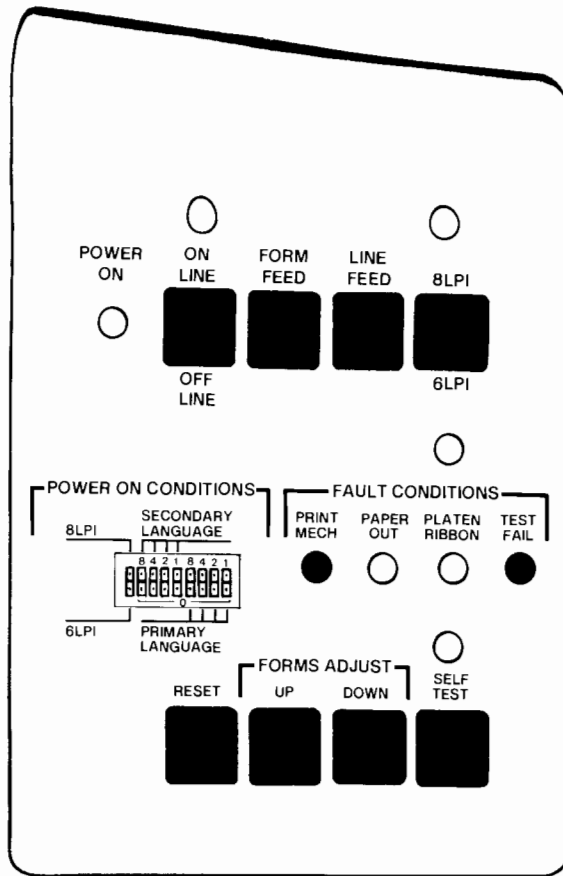

RAM Test Failure  
(Test No. 100)



SELF TEST PRINTOUT

0B 0123456789:;<=>?@ABCDEF GHI JKLMNOPQRSTUVWXYZ[\]^\_`a
1B 0123456789:;<=>?@ABCDEF GHI JKLMNOPQRSTUVWXYZ[\]^\_`a
2B 0123456789:;<=>?@ABCDEF GHI JKLMNOPQRSTUVWXYZ[\]^\_`a
3B 0123456789:;<=>?@ABCDEF GHI JKLMNOPQRSTUVWXYZ[\]^\_`a
4B 0123456789:;<=>?@ABCDEF GHI JKLMNOPQRSTUVWXYZ[\]^\_`a
5B NOT INSTALLED
7B 0123456789:;<=>?@ABCDEF GHI JKLMNOPQRSTUVWXYZ[\]^\_`a
10B 0123456789:;<=>?@ABCDEF GHI JKLMNOPQRSTUVWXYZ[\]^\_`a
11B 0123456789:;<=>?@ABCDEF GHI JKLMNOPQRSTUVWXYZ[\]^\_`a
12B 0123456789:;<=>?@ABCDEF GHI JKLMNOPQRSTUVWXYZ[\]^\_`a
13B 0123456789:;<=>?@ABCDEF GHI JKLMNOPQRSTUVWXYZ[\]^\_`a
14B 0123456789:;<=>?@ABCDEF GHI JKLMNOPQRSTUVWXYZ[\]^\_`a
15B 0123456789:;<=>?@ABCDEF GHI JKLMNOPQRSTUVWXYZ[\]^\_`a
16B 0123456789:;<=>?@ABCDEF GHI JKLMNOPQRSTUVWXYZ[\]^\_`a
17B 0123456789:;<=>?@ABCDEF GHI JKLMNOPQRSTUVWXYZ[\]^\_`a



! "#%&'()\*+,-./0123456789:;<=>?@ABCDEF GHI JKLMNOPQRSTUVWXYZ[\]^\_`a
! "#%&'()\*+,-./0123456789:;<=>?@ABCDEF GHI JKLMNOPQRSTUVWXYZ[\]^\_`ab
" #%&'()\*+,-./0123456789:;<=>?@ABCDEF GHI JKLMNOPQRSTUVWXYZ[\]^\_`abc
# %&'()\*+,-./0123456789:;<=>?@ABCDEF GHI JKLMNOPQRSTUVWXYZ[\]^\_`abcd
%&'()\*+,-./0123456789:;<=>?@ABCDEF GHI JKLMNOPQRSTUVWXYZ[\]^\_`abcde
&'()\*+,-./0123456789:;<=>?@ABCDEF GHI JKLMNOPQRSTUVWXYZ[\]^\_`abcde
'()\*+,-./0123456789:;<=>?@ABCDEF GHI JKLMNOPQRSTUVWXYZ[\]^\_`abcde
()\*+,-./0123456789:;<=>?@ABCDEF GHI JKLMNOPQRSTUVWXYZ[\]^\_`abcde
)+,-./0123456789:;<=>?@ABCDEF GHI JKLMNOPQRSTUVWXYZ[\]^\_`abcde
),-./0123456789:;<=>?@ABCDEF GHI JKLMNOPQRSTUVWXYZ[\]^\_`abcde
)-./0123456789:;<=>?@ABCDEF GHI JKLMNOPQRSTUVWXYZ[\]^\_`abcde
).-/0123456789:;<=>?@ABCDEF GHI JKLMNOPQRSTUVWXYZ[\]^\_`abcde
)-./0123456789:;<=>?@ABCDEF GHI JKLMNOPQRSTUVWXYZ[\]^\_`abcde
.)-/0123456789:;<=>?@ABCDEF GHI JKLMNOPQRSTUVWXYZ[\]^\_`abcde
-./0123456789:;<=>?@ABCDEF GHI JKLMNOPQRSTUVWXYZ[\]^\_`abcde
./0123456789:;<=>?@ABCDEF GHI JKLMNOPQRSTUVWXYZ[\]^\_`abcde
/0123456789:;<=>?@ABCDEF GHI JKLMNOPQRSTUVWXYZ[\]^\_`abcde
0123456789:;<=>?@ABCDEF GHI JKLMNOPQRSTUVWXYZ[\]^\_`abcde
123456789:;<=>?@ABCDEF GHI JKLMNOPQRSTUVWXYZ[\]^\_`abcde
23456789:;<=>?@ABCDEF GHI JKLMNOPQRSTUVWXYZ[\]^\_`abcde
3456789:;<=>?@ABCDEF GHI JKLMNOPQRSTUVWXYZ[\]^\_`abcde
456789:;<=>?@ABCDEF GHI JKLMNOPQRSTUVWXYZ[\]^\_`abcde
56789:;<=>?@ABCDEF GHI JKLMNOPQRSTUVWXYZ[\]^\_`abcde
789:;<=>?@ABCDEF GHI JKLMNOPQRSTUVWXYZ[\]^\_`abcde
9:;<=>?@ABCDEF GHI JKLMNOPQRSTUVWXYZ[\]^\_`abcde
:;<=>?@ABCDEF GHI JKLMNOPQRSTUVWXYZ[\]^\_`abcde
;<=>?@ABCDEF GHI JKLMNOPQRSTUVWXYZ[\]^\_`abcde
=>?@ABCDEF GHI JKLMNOPQRSTUVWXYZ[\]^\_`abcde
?@ABCDEF GHI JKLMNOPQRSTUVWXYZ[\]^\_`abcde
@ABCDEF GHI JKLMNOPQRSTUVWXYZ[\]^\_`abcde
ABCDEF GHI JKLMNOPQRSTUVWXYZ[\]^\_`abcde
BCDEF GHI JKLMNOPQRSTUVWXYZ[\]^\_`abcde
CDEF GHI JKLMNOPQRSTUVWXYZ[\]^\_`abcde
DEF GHI JKLMNOPQRSTUVWXYZ[\]^\_`abcde
EF GHI JKLMNOPQRSTUVWXYZ[\]^\_`abcde
FGHI JKLMNOPQRSTUVWXYZ[\]^\_`abcde
GHI JKLMNOPQRSTUVWXYZ[\]^\_`abcde
HI JKLMNOPQRSTUVWXYZ[\]^\_`abcde
I JKLMNOPQRSTUVWXYZ[\]^\_`abcde
JKLMNOPQRSTUVWXYZ[\]^\_`abcde
KLMNOPQRSTUVWXYZ[\]^\_`abcde
LMNOPQRSTUVWXYZ[\]^\_`abcde
MNOPQRSTUVWXYZ[\]^\_`abcde
NOPQRSTUVWXYZ[\]^\_`abcde
OPQRSTUVWXYZ[\]^\_`abcde
PQRSTUVWXYZ[\]^\_`abcde
QRSTUVWXYZ[\]^\_`abcde
RSTUVWXYZ[\]^\_`abcde
STUVWXYZ[\]^\_`abcde
TUVWXYZ[\]^\_`abcde
UVWXYZ[\]^\_`abcde
VWXYZ[\]^\_`abcde
WXYZ[\]^\_`abcde
XYZ[\]^\_`abcde
YZ[\]^\_`abcde
Z[\]^\_`abcde
[\]^\_`abcde
]^\_`abcde
]\_`abcde
\_`abcde
`abcde
abcde
bcde
cde
de
e
f
g
h
i
j
k
l
m
n
o
p
q
r
s
t
u
v
w
x
y
z
{
|
}
~
! "#%&'()\*+,-./0123456789:;<=>?@ABCDEF GHI JKLMNOPQRSTUVWXYZ[\]^\_`a

# Section IV.

## Operating Your Printer

### OPERATOR CONTROLS AND INDICATORS

Operating the HP 2608A Printer consists primarily of understanding the use and functions of controls and indicators on the printer. Many functions can be controlled by command codes transmitted to the printer. Command codes recognized by the HP 2608A are summarized in this manual and explained in detail in the HP 2608A Technical Reference Manual (HP Part No. 02608-90903). The following table and figures define and locate the printer controls and indicators.

Control/Indicator	Description
MAIN POWER ON/OFF SWITCH	This rocker switch is located on the back of the printer, and is used to control the voltage supply to the printer. This switch is also a circuit breaker and is used to restore power after the breaker has been tripped.
POWER ON INDICATOR	This LED indicator is located on the control panel and is on when the main power switch has been turned on and all power supplies are stable. Power On status is reached in approximately five seconds.
ON/OFF-LINE SWITCH AND INDICATOR	This momentary switch with LED indicator is used to give control of the printer to another device ( <i>on-line</i> ) or to the operator ( <i>off-line</i> ). This switch will transfer the printer on-line if no fault conditions exist. If the printer is on-line and you press "Off-Line", the printer will go off-line as soon as it has executed any pending commands and the data buffers are empty.
FORM FEED SWITCH	This momentary switch is used to advance the paper to the next Top Of Form position. If the switch remains held down, the printer will pause for approximately 120 ms and then advance to a new Top Of Form. This action will continue for as long as the switch remains depressed. This switch functions only when the printer is off-line and not in the Self Test Mode.

Control/Indicator	Description
LINE FEED SWITCH	This momentary switch is used to advance paper to the next print line for the line spacing which has been established by either the 6/8 LPI switch or via program control. If the switch remains held down, the printer will pause for approximately 120 ms and then advance paper at an increased rate. This action will continue for as long as the switch remains depressed. This switch functions only when the printer is off-line and not in the Self-Test Mode.
6/8 LPI SWITCH	This momentary switch with LED indicators is used to redefine the vertical format to one of the standard definitions and to reverse the vertical line spacing which has been established either by the 6/8 LPI default switch or by remote control. Note that if a vertical format has been defined programmatically, activating this switch will override that definition and redefine the present paper position as Top Of Form. This switch functions only when the printer is off-line and not in the Self Test Mode.
SELF TEST SWITCH	This momentary switch with LED indicator initiates a routine that tests the printer to determine if it is in proper operating condition. A detailed description of this test routine is presented in Self Test on page 15 of this manual. This switch functions only when the printer is off-line.
RESET SWITCH	This momentary switch initiates a sequence that removes all programmable information which has been entered into the printer. When this switch is used, the printer returns to power-on status including redefinition of the present paper position as Top Of Form. Do not use the RESET switch unless this is exactly what you want to happen. This switch functions when the printer is either on-line or off-line.
FORMS ADJUST SWITCHES: UP, DOWN	These two momentary switches are used to make fine vertical adjustments of the paper. The DOWN switch retracts paper; however, if the platen is not open, the operator must tension the paper below the print mechanism ( <i>or open the platen</i> ) to allow it to move in the reverse direction ( <i>make certain that the paper — especially the perforation — does not catch the ribbon shield and force it down into the machine</i> ). Operation of these switches does not change the logical Top Of Form. These switches function only when the printer is off-line and not in the Self Test Mode.

Control/Indicator	Description
<p>FAULT CONDITION INDICATORS</p> <ul style="list-style-type: none"> <li>• Test Fail</li> <li>• Print Mech</li> <li>• Paper Out</li> <li>• Platen/Ribbon</li> </ul>	<p>The purpose of these indicators is to assist you in identifying problems which prevent normal operations.</p> <p>This indicator shows that the Self Test routine has failed. Refer to the detailed Self Test discussion on page 15 of this manual.</p> <p>This indicator shows that a fault condition exists in the print mechanism control system. Refer to Fault Conditions on page 26 of this manual.</p> <p>When lit, this indicator shows that the printer is out of paper. The indicator will remain on until paper has been reloaded and the printer put back on-line. Refer to Paper Loading on page 12 of this manual.</p> <p>This indicator shows that the ribbon is not installed, the platen is open, or that a paper jam has been detected. Refer to Ribbon Cartridge Loading and Removal on page 10 of this manual. Also refer to Paper Loading and Adjustment on page 12.</p>
<p>POWER ON CONDITIONS SWITCH</p>	<p>This nine-position rocker switch is used for character set selection and to establish vertical line spacing for power-on and reset status. The switch positions are read only when the printer undergoes a power-on, reset, or programmatic clear. Refer to Character Set Selection and Vertical Line Spacing on pages 24 and 26 of this manual.</p>
<p>TRACTOR CLAMP</p>	<p>This lever locks tractors in place after paper has been adjusted horizontally.</p>
<p>TOP OF FORM INDICATORS</p>	<p>Two TOF indicators are provided. One is located on the top cover and may be used to establish top of form with forms varying from eight to twelve inches in length. The second is a separate mylar adjustment scale and may be used for more precise alignment requirements. This scale provides alignment in dot row increments.</p>
<p>PLATTEN RELEASE LEVER</p>	<p>This lever located on the left side of the print mechanism is used to open and close the platen so that paper and ribbon may be loaded or removed. Paper should not be pulled down through the platen gap when being removed. Tear paper off below the paper inlet and then eject the remaining paper by using the FORM FEED switch.</p>

Control/Indicator	Description
HORIZONTAL SCALE	This scale indicates column numbers (1 - 132) for standard print mode.
PLATEN ADJUST KNOB	This rotary control is used to adjust the platen-to-hammer gap for best print quality with different forms of thicknesses. Setting No. 0 provides the minimum platen-to-hammer gap. Setting No. 9 provides the maximum gap. This is an arbitrary scale and the numbers do not correlate to the number of sheets in a multi-part form.
DEVICE ADDRESS SWITCH	This five position switch is used to establish the printer's system address. Refer to the discussion of this switch on page nine. This switch is located on the back of printers configured for HP-IB operation.
PARITY ERROR INDICATOR	When lit, this LED indicates that a parity error has been detected. This indicator is located on the back of printers configured for HP-IB operation.
ADDRESSED INDICATOR	When lit, this LED indicates that the printer has been addressed by a controlling device. It is located on the back of printers configured for HP-IB operation.



### NOTE

**A run time meter, to be used by HP Service Representatives, is installed in the ribbon cartridge bracket. This meter is visible when the ribbon cartridge is removed.**

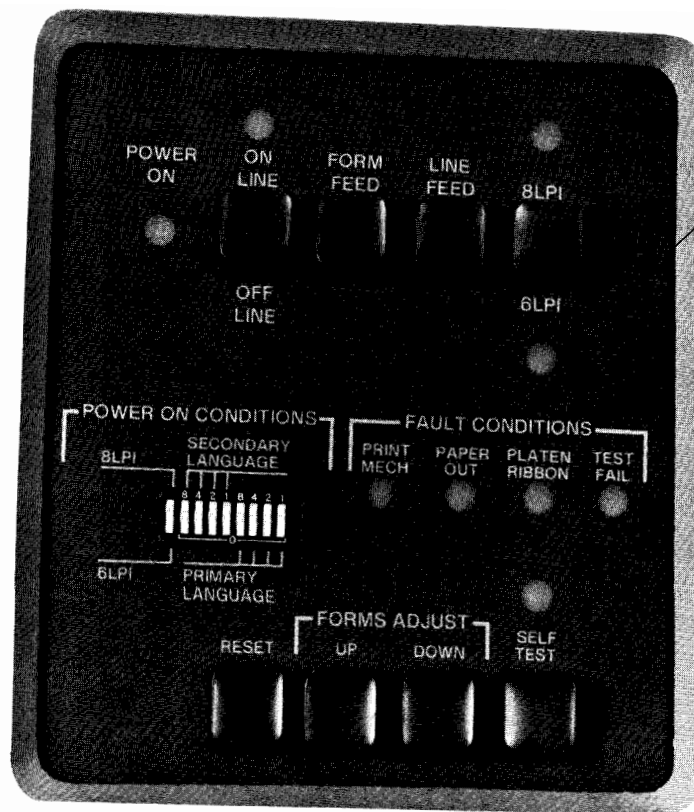

Operator Control Panel

Top Of Form Indicator

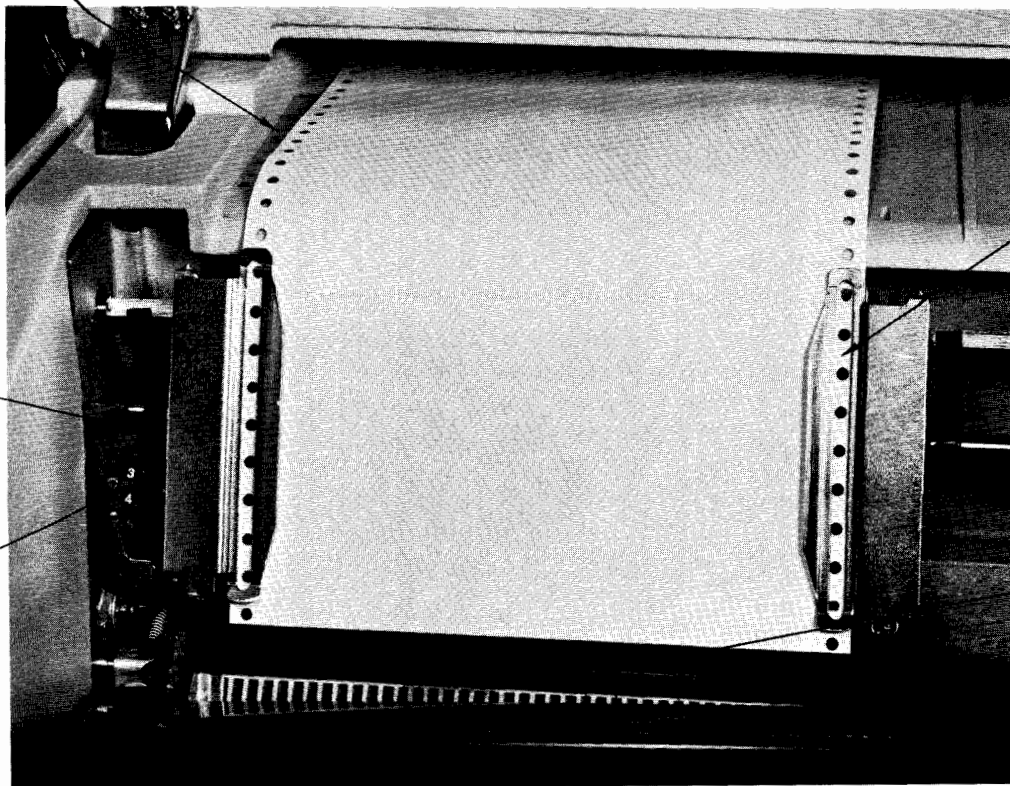

Paper Tractor

Tractor Clamp

Horizontal Scale

Platen Release Lever

Platen Adjust Knob

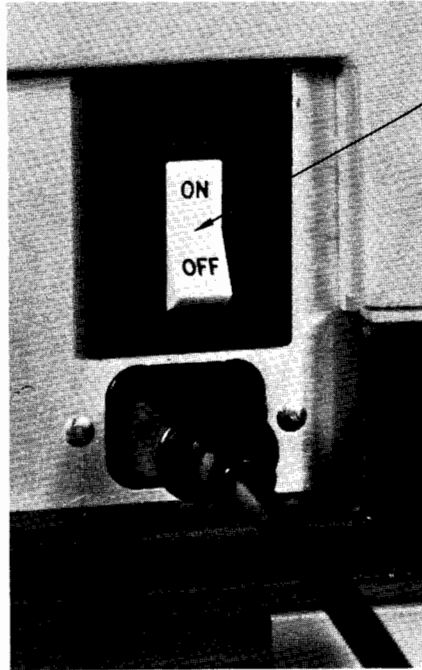

Main Power Switch

Device Address Switch

Addressed Indicator

Parity Error Indicator



## POWER ON AND RESET

When the main power switch (*back of printer*) is closed or the RESET switch (*control panel*) is pressed, the printer is set to a known state as follows:

- Off-line
- Primary and secondary character sets selected as specified by the control panel power-on conditions switch.
- Line spacing as established by the power-on conditions switch.
- Top Of Form (*logical*) at present paper position.
- *Standard print mode selected.*
- Print buffer cleared.
- Standard VFC channel assignments selected.
- Left margin offset equals zero.

All commands previously directed via program control from a computer or other controlling device are cleared.

### NOTE

**Paper adjustment may be required after a Power On or Reset has occurred. Refer to Paper Loading and Adjustment on page 12 of this manual.**

## ON-LINE / OFF-LINE

When the printer is on-line, data and commands can be transmitted to it from a controlling device. When it is off-line, data and commands will be ignored by the printer with the exception of the On-Line, Device Specified Jump (HP-IB only), and Status Read commands.

Off-Line is a state of the printer resulting from power-on reset, a fault condition or conditions (*paper out, platen open, etc.*), an off-line command from a controlling device, or from use of the ON/OFF LINE switch on the control panel.

When the printer is off-line, it may be returned to on-line status by either a command from a controlling device if no fault conditions exist, or by the operator with the control panel switch.

### NOTE

**When the RESET switch is used to take the printer off-line, all printer configurations previously established are cleared.**

## PRINT MODE SELECTION

Print mode selection for the HP 2608A is made via command codes. The three print modes are: Standard Alphanumeric Mode, Double Size Character Mode, and Graphics Mode.

Transmitted print mode commands will override the default mode (*standard alphanumerics*) and when taken off-line or put on-line, the printer remains in the last mode commanded; however the printer will default to the Standard Mode for power-on, reset, and upon receipt of the Master Clear or Device Clear (HP-IB only) commands.

## CHARACTER SET SELECTION

The character set in the standard HP 2608A is a 128 USASCII character set. The printer may contain up to 16 sets including a Draw character set. Your printer contains the sets which were specified in your purchase order.



The following table contains the binary code information that is used to set the default character sets via the control panel rocker switch. To set the switch, enter the code by moving the switch to either the "zero" position (*lower end depressed*) or to the "one" position (*upper end depressed*).

**CHARACTER SET ASSIGNMENTS**

LANGUAGE	BINARY CODE
<b>STANDARD</b>	
USASCII	0000
<b>OPTION 001</b>	
Arabic	0001
Cyrillic	0010
Katakana	0011
Draw	0100*
<b>OPTION 002</b>	
APL	0111
French	1000
German	1001
Swedish/Finnish	1010
Danish/Norwegian	1011
Spanish	1100
British	1101
Japanese ASCII	1110
Roman Extension Set	1111



\*The HP 2608A should be operated at 8 LPI when using the Draw character set so that characters will connect in the vertical position.

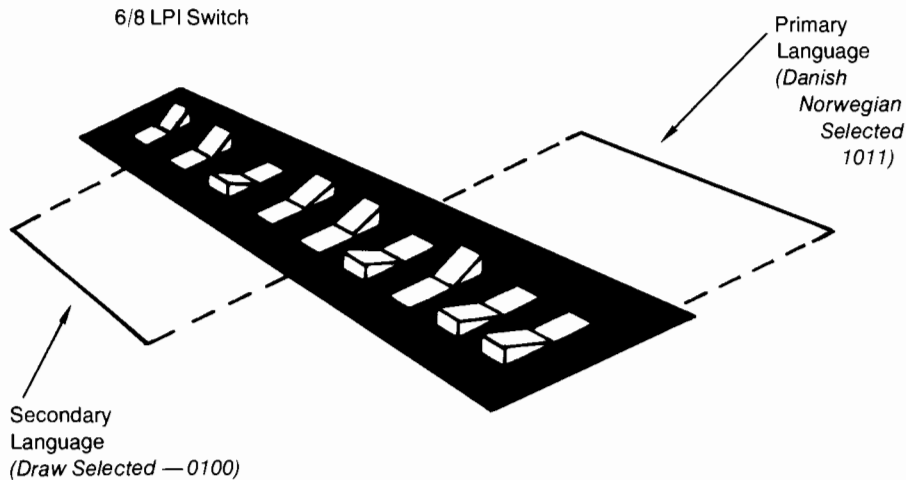

The codes in the above table may also be commanded remotely if character set selection or change is to be performed under program control. Character set selection commands will override the control panel setting; and when taken off-line, the printer remains in the set last commanded. However, the printer will default to the control panel setting for power-on, reset, or upon receipt of the Master Clear or Device Clear (HP-IB only) commands.

Any two sets may be in use within a print line — one designated as primary (*eighth bit = 0*), and the other designated as secondary (*eighth bit = 1*).

Standard ASCII shift-in and shift-out codes may also be used to select primary and secondary languages. Shift-out invokes the secondary language and shift-in returns the printer to the primary set. Shift-out is not cleared by the print command.

To create special symbols and underline selected portions of your output, the HP 2608A has been given the capability of overprinting one character with another on both a character-by-character and a line-by-line basis.

A single character overstrike is accomplished by using the backspace control code; however if more than one character is to be overstruck, a print with zero lines of slew (*no line feed*) may be used. The overstrike print line will be held in the print buffer and will be merged with the next line to form a single printed line with superimposed characters.

#### NOTE

**More than one consecutive backspace code is interpreted by the printer as a single backspace and more than one "zero line slew" print command is inter-**

**preted as a single command. Therefore, data integrity may be lost if consecutive backspaces or zero line slew commands are used.**

## CHARACTER OVERSTRIKE AND UNDERLINING

## VERTICAL LINE SPACING

Vertical line spacing may be manually selected at either 6 or 8 lines per vertical inch using the 6/8 LPI momentary switch on the operator control panel. The LED indicator shows which spacing has been selected. Refer to the 6/8 LPI switch discussion on page 19.

Vertical line spacing for power-on and reset conditions is established by the rocker switch also located on the control panel.

Additionally, vertical line spacing may be established via program control at either 6 or 8 LPI. Remotely transmitted line spacing commands will override control panel settings except under power-on or reset conditions. Selecting 6/8 LPI spacing from the front panel also resets the VFC to power-on status.

## FAULT CONDITIONS

Four LED indicators located on the operator control panel are provided to help you locate and possibly correct problems which prevent normal operations of the printer. When any fault condition exists, the printer automatically goes off-line and cannot be put on-line again until the fault is corrected.

#### TEST FAIL Indicator

When a segment of the self test routine fails, this indicator will light. Refer to Self Test on page 15 of the manual for a detailed description of how to determine the problem area.

**PRINT MECH Fault Indicator**

When lit, this indicator shows that a problem exists in the print mechanism which restricts or hinders movement. Check for possible obstructions which may prevent core bar motion. The printer must be reset to clear the indication. However, if the problem remains uncorrected, the indicator will again light. If you cannot correct the problem and clear the indicator, contact your HP Service Representative. Remember — when the printer is reset, it is returned to power-on status.

**PAPER OUT Fault Indicator**

When lit, this indicator shows the printer is out of paper. Paper out is detected by the absence of paper in two print columns (*15 and 115*). When paper out is detected, the printer goes off-line until paper is reloaded. No data is lost when paper out occurs. Refer to Paper Loading and Adjustment on page 12 of this manual for paper loading instructions.

**RIBBON/PLATEN Fault Indicator**

When lit, this indicator shows that either a ribbon cartridge has not been loaded, the platen is open (release handle has not been returned to the vertical position), or that a paper jam has been detected. Refer to Ribbon Cartridge Loading and Removal on page 10 for instructions to correct this fault.

If a power failure occurs, a possible loss of data will result. When power is returned the printer will be off-line and in power-on status. Power Failure will require resetting of program control and control panel configurations previously established.

**POWER  
FAILURE**

# Section V.

## Operator Maintenance

### PREVENTIVE MAINTENANCE

Maintain the printer in a state of general cleanliness. Accumulated dust, bits of paper, and lint can lead to serious problems.

Watch for indications of physical damage and report problems or potential problems to service personnel.

The air filter on the cooling fan intake, which is located on left hand side of the printer, should be vacuumed at least once a week. Because cooling air is supplied through grillwork in the printer stand, keep the grillwork free of dust and lint. Do not allow dust and lint to accumulate under the stand.

### IN CASE OF DIFFICULTY

You should not attempt to perform any maintenance of this printer except routine operator maintenance and limited maintenance of the print mechanism. However, if the printer fails to function properly, review the following Trouble-Cause chart for a possible solution before asking for service.

Trouble	Cause
POWER-ON INDICATOR DOES NOT LIGHT	Power cord is not plugged in. Current is not coming from power outlet. Circuit breaker has tripped. <i>(Refer to Power on page 8 of this manual.)</i>
PAPER DOES NOT ADVANCE.	Paper is not properly loaded. Check tractors, paper alignment and platen gap setting. Holes in paper are damaged. Paper is caught in box. Paper folds do not match horizontal perforations. Check paper and remove damaged sheets. Reload paper <i>(see Paper Loading on page 12 of this manual)</i> .
PAPER TEARING OR SEPARATING ON MULTI-PART FORMS.	Tension on paper is not correct. Check platen gap setting and tractors. Check paper for binding or dragging. Reload if necessary.
PRINT QUALITY BECOMES ERRATIC, VERY LIGHT, OR SMUDGED.	Adjust platen gap. Replace Ribbon cartridge <i>(see Ribbon Cartridge Loading and Removal on page 10 of this manual)</i> .

# Section VI.

## Command Code Summary

When the printer is off-line, all command codes except DSJ (HP-IB only), STATUS READ, and ON/OFF-LINE (except when a fault condition exists) are ignored.

The following tables summarize the command codes which are recognized by the HP 2608A. Detailed programming information is contained in the HP 2608A Technical Reference Manual (*HP Part No. 02608-90903*).

# HP-IB COMMAND SUMMARY



## DATA COMMAND (Listen)

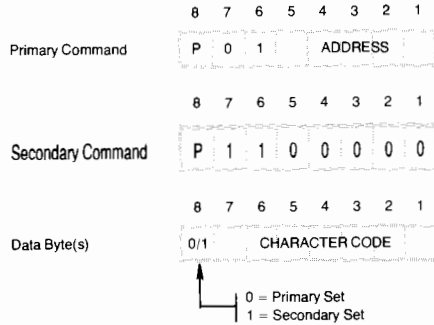

## CHARACTER SET CHANGE COMMAND (Listen)

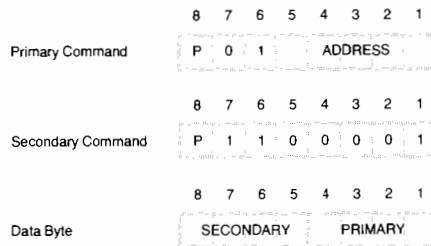

## VFC SET/RESET COMMAND (Listen)

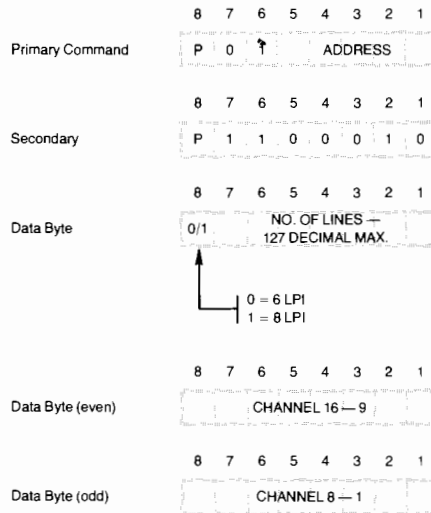

## ON/OFF-LINE COMMAND (Listen)

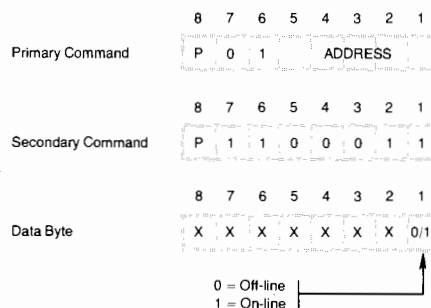

P = Parity  
X = Don't Care

## SELF TEST COMMAND (Listen)

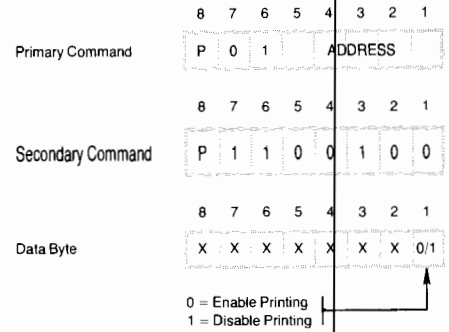

## MASTER CLEAR COMMAND (Listen)

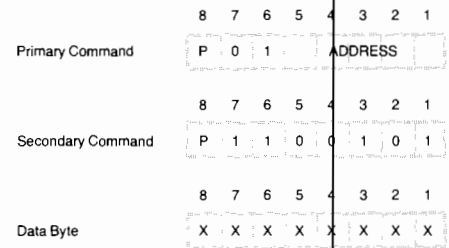

## LEFT MARGIN COMMAND (Listen)

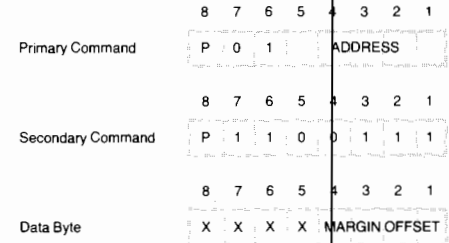

## PRINT COMMAND (Listen)

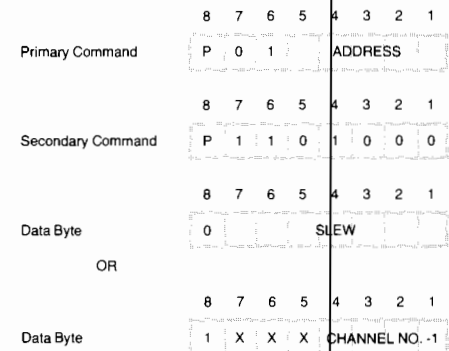

## HP-IB COMMAND SUMMARY (CONTINUED)

### STATUS READ COMMAND (Listen)

Primary Command

8	7	6	5	4	3	2	1	
P	0	1	ADDRESS					

Secondary Command

8	7	6	5	4	3	2	1
P	1	1	0	1	0	1	0

Data Byte

8	7	6	5	4	3	2	1
0	NO. STATUS BYTES						

OR

Data Byte

8	7	6	5	4	3	2	1
1	X	X	X	LANGUAGE CODE			

(Talk)

Primary Command

8	7	6	5	4	3	2	1	
P	1	0	ADDRESS					

Secondary Command

8	7	6	5	4	3	2	1
P	1	1	0	1	0	1	0

### PRINT MODE COMMAND (Listen)

Primary Command

8	7	6	5	4	3	2	1	
P	0	1	ADDRESS					

Secondary Command

8	7	6	5	4	3	2	1
P	1	1	0	1	0	1	1

Data Byte

8	7	6	5	4	3	2	1
X	X	X	0:1	MODE			

0000 = Standard  
0001 = Double Size  
0010 = Graphics

0 = Transparency Disable  
1 = Transparency Enable

### DEVICE CLEAR COMMAND (Listen)

Primary Command

8	7	6	5	4	3	2	1	
P	0	1	ADDRESS					

Secondary Command

8	7	6	5	4	3	2	1
P	1	1	1	0	0	0	0

Data Byte

8	7	6	5	4	3	2	1
X	X	X	X	X	X	X	X

### DEVICE SPECIFIED JUMP COMMAND (Talk)

Primary Command

8	7	6	5	4	3	2	1	
P	1	0	ADDRESS					

Secondary Command

8	7	6	5	4	3	2	1
P	1	1	1	0	0	0	0

### PING COMMAND (Listen)

Primary Command

8	7	6	5	4	3	2	1	
P	0	1	ADDRESS					

Secondary Command

8	7	6	5	4	3	2	1
P	1	1	1	1	1	1	0

Data Byte

8	7	6	5	4	3	2	1
256 TEST DATA BYTES							

### PONG COMMAND (Talk)

Primary Command

8	7	6	5	4	3	2	1	
P	1	0	ADDRESS					

Secondary Command

8	7	6	5	4	3	2	1
P	1	1	1	1	1	1	0

### INITIATE SELF TEST COMMAND (Listen)

Primary Command

8	7	6	5	4	3	2	1	
P	0	1	ADDRESS					

Secondary Command

8	7	6	5	4	3	2	1
P	1	1	1	1	1	1	1

Data Byte

8	7	6	5	4	3	2	1
X	X	X	X	X	X	X	0/1

0 = Enable Printing  
1 = Disable Printing

### READ SELF TEST COMMAND (Talk)

Primary Command

8	7	6	5	4	3	2	1	
P	1	0	ADDRESS					

Secondary Command

8	7	6	5	4	3	2	1
P	1	1	1	1	1	1	1

P = Parity  
X = Don't Care

# APPENDIX A. ASCII TABLES

				← 000-037B →		← 040-077B →		← 100-137B →		← 140-177B →		
b <sub>7</sub> b <sub>6</sub> b <sub>5</sub>				0 <sub>00</sub>	0 <sub>01</sub>	0 <sub>10</sub>	0 <sub>11</sub>	1 <sub>00</sub>	1 <sub>01</sub>	1 <sub>10</sub>	1 <sub>11</sub>	
BITS				COLUMN								
b <sub>4</sub> b <sub>3</sub> b <sub>2</sub> b <sub>1</sub>				0	1	2	3	4	5	6	7	
ROW				↓								
0	0	0	0	0	NUL	DLE	SP	0	@	P	\	p
0	0	0	1	1	SOH	DC1	!	1	A	Q	a	q
0	0	1	0	2	STX	DC2	"	2	B	R	b	r
0	0	1	1	3	ETX	DC3	#	3	C	S	c	s
0	1	0	0	4	EOT	DC4	\$	4	D	T	d	t
0	1	0	1	5	ENQ	NAK	%	5	E	U	e	u
0	1	1	0	6	ACK	SYN	&	6	F	V	f	v
0	1	1	1	7	BEL	ETB	'	7	G	W	g	w
1	0	0	0	8	BS	CAN	(	8	H	X	h	x
1	0	0	1	9	HT	EM	)	9	I	Y	i	y
1	0	1	0	10	LF	SUB	*	:	J	Z	j	z
1	0	1	1	11	VT	ESC	+	;	K	[	k	{
1	1	0	0	12	FF	FS	,	<	L	\	l	
1	1	0	1	13	CR	GS	-	=	M	]	m	}
1	1	1	0	14	SO	RS	.	>	N	^	n	~
1	1	1	1	15	SI	US	/	?	O	_	o	DEL

32 CONTROL  
CODES

Example: The representation for the character "K" (column 4, row 11) is.

	b <sub>7</sub>	b <sub>6</sub>	b <sub>5</sub>	b <sub>4</sub>	b <sub>3</sub>	b <sub>2</sub>	b <sub>1</sub>
BINARY	1	0	0	1	0	1	1
OCTAL	1	1		3			



## HP 2608A USASCII CHARACTER SET

The left and right byte columns show the octal patterns in a 16 bit word when the character occupies bits 8 to 14 (left byte) or 0 to 6 (right byte) and the rest of the bits are zero. To find the pattern of two characters in the same word, add the two values. For example, "AB" produces the octal pattern 040502. (The parity bits are zero in this chart.)

The octal values 0 through 37 and 177 are control codes. The octal values 40 through 176 are character codes.

Decimal Value	Octal Values		Mnemonic	Graphic	Meaning	Octal Values		Character	Meaning
	Left Byte	Right Byte				Left Byte	Right Byte		
0	000000	000000	NUL	N <sub>0</sub>	Null	020000	000040		Space, Blank
1	000400	000001	SOH	S <sub>1</sub>	Start of Heading	020400	000041	!	Exclamation Point
2	001000	000002	STX	S <sub>2</sub>	Start of Text	021000	000042	"	Quotation Mark
3	001400	000003	ETX	E <sub>3</sub>	End of Text	021400	000043	#	Number Sign, Pound Sign
4	002000	000004	EOT	E <sub>4</sub>	End of Transmission	022000	000044	\$	Dollar Sign
5	002400	000005	ENQ	E <sub>5</sub>	Enquiry	022400	000045	%	Percent
6	003000	000006	ACK	A <sub>6</sub>	Acknowledge	023000	000046	&	Amperсанд, And Sign
7	003400	000007	BEL	B <sub>7</sub>	Bell, Attention Signal	023400	000047	'	Apostrophe, Acute Accent
8	004000	000010	BS	B <sub>8</sub>	Backspace (1)	024000	000050	(	Left (opening) Parenthesis
9	004400	000011	HT	H <sub>9</sub>	Horizontal Tabulation	024400	000051	)	Right (closing) Parenthesis
10	005000	000012	LF	L <sub>10</sub>	Line Feed (2)	025000	000052	*	Asterisk, Star
11	005400	000013	VT	V <sub>11</sub>	Vertical Tabulation	025400	000053	+	Plus
12	006000	000014	FF	F <sub>12</sub>	Form Feed (2)	026000	000054	,	Comma, Cedilla
13	006400	000015	CR	C <sub>13</sub>	Carriage Return (2)	026400	000055	-	Hyphen, Minus, Dash
14	007000	000016	SO	S <sub>14</sub>	Shift Out (1) Alternate	027000	000056	.	Period, Decimal Point
15	007400	000017	SI	S <sub>15</sub>	Shift In (1) Character Set	027400	000057	/	Slash, Slant
16	010000	000020	DLE	D <sub>16</sub>	Data Link Escape	030000	000060	0	Digits, Numbers
17	010400	000021	DC1	D <sub>17</sub>	Device Control 1	030400	000061	1	
18	011000	000022	DC2	D <sub>18</sub>	Device Control 2	031000	000062	2	
19	011400	000023	DC3	D <sub>19</sub>	Device Control 3	031400	000063	3	
20	012000	000024	DC4	D <sub>20</sub>	Device Control 4	032000	000064	4	
21	012400	000025	NAK	N <sub>21</sub>	Negative Acknowledge	032400	000065	5	
22	013000	000026	SYN	S <sub>22</sub>	Synchronous Idle	033000	000066	6	
23	013400	000027	ETB	E <sub>23</sub>	End of Transmission Block	033400	000067	7	
24	014000	000030	CAN	C <sub>24</sub>	Cancel	034000	000070	8	
25	014400	000031	EM	E <sub>25</sub>	End of Medium	034400	000071	9	
26	015000	000032	SUB	S <sub>26</sub>	Substitute	035000	000072	:	Colon
27	015400	000033	ESC	E <sub>27</sub>	Escape	035400	000073	;	Semicolon
28	016000	000034	FS	F <sub>28</sub>	File Separator	036000	000074	<	Less Than
29	016400	000035	GS	G <sub>29</sub>	Group Separator	036400	000075	=	Equals
30	017000	000036	RS	R <sub>30</sub>	Record Separator	037000	000076	>	Greater Than
31	017400	000037	US	U <sub>31</sub>	Unit Separator	037400	000077	?	Question Mark
127	077400	000177	DEL	■	Delete				

## HP 2608A USASCII CHARACTER SET (CONTINUED)

Decimal Value	Octal Values		Character	Meaning
	Left Byte	Right Byte		
64	040000	000100	@	Commercial At
65	040400	000101	A	Upper Case Alphabet. Capital Letters
66	041000	000102	B	
67	041400	000103	C	
68	042000	000104	D	
69	042400	000105	E	
70	043000	000106	F	
71	043400	000107	G	
72	044000	000110	H	
73	044400	000111	I	
74	045000	000112	J	
75	045400	000113	K	
76	046000	000114	L	
77	046400	000115	M	
78	047000	000116	N	
79	047400	000117	O	
80	050000	000120	P	
81	050400	000121	Q	
82	051000	000122	R	
83	051400	000123	S	
84	052000	000124	T	
85	052400	000125	U	
86	053000	000126	V	
87	053400	000127	W	
88	054000	000130	X	
89	054400	000131	Y	
90	055000	000132	Z	
91	055400	000133	[	Left (opening) Bracket
92	056000	000134	\	Backslash, Reverse Slant
93	056400	000135	]	Right (closing) Bracket
94	057000	000136	^	Caret
95	057400	000137	_	Underscore

Decimal Value	Octal Values		Character	Meaning
	Left Byte	Right Byte		
96	060000	000140	`	Lower Case Letters
97	060400	000141	a	
98	061000	000142	b	
99	061400	000143	c	
100	062000	000144	d	
101	062400	000145	e	
102	063000	000146	f	
103	063400	000147	g	
104	064000	000150	h	
105	064400	000151	i	
106	065000	000152	j	
107	065400	000153	k	
108	066000	000154	l	
109	066400	000155	m	
110	067000	000156	n	
111	067400	000157	o	
112	070000	000160	p	
113	070400	000161	q	
114	071000	000162	r	
115	071400	000163	s	
116	072000	000164	t	
117	072400	000165	u	
118	073000	000166	v	
119	073400	000167	w	
120	074000	000170	x	
121	074400	000171	y	
122	075000	000172	z	
123	075400	000173	{	Left (opening) Brace
124	076000	000174		Vertical Line
125	076400	000175	}	Right (closing) Brace
126	077000	000176	~	Tilde, Overline

**Notes:** 1. Executed by the HP 2608A. All other control codes are printed.

2. May be executed with HP-IB (option 046) when optionally configured.



## Product Line Sales/Support Key

## Key Product Line

- A Analytical  
 CM Components  
 C Computer Systems Sales only  
 CH Computer Systems Hardware Sales & Services  
 CS Computer Systems Software Sales & Services  
 E Electronic Instruments & Measurement Systems  
 M Medical Products  
 MP Medical Products Primary SRO  
 MS Medical Products Secondary SRO  
 P Personal Computing Products  
 \* Sales only for specific product line  
 \*\* Support only for specific product line

**IMPORTANT:** These symbols designate general product line capability. They do not insure sales or support availability for all products within a line, at all locations. Contact your local sales office for information regarding locations where HP support is available for specific products.

*HP distributors are printed in italics.*

**ANGOLA**

*Telectra*  
*Empresa Técnica de Equipamentos*  
*Eléctricos, S.A.R.L.*  
*R. Barbosa Rodrigues, 41-1 DT.*  
*Caixa Postal 6487*  
**LUANDA**  
 Tel: 35515,35516  
 E,M,P

**ARGENTINA**

Hewlett-Packard Argentina S.A.  
 Avenida Santa Fe 2035  
 Martínez 1640 BUENOS AIRES  
 Tel: 798-5735, 792-1293  
 Telex: 122443 AR CIGY  
 Cable: HEWPACARG  
 A,E,CH,CS,P  
*Bioron S.A.C.I.y.M*  
*Av Paseo Colon 221, 9 Piso*  
*1399 BUENOS AIRES*  
 Tel: 30-4846, 30-1851, 30-8384  
 Telex: 17595 BION/AR  
 M  
*Fale S.A. I.C.I./Electronica*  
*Venezuela 1326*  
*1095 BUENOS AIRES*  
 Tel: 379026, 379027  
 Telex: 18137, 22754 ALVAR AR  
 P

**AUSTRALIA****Adelaide, South Australia Office**

Hewlett-Packard Australia Pty.Ltd.  
 153 Greenhill Road  
 PARKSIDE, S.A. 5063  
 Tel: 272-5911  
 Telex: 82536  
 Cable: HEWPARD Adelaide  
 A\*,CH,CM,E,MS,P

**Brisbane, Queensland Office**

Hewlett-Packard Australia Pty.Ltd.  
 5th Floor  
 Teachers Union Building  
 495-499 Boundary Street  
 SPRING HILL, Queensland 4000  
 Tel: 229-1544  
 Telex: 42133  
 Cable: HEWPARD Brisbane  
 A,CH,CM,E,MS,P

**Canberra, Australia Capital Territory Office**

Hewlett-Packard Australia Pty.Ltd.  
 121 Wollongong Street  
 Fyshwick, A.C.T. 2609  
 Tel: 80 4244 Telex: 62650  
 Cable: HEWPARD Canberra  
 A\*CH,CM,E,MS,P

**Melbourne, Victoria Office**

Hewlett-Packard Australia Pty.Ltd.  
 31-41 Joseph Street  
 BLACKBURN, Victoria 3130  
 Tel: 89-6351  
 Telex: 31-024  
 Cable: HEWPARD Melbourne  
 A,CH,CM,CS,E,MS,P

**Perth, Western Australia Office**

Hewlett-Packard Australia Pty.Ltd.  
 141 Stirling Highway  
 NEDLANDS, W.A. 6009  
 (effective 28 Sept. 1981:  
 261 Stirling Highway  
 CLAREMONT, W.A. 6010)  
 Tel: 386-5455  
 Telex: 93859  
 Cable: HEWPARD Perth  
 A,CH,CM,E,MS,P

**Sydney, New South Wales Office**

Hewlett-Packard Australia Pty.Ltd.  
 17-23 Talavera Road  
 P.O. Box 308  
 NORTH RYDE, N.S.W. 2113  
 Tel: 887-1611  
 Telex: 21561  
 Cable: HEWPARD Sydney  
 A,CH,CM,CS,E,MS,P

**AUSTRIA**

Hewlett-Packard Ges.m.b.H.  
 Grottenhofstrasse 94  
 Verkaufsburo Graz  
 A-8052 GRAZ  
 Tel: 21-5-66  
 Telex: 32375  
 CH,CM,E\*

Hewlett-Packard Ges.m.b.H.  
 Wehlstrasse 29  
 P.O. Box 7  
 A-1205 VIENNA  
 Tel: (222) 35-16-210  
 Telex: 135823/135066  
 A,CH,CM,CS,E,MS,P

**BAHRAIN**

*Green Salon*  
*P.O. Box 557*  
**BAHRAIN**  
 Tel: 25503-250950  
 Telex: 84419  
 P

*Wael Pharmacy*  
*P.O. Box 648*

**BAHRAIN**  
 Tel: 256123  
 Telex: 8550 WAEL GJ  
 M

**BELGIUM**

Hewlett-Packard Belgium S.A./N.V.  
 Blvd de la Woluwe, 100  
 Woluwedal  
 B-1200 BRUSSELS  
 Tel: (02) 762-32-00  
 Telex: 23-494 paloben bru  
 A,CH,CM,CS,E,MP,P

**BRAZIL**

Hewlett-Packard do Brasil I.e.C.  
 Ltda.  
 Alameda Rio Negro, 750  
 ALPHAVILLE 06400 Barueri SP  
 Tel: 421-1311  
 Telex: 011 33872  
 Cable: HEWPACK Sao Paulo  
 A,CH,CM,CS,E,MS  
 Hewlett-Packard do Brasil I.e.C.  
 Ltda.  
 Avenida Epitacio Pessoa, 4664  
 22471 RIO DE JANEIRO-RJ  
 Tel: 286-0237  
 Telex: 021-2 1905 HPBR-BR  
 Cable: HEWPACK Rio de Janeiro  
 A,CH,CM,E,MS,P\*

**CANADA**

**Alberta**  
 Hewlett-Packard (Canada) Ltd.  
 210, 7220 Fisher Street S.E.  
 CALGARY, Alberta T2H 2H8  
 Tel: (403) 253-2713  
 A,CH,CM,E\*,MS,P\*

Hewlett-Packard (Canada) Ltd.  
 11620A-168th Street  
 EDMONTON, Alberta T5M 3T9  
 Tel: (403) 452-3670  
 A,CH,CM,CS,E,MS,P\*

**British Columbia**  
 Hewlett-Packard (Canada) Ltd.  
 10691 Shellbridge Way  
 RICHMOND, British Columbia V6X  
 2W7  
 Tel: (604) 270-2277  
 Telex: 610-922-5059  
 A,CH,CM,CS,E\*,MS,P\*

**Manitoba**  
 Hewlett-Packard (Canada) Ltd.  
 380-550 Century Street  
 WINNIPEG, Manitoba R3H 0Y1  
 Tel: (204) 786-6701  
 A,CH,CM,E,MS,P\*

**New Brunswick**

Hewlett-Packard (Canada) Ltd.  
 190 Wilbur Street  
 MONCTON, New Brunswick E2B 2V0  
 Tel: (506) 386-1677  
 Telex: 01931470  
 CH\*\*

**Nova Scotia**

Hewlett-Packard (Canada) Ltd.  
 P.O. Box 931  
 900 Windmill Road  
 DARTMOUTH, Nova Scotia B2Y 3Z6  
 Tel: (902) 469-7820  
 Telex: 01931470  
 CH,CM,CS,E\*,MS,P\*

**Ontario**

Hewlett-Packard (Canada) Ltd.  
 552 Newbold Street  
 LONDON, Ontario N6E 2S5  
 Tel: (519) 686-9181  
 Telex: 610-352-1201  
 A,CH,CM,E\*,MS,P\*

Hewlett-Packard (Canada) Ltd.  
 6877 Goreway Drive  
 MISSISSAUGA, Ontario L4V 1M8  
 Tel: (416) 678-9430  
 Telex: 610-492-4246  
 A,CH,CM,CS,E,MP,P  
 Hewlett-Packard (Canada) Ltd.  
 2670 Queensview Dr.  
 OTTAWA, Ontario K2B 8K1  
 Tel: (613) 820-6483  
 Telex: 610-563-1636  
 A,CH,CM,CS,E\*,MS,P\*

**Quebec**

Hewlett-Packard (Canada) Ltd.  
 17500 South Service Road  
 Trans-Canada Highway  
 KIRKLAND, Quebec H9J 2M5  
 Tel: (514) 697-4232  
 Telex: 05821521  
 A,CH,CM,CS,E,MP,P\*  
 Hewlett-Packard (Canada) Ltd.  
 Les Galeries du Vallon  
 2323 Boulevard du Versant Nord  
 STE. FOY, Quebec G1N 4C2  
 Tel: (418) 687-4570  
 CH

**CHILE**

*Jorge Calcagni y Cia. Ltda.*  
*Arturo Burhle 065*  
*Casilla 16475*  
**SANTIAGO 9**  
 Tel: 222-0222  
 Telex: Public Booth 0001  
 A,CM,E,M  
*Olympia (Chile) Ltd.*  
*Rodrico de Araya 1045*  
*Casilla 256-V*  
**SANTIAGO 21**  
 Tel: 225-5044  
 Telex: 40565 OLYMP CL  
 C,P

**CHINA, People's Republic of**

*CEIEC Inc.*  
*44 Beimei Rd.*  
**BEIJING, China**  
 Telex: 22475 CEIEC CN  
 A,CH,CM,CS,E,P

**COLOMBIA**

*Instrumentación*  
*H. A. Langebaek & Kier S.A.*  
*Apartado Aéreo 6287*  
**BOGOTÁ 1, D.E.**  
*Carrera 7 No. 48-75*  
**BOGOTÁ, 2 D.E.**  
 Tel: 287-8877  
 Telex: 44400  
 Cable: AARIS Bogota  
 A,CM,E,M,P

**COSTA RICA**

*Cientifica Costarricense S.A.*  
*Avenida 2, Calle 5*  
*San Pedro de Montes de Oca*  
*Apartado 10159*  
**SAN JOSE**  
 Tel: 24-38-20, 24-08-19  
 Telex: 2367 GALGUR  
 CM,E,M

**CYPRUS**

*Telexera Ltd.*  
*P.O. Box 4809*  
*14C Stassinou Avenue*  
**NICOSIA**  
 Tel: 62698  
 Telex: 2894 Leviodoy  
 E,M,P

**CZECHOSLOVAKIA**

*Hewlett-Packard*  
*Obchodni Zastupitelstvi v CSSR*  
*Post. schranka 27*  
*CS-118 01 PRAHA 011*  
 Tel: 66-296  
 Telex: 121353 IHC

**DENMARK**

Hewlett-Packard A/S  
 Datavej 52  
 DK-3460 BIRKEROD  
 Tel: (02) 81-66-40  
 Telex: 37409 hpas dk  
 A,CH,CM,CS,E,MS,P  
 Hewlett-Packard A/S  
 Navervej 1  
 DK-8600 SILKEBORG  
 Tel: (06) 82-71-66  
 Telex: 37409 hpas dk  
 CH,CM,E

**ECUADOR**

*CYEDE Cia. Ltda.*  
*Avenida Eloy Alfaro 1749*  
*Casilla 6423 CCI*  
**QUITO**  
 Tel: 450-975, 243-052  
 Telex: 2548 CYEDE ED  
 A,CM,E,P

*Hospitalar S.A.*

*Robles 625*  
*Casilla 3590*  
**QUITO**  
 Tel: 545-250, 545-122  
 Telex: 2485 HOSPTL ED  
 Cable: HOSPITALAR-Quito  
 M

**EGYPT**

*International Engineering Associates*  
*24 Hussein Hegazi Street*  
*Kasr-el-Aini*  
**CAIRO**  
 Tel: 23-829  
 Telex: 93830  
 CH,CS,E,M  
*Informatic For Systems*  
*22 Talaat Harb Street*  
**CAIRO**  
 Tel: 759006  
 Telex: 93938 FRANK UN  
 CH,CS,P  
*Egyptian International Office*  
*for Foreign Trade*  
*P.O.Box 2558*  
**CAIRO**  
 Tel: 984935  
 Telex: 93337 EGPOR  
 P

**EL SALVADOR**

*IPESA de El Salvador S.A.*  
*Boulevard de los Heroes 1148*  
**SAN SALVADOR**  
 Tel: 252787, 259621  
 Telex: Public Booth 20107  
 A,CH,CM,CS,E,P

**FINLAND**

Hewlett-Packard Oy  
 Revontulientie 7  
 SF-02100 ESPOO 10  
 Tel: (90) 455-0211  
 Telex: 121563 hewpa sf  
 A,CH,CM,CS,E,MS,P

