

HEWLETT  PACKARD

2100 series computers



HP 2607
line printer
diagnostic

Binary tape 24340-16001
Series 1446

HP Computer Museum
www.hpmuseum.net

For research and education purposes only.

HP 2607 Line Printer Diagnostic

The HP 2607 Line Printer Diagnostic confirms proper output functions of the HP 2607A Line Printer. It is one of the HP 2100 series computer system diagnostics executed in conjunction with the diagnostic configurator. Test sequence and test failure reporting to the operator is provided through a console device (if available), through the computer memory data register (MDR or T), and through the computer A-register. Operator input is required via the computer switch register for test options and via the A-register for individual test selection.

This diagnostic program consists of a sequence of tests which exercise the line printer functions. First the I/O channel functions of the line printer are tested. Then, all characteristics of the printing mechanism are tested, including operation with direct memory access (DMA) if available.

LIMITATIONS

This diagnostic verifies operability of the line printer with some limitations.

Four types of priority string conditions exist in the interface PCA (Printed Circuit Assembly):

1. Does the interface receive priority? The diagnostic tests for this condition.
2. Can the interface be denied priority? To test for this condition extract an unused higher priority interface PCA and then run this diagnostic.
3. Does the interface deliver priority? This condition can only be tested by running a diagnostic for a lower-priority interface PCA to some other device.
4. Can the interface deny priority? This condition is outside the scope of this diagnostic.

GENERAL ENVIRONMENT

The general hardware/software environments and system configuration procedures are described in the *HP 2100 Series Diagnostic Configurator* manual (02100-90157).

Hardware Requirement

1. The diagnostic is run on a 2100 series computer with a minimum of 4K of memory.
2. A paper tape reader is required to load the program. If a tape reader is available on the console device, it can be used.
3. An HP 2607A Line Printer with a 12845A-001 or 12845B interface is required.
4. The 6 line-per-inch standard VFU tape (HP part no. 1535-2655) is required.
5. A console device is optional.

Software Requirement

The required software consists of the following binary object tapes:

1. HP 2100 Series Diagnostic Configurator .
2. This diagnostic.

Loading is performed using the Binary Loader (usually memory resident). See the appropriate *Front Panel Procedures* for the 2100 Series Computer being used for use of the Binary Loader. The loader is described in the HP manual *Basic Binary Loader-Basic Binary Disc Loader-Basic Moving Head Disc Loader* (HP 5951-1376).

Operating Procedures

The Operating Procedures section is divided into four parts: Summary, Preparation for Diagnostic Run, Running the Diagnostic, and Diagnostic Messages and Halts.

SUMMARY

1. Load the diagnostic configurator using the BL.
2. Configure the diagnostic configurator. Refer to *HP 2100 Series Diagnostic Configurator* manual for procedures.
3. Load the diagnostic using the BL.
4. Set P-register to 100 octal (starting address).
5. Load switch register bits 0 thru 5 with the select code of the line printer to be tested and set bit 15 of the switch register = 0 if using a 12845A-001 interface or bit 15 = 1 if using a 12845B interface.
6. Press PRESET (INTERNAL and EXTERNAL).
7. Press RUN

Result: HALT

•MDR = 102073_8 if invalid SC; to correct, enter SC of 10_8 or greater, press RUN.

•MDR = 102074_8 if valid SC.

8. Load switch register with selected program options from Table 1.
9. Press RUN.

Note: If tests 0 or 1 are selected, follow the operator intervention commands output by teleprinter. Tests 2 through 7 operate automatically. Test 8 is Operator Design. Key in "BY" to exit Operator Design.

Result: HALT at completion of diagnostic;

•MDR = 102077_8 .

10. Press RUN to repeat diagnostic with same configuration and program options.

PREPARATION FOR DIAGNOSTIC RUN

Before the tests can be initiated, the user performs the following actions:

- Load the Diagnostic Configurator
- Configure to available system hardware
- Load the diagnostic
- Dump configured memory for later use (optional)
- Ready the line printer

Loading

Using the Binary Loader, load the HP 2100 Series Diagnostic Configurator. Perform the configuration procedure (see "Configuring" below) before loading the diagnostic. Then load the HP 2607 Line Printer Diagnostic, using the Binary Loader. The user may verify that the proper diagnostic is loaded by checking memory location 126_n for the Diagnostic Serial Number = 105102

Configuring

Procedures for inputting the system hardware configuration parameters are found in the *HP 2100 Series Diagnostic Configurator* manual (02100-90157) under "Configuring." At the back of the same manual is a PRODUCT APPLICABILITY sheet, which describes which computers are compatible with this diagnostic.

The configuration procedure accepts six groups of parameters. This diagnostic requires four groups to be defined.

They are

- Computer type and options
- Teleprinter as optional system Input B (Slow Input) device
- Teleprinter as optional system Output B (Slow Output) device
- Memory Size and Type

Enter zero or Teleprinter SC (Select Code) for the other two parameters.

Computer Type and Options and *Memory Size and Type* vary from one 2100 series installation to the other. The user must determine the parameters of his installation and configure accordingly.

A teleprinter is recommended for configuration as *System Input B Device* and *System Output B Device*. The teleprinter serves as the operator/diagnostic communicator. If no teleprinter is available,

configuration input is zero. The user must then rely on HALT codes and the switch register to monitor and control test sequence and determine the degree of test success.

If no teleprinter is available, the Operator Design, Test 8, cannot be run.



Dumping

Using procedures described in the Diagnostic Configurator manual, the user may dump memory onto paper tape so that the above configuration procedures need not be repeated. The dumped paper tape holding the configured diagnostic can thereafter be loaded via the Binary Loader.

Readying The Line Printer

Verify the proper installation of all cables. Release 8 LPI switch (i.e. set in OUT position) to select 6 lines-per-inch. Turn power on and press PRINT and FORM FEED.

RUNNING THE DIAGNOSTIC

Parameter Entry And Program Options

The switch register is first used to specify the select code of the 2607 line printer being tested. This is set up before execution is initiated. At the first HALT after execution is initiated, the switch register is set up to hold program options. If the test selection option, switch register bit 9, is set, another HALT occurs to allow the user to enter into the A-register his selection of tests to be executed.

Table 1 holds a summary of switch register options which are entered after the initial HALT.

If *switch register bit 8* is set, tests requiring operator intervention are not executed. These include: subtest 7 in test 0, Basic I/O; Test 1, Manual Control Test; and test 8, Operator Design.

If *switch register bit 9* is set prior to starting test execution or while running, the diagnostic will perform a HALT with $MDR = 102075_8$. The user then selects tests to be executed in the A-register. Refer to the first page of "Test Sections" for test selection numbers and names.

If *switch register bit 12* is set, the diagnostic will not HALT at the completion of all selected tests but will repeat the diagnostic from the beginning. All tests requiring operator intervention will be suppressed when diagnostic is repeated.

Table 1. Switch Register Options

BITS	FUNCTION IF SET
0	Reserved
1	Suppress character "H" in test 6.
2	Suppress character "I" in test 6.
3	Suppress character "#" in test 6.
4	Suppress character "." in test 6.
5	Reserved
6	Reserved
7	Reserved
8	Suppress tests requiring operator intervention.
9	Abort current run and HALT with MDR=102075; user sets bits of A-register with test selection where bit 0 set selects test 0, bit 1 set selects test 1, etc. To restart with selected tests, clear switch register bit 9 and press RUN.
10	Suppress printing of operator information messages (H-type; see table 3).
11	Suppress printing of error messages (E-type; see table 3).
12	Repeat all selected tests of the diagnostic except those requiring operator intervention.
13	Repeat the currently executing test (loop).
14	Suppress error halts (see table 2).
15	Halt at the end of each test with MDR=102076. The A-register holds the octal test number of the test just executed.

Starting Up

1. Set P-register to 100 octal.
2. Load switch register bits 0 to 5 with the select code of the line printer to be tested and set bit 15=0 if using a 12845A-001 or bit 15=1 if using a 12845B interface.
3. Press PRESET (INTERNAL and EXTERNAL if applicable).
4. Press RUN.
 - result:* HALT with MDR=102074 occurs if select code was valid; if MDR=102073, restart from step 2.
5. Load switch register with program options (table 1). If all tests are desired with no options from table 1, clear the switch register.
6. Press RUN.
 - result:* Normal execution of tests begins unless switch register option bit 9 is set. In that event, HALT with MDR=102075 occurs and user specifies tests to be run in A-register. To restart program, clear switch register bit 9 and press RUN.

Anytime during diagnostic execution, switch register bit 9 may be set. Test run aborts at the end of the current test with HALT (MDR=102075). This gives the user the opportunity to specify a different group of tests as described in table 1.

Diagnostic Execution

Tests are divided into two groups: Basic I/O — test 0, and Peripheral — tests 1 through 8. Appropriate error messages are printed for software detected line printer test failures.

a. *Execution of Basic I/O*

ACTION	EXPLANATORY INFORMATION
Initiate diagnostic execution via Starting Up procedures, above.	
<i>Result:</i>	The message
	2607 LINE PRINTER DIAGNOSTIC H024 PRESS PRESET (EXT & INT), RUN
	is printed.
	HALT with MDR = 102024 ₈ occurs.

ACTION	EXPLANATORY INFORMATION
Press PRESET (EXTERNAL and INTERNAL, if applicable).	
Press RUN.	Restart execution.
<i>Result:</i>	Basic I/O test is completed. The message
	H025 BASIC I-O COMP
	is printed. Execution of selected Peripheral tests begins immediately.

b. Execution of Peripheral Tests

These tests should not be run until the 2607 Line Printer (LP) and Interface PCA pass all Basic I/O subtests. Some of the Peripheral tests require manual intervention and some require visual verification by the user. Appendix A holds the test printout from those tests that require visual verification by the user. Thus whenever the user of the diagnostic is directed to refer to a figure, he will find it in Appendix A.

Result: If test 1, Manual Control, is selected, the message
H040 PWR OFF LP, PRESS RUN
is printed, followed by a HALT with MDR = 102040_k.

ACTION	EXPLANATORY INFORMATION
Turn LP power OFF. Press RUN.	If status is incorrect, message E050 is printed.

Result: The message
H041 PWR ON LP, READY LP, PRESS RUN
is printed, followed by a HALT with MDR = 102041_k.

ACTION	EXPLANATORY INFORMATION
Turn LP power ON. Press FORM FEED and PRINT on LP. Press RUN.	If status is incorrect, message E051 is printed. If LP is not at Top of Form, the platen open and paper out tests will fail falsely.

Result: The message
H042 PRINT SW OFF, PRESS RUN
is printed, followed by a HALT with MDR = 102042_k.

ACTION	EXPLANATORY INFORMATION
Press PRINT switch on LP so that light within switch goes out. Press RUN.	If status is incorrect, message E052 is printed.

Result: The message
H043 PRINT SW ON, PRESS RUN
is printed, followed by a HALT with MDR = 102043_k.

ACTION	EXPLANATORY INFORMATION
Press the PRINT switch on the LP so that the light comes back on. Press RUN.	If status is incorrect, the message E053 is printed.

Result: The message
H044 OPEN PLATEN, PRESS RUN
is printed, followed by a HALT with MDR = 102044_R.

ACTION	EXPLANATORY INFORMATION
Pull the PLATEN lever back. Press RUN.	If status is incorrect, the message E054 is printed.

Result: An alarm sounds, as long as the PLATEN lever is pulled back.
The message
H045 CLOSE PLATEN, PRESS RUN
is printed, followed by a HALT with MDR = 102045_R.

ACTION	EXPLANATORY INFORMATION
Push the PLATEN lever forward. Press RUN.	Close PLATEN by pushing lever toward the paper.

Result: The alarm stops when the PLATEN is moved forward into proper position.
The message
H046 REMOVE PAPER FROM LP, PRESS RUN
is printed, followed by a HALT with MDR = 102046_R.

ACTION	EXPLANATORY INFORMATION
Remove paper from the LP. Press RUN.	If status is incorrect, message E055 is printed.

Result: The alarm again sounds when the paper is removed from LP.
The message
H047 RESTORE PAPER IN LP, READY LP, PRESS RUN
is printed, followed by a HALT with MDR = 102047_R.

ACTION**EXPLANATORY INFORMATION**

Replace paper in the LP.
Press FORM FEED and PRINT.
Press RUN.

Result: The alarm stops when the paper is replaced in the LP.
The next selected diagnostic test section is entered.
If test 2, Ripple Print, is selected, printout is made as shown in Figure 1.

ACTION**EXPLANATORY INFORMATION**

Visually verify that printout appears as shown in Figure 1.

All printable characters are printed in each line with printed characters rotated one print position in each succeeding line.

Result: If test 3, Triangular Printing is selected, printout is made as shown by figure 2. This test also tests the line printer auto-print feature.

ACTION**EXPLANATORY INFORMATION**

Visually verify that printout appears as shown in Figure 2.

132 lines are printed with each succeeding line containing one character less.

Result: If test 4, Vertical Format Control Test, is selected, 6 pages of printout are made as shown in Figure 3.

ACTION**EXPLANATORY INFORMATION**

Verify printout by referring to Figure 3.

Vertical format control is issued with each line of printing.

Result: If test 5, Character Set, is selected, printout is made as shown in Figure 4.

ACTION**EXPLANATORY INFORMATION**

Verify that printout of characters appears as shown in Figure 4.

One line of each printable character is printed.

Result: If test 6, Dot Matrix, is selected, printout is made as shown in Figure 5. Switch register bits 1 through 4, if set, can suppress characters "H," "I," "=" and "." respectively.

ACTION

EXPLANATORY INFORMATION

Verify that printout appears as shown in Figure 5.

A line of each character: H, I, # and . is printed unless suppressed via switch register.

Result: If test 7, DMA Operation is selected *and*, if DMA was specified during configuration *and*, if DMA is installed, a ripple pattern of 96 lines is printed like that shown by figure 4. This test will not execute properly if bit 15 (switch register) is not set correctly at the start of the program (page 6, step 2).

ACTION

EXPLANATORY INFORMATION

Verify that the printout appears as shown in Figure 4.

Transfer is made via DMA to the 2607 LP.

Result: If test 8, Operator Design, is selected and a teleprinter is available and configured, the message

OPDSN SECTION

@

is printed. The teleprinter is now in input mode to receive operator designed line printer test instructions. Following entry of each instruction (except "GO" and "BY") the "@" is printed.

ACTION

EXPLANATORY INFORMATION

Select and enter operator design test instructions from Table 5 according to format shown in Appendix B. Terminate each command entered with CARRIAGE RETURN and LINE FEED. The "GO" instruction initiates test. The "BY" instruction causes exit from test 8, OP Design.

Appendix B describes the meaning of each instruction, its format for entry, and gives an example of operator designed test programs.

Result: At the completion of all selected tests, the message

PASS *nnnnnn*

is printed, where *nnnnnn* is the octal pass count. A HALT follows with MDR = 102077₈ and the pass count in the A-register.

c. *Restarting Diagnostic*

- If operator wishes to repeat diagnostic as configured, press RUN.
- If operator wishes to restart diagnostic from HALT with MDR = 102077₈ and with the same line printer select code, but a different set of tests, he does the following:
 1. Set bit 9 of switch register.
 2. Press RUN.
 3. Set A-register bits for tests desired (A-register clear means all).
 4. Clear bit 9 of switch register.
 5. Press RUN.
- If operator wishes to restart diagnostic at any time without reconfiguration, he performs the following:
 1. Set P-register to 2000₈.
 2. Press PRESET (EXTERNAL and INTERNAL, if applicable).
 3. Press RUN.
- If operator wishes to restart diagnostic with new select code, follow procedure in the section "Starting Up."

DIAGNOSTIC MESSAGES AND HALTS

The diagnostic communicates to the operator by teleprinter, HALTs, or both, based on configuration and switch register settings. Thus messages consist of HALT codes (MDR and A-register values) and teleprinter text.

HALT Summary

Table 2 lists octal HALT codes and their significance. Error HALTs are suppressed if switch register bit 14 is set.

The "end of test" HALT is executed, if switch register bit 15 is set; that is the diagnostic executes a HALT instead of proceeding to the next test.

HALT at "end of pass," that is HALT at end of execution of all selected sections of diagnostic, is *suppressed*, if switch register bit 12 is set.

HALT to allow user to make a new test group selection is executed, if switch register bit 9 is set.

Table 2. HALT Codes and Significance

Octal MDR Code	Significance
102000 to 102067	Error (E) or Information (H) messages 00 ₈ to 67 ₈ described in Table 3.
102073	HALT indicating select code input error during "Starting Up" procedure. Input valid select code; press RUN.
102074	Valid select code entry was made; make program option switch register setting; press RUN.
102075	HALT to allow test selection in A-register; make test selection; clear switch register bit 9; press RUN.
102076	End of test section HALT; A-register holds test number just completed.
102077	Diagnostic completed; A-register holds number of passes completed.
106077	Trap cell HALTs stored in CPU memory locations 2 _K to 77 _K .

Diagnostic Messages

There are two general categories of messages output to the operator: program/operator communication messages and test failure (error) messages. Table 3 lists diagnostic messages ordered by message number. Some communication messages have no message number. Those that do are coded with the letter "H" to identify them as communication messages. All error messages are coded with the letter "E." Communication messages are printed, if switch register bit 10 is clear. Error messages are printed if switch register bit 11 is clear.

The test that outputs each message is indicated in the table. The tests are described in this manual under the heading "Test Sections."

"TC" refers to the Test Control program. "CFG" refers to the Configuration portion of the diagnostic (not the Diagnostic Configurator program). Otherwise, the numbers refer to the test number.

Table 3. Messages to Operator

Message	Test	Meaning
2607 LINE PRINTER DIAGNOSTIC	TC	Diagnostic header message.
TEST <i>nn</i>	TC	Indicates to which test a list of error messages, which follow, belongs.
PASS <i>nnnnnn</i>	TC	All selected tests of the diagnostic have completed; <i>nnnnnn</i> is the octal number of passes completed; A register holds the octal number of passes completed, if HALT is invoked.
E000 CLF 0-SFC 0 ERROR	0	CLF/SFC 0 combination failed; CLF did not clear flags or SFC caused no skip with flags clear.
E001 CLF 0-SFS 0 ERROR	0	CLF/SFS 0 combination failed; CLF did not clear flags or SFS caused skip with flags clear.
E002 STF 0-SFC 0 ERROR	0	STF/SFC 0 combination failed; STF did not set flags or SFC caused skip with flags set.
E003 STF 0-SFS 0 ERROR	0	STF/SFS 0 combination failed; STF did not set flags or SFS caused no skip with flags set.
E004 CLF 0 DID NOT INHIBIT INT	0	With card FLAG and CONTROL set, CLF 0 did not turn off interrupt system.
E005 CLF CH-SFC CH ERROR	0	CLF/SFC combination to the 2607 select code (CH) failed; CLF did not clear FLAG or SFC caused no skip with FLAG clear.
E006 CLF CH-SFS CH ERROR	0	CLF/SFS combination to the 2607 select code (CH) failed; CLF did not clear FLAG or SFS caused skip with FLAG clear.
E007 STF CH-SFC CH ERROR	0	STF/SFC combination to the 2607 select code (CH) failed; STF did not set FLAG or SFC caused skip with FLAG set.
E010 STF CH-SFS CH ERROR	0	STF/SFS combination to the 2607 select code (CH) failed; STF did not set FLAG or SFS caused no skip with FLAG set.
E011 STF <i>nn</i> SET CARD FLAG	0	Select code screen test failed; <i>nn</i> = select code that caused the FLAG to set.
E012 INT DURING HOLD OFF INSTR	0	Interrupt occurred during an I/O instruction, a JMP indirect, or a JSB indirect instruction.
E013 SECOND INT OCCURRED	0	Card interrupted a second time after initial interrupt was processed.

Table 3. Messages to Operator (continued)

Message		Test	Meaning
E014	NO INT	0	No interrupt occurred with card FLAG and CONTROL set and the interrupt system on.
E015	INT RTN ADDR ERROR	0	Interrupt did not occur at the correct location in memory.
E016	CLC CH ERROR	0	CLC to 2607 select code (CH) did not clear card CONTROL with the interrupt system on.
E017	CLC 0 ERROR	0	CLC 0 did not clear CONTROL with the interrupt system on.
E020	PRESET (EXT) DID NOT SET FLAG	0	PRESET (External, if applicable) did not set the card FLAG.
E021	PRESET (INT) DID NOT DISABLE INTS	0	PRESET (Internal, if applicable) did not disable the interrupt system.
E022	PRESET (EXT) DID NOT CLEAR CONTROL	0	PRESET (External, if applicable) did not clear CONTROL.
E023	PRESET (EXT) DID NOT CLEAR I/O LINES	0	PRESET (External, if applicable) did not clear I/O data lines.
H024	PRESS PRESET (EXT & INT), RUN	0	Press PRESET (External and Internal, if applicable) then press RUN.
H025	BI-O COMP	0	Test 0, Basic I/O tests, are complete.
E026	INT EXECUTION ERROR	0	Instructions being executed prior to and/or just after the interrupt did not execute correctly.
E030	FLAG FAILED TO SET AFTER OUTPUT	1 to 6, 8	Device FLAG failed to SET with the interrupt system OFF.
E031	LP FAILED TO INT AFTER OUTPUT	1 to 6, 8	Line printer failed to interrupt with interrupt system ON.
E032	LP NOT RDY	1 to 8	Line printer status indicates NOT READY.
H033	DMA NOT CONFIGURED	7	DMA option bit not SET during configuration via the Diagnostic Configurator.
E034	DMA TIME OUT	7	DMA or card failed to set FLAG after a block transfer.
E035	INTERFACE FLAG DID NOT SET AFTER DMA	7	DMA completed a block transfer but the Interface PCA did not set its FLAG to indicate it was finished.
E036	DEMAND BUSY	1 to 8	Line printer status erroneously indicates that demand bit is busy, after 5 second time-out.

Table 3. Messages to Operator (continued)

Message	Test	Meaning
H040 PWR OFF LP, PRESS RUN	1	Turn LP power OFF; press RUN.
H041 PWR ON LP, READY LP PRESS RUN	1	Turn LP power ON. Press FORM FEED, PRINT on LP; press RUN.
H042 PRINT SW OFF, PRESS RUN	1	Press PRINT switch on LP so that light goes out; press RUN.
H043 PRINT SW ON, PRESS RUN	1	Press PRINT switch on LP so that light comes on; press RUN.
H044 OPEN PLATEN, PRESS RUN	1	Open platen on LP; press RUN.
H045 CLOSE PLATEN, PRESS RUN	1	Close platen on LP; press RUN.
H046 REMOVE PAPER FROM LP, PRESS RUN	1	Remove paper from LP; press RUN.
H047 RESTORE PAPER IN LP, READY LP, PRESS RUN	1	Replace paper in LP; press FORM FEED and PRINT; press RUN.
E050 STATUS IS xxxxxx SHOULD BE 140001	1	LP status is incorrect after performing LP power OFF action; xxxxxx is received status.
E051 STATUS IS xxxxxx SHOULD BE 100001	1	LP status is incorrect after performing LP power ON action; xxxxxx is received status.
E052 STATUS IS xxxxxx SHOULD BE 000000	1	LP status is incorrect after performing LP PRINT switch OFF action; xxxxxx is received status.
E053 STATUS IS xxxxxx SHOULD BE 100001	1	LP status is incorrect after performing LP PRINT switch ON action; xxxxxx is received status.
E054 STATUS IS xxxxxx SHOULD BE 000000	1	LP status is incorrect after performing LP open platen action; xxxxxx is received status.
E055 STATUS IS xxxxxx SHOULD BE 000000	1	LP status is incorrect after removing paper from LP; xxxxxx is received status.
OPDSN SECTION	8	Introductory message for Operator Design test section.
ILLEGAL INPUT	8	Instruction entered after prompt "@" symbol was illegal.
QUE FULL STATEMENT NOT LOADED	8	Buffer area for program instructions is full; last instruction entered is not in buffer.

Table 3. Messages to Operator (continued)

Message	Test	Meaning
ERROR <i>e</i> IN LINE <i>n</i>	8	Instruction <i>n</i> contains error <i>e</i> where <i>e</i> has the following significance: <i>e</i> = 1 means line number not found, <i>e</i> = 2 means more than 15 "GS" instructions have stacked up without being cleared by an "RT" instruction, <i>e</i> = 3 means an "RT" instruction occurred without a "GS" instruction to return to.
<i>nn</i> STATUS IS <i>xx000x</i>	8	Instruction at line <i>nn</i> called for a report of status; status is <i>xx000x</i> ₈ (only bit 15, 14 and 0 hold significant status).



Test Sections

The HP 2607 Line Printer Diagnostic provides nine tests to verify proper operation of the HP 2607 line printer. The string of tests are normally executed in sequence although any one or subset of tests may be run. Basic I/O, test 0, should run without error before the rest of the tests are attempted. The test sections are titled by function.

Test Number	Title
0	Basic I/O Channel Functions
1	Manual Control
2	Ripple Print
3	Triangular Print
4	Vertical Format Control
5	Character Set
6	Dot Matrix
7	DMA
8	Operator Design

In addition to the test sections, a Test Control section and a configuration section are provided; neither is selectable.

CONFIGURATION

This section accepts I/O select code and configures diagnostic I/O commands accordingly.

TEST CONTROL

This section prints messages and controls execution of diagnostic test sections according to configuration parameters and switch register options.

BASIC I/O CHANNEL FUNCTIONS -- TEST 0

This test verifies the Line Printer I/O channel functions. It consists of seven subsections.

Section 1

The ability to clear, set, and test the interrupt system is tested.

Section 2

The absence of an interrupt is verified when the I/O channel FLAG and CONTROL is set and when the interrupt system is OFF.

Section 3

The ability to clear, set and test the I/O channel FLAG is tested.

Section 4

The FLAG of every channel (from 10_8 to 77_8), except the line printer channel, is set. A test is then made to insure that the I/O system does not set the line printer channel FLAG as well.

Section 5

The ability of the line printer channel to interrupt is tested. With the FLAG and CONTROL set and the interrupt system on, an interrupt should occur on the line printer channel. It is then verified that the interrupt occurred where expected and that another interrupt does not occur, when the interrupt system is turned back on.

Section 6

It is verified that no interrupt occurs following a "CLC CH" instruction (clear I/O CONTROL bit on line printer channel) when the interrupt system is on and the line printer channel FLAG and CONTROL are set. The "CLC CH" instruction should clear the CONTROL bit. A test is also made to insure that a "CLC 0" instruction indirectly clears the line printer channel CONTROL bit.

Section 7

The PRESET function on the CPU Front Panel is tested with the aid of manual switch entry by the operator. It is verified that all FLAGS are set, all CONTROL bits are cleared, the interrupt system is cleared, and all I/O data lines are cleared.

MANUAL CONTROL — TEST 1

This test allows the operator to test the various line printer functions manually and to insure that the proper status is reported. If switch register option bits 12 or 8 (see Table 1) are set, the test will be skipped. The 8 LPI switch must be released (in OUT position) indicating 6 LPI.

1. The operator turns off the line printer and presses RUN. If the status reported by the printer is not 100001_8 , error message E050 is printed.
2. The operator turns on the line printer and presses FORM FEED, PRINT, and RUN. If the status reported by the printer is not 100001_8 , error message E051 is printed.
3. The operator presses the PRINT switch to disable printing (the print indicator light is extinguished) and then presses RUN. If the status reported by the printer is not 000000_8 , error message E052 is printed.
4. The operator presses the PRINT switch to enable printing (the print indicator lights) and then presses RUN. If the status reported by the printer is not 100001_8 , error message E053 is printed.
5. The operator pulls the PLATEN lever back (an audio alarm should ring) and then presses RUN. If the status reported by the printer is not 000000_8 , error message E054 is printed.
6. The operator pushes the PLATEN lever forward (audio alarm should stop) and presses RUN.
7. The operator removes the paper from the printer (audio alarm should sound) and presses RUN. If the status reported by the printer is not 000000_8 , error message E055 is printed.
8. The operator puts the paper back into the printer (audio alarm should stop) and presses FORM FEED, PRINT, and RUN. The next selected test is entered.

RIPPLE PRINT — TEST 2

The ripple print test is a general printing test. It prints a ripple pattern consisting of 96 lines containing 96 printable characters rotated one print position on each succeeding line. A FORM FEED is performed at the end of the printing to start the next test.

TRIANGULAR PRINT — TEST 3

The triangular print test prints a triangular pattern consisting of 148 lines (figure 2). The first 16 lines are a test of the ability of the line printer to automatically print a line when its buffer is full. The first line sent consists of 140 characters (character M). The line printer should print one 132-character line followed by one 8-character line. Each successive line sent contains one less character. This test verifies that column positions not sent characters do not print.

VERTICAL FORMAT CONTROL — TEST 4

This test serves to verify the operation of the various format control functions. The functions are divided into two groups. The first group consists of the eight functions provided by the eight channels on the vertical format control unit tape (VFU). The following VFU commands are tested:

Function	No. of times Performed	Octal Code	Operation
TOF	1	100100	Top of Form
BOF	1	100101	Bottom of form
SS	12	100102	Single Space
DS	6	100103	Double Space
TS	4	100104	Triple Space
QP	2	100106	Next Quarter Page
HP	2	100105	Next Half Page
SP	3	100107	Next sixth page
TOF	1	100100	Top of Form

Selected holes on the VFU tape channels are tested, producing 6 pages of printing.

The second group consists of the Line Control functions. The following Line Control functions are exercised:

Function (Slew)	Octal Code	Lines Slew
S0	100000	1
S1	100001	1
S2	100002	2
S3	100003	3
S4	100004	4
S5	100005	5
S6	100006	6
S7	100007	7
S8	100010	8
S9	100011	9
S10	100012	10
S11	100013	11
S12	100014	12
S13	100015	13
S14	100016	14
S15	100017	15

Each Line Control function is executed once, producing 2 pages of printing.

CHARACTER SET – TEST 5

This test verifies that all codes yield the correct characters which in turn are printed properly. The tests print one line of each character starting with octal code 000₈ and ending with 177₈. A FORM FEED is performed at the end of printing to start the next test. See Table 4 for character set codes.

DOT MATRIX – TEST 6

The dot matrix test verifies that the printer is capable of printing data in all 35 locations of the dot matrix. Four characters are used for testing, consisting of an H, I, # and a period ".". The characters H, I, # and period may be selectively disabled by setting switch register bits 1 through 4 respectively. See Table 1.



DMA – TEST 7

The DMA test verifies that the printer will run under DMA control. A ripple pattern identical to the pattern printed by test 2 (Ripple Print) results. Eroneous output will result if the interface is not properly specified at the start of the program (page 6, step 2). A FORM FEED is performed at the end of printing to start the next test.

This test will be executed only if the DMA option has been specified via the Diagnostic Configurator. In this case the line printer buffer is filled through the DMA hardware. It is assumed that the DMA hardware is working correctly and only the service request logic of the line printer interface and corresponding timing relation are to be tested.

OPERATOR DESIGN – TEST 8

If a console device is specified during configuration procedure, the user is allowed to design and execute his own program to test line printer functions. Upon entry to this routine, the message "OPDSN SECTION" is printed on the teleprinter followed by a "@" The user then selects OPDSN instructions, enters them on the teleprinter and starts execution as described in Appendix B. If switch register options, bits 12 or 8 (Table 1) are set the test will be skipped. The test is exited by keying in "BY" followed by LINE FEED at the teleprinter.

Table 4. Line Printer Character Codes and Symbols

CODE (HEX)	2607A 2607A-002	2607A-001	2607A-003	CODE (OCTAL)	STANDARD -001	2607A-002 2607A-003	CODE (OCTAL)	STANDARD -001	2607A-002 2607A-003	CODE (OCTAL)	STANDARD (64 CHAR)	2607A -001	2607A-002	2607A-003
0xx000				0xx040	(blank)		0xx100	,		0xx140	,			
0xx001	*			0xx041	!		0xx101	A		0xx141	A	a		
0xx002				0xx042	"		0xx102	B		0xx142	B	b		
0xx003				0xx043	#		0xx103	C		0xx143	C	c		
0xx004				0xx044	\$		0xx104	D		0xx144	D	d		
0xx005				0xx045	%		0xx105	E		0xx145	E	e		
0xx006				0xx046	&		0xx106	F		0xx146	F	f		
0xx007				0xx047	'		0xx107	G		0xx147	G	g		
0xx008				0xx050	(0xx110	H		0xx150	H	h		
0xx009				0xx051)		0xx111	I		0xx151	I	i		
0xx010				0xx052	*		0xx112	J		0xx152	J	j		
0xx011				0xx053	+		0xx113	K		0xx153	K	k		
0xx012				0xx054	,		0xx114	L		0xx154	L	l		
0xx013				0xx055	-		0xx115	M		0xx155	M	m		
0xx014				0xx056	.		0xx116	N		0xx156	N	n		
0xx015				0xx057	/		0xx117	O		0xx157	O	o		
0xx016				0xx060	0		0xx120	P		0xx160	P	p		
0xx017				0xx061	1		0xx121	Q		0xx161	Q	q		
0xx018				0xx062	2		0xx122	R		0xx162	R	r		
0xx019				0xx063	3		0xx123	S		0xx163	S	s		
0xx020				0xx064	4		0xx124	T		0xx164	T	t		
0xx021				0xx065	5		0xx125	U		0xx165	U	u		
0xx022				0xx066	6		0xx126	V		0xx166	V	v		
0xx023				0xx067	7		0xx127	W		0xx167	W	w		
0xx024				0xx070	8		0xx130	X		0xx170	X	x		
0xx025				0xx071	9		0xx131	Y		0xx171	Y	y		
0xx026				0xx072	:		0xx132	Z		0xx172	Z	z		
0xx027				0xx073	;		0xx133	[A	0xx173	[A	
0xx028				0xx074	<		0xx134	\	O	0xx174	\		O	
0xx029				0xx075	=		0xx135]	A	0xx175]		A	
0xx030				0xx076	>		0xx136	^		0xx176	^			
0xx031				0xx077	?		0xx137	_		0xx177	_			

APPENDIX A
Test Printout

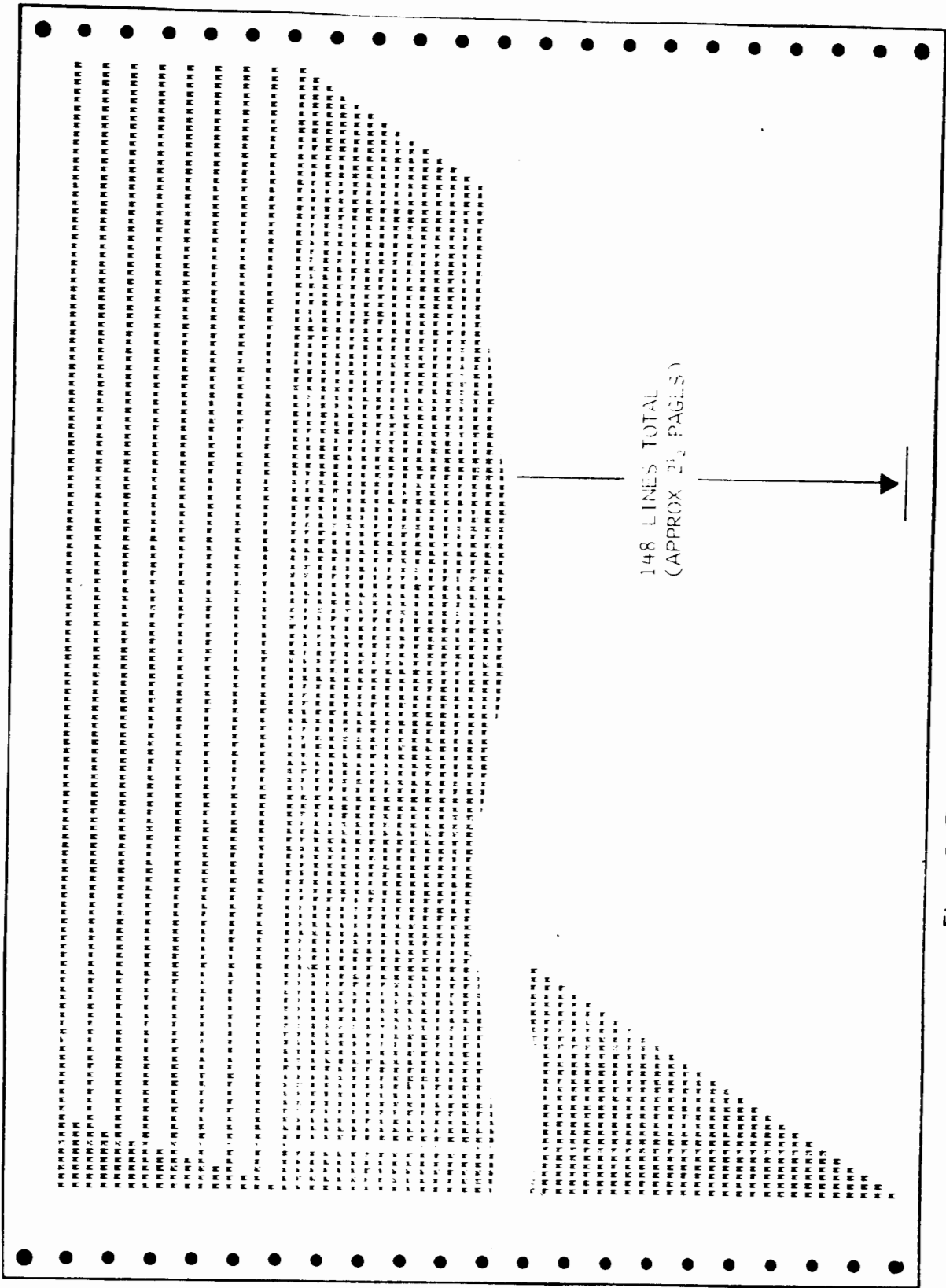

Figure 2. Triangular Printing Test Printout

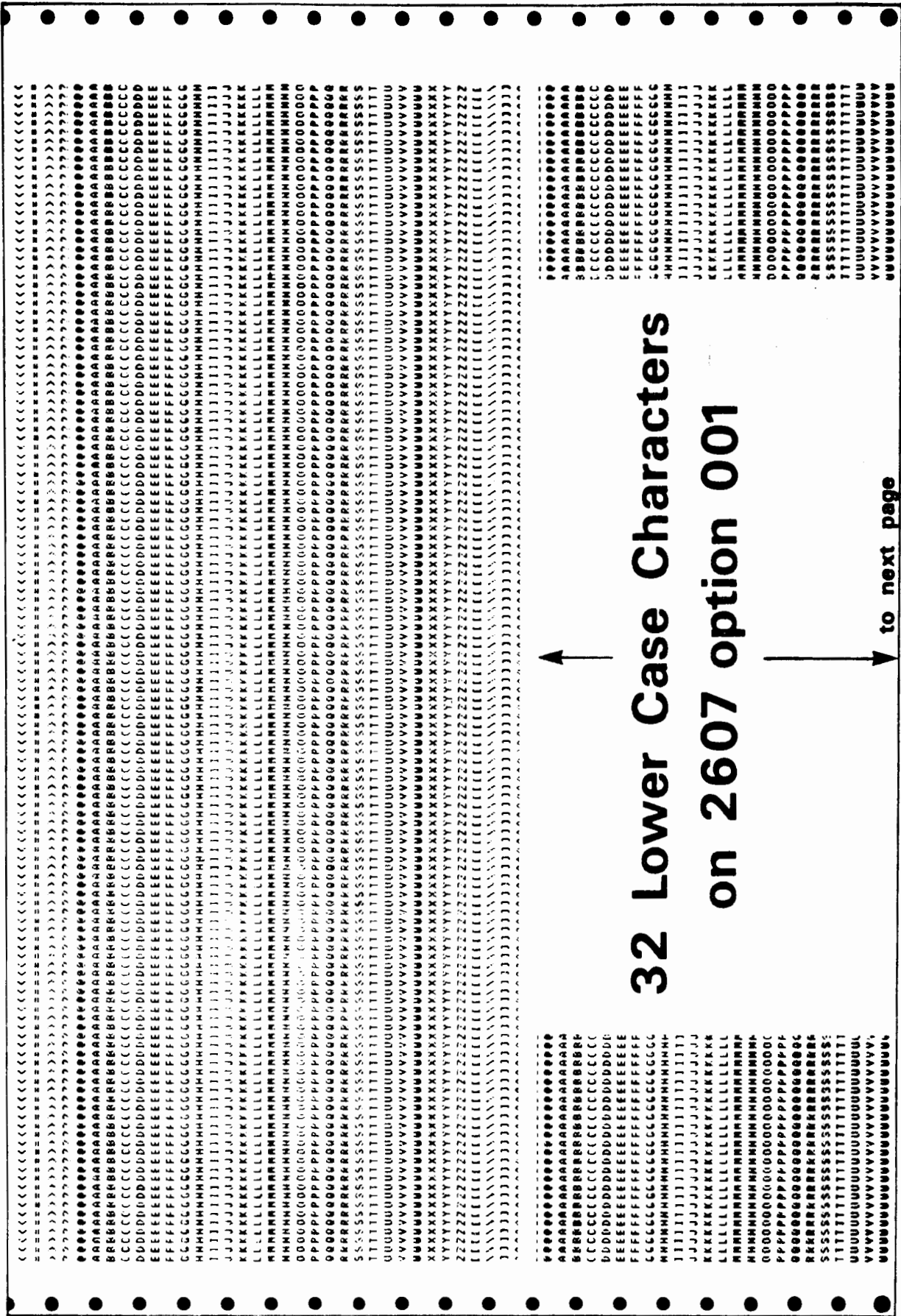

Figure 4. Character Set Test Printout (Page 2 of 3)

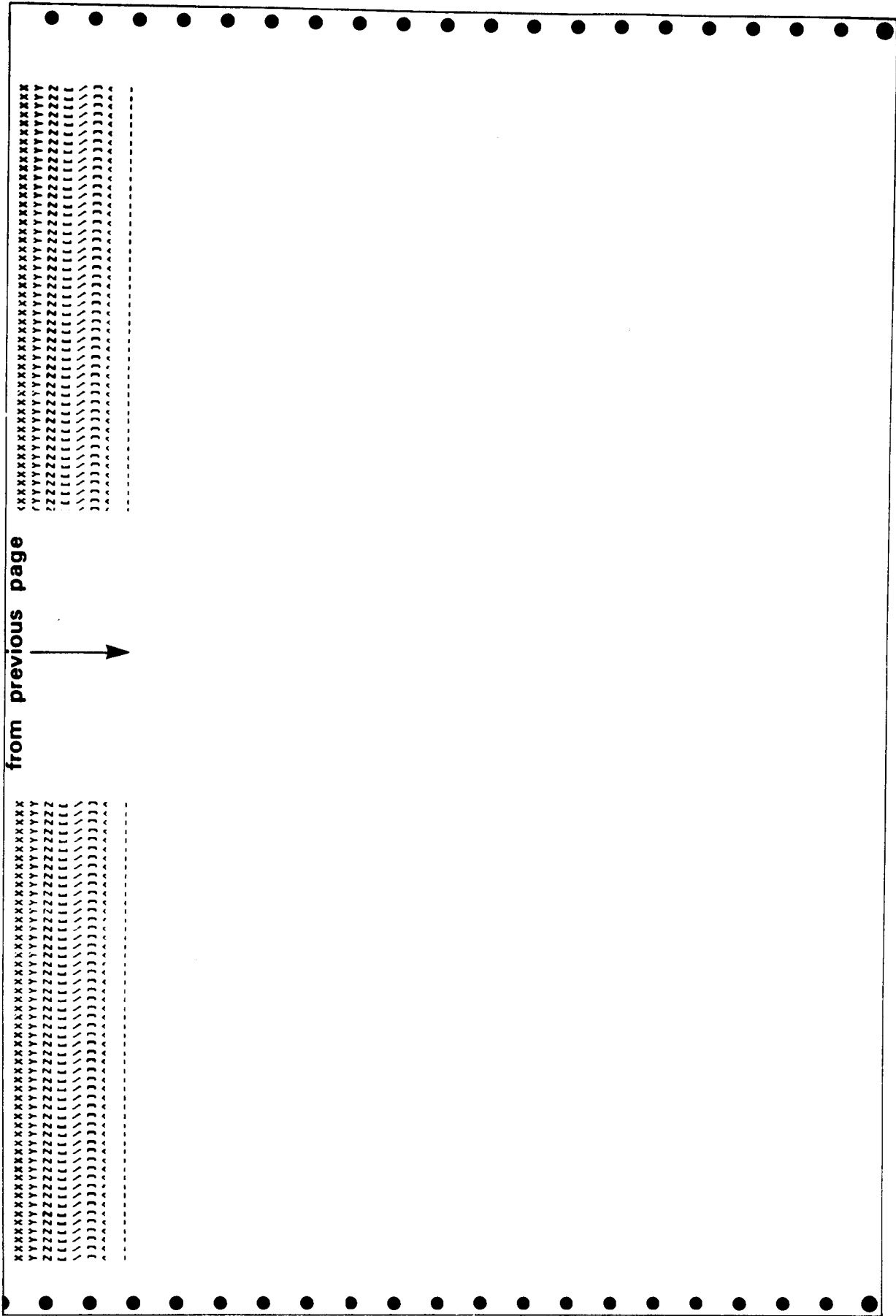

Figure 4. Character Set Test Printout (Page 3 of 3)

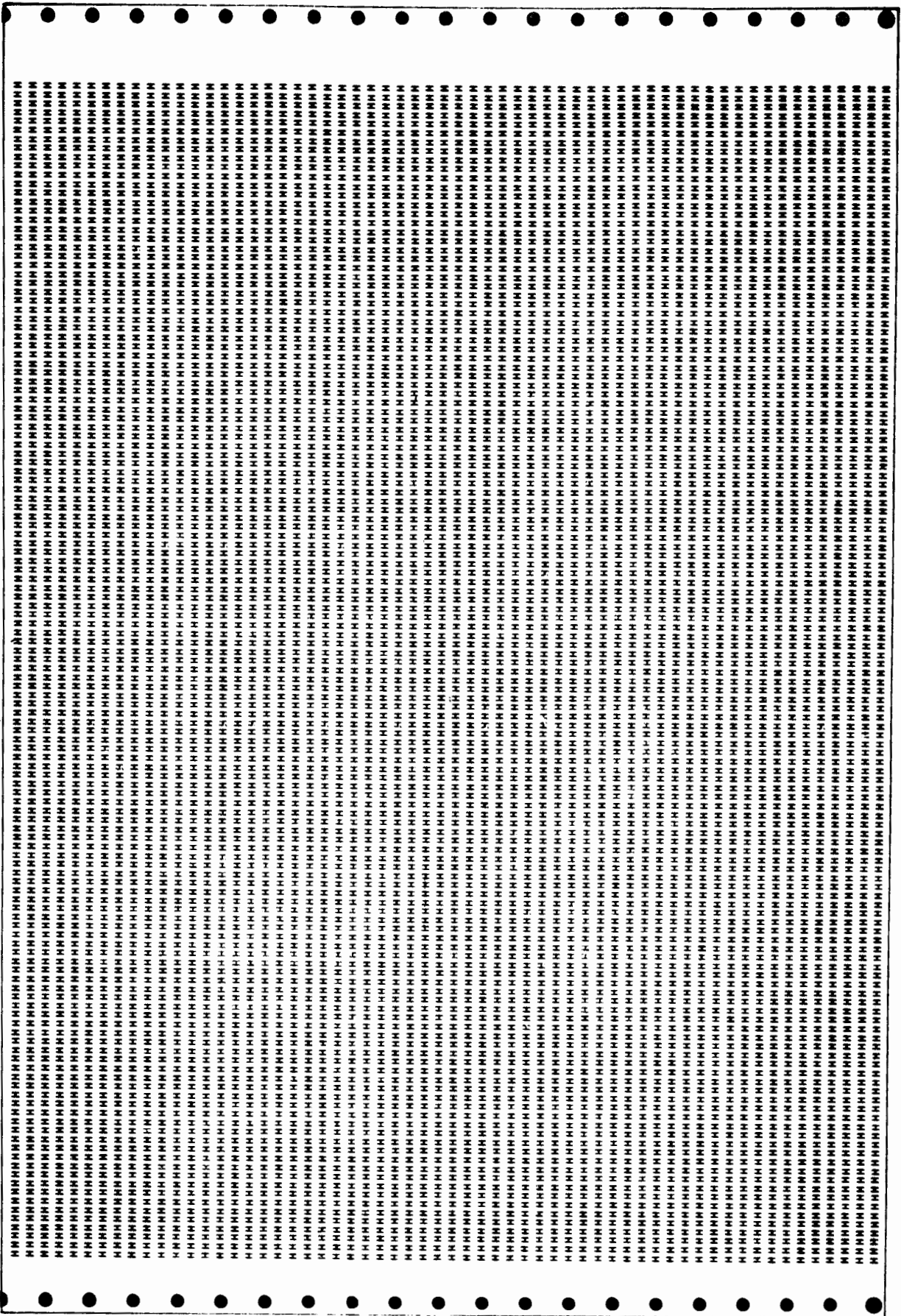

Figure 5. Dot Matrix Test Printout (Page 1 of 4)

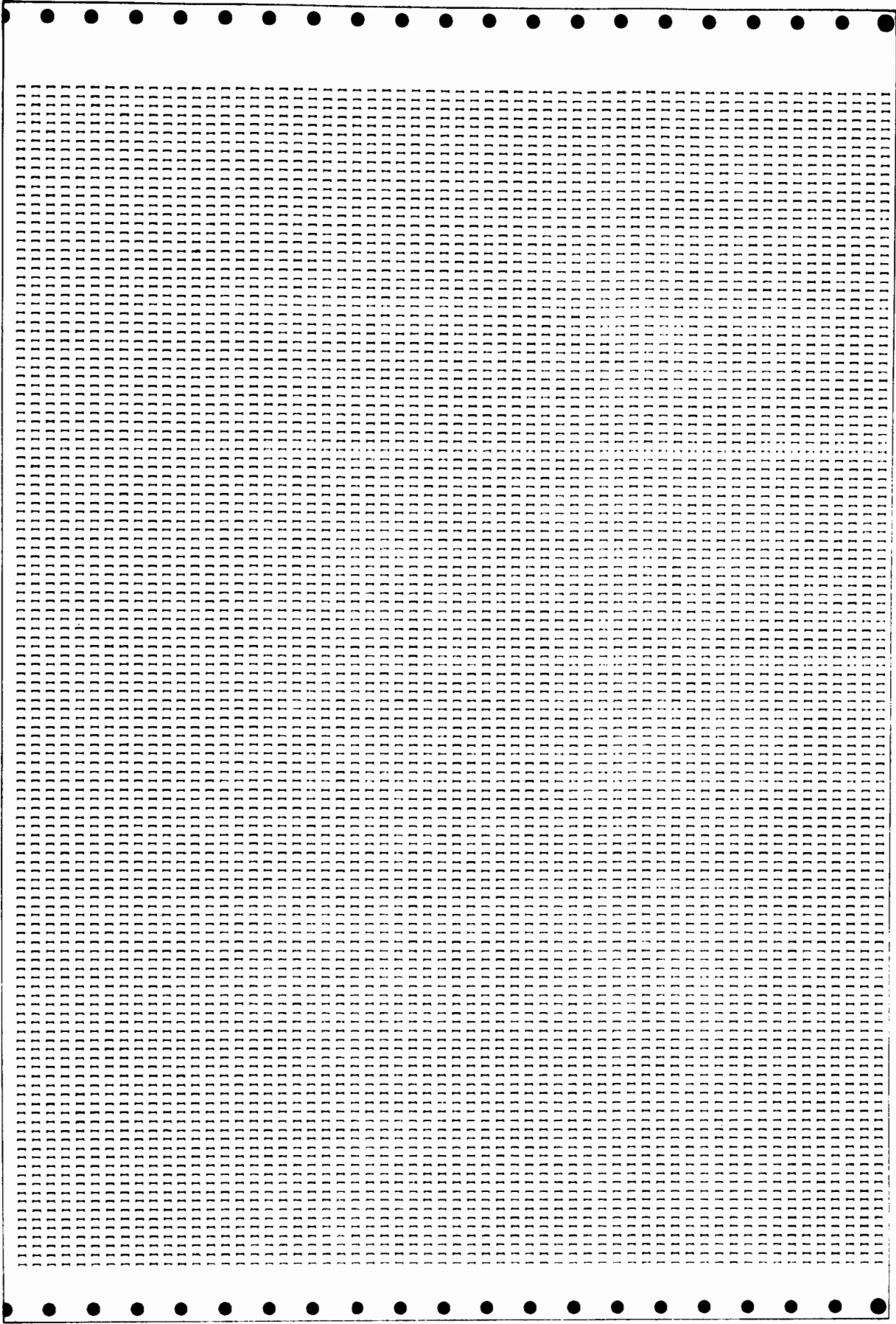

Figure 5. Dot Matrix Test Printout (Page 2 of 4)

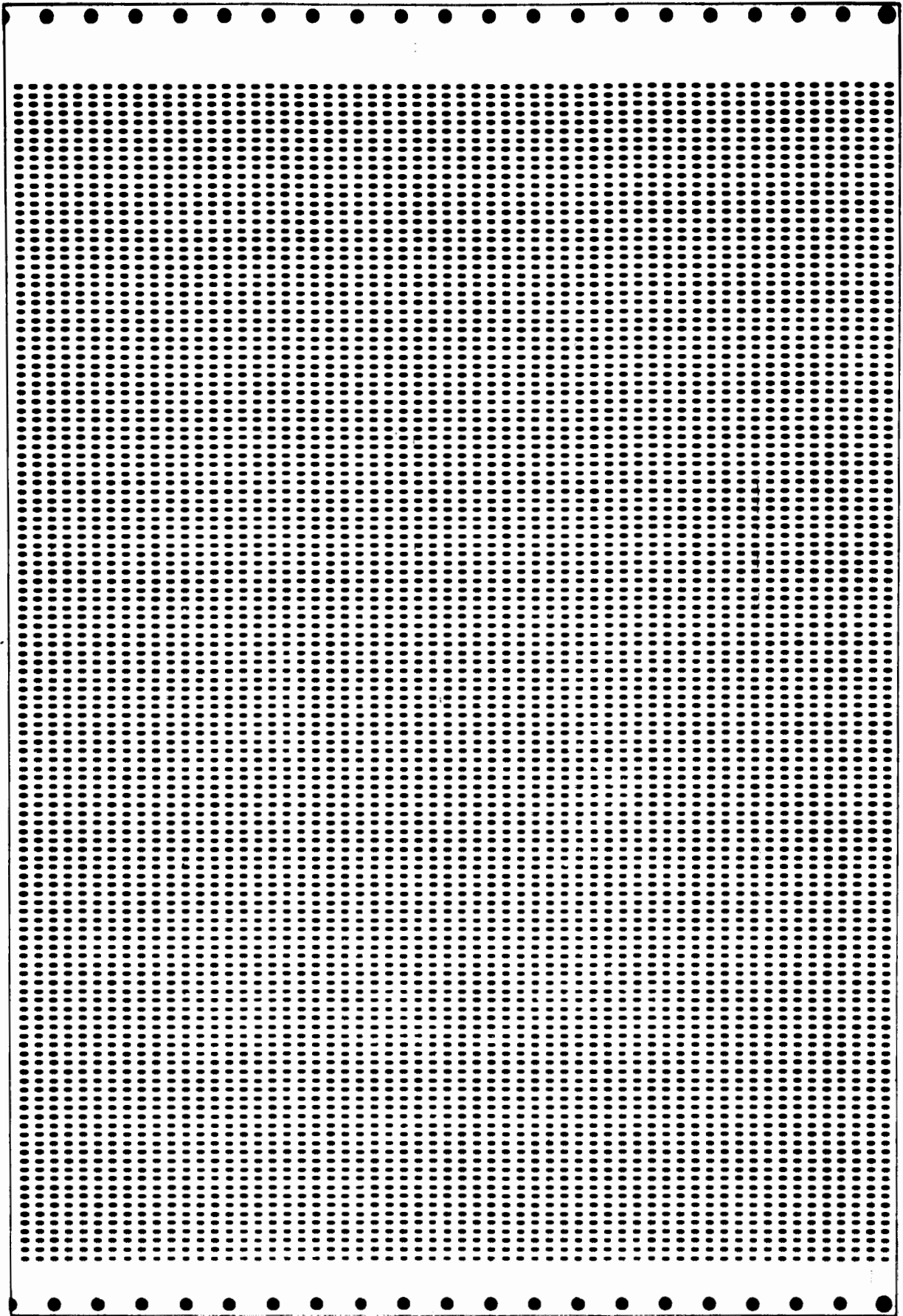

Figure 5. Dot Matrix Test Printout (Page 3 of 4)

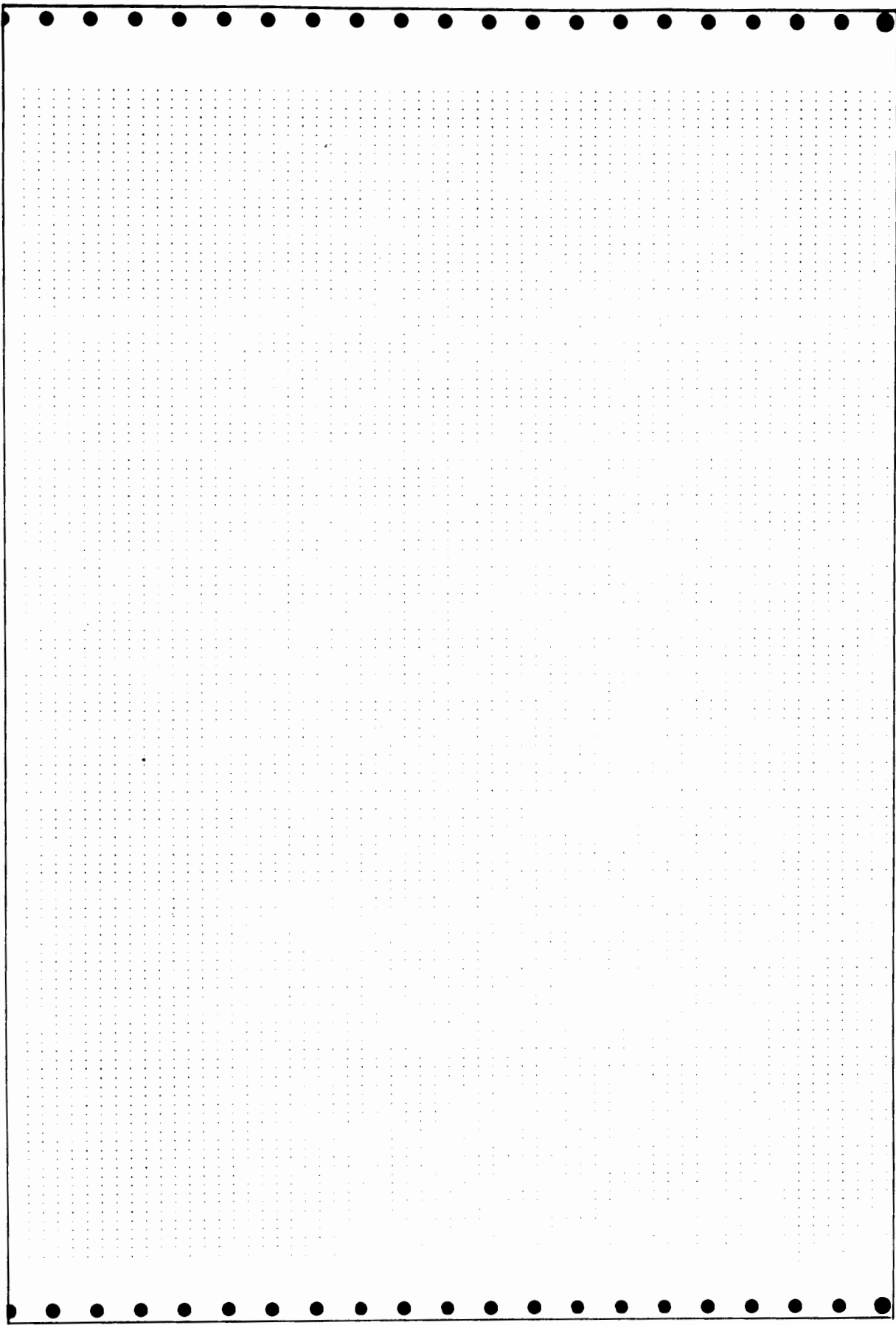

Figure 5. Dot Matrix Test Printout (Page 4 of 4)

APPENDIX B

Operator Design

The Operator Design (Op Design) section, test 8, provides the means for the operator to produce and execute his own line printer test routine. This section accepts a list of instructions from the operator at the teleprinter. The instructions are executed upon command.

ENTERING OP DESIGN INSTRUCTIONS

When the Op Design section is selected, the message

OPDSN SECTION

is printed, where "@" is the prompt for the operator to key in his instruction from those given in Table 5. Terminate each entry with a CARRIAGE RETURN and LINE FEED.

Table 5. Op Design Instructions

Instruction	EXECUTION CONTROL Explanation
LI,<i>nn,mm</i>	List Program: List program from line number <i>nn</i> to line number <i>mm</i> ; if <i>mm</i> is omitted, list to end of program, if <i>nn,mm</i> is omitted, list the entire program.
DL,<i>nn</i>	Delete Line: Delete program line number <i>nn</i> ; if <i>nn</i> = AL, delete entire program.
GO,<i>nn</i>	Start Program: Start program execution at line <i>nn</i> ; if <i>nn</i> is not specified, start program execution at first program statement.
DB,<i>i,t</i>	Define Buffer: Establish the test program buffer with <i>i</i> items of data type, <i>t</i> : <i>t</i> = A specifies ASCII data, where <i>i</i> indicates the number of characters. <i>t</i> = I specifies decimal integer data between -32767 and +32767, where <i>i</i> indicates the number of integers. <i>t</i> = K specifies octal integer data up to 177777 ₈ , where <i>i</i> indicates the number of integers. Enter all ASCII characters on one line. Enter each integer one per line followed by CR, LF.

Table 5. Op Design Instructions (continued)

EXECUTION CONTROL (continued)	
Instruction	Explanation
BY	Exit Op Design Program. Operator Design Program is terminated and control returns to Control Program (a HALT with MDR = 102077 occurs).
TEST PROGRAM INSTRUCTIONS	
Instruction	Explanation
<i>nn</i> WA	Wait. Halt execution of program and print out the message " <i>nn</i> WAIT"; to continue program operator keys in "CO"; to stop program and elicit prompt character, "@," operator keys in "ST."
<i>nn</i> GT, <i>mm</i>	Go to. Branch to instruction with line number <i>mm</i> .
<i>nn</i> GS, <i>mm</i> , <i>i</i>	Go Sub. Branch to subroutine which begins on line <i>mm</i> ; if <i>i</i> is specified, repeat subroutine <i>i</i> times before returning to line <i>nn</i> + 1; a subroutine consists of one or more instructions the last of which is an "RT" (Return).
<i>nn</i> RT	Return. Exit from subroutine and continue execution of program from line after calling "GS" instruction; this instruction must be preceded in execution by a calling "GS" instruction.
<i>nn</i> MS, <i>aa</i> , <i>i</i>	Message. At the teleprinter print the message " <i>aa i</i> ", where <i>aa</i> is any two characters and <i>i</i> is a decimal integer.
<i>nn</i> TD, <i>i</i>	Time Delay. Wait <i>i</i> milliseconds before executing the next instruction, where <i>i</i> is between 0 and 32,767 milliseconds.
<i>nn</i> SR	Status Report. Fetch the status word from the line printer interface and print it on the teleprinter; message format is: <div style="text-align: center;"><i>nn</i> STATUS IS <i>xx000x</i></div> where <i>nn</i> is line number of executing status instruction and <i>xx000x</i> is fetched octal status word. (Note that only bits 15, 14, and 0 hold significant status).
<i>nn</i> SC, <i>xx000x</i> , <i>mm</i>	Status Check. Fetch the status word from the line printer interface and compare it to the octal value, <i>xx000x</i> , where only bits 15, 14 and 0 will be compared. If the fetched value = <i>xx000x</i> , continue to next instruction; if the fetched value \neq <i>xx000x</i> , go to instruction at line <i>mm</i> .
<i>nn</i> CP, <i>i</i> , <i>j</i>	Cyclic Print. Print on the line printer a ripple print pattern, similar to Figure 1, which cycles one character to left for each line printed; <i>i</i> specifies the number of lines output; default for <i>i</i> and <i>j</i> are 132 and 60 respectively.
<i>nn</i> OC, <i>p</i> , <i>i</i>	Output Characters. Output to line printer <i>i</i> characters specified by parameter <i>p</i> : <i>p</i> = UB means output <i>i</i> characters from buffer defined by "DB" instruction; <i>i</i> defaults to buffer length. <i>p</i> = \$c means output the character <i>c</i> <i>i</i> times to line printer; <i>i</i> defaults to one character.

Table 5. Op Design Instructions (continued)

TEST PROGRAM INSTRUCTIONS (continued)	
Instruction	Explanation
<i>nn PC</i>	Print Command. Print the contents of the line printer buffer (a command of 100102, is sent to LP).
<i>nn FF, p, i</i>	Form Feed. Same as "OC" instruction except that output is followed by a FORM FEED; if <i>p</i> and <i>i</i> are not specified, FORM FEED only is sent to LP.
<i>nn VF, v, i</i>	Vertical Form Control. When <i>v</i> = LC, output a LINE CONTROL command, where <i>i</i> specifies the number of lines; default for <i>i</i> = 0 lines. When <i>v</i> = FC, output a FORM CONTROL command, where <i>i</i> specifies the channel number; default for <i>i</i> = 0 (Top of Form). If neither <i>v</i> or <i>i</i> are specified, the default is FORM CONTROL and Top of Form.

INSTRUCTION FORMAT

There are two instruction formats. One format is for instructions executed immediately after entry, called Execution Control instructions, and another format for instructions executed in groups upon command, called Test Program instructions.

Execution Control

These instructions are executed immediately after they are accepted. Consequently, they need no line number. They have the general format:

II, x, y

where *II* is the instruction code and *x* and *y* are parameters, if any. No SPACES should appear in an Execution Control instruction, except that a SPACE may be substituted for the COMMA as a parameter separator.

Test Program Instructions

These instructions are executed in groups as a sequence of commands which perform test functions on the line printer. Since sequence of execution is primarily important, these instructions require line number in their format:

nn II, x, y

where *nn* is a two digit decimal number. Lines may be entered in any order. They will be executed in line number sequence. One SPACE must follow the line number. Otherwise, the only SPACE that appears is that which may be substituted for the comma as a parameter separator.

EXAMPLE 1.

```

@02 SC, 100001, 30 (CR/LF)
@08 FF (CR/LF)
@10 OC, $W, 132 (CR/LF)
@12 PC (CR/LF)
@14 GS, 16, 30 (CR/LF)
@15 GT, 02 (CR/LF)
@16 OC, $E, 75 (CR/LF)
@18 PC (CR/LF)
@20 RT (CR/LF)
@30 MS, ER, 01 (CR/LF)
@GO
    
```

Flow of Example 1 is shown in Figure 6. Print-out is shown in Figure 7. If status is bad, the teleprinter prints out:

```

*ER 00001
@
    
```

and is ready for operator input.

EXAMPLE 2.

```

@ DB, 1, A (CR/LF executed by diagnostic)
Z (CR/LF executed by diagnostic)
@10 OC, UB (CR/LF)
@20 PC (CR/LF)
@GO (CR/LF)
@
    
```

The EXAMPLE 2 test program executes once, printing one "Z" on the line printer. Then the Op Design program outputs the "@" prompt signalling completion of the program.

The operator can then add to the program:

```

@05 FF (CR/LF)
@GO (CR/LF)
    
```

This will produce a FORM FEED before each printout on the line printer. Use the "LI" command to list program:

```

@LI (CR/LF)
0005 FF
0010 OC UB
0020 PC
**LIST END**
@
    
```

Note that "LI" function removes commas and fills in leading zeros.

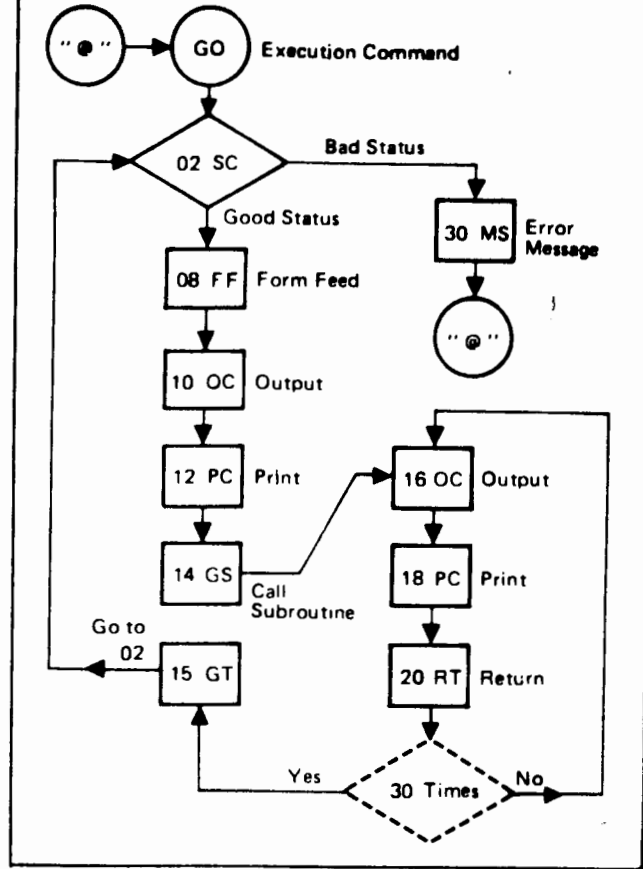

Figure 6. Flowchart