

Connectivity Pack User's Guide

for the HP 200LX
and the HP 100LX

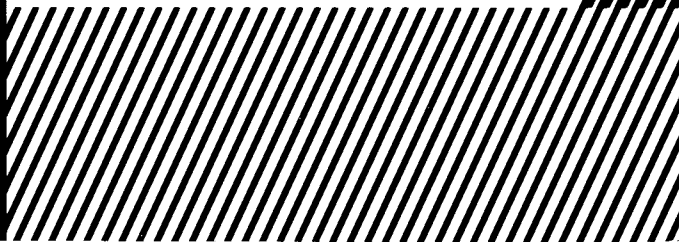

Connectivity Pack User's Guide

**for the HP 200LX
and the HP 100LX**



**HP Part No. F1021-90007
Printed in Singapore**

HP Computer Museum
www.hpmuseum.net

For research and education purposes only.

Notice

For warranty information, see chapter 6.

This manual and any examples contained herein are provided “as is” and are subject to change without notice. **Hewlett-Packard Company makes no warranty of any kind with regard to this manual, including, but not limited to, the implied warranties of merchantability and fitness for a particular purpose.** Hewlett-Packard Co. shall not be liable for any errors or for incidental or consequential damages in connection with the furnishing, performance, or use of this manual or the examples herein.

The above disclaimers and limitations shall not apply to consumer transactions in Australia and the United Kingdom and shall not affect the statutory rights of consumers.

© Hewlett-Packard Co. 1994. All rights reserved. Reproduction, adaptation, or translation of this manual is prohibited without prior written permission of Hewlett-Packard Company, except as allowed under the copyright laws.

Microsoft and MS-DOS are registered trademarks of Microsoft, Incorporated. Intuit and Pocket Quicken are registered trademarks of Intuit, Inc. Lotus and 1-2-3 are registered trademarks of Lotus Development Corporation. LapLink Remote Access is a trademark of Traveling Software, Incorporated.

Hewlett-Packard Company
Corvallis Division
1000 N.E. Circle Blvd.
Corvallis, OR 97330, U.S.A.

HP Software Product License Agreement

Important: Please carefully read this License Agreement before opening the media envelope or operating the equipment. Rights in the software are offered only on the condition that the Customer agrees to all terms and conditions of the License Agreement. **Opening the media envelope or operating the equipment indicates your acceptance of these terms and conditions.** If you do not agree to the License Agreement, you may return the unopened package for a full refund.

In return for payment of the applicable fee, HP grants the Customer a license in the software, until terminated, subject to the following:

Use:

- Customer may use the software on any one computer.
- Customer may not reverse assemble or decompile the software.

Copies and Adaptations:

- Customer may make copies or adaptations of the software:
 - For archival purposes, or
 - When copying or adaptation is an essential step in the use of the software with a computer so long as the copies and adaptations are used in no other manner.
- Customer has no other rights to copy unless they acquire an appropriate license to reproduce, which is available from HP for some software.
- Customer agrees that no warranty, free installation, or free training is provided by HP for any copies or adaptations made by Customer.
- All copies and adaptations of the software must bear the copyright notice(s) contained in or on the original.

Ownership:

- Customer agrees that they do not have any title or ownership of the software, other than ownership of the physical media.
- Customer acknowledges and agrees that the software is copyrighted and protected under the copyright laws.
- Customer acknowledges and agrees that the software may have been developed by a third party software supplier named in the copyright notice(s) included with the software, who shall be authorized to hold the Customer responsible for any copyright infringement or violation of this License Agreement.

Transfer of Rights in Software:

- Customer may transfer rights in the software to a third party only as part of the transfer of all their rights, and only if Customer obtains the prior agreement of the third party to be bound by the terms of this License Agreement.
- Upon such a transfer, Customer agrees that their rights in the software are terminated, and that they will either destroy their copies and adaptations or deliver them to the third party.
- Transfer to a U.S. government department or agency or to a prime or lower tier contractor in connection with a U.S. government contract shall be made only upon their prior written agreement to terms required by HP.

Sublicensing and Distribution: Customer may not sublicense the software or distribute copies or adaptations of the software to the public in physical media or by telecommunication without the prior written consent of HP.

Termination: HP may terminate this software license for failure to comply with any of these terms provided HP has requested Customer to correct the failure and Customer has failed to do so within thirty (30) days of such notice.

Updates and Upgrades: Customer agrees that the software does not include updates and upgrades that may be available from HP under a separate support agreement.

Export Clause: Customer agrees not to export or re-export the software or any copy or adaptation in violation of the U.S. Export Administration regulations or other applicable regulations.

Edition History

Edition 2 December 1994

Contents

1. Setting Up Your System	
What Does the Connectivity Pack Do?	1-1
What You Should Have	1-1
Connecting the Hardware	1-2
Installing the Software	1-4
Additional Set Up for Windows	1-4
About Using an HP OmniBook	1-5
Starting the Connectivity Pack	1-5
Checking the Filer's Settings	1-6
After You Install	1-8
2. Transferring Files with the Filer	
Establishing a Link between PC and Palmtop	2-2
Transferring Files between PC and Palmtop	2-3
Using the Filer with LapLink Remote Access	2-4
Communicating Palmtop to Palmtop	2-4
Backing Up Files with the Filer	2-5
Connecting a PC and a Palmtop with Modems	2-6
3. HP 200LX Applications on the PC	
Running HP 200LX Applications on the PC	3-2
Using Setup on the PC	3-3
4. Merging and Translating Files	
Merging or Synchronizing Two Files	4-1
Defining and Resolving Conflicts	4-8
Defining Conflicts	4-8
Resolving Conflicts	4-9
Translating File Formats	4-11
File Format Comparisons	4-13
Comma Delimited Format	4-13
How Appointment Book and Phone Book Fields Are Translated	4-14

How Database and Note Taker Fields Are Translated	4-16
How Different Formats Handle Appointment Types	4-17
Running Several Xlate/Merge Tasks	4-17
Running a Task List	4-17
Additional Task Lists	4-18
Recovering Data after a Task	4-18
The Log File	4-19
Backup Files	4-19
5. Using LapLink Remote Access to Link Computers	
Linking the PC and the Palmtop	5-3
Assumptions	5-3
Starting LapLink Remote Access	5-4
Using LapLink Remote Access with Other Applications	5-6
Checking the Settings for LapLink Remote Access	5-7
About LapLink Remote Access Files	5-8
Backing up Files Using LapLink Remote Access	5-9
Starting and Controlling LapLink Remote Access from DOS	5-9
Installing PC Software onto an HP Palmtop	5-12
Making an Infrared Link	5-14
Editing the TSI.INI File	5-16
LapLink Remote Access on an HP 100LX	5-17
Running LapLink Remote Access on the HP 100LX	5-18
Extra Features of LapLink Remote Access	5-19
6. Troubleshooting and Warranty	
Symptoms	6-1
Connectivity Pack Problems	6-1
LapLink Remote Access Problems	6-4
HP 100LX/200LX Problems	6-6
PC Problems	6-6
Selected Messages	6-6
Diagnostic Programs	6-9
Limited Warranty	6-9
Index	

Setting Up Your System

What Does the Connectivity Pack Do?

The Connectivity Pack turns your HP 200LX or HP 100LX Palmtop PC (a “palmtop”) into an extension of your desktop PC. It’s the answer for those times you wish you could take your PC with you when you leave your desk.

The Connectivity Pack provides two main programs:

- **HP 200LX Applications (APP200) program.** This provides PC versions of most HP 200LX applications *plus* Translate/Merge for reconciling Appointment Book, Phone Book, Database, Note Taker, and Quicken files. The Filer in the Connectivity Pack provides a communications link from the PC to the palmtop’s Filer.
- **Traveling Software’s LapLink Remote Access™ redirector.** This provides a second Connectivity Pack link. The redirector maps disk drives from the palmtop onto your PC file system. This can be more convenient than the Filer because it *directly accesses remote files* instead of merely copying them back and forth. It also provides a means to install PC software onto the palmtop.

What You Should Have

The Connectivity Pack contains three 3.5-inch disks, a serial cable, and five adapters (25-pin printer, 25-pin modem, 9-pin modem, 25-pin computer, and HP 100LX/200LX-to-HP 95LX).

You’ll need an IBM PC or compatible computer with

- A 3.5-inch, 1.44-MB disk drive.
- A 286 or higher CPU. With Windows, we recommend 386 or higher.

- 640 KB DOS RAM, and at least 450 KB of free conventional DOS memory.
- An EGA or higher display.
- A hard disk drive with 3 MB available disk space.
- An available serial port.
- MS-DOS® operating system, version 3.31 or later.
- To use Windows, you need Windows version 3.1 or later.

The APP200 program runs under DOS and does not support a mouse.

Connecting the Hardware

Option 1: To connect infrared ports:

- If your PC has an infrared port, you do not need to make a cable connection. Just align the two IR windows—maximum distance apart is 15 cm (6 in)—and go on to “Installing the Software.”

Option 2: To connect serial ports by cable:

Use the serial cable provided with the Connectivity Pack to connect your palmtop to a serial port on your PC.

1. Find a serial port on the PC—it’s either a 9-pin or 25-pin connector. If you have *more than one serial port*, try choosing COM1. (If you have a serial mouse, it is probably connected to COM1; in this case, try choosing COM2 for the Connectivity Pack.)

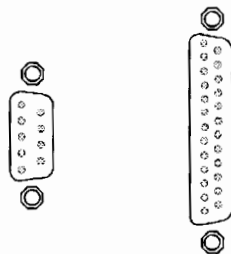

9-Pin and 25-Pin Serial Connectors on the PC

2. Connect the serial cable between the PC's serial port and the palmtop's serial port as shown in the figure below.

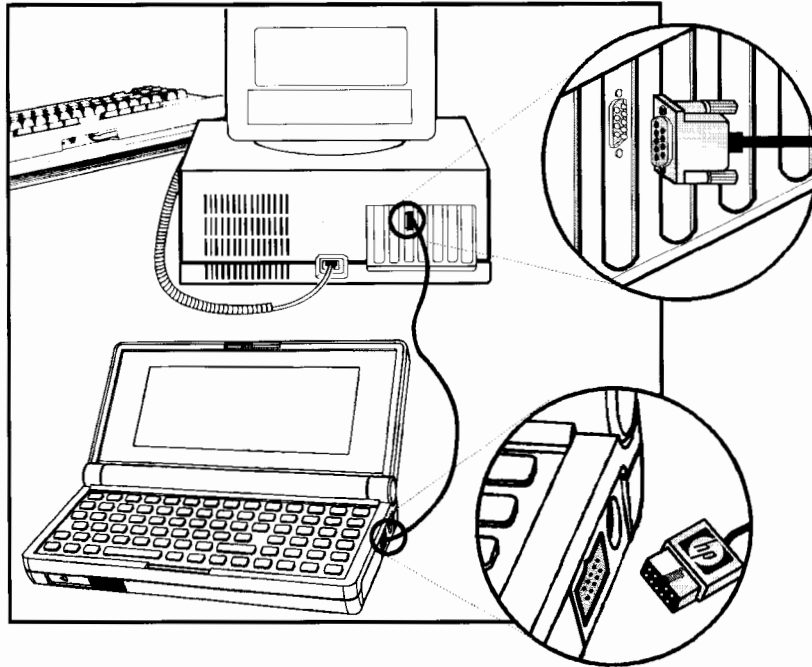

HP logo on plug faces up.

If you need to use a 25-pin adapter, first try the computer adapter (with the computer icon on it). If it does not work, try the 25-pin modem adapter (with the phone icon on it).

Beware of a parallel port or a game port—it might *look* like a 25-pin serial port, but it will not work, and it can make a connected palmtop fail.

Check your PC documentation for identification of its COM ports.

Installing the Software

This software is *not* designed to be installed onto a network drive.

To install the Connectivity Pack software onto your PC hard disk:

1. Close all applications on your PC, including Microsoft Windows. (To close Windows, select File Exit from the Program Manager menu. *Do not click on the MS-DOS icon.*) The MS-DOS prompt should be present.
2. Insert Connectivity Pack disk #1 into the drive.
3. At the DOS prompt, type

```
a:  (substitute your drive letter)
install 
```

Follow the instructions on the screen to make selections and insert disks. If you specify a different drive or directory, record the drive letter and directory name here.

.....

Additional Set Up for Windows

Windows Setup is optional. If you do *not* setup in Windows, you can run LapLink Remote Access, as well as Backup and the rest of the Connectivity Pack, from DOS.

- Setup installs LapLink Remote Access for Windows.
- Setup provides Windows icons for the Connectivity Pack, LapLink Remote Access, and the Backup feature.

To set up icons and LapLink Remote Access in Windows:

You must first install the Connectivity Pack as in the previous procedure.

1. Start Windows.
2. From the Program Manager, select the commands File Run.
3. In the text box, enter `c:\cpack200\setup` (if you changed the name of the directory, substitute it for `cpack200`).
4. Click on OK.
5. Answer the questions posed on the screen.

1-4 Setting Up Your System

To clean up your Install files:

- At the DOS prompt, from the Connectivity Pack directory (e.g. C:\CPACK200), enter
cleanup
This deletes about 220 KB of files that are no longer needed.

About Using an HP OmniBook

You should not perform this Windows Setup on an OmniBook 300 or 425. However, any OmniBook can communicate with an HP 200LX *without the Connectivity Pack*. You can communicate using LapLink Remote Access and an infrared or cable connection.

If you have OmniBook Companion software installed on your PC, you should install the Connectivity Pack with LapLink Remote Access onto Windows, and then remove the Companion's LapLink Remote Access files.

Starting the Connectivity Pack

To start the Connectivity Pack on the PC:

- In Windows, double-click on the Connectivity Pack icon.
— or —
- At the DOS prompt, change to the Connectivity Pack directory and start APP200. That is, type
cd \cpack200 (*use your own directory name*)
APP200

This does not start LapLink Remote Access. To start it, refer to chapter 5.







Checking the Filer's Settings







This section explains the correct settings for the PC and the palmtop to communicate with each other. Normally, you do *not* need to make these settings, *unless* the Install program did not or could not automatically identify your PC's COM port for communication with the palmtop.

The settings for LapLink Remote Access must be made separately. See "Checking the Settings for LapLink Remote Access" in chapter 5.

To check the palmtop's configuration settings:

1. **On the palmtop:** Start the Filer ()
2. Press    (Communications Remote-Settings).
 - Check Baud. It must be the same on both computers. We recommend 19200 to start—try higher speeds later.
 - Set Interface to COM1 (or Infrared, if appropriate). COM1 is the palmtop's serial cable (wire) port—it *does not have to match the PC's serial port*.
 - Check that Server Mode is Enabled. (This allows the palmtop to respond when the PC demands information.)
3. Press  (OK).

To check the PC's configuration settings:

1. **On the PC:** Run the Connectivity Pack:
 - In Windows, double-click on the Connectivity Pack icon.
—or—
 - At the DOS prompt, change to the Connectivity Pack directory and start APP200. That is, type
`cd \cpack200  (use your own directory name)`
`APP200 `
2. Start the Filer (press .
3. Press    (Communications Remote-Settings).
 - Set Baud to match the palmtop's Baud (as in the previous procedure). We recommend 19200 to start—try a higher speed later.
 - Set Interface to match the number of the PC's COM port that the serial cable is actually connected to (or the number of the COM port that handles infrared data—often COM3). *You might have to determine this by trial and error since ports are often unlabeled.* If you cannot successfully link the two computers

(page 2-2), then try a different Interface setting and test the link again. Try all four settings, if necessary. If there is still no successful link, try plugging the serial cable into a different serial port. (If another cable is already connected to a port, you might unplug it—at least temporarily.) For each new port, try the settings COM1 through COM4 again.

- Server Mode must be enabled.

4. Press **F10** (OK) to finish.

Note

If you are using COM3 or COM4 as the PC's serial port, you might need to confirm the address and interrupt value (IRQ). Consult the PC's documentation or your PC dealer. Then verify these settings in the Connectivity Pack's Setup program—select **Alt** Options Communications-Port.

After You Install . . .

Where to Go After Installing the Connectivity Pack

Task		Chapter
Establishing a link between PC and palmtop.	2	Transferring Files with the Filer
Establishing a link with remapped drives.	5	Using LapLink Remote Access to Link Computers
Copying and backing up files between PC and palmtop.	2	Transferring Files with the Filer
Using Appointment Book, Phone Book, Note Taker, Database, Memo, Calculator, and Setup on the PC.	3	Using HP 200LX Applications on the PC
Merging, synchronizing, or translating Appointment Book, Phone Book, Database, Note Taker, and Quicken files from different sources (PC and palmtop).	4	Merging and Translating Files
Directly accessing files on a remote computer using a redirector link.	5	Using LapLink Remote Access to Link Computers
Diagnosing problems in installing and using the Connectivity Pack.	6	Troubleshooting

Transferring Files with the Filer

You can transfer files between your PC and your palmtop using either the Filer or LapLink Remote Access.

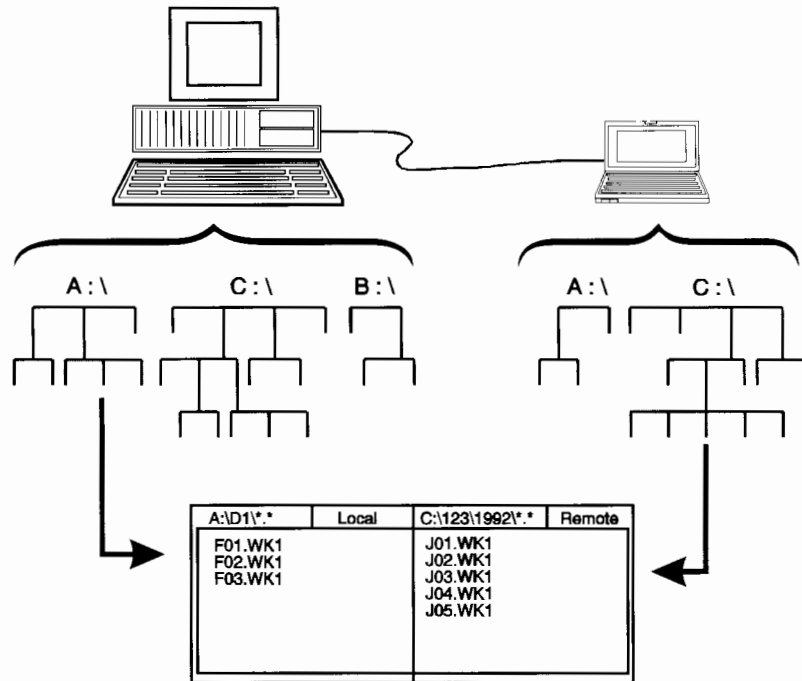

The Filer: Viewing PC and Palmtop Files on the PC

When you link to a **remote** computer using two Filers, the screen of the **local** computer displays the current directories of both







computers. The drive names are retained, so you might see two different directories with the same name (such as C:\) from different computers.



Note The palmtop's Filer uses extra power, particularly when it is maintaining an active link. Be sure to disconnect the link when you don't need it, or use an ac adapter with the palmtop.



Establishing a Link between PC and Palmtop

For this procedure you open the Filer on both computers and then work at one of the computers. Use the Filer as explained in your HP 200LX or HP 100LX *User's Guide*.

To link computers with the Filer:

1. Connect the palmtop to the PC (chapter 1).
2. **On the palmtop:** Close all applications (press    ).
3. Open the Filer on both computers:
 - **On the palmtop:** Press  to open the Filer.
 - **On the PC:** Start the Connectivity Pack and open the Filer: In Windows, click on the Connectivity Pack icon and press . Or, if you're working from DOS, enter:

```
cd \cpack200   
app200   

```

4. Choose one of the computers to work at—usually the PC. This is the **local** computer, while the other is the **remote** computer.
5. Press  (Split) to split the screen, then  (Remote) to establish a remote connection. The display shows a *local* directory and a *remote* directory—one directory from each computer.

2-2 Transferring Files with the Filer

Two separate directories with the same name, but on different computers.

C:**	Remote	C:**	Local
_BAT	<DIR>	123R24	<DIR>
		3OPEN	<DIR>
		95DEMO	<DIR>
		ANDRE	<DIR>
		ARPA_PC	<DIR>
		BACKUP	<DIR>
		BIN	<DIR>
		BLD28	<DIR>
		CCWIN	<DIR>
		COMMS	<DIR>
		CORELDRW	<DIR>
		COUGAR	<DIR>

Dirs: 1 Files: 0 Bytes: 0 Bytes Free on Disk: 299,520
Help Copy Move Filter Goto Local Full View Tree Disconn

Remote (Palmtop) and Local (PC) Windows

6. When you are done using the link, press **(F10)** (Disconn) to break the remote connection.
7. Quit the Filer on each computer when you're done.

If You Have Problems Linking

- If you have problems establishing a link, check the Filer's settings (see page 1-6).
- If the local computer displays "Remote connection broken," press **(F6)** (Remote) to reconnect. If the problem persists, try a lower baud rate.
- For more troubleshooting information, see chapter 6.

Transferring Files between PC and Palmtop

To transfer files:

1. Link the PC and the palmtop (see the previous procedure).
2. Display the *destination directory*—the place where the file will go:
 - a. Move (using arrow keys) the highlight to the window for the target computer (receiving the copy).
 - b. If the name of the desired directory isn't shown at the top of the window, change to the desired directory—highlight the directory name and press **(Enter)**, or press **(F5)** (Goto) and enter the

directory name. (For a higher level directory, highlight View Up and press **Enter**.)

3. Display the *source directory*—the place where the file *comes from*—using the same methods. (Arrow to the opposite window.)
4. Highlight the file you want to transfer.
 - To simultaneously transfer more than one file, highlight and select (press **spacebar**) each file. (A diamond will mark it.)
 - To transfer an entire directory (including subdirectories), highlight its name.
5. *Copy* (**F2**) or *Move* (**F3**) the file. (*Move* deletes the original file.)
6. When done, press **F10** (Disconn) **Menu** **Q** (Quit).

For detailed information about using the Filer, see your HP 200LX or HP 100LX *User's Guide*.

Using the Filer with LapLink Remote Access

If you link computers using LapLink Remote Access, you can still use the Filer to manage files (on all drives), *but not to establish a remote connection*. (When LapLink Remote Access is on, *it* controls the remote connection.)

Communicating Palmtop to Palmtop

If you want to communicate between two HP palmtop computers, you do not need to use the Connectivity Pack or a cable. Use the infrared ports and open the Filers.



Backing Up Files with the Filer

It's *always* a good idea to back up your data. The Connectivity Pack provides two convenient features for backing up palmtop files onto a PC, one using the Filer and one using LapLink Remote Access.

- Use the Filer to copy a whole directory (File Backup) or selected files (File Copy) from the palmtop to a PC. You specify the destination directory path each time.
- Use LapLink Remote Access to automatically back up the palmtop's entire A and C drives onto the PC. The destination directory is pre-specified. Use the DOS command 200BACK or the Backup icon. See page 5-9.

(Without using the Connectivity Pack, you can also back up your palmtop's C drive files to a plug-in memory card—drive A—using the Filer's File Backup or File Copy commands.)

To back up a palmtop directory to a PC:





The computers must be connected by cable or infrared.

1. **On the palmtop:** Close all applications (press **&...** **MENU** **A** **L**).
2. Start both the PC and palmtop Filers.
3. **On the PC:** Press **F7** (Split) and **F6** (Remote) to establish a remote connection.
4. Select the palmtop (remote) directory you want to back up. To back up the palmtop's entire C drive, press **Esc** until **C:**.*** is displayed.
5. Press **Alt** **F** **B** (File Backup).
6. Select the appropriate parameters, and press **F10** (OK).

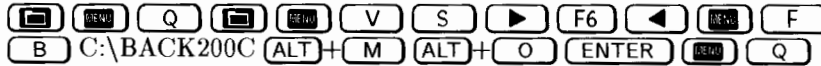
Automatically Backing Up Using Macros

Once you've used the Filer's Backup command to back up files from your palmtop, you can create a macro on your palmtop to back up just those files modified since the previous backup. For example, the following macro would back up the palmtop's entire C drive onto a backup directory (on the PC) named **C:\BACK200C**. *Remember to connect the computers and open the PC's Filer before running the macro.*



This macro opens the Filer twice to make sure it's in a known state, and selects the "Modified files only" and "Overwrite existing files" options. Before using this macro, close all applications on the palmtop (   ).



Connecting a PC and a Palmtop with Modems

The Connectivity Pack lets a PC and a palmtop communicate over great distances (but at a slow data rate) using two modems and a telephone line.

To connect a PC and a palmtop using modems:

1. Connect the PC and its modem according to the PC or modem instructions. If the PC has more than one serial port, it's simplest to use COM1—though you can use COM2, COM3, or COM4 if you need to.
2. Connect the palmtop and its modem using the card slot (for a PCMCIA modem) or the Connectivity Pack serial cable. If you need an adapter to connect the cable to the modem's serial port, try the two marked with a phone icon and included in this Connectivity Pack.

To set up the Filer for a modem connection:

- **On the palmtop:** Check the Filer's Remote Settings (  ):
 - The Interface setting must be COM1 (use COM2 for a modem card).
 - The Baud setting must be a value supported by your two modems, and must be the same for the PC, the palmtop, and the modems. (Using 2400 baud works well with many modems.)
 - The Phone Number must be the one you'll call to connect to the PC. (Numbers, spaces, hyphens, commas, and parentheses are the only valid characters.)
 - The Tone/Pulse setting must match the phone line you're using (usually Tone).

2-6 Transferring Files with the Filer

- **On the PC:** Check the Filer's Remote Settings (**Alt** **C** **R**):
 - The Interface setting must be the PC serial port where the modem is connected.
 - The Baud setting must match the palmtop's.

To be ready for a modem connection, the PC must already be running the Filer, and the PC modem must be in auto-answer mode. You can then make a connection from the palmtop end by pressing **F6** (Remote). To disconnect from a modem connection, press **F10** (Disconn).

HP 200LX Applications on the PC

The Connectivity Pack provides PC versions of the following HP 200LX applications. Except as noted below, the PC versions have the same functions as the palmtop versions (described in the HP 200LX and HP 100LX *User's Guide*).

- **Appointment Book.** This application handles files in HP 100LX/200LX format. *Alarms and timers will not be activated on the PC.*
- **HP Calculator.** The Calculator does not link to Lotus 1-2-3.
- **Database.** This application handles files in HP 100LX/200LX format.
- **Filer.** From within the Filer you cannot switch to DOS, undelete files, or format disks.
- **Memo Editor.**
- **Note Taker.**
- **Phone Book.** This application handles files in HP 100LX/200LX format.
- **Setup.** This application is modified to control PC settings for the Connectivity Pack.

The Connectivity Pack also provides two new applications, covered in the next two chapters.

Running HP 200LX Applications on the PC

To start the Connectivity Pack Applications program:

- **From Windows:** Double-click on the Connectivity Pack icon in Windows.
- or*
- **From the DOS command line:** Change to the Connectivity Pack directory and enter APP200:

```
cd \cpack200
app200
```

This displays the Application Manager, from which you can access all applications in the Connectivity Pack *except* LapLink Remote Access.

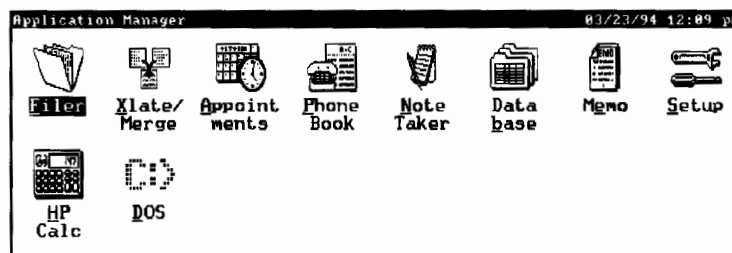

Connectivity Pack Application Manager

To start an application from the Application Manager:

- Press its underlined letter, or highlight it and press **Enter**.













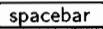

To switch between applications:

- Press **Alt** **Q** to quit the current application, then select the application you want from the Application Manager. (You must quit one application before starting another, unlike when using the palmtop.)

To exit the Connectivity Pack:

- Press **Alt** **Q** to quit the current application, then press **Alt** **Q** again to quit the Connectivity Pack.

To match HP 100LX/200LX keys to the PC:

HP 100LX/200LX	PC
	
 ZOOM	 + 
	
Calculator keys	same positions ( ,  ,
	 ,  ,  ,  ,  , 

Using Setup on the PC

The Setup application controls settings for the Connectivity Pack. Some of the commands are different from those in the HP 200LX Setup application.

Note The Connectivity Pack settings on the PC are independent of settings on the palmtop.

After starting the Setup application, select  Options to access these commands:

- **Display.** This adjusts the screen colors used by the Connectivity Pack.
- **Printer.** This sets the printer settings for the Connectivity Pack.
- **Communications Port.** This sets the COM3 and COM4 port address and interrupts for the Filer—use these only if you are using COM3 or COM4 for your PC's Filer communications port. (This is not for LapLink Remote Access.)
- **Date/Time.** This sets the date and time formats. *You must set the PC's current date and time using a DOS or Windows utility.*
- **International.** This sets the numeric punctuation and the currency symbol.

Merging and Translating Files

The Xlate/Merge utility can **merge** two files, **synchronize** (make identical) two files, or **translate** a file (HP 95LX or Comma Delimited file into HP 100LX/200LX format).

You can use Xlate/Merge with Appointment Book, Phone Book, Pocket Quicken, Database, or Note Taker files.

Merging or Synchronizing Two Files

You can merge or synchronize palmtop and PC files periodically to make them agree.

- Merge** Merges one file into another of the same type, producing one merged file and one unchanged file. It does not duplicate identical records, and it flags conflicting records, whose fate you can decide. You can specify what constitutes a conflict.
- Synchronize** Compares two files of the same type and updates both files (by adding and deleting records), producing *two, identical files*. Like Merge, it flags conflicting records, allowing you to see and decide what to do about every difference between the files. You specify what constitutes a conflict.



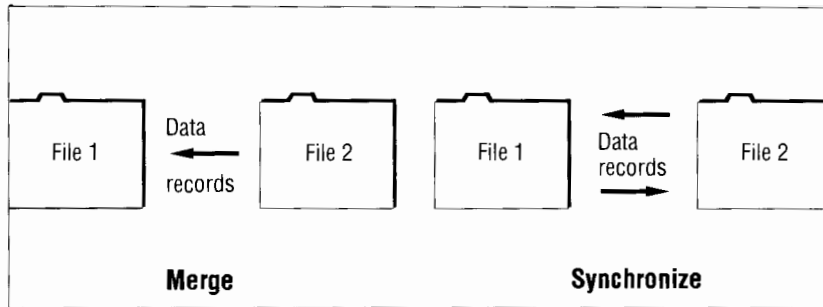

You can merge or synchronize like files of these types:

File Types for Merging and Synchronizing

File Type	Extension/Format
Appointment Book	.ADB
Database	.GDB
Note Taker	.NDB
Phone Book	.PDB
Pocket Quicken	.PDT
Quicken (desktop)	.QDT

You *cannot* merge or synchronize HP 95LX and Comma Delimited files—translate them to HP 100LX/200LX format first.

A Pocket Quicken (.PDT) file can combine with another .PDT file or with a DOS or Windows desktop Quicken (.QDT) file. A .QDT file can combine only with a .PDT file.

4-2 Merging and Translating Files

Prerequisites for Merging or Synchronizing

- Make sure both files are on the PC. If one file is on the palmtop, then use the Filer to transfer it to the PC. (Or, use LapLink Remote Access to access a remote file.)
- *Except for Quicken files*, both files must have the same format, that is, the same file extension. If they do not, **Translate** one of them first. However, you do *not* need to translate HP 95LX files, since they are translated automatically when you open them in the Connectivity Pack or another palmtop.
- The files to merge or synchronize must be closed. That is, quit any application whose files will be merged or synchronized.
- The files may be password-protected, but *Quicken source files must have the same password*.

To merge or synchronize two files:

1. From the Application Manager (the icons screen) of the Connectivity Pack (on the PC), press **[X]** to start the Xlate/Merge application.
2. Press **[F2]** (Add) to specify the task you want to perform.

If the task you want to perform already appears in the task list, you don't need to add it. Just select it and run it. Remember that the task definition includes information on file names and conflict definition/resolution.

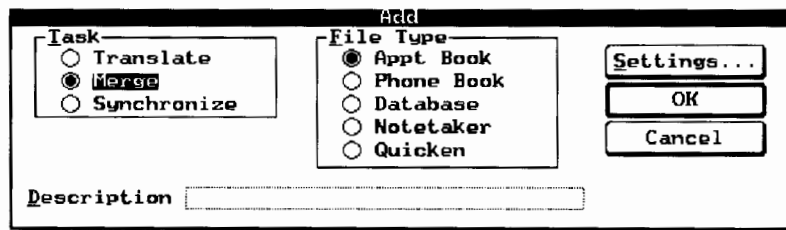

Dialog Box to Add a Task

- Select the Task. (Arrow among buttons; tab among fields.)
- Select the File Type.
- Optional: Enter a Description for the task.

3. Press **F8** to specify the Settings.
 - File names for input and output—press **F6** and **F7**.
 - Conflict Definition and Conflict Resolution—in most cases, you can accept the default settings.

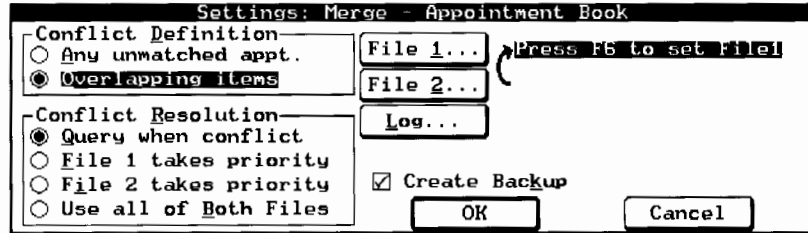

Dialog Box to Specify Settings

The tables below define the settings.

4. Press **F10 F10** to save the settings and the task definition.
5. Press **F6** to run the task.
 - To interrupt and cancel a task, press **Esc**.
 - For a Synchronize task or a Merge task with a **Query** conflict resolution, you will see a screen for each unmatched or conflicting record. You then select which record (or neither or both) to put into the output file(s). See “Defining and Resolving Conflicts,” the next section.
6. To save this task definition for periodic use, answer “Yes” at the “Save changes?” dialog box when you quit Xlate/Merge.
7. To close the application, press **Alt Q**.

4-4 Merging and Translating Files

**Merge and Synchronize Settings:
Appointment Book, Phone Book, Database, Note Taker**

Setting	Description
File1	First input file. Modified by both Merge and Synchronize.
File2	Second input file. Modified by Synchronize only.
Log	Optional file to record all conflicts and their resolutions.
Create Backup	Back up File1 (Merge) or both files (Sync) as <i>filename.xx</i> \$.
Conflict Definition	What the program will identify as a conflict.
Conflict Resolution	Which records the program will choose in case of conflict, or whether to let you decide case by case.

**Merge and Synchronize Settings:
Quicken**

Setting	Description
File1	First input file. Modified by both Merge and Synchronize.
File2	Second input file. Modified by Synchronize only.
Log	Optional file to record all conflicts and their resolutions.
Create Backup	Back up File1 (Merge) or both files (Sync) as <i>filename.PD</i> \$ (Pocket Quicken) or <i>filename.QD</i> \$ (desktop Quicken). This also backs up auxiliary desktop Quicken files as <i>filename.\$DT</i> , <i>.\$DL</i> , <i>.\$MT</i> , <i>.\$NX</i> , and <i>.\$ST</i> .
Months to Merge	How many months to merge from File2 into File1, counting from the present backwards. A blank field means all months. A balance-forward transaction replaces any deleted transactions in each account.
Months to Keep	How many months to retain (Synchronize) in the Pocket Quicken file (.PDT), counting from the present backwards. Older transactions are deleted. This keeps the Pocket Quicken file from getting too big. A blank field means all months.
Keep prior uncleared transactions	Keep uncleared transactions even if they are prior to the "Months to Keep" cut-off date.
Conflict Definition	"Similar, not identical" is the only choice.
Conflict Resolution	Which records the program will choose in case of conflict, or whether to let you decide case by case.

Example: Synchronizing Two Appointment Books. Suppose you maintain two Appointment Books: one on a palmtop, which you carry with you, and one on a PC (with the Connectivity Pack), which stays in the office. Once a week you reconcile the two by running a Synchronize task. You synchronize (rather than merge) the files so that you can maintain two Appointment Book files. You want to review every discrepancy (including additions and deletions) between the two files.

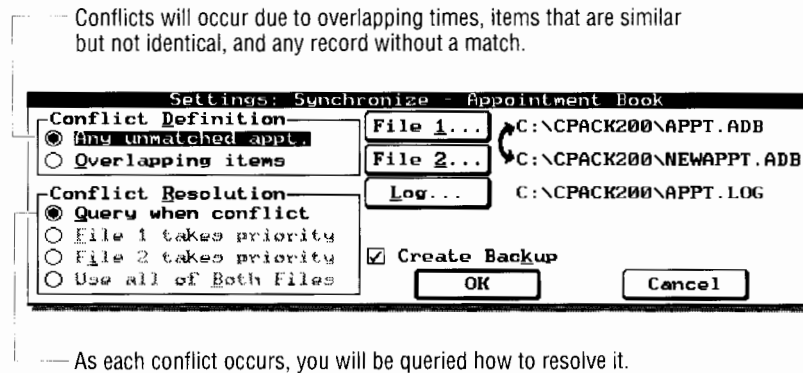

Example: Merging Two Phone Books. Suppose you want to augment your Phone Book file (MYPHONE.PDB) with entries that a co-worker has in her Phone Book (HERPHONE.PDB). You don't need to review every new record in HERPHONE.PDB, and you don't need to update it, so you merge (rather than synchronize) HERPHONE.PDB into MYPHONE.PDB. The net effect is to add new entries to MYPHONE.PDB but leave HERPHONE.PDB *unchanged*. When there is an actual discrepancy between the two files, such as the same name appearing with different phone numbers, you want to always keep the record from MYPHONE.PDB, since you know that all the information in your Phone Book is correct.

4-6 Merging and Translating Files

Only discrepancies between two records will cause a conflict.

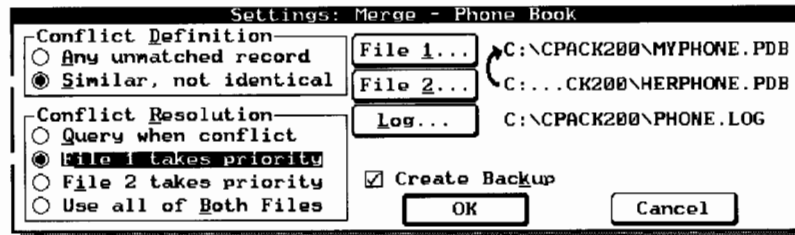

For any conflict, keep the record as it is in MYPHONE file.

Example: Synchronizing Two Quicken Files. Suppose you maintain two Quicken files, one on your palmtop (file QDATA.PDT) and one on your PC (file QDATA.QDT). In order to update them and make them consistent with each other, you run a Synchronize task on them weekly. Any new transactions in one file should be automatically added to the other file. You want to review each pair of conflicting records.

In order to limit the size of the Pocket Quicken file (since available disk memory is much lower on the HP 200LX than on a PC), the oldest transactions in the Pocket Quicken file will be deleted. By default, Synchronize will save only the three most recent months of transactions in the palmtop file, but it will also save any transactions that have not yet been cleared. A balance-forward transaction replaces the deleted transactions in each account.

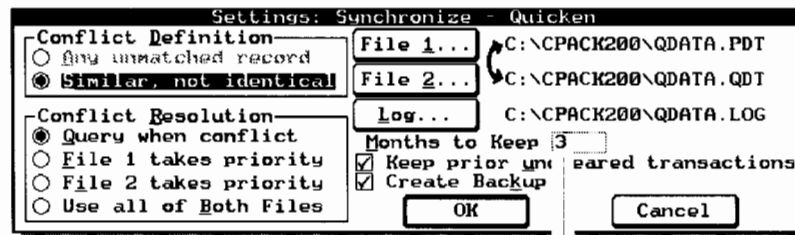

Keep the last 3 months in the Pocket Quicken file.

Example: Using Merge to Translate a Desktop Quicken File. If you've been using Quicken on your PC and now want to use that file on your palmtop, you'll need to translate it first. To do this, first create an empty Pocket Quicken file and then copy it to the PC (using the Connectivity Pack). Then *merge* your desktop Quicken file (File2) into the empty Pocket Quicken file (File1). The net effect is to convert File2 (a .QDT file) into the format of File1 (a .PDT file). You can open the .PDT file on the palmtop.

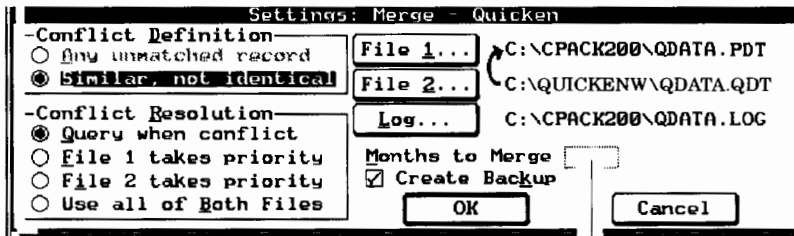

Leave blank to merge all months from File2.

Defining and Resolving Conflicts

Merge and Synchronize tasks define and resolve conflicts between the two files being combined.

Defining Conflicts

The following table defines the types of conflicts you can specify.

Conflict Definitions

File Type	Conflict	Meaning
Appointment Book	Overlapping items Any unmatched appt.	Two appts whose Time durations overlap. Same as above, plus: <ul style="list-style-type: none"> ■ Two non-identical appts, events, or to-do items whose Description fields <i>do</i> match. ■ Any record that does not appear in both files.
Database Note Taker Phone Book	Similar, not identical Any unmatched record	Two non-identical records whose first fields (e.g. Name in Phone Book, Title in Note Taker) <i>do</i> match. Same as above, plus: <ul style="list-style-type: none"> ■ Any record that does not appear in both files.
Pocket Quicken	Similar, not identical	Two transactions that differ in <i>only one or two</i> of these fields: Check#, Payee, Amount, Memo, Cleared Status, Date, or Categories/Splits.



Merge and Synchronize do *not* detect conflicts or duplicate records *within a file* (if one file has overlapping appointments within itself, for example).

When Merge or Synchronize detects identical records (those in which all fields are exactly the same by case-sensitive comparison), it puts only one of the records into the output file.

Resolving Conflicts

If your choice for Conflict Resolution is “Query when conflict,” then you will be asked to choose which of two conflicting records to keep in the output file, or whether to keep a record that has no match in the other file.

A typical Query screen for you to review looks like this:

---Fields that differ appear in boldface.

	File 1=C:\...K200\APPT.ADB	File 2=C:\...0\NEMAPPT.ADB
Description	Dentist	Staff Meeting
Start Time	10:00am	10:00am
End Time	10:30am	11:00am
Start Date	3/11/1994	3/11/1994
Location		
Alarm	Enabled	Enabled
Leadline	5	5
No. Consecutive Days	1	1
Shows in Week/Month	Yes/Yes	Yes/Yes
Repeat Status	None	None
Note		

Keep which record ?

A Query Screen: Conflicting Records

- A pair of boldface entries (indicating a difference) can look the same if their difference is hidden. For example, these two cases would appear the same but be in boldface: (1) a Weekly Repeat Status that is really bi-weekly in one case; (2) a difference that occurs after the first 20 characters of the field.
- Select which input record to put into the output file(s): from File1, File2, Both, or Neither. When in doubt, select Both and then examine those records more fully later, either in the output file or in the log file.
- If there is a conflict due to an unmatched record (“no corresponding record”), your choice is to keep (“Add”) or remove (“Delete”) that record.
- To interrupt or cancel the entire task, press **[Esc]**.

Example: Two Repeating Appointments That Conflict. Suppose you are merging two appointment files and are queried to resolve a conflict between two repeating appointments: File1 has a weekly staff meeting Mondays from 9:00-10:00, and File2 has a weekly vendor delivery at 9:30.

Since you don't need to be on hand for the delivery, you select “Both” to put both records into your merged file. Since a repeating appointment that conflicts once can conflict again (and in this case certainly will), you then will be queried how to handle future occurrences of the appointment from File2. (You are not queried about the File1 appointment because File1 is the “base” file against which File2's appointments are matched.)

4-10 Merging and Translating Files

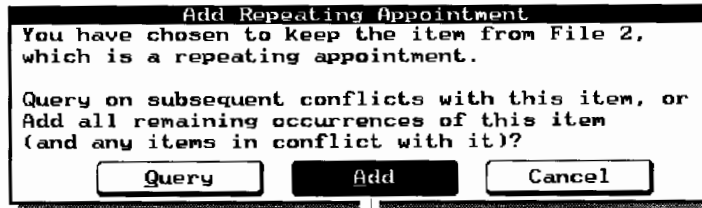

Select Add to add all future (overlapping) occurrences of this item *without* querying.

Translating File Formats

You can Translate an Appointment Book, Phone Book, Database, or Note Taker file between **HP 100LX/200LX format** and **Comma Delimited (CD) format**, a basic format that most software can interpret. (To translate Quicken files, see page 4-8.)

In this way, you can convert files from other appointment and database programs that are Comma Delimited-compatible to files that you can use on an HP 100LX/200LX (and vice-versa).

In addition, you can translate HP 95LX Appointment Book and Phone Book files between the HP 100LX/200LX format or the Comma Delimited format.

For specifications, see the next section, "File Format Comparisons."

To translate a file to another format:

You cannot translate a password-protected file.

1. Make sure the file to be translated is closed. (Applications Close-All).
2. In the Connectivity Pack (on the PC), press to start Xlate/Merge.
3. Press (Add) and specify the translation you want to perform:
 - Select Translate in the Task box.
 - Select the File Type.
 - Optional: Enter a Description for the task.

(If the task you want to perform already appears in the task list, you don't need to **add** it. Just select it and run it.)

4. Press **F8** and specify the Settings:
 - In the File Formats box, specify the format of the source (input) file and the format you want to end up with as the target (output).
 - Specify the name of the source file. Give the target file a name. Note that only in the case of a .CDF to .GDB or .NDB translation must the target file already exist. (Use a dummy .GDB or .NDB file to provide a template for the translation.) The log file is optional. You can use the F-keys to name files.
 - Optional: Check the Field Mappings (**F8**) between the two formats for the task. To change any mapping, highlight the field and press **F7** (Remap). Remapping is important when translating from a format with more fields (like HP 100LX/200LX) to a format with fewer (like HP 95LX or Comma Delimited). For instance, if you were translating an Appointment Book file from an HP 200LX to a Comma Delimited file, you could remap the Location field to Field 3. Any data that had been in the Location field would then appear in Field 3. On the other hand, if you selected <UNMAP>, the data would not be translated.
5. Save the settings and the task definition (**F10 F10**), then run the task (**F6**). To interrupt and cancel a task, press **Esc**.
6. To save this task definition for periodic use, answer "Yes" at the "Save changes?" dialog box when you quit Xlate/Merge.

To translate a HP 95LX file to a HP 100LX/200LX file:

- The fastest way to translate HP 95LX Appointment Book and Phone Book files into HP 100LX/200LX format is to use the File Open command in the Appointment Book or Phone Book. **Alt** File Open automatically translates a HP 95LX file before opening it.

File Format Comparisons

Translate recognizes the following default file extensions.

Formats by File Extension

File Extension	Description
.ABK	HP 95LX Appointment Book file.
.ADB	HP 100LX/200LX Appointment Book file (.AD\$ is its backup file for Synchronize or Merge).
.CDF	Comma Delimited data file (for any database, including phone-type records and note records).
.CDS	Comma Delimited schedule file (appointments and events). (An .ABK or .ADB file translates into two Comma Delimited files: .CDS + .CDT.)
.CDT	Comma Delimited to-do item file.
.GDB	HP 100LX/200LX Database file.
.LOG	Log file from a Merge, Synchronize, or Translate task.
.NDB	HP 100LX/200LX Note Taker file.
.PBK	HP 95LX Phone Book file.
.PDB	HP 200LX or HP 100LX Phone Book file (.PD\$ is its backup file for Synchronize or Merge).
.TMG	Task manager (task list) file for Xlate/Merge.

Comma Delimited Format

The Comma Delimited format is used by many programs. In Comma Delimited files,

- Fields are separated by commas.
- Field contents are enclosed in quotation marks.
- An empty or unmapped field remains empty when translated.
- The order of the fields is significant. Translation suppresses empty fields at the end of each record. The Comma Delimited order for

appointment and phone records matches the order of fields in the following tables. For to-do items, the Comma Delimited order is Priority, Description, Note, Start Date, checkoff status, checkoff date, carry-forward status, an empty field, and Due Date.

- Dates use the YYYYMMDD (year/month/day) format, and times use the HHMM (24-hour/minute) format. (An appointment Start Time of 1:00 pm would be entered as "1300", and a 5 minute Leadtime would be entered as "1255".)
- Check boxes are given a value of 1 if checked and 0 if not checked.

An example of a phone-type record in Comma Delimited format ready to be translated into HP 100LX/200LX format would be:

```
"Smith, John",, "(503) 757-2000",,,  
"(503) 757-0000", "Sales Mgr",,  
"Indispensable Products",  
"1000 Tangent Cir",,  
"Corvallis", "OR", "97333",  
"not in on Fridays"
```

Two commas in a row represent an empty field. The order of fields above is:

Name (last, first), Business phone, (no Home phone), (no Alternate phone), Fax phone, Title, (no Category), Company, Address1, (no Address2), City, State, Zip, Note

How Appointment Book and Phone Book Fields Are Translated

The following tables list how Translate interprets the fields it encounters in HP 100LX/200LX, HP 95LX, and Comma Delimited files for the Appointment Book and the Phone Book. If you translate a file and find that it's missing data, compare the characteristics of the fields of the source and target files to find the discrepancy.

Supported Phone Book Fields

Format	Data Fields	Max. Length	Other
palmtop	Name	86 characters	Maximum note length is 32 KB, but when translated the note will be truncated to the first 512 bytes.
	Business Phone	29 characters	
	Home Phone	29 characters	
	Alternate Phone	29 characters	
	Fax Phone	29 characters	
	Title	38 characters	
	Category	127 characters	
	Company	82 characters	
	Address Line 1	82 characters	
	Address Line 2	82 characters	
	City	34 characters	
	State	39 characters	
	Zip Code	16 characters	
Notes	Up to 32 KB		
HP 95LX	Name	30 characters	The HP 95LX's Address field can contain up to 9 fields within it, in the order and arrangement shown. Fields not shown are not translated. Fax and Home numbers are included <i>only</i> if preceded by +f- or +h- in the HP 95LX version. Max. file size 44 KB.
	Business Phone	8 lines (320 chars)	
	Address		
	•[+f-Fax phone]		
	•[+h-Home phone]		
	•Title		
	•Company		
	•Street Address		
	•City, State		
	•Zip		
•Notes			
Comma Delimited	Field 1 to Field 25	Max. file size limited by available disk space.	CD fields correspond in order to palmtop fields. Additional fields aren't mapped, but can be.

Supported Appointment Book Fields

Format	Data Fields	Max. Length	Other
HP 100LX/ HP 200LX	Start Date Start Time End Time Alarm Lead Time Description Note Location End Date Week View Month View	5 digits 51 characters 32 KB of text 19 characters	Maximum note length is 32 KB, but when translated the note will be truncated to the first 512 bytes. File size limited by available disk space; max. 5000 records.
HP 95LX	Date Start Time End Time Alarm Lead Time Appointment Note	27 characters 11 lines (440 chars.)	Max. file size 44 KB.
Comma Delimited	Field 1 to Field 25	Maximum file size limited by available disk space.	CD fields correspond directly to palmtop fields. Additional fields aren't mapped, but can be.

How Database and Note Taker Fields Are Translated

The translation of Database and Note Taker files can take place between HP 100LX/200LX format and Comma Delimited format only.

- All fields can have up to 255 characters for translation. Exception: the Note field is limited to 2 K characters.
- An entire record can have up to 31 KB for translation to palmtop format.
- The translation of a database file does not alter the source file. If there is information that does not fit into the template of the target file, then that information is ignored.
- A carriage return with linefeed (CRLF) in the Note field of a HP 100LX/200LX formatted file is translated to a Tab character in Comma Delimited format; a Tab in the Note field of a Comma Delimited file is translated to CRLF in HP 100LX/200LX format.

4-16 Merging and Translating Files

How Different Formats Handle Appointment Types

The HP 95LX and Comma Delimited formats cannot distinguish as many different types of appointments and to-do items as the HP 100LX/200LX format can. So if you translate *from* the HP 100LX/200LX format, certain types of items will be folded into broader categories (sometimes overwriting other information).

HP 95LX	Does <i>not</i> support Daily repeating appointments, Custom repeating appointments, Yearly repeating-by-position appointments, any Frequency (other than 1), or any repeating to-do items. For the HP 95LX format, these types of repeating items will be translated into multiple, individual occurrences.
Comma Delimited	Supports <i>only</i> individual occurrences of appointments, events, and to-do items. Repeating items translated into Comma Delimited format become multiple, individual occurrences.

Running Several Xlate/Merge Tasks



Running a Task List

You can keep up to ten task descriptions in a Xlate/Merge task list. You can then run more than one task at once by **selecting** each task to run.

For example, you might run several tasks *with the same files* periodically, such as weekly synchronizing two Appointment Book files (PC and palmtop), synchronizing two Quicken files (PC and palmtop), and merging two constantly changing database files (from separate sales representatives).

- To edit a task, highlight it and press **Enter**.
- To run a task, highlight it and press **F6**.
- To run all the tasks in a list, press **F4** (Run All).
- To run several tasks in a batch, first select each one (highlight it and press **spacebar**—a ♦ shows it's been selected).

Additional Task Lists

If you want to save more than ten tasks, or you want to save separate task lists, then you can open and save a new .TMG (task manager) file. If you select any tasks, these selections (◆) are also saved in the file.

- To start a new task list, select (Alt) File New.
- To save the current task list, select (Alt) File Save.
- To rename the current task list, select (Alt) File Save-As.
- To edit or run a particular task list that is not current, select (Alt) File Open to display that list.
- To rearrange the order of tasks in a task list, use Cut, Copy, and Paste ((F8), (F9), (F10)).

Task List Function Keys

Key Label	Description
Add	Displays dialog box to define a new task.
Run All	Runs all the tasks in the current list.
Run	Runs the current (highlighted) task <i>or</i> all selected tasks (those marked with ◆).
Cut	Deletes the highlighted task and copies it into the Clipboard.
Copy	Copies the highlighted task into the Clipboard.
Paste	Copies the task from the Clipboard to the current position.

Recovering Data after a Task

Occasionally a merge, synchronization, or translation task might appear to lose or improperly transfer data. For example, if you translate a file to a format with fewer fields or shorter field lengths, some of the original data might be truncated, reorganized, or simply not translated. To diagnose this situation, examine the log file. To recover the original data, use a backup file.

The Log File

A log file records any conflicts (and their resolutions) encountered during a Merge, Synchronize, or Translate task. You can open the log file in the Connectivity Pack's Memo Editor or in another text editor.

20 characters of path name.

```
Memo: APPT.LOG
MODIFIED INSEET ASCII
03/11/94 11:49 am
LINE: 9 COL: 62
Legend:
* -> Fields that are different
!* -> Fields that are different, but appear the same in the log file

      C:\CPACK200\APPT.ADB  C:\...200\NEWAPPT.ADB
* Description  Vendor Delivery  Staff Meeting  Both
Start Time    9:00am           9:00am
End Time      10:00am           10:00am

  Help  Bold  Underline  Find  Find&Rep  PrintField  Promote  Demote  Opz  Save
  F1    F2    F3         F4    F5        F6         F7       F8     F9   F10

Field names.      20 characters of data.      Conflict resolution.
```

A Log File for a Synchronize Task

Backup Files

Backup files let you recover the source data from a Merge, Synchronize, or Translate task. In the Filer, you can copy or rename a backup file.

- Merge backs up its *File1* and Synchronize backs up its *File1* and *File2* if you check the Create Backup checkbox. The files are named *File1.xx\$* and *File2.xx\$*, where *xx* is the first two letters of the original's file extension. For instance, a Pocket Quicken file is backed up as *filename.PD\$*.
- Merge does not alter its *File2* and Translate does not alter its source file.
- Desktop Quicken has auxiliary files that are also backed up by Merge and Synchronize. These backup files are named *filename.\$DI*, *filename.\$MT*, *filename.\$NX*, and *filename.\$ST*. In order to use the backed-up version of a desktop Quicken file, you must have copies of *all the backed-up auxiliary files* in the same directory, as well.

Using LapLink Remote Access to Link Computers

LapLink Remote Access creates a special kind of link called a **redirector**. With a redirector link, you have direct access to all of the files on your palmtop while working at your PC.

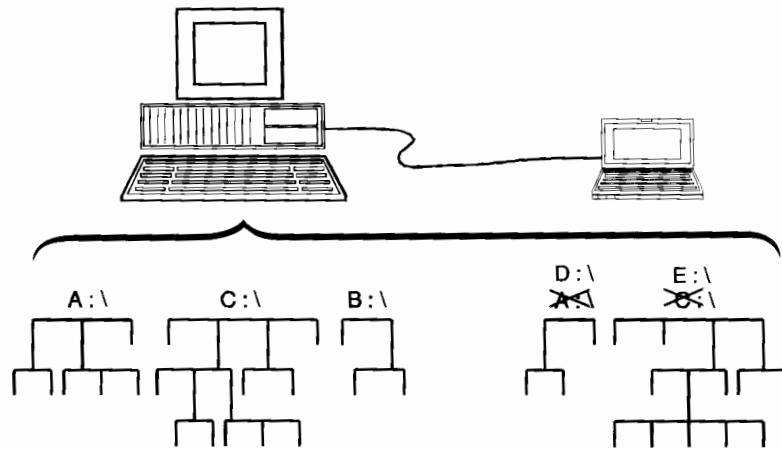

LapLink Remote Access: Accessing Palmtop Files via the PC

A remote link consumes extra power. To conserve power, the palmtop times out after 5 minutes (default value) of inactivity, breaking the link. You can use an ac adapter with the palmtop to preserve the link and save battery power.

The following chart shows how LapLink Remote Access could map new drive letters onto the PC for the palmtop drives.

Typical Drive Mappings Using LapLink Remote Access

PC Drive	Location on PC	Location on Palmtop
A	flexible disk	
B	flexible disk	
C	hard disk	
D	→	drive A (card slot)
E	→	drive C (RAM disk)
F	→	drive D (ROM disk—read only)
G	→	drive E (another name for A)

In this example, you can say that the PC's drive D "maps to" drive A on the palmtop. It has been **redirected**. So you can use drive D on the PC to read a plug-in card in the palmtop's drive A.

Example: Sharing Files. You can use LapLink Remote Access while working at your PC to directly open database (or appointment or Quicken) files from your palmtop without first copying them to your PC.

Example: Installing Software. You can install a new application on your palmtop, even though the software comes on flexible disks. You link the PC and the palmtop with LapLink Remote Access, then work at the palmtop. You insert the software installation disk into the PC's drive, but perform the installation steps on the palmtop.

Example: Using Windows File Manager for PC and Palmtop Files. You can use the same PC file manager—say, Windows File Manager—for your palmtop files and your PC files if you link the two computers with LapLink Remote Access.

Example: Using an OmniBook. An HP OmniBook can communicate with an HP 200LX *without the Connectivity Pack*. You can communicate using LapLink Remote Access and an infrared or cable connection. You can also communicate with an HP 100LX in this way if you first install LapLink Remote Access onto the HP 100LX (as explained later in this chapter).

5-2 Using LapLink Remote Access to Link Computers

Linking the PC and the Palmtop

Assumptions



- **Windows versus DOS.** This section assumes you are using Windows in Enhanced mode on your PC to run LapLink Remote Access. If you are not running Windows or you are running Windows in Standard mode, then you should run LapLink Remote Access from the DOS command line. Refer to “Starting and Controlling LapLink Remote Access from DOS,” later in this chapter.
- **Serial versus infrared link.** This section assumes you are using the serial cable included with the Connectivity Pack. However, you can use a cable-free, infrared connection if your PC has an infrared port (as some HP Vectras and all HP OmniBooks and palmtops have). Refer to “Making an Infrared Link,” later in this chapter.
- **HP 100LX.** This section assumes you are using an HP 200LX, which comes with LapLink Remote Access installed. If you are using an HP 100LX, you must first install LapLink Remote Access. Refer to “LapLink Remote Access on an HP 100LX,” later in this chapter.
- **Palmtop in client mode.** This section assumes you are using the LapLink Remote Access Server application on the HP 200LX, giving directions from the PC to the palmtop. If you want to use the HP 200LX in **client mode** (giving directions from the palmtop to the PC), refer to “Starting and Controlling LapLink Remote Access from DOS,” later in this chapter.

Note

While the palmtop's LapLink Remote Access application is open, the palmtop is locked in server mode: It responds only to the PC, and most of the keyboard is inactive. *No alarms will go off* and you cannot switch to another application.

Starting LapLink Remote Access

To establish the link:

1. **On the palmtop:** Select the LapLink Remote Access Server ( ).

In this situation, the palmtop functions as a **file server** for the PC; that is, it acts like a set of disk drives. The palmtop *cannot* be the controlling computer (unless you run LapLink Remote Access from the DOS command line).

2. **On the PC:** Quit any open applications, *including the Connectivity Pack*. In Windows, double-click on the LapLink Remote Access icon. This opens the LapLink Remote Access window and turns on its communications link. (The On/Off switch should appear ON.)

The computers chime when the connection is made. Messages confirm the status of the link.

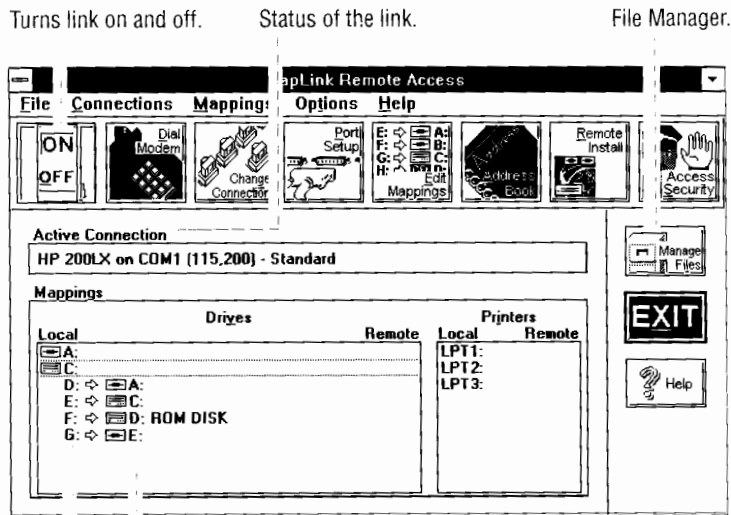

PC drives. Corresponding palmtop drives.

PC: LapLink Remote Access Window

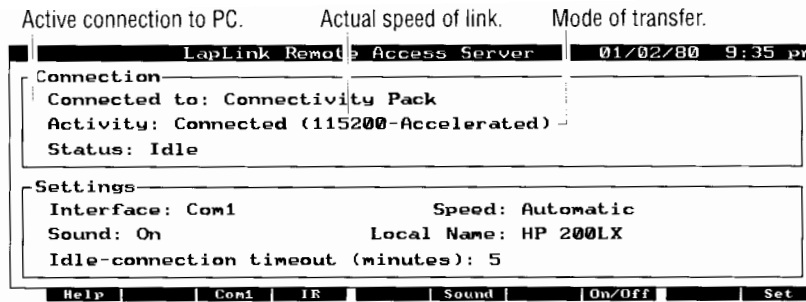

Palmtop: LapLink Remote Access Status

If the palmtop is not using an ac adapter, then it stops trying to make a link after 3 minutes without success.



If you have trouble making the link:

- See "Checking the Settings for LapLink Remote Access," page 5-7.
- Refer to chapter 6, Troubleshooting, under "LapLink Remote Access Problems."

To break the link:

To regain use of the HP 200LX, you must break the link.

Caution Don't break the link while the connection is being used. If you do so while a file is being transferred, the resulting file will be unusable.

- **On the palmtop:** Quit LapLink Remote Access Server ( ). The computers chime when the link is disconnected.
- **On the PC:** In the LapLink Remote Access window, click the On/Off button to "Off", or click on the Exit button. (The main LapLink Remote Access program continues to run in the background as a TSR (memory-resident) program.)

If you break the link from the palmtop side *only*, when you re-start LapLink Remote Access from the palmtop (HP 200LX Server), *the PC must be in Windows*, not in a DOS environment.

Using LapLink Remote Access with Other Applications

With the redirector, the PC can access the palmtop's drives as if they were its own. So you can use *any* application on the PC and specify a compatible file on the palmtop. For example, you could run a Merge task on the PC, specifying one file from a PC drive and the other file from a remote palmtop drive (remapped to the PC).

For general file management, you can use either the Connectivity Pack's Filer or Windows' File Manager. However, you cannot start a remote Filer connection while LapLink Remote Access is active.

Note To use LapLink Remote Access with other Connectivity Pack applications, you must first start LapLink Remote Access, *then* start the Connectivity Pack.

To use the Connectivity Pack with remote drives:

1. Start LapLink Remote Access on both the PC and the palmtop and wait for the connection, if necessary.
2. Note the drive mappings so you will know how to designate the remote drive you want.
3. Move or minimize (upper right-hand arrow button) the LapLink Remote Access window so that you can access the Connectivity Pack window. Or, press **(Alt)+(TAB)** to cycle to another open program. *Do not close or exit the LapLink Remote Access window;* this would break the redirector link.
4. Double-click on the Connectivity Pack icon and open the application you want. When you specify a file to open, be sure to use the drive designations you noted in step 2.

To access the Windows File Manager with remote drives:

1. Start LapLink Remote Access on both the PC and the palmtop, if necessary.
2. Note the drive mappings so you will know how to designate the remote drive you want.
3. Click on the Manage Files box.
4. You can now move, copy, delete, and otherwise manage files using the remote drive designations you noted in step 2.

5-6 Using LapLink Remote Access to Link Computers

Example: Accessing the Palmtop's Appointment Book Remotely.

First close the *Appointment Book* on the palmtop, so that no appointment file is open during data transfer. After starting LapLink Remote Access on both computers, start the Connectivity Pack on the PC, open the Appointment Book, select (Alt) File Open, and specify F:_DAT\APPT.ADB to retrieve this appointment file from the palmtop's C drive (assuming that the PC's drive F maps to the palmtop's drive C).

Checking the Settings for LapLink Remote Access

To check the settings on the HP 200LX:

- Press (Ctrl) (R) to display the LapLink Remote Access Server screen. You can change the settings by pressing (F10) (Set) to display the Settings screen. Some settings also have F-keys. Unless you want to link via the infrared port, you can accept the default values.

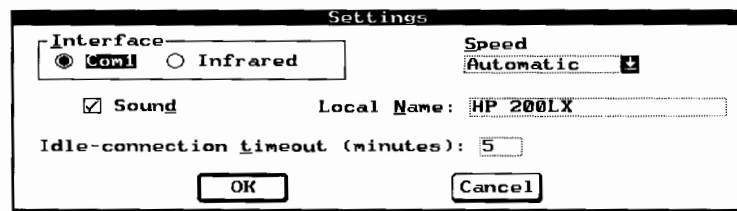

Palmtop: LapLink Remote Access Settings Screen

- Interface: Com1 for serial cable; Infrared for IR.
- Speed: Automatic will select the fastest available baud—for COM1 only.
- Sound: whether to sound a chime when a link is made or broken.
- Local Name: how the PC identifies the palmtop.
- Idle-connection timeout: how long the link can be unused before it automatically disconnects itself. To save battery power, set a short timeout.

To check the settings on the PC:

- In Windows, double-click on the LapLink Remote Access icon. From the Options menu, you can make the same settings as on the palmtop: Port Setup (interface types), Computer Name, Sound, and Timeouts.
- The port you want to use should already be enabled as a result of the installation. If not, highlight the port you want, specify Serial in the Type box, and check the Enable Port checkbox. (Specify Serial even for an infrared link, unless the PC is an HP OmniBook.)
- The Speed setting is under Port-Setup Advanced. The default is Automatic, as on the palmtop. “Automatic” selects the fastest available baud.

To change the settings without Windows, you must edit the TSI.INI file (later in this chapter).

About LapLink Remote Access Files

LapLink Remote Access supplies several batch files to create a communications link from PC to palmtop with a redirector. It includes several **TSR** (*terminate and stay resident*) programs, which remain resident in system memory while you open other software applications. This allows LapLink Remote Access to work in the background, maintaining the communications link and redirecting disk drives.

There are two ways to run LapLink Remote Access on the PC—from Windows and from DOS. If you have a choice, we recommend running it from Windows, because it requires much less conventional DOS memory (8 KB versus about 100 KB).

Backing up Files Using LapLink Remote Access

You can use the Connectivity Pack Backup icon to back up both the A and C drives from the palmtop to the PC. The backed-up files are copied into C:\CPACK200\BACKUP_A and BACKUP_C. To use this feature, the PC and the palmtop must be linked by LapLink Remote Access.

To back up the palmtop's drives:

- In Windows, double-click on the Backup icon in the Connectivity Pack group.

or

In the DOS command line, change to the CPACK200 directory and enter 200BACK.

To change parameters for the backup procedure (such as which files to back up or where to save the backed up files or directories), you can edit the file C:\CPACK200\BACKUP.INI.



Starting and Controlling LapLink Remote Access from DOS

You can run either computer (or both computers) from DOS.

From the PC

If your PC does not have Microsoft Windows, you can run LapLink Remote Access from the DOS command line. However, this costs about 92 KB more of DOS memory than using Windows does.

From the Palmtop Computer

The LapLink Remote Access Server application on the HP 200LX works only as a **server**. That is, the HP 200LX can serve only as a mass storage device, responding to directions from the PC but not giving directions to the PC. The palmtop *can* also be a **client** (the computer giving the directions), *if LapLink Remote Access is run from*

the DOS command line. The DOS environment is not as flexible or as friendly, but it does allow client status.

Note The HP 200LX and HP 100LX cannot run other built-in applications while LapLink Remote Access is active.

To start LapLink Remote Access from DOS:

1. Exit any applications shell and display the DOS command line. To do this on the palmtop, press **<...>** and select **<NEW>** Applications Terminate-All.
2. Start LapLink Remote Access.
 - **On the PC:** Enter
`cd \cpack200` (or appropriate Connectivity Pack directory)
`llra`
 - **On the palmtop:** From any directory (on the HP 100LX, from C:\LLRA), enter
`llraw` (for a serial wire link)
— or —
`llrair` (for an infrared link)

This command automatically starts LapLink Remote Access, enables the serial or infrared port for the redirector, and turns on the link. The computers will chime when the link is established.
3. Remember to start LapLink Remote Access on the other computer.
4. For a status message, enter `llra /m`.
5. You can control LapLink Remote Access with the DOS commands in the following table.

LLRA Commands for DOS

Command	Description
LLRA	Loads all TSR programs and turns on the link.
LLRAW	Palmtop only: Loads all TSR programs, enables the serial cable port, and turns on the link.
LLRAIR	Palmtop only: Loads all TSR programs, enables the infrared port, and turns on the link.
LLRAS	Palmtop only: After executing LLRA /U, this enables the subsequent use of LapLink Remote Access Server.
APP200L	Loads the TSRs, turns on the link, and starts the Connectivity Pack. When you quit the Connectivity Pack, it automatically unloads the TSRs.

Parameters for LLRA Commands

Parameter	Description
/?	Lists these DOS LapLink Remote Access commands.
/ON	Turns on the link. Equivalent to the On/Off button.
/OFF	Turns off the link. Equivalent to the On/Off button.
/M	Displays the connection status and the local/remote drive mappings.
/port no.	Turns on the redirector link over the specified port. 1=COM1, 2=COM2, 3=COM3, 4=COM4, 5=LPT1, 6=LPT2, 7=LPT3.
/Ppath	Specifies path for TSI.INI file—if not the same path as for other LapLink Remote Access files (TSRs).
/U	Turns off the link and removes the LapLink Remote Access TSR programs from memory.

To use the DOS LapLink Remote Access:

- You can now directly access the drives on the remotely linked computer. For instance, if drive E on the PC now maps to drive C on the palmtop, the following commands on the PC would display the directory for the palmtop's RAM disk drive:

```
e:  
dir
```

- **On the PC:** To maintain the redirector link while using another application, just start that application. You can start the Filer, for instance, and manage remote files from the Filer using the remapped drive designations.
On the palmtop: You cannot simultaneously use the redirector link and another built-in application.

To stop LapLink Remote Access and recover the memory it uses:

1. Exit any applications shell and display the DOS command line.
2. Enter

```
llra /u
```

(On the PC, you must be in the Connectivity Pack directory.)

This breaks the link and unloads the LapLink Remote Access program files from DOS memory.

3. **If on the palmtop:** Enter

```
llras  
200
```

This prepares for future use of the LapLink Remote Access Server and re-starts the System Manager.

Installing PC Software onto an HP Palmtop

Note Many software manufacturers prohibit you from copying programs to multiple computers. Check your software license before installing the software on your palmtop.

When installing PC software onto an HP 200LX or HP 100LX, we recommend that you install it onto a plug-in card in drive A, since the memory requirements could overwhelm the drive C RAM disk.

- If the software uses an installation program, install it remotely from the PC to the palmtop's drive A using the LapLink Remote Access redirector. See "To install PC software remotely onto the palmtop," below.
- If the installation program does not work with LapLink Remote Access, you could try installing the software onto the PC, and then copying the files (using the Connectivity Pack) to the palmtop's drive A (containing a plug-in card). See "To install software on a PC and copy it to a palmtop," below.

5-12 Using LapLink Remote Access to Link Computers

- If the software needs only to be copied to be installed, you could use the Connectivity Pack to copy the program's files from a PC drive to the palmtop's drive A (containing a plug-in memory card).
- If you have a memory-card drive for your PC, you could try installing the software from the PC to a plug-in card, and then inserting the card into the palmtop's card slot. This method does not use the Connectivity Pack.

To install PC software remotely onto the palmtop:

In this procedure, the palmtop is the local computer and the PC is the remote computer. Using the redirector, the palmtop reads the software from a PC drive as if it were a palmtop drive.

1. Insert the first software disk into the PC's flexible-disk drive.
2. Insert a plug-in memory card into the palmtop's card slot, drive A.
3. **On the palmtop:** Terminate the System Manager:
Press **ESC** **MENU** **A** **T** (Application Terminate-All).
4. Turn on LapLink Remote Access on both computers:
 - **On the palmtop:** Start LapLink Remote Access from the DOS prompt so that the palmtop can be the client. Enter `llra>w` for a cable (wire) link *or* `llra>ir` for an infrared link.

Listen for the chimes to confirm the link.
5. **On the palmtop:** Check the drive mapping (enter `llra /m`) and note the local (palmtop) drive that corresponds to the remote (PC) disk drive you're using. Make the remote drive the current drive and start the installation. For example, if PC drive A holds the disk, and it maps to palmtop drive F, you would enter this on the palmtop:

```
f:
install
```

6. Follow the installation instructions, specifying drive A for the installation destination. (If it refuses to install onto A, try drive E—drive E is also assigned to drive A on the palmtop.)
7. When the installation is over, be sure to terminate LapLink Remote Access on the palmtop and then restart the System Manager:

```
llra /u
llra>
200
```

See your HP 200LX or HP 100LX *User's Guide* for more information on running DOS applications. You can add the application to the palmtop's Applications Manager, if you like, making it easier and faster to start the program.

To install software on a PC and copy it to the palmtop:

Use this procedure when you can't use LapLink Remote Access to install a program directly onto the palmtop.

1. Install the program on your PC. During the installation, set the following parameters—if possible—to make the program work on the palmtop:
 - For the monitor type, choose CGA, MDA, Black and White, LCD, or plasma display. *Don't select EGA or VGA.* If there is a "snow" setting, select "no snow."
 - If the installation program asks whether to modify the CONFIG.SYS and AUTOEXEC.BAT files, select "no."
2. **On the PC:** Use the Connectivity Pack to copy *all* the program's files to your palmtop, using identical directory names and structure. (See chapter 2 for instructions.)

Making an Infrared Link

You can make a *cable-free* connection between your palmtop and a PC that has an infrared port. The infrared ports use invisible beams of infrared light to communicate. Some HP Vectra desktop PCs have infrared ports, and all HP OmniBook Superportable computers and HP palmtop computers have infrared ports.

To check the configuration settings for an infrared link:

1. **On the palmtop:** Start the LapLink Remote Access Server (press **&... R**) and make sure the Interface setting is Infrared (press **F4**, if necessary).
2. **If using a desktop PC:** Change the baud setting (the Speed field in Port Setup, Advanced) to match the palmtop's: usually 115200. The port configuration settings (in Port Setup) should already specify the correct COM port as Serial and Enabled. *Do not change the setting to Infrared.*
3. **If using OmniBook:** The port configuration setting in Port Setup should by default specify COM3 as Infrared and Enabled.

To establish an infrared link:

1. Line up the two computers' infrared ports no more than 15 cm (6 inches) apart for optimum performance.
2. **On the palmtop:** Start the LapLink Remote Access Server (**&... R**).
3. **On the PC (including an HP OmniBook):** Start LapLink Remote Access.

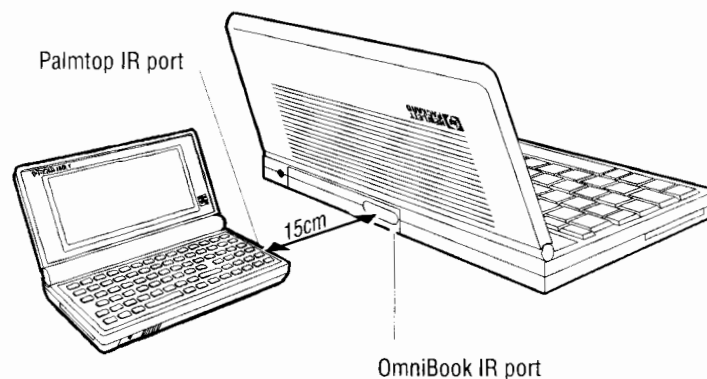

When both computers chime, they are successfully linked. LapLink Remote Access operates just as it does with a serial cable connection.

If you block the infrared path for more than about 30 seconds, the link will break.

Editing the TSI.INI File

When the LapLink Remote Access programs are started, configuration information comes from an initialization file called TSI.INI. This file is located in the LapLink Remote Access directory, which is D:\BIN on the HP 200LX and, probably, C:\CPACK200 on the PC.

In most cases, there is no need to edit this file. If, however, you are running LapLink Remote Access from the PC without Windows, then you have no interface for controlling such parameters as Computer Name, Baud setting, and Sound setting.

Default TSI.INI File on the PC

Line	Description
ComputerName= Connectivity Pack	How this computer is identified by the other computer.
[Redirector] Enabled=Yes	When you run LLRA, it automatically attempts to link to the other computer (setting is ON).
Sound=Yes	Computer will chime when it makes a link to the other computer, as well as when it disconnects the link.
[COM1] Enabled.Redir=Yes	“Yes” means LapLink Remote Access uses this port. Which port to enable was decided during installation; if not, you must edit this specification.
Type=Serial	Always Serial. (Only the HP OmniBook’s COM3 would not be serial; it is Infrared.)
Address=3F8 IRQ=4	Values for COM1 and COM2 are standard; COM3 and COM4 are not.
Baud=0	Zero means Automatic baud rate detection (fastest speed possible). 19200, 38400, 57600, and 115200 also available.
TransferMode=Best	Selects Accelerated transfer protocol, if possible; otherwise Standard.
[COM2] Enabled.Redir=No :	COM2, COM3, and COM4 have parameters like COM1. The addresses and IRQ values will vary. Note that only one COM port will be enabled—the specific one selected during installation.

To edit TSI.INI on the PC:

- Use the Memo Editor to open, edit, and save the TSI.INI file in the Connectivity Pack directory (C:\CPACK200).

5-16 Using LapLink Remote Access to Link Computers

To use the new TSI.INI file to run LapLink Remote Access on the PC:

1. Unload the TSR files by executing LLRA /U from the CPACK200 directory.
2. Re-load the TSR files by executing LLRA from the CPACK200 directory. This will read the new TSI.INI file and start LapLink Remote Access.

LapLink Remote Access on an HP 100LX

Unlike the HP 200LX palmtop computer, the HP 100LX does not have the LapLink Remote Access program built in. Therefore, in order to use the redirector provided by this Connectivity Pack, you must use the Filer to install LapLink Remote Access onto the HP 100LX.

To install LapLink Remote Access onto an HP 100LX:

These directions install onto the C drive. If you prefer, you can install onto the A drive.

1. **On the HP 100LX:** Create the directory C:\LLRA. (In the Filer, select  File Create-Dir.)
2. Start the Connectivity Pack on the PC, open the Filers on both computers, and make a remote connection from either computer. Copy the following files from the PC directory C:\CPACK200 (or whichever directory is your Connectivity Pack directory) to the HP 100LX directory C:\LLRA.

LCOM1.BAT, LCOM1.ICN
LIR.BAT, LIR.ICN
LL100TSI.INI
LLRA.BAT
LLRA1.EXE, LLRA2.EXE, LLRA3.EXE
LLRAIR.BAT, LLRAW.BAT
3. **On the HP 100LX:** Rename the file LL100TSI.INI to TSI.INI. (Use the Filer's File Rename command to specify a new name in the same directory.)
4. **On the HP 100LX:** Add two LapLink Remote Access applications to the Application Manager (More Applications screen), one for a cable connection and one for an infrared connection. Press .

F2 for each addition and fill in the fields as follows. Press **F10** to end each addition.

Add an Application

Field	Cable Connection	Infrared Connection
Name	LapLink C&om1 (O is shortcut key)	LapLink I&R (R is shortcut key)
Path ¹	c:\llra\lcom1.bat 200	c:\llra\lir.bat 200
Comments	i & (FN ! FN ?)	i & (FN ! FN ?)
Icons	Accept the default.	Accept the default.

¹ Do *not* insert spaces between any characters.

Running LapLink Remote Access on the HP 100LX

Remember to turn on LapLink Remote Access on the PC, as well.

To start LapLink Remote Access on the HP 100LX:

- From the More Applications screen (press **&...** **F10**), start LapLink Com1 (for a cable link) or LapLink IR (for an infrared link).

This automatically starts LapLink Remote Access, enables the appropriate communications port, and turns on the link. Each computer will chime when the link is established.

- If you need to maximize the available system memory, such as for installing software from a PC, then you can start LapLink Remote Access from DOS, as explained on page 5-10.

To use LapLink Remote Access on the HP 100LX:

- It is easiest to work at the PC, using it as the client and the HP 100LX as the server.
- If you want the HP 100LX to be the client, then you can use the DOS commands on page 5-10.

To stop LapLink Remote Access on the HP 100LX:

- Enter EXIT to break the link and unload the LapLink Remote Access program files from DOS memory.

5-18 Using LapLink Remote Access to Link Computers

Extra Features of LapLink Remote Access

The LapLink Remote Access program includes several features displayed in large picture buttons across the top of the main LapLink Remote Access screen:

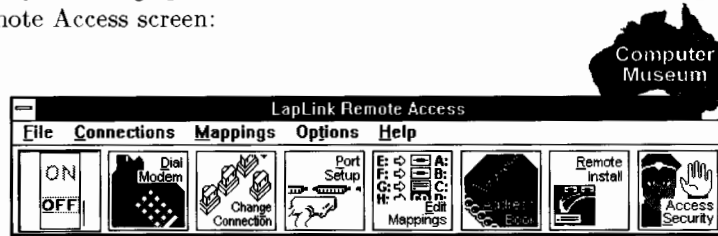

Some of these features are of limited use with the HP 200LX and HP 100LX computers, such as Dial Modem and Remote Install. Others are advanced features for intensive users, such as Edit Mappings.

Refer to the online Help on the PC for information on these features: after clicking on the appropriate feature's button, click on the Help button (the blue question mark). For stepwise instructions, click on the green HOW TO button.

- **Dial Modem.** Using a modem with LapLink Remote Access is difficult, in part because the HP 200LX cannot control a modem from Server mode.
- **Change Connections.** If the PC is connected to more than one computer, you can quickly switch among them here.
- **Port Setup.** You can specify which ports are available for LapLink Remote Access and what types they are. By *disabling* a port, you prevent LapLink Remote Access from interfering with other communications on that port, such as for a modem. (You cannot change the status of a port while it is Connected.) Problems in linking two computers are sometimes related to the address and interrupt settings (Advanced button). See the following table.
- **Edit Mappings.** You can change the way that the palmtop computer's drives are mapped to the PC. You can "unmap" a drive to make it unavailable. The printer mappings are of little use since you would not typically want to print from the PC to a printer connected to the palmtop.
- **Address Book.** This is for use with a modem: It lists phone numbers and computer passwords.

- **Remote Install.** We do not recommend this with a palmtop. To install LapLink Remote Access onto an HP 100LX, see “LapLink Remote Access on an HP 100LX,” earlier in this chapter. Note that the HP 200LX has LapLink Remote Access built in.
- **Access Security.** This sets a password to restrict access *to the PC's drives* only.
- **Manage Files.** Clicking on this button is a shortcut to start the Windows File Manager.

Adjusting Port Setup When You Have Trouble Linking

Type of Port	Advanced Options	Suggested Modifications
Serial	Speed (baud) Address Interrupt Transfer Mode	Change Address or Interrupt for a special port configuration. For example, on an HP Vectra, COM3 and COM4 may use interrupts 10 and 11. Change Interrupt to Polled for conflicts between COM1 and COM3 (or COM2 and COM4) usage. Change Speed or Transfer Mode for problems establishing a link. Standard transfer mode is slower but more reliable.
Infrared	Speed (baud) Address Interrupt	Change Speed for problems establishing a link. Change Address or Interrupt for a special port configuration.

Troubleshooting and Warranty

This chapter contains the following information:

- Symptoms of Connectivity Pack problems and possible remedies.
- Selected status messages and possible responses.
- Diagnostic programs.
- Warranty information.

See the inside back cover for information about contacting Hewlett-Packard.

Symptoms

If you have problems using the Connectivity Pack, look in this section for the description that most closely matches the symptoms you observe, and try the suggestions listed.

Connectivity Pack Problems

If the installation program doesn't work properly:

- Make sure that your 3.5" disk drive can read high-density disks.
- Make sure you've set the current drive to the drive containing the Connectivity Pack disk.

If you can't start the Connectivity Pack or it locks up:

- Make sure you allowed the installation process to finish.
- Make sure you are in the Connectivity Pack directory (usually C:\CPACK200).
- Make sure you did *not* install the software on a network drive—it must be installed on a local hard disk.
- Make sure your PC is using MS-DOS version 3.31 or later.

- Make sure your PC has a 286 or higher processor, and an EGA or higher display. The Connectivity Pack won't work on a PC XT.
- Check the FILES command in your PC's CONFIG.SYS file:
 1. Determine the *current* FILES setting specified in the CONFIG.SYS file. (At the MS-DOS prompt enter `type \config.sys`)
 2. If the FILES parameter does not exist or is not set to at least 15, add it or modify it to `FILES=15`.
 - a. Make a backup copy of your current CONFIG.SYS file as CONFIG.OLD. Open CONFIG.SYS with a text editor to modify it.
 - b. When done, save the CONFIG.SYS file *in ASCII format*.
 - c. Reboot the PC (press **Ctrl**+**Alt**+**Del**). Your PC now uses the new FILES value.
 - d. An incorrectly saved or modified CONFIG.SYS file can make the PC malfunction. If you want to restore your original CONFIG.SYS and start over, at the MS-DOS prompt enter `copy config.old config.sys`

If you can't find files:

- **In the Filer:** Check that you're viewing the correct drive and the correct side of the screen (local versus remote computer).
- **In LapLink Remote Access:** Check that you're viewing the correct drive. Remember that the remote drives have new designations (as shown in the LapLink Remote Access window or when you enter `llra /m`).
- **In applications other than LapLink Remote Access:** There are limits on the number of files that can be listed.

If you cannot access remote drives using the Connectivity Pack:

- Remember that you must start LapLink Remote Access *before* starting the Connectivity Pack in order to make a remote connection and have access to remote drives. Start LapLink Remote Access on both computers and listen for both sets of chimes.

If you can't make a remote connection:

- Make sure the serial cable is plugged into the palmtop with the HP logo facing up.
- Make sure that either the Filer or LapLink Remote Access is running on *both* computers.

6-2 Troubleshooting and Warranty

If the Filer can't make a remote connection:

- Check the Filer's settings on both palmtop and PC: See "Step 3: Checking the Filer's Settings," in chapter 1. Note that Server Mode must be Enabled and that you might need to lower the baud (from above 19200) to make the link work.
- The palmtop has only one serial port connector, COM1—you should select it on the palmtop if you're connecting with a cable to a PC or external modem, *regardless of which serial port you're using on the PC*. (The palmtop's COM2 port is used with PCMCIA modems in the card slot.)
- LapLink Remote Access should not be on—the Filer and LapLink Remote Access cannot both make a remote connection at the same time.
- Check that no memory-resident program (TSR) on the PC is using the serial port. If one is, stop the TSR, or use a different port.
- Try restarting the PC by pressing **Ctrl+Alt+Del**.
- Try resetting the palmtop: Save any open files and close all applications. Press **↑+CTRL+ON**, then **N ENTER**. *Do not initialize the RAM disk.*

If the Filer loses its remote connection during a file transfer:

- Check the cable connection or infrared connection between the computers.
- In the Filer, try pressing **F6** (Remote).
- Try the suggestions in the previous topic.
- Try lowering the baud setting.

If you run out of memory while merging or synchronizing two files:

- Close or quit other applications or programs that are running—such as Windows, memory-resident (TSR) programs, and network software. Merging requires enough memory to hold both files during processing.

If you can't translate Comma Delimited files to HP 100LX/200LX format:

- Make sure no field contains a *single* " (double-quote) character, which is reserved for marking the start and end of each field. (To represent a double-quote character within a field, use *two* double-quote characters together.)

- Make sure the only characters outside the " (quote) delimiters are comma separators and carriage-return/line-feed record markers.
- Make sure each record ends with carriage-return *and* line-feed characters.
- Use the Connectivity Pack Phone Book to create a short file with palmtop format. Then use Translate to create a CD version, and compare its format with the Comma Delimited file that's difficult to translate.
- Examine the task's log file for clues to the problem.

If a modem connection doesn't work:

- Make sure the Filer is open on *both* computers.
- Make sure the baud rate for the two modems is the same as those set in the Filer ( Communication Remote-Settings) on *both* computers.
- Make sure you're using the correct cable adapter—the 25-pin modem connector has a picture of a phone embossed on it.
- Make sure the receiving modem is in auto-answer mode.
- Check the connection and configurations of the PC and its modem. See your PC and modem documentation.

If you can't delete SETUP.ENV from the installation directory:

- This file is required by the Connectivity Pack, so you shouldn't delete it unless you're removing the Connectivity Pack software from your PC. To delete this file, first enter ATTRIB -R SETUP.ENV, then delete the file.

LapLink Remote Access Problems

If LapLink Remote Access can't make a remote connection:

- Make sure the serial cable is plugged into the palmtop with the HP logo facing up.
- Make sure that LapLink Remote Access is running on *both* computers. Listen for the chimes to let you know that the link is established. Do this *before* starting other programs, including Connectivity Pack.
- Check the communication settings. See "Checking the Settings for LapLink Remote Access," page 5-7.
 - An infrared link might need to run at a lower baud rate.

6-4 Troubleshooting and Warranty

- The best Speed for a COM port is Automatic.
- If you are using an infrared link with a PC, remember that the PC's Port Setup must specify a Serial (*not* Infrared) port. (An OmniBook *does* use the Infrared port setting.)
- If you are using Windows and the Install program did not modify your AUTOEXEC.BAT—or did so incorrectly—then you must either (1) enter `11r-a1` from the Connectivity Pack directory in DOS *before* starting Windows, or (2) your AUTOEXEC.BAT file must have the line `C:\CPACK200\LLRA1` *before* the statement that starts Windows (or at the end of the file if there is no Windows statement). The Install program already took care of this *unless* you told the program not to modify AUTOEXEC.BAT, *or* the Install program could not identify your Windows statement and incorrectly placed `C:\CPACK200\LLRA1` *after* the Windows statement.
- Look for conflicting programs running on your PC. Close or quit other applications or programs that are running—such as memory-resident (TSR) programs. Examine the AUTOEXEC.BAT file for commands that run potentially conflicting programs.
- If you are trying to link to an HP OmniBook, and you installed the Connectivity Pack onto Windows, then LapLink Remote Access probably does not work. Try editing the AUTOEXEC.BAT file on the OmniBook by deleting the line `C:\CPACK200\LLRA1`. Then reboot the OmniBook.

If LapLink Remote Access can't access all the remote drives:

- Verify the drive mappings: Check the PC's LapLink Remote Access window *or* enter `11r-a /m` at the DOS command line.
- Check that the LASTDRIVE parameter (in the CONFIG.SYS file) is large enough to accommodate four palmtop drives in addition to the PC's hard, flexible, and network drives. The Install program set the PC's LASTDRIVE to Z, unless you specified a Novell network. If you are on a Novell network, you need to contact your network administrator. The palmtop's default LASTDRIVE is J. This setting is irrelevant unless the palmtop is the client and the PC has more than five drives, in which case you need a value higher than J. If you edit the file, reboot the PC.
- If LapLink Remote Access was started under Windows on the PC, then it must also be started on the palmtop *while the PC is running Windows*.

If the LapLink Remote Access connection is interrupted:

- **From the palmtop:** If the palmtop is using battery power, it will turn off LapLink Remote Access, breaking its link, after 5 minutes of inactivity. To prevent this interruption, you can plug in an ac adapter or change the timeout setting in the LapLink Remote Access Server.
- **From the PC:** By default, the PC does not time out its link (Connection Timeout is zero). You can check the Options Timeouts command (Windows).

HP 100LX/200LX Problems

If your palmtop's batteries run down too fast:

- Use an ac adapter.
- Refer to the HP 200LX or HP 100LX *User's Guide* for more information on reducing power use.

PC Problems

If you have network problems while using LapLink Remote Access:

- Make sure you start the network *before* you start LapLink Remote Access.

Selected Messages

The following messages appear in the Connectivity Pack, in Windows, or in the MS-DOS environment.

“Bad command or file name”

- Switch to the Connectivity Pack directory (usually \CPACK200) before running APP200, LLRA, or 200BACKUP.

“Cannot find file C:\CPACK200\LLRAWIN.EXE ... ”

- You need to re-install the Connectivity Pack.

“The Connectivity Pack Setup ... could not be completed”

Various situations can produce this message, such as

- You specified the root directory for Setup. Exit Windows and re-run Install, specifying a different directory for Install.
- There are files missing that Setup needs. Exit Windows and re-run Install.
- The CONFIG.SYS and/or AUTOEXEC.BAT files are write-protected or otherwise inaccessible. Unprotect the file(s) and re-run Setup.
- The root directory is full and cannot accommodate the temporary files that Setup creates. Make room in the root directory and re-run Setup.

“Could not find LapLink Remote Access files—backup failed”

- Make sure you are running 200BACKUP from your Connectivity Pack directory (usually C:\CPACK200). For instance, enter CD \CPACK200 before running 200BACKUP.



“Disk is full”

- The disk drive you’re writing to is full. Delete unneeded files.

“Invalid or empty file”

- The file may be corrupt or missing from the installation directory. Restore the file from a backup file (if you’ve made one), or, if the file is a Connectivity Pack file, reinstall the Connectivity Pack software.

“The LLRA1 module was not found”

- Did you remember to reboot the PC (press **Ctrl**+**Alt**+**Del** simultaneously) after completing the installation procedure?
- LLRA1 is loaded from AUTOEXEC.BAT, where the installation program adds it. Check your AUTOEXEC.BAT file and make sure the line C:\CPACK200\LLRA1 is the last line *before* the command that starts Windows (if there is one). (Substitute your own Connectivity Pack directory name, if you changed it from C:\CPACK200). If you edit the file, reboot the PC.
- If Install did not modify your AUTOEXEC.BAT file, then you need to add the line C:\CPACK200\LLRA1, as explained above.

“Out of memory”

- The file is too large for the application. Transfer it to another computer and delete entries from the file.
- The PC has insufficient memory to perform the task. Close or quit other applications or programs that are running—such as memory-resident (TSR) programs.

“Record not found”

- The data in this file might have been corrupted. You should delete this file and replace it with a backup version, if you’ve made one. Or, you can try to merge this file into a new file.

“There is not enough memory available to run Install . . . ”

- The PC needs at least 640 KB of RAM, with at least 450 KB of free conventional DOS memory. If you are running memory-resident programs (“TSRs”), you might need to remove them to regain memory. Refer to your MS-DOS owner’s manual for suggestions on freeing up conventional memory. For instance, you can try to get more memory by commenting out (preceding with “REM”) TSRs (such as network commands) in the AUTOEXEC.BAT file, then rebooting the PC.

“TSR is already loaded. APP200 cannot be run”

- It could be that APP200 is already running and you are in a DOS box. Try typing EXIT .
- If EXIT does not work, then reboot the PC (++.

Diagnostic Programs

The Connectivity Pack contains four programs that might help you resolve certain configuration problems:

- APPCOM displays serial port information.
- APPDRV displays a list of disk drives.
- APPMEM displays memory usage, including allocations for memory-resident programs.
- UN200 unloads all of the Connectivity Pack memory-resident programs.

Limited Warranty

Software: HP warrants for a period of **1 year** from the date of purchase that the software product will execute its programming instructions when properly installed on the personal computer or workstation indicated on this package. HP does not warrant that the operation of the software will be uninterrupted or error free. In the event that this software product fails to execute its programming instructions during the warranty period, Customer's remedy shall be to return the diskette(s) or tape cartridge(s) ("media") to HP for replacement. Should HP be unable to replace the media within a reasonable amount of time, Customer's alternate remedy shall be a refund of the purchase price upon return of the product and all copies.

Media: HP warrants the media upon which this product is recorded to be free from defects in materials and workmanship under normal use for a period of **1 year** from the date of purchase. In the event any media prove to be defective during the warranty period, Customer's remedy shall be to return the media to HP for replacement. Should HP be unable to replace the media within a reasonable amount of time, Customer's alternate remedy shall be a refund of the purchase price upon return of the product and all copies.

Notice of Warranty Claims: Customer must notify HP in writing of any warranty claim not later than thirty (30) days after the expiration of the warranty period.

Limitation of Warranty: HP makes no other express warranty, whether written or oral, with respect to this product. Any implied

warranty of merchantability or fitness is limited to the 1-year duration of this written warranty. Some states or provinces do not allow limitations on how long an implied warranty lasts, so the above limitation or exclusion may not apply to you. (In the UK only: If you are a “consumer” as defined by statutes, parts of this statement may not apply to you.)

This warranty gives specific legal rights, and you may also have other rights which vary from state to state, or province to province.

Exclusive Remedies: The remedies provided above are Customer’s sole and exclusive remedies. In no event shall HP be liable for any direct, indirect, special, incidental, or consequential damages (including lost profit) whether based on warranty, contract, tort, or any other legal theory. Some states or provinces do not allow the exclusion or limitation of incidental or consequential damages, so the above limitation or exclusion may not apply to you.

Warranty Service: Warranty service may be obtained by contacting the number or office indicated inside the back cover.

Index

Special characters

100LX. *See* HP 100LX
200LX. *See* HP 200LX
. \$DI files, 4-5, 4-19
. \$DT files, 4-5, 4-19
. \$MT files, 4-5, 4-19
. \$NX files, 4-5, 4-19

A

.ABK translation, 4-12
ac adapter, 6-6
 for Filer, 2-2
 for LapLink Remote Access,
 5-1
accelerated transfer mode, 5-5,
 5-16
accessing
 remote files, 5-7
Access Security, 5-20
access to PC drives
 restricting, 5-20
adapters
 serial, 1-1
adapters (serial), 1-3
.ADB files, 4-2
Add, 4-3, 4-11
adding tasks, 4-3, 4-11
Address Book, 5-19
addresses, 5-16, 5-19, 5-20
Advanced settings, 5-19
alarms, 3-1

APP200, 1-5. *See also* HP
 200LX applications
 problems, 6-1
APP200 cannot run, 6-8
APP200L, 5-11
APPCOM program, 6-9
APPDRV program, 6-9
Application Manager
 HP 100LX, 5-18
application notes. *See inside
 back cover*
applications
 changing, 3-2
 closing on the palmtop, 2-3
 for Xlate/Merge, 4-2
 running, 1-5
 starting, 3-2
APPMEM program, 6-9
Appointment Book, 3-1
 file formats, 4-13
 recovering data, 4-18
 translating files, 4-11
 translating HP 95LX files,
 4-12
Appointment Book fields
 translating, 4-15, 4-17
Appointment Book format,
 4-17
AUTOEXEC.BAT, 6-5, 6-7
 problems, 6-5
AUTOEXEC.BAT file, 6-8

B

- backing up
 - changing parameters, 5-9
 - files, 4-5, 4-18, 4-19
 - how to (Filer), 2-5
 - how to (LapLink Remote), 5-9
 - palmtop, 2-5
 - remotely, 5-9
 - using macros, 2-5
- backup filenames, 4-5, 4-19
- BACKUP.INI, 5-9
- backup problems, 6-7
- bad command, 6-6
- balance forward, 4-7
- batch file, 4-17
- batteries (HP 100LX/200LX), 6-6
- baud
 - infrared LapLink Remote, 5-15
- baud rate
 - LapLink Remote, 5-7, 5-8, 5-16
- baud rates, 2-6
- beeping
 - LapLink Remote, 5-15
- breaking a link
 - how to (LapLink Remote), 5-5
- broken connection (Filer), 2-3, 6-3

C

- cable, 1-3. *See also* serial cable
 - LapLink Remote, 5-3
- cable connection, 1-2
- Calculator, 3-1
- CD. *See* Comma Delimited
- Change Connections, 5-19
- changing applications

- how to, 3-2
- chimes
 - LapLink Remote, 5-7, 5-15
- cleanup, 1-5
- clean up Install
 - how to, 1-5
- client mode, 5-3
 - palmtop, 5-10
- colors (display), 3-3
- COM1/2/3/4. *See* serial ports
- COM2 port
 - palmtop, 6-3
- COM3
 - COM4, 3-3
- Comma Delimited file format, 6-3
- Comma Delimited format, 4-2, 4-11, 4-12, 4-13, 4-15, 4-16, 4-17
 - translating appointments, 4-17
- COM port
 - identifying, 1-4
 - LapLink Remote, 5-8, 5-16
- computer. *See* HP 200LX,
 - palmtop, PC
- computer name, 5-16
 - LapLink Remote, 5-7
- CONFIG.SYS file
 - LASTDRIVE parameter, 6-5
 - modifying, 6-2
- configuration
 - communication, 1-6
- configuration for Filer
 - communications, 1-6
- configuration settings
 - how to set (LapLink Remote), 5-8
 - how to set (palmtop), 1-6
 - how to set (PC), 1-6
- conflict definition, 4-5, 4-8

- conflicting records
 - repeating, 4-10
 - selecting, 4-10
 - unmatched, 4-10
 - conflict resolution, 4-5, 4-9
 - in a file, 4-9
 - connect cable
 - how to, 1-2
 - connect infrared ports
 - how to, 1-2
 - connecting. *See* linking
 - two palmtops, 2-4
 - connecting computers (Filer), 2-2
 - connecting computers (LapLink Remote), 5-3
 - connecting PC and palmtop, 1-2, 1-3
 - connecting PC and palmtop (Filer), 2-1
 - connecting with modem
 - how to, 2-6
 - connections
 - broken (Filer), 2-3
 - multiple (LapLink Remote), 5-19
 - connections broken (Filer), 6-3
 - Connectivity Pack, 3-1
 - applications on PC, 3-1
 - installing software, 1-4
 - problems, 6-1
 - setting up system, 1-1
 - starting, 1-5, 3-2
 - starting with LapLink Remote, 5-11
 - stopping, 3-2
 - system requirements, 1-1
 - trouble starting, 6-1
 - uninstalling, 6-4, 6-9
 - using remote drives, 5-6
 - warranty, 6-9
 - Connectivity Pack directory, 6-1
 - connectors, 1-2
 - consulting. *See inside back cover*
 - Copy, 4-18
 - copying files, 2-1
 - copying files (Filer), 2-3
 - corrupt record, 6-8
 - CPACK200, 1-5
 - currency symbol, 3-3
 - Customer Support. *See inside back cover*
 - Cut, 4-18
- D**
- Database, 3-1
 - Database fields
 - translating, 4-16
 - date format, 3-3
 - diagnostic programs, 6-9
 - Dial Modem, 5-19
 - directories
 - backing up palmtop, 2-5
 - local and remote, 2-2
 - transferring, 2-3, 2-4
 - directory, 1-4
 - LapLink Remote, 5-16
 - disk drives. *See* drives
 - display colors
 - setting up, 3-3
 - DOS
 - LapLink, 5-8
 - LapLink Remote, 5-3, 5-10
 - running LapLink from, 5-9
 - versions supported, 1-2
 - DOS box, 6-8
 - DOS commands
 - LapLink Remote, 5-11
 - DOS LapLink Remote

- how to use, 5-11
- drive A, 5-2, 5-13
- drive C, 5-2
- drive D, 5-2
- drive E, 5-2, 5-13
- drive interruption, 5-5
- drive letters
 - assigned by LapLink Remote, 5-2
- drive mappings
 - editing, 5-19
- drives
 - backing up, 5-9
 - for installation, 1-2
 - local and remote, 2-3
 - mappings, 5-2, 5-11
 - network, 1-4

E

- editing tasks, 4-3, 4-18
- Edit Mappings, 5-19
- enabling ports (LapLink Remote), 5-15
- Enhanced mode Windows, 5-3
- error messages, 6-6
- establishing a link
 - how to (LapLink Remote, 5-4
- establishing a link (Filer), 2-2
- establishing a link (LapLink Remote), 5-3
- exit Connectivity Pack
 - how to, 3-2
- extensions
 - file, 4-13

F

- fax number
 - translating, 4-15
- field mapping, 4-12
- File1,File2, 4-5

- file extensions, 4-13
 - for translating, 4-13
- file formats, 4-2, 4-11
 - comparing, 4-13
- File Manager
 - how to access, 5-6
 - shortcut from LapLink Remote, 5-20
 - Windows, 5-6
- filenames
 - backup, 4-5, 4-19
- Filer, 3-1
 - communications port, 3-3
 - local and remote, 2-2
 - power use, 2-2
 - problems, 6-1
 - transferring files, 2-1, 2-3
 - with LapLink Remote, 2-4, 5-6
- Filer link, 2-2
 - not with LapLink Remote, 2-4
- Filer settings
 - communication, 1-6
- files
 - Appointment Book, 4-11
 - backing up palmtop, 2-5
 - backup, 4-19
 - closing before transfer, 5-7
 - combining, 4-1
 - copying, 2-1
 - copying (Filer), 2-3
 - formats, 4-2, 4-11, 4-13
 - log, 4-19
 - merging, 4-1
 - moving, 2-1
 - moving (Filer), 2-3
 - Phone Book, 4-11
 - recovering data, 4-18
 - resolving conflicts, 4-9
 - transferring, 2-1

- transferring (Filer), 2-3
- translating formats, 4-11
- file size
 - translation, 4-15
- FILES parameter, 6-2
- file types, 4-2
 - Xlate/Merge, 4-1, 4-2
- formats
 - comparing, 4-11, 4-13
 - translating, 4-11, 4-14, 4-15, 4-17

G

- .GDB files, 4-2
- .GDB translations, 4-12

H

- hard disk required, 1-2
- Hewlett-Packard. *See inside back cover*
- home number
 - translating, 4-15
- HP 100LX, 5-3
 - file formats, 4-15
 - format, 4-2, 4-11, 4-13
 - LapLink Remote on, 5-17, 5-18
 - to OmniBook, 5-2
- HP 100LX/200LX, 1-2
 - battery life, 6-6
- HP 200LX, 5-3
 - format, 4-2
 - to OmniBook, 5-2
- HP 95LX
 - file formats, 4-15
 - file translations, 4-12
 - format, 4-2, 4-11, 4-12, 4-13
 - translating appointments, 4-17
- HP OmniBook, 5-3, 5-8
 - problems, 6-5

- to palmtop, 5-2
- Windows Setup for, 1-5
- with LapLink Remote, 5-2
- with palmtop, 1-5

HP OmniBook Companion, 1-5

I

- icons for HP 100LX, 5-18
- identical fields, 4-9
- identifying COM port, 1-4
- idle-connection timeout, 5-7
- infrared connection, 1-2
- infrared link
 - blocking, 5-15
 - how to make (LapLink Remote), 5-15
 - LapLink Remote, 5-3, 5-15
 - palmtop to PC, 5-14
 - speed of, 6-3
- infrared port, 1-2
 - range, 5-15
 - used by LapLink Remote, 5-15
- infrared setting
 - PC, 5-8
- infrared settings
 - how to set (LapLink Remote), 5-15
- initialization file
 - LapLink Remote, 5-16
- initial parameters
 - LapLink Remote, 5-16
- input files
 - Merge, Sync, 4-5
- install
 - cleanup, 1-5
- Install, 1-4
- installation
 - problems, 6-1
 - procedure, 1-1
- install Connectivity Pack

- how to, 1-4
 - installing
 - for Windows, 1-4
 - installing LapLink Remote, 6-7
 - on HP 100LX, 5-3
 - installing LapLink Remote onto
 - another computer, 5-20
 - installing PC software onto
 - palmtop, 5-12
 - installing software
 - PC to palmtop, 5-13
 - without LapLink Remote, 5-14
 - installing software remotely
 - how to, 5-13
 - install LapLink Remote onto
 - HP 100LX
 - how to, 5-17
 - interface
 - LapLink Remote, 5-7
 - interrupts, 5-19, 5-20
 - IR. *See* infrared
 - IRQ, 5-16. *See also* interrupt levels
- K**
- keyboard
 - differences, 3-3
- L**
- LapLink directory, 5-16
 - LapLink DOS commands, 5-11
 - LapLink Remote
 - chiming, 5-15
 - chiming at connect, 5-4
 - DOS, 5-11
 - example, 5-7
 - how to stop, 5-12
 - infrared link, 5-14, 5-15
 - initialization file, 5-16
 - installing on HP 100LX, 5-3, 5-17
 - installing remotely, 5-20
 - in Windows, 5-5
 - link to PC, 5-3
 - memory, 5-5
 - memory usage, 5-8
 - no-link timeout, 5-5
 - on PC, 5-5
 - ports for linking, 5-15
 - power use, 5-1
 - problems, 6-1
 - recovering memory from, 5-12
 - running from DOS, 5-9
 - running on HP 100LX, 5-18
 - running on PC only, 5-5
 - settings, 5-7
 - starting in Windows, 5-4
 - starting with Connectivity Pack, 5-11
 - stopping in DOS, 5-12
 - stopping on HP 100LX, 5-18
 - successful link, 5-4
 - troubleshooting, 5-20
 - TSRs, 5-8
 - turning off, 5-5
 - typical mappings, 5-2
 - unloading programs, 5-12
 - Windows vs. DOS, 5-3, 5-8
 - with Filer, 5-6
 - with other applications, 5-6
 - with the Filer, 2-4
 - LapLink Remote Access
 - backing up files, 5-9
 - transferring files, 5-1
 - LapLink Remote from DOS
 - how to start, 5-10
 - LapLink Remote on HP 100LX
 - how to start, 5-18
 - how to stop, 5-18

- how to use, 5-18
- LapLink Remote settings
 - how to check, 5-7
- largest executable program size, 6-8
- LASTDRIVE parameter, 6-5
- link
 - breaking (Filer), 2-3
 - breaking (LapLink Remote), 5-5, 6-6
 - establishing (Filer), 2-2
 - establishing (LapLink Remote), 5-3
 - infrared (LapLink Remote), 5-14
 - trouble establishing (LapLink Remote), 5-20
- linking
 - how to (Filer), 2-2
 - other applications (LapLink Remote), 5-6
 - PC and palmtop (Filer), 2-2
 - PC and palmtop (LapLink Remote), 5-3
 - problems, 2-3
 - problems (LapLink Remote), 5-20
 - two palmtops, 2-4
- linking computers
 - how to (LapLink Remote), 5-4
- links
 - multiple (LapLink Remote), 5-19
 - trouble establishing (LapLink Remote), 5-19
- LL100TSL.INI, 5-18
- LLRA
 - parameters, 5-11
 - unloading, 5-17
- LLRA1 missing, 6-7
- LLRA commands, 5-11
- LLRA in AUTOEXEC.BAT, 6-5
- LLRAIR, 5-11
- LLRAS, 5-11
- LLRAW, 5-11
- local computer, 2-2
- local directory, 2-2
- local name
 - LapLink Remote, 5-7
- log files, 4-5, 4-18, 4-19

M

- macros
 - backup, 2-5
- Manage Files, 5-20
- map, 1-8
- mapping fields
 - translate, 4-12
- mappings
 - editing, 5-19
 - typical list, 5-2
- Memo Editor, 3-1
- memory
 - available, 6-8
 - insufficient, 6-8
- memory problems, 6-3, 6-7, 6-8
- memory-resident programs, 6-8
- memory to run LapLink, 5-9
- Merge, 4-1
 - conflicts, 4-4
 - duplicate records, 4-1, 4-9
 - Quicken, 4-5
- merge files
 - how to, 4-3
- Merge settings, 4-5
- merging
 - password-protected files, 4-3
- messages (error), 6-6
- modem, 5-19
 - baud rates, 2-6

- connecting, 2-6
- lists, 5-19
- modems
- problems, 6-4
- Months to merge/keep, 4-5
- mouse, 1-2
- moving files, 2-1
- moving files (Filer), 2-3
- MS-DOS. *See* DOS

N

- name
 - computer, 5-7
- .NDB files, 4-2
- .NDB translation, 4-12
- network
 - Novell, 6-5
- networks
 - and installation, 1-4
 - problems, 6-6
- no corresponding record, 4-10
- Note Taker, 3-1
- Note Taker fields
 - translating, 4-16
- numeric punctuation, 3-3

O

- OmniBook. *See* HP OmniBook
- out of memory, 6-8
- overlapping appointments, 4-8
- overview, 1-8

P

- palmtop, 1-2
 - backing up with Filer, 2-5
 - backing up with LapLink, 5-9
 - connecting to PC, 1-2, 1-3
 - direct connection, 1-2
 - resetting, 6-3
- palmtop Filer settings

- communication, 1-6
- palmtop-palmtop link, 2-4
- palmtop-PC
 - transferring files, 2-3
- palmtop-PC link (Filer), 2-2
- palmtop-PC link (LapLink Remote), 5-3
- password
 - LapLink Remote, 5-20
 - remote computer, 5-19
- password-protected files, 4-3
- password protected files, 4-11
- Paste, 4-18
- .PBK translation, 4-12
- PC
 - connecting to palmtop, 1-2, 1-3
 - Connectivity Pack setup, 3-3
 - direct connection, 1-2
 - infrared setting, 5-8
 - keyboard, 3-3
 - link to (LapLink Remote), 5-3
 - palmtop applications, 3-1
 - printing to, 5-1
 - requirements, 1-1
 - serial link to, 5-4
 - sharing files, 5-1
- PC Filer settings
 - communication, 1-6
- PC-palmtop
 - transferring files, 2-3
- PC-palmtop link (Filer), 2-2
- PC-palmtop link (LapLink Remote), 5-3
- .PDB files, 4-2
- .PD\$ files, 4-5, 4-19
- .PDT files, 4-2, 4-8
- Phone Book, 3-1
 - file formats, 4-13
 - recovering data, 4-18

- translating files, 4-11
- translating HP 95LX files, 4-12
- Phone Book fields
 - translating, 4-14
- Pocket Quicken. *See* Quicken
- ports, 1-3, 1-4, 5-3
 - changing (LapLink Remote), 5-19
 - configurations, 5-20
 - disabling, 5-19
 - infrared LapLink Remote, 5-15
 - specifying, 5-19
 - used by LapLink Remote, 5-15
- port setting
 - LapLink Remote, 5-8, 5-16
- Port Setup, 5-19
- power use
 - Filer, 2-2
 - LapLink Remote, 5-1, 5-8
- printer settings, 3-3
- problem fixing, 6-1
- product support. *See inside back cover*
- punctuation setting, 3-3

Q

- .QD\$ files, 4-5, 4-19
- .QDT files, 4-2, 4-8
- query when conflict, 4-9
- Quicken file formats, 4-2
- Quicken files
 - backup, 4-5, 4-19
 - translating, 4-8

R

- rebooting, 6-3
- record
 - unmatched, 4-10

- record not found, 6-8
- recovering files, 4-18
- redirector, 5-1, 5-2. *See also*
 - LapLink Remote
 - backing up files, 5-9
 - LapLink Remote Access, 5-6
 - running from DOS, 5-9
 - starting in Windows, 5-4
 - terminating in DOS, 5-12
 - transferring files, 5-1
 - turning off, 5-5
 - with Filer, 5-6
- Redirector
 - problems, 6-1
- remap, 4-12
- remote computer, 2-2
- Remote connection broken, 2-3
- remote directory, 2-2
- remote drives
 - backing up, 5-9
 - how to use, 5-6
 - using, 5-6
- remote files
 - accessing, 5-7
- Remote Install, 5-20
- remote installation
 - PC to palmtop, 5-13
- remote software installation, 5-13
- resetting palmtop, 6-3
- resolving conflicts, 4-9
- Run, 4-17
- Run All, 4-17
- running a task list, 4-17
- running Connectivity Pack, 1-5

S

- saving tasks, 4-4, 4-12
- selected tasks, 4-17
- selecting files, 2-4
- serial cable, 1-2



- adapters for, 1-3
 - connecting modem and palmtop, 2-6
 - connecting PC and palmtop, 1-3
- serial link, 5-4
 - LapLink Remote, 5-3
- serial ports
 - connecting, 1-2
- server mode, 5-19, 6-3
 - LapLink, 5-11
- service, 6-9
- settings
 - communication, 1-6
 - LapLink Remote Access, 5-7
 - palmtop Filer, 1-6
 - PC Filer, 1-6
- setup
 - cleanup, 1-5
- Setup, 3-1, 3-3
- SETUP.ENV file, 6-4
- setup for Windows
 - unsuccessful, 6-1
- Setup for Windows, 1-4
- similar, not identical records, 4-8
- software
 - installing onto palmtop, 5-12
- sound, 5-16
 - LapLink Remote, 5-7
- speed
 - LapLink Remote, 5-7
- Standard mode Windows, 5-3
- start Connectivity Pack
 - how to, 1-5
- starting
 - Connectivity Pack, 1-5
 - LapLink Remote, 5-4
 - LapLink Remote from DOS, 5-9
- starting applications
 - how to, 3-2
- starting Connectivity Pack
 - how to, 3-2
 - trouble with, 6-1
- starting LapLink Remote
 - after Connectivity Pack, 5-6
- support. *See inside back cover*
- Synchronize
 - conflicts, 4-4
 - duplicate records, 4-1, 4-9
 - Quicken, 4-5
 - settings, 4-5
- synchronize files
 - how to, 4-3
- synchronizing
 - password-protected files, 4-3
- system disk, 6-8
- System Manager, 5-10, 5-11
- system requirements, 1-1

T

- tagging. *See* selecting target file, 4-12
- task lists, 4-18
- tasks
 - running, 4-17
- technical support. *See inside back cover*
- telephone connection, 2-6
- time format, 3-3
- timeout
 - LapLink Remote, 5-7, 6-6
 - no-link, 5-5
- timer, 3-1
- transactions, 4-5, 4-7
 - deleted, 4-5, 4-7
 - uncleared, 4-5
- transfer mode, 5-16
- transferring directories, 2-4
- transferring files, 2-1, 2-3
 - how to (Filer), 2-3

- transferring files (Filer), 2-3
- Translate
 - running, 4-11
- translate files
 - Appointment Book fields, 4-15
 - Database and Note Taker fields, 4-16
 - date and time formats, 4-14
 - file extensions, 4-13
 - format, 4-13
 - formats for, 4-12
 - how to, 4-11
 - order of fields, 4-13
 - Phone Book fields, 4-14
- translating
 - password-protected file, 4-11
- translating file formats, 4-11
- translating Quicken files, 4-8
- troubleshooting, 6-1
- TSL.INI, 5-16
 - how to edit, 5-16
 - how to use, 5-17
 - HP 100LX, 5-18
- TSL.INI settings, 5-16
- TSR already loaded, 6-8
- TSR programs, 5-8
- TSRs, 6-8

U

- UNAPP program, 6-9

- uninstalling Connectivity Pack, 6-4, 6-9
- unmapping drives, 5-19
- unmatched record, 4-8, 4-10

V

- versions
 - software needed, 1-2

W

- warranty, 6-9
- where to go, 1-8
- Windows
 - LapLink, 5-8
 - LapLink Remote, 5-3
 - loading LLRA1, 6-7
 - versions supported, 1-2
- Windows setup
 - unsuccessful, 6-1
- Windows Setup, 1-4
- Windows statement, 6-5

X

- Xlate/Merge, 4-1
 - batch file, 4-17
 - diagnosing, 4-18
 - editing tasks, 4-3, 4-18
 - file types, 4-1
 - running multiple tasks, 4-17
 - selected tasks, 4-17
 - task list, 4-17

Contents

- 1: Setting Up Your System
- 2: Transferring Files with the Filer
- 3: HP 200LX Applications on the PC
- 4: Merging and Translating Files
- 5: Using LapLink Remote Access to Link Computers
- 6: Troubleshooting and Warranty
- Index



Part Number F1021-90007 Edition 2

English
Printed in Singapore 12/94

