

HP 1000 A600/A600+ Computer

Reference Manual

HP 1000 A-Series

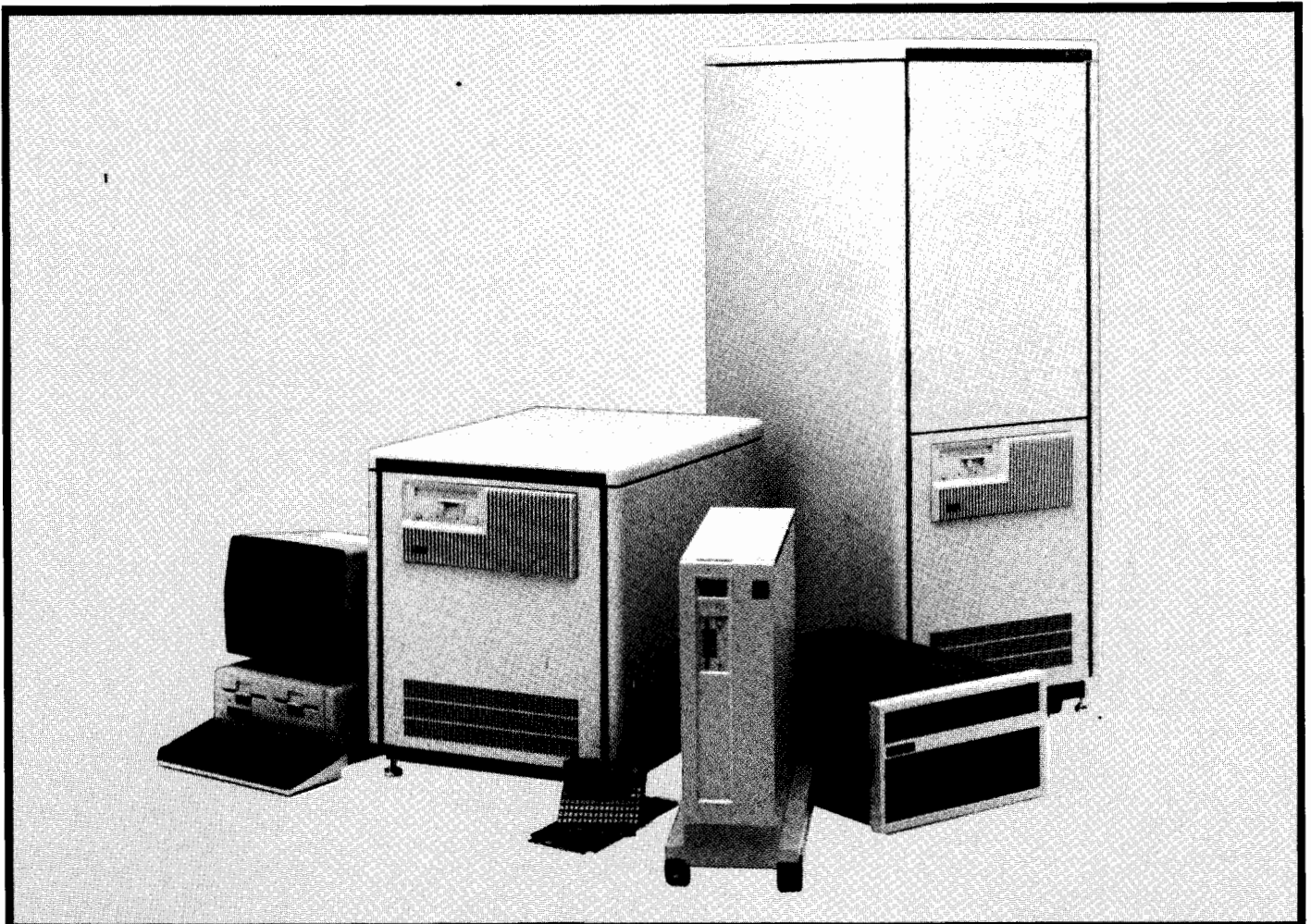

HP Computer Museum
www.hpmuseum.net

For research and education purposes only.



HP 1000 A600/A600+ Computer

Reference Manual

FEDERAL COMMUNICATIONS COMMISSION RADIO FREQUENCY INTERFERENCE STATEMENT

The Federal Communications Commission (in Subpart J, of Part 15, Docket 20780) has specified that the following notice be brought to the attention of the users of this product.

Warning: This equipment generates, uses, and can radiate radio frequency energy and if not installed and used in accordance with the instruction manual, may cause interference to radio communications. It has been tested and found to comply with the limits for Class A computing devices pursuant to Subpart J of Part 15 of FCC Rules, which are designed to provide reasonable protection against such interference. Operation of this equipment in a residential area is likely to cause interference in which case the user at his own expense will be required to take whatever measures may be required to correct the interference.



PRINTING HISTORY

The Printing History below identifies the Edition of this Manual and any Updates that are included. Periodically, Update packages are distributed which contain replacement pages to be merged into the manual, including an updated copy of this Printing History page. Also, the update may contain write-in instructions.

Each reprinting of this manual will incorporate all past Updates, however, no new information will be added. Thus, the reprinted copy will be identical in content to prior printings of the same edition with its user-inserted update information. New editions of this manual will contain new information, as well as all Updates.

To determine what software manual edition and update is compatible with your current software revision code, refer to the appropriate Software Numbering Catalog, Software Product Catalog, or Diagnostic Configurator Manual.

First Edition	Mar 1982	
Second Edition	Jun 1983	
Update 1	Dec 1983	
Reprint	Dec 1983	Update 1 has been incorporated.

NOTICE

The information contained in this document is subject to change without notice.

HEWLETT-PACKARD MAKES NO WARRANTY OF ANY KIND WITH REGARD TO THIS MATERIAL, INCLUDING, BUT NOT LIMITED TO, THE IMPLIED WARRANTIES OF MERCHANTABILITY AND FITNESS FOR A PARTICULAR PURPOSE. Hewlett-Packard shall not be liable for errors contained herein or for incidental or consequential damages in connection with the furnishing, performance or use of this material.

Hewlett-Packard assumes no responsibility for the use or reliability of its software on equipment that is not furnished by Hewlett-Packard.

This document contains proprietary information which is protected by copyright. All rights are reserved. No part of this document may be photocopied, reproduced or translated to another program language without the prior written consent of Hewlett-Packard Company.

DOCUMENTATION MAP

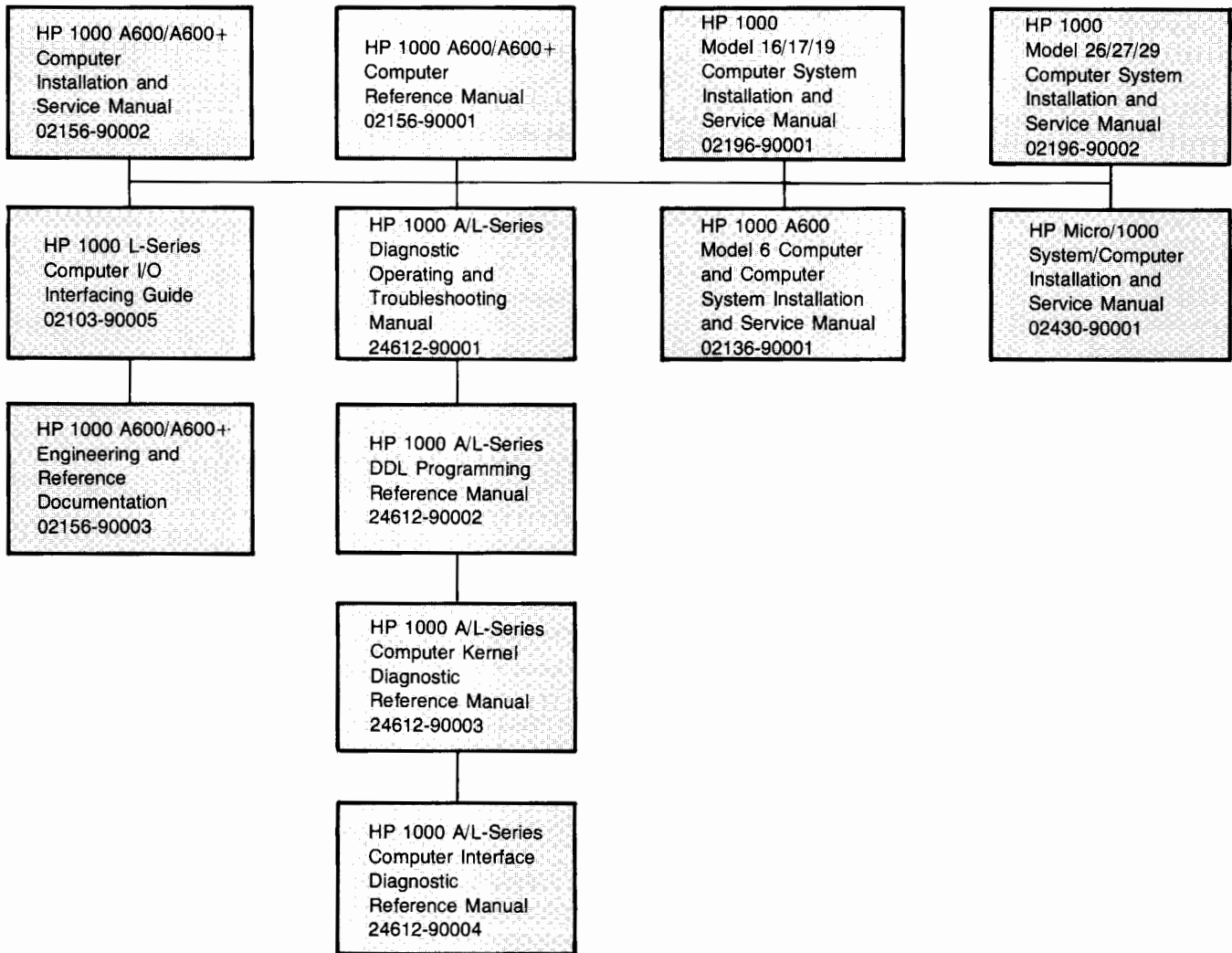

CONTENTS

Section I	Page		
GENERAL FEATURES			
Architecture	1-1	Virtual Memory Area	3-3
Virtual Control Panel	1-2	Code and Data Separation	3-3
Bootstrap Loaders	1-2	Base-Relative Addressing	3-3
Self-Test Routines	1-2	Reserved Memory Locations	3-4
Time Base Generator	1-2	Nonexistent Memory	3-4
Power Supply	1-2	Base Set Instruction Formats	3-4
Input/Output	1-3	Memory Reference Instructions	3-4
Memory	1-4	Register Reference Instructions	3-4
Software	1-4	Input/Output Instructions	3-5
HP Interface Bus	1-4	Extended Arithmetic Memory	
Computer Network	1-4	Reference Instructions	3-5
Expansion and Enhancement	1-5	Extended Arithmetic Register	
Specifications	1-5	Reference Instructions	3-5
		Extended Instructions	3-5
		Floating Point Instructions	3-5
		Double Integer Instructions	3-6
		Language Instruction Set	3-6
		Virtual Memory Instructions	3-6
		Operating System Instructions	3-6
		CDS Instructions	3-6
		Base Set Instruction Coding	3-6
		Memory Reference Instructions	3-6
		Register Reference Instructions	3-8
		Shift/Rotate Group	3-8
		Alter/Skip Group	3-11
		Input/Output Instructions	3-13
		Extended Arithmetic Memory	
		Reference Instructions	3-15
		Extended Arithmetic Register	
		Reference Instructions	3-15
		Extended Instruction Group	3-16
		Index Register Instructions	3-16
		Jump Instructions	3-21
		Byte Manipulation Instructions	3-21
		Bit Manipulation Instructions	3-23
		Word Manipulation Instructions	3-24
		Floating Point Instructions	3-25
		Single Precision Operations	3-25
		Language Instruction Set	3-26
		Double Integer Instructions	3-28
		Virtual Memory Instructions	3-30
		Operating System Instructions	3-32
		Execution Times	3-33
		Double-Precision Floating Point Instructions	3-33
		Assembly Language	3-34
		RTE Implementation	3-34
		Section IV	Page
		DYNAMIC MAPPING SYSTEM	
		Memory Addressing	4-1
		General Descriptions	4-1
		Page Mapping Register Instructions	4-1
		Working Map Instructions	4-2
		Cross-map Instructions	4-2
		Detailed Descriptions	4-3
		DMS Instruction Execution Times	4-11
		Assembly language and RTE Implementation	4-11
Section III	Page		
PROGRAMMING INFORMATION			
Data Formats	3-1		
Addressing	3-1		
Paging	3-1		
Direct and Indirect Addressing	3-3		
Memory Mapping	3-3		

CONTENTS (Continued)

<p>Section V Page</p> <p>CODE AND DATA SEPARATION</p> <p>Code and Data Addressing 5-1</p> <p>General Descriptions 5-1</p> <p> Procedure Call Instructions 5-1</p> <p> Procedure Exit Instructions 5-2</p> <p> C, Q, Z, and IQ Instructions 5-2</p> <p>Stack Frame Description 5-2</p> <p>Detailed Descriptions 5-4</p> <p>Assembly Language and RTE Implementation 5-10</p> <p>Execution Times 5-10</p> <p>Section VI Page</p> <p>INTERRUPT SYSTEM</p> <p>Power Fail Interrupt 6-1</p> <p>Parity Error Interrupt 6-3</p> <p>Memory Protect Interrupt 6-3</p> <p>Unimplemented Instruction Interrupt 6-4</p> <p>Time Base Generator Interrupt 6-4</p> <p>Virtual Memory Area Interrupt 6-4</p> <p>CDS Segment Interrupt 6-4</p> <p>Input/Output Interrupt 6-4</p> <p>Interrupt Priority 6-4</p> <p>Central Interrupt Register 6-5</p> <p>Processor Status Register 6-5</p> <p>Interrupt Type Control 6-5</p> <p>Instruction Summary 6-5</p> <p>Section VII Page</p> <p>INPUT/OUTPUT SYSTEM</p> <p>Input/Output Addressing 7-1</p>	<p>Input/Output Priority 7-1</p> <p>Interface Elements 7-4</p> <p> Global Register 7-4</p> <p> Control Bits 7-4</p> <p> Flag Bits 7-4</p> <p> Data Buffer Register 7-4</p> <p> Control Register 7-4</p> <p>Direct Memory Access 7-4</p> <p> Control Word 1 7-5</p> <p> Control Word 2 7-5</p> <p> Control Word 3 7-5</p> <p> DMA Transfer Initialization 7-5</p> <p> Self-Configured DMA 7-5</p> <p> DMA Data Transfer 7-7</p> <p>Non-DMA Data Transfer 7-7</p> <p> Input Data Transfer (Interrupt Method) 7-7</p> <p> Output Data Transfer (Interrupt Method) 7-7</p> <p> Non-Interrupt Data Transfer 7-9</p> <p>Diagnose Modes 7-10</p> <p> Diagnose Mode 1 7-10</p> <p> Diagnose Mode 2 7-10</p> <p> Diagnose Mode 3 7-10</p> <p>Appendix Page</p> <p>Character Codes A-3</p> <p>Octal Arithmetic A-4</p> <p>Octal/Decimal Conversions A-5</p> <p>Mathematical Equivalents A-6</p> <p>Octal Combining Tables A-8</p> <p>Base Set Instruction Codes in Binary A-10</p> <p>Extend and Overflow Examples A-13</p> <p>Interrupt and Control Summary A-14</p>
---	--

ILLUSTRATIONS

Title	Page	Title	Page
HP 1000 A600 Computers	1-0	Stack Frame General Layout	5-3
A600 Computer Simplified Block Diagram	1-2	Input/Output System	7-2
Loading Device Parameters and Media Formats	2-7	I/O Priority Assignment	7-2
Loader Command Format	2-10	Priority Linkage (Simplified)	7-3
Data Formats and Octal Notation	3-2	Interrupt Sequences	7-3
Base Set Instruction Formats	3-5	General Bit Definitions for Control Word 1	7-6
Shift and Rotate Functions	3-9	DMA Input Data Transfer	7-8
Examples of Double-Word Shifts and Rotates	3-17	Input Data Transfer (Interrupt Method)	7-8
Basic Logical Memory Addressing Scheme	4-1	Output Data Transfer (Interrupt Method)	7-9
Expanded Memory Addressing Scheme	4-2		

TABLES

Title	Page	Title	Page
Available I/O Slots for Standard		Typical Base Set Instruction Execution Times	3-35
Computer Configurations	1-3	Typical and Maximum Execution Times of	
Options and Accessories	1-5	Selected Instructions	3-37
Specifications	1-6	Instructions and Opcodes for	
Start-Up Switch Settings	2-3	RTE-A Implementation	3-38
Sample VCP Loader Call Back Checkout		Dynamic Mapping Instructions Execution Times . . .	4-12
Program	2-4A	CDS Instruction Execution Times	5-10
VCP Characters and Associated Registers	2-5	A600 Interrupt Assignments	6-1
VCP Commands	2-6	Sample Power Fail Subroutine	6-2
VCP Loader Command Errors	2-11	Instructions for Select Code 00 through 07	6-6
Memory Paging	3-3	Noninterrupt Transfer Routines	7-10
Reserved Memory Locations	3-4	Diagnose Mode 1	7-10
Shift/Rotate Group Combining Guide	3-9	Diagnose Mode 2	7-11
Alter/Skip Group Combining Guide	3-10		

ALPHABETICAL INDEX OF INSTRUCTIONS

Instruction	Page	Instruction	Page
ADA	Add to A 3-6	DSY	Decrement Y and Skip if Zero 3-18
ADB	Add to B 3-7	ELA	Rotate E Left with A 3-10
ADQA	Add Q to A 5-9	ELB	Rotate E Left with B 3-10
ADQB	Add Q to B 5-9	ERA	Rotate E Right with A 3-10
ADX	Add Memory to X 3-16	ERB	Rotate E Right with B 3-10
ADY	Add Memory to Y 3-18	EXIT	Procedure Exit 5-7
ALF	Rotate A Left Four 3-9	EXIT1	Procedure Exit With One Skip 5-7
ALR	A Left Shift, Clear Sign 3-9	EXIT2	Procedure Exit With Two Skips 5-7
ALS	A Left Shift 3-9	FAD	Floating Point Add 3-25
AND	"And" to A 3-7	FDV	Floating Point Divide 3-25
ARS	A Right Shift 3-9	FIX	Floating Point to Single Integer 3-25
ASL	Arithmetic Shift Left (32) 3-16	FLT	Single Integer to Floating Point 3-25
ASR	Arithmetic Shift Right (32) 3-16	FMP	Floating Point Multiply 3-25
BLF	Rotate B Left Four 3-9	FSB	Floating Point Subtract 3-25
BLR	B Left Shift, Clear Sign 3-10	HLT	Halt 3-13
BLS	B Left Shift 3-10	INA	Increment A 3-12
BRS	B Right Shift 3-10	INB	Increment B 3-12
CACQ	Copy A to C and Q 5-8	IOR	"Inclusive Or" to A 3-7
CAX	Copy A to X 3-18	ISX	Increment X and Skip if Zero 3-18
CAY	Copy A to Y 3-18	ISY	Increment Y and Skip if Zero 3-19
CAZ	Copy A to Z 5-8	ISZ	Increment and Skip if Zero 3-7
CBCQ	Copy B to C and Q 5-8	JLA	Jump and Load A 3-21
CBS	Clear Bits 3-23	JLB	Jump and Load B 3-21
CBT	Compare Bytes 3-22	JLY	Jump and Load Y 3-21
CBX	Copy B to X 3-18	JMP	Jump 3-7
CBY	Copy B to Y 3-18	JPY	Jump Indexed by Y 3-21
CBZ	Copy B to Z 5-8	JSB	Jump to Subroutine 3-7
CCA	Clear and Complement A 3-11	LAX	Load A Indexed by X 3-19
CCB	Clear and Complement B 3-11	LAY	Load A Indexed by Y 3-19
CCE	Clear and Complement E 3-11	LBT	Load Byte 3-22
CCQA	Copy C and Q to A 5-8	LBX	Load B Indexed by X 3-19
CCQB	Copy C and Q to B 5-8	LBY	Load B Indexed by Y 3-19
CIQA	Copy Interrupted to A 5-9	LDA	Load A 3-8
CIQB	Copy Interrupted to B 5-9	LDB	Load B 3-8
CLA	Clear A 3-11	LDMP	Load Map Set 4-3
CLB	Clear B 3-12	LDX	Load X from Memory 3-19
CLC	Clear Control 3-13	LDY	Load Y from Memory 3-19
CLE	Clear E 3-10, 3-12	LIA	Load Input to A 3-14
CLF	Clear Flag 3-13	LIB	Load Input to B 3-14
CLO	Clear Overflow 3-13	LPMR	Load Page Map Register 4-3
CMA	Complement A 3-12	LSL	Logical Shift Left (32) 3-16
CMB	Complement B 3-12	LSR	Logical Shift Right (32) 3-16
CME	Complement E 3-12	LWD1	Select DATA1 Map 4-4
CMW	Compare Words 3-24	LWD2	Load DATA2 Map 4-5
CPA	Compare to A 3-7	MB00	Cross Move Bytes, Execute to Execute . . . 4-9
CPB	Compare to B 3-7	MB01	Cross Move Bytes, Execute to DATA1 . . . 4-9
CXA	Copy X to A 3-18	MB02	Cross Move Bytes, Execute to DATA2 . . . 4-10
CXB	Copy X to B 3-18	MB10	Cross Move Bytes, DATA1 to Execute . . . 4-10
CYA	Copy Y to A 3-18	MB11	Cross Move Bytes, DATA1 to DATA1 . . . 4-10
CYB	Copy Y to B 3-18	MB12	Cross Move Bytes, DATA1 to DATA2 . . . 4-10
CZA	Copy Z to A 5-9	MB20	Cross Move Bytes, DATA2 to Execute . . . 4-11
CZB	Copy Z to B 5-9	MB21	Cross Move Bytes, DATA2 to DATA1 . . . 4-11
DIV	Divide 3-15	MB22	Cross Move Bytes, DATA2 to DATA2 . . . 4-11
DLD	Double Load 3-15	MBT	Move Bytes 3-22
DST	Double Store 3-15	MIA	Merge Into A 3-14
DSX	Decrement X and Skip if Zero 3-18	MIB	Merge Into B 3-14

ALPHABETICAL INDEX OF INSTRUCTIONS (Continued)

Instruction	Page	Instruction	Page
MPY	Multiply	TBS	Test Bits
MVW	Move Words	XAX	Exchange A and X
MW00	Cross Move Words, Execute to Execute	XAY	Exchange A and Y
MW01	Cross Move Words, Execute to DATA1	XBX	Exchange B and X
MW02	Cross Move Words, Execute to DATA2	XBY	Exchange B and Y
MW10	Cross Move Words, DATA1 to Execute	XCA1	Cross Compare A through DATA1 Map
MW11	Cross Move Words, DATA1 to DATA1	XCA2	Cross Compare A through DATA2 Map
MW12	Cross Move Words, DATA1 to DATA2	XCB1	Cross Compare B through DATA1 Map
MW20	Cross Move Words, DATA2 to Execute	XCB2	Cross Compare B through DATA2 Map
MW21	Cross Move Words, DATA2 to DATA1	XJCQ	Cross Map Jump (and Load C and Q)
MW22	Cross Move Words, DATA2 to DATA2	XJMP	Cross Map Jump
NOP	No Operation	XLA1	Cross Load A through DATA1 Map
OTA	Output A	XLA2	Cross Load A through DATA2 Map
OTB	Output B	XLB1	Cross Load B through DATA1 Map
PCALI	Internal Procedure Call	XLB2	Cross Load B through DATA2 Map
PCALN	Procedure Call, .ENTN Compatible	XOR	"Exclusive Or" to A
PCALR	Procedure Call, .ENTR Compatible	XSA1	Cross Store A through DATA1 Map
PCALV	Variable External Procedure Call	XSA2	Cross Store A through DATA2 Map
PCALX	External Procedure Call	XSB1	Cross Store B through DATA1 Map
RAL	Rotate A Left	XSB2	Cross Store B through DATA2 Map
RAR	Rotate A Right	.BLE	Single to Double Floating Point
RBL	Rotate B Left	.CFER	Transfer Complex or Double Floating Point
RBR	Rotate B Right	.CPM	Single Integer Arithmetic Compare
RRL	Rotate Left (32)	.CPUID	Processor Identification
RRR	Rotate Right (32)	.DAD	Double Integer Add
RSS	Reverse Skip Sense	.DCO	Double Integer Compare
SAX	Store A Indexed by X	.DDE	Double Integer Increment
SAY	Store A Indexed by Y	.DDI	Double Integer Divide
SBS	Set Bits	.DDIR	Double Integer Divide Reverse
SBT	Store Byte	.DDS	Double Integer Decrement and Skip if Zero
SBX	Store B Indexed by X	.DFER	Transfer Three Consecutive Words
SBY	Store B Indexed by Y	.DIN	Double Integer Increment
SDSP	Store Display	.DIS	Double Integer Increment and Skip if Zero
SEZ	Skip if E is Zero	.DMP	Double Integer Multiply
SFB	Scan for Byte	.DNG	Double Integer Negate
SFC	Skip if Flag Clear	.DSB	Double Integer Subtract
SFS	Skip if Flag Set	.DSBR	Double Integer Subtract Reverse
SIMP	Save Interrupted Map	.ENTC	Transfer Parameter Addresses
SLA	Skip if LSB of A is Zero	.ENTN	Transfer Parameter Addresses
SLB	Skip if LSB of B is Zero	.ENTP	Transfer Parameter Addresses
SOC	Skip if Overflow Clear	.ENTR	Transfer Parameter Addresses
SOS	Skip if Overflow Set	.FIXD	Floating Point to Double Integer
SPMR	Store Page Mapping Register	.FLTD	Double Integer to Floating Point
SSA	Skip if Sign of A is Zero	.FLUN	Unpack Floating Point Quantity
SSB	Skip if Sign of B is Zero	.FWID	Firmware Identification
STA	Store A	.IMAP	16-Bit Subscript Mapping
STB	Store B	.IRES	16-Bit Subscript Resolution
STC	Set Control	JMAP	
STF	Set Flag	JRES	
STMP	Store Map Set	.LBP	Mapping with Registers
STO	Set Overflow	.LBPR	Mapping with DEF
STX	06Store X to Memory	.LPX	Indexed Mapping with Registers
STY	Store Y to Memory	.LPXR	Indexed Mapping with DEF
SWMP	Save Working Map		
SZA	Skip if A is Zero		
SZB	Skip if B is Zero		

ALPHABETICAL INDEX OF INSTRUCTIONS (Continued)

Instruction	Page	Instruction	Page
.NGL	Double to Single Floating Point 3-28	.TFXD	Double Floating Point to Double Integer 3-33
.PACK	Normalize Floating Point Quantity 3-28	.TFXS	Double Floating Point to Single Integer 3-34
.PMAP	Map Specified Page 3-31	.TMPY	Double Floating Point Multiply 3-34
.PWR2	X Times 2 to the Power N 3-28	.TSUB	Double Floating Point Subtract 3-34
.SETP	Set A Table 3-27	.WFI	Wait for Interrupt 3-32
.SIP	Skip if Interrupt Pending 3-32	.XFER	Transfer Three Consecutive Words 3-27
.TADD	Double Floating Point Add 3-33	.ZFER	Transfer Eight Words 3-26
.TDIV	Double Floating Point Divide 3-33	..FCM	Complement and Normalize Single Floating Point 3-27
.TFTD	Double Integer to Double Floating Point 3-33	..TCM	Negate Double Floating Point 3-28
.TFTS	Single Integer to Double Floating Point 3-33		

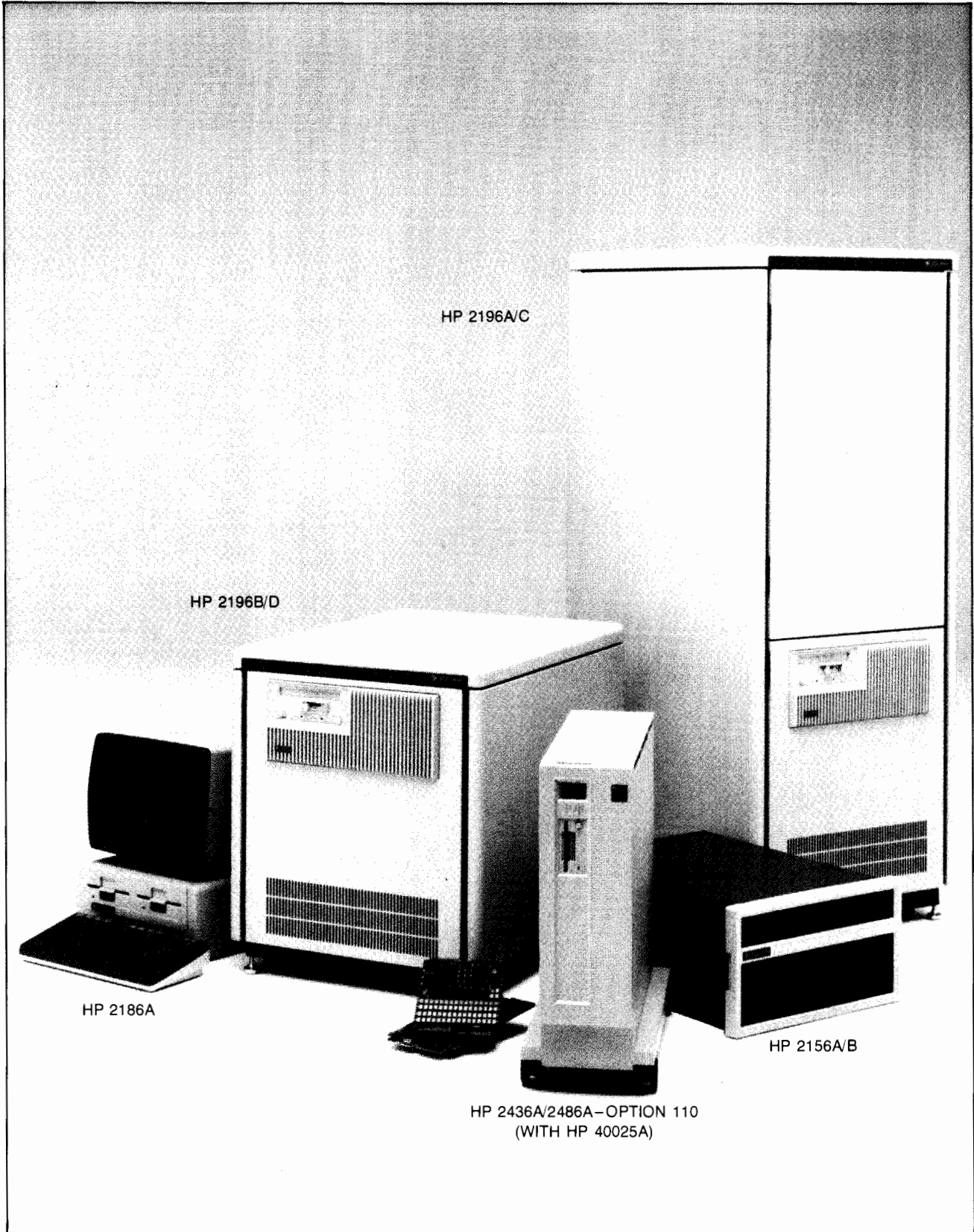

Figure 1-1. HP 1000 A600 Computers

The HP 1000 A600/A600+ Computers and System Processor Units (SPUs) (hereafter referred to as A600/A600+ computers) are members of the HP 1000 A-Series Computer family. At the heart of the A600/A600+ computer is a compact two-board CPU/memory set that yields extremely high performance for its price class. The set consists of a processor board and a fully mapped memory controller board containing up to a half-megabyte of single-bit parity memory. The A600/A600+ computers deliver full minicomputer power to a wide variety of applications, and maintain software compatibility with previous HP 1000 Computers. As shown in Figure 1-1, the A600/A600+ hardware is available as:

- HP 2106AK/BK Board Computer — a two-board set that may be used with optional 5- and 10-slot card cages for user-designed systems.
- HP 2136A/C Computer — a desktop computer with dual flexible mini-discs and 128kb of memory, asynchronous serial interface card, HP-IB interface card, and 3 slots available for additional memory or I/O. Designed as a target system for volume end users.
- HP 2136B/D Computer — same as the HP 2136A/C except without the dual flexible mini-discs and HP-IB interface card, and with 5 available slots. Can serve as a memory based node computer on a DS link.
- HP 2156A/B Computer — a complete 20-slot box computer including power supply, cooling fans, and 128kb of memory in a standard 19-inch rack-mount package.
- HP 2186A/C System Processor Unit — a desktop computer with dual flexible mini-discs, 128kb of memory, asynchronous serial interface card, HP-IB interface card, RTE-A software, and 3 slots available for additional memory and I/O.
- HP 2186B/D System Processor Unit — same as the HP 2186A except without the dual flexible mini-discs and with 4 available slots. Can serve as a memory based node computer on a DS link.
- HP 2196A/C System Processor Unit — a 1.5 metre cabinet containing the A600 computer with 128kb of memory, asynchronous serial interface card, HP-IB interface card, RTE-A software, and 16 slots available for additional memory and I/O.
- HP 2196B/D System Processor Unit — same as the HP 2196A except in a 720 mm cabinet.
- HP 2486A System Processor Unit — an A600+ computer system with 512k bytes of memory, 14 card cage slots for CPU, memory, and I/O, asynchronous interface card, HP-IB interface, and RTE-A software.
- HP 2436A Computer — an A600+ computer with 128k bytes of memory and 14 card cage slots for CPU, memory, and I/O.
- HP 2436E Computer — an A600+ execute-only computer with 128k bytes of memory and 14 card cage slots for CPU, memory, and I/O.



1-1. ARCHITECTURE

The A600/A600+ computer architecture is based on a distributed intelligence concept that separates the processing of input/output (I/O) instructions from that of other instructions. The central processor unit (CPU) resides on a single printed circuit board and features a fully microprogrammed bit-slice control processor, which executes one million instructions per second. The 56-bit wide microinstruction format eliminates much discrete decoding logic, thereby enhancing processor performance while reducing physical size and complexity. The compact one-board CPU executes the powerful HP 1000 instruction set that includes index instructions and a full complement of instructions for logical operations as well as bit and byte manipulation. Also included in the standard base instruction set of A600/A600+ computers are double-integer, single-precision floating point, virtual memory, and high-level language instruction groups, which substantially increase program execution speed. An optional double-precision enhancement package adds 19 instructions to the A600 repertoire, including double-precision floating point instructions. The CPU also performs several system level functions, including memory protect, power fail/auto restart, time base generation, parity error interrupt, unimplemented instruction interrupt, and extensive self-tests.

The A-Series architecture also includes a feature called Code and Data Separation (CDS) which accommodates programs that have up to 4 million words of code.

All input/output instructions are executed by custom silicon-on-sapphire (SOS) input/output processor (IOP) integrated circuit chips that reside on the individual I/O interface cards. A common backplane links the processor, memory, and I/O cards. The instructions are fetched from memory and decoded by the processor card. When an instruction is decoded as being of the I/O type, it is broadcast on the backplane for execution by the appro-

appropriate I/O chip. Because each I/O card is capable of operating independently of the CPU, the A600/A600+ can perform direct memory access (DMA) I/O transfers very efficiently. An I/O card interacts with the CPU only on DMA initiation and completion; beyond that, the entire high-speed transfer is handled by the I/O card, leaving the CPU free to work on other tasks. This achieves high efficiency in CPU and I/O throughput. Figure 1-2 is a simplified block diagram of the A600/A600+ computer.

1-2. VIRTUAL CONTROL PANEL

The Virtual Control Panel (VCP) program is an interactive program that enables an external device (such as a terminal) to control the CPU in a manner similar to a conventional computer control panel and also provides additional features. That is, it allows the operator to access the various registers (A, B, P, etc.), examine or change memory, and control execution of a program. The VCP program is stored in EPROM on the memory controller card. In a typical application, the VCP could be an HP 262x Terminal interfaced by an HP 12005 Asynchronous Serial Interface Card. When not being used as the VCP, the VCP-assigned terminal can be used in the same way as any other terminal connected to the system. When the A600/A600+ computer is operating as a node in a computer network via DS/1000-IV, the VCP can be an adjacent computer in the network.

1-3. BOOTSTRAP LOADERS

There are several bootstrap loaders stored in EPROM on the memory controller card. The loaders provide program loading from several sources including disc drives, PROM storage modules, a DS/1000-IV network link, HP mini-cartridge tapes, magnetic tape drives, and cartridge tapes of the HP 7908/11/12/14 Disc Drives. The first three loaders can be selected for auto-boot by switches on the central processor card; any of the loaders can be selected by operator commands via the Virtual Control Panel. However, for auto-boot from a disc drive other than the flexible mini-disc of the HP 2136A/C and 2186A/C, the system must be reconfigured during operating-system generation.

1-4. SELF-TEST ROUTINES

Self-test routines are standard in the A600/A600+ computer and are stored in PROM on the central processor card and on the memory controller card. These routines are executed whenever computer power is turned on, providing a convenient confidence-check of the processor card, memory cards, and part of the logic on each input/output card. Execution of these routines can also be initiated by a switch on the central processor card or by operator command via the Virtual Control Panel.

1-5. TIME BASE GENERATOR

The processor card includes a time base generator which can be used to time external events or to create a real-time clock in software. The time base generator (TBG) can generate an interrupt every 10 milliseconds. The TBG, which can be enabled and disabled by standard I/O instructions, is disabled at power up.

The A600+ provides a programmable time base generator (TBG), allowing finer resolution in counting time increments. The programmable TBG also simplifies the migration of real-time programs from one processor to another.

1-6. POWER SUPPLY

A600/A600+ computers have a power supply designed to continue normal operation in environments where ac line power may fluctuate widely. Input line voltages and frequencies may vary widely without affecting the operation of the computer.

For the HP 2156 or 2196A/B/C/D computers, an optional battery backup pack (12157A) can be installed in the

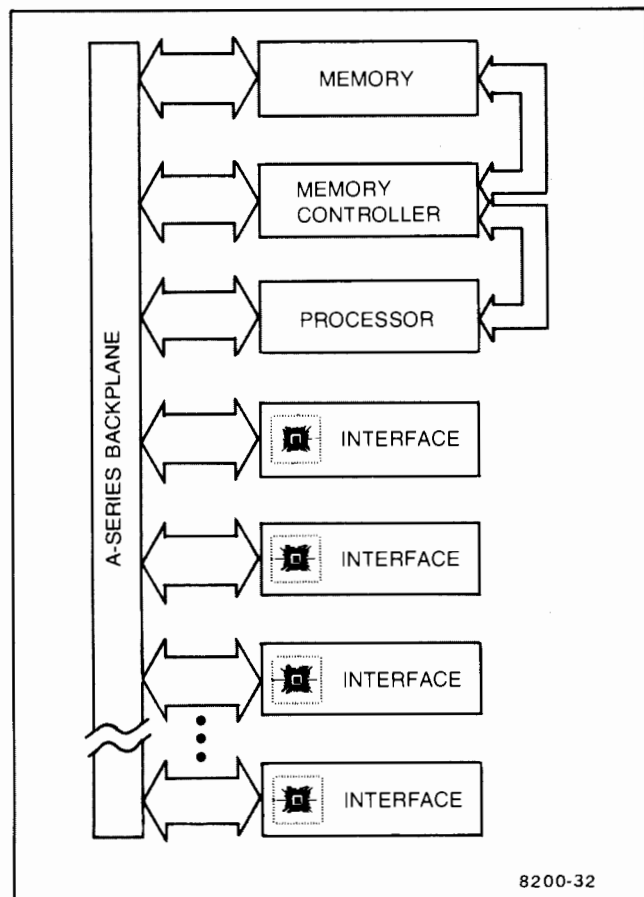

Figure 1-2. A600 Computer Simplified Block Diagram

power supply to sustain up to 4M bytes of memory for at least 20 minutes in the event of a complete power failure, thus providing an automatic restart capability. For the HP 2436 or 2486A, an optional battery backup card sustains up to 4M bytes of memory for at least 45 minutes. An external battery can be connected when there is a need to sustain memory for longer periods of time.

For the HP 2136A/B/C/D or 2186A/B/C/D computers, an optional battery backup card (12013A) can be installed in the card cage, rather than in the power supply, to sustain for at least one hour up to 512k bytes of memory on the memory controller card. The battery backup card does not support memory expanded with memory array cards (12103x).

Another power supply option (HP 2156A/B or 2196A/B/C/D only) provides two 25-kHz voltages that can be rectified at the load and used to power accessory plug-in cards used for measurement and control applications.

1-7. INPUT/OUTPUT

The input/output system for A600/A600+ computers features a custom SOS chip on each I/O card, enabling each card to process its own I/O instructions and handle direct memory access (DMA) data transfers. The I/O system has a multilevel vectored priority interrupt structure with 53 distinct interrupt levels, each of which has a unique priority assignment. Any I/O device can be selectively enabled or disabled, or all I/O devices can be enabled or disabled under program control.

Data transfer between the computer and I/O devices can take place under DMA control or program control. The DMA capability provides a direct link between memory and I/O devices. The total bandwidth through multiple DMA channels is 4.27 million bytes (2.13 million words) per second.

The A600/A600+ computer backplane provides the link between the processor, memory, interface cards, and the power supply. The backplane has slots for either 8 (HP 2136A/B/C/D or 2186A/B/C/D), or 20 (HP 2156A/B or 2196A/B/C/D), or 16 (HP 2436A/E or 2486A) plug-in cards. In all computer configurations, one slot must be used for the processor card and another for the memory controller card. Depending on the computer configuration and options included, additional card slots are used for each optional memory array card, terminal interface card, disc drive interface card, flexible mini-disc controller card, and optional battery backup card. The standard computer configurations and available I/O slots are listed in Table 1-1.

The A600/A600+ computer uses the HP A/L-Series I/O cards and an important feature of these cards is a common-content Global Register which can be loaded with the select code of a specific I/O card. When the Global Register is enabled all I/O instructions are executed only by the I/O card whose select code is in the Global Register. This not only facilitates setting up DMA transfers but also makes reconfiguration of an I/O driver a simple matter of changing the Global Register to the appropriate select code. Also, since the Global Register can direct I/O instructions to a specific I/O card, the I/O-instruction address bits can be used to access registers on an I/O card. This feature is utilized in the design of the A/L-Series I/O cards to increase their capabilities.

About one-third of the area on all A/L-Series I/O cards is occupied by identical logic called the I/O Master, consisting of an I/O processor chip and its associated logic. The I/O Master is also available in breadboard form for users who wish to design their own I/O cards. The I/O Master is described in detail in the *HP 1000 L-Series Computer I/O Interfacing Guide*, part no. 02103-90005.

Table 1-1. Available I/O Slots for Standard Computer Configurations

COMPUTER	STANDARD			AVAILABLE SLOTS	OPTIONAL	
	ASIC	HP-IB	CONTROLLER		MEMORY	BACKUP
HP 2136A/C	1	1	1	3	3*	1
HP 2136B/D	1	—	—	5	3*	1
HP 2156A/B	—	—	—	18	4	—
HP 2186A/C	1	1	1	3	3*	1
HP 2186B/D	1	1	—	4	3*	1
HP 2196A/C	1	1	—	16	4	—
HP 2196B/D	1	1	—	16	4	—
HP 2436A/E	—	—	—	14	4	2
HP 2486A	1	1	—	10	4	2

* Note: Optional memory array cards can not be used if battery backup card is installed.

1-8. MEMORY

The standard memory system of A600/A600+ computers is the HP 12102A/B Memory Controller Card, which contains 128k bytes of semiconductor memory based on 64k-bit NMOS/RAM chips; an optional 512k-byte memory controller card (HP 12102B) may replace the standard 128k-byte card. Main memory contained on the memory controller card can be expanded by the addition of up to four HP 12103A/C/D Memory Array Cards, which have 128k, 512k, and 1024k bytes of dynamic random-access memory (RAM), respectively.

The maximum memory size available in A600/A600+ computers is three million bytes for the HP 2136A/B/C/D or HP 2186A/B/C/D, four million bytes for the HP 2156A/B, 2196A/B/C/D, 2436A/E, and 2486A. Addressing physical memory configurations larger than 64k bytes is made possible by the use of the Dynamic Mapping System (DMS), which is standard in the A600/A600+ and is described in Section IV. The DMS is a powerful memory management scheme that allows A600/A600+ computer users to address up to 32 megabytes of memory and provides user-selectable write protection of each individual 2048-byte page. The A600+ also provides read protection for each page. For data integrity, memory parity checking is provided as a standard feature, and a parity-valid indicator light is provided on each memory array card for quick fault isolation.

1-9. SOFTWARE

Software support for the A600/A600+ computers begins with RTE-A, a member of HP's family of Real-Time Executive (RTE) operating systems. RTE-A is a real-time multiprogramming, multi-user system designed to take full advantage of the A600/A600+ I/O structure to enhance overall CPU and I/O throughput. RTE-A offers a wide range of configurations, from a small, memory-based, execute-only system to a full disc-based system with on-line program development. Utilizing the A600/A600+ mapped memory system, RTE-A supports memory sizes from 128k bytes to three megabytes (HP 2136A/B/C/D and 2186A/B/C/D) or four megabytes (HP 2156A/B, 2196A/B/C/D, 2436A, and 2486A/E). Memory can be divided into fixed and dynamically allocated partitions at system generation time. Critical programs can be made resident in fixed partitions to ensure fastest possible response to requests for their execution. Other programs can be assigned partitions from the dynamic memory pool according to need, using the smallest available block of memory.

RTE-A also supports Virtual Memory Addressing (VMA) for access to data arrays much larger than main memory (up to 128 megabytes). The disc functions as an extension of main memory so far as data is concerned, in a manner that is transparent to the user and does not require any special programming. In addition, RTE-A supports a

special case of VMA, called Extended Memory Area (EMA). With EMA, up to two megabytes of a program's data can be in main memory at once, which affords faster processing of data arrays small enough to use the EMA capability. The programmer chooses the data array handling mode at program load time.

The HP 92078A software accessory package provides support for programs that have up to 4M words of code through a feature called Code and Data Separation (CDS). With CDS, a large application program is automatically segmented by the LINK loader program into one or more code segments, in addition to a data segment which may be up to 31k words in size; the program may also access a VMA area. The code segments may reside on disc or in memory, and the process of accessing code segments in physical memory, or loading a code segment from disc into physical memory, is automatically handled by a combination of microcode and software. CDS is described further in Section V.

Disc-based RTE-A systems support program development in FORTRAN 77, Pascal, BASIC, and Macro/1000 Assembly Language. Program development for the A600/A600+ can also be performed on an HP 1000 System under RTE-6/VM or RTE-IVB.

Diagnostic packages listed in Table 1-2 are used for testing and fault location.

1-10. HP INTERFACE BUS

Among the I/O interface cards available for the A600/A600+ computer is the HP 12009A HP-IB Interface Card which can interface the A600/A600+ computer to a variety of HP peripherals and other equipment compatible with the Hewlett-Packard Interface Bus (HP-IB). (HP-IB is the Hewlett-Packard implementation of IEEE standard 488-1978, "Digital Interface for Programmable Instrumentation".) A single HP 12009A can control up to 14 HP-IB instruments and several can be used to achieve concurrent operation of multiple HP-IB instrumentation clusters under the RTE-A multiprogramming operating system. However, a maximum of only four hard discs of comparable speed (standard or high-speed) should be assigned to a single HP 12009A, as disc demands on bus capacity are often so high as to impair performance of other devices connected to the same HP-IB interface as the discs.

1-11. COMPUTER NETWORK

The user can configure the A600/A600+ computer into an HP DS/1000-IV Distributed System by using either an HP 12007A or an HP 12044A HDLC Interface. Both of these interfaces support the high-level data link communications (HDLC) protocol, functioning as a preprocessor to

handle low and medium levels of protocol processing. The A600/A600+ computers can be easily mixed with other members of the HP 1000 family in a single computer network. The HP 12042A Programmable Serial Interface allows the sophisticated OEM to design his own customized protocol for networks. HP provides a customer course on how to program the PSI card.

1-12. EXPANSION AND ENHANCEMENT

Table 1-2 lists accessory products available to expand or enhance the A600/A600+ computers.

1-13. SPECIFICATIONS

HP 1000 Computer Systems, A/L-Series Technical Data Handbook, part no. 5953-8712 provides complete specifications for the A600/A600+ computers and systems. Table 1-3 provides an abridged set of A600/A600+ specifications. Except where indicated, the specifications are common to all A600/A600+ computers and systems. The computers and computer systems have been product accepted by the Underwriters' Laboratories (UL) and the Canadian Standards Association (CSA). The A600/A600+ computers and systems also meet the RFI standards of the Federal Communications Commission (FCC) and Verband Deutscher Elektrotechniker (VDE).

Table 1-2. Options and Accessories

DESCRIPTION	PRODUCT NO.	OPTION NO.
Install 512k byte instead of 128k byte memory controller card	—	012
230 Vac Operation	—	015
128k Byte Memory Array Card	12103A	—
512k Byte Memory Array Card	12103C	—
1024k Byte Memory Array Card	12103D	—
Memory Connector for one memory array card	12038A	—
Memory Connector for two memory array cards	12038B	—
Memory Connector for three memory array cards	12038C	—
Memory Connector for four memory array cards	12038D	—
Asynchronous Serial Interface	12005A	—
Parallel Interface	12006A	—
HDLC Interface (modem operation)	12007A	—
PROM Storage Module	12008A	—
HP-IB Interface	12009A	—
Intelligent Breadboard	12010A	—
Extender Board	12011A	—
Priority Jumper Card	12012A	—
Battery Backup Card	12013A*	—
8-Channel Asynchronous Multiplexer	12040B	—
Programmable Serial Interface	12042A	—
HDLC Interface (hard-wired operation)	12044A	—
High-Level Analog Input Card	12060A†	—
Expansion Multiplexer Card	12061A†	—
Analog Output Card	12062A†	—
16-In/16-Out Isolated Digital I/O Card	12063A†	—
DS/1000-IV Data Link Slave Interface	12072A	—
DS/1000-IV Modem Interface to HP 3000	12073A	—
LAP-B Network Interface	12075A	—

Table 1-2. Options and Accessories (Continued)

DESCRIPTION	PRODUCT NO.	OPTION NO.
DS/1000-IV Direct Connect Interface to HP 3000	12082A	—
Battery Backup Card	12154A*	—
Power Fail Recovery System	12157A*	—
25 kHz Power Module	12158A**	—
25 kHz Power Module	12159A	—
Diagnostic Package for A600/A600+ processor and interfaces	24612A‡	—
Diagnostic Package for A600/A600+ compatible hard disc drives and magnetic tape units	24398B‡	—

* The 12013A card is used only with the HP 2136A/B/C/D and 2186A/B/C/D, the 12157A card with the HP 2156A/B/C/D and 2196A/B/C/D, and the 12154A with the HP 2436A and 2486A.

† Measurement and control accessories requiring 25 kHz ac power cannot be used with the HP 2136A/B/C/D or 2186A/B/C/D computers.

** Only supported on the HP 2156A/B and 2196A/B/C/D computers.

‡ Included with the HP 2186A/B/C/D, 2196A/B/C/D, and 2486A System Processor Units.

Table 1-3. Specifications

COMMON SPECIFICATIONS	
CENTRAL PROCESSOR	
Word Size:	16 bits.
Cycle Time:	227 nanoseconds.
Microinstruction Word Width:	56 bits.
Logical Address Space:	64k bytes.
Instruction Set:	182 standard instructions (239 for A600+).
Memory Reference:	14
Register Reference:	39
Input/Output:	13
Extended Arithmetic:	12
Extended Instructions:	32
Bit, Byte, Word Manipulation:	10
Floating Point:	6 (8 for A600+)
Dynamic Mapping	22 (40 for A600+)
Double Integer:	9 (12 for A600+)
EMA/VMA:	7 (9 for A600+)
Language Instruction Set	14 optional instructions (17 for A600+).
Operating System Assist:	4
Double-Precision Floating Point	8 (A600+ only).
Code and Data Separation Set	21 (A600+ only).

Table 1-3. Specifications (Continued)

COMMON SPECIFICATIONS	
Registers:	
Accumulators:	Two (A and B), 16 bits each. Implicitly addressable, also explicitly addressable as memory locations.
Index:	Two (X and Y), 16 bits each.
Program Counter:	One (P), 15 bits.
Base Register:	One (Q), 15 bits.
Supplementary:	Two (Overflow and Extend), one bit each.
Memory Protect:	Two (V and Z), 15 bits each.
Parity:	One (PE), 24 bits.
Interrupt:	One (CIR), 6 bits.
Mode Register:	One (C), one bit.
MEMORY	
Memory Structure:	64 pages minimum of 2048 bytes per page, with direct access to current page or base page (or a page on the stack for A600+) (page 00), and indirect or mapped access to all other pages.
Memory Size:	128k bytes is standard, expandable to: 2136A/B/C/D, 2186A/B/C/D: 3072k bytes. 2156A/B, 2196A/B/C/D, 2436A/E, 2486A: 4096k bytes. Virtual memory for data arrays up to 128M bytes, divided between main memory and disc. A600+ only: Virtual memory for programs up to 8M bytes, divided between main memory and disc. Size of memory supported by optional power fail provisions: 2136A/B/C/D, 2186A/B/C/D: battery backup supports only 128k or 512k-byte memory controller card. (No memory array card.) 2156A/B, 2196A/B/C/D, 2436A/E, 2486A: battery backup supports up to 4096k-byte main memory.
Memory Cycle Time:	RAM: 454 nanoseconds (two cycles). ROM: 682 nanoseconds (three cycles).
Memory Parity Checking:	Parity logic on the memory cards continuously generates single-bit parity for all words written into memory and monitors the parity of all words read out of memory. Either odd or even parity can be selected programmatically. A parity error generates an interrupt to memory location 00005, which must contain an indirect JSB or JMP to a user-supplied parity error handling subroutine (included in RTE-A). (No I/O instructions in trap cell.)
INTERRUPT SYSTEM	
Power Fail Provisions:	When primary line power falls below a predetermined level while the computer is running, a power fail warning signal from the computer power supply causes an interrupt to memory location 00004. This location is intended to contain a jump-to-subroutine (JSB) instruction to a user-supplied power fail subroutine, such as that included in the RTE-A operating system. A minimum of 5 milliseconds is available to execute the power fail subroutine.
Time Base Generator Interrupt:	A time base generator interrupt is provided for maintaining a real time clock. The interrupt request is made when the CPU signals, at 10-millisecond intervals, that its internal clock has rolled over. Timing accuracy of the time base generator is ± 2 seconds per 24-hour day.



Table 1-3. Specifications (Continued)

COMMON SPECIFICATIONS	
Unimplemented Instruction:	An unimplemented instruction interrupt is requested when the CPU signals that the last instruction fetched was not recognized. This interrupt provides entry to software routines for the execution of instruction codes not recognized by the A600/A600+ processor or the I/O cards.
Memory Protect:	Memory protect logic on the memory controller: <ol style="list-style-type: none"> 1. Protects memory on a page-by-page basis against alteration, access, or entry by programmed instructions, except those referencing the A and B-registers. A memory protect violation will interrupt the CPU and save the address of the violating instruction in a register on the memory controller card, which the A- or B-register can access by a single Assembly language instruction. 2. Prohibits execution of privileged instructions (mapping instructions and all I/O instructions except those referencing select code 01, the CPU switch register, and the overflow register, but not including HLT, are privileged). This limits control of I/O and mapping operations to the operating system or other privileged programs.
INPUT/OUTPUT	
Determination of I/O Address:	The I/O address select code is set for each interface card by select code switches on the card and is therefore independent of interface card position in the card cage.
I/O Device Interrupt Priority:	Depends upon I/O interface card position in the card cage with respect to the processor card.
Interrupt Masking:	The I/O Master Logic includes an interrupt mask register which provides for selective inhibition of interrupts from specific interfaces under program control. This capability can be programmed to temporarily cut off undesirable interrupts from any combination of interfaces when they could interfere with crucial transfers.
Interrupt Latency Without DMA Interference:	4.7 to 40 microseconds; 5.1 microseconds typical. (Interrupts cannot be serviced until a DMA cycle or an instruction in progress has completed execution.) The worst-case latency of 40 microseconds is based upon time to complete loading or storing of a map (LMAP, SMAP), the longest standard instruction.
Direct Memory Access (DMA):	The I/O processor chip supports DMA capability on each I/O interface, which reduces the number of interrupts from one per data item (byte or word) to one per complete DMA block.
DMA Latency:	Time interval from Service Request by an I/O device through completion of the DMA I/O data transfer to or from the I/O interface is 0.908 microseconds for input, 1.135 microseconds for output for the interface with highest hardware I/O priority.
Data Packing Under DMA:	When byte mode is specified in DMA Control Word, the I/O processor chip automatically manages byte packing or unpacking.
Maximum Achievable DMA Rate:	2.13 million words (4.27 megabytes) per second.
Self-Configured DMA Timing:	4.5 to 7.1 microseconds between successive block transfers of a chained series.
I/O Master Signals and Timing:	Refer to the HP 1000 L-Series I/O interfacing guide, part no. 02103-90005.

Table 1-3. Specifications (Continued)

COMMON SPECIFICATIONS				
POWER SUPPLY FOR HP 2136A/B/C/D, 2186A/B/C/D				
Output:	DC voltages, tolerances, and Periodic and Random Deviation:			
	+5V	±2%	40mV	
	+12V	±5%	40mV	
	-12V	±5%	40mV	
	The total power output is limited to 175W up to 4.6 km (15,000 ft).			
Short Circuit Protection:	All dc power outputs are fault protected for short circuits. The DC outputs will current-limit if short circuited.			
+5V Output Overvoltage Protection:	The +5V is sensed for overvoltage and the +5V supply shuts down if its output voltage exceeds 5.5V. The ac power switch must be cycled to reset the +5V output.			
POWER SUPPLY FOR HP 2156A/B, 2196A/B/C/D				
Output:	DC voltages and tolerances:			
	+5V	±2%		
	+12V	+6/-3%		
	-12V	±6%		
Optional AC Voltages and Tolerances:	27V rms ±8%, 25 kHz nominal, split phase from three pins on backplane-mating connector. Total harmonic distortion: <10%.			
Maximum Output Current Ratings:	+5V	+5M	+12V	-12V
	68A	5.0A	5.2A	3.5A
				25 kHz
				2.5A
Short Circuit Protection:	All dc and ac power outputs are fault protected for short circuits. The power supply will shut down if any of the outputs are short circuited at turn on.			
+5V Output Overvoltage Protection:	The +5V output is sensed for overvoltage and the +5V supply shuts down if its output voltage exceeds 5.5V. The ac power switch must be cycled to reset the +5V output.			
DC REQUIRED:	All packages have sufficient power and cooling capability to support all available interfaces and accessories except for HP 2136A/B/C/D and 2186A/B/C/D, which do not support the 25 kHz Power Module, nor the interfaces which require 25 kHz.			
POWER SUPPLY FOR HP 2436A/E, 2486A				
Output:	DC voltages and tolerances.			
	+5V	±2%		
	+12V	+6/-3%		
	-12V	±6%		
Maximum Output Current Ratings:	+5V	+12V	-12V	
	50A	7.0A	3.0A	
Short Circuit Protection:	All dc power outputs are fault protected for short circuits. The power supply will shut down if any of the outputs are short circuited at turn on.			
25 kHz AC VOLTAGE FOR HP 2436A/E, 2486A				
Device:	HP 12159A 25 kHz Power Module.			
Application:	The Power Module provides 27V rms ±8%, 25 kHz nominal, split phase from three pins on the backplane-mating connector. Maximum output power is 30 Watts.			
BATTERY BACKUP FOR HP 2136A/B/C/D, 2186A/B/C/D (OPTIONAL)				
Device:	12013-60001 Battery Backup Card.			
Application:	When fully charged, sustains a maximum of 512 kilobytes of memory (memory controller card only) for one hour.			
Recharge time:	14 hours for fully discharged battery pack.			
Battery type:	Nickel-cadmium.			

Table 1-3. Specifications (Continued)

COMMON SPECIFICATIONS**BATTERY BACKUP FOR HP 2156A/B, 2196A/B/C/D (OPTIONAL)**

Device:	12157-60001 Battery Backup Card 1420-0304 Battery Pack
	Provides from 15 to 90 minutes of hold-up, depending on the system configuration, state of charge, and temperature; additional hold-up time can be achieved by connecting an external battery.
Recharge time:	12 hours for fully discharged battery pack.
Battery type:	Sealed lead acid.

BATTERY BACKUP FOR HP 2436A/E, 2486A

Device:	HP 12154A Battery Backup Module.
Application:	The Battery Backup Module provides from 45 to 210 minutes of memory sustaining power depending upon system configuration, state of charge, and temperature; additional hold-up time can be achieved by connecting an external battery.
Recharge Time:	14 hours for fully discharged battery pack.
Battery Type:	Nickel cadmium.

SPECIFICATIONS APPLICABLE ONLY TO HP 2136A/B/C/D AND 2186A/B/C/D**ELECTRICAL SPECIFICATIONS****(Excluding Terminal and Keyboard)****AC Power Required:**

Line Voltage:	86-138V (115V -25%/+20%) standard; 178-276V (230V -23%/+20%) option 015.
Line Frequency:	47.5 to 66 Hz.
Maximum Power Required:	300 Watts.

PHYSICAL CHARACTERISTICS**(Including Terminal and Keyboard)****Dimensions:**

Height:	45 cm (17.7 in.).
Width:	39.1 cm (15.4 in.).
Depth:	73.7 cm (29 in.).

Weight:	2136A/C, 2186A/C: 31.8 kg (70 lb). 2136B/D, 2186B/D: 26.4 kg (58 lb).
----------------	--

Ventilation: Two 70 cfm fans provide cooling for terminal and SPU.

Maximum Heat Dissipation: 404 kilogram-calories/hr (1604 BTU/hr), including 262x option 090 terminal with option 050 printer.

ENVIRONMENTAL SPECIFICATIONS**Temperature:**

Operating:	2136A/C, 2186A/C: 10° to 40°C (50° to 104°F). 2136B/D, 2186B/D: 0° to 55°C (32° to 131°F); derated to: 5° to 55°C (41° to 131°F) if 12013A battery backup is installed; or derated to: 5° to 40°C (41° to 104°F) if terminal with option 050 printer is used.
------------	--

Table 1-3. Specifications (Continued)

SPECIFICATIONS APPLICABLE ONLY TO HP 2136A/B/C/D AND 2186A/B/C/D (Continued)

Non-operating:	-40° to 60°C (-40° to 140°F).
Relative Humidity:	2136A/C, 2186A/C: 20% to 80% non-condensing. 2136B/D, 2186B/D: 5% to 95% non-condensing; derated to: 5% to 80% non-condensing if terminal with option 050 printer is used.
Altitude:	
Operating:	To 4.6 km (15,000 ft).
Non-operating:	15.3 km (50,000 ft).
Vibration and Shock:	HP 1000 A600-Series products are type tested for normal shipping and handling shock and vibration. (Contact factory for review of any application that requires operation under continuous vibration.)

SPECIFICATIONS APPLICABLE ONLY TO THE HP 2156A/B COMPUTER**ELECTRICAL SPECIFICATIONS****AC Power Required:**

Line Voltage:	86-138V (115V -25%/+20%) standard; 178-276V (230V -23%/+20%) option 015.
Line Frequency:	47.5 to 66 Hz.
Maximum Power Required:	700 Watts.

PHYSICAL CHARACTERISTICS**Dimensions:**

Height:	266 mm (10.5 in.).
Width:	483 mm (19 in.).
Depth:	612 mm (24 in.).

Weight: 29.5 kg (65 lb).

Ventilation: Four fans provide approximately 10.1 cubic meters per minute (360 CFM) front-to-rear airflow, half through the card cage and half to cool the power supply.

ENVIRONMENTAL SPECIFICATIONS**Temperature:**

Operating:	0° to 55°C (32° to 131°F) up to 3048 metres (10,000 ft); 0° to 45°C (32° to 113°F) up to 4572 metres (15,000 ft).
Non-operating:	-40° to 75°C (-40° to 167°F). derated to: -40° to 60°C (-40° to 140°F) with 12157A power fail option.

Relative Humidity: 5% to 95% non-condensing.

Altitude:

Operating:	To 4.6 km (15,000 ft).
Non-operating:	To 15.3 km (50,000 ft).

Vibration and Shock: HP 1000 A600-Series products are type tested for normal shipping and handling shock and vibration. (Contact factory for review of any application that requires operation under continuous vibration.)

Table 1-3. Specifications (Continued)

SPECIFICATIONS APPLICABLE ONLY TO HP 2196A/B/C/D SYSTEMS**ELECTRICAL SPECIFICATIONS****Standard Line Voltage and Line Frequency:**

Line Voltage (With 7908R):	88-127V (115V nominal).
Line Voltage (With 7911R, 7912R, or 7914R):	90-105V (100V nominal) or 108-126V (120V nominal).
Line Frequency:	With 7908R: 47.5 to 66 Hz. With 7911/12R/14R: 54 to 66 Hz.

Option 015 Line Voltage and Line Frequency:

Line Voltage (With 7908R):	187-253V (230V nominal).
Line Voltage (With 7911R, 7912R, or 7914R):	198-231V (220V nominal) or 216-252V (240V nominal).
Line Frequency:	With 7908R: 47.5 to 66 Hz. With 7911/12R/14R: 48 to 55 Hz.

Power Requirements:

Requires at least 20 Ampere grounded power receptacle for 115 Vac operation, or at least 10 Ampere grounded power receptacle for 230 Vac operation (option 015). The 2196A/C requires split-phase power; the 2196B/D requires single-phase power. An additional power receptacle is required for the system console.

Maximum Current Required:

2196A/C: 16 Amperes per phase.
2196B/D: 16 Amperes.

PHYSICAL CHARACTERISTICS**Dimensions:**

Height:	2196A/C: 1613 mm (63.4 in.). 2196B/D: 720 mm (28.3 in.).
Width:	635 mm (25 in.).
Depth:	813 mm (32 in.).

Weight:

Without disc drive:	2196A/C: 139.7 kg (307.5 lb). 2196B/D: 94.3 kg (207.5 lb).
7908R Disc Drive adds:	37.0 kg (81.6 lb).
7911R/12R/14R Drive adds:	67.3 kg (148 lb).

Racking Limitations:

The additional space in the top half of the 2196A/C cabinet is intended for instrumentation installed on rails and not on slides.

ENVIRONMENTAL SPECIFICATIONS**Temperature:**

Operating:	0° to 55°C (32° to 131°F) up to 3048 metres (10,000 ft); 0° to 45°C (32° to 113°F) up to 4572 metres (15,000 ft).
Non-operating:	-40° to 60°C (-40° to 140°F).

Relative Humidity:

SPU only:	5% to 95% with maximum wet bulb temperature not to exceed 25.6°C (78.1°F), excluding all conditions which cause condensation.
7908R/11R/12R/14R Disc:	20% to 80% non-condensing.

Table 1-3. Specifications (Continued)

SPECIFICATIONS APPLICABLE ONLY TO THE HP 2196A/B/C/D SYSTEMS (Continued)**Altitude:**

Operating:	To 4.6 km (15,000 ft).
Non-operating:	To 15.3 km (50,000 ft).

Vibration and Shock:

HP 1000 A600-Series products are type tested for normal shipping and handling shock and vibration. (Contact factory for review of any application that requires operation under continuous vibration).

SPECIFICATIONS APPLICABLE ONLY TO THE HP 2436A/E AND 2486A**ELECTRICAL SPECIFICATIONS****AC Power Required:**

Line Voltage:	86-138V (115V $-25%/+20%$) standard; 178-276V (230V $-23%/+20%$) option 015.
Line Frequency:	47.5 to 66 Hz.
Operating Current:	6A, max. in 115V configuration; 3A, max. in 230V configuration.

PHYSICAL CHARACTERISTICS**Dimensions:**

Height:	178 mm (7 in)
Width:	483 mm (19 in)
Depth:	648 mm (25.5 in)

Weight:

Without Integral Discs:	16.3 kg (36 lb)
Integral Discs Add:	2.27 kg (5 lb)

Ventilation:

Air intake is in through the left; exhaust is out through the right.

ENVIRONMENTAL SPECIFICATIONS**Temperature:**

Operating:	0° to 55°C (32° to 131°F) to 3048 metres (10,000 ft) without Option 110 internal discs. Maximum temperature is linearly derated 2°C (3.6°F) for each 304.8m (1000 ft) increase of altitude. Resulting temperature range is 0° to 45°C (32° to 113°F) at 4572 metres (15,000 ft). 5° to 45°C (40° to 113°F) with Option 110 internal discs; maximum rate of change <10°C (18°F) per hour.
Non-operating:	-40° to 75°C (-40° to 167°F) (maximum temperature with Option 110 internal discs is 60°C (140°F)).

Relative Humidity:

Without Option 110 Discs:	Operating: 5% to 95% with maximum wet bulb temperature not to exceed 40°C (104°F), excluding all conditions which cause condensation.
With Option 110 Discs:	Operating 20% to 80% with maximum wet bulb temperature not to exceed 29°C (85°F), excluding all conditions which cause condensation.
Non-Operating:	5% to 95% non-condensing.

Altitude:

Operating:	To 4.6 km (15,000 ft).
Non-operating:	To 15.3 km (50,000 ft)

This section describes the bootstrap loaders, the Virtual Control Panel (VCP) program, and the central processor registers accessible to the programmer.

2-1. HARDWARE REGISTERS

The processor card has several working registers that can be selected for display and modification via the Virtual Control Panel program. (Interface card registers are described in Section VI of this manual and in the interface card reference manuals.) The functions of these processor card registers are described in the following paragraphs.

2-2. A-REGISTER

The A-register is a 16-bit accumulator that holds the results of arithmetic and logical operations performed by programmed instructions. This register can be addressed directly by any memory reference instruction as location 000000 (octal), thus permitting interrelated operations with the B-register (e.g., "add B to A," "compare B with A," etc.) using a single-word instruction.

2-3. B-REGISTER

The B-register is a second 16-bit accumulator which can hold the results of arithmetic and logical operations completely independently of the A-register. The B-register can be addressed directly by any memory reference instruction as location 000001 (octal) for interrelated operations with the A-register.

2-4. P-REGISTER

The 15-bit P-register holds the address of the next instruction to be fetched from memory.

2-5. EXTEND (E) REGISTER

The one-bit extend (E) register is used by rotate instructions to link the A- and B-registers or to indicate a carry from the most-significant bit (bit 15) of the A- or B-register by an add instruction or an increment instruction. This is of significance primarily for multiple-precision arithmetic operations. If already set (logic 1), the extend bit cannot be cleared by a carry. However, the extend bit can be selectively set, cleared, complemented, or tested by programmed instructions. If arithmetic instructions are not being executed, the E-register can be used as a Flag.

2-6. OVERFLOW (O) REGISTER

The one-bit overflow (O) register is used to indicate that an add instruction, divide instruction, or an increment instruction referencing the A- or B-register has caused the accumulators to exceed the maximum positive or negative number that can be contained in these registers. The overflow bit can be selectively set, cleared, or tested by programmed instructions. If arithmetic instructions are not being executed, the O-register can be used as a Flag.

2-7. CENTRAL INTERRUPT REGISTER

The central interrupt register is a six-bit register that holds the select code of the last interface card or internal condition whose interrupt request was serviced.

2-8. VIOLATION REGISTER

The violation register is a 15-bit register that records the logical address of any fetched instruction that violates memory protection or privileged instruction rules.

2-9. PARITY ERROR REGISTER

The 24-bit parity error register stores the physical address of the last memory location that caused a parity error.

2-10. INTERRUPT SYSTEM REGISTER

The interrupt system register is a one-bit register that indicates the status of the interrupt system. When set (logic 1), the interrupt system is enabled; when cleared (0), the interrupt system is disabled.

2-11. X- AND Y-REGISTERS

These two 16-bit registers, designated X and Y, are accessed through the use of the 32 index register instructions and two jump instructions described in Section III.

2-12. WMAP-REGISTER

This 16-bit register holds the logical map numbers used for memory references by Dynamic Mapping System instructions, as well as the state of the memory protect system. (The DMS is described in Section IV.)

2-13. IMAP REGISTER

The IMAP register is a 16-bit register that holds the value which the WMAP register had at the last interrupt. The IMAP register may be accessed only by the SIMP instruction.

2-14. C- AND Q-REGISTERS

The one-bit C-register determines whether the Code and Data Separation (CDS) feature is enabled (0 = enabled; 1 = disabled). The Q-register is a 15-bit base register whose value is added to memory addresses whenever CDS is enabled and a memory address is between 2 and 1023, inclusive.

2-15. Z-REGISTER

This 16-bit register is a bounds register used by Code and Data Separation instructions to protect user memory (refer to Section V).

2-16. IQ-REGISTER

This 16-bit register holds the value which the C- and Q-registers had at the last interrupt.

2-17. VIRTUAL REGISTERS

There are two virtual registers, M and T, that are created by the Virtual Control Panel program and which can be accessed, via the VCP, to examine or change a program in memory or to manually create a program in memory.

2-18. M-REGISTER

The M-register holds the address of the memory cell currently being read from or written into by the Virtual Control Panel.

2-19. T-REGISTER

The T-register indicates the contents of the memory location currently pointed to by the M-register. It uses the memory map indicated by the XQT portion of WMAP.

2-20. CONTROLS AND INDICATORS

Operator controls and indicators for an A600 computer system are described in the appropriate installation and service manual.

Light-emitting diodes (LEDs) on the processor card provide indications for the computer self-test.

If the HP 12013A Battery Backup Card is installed and enabled and line power fails or is removed, the card will emit a one-second beep sound every ten seconds, indicating that the card is sustaining memory. (No audible indication is provided by the HP 12157A Power Fail Recovery System; however, a VCP message at system power-up notifies the operator if memory has not been sustained.) If the card does not sustain memory for the duration of a power removal, it emits a single two-second beep when power is restored. Also, during initial installation of the card, some types of improper installation will cause the card to emit a continual beep. (A switch on the battery card allows the user to disable the card.)

2-21. SELF-TEST

The self-test consists of two test programs (Test 1 and Test 2) that automatically execute each time the computer is powered up and which provide a quick, convenient check of basic computer operation. (Also, the self-test can be executed by pressing Reset switch S1 on the processor card.) If either test program fails, the computer will not operate. Successful completion of the self-test is followed immediately by execution of either a bootstrap loader, the Virtual Control Panel program, or a program sustained in memory by an optional battery pack (or battery backup card) as preselected by the user.

Test 1 is a microprogram stored in PROM on the processor card which executes immediately upon power up. It checks logic and registers on the processor card. On successful completion Test 2 is started. If Test 1 detects a failure, it stops executing and the processor-card LEDs indicate a failure code. Test 1 execution time is negligible.

Test 2 is an assembly language program stored in EPROM on the memory controller card and executes upon successful completion of Test 1. Test 2 checks the computer's basic instruction set, several internal flags, and all the memory. If memory was sustained by the optional battery pack (or battery backup card), Test 2 checks it in a non-destructive manner by reading each memory location, thus making a parity check on the data. If a parity error does occur, the location is read again. Soft errors (defined as a parity error only on the first of two reads of a memory location) are reported to the VCP (if present). If memory was not sustained, Test 2 writes all ones to each memory location and reads back the data and then writes all zeros and reads back. (The memory is cleared.) Test 2 also checks the I/O Master logic on each interface card to ensure that data transfer, flag, interrupt, and direct memory access (DMA) functions are processed correctly. If Test 2 detects a failure, it stops executing and the processor-card LEDs indicate a failure code. (If a VCP is in the system and the failure does not hinder VCP operation, the VCP program is entered and the failure code is displayed on the VCP.) The LED indication on successful completion of Test 2 depends on the computer action selected by the Start-Up (BOOT SEL) switches on the processor card. Test 2 has a maximum execution time of approximately 10 seconds; the more memory installed in the backplane, the longer it takes to execute.

2-22. BOOTSTRAP LOADERS

Bootstrap loading of a program for the A600 computer is provided for by six loaders contained in PROMs on the memory controller card. The loading devices are disc drive (via HP-IB or disc interface), PROM storage module, DS/1000-IV network link, HP 264x mini-cartridge tape, cartridge tape of the HP 7908/11/12/14 Disc Drive, and HP 7970E Magnetic Tape Drive. There are two ways to invoke a loader: auto-boot when power comes up; and by VCP command. Auto-boot can only invoke four of the loaders: two discs, PROM module, and DS/1000-IV; the VCP can invoke any of the loaders by a command from the operator. The VCP load commands are discussed later in this section.

2-23. LOADER SELECTION FOR AUTO-BOOT

The selection of an auto-boot is by means of four of the BOOT SEL switches located on the processor card. These switches, the Start-Up switches, are set during installation and also provide options other than auto-boot selection. When a loader has been selected for auto-boot and the self-test completes, the boot loader executes if memory was lost; or the program in memory executes if memory was sustained by the optional battery backup pack (or card). Refer to Table 2-1 for Start-Up switch settings.

2-24. PROGRAM STARTS

When an auto-boot completes without error, the loaded program starts execution at memory location 02. The loader sets the contents of the A and B registers as follows:

- a. Cold start (memory not sustained):
 1. A = loader command parameters.
 2. B = pointer to string area.
- b. Auto-restart (starts execution at location 04 if memory sustained):
 1. A = zero.
 2. B = zero.
- c. %E command from VCP:
 1. A = -1.
 2. B = zero.
- d. %B, or %L command from VCP:
 1. A = loader command parameters.
 2. B = pointer to a string area where:
 - Word 1 = memory size (64k bytes).
 - Word 2 = string length (in bytes).
 - Word 3 = first word of string.
 - Word n = n-2 word of string.

Table 2-1. Start-Up Switch Settings

BOOT SEL switches*						COMPUTER ACTION
S1	S2	S3	S4	S5	S6	
C	C	C	C	z	y	Loop on self-test Test 2 regardless of error.
C	C	O	C	z	y	Loop on self-test Test 2 and stop on error.
C	O	O	C	z	y	Run VCP** routine on completion of self-test.
O	C	C	C	z	y	If memory lost (not sustained), run VCP routine; otherwise, restart program (JMP 4B). (Note 2, Note 4.)
O	C	O	C	z	y	If memory lost, load and execute program from PROM card; otherwise, restart program (JMP 4B). (Note 2) (In order to auto-boot from PROM, the card must have select code 22. Equivalent to loader command %BRM.)
O	O	C	C	z	y	If memory lost, load and execute program via HDLC card; otherwise, restart program (JMP 4B). (Note 2) (In order to auto-boot via HDLC, the card must have select code 24. Equivalent to loader command %BDS.)
O	O	O	C	z	y	If memory lost, load and execute program from first file of disc (via HP-IB); otherwise, restart program (JMP 4B). (Note 2) (In order to auto-boot via HP-IB, the HP-IB interface card must have select code 27 and the disc drive must have HP-IB address 2. Equivalent to loader command %BDC.)
O	C	C	O	z	y	If memory lost, load and execute program from first file of disc (via HP 12022A interface); otherwise, restart program (JMP 4B). (Note 2) (In order to auto-boot via HP 12022A, the card must have select code 32 and operate with a hard disc drive having address 0. Equivalent to loader command %BDI.)

* O = open (up); C = closed (down)
 y = C, system console uses ENQ-ACK handshake.
 y = O, system console does not use ENQ-ACK handshake.
 z = C, normal mode, break enabled.
 z = O, break disabled (not halts).
 ** Virtual Control Panel.

Notes: 1. When a loader finishes an auto-boot, it starts execution of the loaded program at location 02.
 2. If auto-restart feature is disabled (switch M closed), the program cannot restart and the boot loader (or VCP routine) will execute.
 3. Do not use any switch combination that is not shown above.
 4. Use this switch configuration for normal computer operation.

2-25. VCP REENTRY FOR EXTENDED BOOT LOADING

The VCP PROM loader can be re-entered from a program to boot load. It executes a program from a loading device. The VCP code is re-entered as follows:

- a. A VCP boot loader call allows the programmer to call any of the VCP loaders. This allows a complete call back sequence including a checkout routine. For a sample VCP loader call back checkout program, refer to Table 2-1A.

LDA COUNT	Negative number of characters in the boot string.
LDB POINTER	Starting address of the string.
HLT 0, C <----->	Call VCP loader sequence. VCP loader is started and the new program is loaded.
COUNT DEC -12	Negative number of characters (bytes) in the string.
POINTER DEF *+1	Starting address of the string.

ASC 06,DC2027SYSTEM

The string can be any allowable string entered after the %B command (%Bxxxxffbusctext). Note that %B is not actually entered but is assumed when using this call. If the VCP loader encounters an error, the loader will report the error and return to the VCP> prompt.

- b. With the disc loader, re-enter to boot load the specific program described by the "ABS" code in the following call back programming sequence.

CLA,CLE,INA	Indicate disc call back – do not suspend
HLT 3,C	Return to VCP Loader
ABS...	HP-IB bus address
ABS...	Device unit number (head for 7906)
	Absolute starting sector (Vector 1 dor 7908/11/12/14)
ABS...	Cylinder offset (Vector 2 for 7908/11/12/14)
ABS...	Vector 3 for 7908/11/12/14

This sequence assumes that the Global Register is set prior to entry to the loader and that the absolute starting sector is the combined cylinder/head/sector for that drive. When the load is completed, the loader will start execution in the standard JMP 2 manner. If a suspend after load was specified by the E-register being set when called, the program will return to the VCP after the load. In the case of the suspend the operator can enter either a %E or a %R to continue. Any error will return to the VCP, if present, or start the original load over.

The 7906 will be accessed in the surface mode only, all other discs will be accessed in the cylinder mode.

2-26. DEVICE PARAMETERS AND MEDIA FORMATS

There is a specific data format for each combination of loader, interface card, loading device, and media. The data formats are described in Figure 2-1.

2-27. VIRTUAL CONTROL PANEL

The Virtual Control Panel (VCP) program is an interactive program that enables an external device (such as a terminal) to control the CPU in a manner similar to a conventional computer control panel. That is, it allows the operator to load programs using the loaders, access the various registers (A, B, P, etc. plus I/O card registers), examine or change memory, and control execution of a program. There are two VCP programs stored in PROM on the memory controller card: one program is for use with an HP 12005 Interface Card, and the other is for use either with an HP 12007/12044 DS/1000-IV Card or the HP 12040B Multiplexer Card. Only one interface card in the computer can serve as a VCP interface; the card selection is established when the system is installed.

2-28. VCP PROGRAM OPERATION

The VCP program is executed from PROM as a software program and uses the various machine registers (A, B, etc.) during its execution. Therefore, these registers are automatically saved upon entry to the VCP code. (The save area is in boot RAM on the memory controller card.) Thus, the response to an inquiry is the data that was saved at the time of entry to the VCP. The exceptions to this are indicated by the absence of an asterisk in Table 2-2. When the operator enters the Run (%R) command, the VCP program restores the machine with the current data in the save area and starts execution as specified by the program execution address in the P-register.

The VCP program can be entered in three ways as follows:

- a. After a power-up, PROM execution is directed to the VCP program instead of a boot load routine;
- b. When the VCP interface card requests a slave cycle to enable the VCP program (e.g., BREAK key pressed on VCP); or
- c. When a HLT (halt) instruction is executed with the memory protect system disabled and one I/O card is enabled for break (otherwise the instruction has no effect).

After a power-up, the computer type and the total memory size is displayed (ECA is always zero, as there is no error correcting memory) and the A-register is set to the number of I/O chips that were tested during the self-test. This enables the operator to verify that all installed

Table 2-2. VCP Characters and Associated Registers

CHARACTER ENTERED	RESPONSE†	MEANING
A*	xxxxxx	A-register contents
B*	xxxxxx	B-register contents
E*	x	E-register contents
G*	x000xx	Global Register (GR) contents and status (bit 15=1 if enabled, 0 if disabled)
I*	x	Interrupt system status (0=off, 1=on)
M*	0xxxxx	Memory address (pointer for T and Ln command)
O*	x	O-register contents
P*	0xxxxx	Program execution address
RS	xxxxxx	Switch register contents
T	0xxxxx xxxxxx	Memory contents pointed to by M
V	xxxxxx	Violation register (memory protect)
X*	xxxxxx	X-register contents
Y*	xxxxxx	Y-register contents
RC	0000xx	Central Interrupt Register contents
RD**	xxxxxx xxxxxx	Data for I/O diagnose modes 1 and 2 (refer to paragraph 7-22)
RF**	xxxxxx	I/O flags: Flags 20 thru 24, and Flag 30 (1 = flag set; 0 = flag clear)
RI**	xxxxxx	Interrupt mask register
RP	xxxxxx xxxxx xxx	Parity violation register contents
RW*	xxxxxx	Working map set (WMAP)
Q*	cxxxxx	Base register contents and CDS mode bit (1 = disabled, 0 = enabled)
Z*	0xxxxx	Bounds register contents
R20**	xxxxxx	DMA self-configuration register
R21**	xxxxxx	DMA control register
R22**	xxxxxx	DMA address register
R23**	xxxxxx	DMA count register
R24**	xxxxxx	I/O scratch register
R25**	xxxxxx	I/O scratch register
R26**	xxxxxx	I/O scratch register
R30**	xxxxxx	I/O card data register
R31**	xxxxxx	Optional I/O card register
R32**	xxxxxx	Optional I/O card register



† x = octal data except for RF**.

* Registers that are maintained in the VCP save area of boot RAM.

** Applies only to the I/O card whose select code equals the contents of the Global Register.

NOTE: When a register's contents are changed by the user the new value is returned; if the VCP does not accept a change, the VCP prompt is returned.

Table 2-1A. Sample VCP Loader Call Back Checkout Program

LABEL	OPCODE	OPERAND	COMMENTS
ASMB,A,B,L,C	ORG	2B	Goto start of the program.
	JMP	START	
	NOP		No powerfail, auto restart.
	NOP		
START	ORG	100B	
	HLT	0	Test halt to compare string.
	LDA	COUNT	Negative number of characters in the boot string.
	LDB	PNTR	Starting address of the string.
	HLT	0, C	Call VCP loader sequence.
	NOP		
	NOP		
COUNT	DEC	-18	Negative numbers of characters (bytes) in the string.
PNTR	DEF	*+1	Starting address of the string.
		ASC 09,CT10020Test String	
	END		

memory and I/O cards were tested. (Also, the B-register normally contains the revision code of the VCP PROMs; however, some failures that occur during self-test Test 2, such as two or more I/O cards having the same select code, load the B-register with error identification information.) When entered, the VCP displays the basic set of registers (P, A, B, M, RW, and T) and issues the VCP prompt (VCP>) for an operator entry. The operator can enter any of the characters or commands listed in Tables 2-2 and 2-3 and the VCP program will respond as indicated in the tables. A carriage return is entered to terminate a command.

After a response to an inquiry the operator can change the data contained in that register or memory location by entering new data; for example (operator inputs are underlined and <cr> indicates a carriage return):

A 001234 4321<cr>

A 004321

Data input is terminated by the operator entering a carriage return. If during an input the program cannot interpret a character, the program will output the characters "!" (except when the VCP prompt is returned because a change has not been accepted) and then start a new line. Entry errors may be corrected by backspacing over them and entering the correct information; during any data input the operator can abort the input by entering a rub-out (DEL). The loader commands, %B, %L, and %W can also be aborted by a rub-out. When entering data into a register, leading zeros may be omitted. If the operator types a question mark, the VCP will output a "help" file that summarizes acceptable command entries.

2-29. LOADER COMMANDS

The loader commands can be entered via the VCP in either of two ways:

- a. Allow the parameter default values (given in Figure 2-1) to be used; or
- b. Specify all necessary parameters.

The VCP loader command format is shown in Figure 2-2. The loader command error messages and their meanings are listed in Table 2-4.

2-30. VCP USER CONSIDERATIONS

When using the VCP to debug a program the user should be aware of the following conditions:

- a. The VCP program uses an interface card and modifies the characteristics of that card. When the VCP program exits, it sets Register 24 on the interface card to all ones to allow software detection of a VCP interaction and, thus, re-initialize the card for proper operation. (This also causes an interrupt if the interrupt system is enabled.) Also, the VCP will leave the card in the output mode with both Flag 30 and Control 30 set.
- b. The status of the interrupt system (STC 4 (on) or CLC 4 (off)) is not indicated and will remain unchanged unless %P is executed to preset the computer.
- c. Memory protect is indicated as the sign bit of RW (WMAP register) and may be modified. (1 = enabled, 0 = disabled)

2-31. VCP SLAVE FUNCTIONS

The slave feature of an I/O processor chip is used in conjunction with the VCP program. The slave feature enable is read into the I/O chip of the VCP interface card on power-up and cannot be altered until the next power-up condition. After power-up a change in the state of the slave signal causes the I/O chip to generate a slave request on the next instruction fetch. When the request is granted, the I/O chip requests the CPU's current P-register contents and saves these contents in a register in the I/O chip. The I/O chip then stores the starting address of the VCP program into the CPU's P-register, instructs the CPU to enable the boot PROM, and allows execution to start. The VCP program can be started in two other ways, as follows:

Table 2-3. VCP Commands

COMMAND*	MEANING
%B	Load and go (boot). Execute a specified loader routine and start program execution at completion of load. See Figure 2-2 for format.
%C	Clear memory. Set all memory to zero and perform a preset.
%E	Execute. Start execution of program at location P=2 (A-register equals -1 (all ones) and B-register equals 0).
%L	Load. Similar to %B except do not start execution. See figure 2-2 for format. (%L followed by %R is equivalent to %B.)
%P	Preset. Generate a control reset (CRS) signal to all interface cards.
%R	Run. Set all registers to the appropriate values in the save area and start execution at address specified by the P-register.
%T	Test. Initiate the self-test and return to VCP (memory is sustained but the I/O system is reset).
%W	Write. Write to the selected device. (See Figure 2-2 for format.) When writing to a disc drive, the Count and Partial values defined in Figure 2-1 must be in memory locations 00000 and 00001.
D	Decrement. Decrement memory pointer and display the contents of the M- and T-registers. Valid only after T.
Ln	List. List n blocks of eight memory locations starting with location pointed to by the M-register.
N	Next. Same as D except increment the pointer. Valid only after T.
RMxx	List the 32 map registers in the DMS map set specified by xx.
RMxxPyy	Show the value of register yy in map set xx. If a number is input after this command, the register is changed to the new value.
?	Output Help file.

*Must be followed by a carriage return.

- a. On power-up and after the self-test the VCP program starts execution if it is selected in lieu of a boot loader. This selection may often be used because the loaders can be invoked individually from the VCP.

- b. When a HLT* (halt) instruction is executed the I/O processor chip interprets it in the same manner as a change in the slave enable signal. This allows a program to have breakpoints for debugging purposes. Note that a HLT instruction will not be executed, but causes a memory protect interrupt if memory protection is on.

During execution of the VCP program, access to the P-save register in the I/O chip is accomplished with LIA/B 3 and OTA/B 3 (without the instruction's Flag bit set). It should also be noted that the I/O chip will not execute a

slave request until an STC 2 (enable break feature) instruction has been executed. This prevents re-entry of the VCP program once it has been entered.

During the self-test, the starting address of the VCP program is assigned to the break-enabled I/O card by an OTA/B 3,C* instruction with the Aor B-register set to the address. This address can also be read back with an LIA/B 3,C* instruction.

* If break is not enabled on any I/O card, then the instruction has no effect.

MINI-CARTRIDGE TAPE

Device: HP 264x Terminal.

Interface: HP 12005A Asynchronous Serial Interface.

Default
Parameters*: 000020

Format: Reads absolute binary file, writes 4k absolute binary block.

Loader: Transmits special escape sequence to invoke a read of a record and does checksum of the data. When writing to tape, a block number is used to specify which 4k-word memory area is to be dumped to tape (0 = 0 7777 bytes, 1 = 10000 to 17777 bytes, etc.).

If a file number is specified then the program will issue a find file command; if not, the tape is read from where it stands. When writing to the tape, the program will not write a file mark; this allows sequential blocks to be written in a series. There are only two units (0 and 1) on the terminal; if a larger unit number is specified, the result will be unpredictable.

More than 32k words may be loaded into a system from a single cartridge tape.

PROM MODULE

Device: PROM (2k x 8 bits).

Interface: HP 12008A PROM Storage Module.

Default
Parameters*: 000022

Format: Count-Partial-Data.
Count = number of 64k byte blocks.
Partial = number of words of partial 64k byte block.
Data = 16-bit words, one word per location until Count and Partial are satisfied.

Loader: Uses STC-LIA process to transfer data. The PROM cannot be written to nor does it use the block number or unit number.

* See Figure 22 for loader command formats.

Figure 2-1. Loading Device Parameters and Media Formats (Sheet 1 of 3)

DISC DRIVE

Device: HP 9895, 9134, 9133, 9121, 7906, 7908, 7910, 7911, 7912, or 7914 Disc Drive, or cartridge tape drive of 7908/11/12/14 Disc Drive.

Interface: HP 12009A HP-IB Interface.

Default
Parameters*: 002027

Format: Count-Partial-Data.†
Count = number of 64k byte blocks.
Partial = number of words of partial 64k byte block.
Data = 16-bit words, one word per location until Count and Partial are satisfied.

Loader: Uses HP-IB protocol to communicate with the disc. The load sequence is:

1. Device clear
2. Status check
3. Read/write 32k words via DMA
4. Status check

DISC DRIVE (VIA DISC INTERFACE)

Device: HP 2436A/86A internal fixed/micro-floppy disc drive.

Interface: HP 12022A Disc Interface.

Default
Parameters*: 000032

Format: Same as Disc Drive via HP-IB, above.

Loader: Standard I/O for commands to interface, and DMA for data.

* See Figure 2-2 for loader command formats.

† The Count is stored in location 00000 and the Partial in 00001.

Figure 2-1. Loading Device Parameters and Media Formats (Sheet 2 of 3)

MAGNETIC TAPE

Device: HP 7970E or 7974A Magnetic Tape Drive.

Interface: HP 12009A HP-IB Interface.

Default
Parameters*: 004027

Format: Memory image file.
Count-Partial-Data.
Count = number of 64k byte blocks.
Partial = number of words of partial 64k byte block.
Data = 256 byte records read until EOF or until Count and Partial are satisfied.

Loader: Uses HP-IB protocol to communicate with the magnetic tape. The load sequence is:

1. Device ID
2. Device clear
3. Rewind/file forward (if file specified)
4. Read/write
5. Status check

COMPUTER NETWORK

Device: HP 1000 Computer.

Interface: HP 12007A/12044A HDLC Interface.

Default
Parameters*: 000024

Format: Reads absolute binary or memory image files, writes a 32k memory image file.

Loader: Standard handshake using HP distributed system protocol. Block number and unit number are not used.

* See Figure 2-2 for loader command formats.

Figure 2-1. Loading Device Parameters and Media Formats (Sheet 3 of 3)

LOADER COMMAND FORMAT:

%B/L/W dv fffffbusc text

where:

dv = device type as follows:

- DC = disc (cartridge or flexible) via HP-IB
- CT = cartridge tape (HP 264x)
- RM = PROM card
- DS = DS computer network Link
- MT = 7970E magnetic tape drive via HP-IB
- DI = disc via 12022A card

ffff = file number (octal 0 to 77777 only)

b = 4k-word memory block number when writing to cartridge tape; HP-IB bus address of disc drive or drive address for 12022A interface; otherwise, use 0.

u = unit number (0 to 7) only if used on device. For the HP 7906 Disc Drive, the unit number is the head number. For HP 7908, 7911, 7912, or 7914 Disc Drive that includes cartridge tape drive, unit 0 = disc drive and unit 1 = cartridge tape drive.

sc = select code of interface card to be used.

text = file name, or ASCII string to be passed to the program after it is loaded. This is only available with the %B and %L commands.

NOTE: See Figure 2-1 for default parameters for each loading device.

Note that spaces cannot be used in the command entry. The following formats are all acceptable:

%Bdvtext Device parameters are defaulted; text cannot start with a number.

%Bdvffffbusc No text passed.

%Bdvffffbusctext Text passed.

EXAMPLES:

%BDC Load and start execution of the default program on disc. (Disc parameters defaulted to 002027; see Figure 2-1).

%BDC30 Load and start execution of the default program on the disc at select code 30 and default other parameters.

%LDC27025 Load (but don't execute) and override parameter default values:
 file number 2 (i.e., third file)
 HP-IB bus address 7
 unit 0
 select code 25

%WDC27025 Same as above except write to file 2.

Figure 2-2. Loader Command Format

Table 2-4. VCP Loader Command Errors

ERROR CODE	MEANING
2	Select code less than 20 octal.
3	No card with the select code you specified.
Cartridge Tape Loader Errors	
110	File forward error. Status in B-register.
111	Checksum error.
112	No data before EOF (end of file).
120	Write error. Status in B-register.
PROM Module Loader Errors	
211	End of programs.
212	Bad format.
213	System larger than 32k must start on card boundary.
DS/1000 Loader Errors	
310	Time out after CLC 0. Check select code specified.
311	Checksum error. P file not absolute binary.
312	Time out after download request.
313	Time out after file number.
314	Bad transfer (Central generated). Status in B-register.
315	Time out after buffer request.
316	Time out after count echo.
317	Time out waiting for data.
320	Time out after VCP mode requests a DS write.
321	Central will not accept data. Status in B-register.
325	Data block out of sequence
Disc Loader Errors	
411	Time out reading disc type. Check HP-IB address.
412	Time out UDC (Universal Device Code) or reading status. Check disc.
413	Status error. Status in B-register.
414	Time out during file mask.
415	Time out during seek.
416	Time out during read or write command.
417	Time out during DMA of data.
420	Parity error during DMA transfer.
421	Time out during FIFO flush.
422	Time out during DSJ (Device Specified Jump) command.
423	Bad DSJ return. Returned value in B-register.
460	Disc not identifiable. Disc ID in B-register.

Table 2-4. VCP Loader Command Errors (Continued)

ERROR CODE	MEANING
Magnetic Tape Loader Errors	
510	Time out during initialization/read ID.
511	Time out when issuing end/select unit.
512	Mag tape off line.
513	No write ring.
514	Time out during End command.
515	Time out waiting for rewind completion.
517	Time out waiting for DMA transfer.
520	Parity error during DMA transfer.
521	Time out doing a PHI flush.
522	Time out waiting for DSJ.
523	Bad DSJ response.
525	Time out waiting for Mag Tape Not Busy.
530	Time out after issuing a command.
531	Parallel Poll time out after issuing a command.
535	Bad status after read/write command.
550	No data transfer (read only).
560	Not mag tape ID.
HP 12022A Disc Interface Loader Error	
610	Time out after SDH (sector drive head) for read/write.
611	Time out after cylinder high.
612	Time out after cylinder low.
613	Time out after sector.
614	Time out after sector count.
615	Time out after read/write command.
616	Time out after DMA read/write transfer.
617	Parity error during transfer.
620	Fixed disc not ready.
630	Time out after request status register.
631	Time out after read status register.
632	Time out after waiting for not busy.
633	Time out after request error register.
634	Time out after read error register.
635	Status error: — A-register = status register; B = error reg.
650	Time out after SDH register for restore.
651	Time out after restore.
660	Disc not defined.

This section describes the software data formats and the base set machine-language instruction coding (including single-precision floating point, virtual memory, high-level language support instruction set (LIS), and operating system instruction set (OSI)) required to operate the computer and its associated input/output system. This section also describes the double-precision floating point instructions, which are standard in the A600+ base set. Machine-language instruction coding for the Dynamic Mapping System is presented in Section IV. Machine language instruction coding for the CDS instruction group is presented in Section V.

3-1. DATA FORMATS

As shown in Figure 3-1, the basic data format is a 16-bit word in which bit positions are numbered from 0 through 15 in order of increasing significance. Bit position 15 of the data format is used for the sign bit; a logic 0 in this position indicates a positive number and a logic 1 in this position indicates a negative number. The data is assumed to be a whole number and the binary point is therefore assumed to be to the right of the number.

The basic word can also be divided into two 8-bit bytes or combined to form a 32-bit double word. The byte format is used for character-oriented input/output devices; packing two bytes of data into one 16-bit word is accomplished by software drivers or by byte-packing hardware in the I/O Master. In I/O operations, the higher-order byte (byte 1) is the first to be transferred.

The double-integer format is used for extended arithmetic in conjunction with the extended arithmetic instructions described under paragraphs 3-26 and 3-27. Bit position 15 of the most-significant word is the sign bit and the binary point is assumed to be to the right of the least significant word. The integer value is expressed by the remaining 31 bits.

Two floating point formats are shown in Figure 3-1. The single-precision format is used with single-precision floating point instructions included in the standard base set of instructions, as described in paragraph 3-34. The double-precision format is used with double-precision floating point instructions that are included in the A600+ base set, as described in paragraph 3-40A. Bit position 15 of the most-significant word is the mantissa sign and bit position 0 of the least-significant word is the exponent sign. Bits 1 through 7 of the least significant word express the exponent and the remaining bits express the mantissa. A single-precision floating point number is made up of a 23-bit mantissa (fraction) and sign and a 7-bit exponent

and sign, thus providing six significant decimal digits in the mantissa. A double-precision floating point number is made up of a 55-bit mantissa and a 7-bit exponent and sign, thus providing 16 significant decimal digits in the mantissa. If either the mantissa or the exponent is negative, that part must be stored in two's complement form. The number must be in the approximate range of 10^{-38} to 10^{38} . When loaded into the accumulators, the A-register contains the most-significant word and the B-register contains the least-significant word.

Figure 3-1 also illustrates the octal notation for both single-length (16-bit) and double-length (32-bit) words. Each group of three bits, beginning at the right, is combined to form an octal digit. A single-length (16-bit) word can therefore be fully expressed by six octal digits and a double-length (32-bit) word can be fully expressed by 11 octal digits. Octal notation is not shown for byte or floating-point formats, since bytes normally represent characters and floating-point numbers are given in decimal form.

The range of representable numbers for single-word data is +32,767 to -32,768 (decimal) or +77,777 to -100,000 (octal). The range of representable numbers for double-word integer data is +2,147,483,647 to -2,147,483,648 (decimal) or +17,777,777,777 to -20,000,000,000 (octal).

3-2. ADDRESSING

3-3. PAGING

The computer memory is logically divided into pages of 1,024 words each. A page is defined as the largest block of memory that can be directly addressed by the address bits of a single-length memory reference instruction. (Refer to paragraph 3-9.) These memory reference instructions use 10 bits (bits 0 through 9) to specify a memory address; thus, the page size is 1,024 locations (2000 octal). Octal addresses for each page, up to a maximum memory size of 32k, are listed in Table 3-1.

Provision is made to directly address one of two pages: page zero (the base page consisting of locations 00000 through 01777) and the current page (the page in which the instruction itself is located). Memory reference instructions reserve bit 10 to specify one or the other of these two pages. To address locations on any other page, indirect addressing is used as described in following paragraphs. Page references are specified by bit 10 as follows:

- a. Logic 0 = Page Zero (Z).
- b. Logic 1 = Current Page (C).

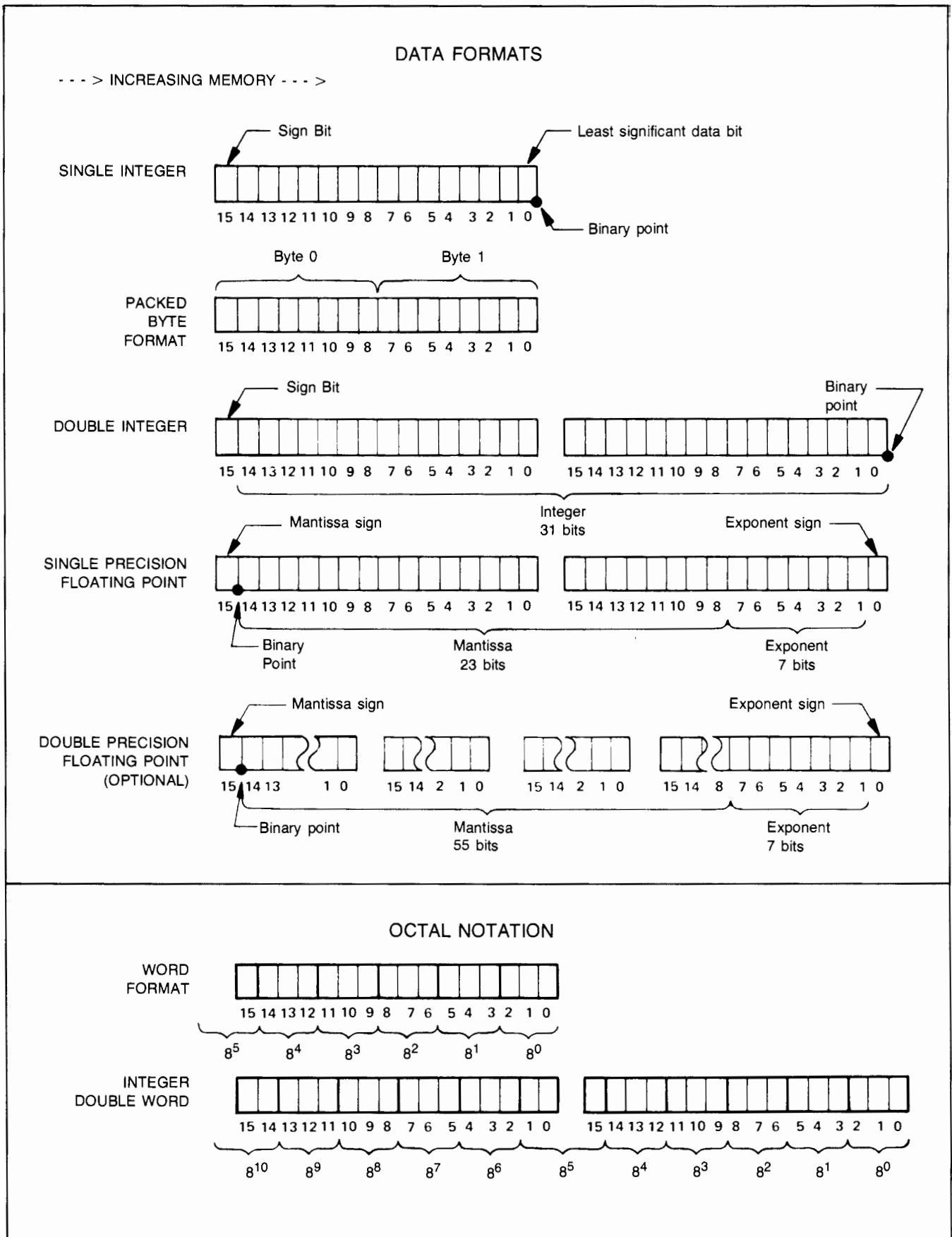

2270-2

Figure 3-1. Data Formats and Octal Notation

Table 3-1. Memory Paging

MEMORY SIZE	PAGE	OCTAL ADDRESSES
	0	00000 to 01777
	1	02000 to 03777
	2	04000 to 05777
	3	06000 to 07777
	4	10000 to 11777
	5	12000 to 13777
	6	14000 to 15777
	7	16000 to 17777
	8	20000 to 21777
	9	22000 to 23777
	10	24000 to 25777
	11	26000 to 27777
	12	30000 to 31777
	13	32000 to 33777
	14	34000 to 35777
16K ↓	15	36000 to 37777
	16	40000 to 41777
	17	42000 to 43777
	18	44000 to 45777
	19	46000 to 47777
	20	50000 to 51777
	21	52000 to 53777
	22	54000 to 55777
	23	56000 to 57777
	24	60000 to 61777
	25	62000 to 63777
	26	64000 to 65777
	27	66000 to 67777
	28	70000 to 71777
	29	72000 to 73777
	30	74000 to 75777
	31	76000 to 77777

3-4. DIRECT AND INDIRECT ADDRESSING

All memory reference instructions reserve bit 15 to specify either direct or indirect addressing. For single-length memory reference instructions, bit 15 of the instruction word is used; for extended arithmetic memory reference instructions, bit 15 of the address word is used. Indirect addressing uses the address part of the instruction to access another word in memory, which is taken as the new memory reference for the same instruction. This new address word is a full 16 bits long: 15 address bits plus another direct/indirect bit. The 15-bit length of the address permits access to any location in the Logical address space. If bit 15 again specifies indirect addressing, still another address is obtained; thus, multistep indirect addressing may be done to any number of levels. The first address obtained that does not specify another indirect

level becomes the effective address for the instruction. Direct or indirect addressing is specified by bit 15 as follows:

- a. Logic 0 = Direct (D).
- b. Logic 1 = Indirect (I).

After three or more levels of indirect addressing, interrupts are checked and, if an interrupt is pending, the instruction will be interrupted and restarted when the interrupt service routine is done.

3-5. MEMORY MAPPING

Memory mapping is a standard feature of the A600 computer and is used to access all locations of main memory. Memory mapping is provided by the Dynamic Mapping System described in Section IV.

3-5A. VIRTUAL MEMORY AREA

Under Virtual Memory Area (VMA) operation, a program may access two separate data areas, one being the 32k word logical address space, and the other being a virtual address space of up to 16M words. The virtual address space may be either memory-resident or disc-resident, and up to 1M words per program may reside in memory. This is accomplished through mapping pages of the logical address space to the virtual address space.

3-5B. CODE AND DATA SEPARATION

When Code and Data Separation (CDS) is enabled, a program's address space is partitioned into two separate address spaces: a code space and a data space of up to 31k words each. Opcodes and the operand pointers that follow the opcode reside in code space, and variables and constants reside in data space. CDS instructions are provided that remap the code segment to other physical pages in memory, thus providing large program support. A program's code size may be up to 128 segments (each having 31k words of code), which may be either memory-resident or disc-resident. The optional HP 92078A package for the RTE-A operating system provides software support for CDS.

3-5C. BASE-RELATIVE ADDRESSING

Under CDS, special hardware is used to access memory locations relative to a base register called the Q-register. When a memory address is in the range 2 through 1023, the Q-register value is added to produce an effective address in the data space. When CDS is enabled, code may not reside on the base page, which means that jump instructions may not jump to the base page.

3-6. RESERVED MEMORY LOCATIONS

The first 64 memory locations of the physical base page (octal addresses 00000 through 00077) are reserved as listed in Table 3-2. The first two locations are reserved as addresses for the two 16-bit accumulators (the A- and B-registers). If options or input/output devices corresponding to locations 00020 through 00077 are not included in the system configuration, these locations can be used for programming purposes. The last 64 locations of the physical base page (1700 to 1777) are reserved for use by the Virtual Control Panel program for the string area.

3-7. NONEXISTENT MEMORY

Nonexistent memory is defined as those locations not physically implemented in the machine. Any attempt to write into a nonexistent memory location will be ignored (no operation). Any attempt to read from a nonexistent memory location will return an all-ones word (177777 octal); no parity error occurs. If the nonexistent memory is protected, a memory protect interrupt will be generated.

3-8. BASE SET INSTRUCTION FORMATS

The base set of instructions are classified according to format. The six formats used are illustrated in Figure 3-2 and described in the following paragraphs except for the DMS and CDS instructions, which are described in Sections IV and V. In all cases where a single bit is used to select one of two cases (e.g., D/I), the choice is made by coding a logic 0 or logic 1, respectively.

3-9. MEMORY REFERENCE INSTRUCTIONS

This class of instructions, which combines an instruction code and a memory address into one 16-bit word, is used to execute some function involving data in a specific memory location. Examples are storing, retrieving, and combining memory data to and from the accumulators (A- and B-registers) or causing the program to jump to a specified location in memory.

The memory cell referenced (i.e., the absolute address) is determined by a combination of 10 memory address bits (0 through 9) in the instruction word and 5 bits (10 through 14) assumed from the current contents of the M-register. This means that memory reference instructions can directly address any word in the current page; additionally, if the instruction is given in some location other than the base page (page zero), bit 10 (Z/C) of the instruction doubles the addressing range to 2,048 locations by allowing the selection of either page zero or the current page. (This causes bits 10 through 14 of the address contained in the

Table 3-2. Reserved Memory Locations

MEMORY LOCATION	PURPOSE
00000	A-register address.
00001	B-register address.
00002-00003	Reserved.
00004	Power-fail interrupt.
00005	Memory parity interrupt.
00006	Time base generator interrupt.
00007	Memory protect interrupt.
00010	Unimplemented instruction interrupt.
00011	Reserved.
00012	Virtual Area Memory Interrupt.
00013	CDS Segment Interrupt.
00014-00017	Reserved.
00020-00077	Interrupt locations corresponding to interface card select codes.
01700-01777	VCP program string area.

M-register to be set to zero instead of assuming the current contents of the M-register.) This feature provides a convenient linkage between all pages of memory, since page zero can be reached directly from any other page.

With CDS enabled, this feature becomes even more powerful as the base register is added to all base page references (addresses from 2 to 1777 octal, or MRG instructions with Z/C=0). This means that each single-word instruction has direct access to data on the current page, or data up to 1k word relative to the base register.

As discussed under paragraph 3-4, bit 15 is used to specify direct or indirect memory addressing. Note also that since the A- and B-registers are addressable, any single-word memory reference instruction can apply to either of these registers as well as to memory cells. For example, an ADA 0001 instruction adds the contents of the B-register (address 0001) to the contents currently held in the A-register; specify page zero for these operations since the addresses of the A- and B-registers are on page zero.

3-10. REGISTER REFERENCE INSTRUCTIONS

In general, the register reference instructions manipulate bits in the A-register, B-register, and E-register; there is no reference to memory. This group includes 39 basic instructions which may be combined to form a one-word multiple instruction that can operate in various ways on the contents of the A-, B-, and E-registers. These 39 in-

structions are divided into two subgroups: the shift/rotate group (SRG) and the alter/skip group (ASG). The appropriate subgroup is specified by bit 10 (S/A). Typical operations are clear and/or complement a register, conditional skips, and register increment.

3-11. INPUT/OUTPUT INSTRUCTIONS

The input/output instructions use bits 6 through 11 for a variety of I/O instructions and bits 0 through 5 to apply the instructions to a specific I/O channel (if the Global Register is disabled) or to an I/O card register. This provides the means of controlling all peripherals connected to the I/O channels and for transferring data to and from these peripherals. Included also in this group are instructions to control the interrupt system, overflow bit, and computer halt.

3-12. EXTENDED ARITHMETIC MEMORY REFERENCE INSTRUCTIONS

As the single-word memory reference instruction described previously, the extended arithmetic memory reference instructions include an instruction code and a memory address. In this case, however, two words are required. The first word specifies the extended arithmetic class (bits 12 through 15 and 10) and the instruction code (bits 4 through 9 and 11); bits 0 through 3 are not needed and are coded with zeros. The second word specifies the memory address of the operand. Since the full 15 bits are used for the address, this type of instruction may directly address any location in memory. If the CDS mode is enabled and the reference is to the base page, the base (Q) register will be added to the second word before referencing memory. As with all memory reference instructions, bit 15 is used to specify direct or indirect addressing. Operations performed by this class of instructions are integer multiply and divide (using double-length product and dividend) and double load and double store.

3-13. EXTENDED ARITHMETIC REGISTER REFERENCE INSTRUCTIONS

This class of instructions provides long shifts and rotates on the combined contents of the A- and B-registers. Bits 12 through 15 and 10 identify the instruction class; bits 4 through 9 and 11 specify the direction and type of shift; and bits 0 through 3 control the number of shifts, which can range from 1 to 16 places.

3-14. EXTENDED INSTRUCTIONS

The extended instructions include index register instructions, bit and byte manipulation instructions, and move and compare instructions. Instructions comprising the extended instruction group are one, two, or three words in length. The first word is always the instruction code; operand addresses are given in the words following the instruction code or in the A- and B-registers. The operand addresses are 15 bits long, with bit 15 (most-significant bit) generally indicating direct or indirect addressing.

3-15. FLOATING POINT INSTRUCTIONS

The floating point instructions allow addition, subtraction, multiplication, and division of 32-bit floating point quantities. Two conversion routines are provided for transforming numerical integer representations to/from floating point representations. The A600+ adds double precision (64-bit) floating point instructions, as well as all routines to convert from single and double integer to single and double precision floating point, and vice versa.

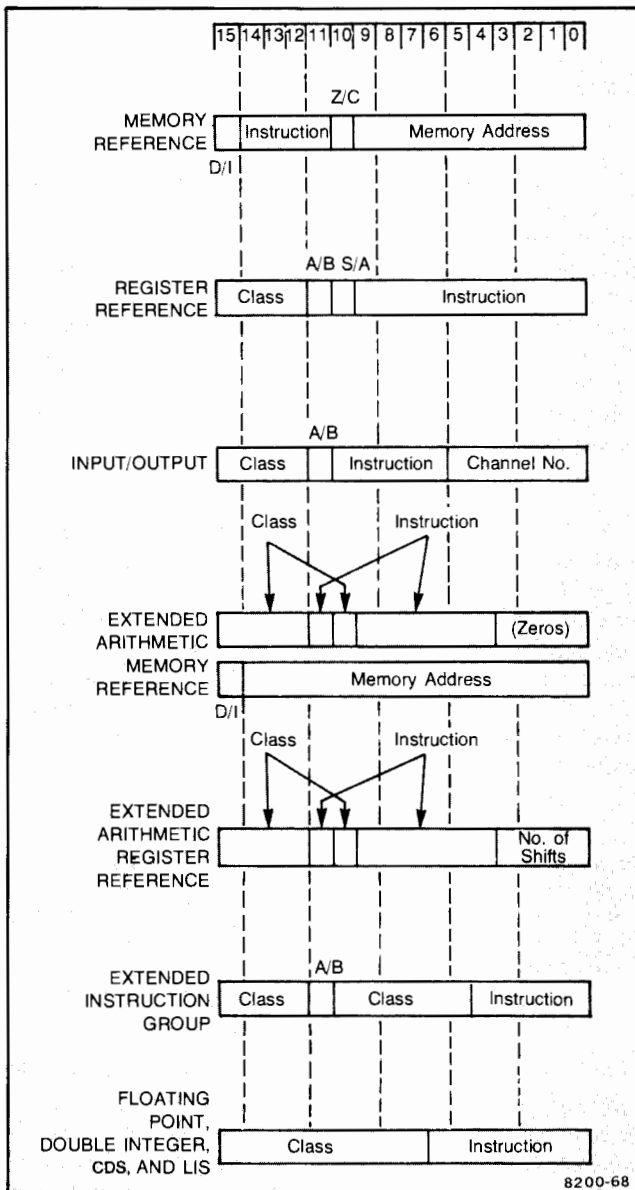
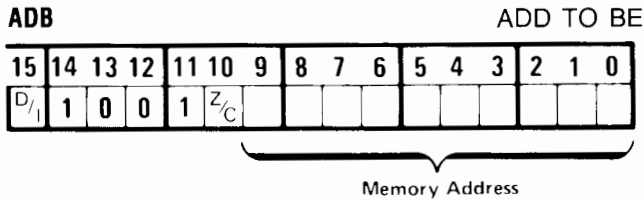
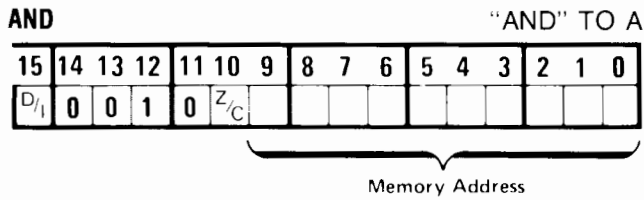

Figure 3-2. Base Set Instruction Formats



Adds the contents of the addressed memory location to the contents of the B-register. The sum remains in the B-register and the contents of the memory cell are unaltered. The result of this addition may set the extend bit or the overflow bit. (Extend and overflow examples are illustrated on page A-13.)



Combines the contents of the addressed memory location and the contents of the A-register by performing a logical "and" operation. The contents of the memory cell are unaltered.

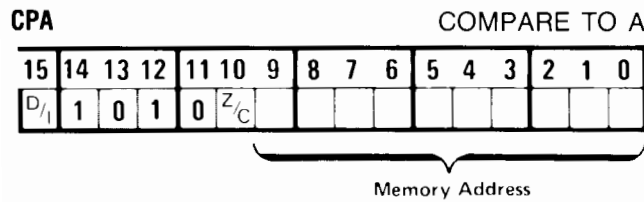

Compares the contents of the addressed memory location with the contents of the A-register. If the two 16-bit words are not identical, the next instruction is skipped; i.e., the P-register advances two counts instead of one count. If the two words are identical, the next sequential instruction is executed (do if true). Neither the A-register contents nor memory cell contents are altered.

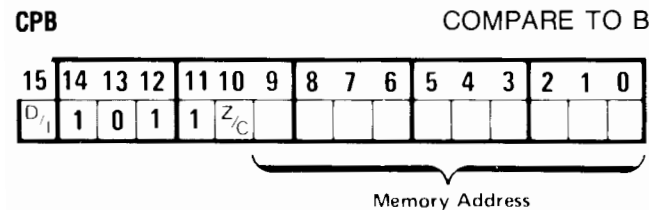

Compares the contents of the addressed memory location with the contents of the B-register. If the two 16-bit words are not identical, the next instruction is skipped; i.e., the P-register advances two counts instead of one count. If the two words are identical, the next sequential instruction is executed (do if true). Neither the B-register contents nor memory cell contents are altered.

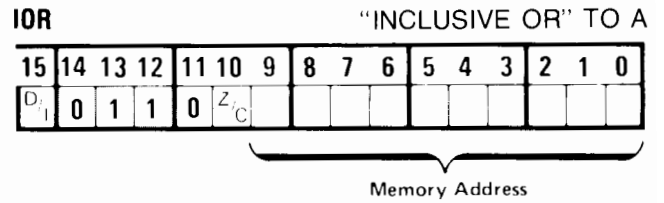

Combines the contents of the addressed memory location and the contents of the A-register by performing a logical "inclusive or" operation. The contents of the memory cell are unaltered.

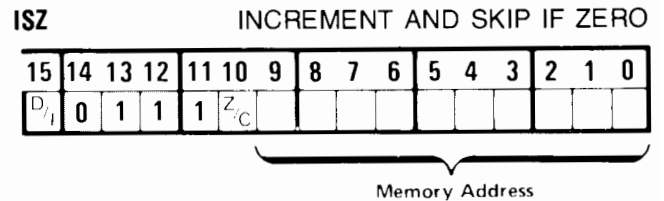

Adds one to the contents of the addressed memory location. If the result of this operation is zero (memory contents incremented from 177777 to 000000), the next instruction is skipped; i.e., the P-register is advanced two counts instead of one count. If the result of this operation is not zero, the next sequential instruction is executed. In either case, the incremented value is written back into the memory cell. Current page, direct addressing with this instruction will produce undefined results if CDS is enabled.

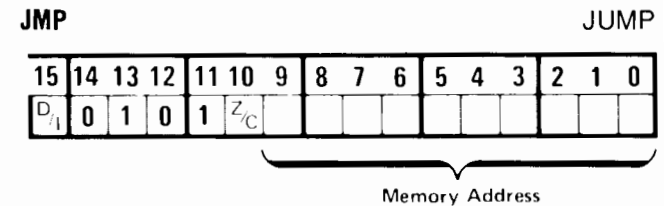

Transfers control to the addressed memory location. That is, a JMP causes the P-register count to set according to the memory address portion of the JMP instruction so that the next instruction will be read from that location.

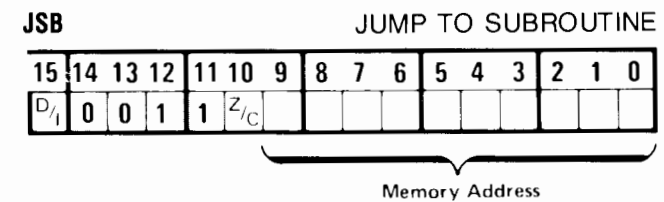

This instruction, executed in location P (P-register count), causes the computer control to jump unconditionally to the memory location (m) specified by the memory address portion of the JSB instruction. The contents of the P-register plus one (return address) is stored in memory location m, and the next instruction to be executed will be

3-16. DOUBLE INTEGER INSTRUCTIONS

The double integer instructions allow arithmetic and test operations on 32-bit quantities. Bits 15 through 7 identify the instruction class, and bits 6 through 0 specify the instruction code. Double integer values contained in the A- and B-registers have the most significant bits in the A-register.

3-17. LANGUAGE INSTRUCTION SET

The language instruction set performs several frequently used high-level language operations, including parameter passing, array address calculations, and floating point conversion, packing, rounding and normalizing. Bits 15 through 7 identify the instruction class, and bits 6 through 0 specify the instruction code.

3-18. VIRTUAL MEMORY INSTRUCTIONS

The virtual memory instructions perform accesses to virtual memory and the extended memory area, which are extensions of logical memory.

3-19. OPERATING SYSTEM INSTRUCTIONS

The operating system instructions provide instructions for ascertaining the CPU and firmware identification, and instructions for interrupt conditions.

3-19A. CDS INSTRUCTIONS

The A600+ includes the CDS instruction set, which includes instructions for examining and modifying the base (Q) register, bounds (Z) register, and CDS-mode (C) register. This set also includes instructions for transferring control between subroutines (which may or may not be memory resident).

All instructions that reference multi-word data (double integer, single and double precision floating point) as well as instructions using sequential addressing (DMS move instructions, .SETP and SFB) will have the base register added to the initial address if the instruction is base relative and CDS mode is enabled. Subsequent memory references are then executed sequentially.

Instructions that leave an address in a register upon completion (e.g., LBT, .ZFER, .SETP, MW00) will contain an address resolved for base relativity, incremented by the proper count.

3-20. BASE SET INSTRUCTION CODING

Machine language coding for the base set of instructions are provided in following paragraphs. Definitions for these

instructions are grouped according to the instruction type: memory reference, register reference, input/output, extended arithmetic memory reference, and extended arithmetic register reference.

Directly above each definition is a diagram showing the machine language coding for that instruction. The gray shaded bits code the instruction type and the blue shaded bits code the specific instruction. Unshaded bits are further defined in the introduction to each instruction type. The mnemonic code and instruction name are included above each diagram.

In all cases where an additional bit is used to specify a secondary function (D/I,Z/C, or H/C), the choice is made by coding a logic 0 or logic 1, respectively. In other words, a logic 0 codes D (direct addressing), Z (zero page), or H (hold flag); a logic 1 codes I (indirect addressing), C (current page), or C (clear flag).

3-21. MEMORY REFERENCE INSTRUCTIONS

The following 14 memory reference instructions execute a function involving data in memory. Bits 0 through 9 specify the affected memory location on a given memory page or, if indirect addressing is specified, the next address to be referenced. Indirect addressing may be continued to any number of levels; when bit 15 (D/I) is a logic 0 (specifying direct addressing), that location will be taken as the effective address. The A- and B-registers may be addressed as locations 00000 and 00001 (octal), respectively.

If bit 10 (Z/C) is a logic 1, the memory address is on the current page. If bit 10 is a logic 0, the memory address depends on whether CDS mode is enabled. If CDS mode is enabled, the base (Q) register will be added to bits 0 through 9 to provide the memory address. If CDS mode is not enabled, the memory address is on the base page (page 0). If the A- or B-register is addressed, bit 10 must be a logic 0 to specify page zero, unless the current page is page zero.

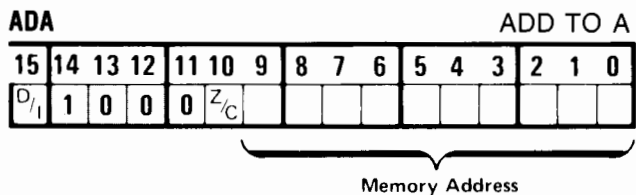

Adds the contents of the addressed memory location to the contents of the A-register. The sum remains in the A-register and the contents of the memory cell are unaltered. The result of this addition may set the extend bit or the overflow bit. (Extend and overflow examples are illustrated on page A-13.)

that contained in the next sequential memory location (m + 1). A return to the main program sequence at P + 1 will be effected by a JMP indirect through location m. This instruction has undetermined results if executed while CDS is enabled.

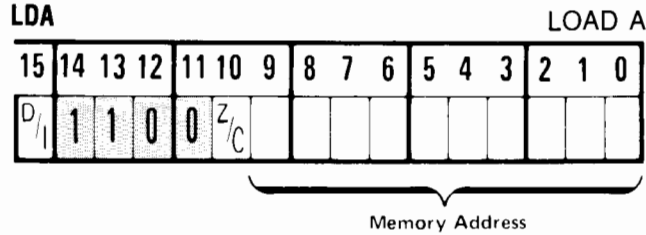

Loads the contents of the addressed memory location into the A-register. The contents of the memory cell are unaltered.

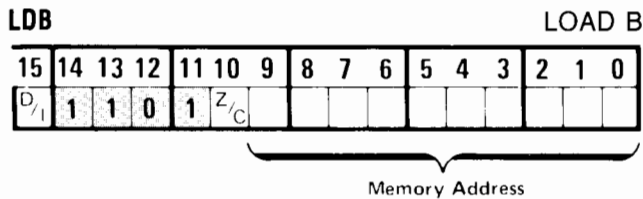

Loads the contents of the addressed memory location into the B-register. The contents of the memory cell are unaltered.

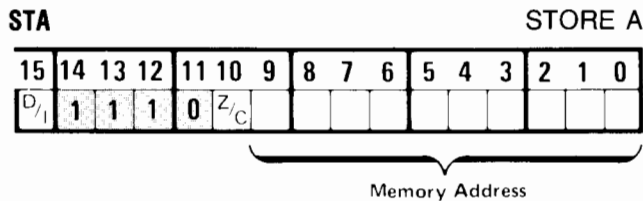

Stores the contents of the A-register in the addressed memory location. The previous contents of the memory cell are lost; the A-register contents are unaltered. Current page, direct addressing with this instruction will produce undefined results if CDS is enabled.

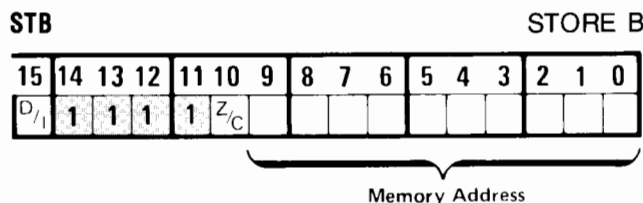

Stores the contents of the B-register in the addressed memory location. The previous contents of the memory cell are lost; the B-register contents are unaltered. Current page, direct addressing with this instruction will produce undefined results if CDS is enabled.

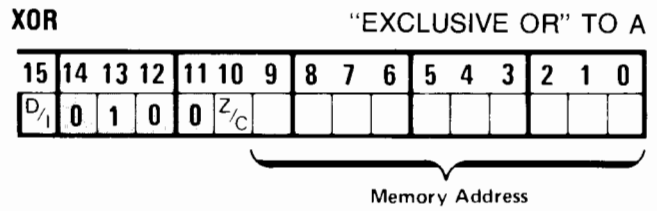

Combines the contents of the addressed memory location and the contents of the A-register by performing a logical "exclusive or" operation. The contents of the memory cell are unaltered.

3-22. REGISTER REFERENCE INSTRUCTIONS

The 39 register reference instructions execute functions on data contained in the A-register, B-register, and E-register. These instructions are divided into two groups: the shift/rotate group (SRG) and the alter/skip group (ASG). In each group, several instructions may be combined into one word. Since the two groups perform separate and distinct functions, instructions from the two groups cannot be mixed. Unshaded bits in the coding diagrams are available for combining other instructions from the same group. The ASG and SRG instructions are not affected by the state of CDS.

3-23. SHIFT/ROTATE GROUP. The 20 instructions in the shift/rotate group (SRG) are defined first; this group is specified by setting bit 10 to a logic 0. A comparison of the various shift/rotate functions are illustrated in Figure 3-3. Rules for combining instructions in this group are as follows (refer to Table 3-3):

- a. Only one instruction can be chosen from each of the two multiple-choice columns.
- b. References can be made to either the A-register or B-register, but not both.
- c. Sequence of execution is from left to right.
- d. In machine code, use zeros to exclude unwanted operations.
- e. Code a logic 1 in bit position 9 to enable shifts or rotates in the first position; code a logic 1 in bit position 4 to enable shifts or rotates in the second position.
- f. The extend bit is not affected unless specifically stated. However, if a "rotate-with-E" instruction (ELA, ELB, ERA, or ERB) is coded but disabled by a logic 0 in bit position 9 and/or position 4, the E-register will be updated even though the A- or B-register contents are not affected; to avoid this situation, code a "no operation" (four zeros) in the first and/or second positions (3 zeros for ALS/BLS).

Table 3-3. Shift/Rotate Group Combining Guide

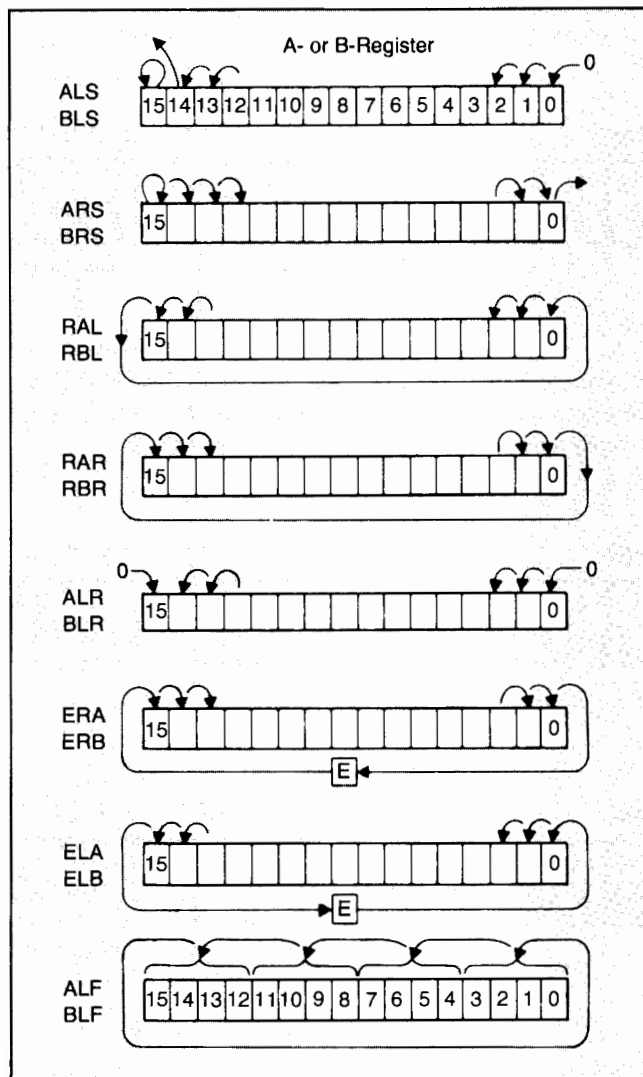
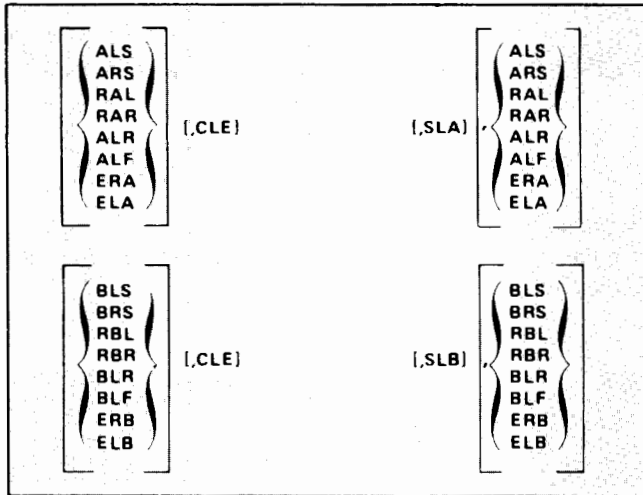
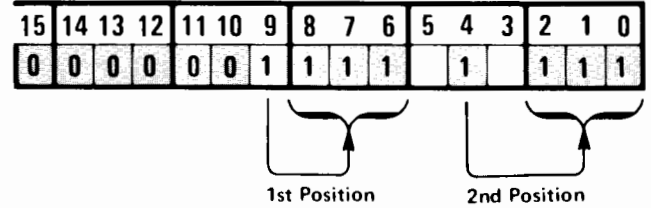

Figure 3-3. Shift and Rotate Functions

ALF ROTATE A LEFT FOUR



Rotates the A-register contents (all 16 bits) left four places. Bits 15, 14, 13, and 12 rotate around to bit positions 3, 2, 1, and 0, respectively. Equivalent to four successive RAL instructions.

ALR A LEFT SHIFT, CLEAR SIGN

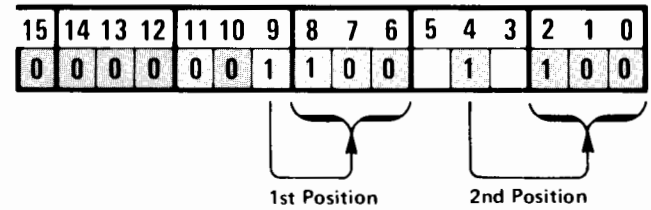

Shifts the A-register contents left one place and clears sign bit 15.

ALS A LEFT SHIFT

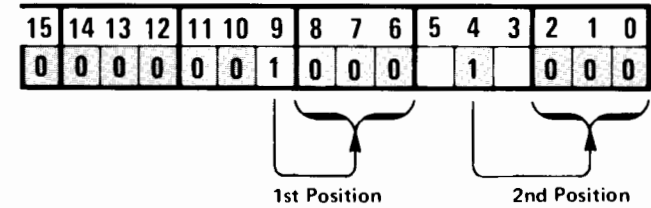

Arithmetically shifts the A-register contents left one place, 15 magnitude bits only; bit 15 (sign) is not affected. The bit shifted out of bit position 14 is lost; a logic 0 replaces vacated bit position 0.

ARS A RIGHT SHIFT

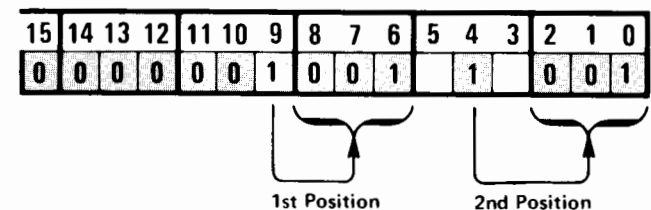

Arithmetically shifts the A-register contents right one place, 15 magnitude bits only; bit 15 (sign) is not affected. A copy of the sign bit is shifted into bit position 14; the bit shifted out of bit position 0 is lost.

BLF ROTATE B LEFT FOUR

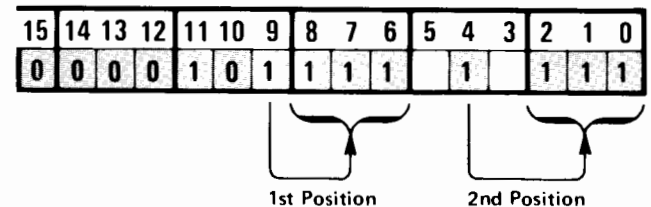

Rotates the B-register contents (all 16 bits) left four places. Bits 15, 14, 13, and 12 rotate around to bit positions 3, 2, 1, and 0, respectively.

tions 3, 2, 1, and 0, respectively. Equivalent to four successive RBL instructions.

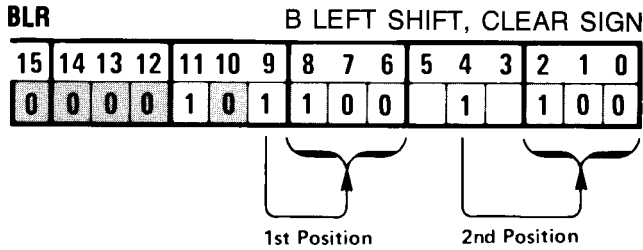

Shifts the B-register contents left one place and clears sign bit 15.

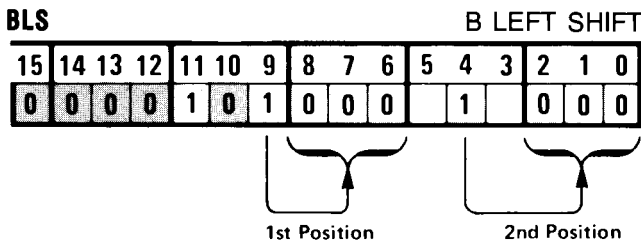

Arithmetically shifts the B-register contents left one place, 15 magnitude bits only; bit 15 (sign) is not affected. The bit shifted out of bit position 14 is lost; a logic 0 replaces vacated bit position 0.

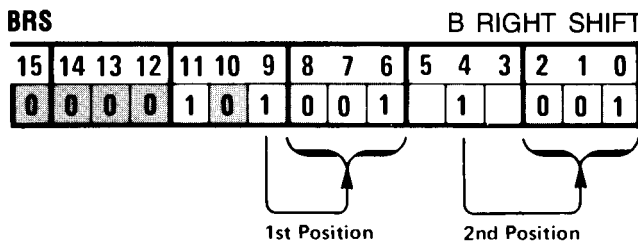

Arithmetically shifts the B-register contents right one place, 15 magnitude bits only; bit 15 (sign) is not affected. A copy of the sign bit is shifted into bit position 14; the bit shifted out of bit position 0 is lost.

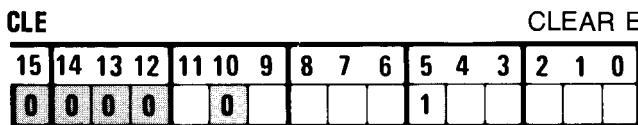

Clears the E-register; i.e., the extend bit becomes a logic 0.

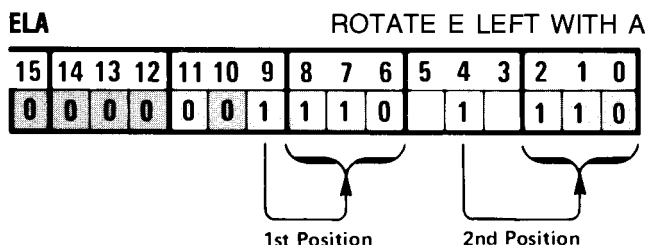

Rotates the E-register content left with the A-register contents (one place). The E-register content rotates into bit position 0; bit 15 rotates into the E-register.

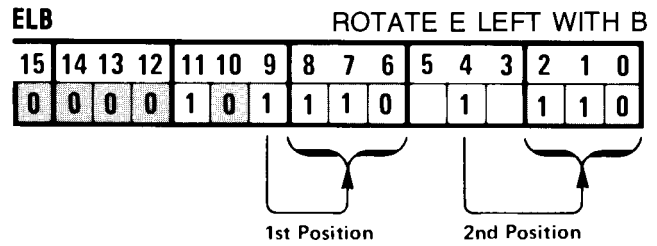

Rotates the E-register content left with the B-register contents (one place). The E-register content rotates into bit position 0; bit 15 rotates into the E-register.

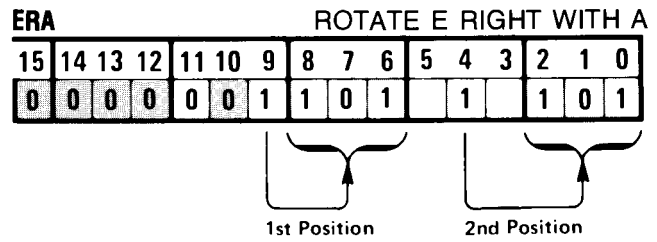

Rotates the E-register content right with the A-register contents (one place). The E-register content rotates into bit position 15; bit 0 rotates into the E-register.

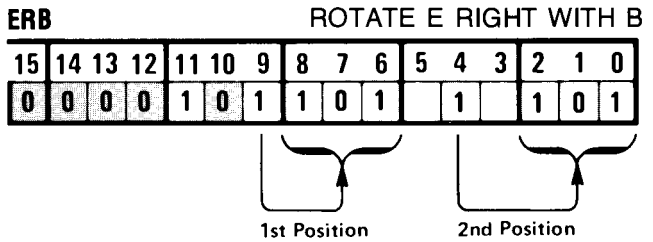

Rotates the E-register content right with the B-register contents (one place). The E-register content rotates into bit position 15; bit 0 rotates into the E-register.

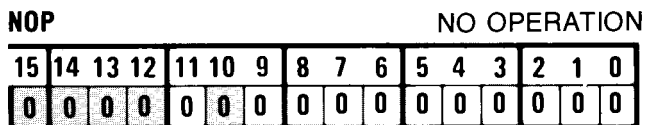

This all-zeros instruction causes a no-operation cycle.

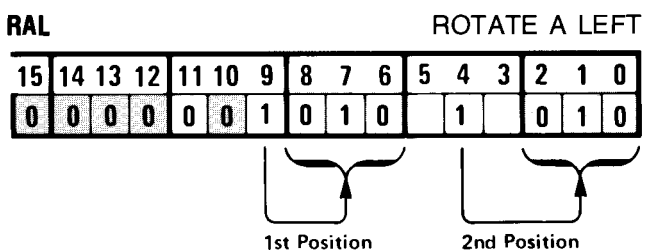

Rotates the A-register contents left one place (all 16 bits). Bit 15 rotates into bit position 0.

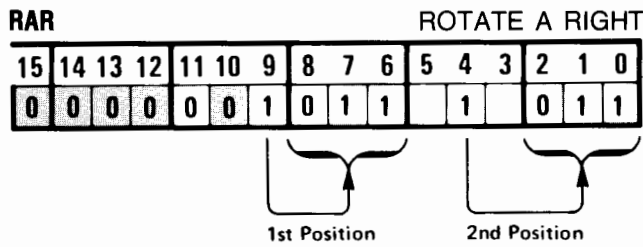

Rotates the A-register contents right one place (all 16 bits). Bit 0 rotates into bit position 15.

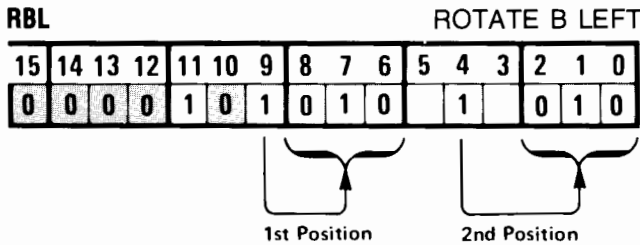

Rotates the B-register contents left one place (all 16 bits). Bit 15 rotates into bit position 0.

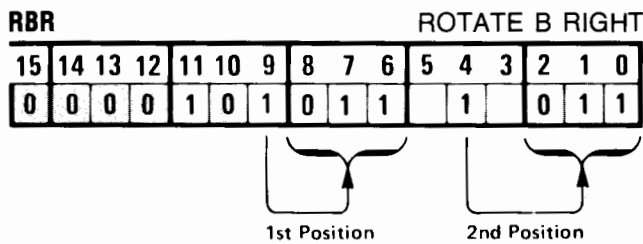

Rotates the B-register contents right one place (all 16 bits). Bit 0 rotates into bit position 15.

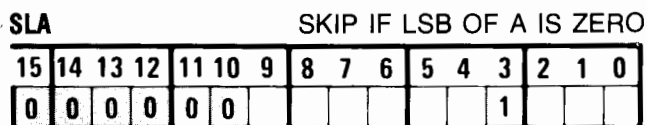

Skips the next instruction if the least-significant bit (bit 0) of the A-register is a logic 0.

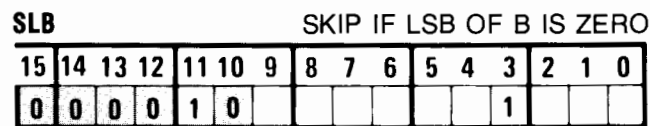

Skips the next instruction if the least-significant bit (bit 0) of the B-register is a logic 0.

3-24. ALTER/SKIP GROUP. The 19 instructions comprising the alter/skip group (ASG) are defined next. This group is specified by setting bit 10 to a logic 1. Rules for combining instructions are as follows (refer to Table 3-4):

- a. Only one instruction can be chosen from each of the two multiple-choice columns.

Table 3-4. Alter/Skip Group Combining Guide

$\left[\begin{matrix} \text{CLA} \\ \text{CMA} \\ \text{CCA} \end{matrix} \right] \left[\text{.SEZ} \right]$	$\left[\begin{matrix} \text{CLE} \\ \text{CME} \\ \text{CCE} \end{matrix} \right] \left[\text{.SSA} \right] \left[\text{.SLA} \right] \left[\text{.INA} \right] \left[\text{.SZA} \right] \left[\text{.RSS} \right]$
$\left[\begin{matrix} \text{CLB} \\ \text{CMB} \\ \text{CCB} \end{matrix} \right] \left[\text{.SEZ} \right]$	$\left[\begin{matrix} \text{CLE} \\ \text{CME} \\ \text{CCE} \end{matrix} \right] \left[\text{.SSB} \right] \left[\text{.SLB} \right] \left[\text{.INB} \right] \left[\text{.SZB} \right] \left[\text{.RSS} \right]$

- b. References can be made to either the A-register or B-register, but not both.
- c. Sequence of execution is from left to right.
- d. If two or more skip functions are combined, the skip function will occur if either or both conditions are met. One exception exists: refer to the RSS instruction.
- e. In machine code, use zeros to exclude unwanted instructions.

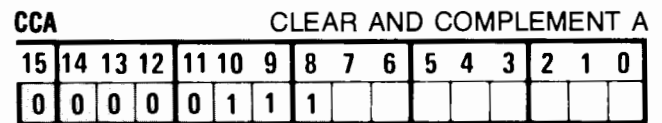

Clears and complements the A-register contents; i.e., the contents of the A-register become 177777 (octal). This is the two's complement form of -1.

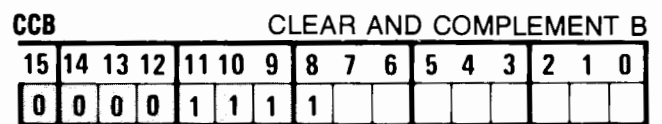

Clears and complements the B-register contents; i.e., the contents of the B-register become 177777 (octal). This is the two's complement form of -1.

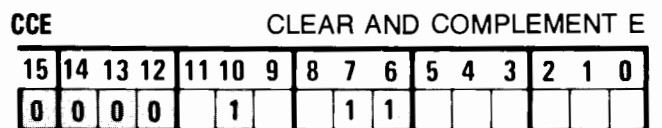

Clears and complements the E-register content (extend bit); i.e., the extend bit becomes a logic 1.

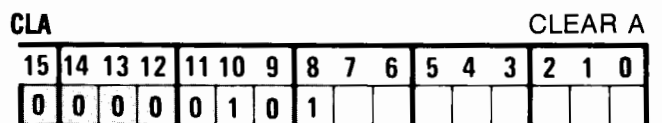

Clears the A-register; i.e., the contents of the A-register becomes 000000 (octal).

CLB				CLEAR B											
15	14	13	12	11	10	9	8	7	6	5	4	3	2	1	0
0	0	0	0	1	1	0	1								

Clears the B-register; i.e., the contents of the B-register become 000000 (octal).

CLE				CLEAR E											
15	14	13	12	11	10	9	8	7	6	5	4	3	2	1	0
0	0	0	0		1			0	1						

Clears the E-register; i.e., the extend bit becomes a logic 0.

CMA				COMPLEMENT A											
15	14	13	12	11	10	9	8	7	6	5	4	3	2	1	0
0	0	0	0	0	1	1	0								

Complements the A-register contents (one's complement).

CMB				COMPLEMENT B											
15	14	13	12	11	10	9	8	7	6	5	4	3	2	1	0
0	0	0	0	1	1	1	0								

Complements the B-register contents (one's complement).

CME				COMPLEMENT E											
15	14	13	12	11	10	9	8	7	6	5	4	3	2	1	0
0	0	0	0		1			1	0						

Complements the E-register content (extend bit).

INA				INCREMENT A											
15	14	13	12	11	10	9	8	7	6	5	4	3	2	1	0
0	0	0	0	0	1								1		

Increments the A-register by one. The overflow bit will be set if an increment of the largest positive number (077777 octal) is made. The extend bit will be set if an all-ones word (177777 octal) is incremented.

INB				INCREMENT B											
15	14	13	12	11	10	9	8	7	6	5	4	3	2	1	0
0	0	0	0	1	1								1		

Increments the B-register by one. The overflow bit will be set if an increment of the largest positive number (077777

octal) is made. The extend bit will be set if an all-ones word (177777 octal) is incremented.

RSS				REVERSE SKIP SENSE											
15	14	13	12	11	10	9	8	7	6	5	4	3	2	1	0
0	0	0	0		1										1

Skip occurs for any of the following skip instructions, if present, when the non-zero condition is met. An RSS without a skip instruction in the word causes an unconditional skip. If a word with RSS also includes both SSA and SLA (or SSB and SLB), bits 15 and 0 must both be logic 1's for a skip to occur; in all other cases, a skip occurs if one or more skip conditions are met.

SEZ				SKIP IF E IS ZERO											
15	14	13	12	11	10	9	8	7	6	5	4	3	2	1	0
0	0	0	0		1					1					

Skips the next instruction if the E-register content (extend bit) is a logic 0.

SLA				SKIP IF LSB OF A IS ZERO											
15	14	13	12	11	10	9	8	7	6	5	4	3	2	1	0
0	0	0	0	0	1							1			

Skips the next instruction if the least-significant bit (bit 0) of the A-register is a logic 0; i.e., skips if an even number is in the A-register.

SLB				SKIP IF LSB OF B IS ZERO											
15	14	13	12	11	10	9	8	7	6	5	4	3	2	1	0
0	0	0	0	1	1							1			

Skips the next instruction if the least-significant bit (bit 0) of the B-register is a logic 0; i.e., skips if an even number is in the B-register.

SSA				SKIP IF SIGN OF A IS ZERO											
15	14	13	12	11	10	9	8	7	6	5	4	3	2	1	0
0	0	0	0	0	1					1					

Skips the next instruction if the sign bit (bit 15) of the A-register is a logic 0; i.e., skips if a positive number is in the A-register.

SSB SKIP IF SIGN OF B IS ZERO

15	14	13	12	11	10	9	8	7	6	5	4	3	2	1	0
0	0	0	0	1	1					1					

Skips the next instruction if the sign bit (bit 15) of the B-register is a logic 0; i.e., skips if a positive number is in the B-register.

SZA SKIP IF A IS ZERO

15	14	13	12	11	10	9	8	7	6	5	4	3	2	1	0
0	0	0	0	0	1									1	

Skips the next instruction if the A-register contents are zero (16 zeros).

SZB SKIP IF B IS ZERO

15	14	13	12	11	10	9	8	7	6	5	4	3	2	1	0
0	0	0	0	1	1									1	

Skips the next instruction if the B-register contents are zero (16 zeros).

3-25. INPUT/OUTPUT INSTRUCTIONS

The following input/output instructions provide the capability of setting, clearing or testing the flag and control bits associated with DMA, programmed I/O, interrupts, memory protect, time base generator, parity error, Global Register, and overflow. I/O instructions with select codes of seven or less have various functions. (Refer to Table 5-3 for further information regarding specific select-code functions.) I/O instructions permit data transfer between the A- and B-registers and either specific I/O devices or between registers associated with memory protect, parity error, or interrupts. The various registers and I/O devices are addressed by means of their register numbers and select codes.

Bit 11, where relevant, specifies the A- or B-register or distinguishes between set control and clear control; otherwise, bit 11 may be a logic 0 or a logic 1 without affecting the instruction (although the assembler will assign zeros in this case). In those instructions where bit position 9 includes the letters H/C, the programmer has the choice of holding (logic 0) or clearing (logic 1) the device flag after executing the instruction. (Exception: the H/C bit associated with instructions SOC and SOS holds or clears the overflow bit instead of the device flag.) Note that this H/C option is not supported on some of the I/O instructions with select code less than 10 octal.

Bits 8, 7, and 6, specify the appropriate I/O instruction. When the Global Register is enabled, bits 5 through 0

apply the instruction to a register on the I/O card whose select code is in the Global Register. (The Global Register is discussed further in paragraph 6-4).

NOTE

Execution of I/O instructions is inhibited when the memory protect feature is enabled. Refer to paragraph 5-3.

The following instruction descriptions assume that the Global Register is disabled and, therefore, the instructions are addressed to a select code. The extension of I/O instructions is not affected by the state of CDS.

CLC CLEAR CONTROL

15	14	13	12	11	10	9	8	7	6	5	4	3	2	1	0
1	0	0	0	1	1	H/C	1	1	1						

Select Code or Register Number

Clears the control bit (Control 30) of the selected I/O channel or function. This turns off the specific device channel and prevents it from interrupting. A CLC 00 instruction clears the control bits from select code 06 upward, effectively turning off all I/O devices.

CLF CLEAR FLAG

15	14	13	12	11	10	9	8	7	6	5	4	3	2	1	0
1	0	0	0		1	1	0	0	1						

Select Code or Register Number

Clears the flag (Flag 30) of the selected I/O channel or function. A CLF 00 instruction disables the interrupt system for the time base generator and all interface cards; this does not affect the status of the individual channel flags.

CLO CLEAR OVERFLOW

15	14	13	12	11	10	9	8	7	6	5	4	3	2	1	0
1	0	0	0	0	1	1	0	0	1	0	0	0	0	0	1

Clears the overflow bit.

HLT HALT

15	14	13	12	11	10	9	8	7	6	5	4	3	2	1	0
1	0	0	0		1	H/C	0	0	0						

Select Code or Register Number

Halts the computer, holds or clears the flag of the selected I/O channel, and invokes the virtual control panel

program. The HLT instruction will be contained in the T-register, which is displayed on the VCP when the VCP program starts executing. The P-register (also displayed) will contain the HLT location plus one. Note that if break is not enabled on any I/O card, the HLT instruction has no effect.

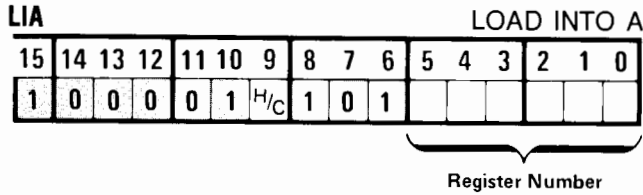

Loads the contents of the addressed I/O buffer or special function register into the A-register.

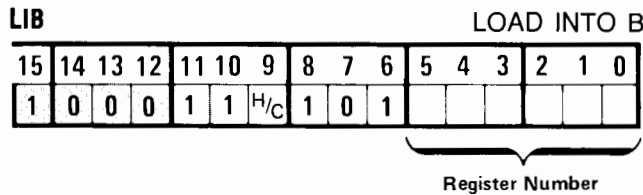

Loads the contents of the addressed I/O buffer or special function register into the B-register.

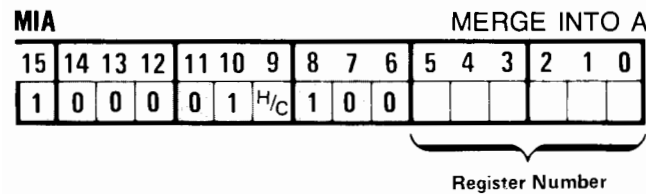

By executing a logical "inclusive or" function, merges the contents of the addressed I/O buffer or special function register into the A-register.

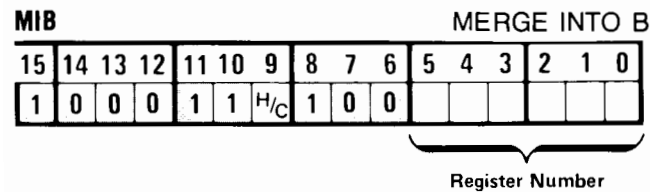

By executing a logical "inclusive or" function, merges the contents of the addressed I/O buffer or special function register into the B-register.

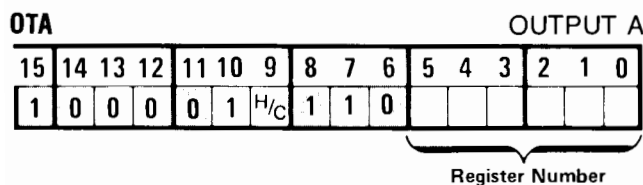

Outputs the contents of the A-register to the addressed I/O buffer or special function register. The contents of the A-register are not altered.

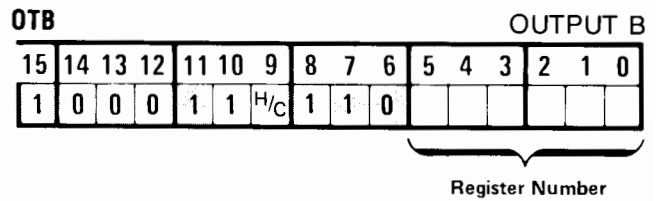

Outputs the contents of the B-register to the addressed I/O buffer or special function register. The contents of the B-register are not altered.

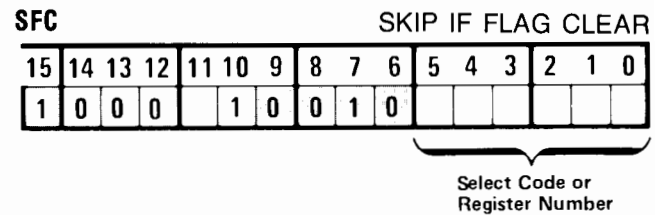

Skips the next programmed instruction if the flag (Flag 30) of the selected channel is clear (device busy).

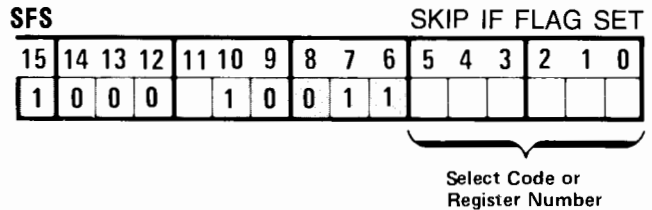

Skips the next programmed instruction if the flag (Flag 30) of the selected channel is set (device ready).

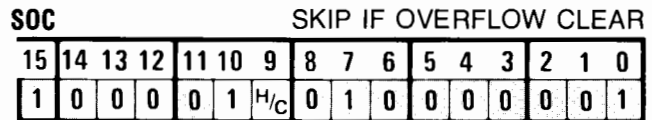

Skips the next programmed instruction if the overflow bit is clear. Use the H/C (bit 9) to either hold or clear the overflow bit following the completion of this instruction (whether the skip is taken or not).

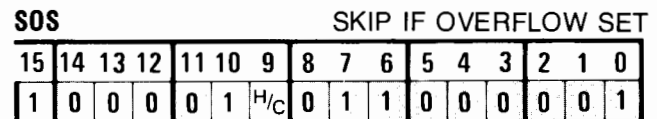

Skips the next programmed instruction if the overflow bit is set. Use the H/C bit (bit 9) to either hold or clear the overflow bit following the completion of this instruction (whether the skip is taken or not).

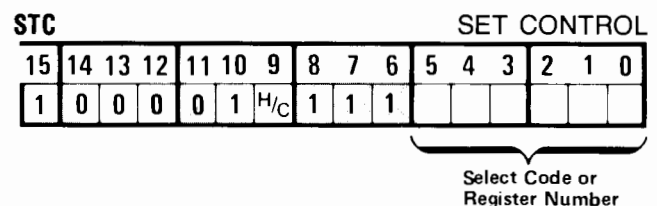

Sets the control bit (Control 30) of the selected I/O channel or function.

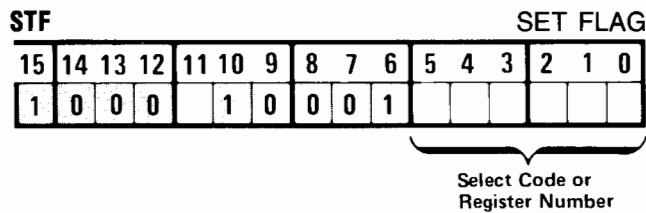

Sets the flag (Flag 30) of the selected I/O channel or function. An STF 00 instruction enables the interrupt system for the time base generator and all interface cards.

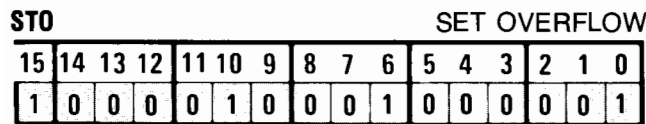

Sets the overflow bit.

3-26. EXTENDED ARITHMETIC MEMORY REFERENCE INSTRUCTIONS

The four extended arithmetic memory reference instructions provide for integer multiply and divide and for loading and storing double-length words to and from the A- and B-registers. The complete instruction requires two words: one for the instruction code and one for the address. When stored in memory, the instruction word is the first to be fetched; the address word is in the next sequential location.

Since 15 bits are available for the address, these instructions can directly address any location in memory. As for all memory reference instructions, indirect addressing to any number of levels may also be used. A logic 0 in bit position 15 specifies direct addressing; a logic 1 specifies indirect addressing.

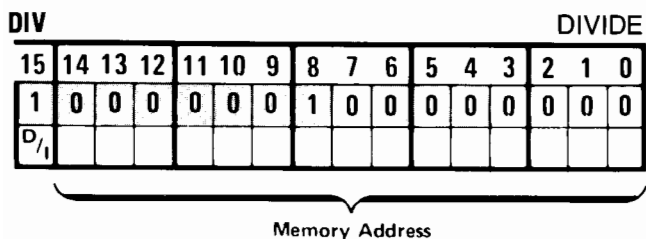

Divides a double-word integer in the combined B- and A-registers by a 16-bit integer in the addressed memory location. The result is a 16-bit integer quotient in the A-register and a 16-bit integer remainder in the B-register. Overflow can result from an attempt to divide by zero, or from an attempt to divide by a number too small for the dividend. In the former case (divide by zero), the division will not be attempted and the B- and A-register contents will be unchanged except that a negative quantity will be made positive. In the latter case (divisor too small), the execution will be attempted with unpredictable results left in the B- and A-registers. If there is no divide error, the overflow bit is cleared.

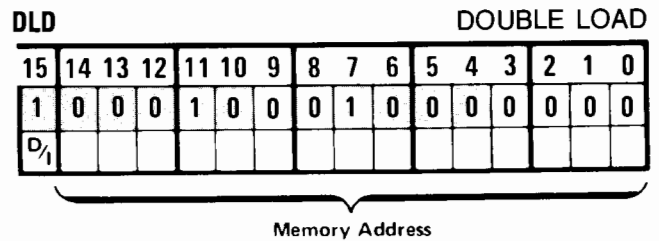

Loads the contents of addressed memory location m (and m+1) into the A- and B-registers, respectively. If m is base relative and CDS mode is enabled, the base register will be added to m and the references will come from m+Q and m+Q+1 (even if m+1 is not base relative).

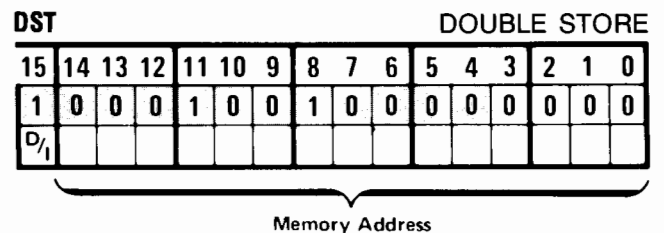

Stores the double-word quantity in the A- and B-registers into addressed memory locations m (and m+1), respectively. If m is base relative and CDS mode is enabled, the base register will be added to m and the references will come from m+Q and m+Q+1 (even if m+1 is not base relative).

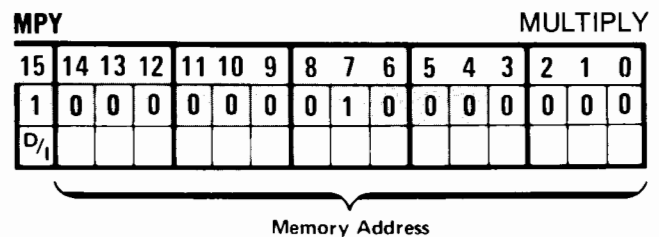

Multiplies a 16-bit integer in the A-register by a 16-bit integer in the addressed memory location. The resulting double-length integer product resides in the B- and A-registers, with the B-register containing the sign bit and the most-significant 15 bits of the quantity. The A-register may be used as an operand (i.e., memory address 0), resulting in an arithmetic square. The instruction clears the overflow bit.

3-27. EXTENDED ARITHMETIC REGISTER REFERENCE INSTRUCTIONS

The six extended arithmetic register reference instructions provide various types of shifting operations on the combined contents of the B- and A-registers. The B-register is considered to be to the left (most-significant word) and the A-register is considered to be to the right (least-significant word). An example of each type of shift operation is illustrated in Figure 3-4.

The complete instruction is given in one word and includes four bits (unshaded) to specify the number of shifts (1 to 16). By viewing these four bits as a binary-coded number, the number of shifts is easily expressed; i.e., binary-coded 1 = 1 shift, binary-coded 2 = 2 shifts . . . binary-coded 15 = 15 shifts. The maximum number of 16 shifts is coded with four zeros, which essentially exchanges the contents of the B- and A-registers.

The extend bit is not affected by any of the following instructions. Except for the arithmetic shifts, overflow also is not affected.

The execution of extended arithmetic register reference instructions is not affected by the state of CDS.

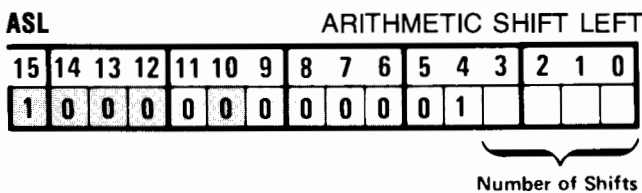

Arithmetically shifts the combined contents of the B- and A-registers left n places. The value of n may be any number from 1 through 16. Zeros are filled into vacated low-order positions of the A-register. The sign bit is not affected, and data bits are lost out of bit position 14 of the B-register. If any one of the lost bits is a significant data bit ("1" for positive numbers, "0" for negative numbers), the overflow bit will be set; otherwise, overflow will be cleared during execution. See ASL example in Figure 3-4. Note that two additional shifts in this example would cause an error by losing a significant '1'.

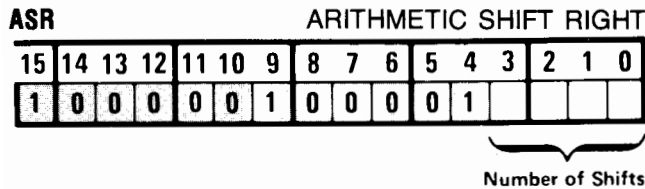

Arithmetically shifts the combined contents of the B- and A-registers right n places. The value of n may be any number from 1 through 16. The sign bit is unchanged and is extended into bit positions vacated by the right shift. Data bits shifted out of the least-significant end of the A-register are lost. Overflow cannot occur because the instruction clears the overflow bit.

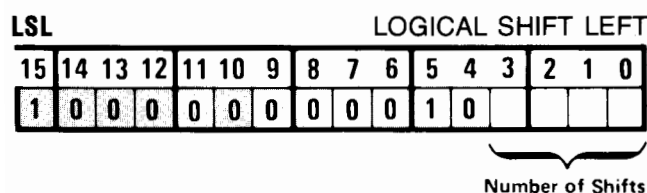

Logically shifts the combined contents of the B- and A-registers left n places. The value of n may be any

number from 1 through 16. Zeros are filled into vacated low-order bit positions of the A-register; data bits are lost out of the high-order bit positions of the B-register.

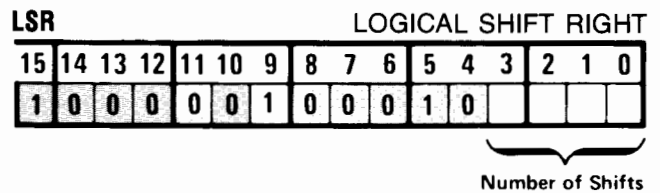

Logically shifts the combined contents of the B- and A-registers right n places. The value of n may be any number from 1 through 16. Zeros are filled into vacated high-order bit positions of the B-register; data bits are lost out of the low-order bit positions of the A-register.

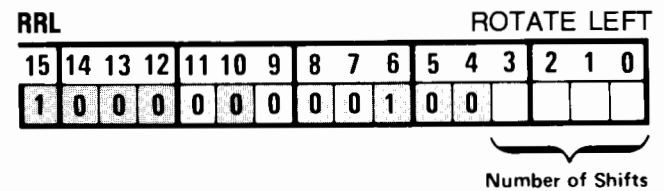

Rotates the combined contents of the B- and A-registers left n places. The value of n may be any number from 1 through 16. No bits are lost or filled in. Data bits shifted out of the high-order end of the B-register are rotated around to enter the low-order end of the A-register.

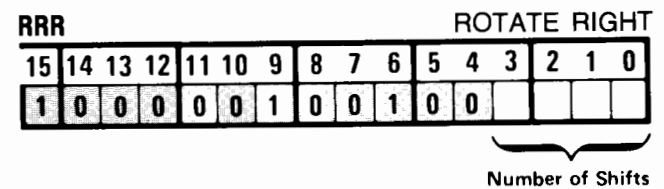

Rotates the combined contents of the B- and A-registers right n places. The value of n may be any number from 1 through 16. No bits are lost or filled in. Data bits shifted out of the low-order end of the A-register are rotated around to enter the high-order end of the B-register.

3-28. EXTENDED INSTRUCTION GROUP

3-29. INDEX/REGISTER INSTRUCTIONS. The index registers (X and Y) are two 16-bit registers accessible by the following instructions.

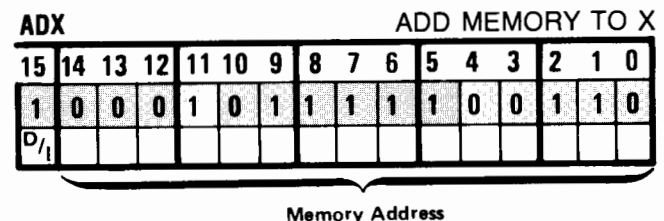

Adds the contents of the addressed memory location to the contents of the X-register. The sum remains in the

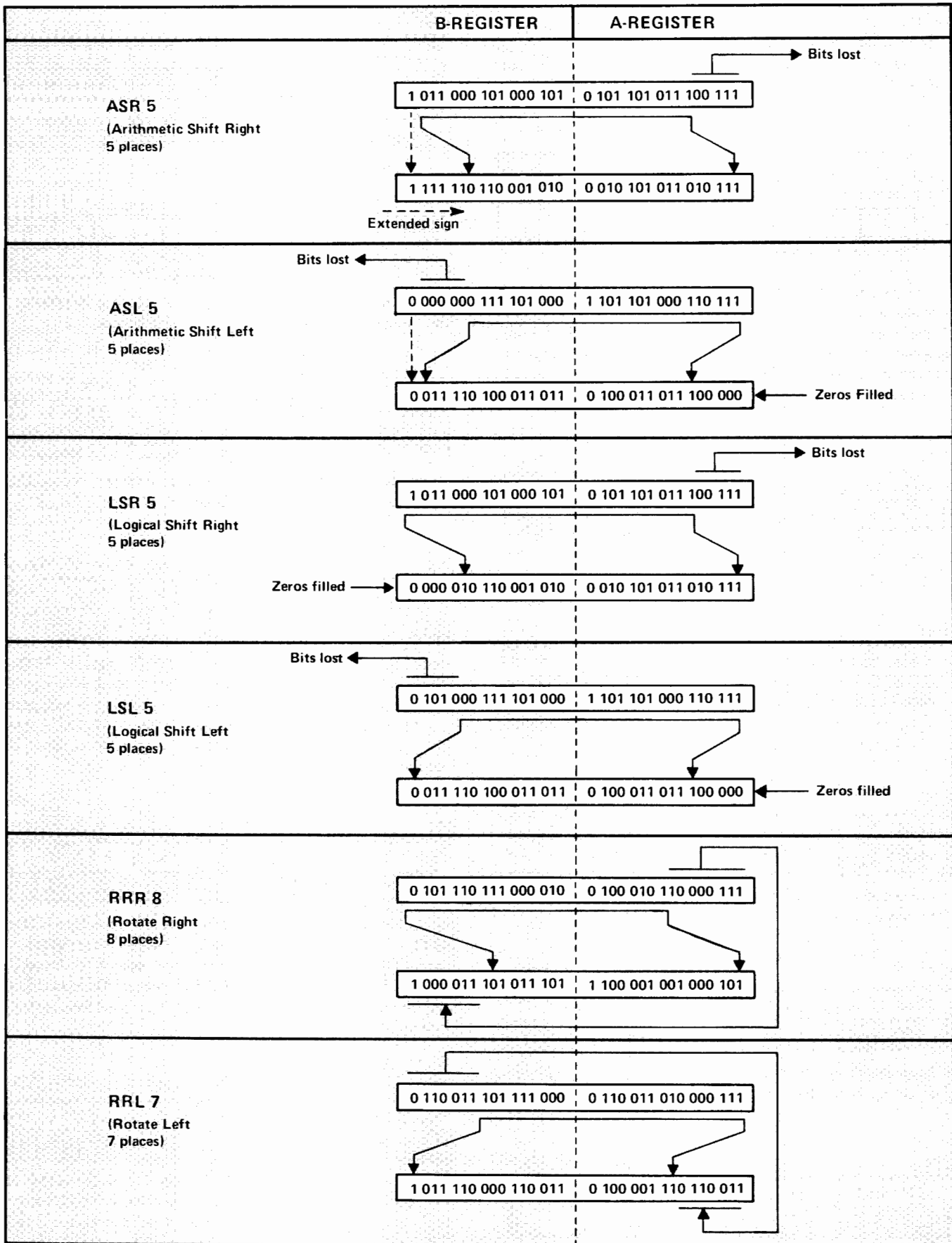

Figure 3-4. Examples of Double-Word Shifts and Rotates

X-register and the contents of the memory cell are unaltered. The result of this addition may set the extend bit or the overflow bit. The A- and B-registers can be referenced as memory locations 0 and 1, respectively.

ADY ADD MEMORY TO Y

15	14	13	12	11	10	9	8	7	6	5	4	3	2	1	0
1	0	0	0	1	0	1	1	1	1	1	0	1	1	1	0
Memory Address															

Adds the contents of the addressed memory location to the contents of the Y-register. The sum remains in the Y-register and the contents of the memory cell are unaltered. The result of this addition may set the extend bit or the overflow bit. The A- and B-registers can be referenced as memory locations 0 and 1, respectively.

CAX COPY A TO X

15	14	13	12	11	10	9	8	7	6	5	4	3	2	1	0
1	0	0	0	0	0	1	1	1	1	1	0	0	0	0	1

Copies the contents of the A-register into the X-register. The contents of the A-register are unaltered.

CAY COPY A TO Y

15	14	13	12	11	10	9	8	7	6	5	4	3	2	1	0
1	0	0	0	0	0	1	1	1	1	1	0	1	0	0	1

Copies the contents of the A-register into the Y-register. The contents of the A-register are unaltered.

CBX COPY B TO X

15	14	13	12	11	10	9	8	7	6	5	4	3	2	1	0
1	0	0	0	1	0	1	1	1	1	1	0	0	0	0	1

Copies the contents of the B-register into the X-register. The contents of the B-register are unaltered.

CBY COPY B TO Y

15	14	13	12	11	10	9	8	7	6	5	4	3	2	1	0
1	0	0	0	1	0	1	1	1	1	1	0	1	0	0	1

Copies the contents of the B-register into the Y-register. The contents of the B-register are unaltered.

CXA COPY X TO A

15	14	13	12	11	10	9	8	7	6	5	4	3	2	1	0
1	0	0	0	0	0	1	1	1	1	1	0	0	1	0	0

Copies the contents of the Y-register into the A-register. The contents of the Y-register are unaltered.

CXB COPY X TO B

15	14	13	12	11	10	9	8	7	6	5	4	3	2	1	0
1	0	0	0	1	0	1	1	1	1	1	0	0	1	0	0

Copies the contents of the Y-register into the B-register. The contents of the Y-register are unaltered.

CYA COPY Y TO A

15	14	13	12	11	10	9	8	7	6	5	4	3	2	1	0
1	0	0	0	0	0	1	1	1	1	1	0	1	1	0	0

Copies the contents of the X-register into the A-register. The contents of the X-register are unaltered.

CYB COPY Y TO B

15	14	13	12	11	10	9	8	7	6	5	4	3	2	1	0
1	0	0	0	1	0	1	1	1	1	1	0	1	1	0	0

Copies the contents of the X-register into the B-register. The contents of the X-register are unaltered.

DSX DECREMENT X AND SKIP IF ZERO

15	14	13	12	11	10	9	8	7	6	5	4	3	2	1	0
1	0	0	0	1	0	1	1	1	1	1	1	0	0	0	1

Subtracts one from the contents of the X-register. If the result of this operation is zero (X-register decremented from 000001 to 000000), the next instruction is skipped; i.e., the P-register count is advanced two counts instead of one count. If the result is not zero, the next sequential instruction is executed.

DSY DECREMENT Y AND SKIP IF ZERO

15	14	13	12	11	10	9	8	7	6	5	4	3	2	1	0
1	0	0	0	1	0	1	1	1	1	1	1	1	0	0	1

Subtracts one from the contents of the Y-register. If the result of this operation is zero (Y-register decremented from 000001 to 000000), the next instruction is skipped; i.e., the P-register count is advanced two counts instead of one count. If the result is not zero, the next sequential instruction is executed.

ISX INCREMENT X AND SKIP IF ZERO

15	14	13	12	11	10	9	8	7	6	5	4	3	2	1	0
1	0	0	0	1	0	1	1	1	1	1	1	0	0	0	0

Adds one to the contents of the X-register. If the result of this operation is zero (X-register rolls over to 000000 from 177777), the next instruction is skipped; i.e., the P-register count is advanced two counts instead of one count. If the result is not zero, the next sequential instruction is executed.

ISY INCREMENT Y AND SKIP IF ZERO

15	14	13	12	11	10	9	8	7	6	5	4	3	2	1	0
1	0	0	0	1	0	1	1	1	1	1	1	1	0	0	0

Adds one to the contents of the Y-register. If the result of this operation is zero (Y-register rolls over to 000000 from 177777), the next instruction is skipped; i.e., the P-register count is advanced two counts instead of one count. If the result is not zero, the next sequential instruction is executed.

LAX LOAD A INDEXED BY X

15	14	13	12	11	10	9	8	7	6	5	4	3	2	1	0
1	0	0	0	0	0	1	1	1	1	1	0	0	0	1	0
D ₇ /I ₁															

Operand Address

Loads the A-register with the contents indicated by the effective address, which is computed by adding the contents of the X-register to the operand address. The effective address is loaded into the M-register; the X-register and memory contents are not altered. Indirect addressing is resolved before indexing; bit 15 of the effective address is ignored. If CDS mode is enabled, the operand address is resolved for base relativity and the base register will be added before indexing. The index value can be positive or negative.

LAY LOAD A INDEXED BY Y

15	14	13	12	11	10	9	8	7	6	5	4	3	2	1	0
1	0	0	0	0	0	1	1	1	1	1	0	1	0	1	0
D ₇ /I ₁															

Operand Address

Loads the A-register with the contents indicated by the effective address, which is computed by adding the contents of the Y-register to the operand address. The effective address is loaded into the M-register; the Y-register and memory contents are not altered. Indirect addressing is resolved before indexing; bit 15 of the effective address is ignored. If CDS mode is enabled, the operand address is resolved for base relativity and the base register will be added before indexing. The index value can be positive or negative.

LBX LOAD B INDEXED BY X

15	14	13	12	11	10	9	8	7	6	5	4	3	2	1	0
1	0	0	0	1	0	1	1	1	1	1	0	0	0	1	0
D ₇ /I ₁															

Operand Address

Loads the B-register with the contents indicated by the effective address, which is computed by adding the contents of the X-register to the operand address. The effective address is loaded into the M-register; the X-register and memory contents are not altered. Indirect addressing is resolved before indexing; bit 15 of the effective address is ignored. If CDS mode is enabled, the operand address is resolved for base relativity and the base register will be added before indexing. The index value can be positive or negative.

address is loaded into the M-register; the X-register and memory contents are not altered. Indirect addressing is resolved before indexing; bit 15 of the effective address is ignored. If CDS mode is enabled, the operand address is resolved for base relativity and the base register will be added before indexing. The index value can be positive or negative.

LBY LOAD B INDEXED BY Y

15	14	13	12	11	10	9	8	7	6	5	4	3	2	1	0
1	0	0	0	1	0	1	1	1	1	1	0	1	0	1	0
D ₇ /I ₁															

Operand Address

Loads the B-register with the contents indicated by the effective address, which is computed by adding the contents of the Y-register to the operand address. The effective address is loaded into the M-register; the X-register and memory contents are not altered. Indirect addressing is resolved before indexing; bit 15 of the effective address is ignored. If CDS mode is enabled, the operand address is resolved for base relativity and the base register will be added before indexing. The index value can be positive or negative.

LDX LOAD X FROM MEMORY

15	14	13	12	11	10	9	8	7	6	5	4	3	2	1	0
1	0	0	0	1	0	1	1	1	1	1	0	0	1	0	1
D ₇ /I ₁															

Memory Address

Loads the contents of the addressed memory location into the X-register. The A- and B-registers may be addressed as locations 00000 and 00001, respectively; however, if it is desired to load from the A- or B-register, copy instructions CAX or CBX should be used since they are more efficient.

LDY LOAD Y FROM MEMORY

15	14	13	12	11	10	9	8	7	6	5	4	3	2	1	0
1	0	0	0	1	0	1	1	1	1	1	0	1	1	0	1
D ₇ /I ₁															

Memory Address

Loads the contents of the addressed memory location into the Y-register. The A- and B-registers may be addressed as locations 00000 and 00001, respectively; however, if it is desired to load from the A- or B-register, copy instructions CAY or CBY should be used since they are more efficient.

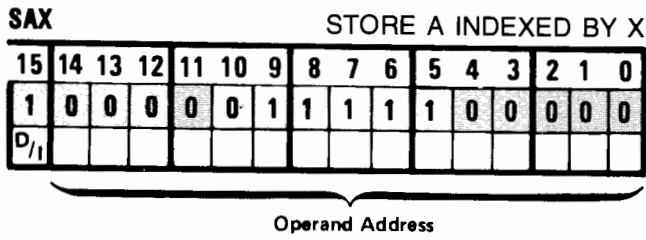

Stores the contents of the A-register into the location indicated by the effective address, which is computed by adding the contents of the X-register to the operand address. The effective address is loaded into the M-register; the A- and X-register contents are not altered. Indirect addressing is resolved before indexing; bit 15 of the effective address is ignored. If CDS mode is enabled, the operand address is resolved for base relativity and the base register will be added before indexing. The index value can be positive or negative.

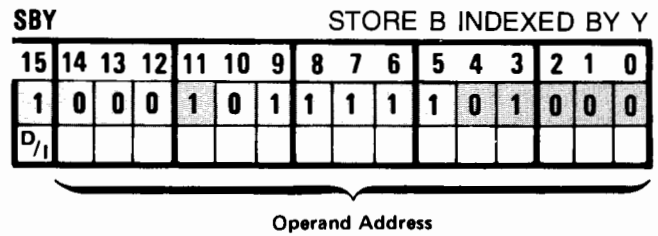

Stores the contents of the B-register into the location indicated by the effective address, which is computed by adding the contents of the Y-register to the operand address. The effective address is loaded into the M-register; the B- and Y-register contents are not altered. Indirect addressing is resolved before indexing; bit 15 of the effective address is ignored. If CDS mode is enabled, the operand address is resolved for base relativity and the base register will be added before indexing. The index value can be positive or negative.

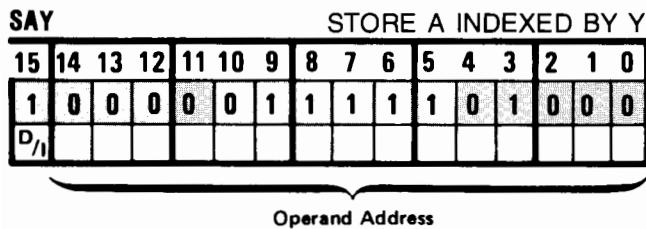

Stores the contents of the A-register into the location indicated by the effective address, which is computed by adding the contents of the Y-register to the operand address. The effective address is loaded into the M-register; the A- and Y-register contents are not altered. Indirect addressing is resolved before indexing; bit 15 of the effective address is ignored. If CDS mode is enabled, the operand address is resolved for base relativity and the base register will be added before indexing. The index value can be positive or negative.



Stores the contents of the X-register into the addressed memory location. The A- and B-registers may be addressed as locations 00000 and 00001, respectively. The X-register contents are not altered.

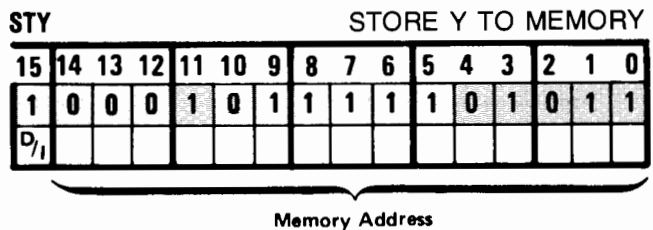

Stores the contents of the Y-register into the addressed memory location. The A- and B-registers may be addressed as locations 00000 and 00001, respectively. The Y-register contents are not altered.

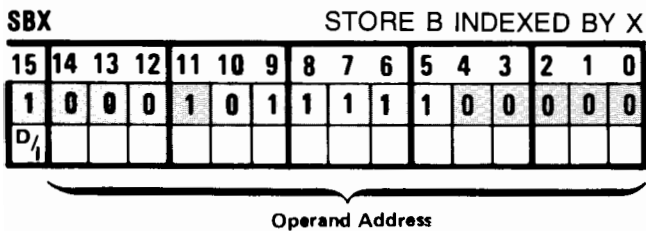

Stores the contents of the B-register into the location indicated by the effective address, which is computed by adding the contents of the X-register to the operand address. The effective address is loaded into the M-register; the B- and X-register contents are not altered. Indirect addressing is resolved before indexing; bit 15 of the effective address is ignored. If CDS mode is enabled, the operand address is resolved for base relativity and the base register will be added before indexing. The index value can be positive or negative.

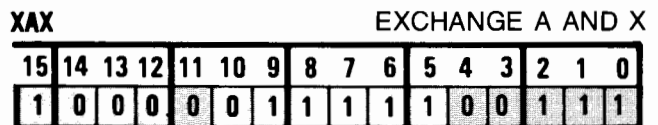

Exchanges the contents of the A- and X-registers.

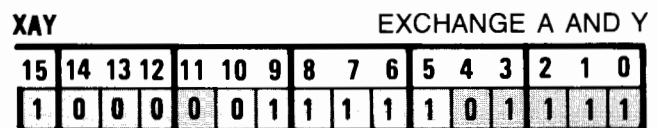

Exchanges the contents of the A- and Y-registers.

XBX **EXCHANGE B AND X**

15	14	13	12	11	10	9	8	7	6	5	4	3	2	1	0
1	0	0	0	1	0	1	1	1	1	1	0	0	1	1	1

Exchanges the contents of the B- and X-registers.

XBY **EXCHANGE B AND Y**

15	14	13	12	11	10	9	8	7	6	5	4	3	2	1	0
1	0	0	0	1	0	1	1	1	1	1	0	1	1	1	1

Exchanges the contents of the B- and Y-registers.

3-30. JUMP INSTRUCTIONS. The following four jump instructions allow a program to either jump to or exit from a subroutine.

JLA **JUMP AND LOAD A**

15	14	13	12	11	10	9	8	7	6	5	4	3	2	1	0
1	0	0	0	0	0	0	1	1	0	0	0	0	0	0	0
D ₁															

Memory Address

This instruction, executed in location P, causes computer control to jump unconditionally to the memory location specified by the second word of the instruction. The contents of the program counter plus two are stored in the A-register. A return to the main program will be effected by a JMP indirect through location 00000 (the A-register).

JLB **JUMP AND LOAD B**

15	14	13	12	11	10	9	8	7	6	5	4	3	2	1	0
1	0	0	0	1	0	0	1	1	0	0	0	0	0	0	0
D ₁															

Memory Address

This instruction, executed in location P, causes computer control to jump unconditionally to the memory location specified by the second word of the instruction. The contents of the program counter plus two are stored in the B-register. A return to the main program will be effected by a JMP indirect through location 00001 (the B-register).

JLY **JUMP AND LOAD Y**

15	14	13	12	11	10	9	8	7	6	5	4	3	2	1	0
1	0	0	0	1	0	1	1	1	1	1	1	0	0	1	0
D ₁															

Memory Address

This instruction is designed for entering a subroutine. The instruction, executed in location P, causes computer

control to jump unconditionally to the memory location specified in the memory address. Indirect addressing may be specified. The contents of the P-register plus two (return address) is loaded into the Y-register. A return to the main program sequence at P + 2 may be effected by a JPY instruction (described next).

JPY **JUMP INDEXED BY Y**

15	14	13	12	11	10	9	8	7	6	5	4	3	2	1	0
1	0	0	0	1	0	1	1	1	1	1	1	1	0	1	0
0															

Operand Address

Transfers control to the effective address, which is computed by adding the contents of the Y-register to the operand address. Indirect addressing is not allowed. The effective address is loaded into the P-register; the Y-register contents are not altered. Memory protect checks are performed on all references to memory (read, write, fetch), except references to memory locations 0 and 1 (A and B).

3-31. BYTE MANIPULATION INSTRUCTIONS. A byte address is defined as two times the word address plus zero or one, depending on whether the byte is in the high-order position (bits 8 through 15) or low-order position (bits 0 through 7) of the word containing it. If the byte of interest is in bit positions 8 through 15 of memory location 100, for example, then the address of that byte is $2 * 100 + 0$, or 200; the address of the low-order byte in the same location is 201 ($2 * 100 + 1$). Because of the way byte addresses are defined, 16 bits are required to cover all possible byte addresses in the 32k-word Logical address space (memory goes to 4M bytes). Hence, for byte addressing, bit 15 does not indicate indirect addressing. Memory references to byte addresses on base page (4-3777) with CDS mode enabled will have $2 * Q$ (byte base register) added to the base relative address.

Byte addresses 000 through 003 reference bytes in the A- and B-registers. These addresses will not cause memory violations. The user should, however, be careful in referencing these byte addresses; for example, storing into byte address 002 or 003 would destroy the byte address originally contained in the B-register.

NOTE

Instructions that store an interrupt count into the code sequence on interrupt (CBT, MBT, CMW, and MVW), have undefined results if executed with CDS mode enabled.

CBT																COMPARE BYTES															
15	14	13	12	11	10	9	8	7	6	5	4	3	2	1	0	15	14	13	12	11	10	9	8	7	6	5	4	3	2	1	0
1	0	0	0	1	0	1	1	1	1	1	1	0	1	1	0	1	0	0	0	1	0	1	1	1	1	0	1	1	0		
D ₁																															
0	0	0	0	0	0	0	0	0	0	0	0	0	0	0	0	0	0	0	0	0	0	0	0	0	0	0	0	0	0	0	
Return if array 1 = array 2																															
Return if array 1 < array 2																															
Return if array 1 > array 2																															

Compares the bytes in string 1 with those in string 2. This is a three-word instruction where

- Word 1 = Instruction code,
- Word 2 = Address of word containing the string count, and
- Word 3 = All-zeros word reserved for use by microcode.

The operand addresses are in the A- and B-registers. The A-register contains the first byte address of string 1 and the B-register contains the first byte address of string 2.

The number of bytes to be compared is given in the memory location addressed by Word 2 of the instruction; the number of bytes to be compared is restricted to a positive integer greater than zero. The strings are compared one byte at a time; the *i*th byte in string 1 is compared with the *i*th byte in string 2. The comparison is performed arithmetically; i.e., each byte is treated as a positive number. If all bytes in string 1 are identical with all bytes in string 2, the "equal" exit is taken. As soon as two bytes are compared and found to be different, the "less than" or "greater than" exit is taken, depending on whether the byte in string 1 is less than or greater than the byte in string 2. The three ways this instruction exits are as follows:

- a. No skip if string 1 is equal to string 2; the P-register advances one count from Word 3 of the instruction. The A-register contains its original value incremented by the count stored in the address specified in Word 2.
- b. Skips one word if string 1 is less than string 2; the P-register advances two counts from Word 3 of the instruction. The A-register contains the address of the byte in string 1 where the comparison stopped.
- c. Skips two words if string 1 is greater than string 2; the P-register advances three counts from Word 3 of the instruction. The A-register contains the address of the byte in string 1 where the comparison stopped.

For all three exits, the B-register will contain its original value incremented by the count stored in the address specified in Word 2. This instruction is interruptible. The interrupt routine is expected to save and restore the

contents of the A- and B-registers. During the interrupt, the remaining count is stored in Word 3 of the instruction. This instruction has undefined results if executed with CDS mode enabled.

LBT																LOAD BYTE															
15	14	13	12	11	10	9	8	7	6	5	4	3	2	1	0	15	14	13	12	11	10	9	8	7	6	5	4	3	2	1	0
1	0	0	0	1	0	1	1	1	1	1	1	0	1	1	0	1	0	0	0	1	0	1	1	1	1	1	0	0	1	1	
D ₁																															
0	0	0	0	0	0	0	0	0	0	0	0	0	0	0	0	0	0	0	0	0	0	0	0	0	0	0	0	0	0	0	

This one word instruction loads into the A-register the byte whose address is contained in the B-register. The byte is right-justified with leading zeros in the left byte. The B-register is incremented by one.

MBT																MOVE BYTES															
15	14	13	12	11	10	9	8	7	6	5	4	3	2	1	0	15	14	13	12	11	10	9	8	7	6	5	4	3	2	1	0
1	0	0	0	1	0	1	1	1	1	1	1	0	1	0	1	1	0	0	0	1	0	1	1	1	1	1	0	1	0	1	
D ₁																															
0	0	0	0	0	0	0	0	0	0	0	0	0	0	0	0	0	0	0	0	0	0	0	0	0	0	0	0	0	0	0	

Moves bytes in a left-to-right manner; i.e., the byte having the lowest address from the source is moved first. This is a three word instruction where

- Word 1 = Instruction code,
- Word 2 = Address of word containing the byte count, and
- Word 3 = All-zeros word reserved for use by microcode.

The operand addresses are in the A- and B-registers. The A-register contains the first byte address source and the B-register contains the first byte address destination.

The number of bytes to be moved is given by a 16-bit positive integer greater than zero addressed by Word 2 of the instruction. The byte address in the A- and B-registers are incremented as each byte is being moved. Thus, at the end of the operation, the A- and B-registers are incremented by the number of bytes moved. Wraparound of the byte address would result from a carry out of bit position 15; therefore, if the destination became 000, 001, 002, or 003, the next byte would be moved into the A- or B-register and destroy the proper byte addresses for the move operation. For each byte move, a memory protect check is performed.

This instruction is interruptible. The interrupt routine is expected to save and restore the contents of the A- and B-registers. During the interrupt, the remaining count is stored in Word 3 of the instruction. This instruction has undefined results if executed with CDS mode enabled.

SBT								STORE BYTE							
15	14	13	12	11	10	9	8	7	6	5	4	3	2	1	0
1	0	0	0	1	0	1	1	1	1	1	1	0	1	0	0

Stores the A-register low-order (right) byte in the byte address contained in the B-register. The B-register is incremented by one. A memory protect check is performed before the byte is stored. The left byte in the A-register does not have to be zeros. The other byte in the same word of the stored byte is not altered.

SFB								SCAN FOR BYTE							
15	14	13	12	11	10	9	8	7	6	5	4	3	2	1	0
1	0	0	0	1	0	1	1	1	1	1	1	0	1	1	1

This is a one word instruction with the operands in the A- and B-registers. The A-register contains a termination byte (high-order byte) and a test byte (low-order byte). The B-register contains the first byte address of the string to be scanned.

A string of bytes is scanned starting at the byte address given in the B-register. Scanning terminates when a byte in the string matches either the test byte or the termination byte in the A-register. The manner in which the instruction exits depends on which byte is matched first. If a byte in the string matches the test byte, the instruction will not skip upon exit; the B-register will contain the address of the byte matching the test byte. If a byte in the string matches the termination byte, the instruction will skip one word upon exit; the B-register will contain the address of the byte matching the termination byte *plus one*.

The scanning operation will not continue indefinitely even if neither the termination byte nor test byte exists in memory. These bytes are in the A-register with byte addresses 000 and 001, respectively. Thus, if no match is made by the time the B-register points to the last byte in memory, the B-register will roll over to zero and the next test will match the termination byte in the A-register with itself.

This instruction is interruptible. The interrupt routine is expected to save and restore the contents of the A- and B-registers.

3-32. BIT MANIPULATION INSTRUCTIONS. The following three instructions allow any number of bits in a specified memory location to be cleared, set, or tested.

CBS								CLEAR BITS							
15	14	13	12	11	10	9	8	7	6	5	4	3	2	1	0
1	0	0	0	1	0	1	1	1	1	1	1	1	1	0	0
D ₁															
D ₁															

Memory Address

Clears bits in the addressed location. This is a three-word instruction where

- Word 1 = Instruction code,
- Word 2 = Address of a 16-bit mask, and
- Word 3 = Address of word where bits are to be cleared.

The bits to be cleared correspond to logic 1's in the mask. The bits corresponding to logic 0's in the mask are not affected. A memory protect check is performed prior to modifying the word in memory.

SBS								SET BITS							
15	14	13	12	11	10	9	8	7	6	5	4	3	2	1	0
1	0	0	0	1	0	1	1	1	1	1	1	1	0	1	1
D ₁															
D ₁															

Memory Address

Sets bits in the addressed location. This is a three-word instruction where

- Word 1 = Instruction code,
- Word 2 = Address of a 16-bit mask, and
- Word 3 = Address of word where bits are to be set.

The bits to be set correspond to logic 1's in the mask. The bits corresponding to logic 0's in the mask are not affected. A memory protect check is performed prior to modifying the word in memory.

TBS								TEST BITS							
15	14	13	12	11	10	9	8	7	6	5	4	3	2	1	0
1	0	0	0	1	0	1	1	1	1	1	1	1	1	0	1
D ₁															
D ₁															

Memory Address

Tests (compares) bits in the addressed location. This is a three-word instruction where

- Word 1 = Instruction code,
- Word 2 = Address of a 16-bit mask, and

Word 3 = Address of word in which bits are to be tested.

The bits in the addressed memory word corresponding to logic 1's in the mask are tested. If all the bits tested are 1's, the instruction will not skip; otherwise the instruction will skip one word (i.e., the P-register will advance two counts from Word 3 of the instruction).

3-33. WORD MANIPULATION INSTRUCTIONS.

The following instructions facilitate the comparing and moving of word arrays.

CMW																COMPARE WORDS															
15	14	13	12	11	10	9	8	7	6	5	4	3	2	1	0	15	14	13	12	11	10	9	8	7	6	5	4	3	2	1	0
1	0	0	0	1	0	1	1	1	1	1	1	1	1	1	0	1	0	0	0	1	0	1	1	1	1	1	1	1	1	0	
0	0	0	0	0	0	0	0	0	0	0	0	0	0	0	0	0	0	0	0	0	0	0	0	0	0	0	0	0	0	0	
Return if array 1 = array 2																Return if array 1 < array 2															
Return if array 1 > array 2																															

Compares the words in array 1 with those in array 2. This is a three-word instruction where

- Word 1 = Instruction code,
- Word 2 = Address of word containing the word count, and
- Word 3 = All-zeros word reserved for use by microcode.

The operand addresses are in the A- and B-registers. The A-register contains the first word address of array 1 and the B-register contains the first word address of array 2. Bit 15 of the addresses in the A- and B-registers are ignored; i.e., no indirect addressing allowed.

The number of words to be compared is given in the memory location addressed by Word 2 of the instruction; the number of words to be compared is restricted to a positive integer greater than zero. The arrays are compared one word at a time; the *i*th word in array 1 is compared with the *i*th word in array 2. This comparison is performed arithmetically; i.e., each word is considered a two's complement number. If all words in array 1 are equal to all words in array 2, the "equal" exit is taken. As soon as two words are compared and found to be different, the "less than" or "greater than" exit is taken, depending on whether the word in array 1 is less than or greater than the word in array 2. The three ways this instruction exits are as follows:

- a. No skip if array 1 is equal to array 2; the P-register advances one count from Word 3 of the instruction. The A-register contains its original value incremented by the word count stored in the address specified in Word 2.

- b. Skips one word if array 1 is less than array 2; the P-register advances two counts from Word 3 of the instruction. The A-register contains the address of the word in array 1 where the comparison stopped.
- c. Skips two words if array 1 is greater than array 2; the P-register advances three counts from Word 3 of the instruction. The A-register contains the address of the word in array 1 where the comparison stopped.

For all three exits, the B-register will contain its original value incremented by the word count stored in the address specified in Word 2. This instruction is interruptible. The interrupt routine is expected to save and restore the contents of the A- and B-registers. During the interrupt, the remaining count is stored in Word 3 of the instruction. This instruction has undefined results if executed with CDS mode enabled.

MVW																MOVE WORDS															
15	14	13	12	11	10	9	8	7	6	5	4	3	2	1	0	15	14	13	12	11	10	9	8	7	6	5	4	3	2	1	0
1	0	0	0	1	0	1	1	1	1	1	1	1	1	1	1	1	0	0	0	1	0	1	1	1	1	1	1	1	1	1	
0	0	0	0	0	0	0	0	0	0	0	0	0	0	0	0	0	0	0	0	0	0	0	0	0	0	0	0	0	0	0	

Moves words in a left-to-right manner; i.e., the word having the lowest address in the source is moved first. This is a three-word instruction where

- Word 1 = Instruction code,
- Word 2 = Address of word containing the count, and
- Word 3 = All-zeros word reserved for use by microcode.

The operand addresses are in the A- and B-registers. The A-register contains the first word address source and the B-register contains the first word address destination. The number of words to be moved is a 16-bit positive integer greater than zero addressed by Word 2 of the instruction. The word addresses in the A- and B-registers are incremented as each word is being moved. Thus, at the end of the operation, the A- and B-registers are incremented by the number of words moved.

Wraparound of the word address would result from a carry into bit position 15 (i.e., at 32767). If the destination address became 000 or 001, the next word would be moved into the A- or B-register and destroy the proper word addresses for the move operation. For each word move, a memory protect check is performed.

This instruction is interruptible. The interrupt routine is expected to save and restore the contents of the A- and B-registers. During the interrupt, the remaining count is stored in Word 3 of the instruction. This instruction has undefined results if executed with CDS mode enabled.

3-34. FLOATING POINT INSTRUCTIONS

The floating point instructions allow addition, subtraction, multiplication, and division of single precision floating point quantities, and conversion of quantities from floating point format to integer format or vice versa. The A600+ has additional instructions to convert single precision floating point quantities to double integer and vice versa. Data formats are shown in Figure 3-1. Except for zero, all floating point operands must be normalized (i.e., sign of mantissa differs from most significant bit of mantissa).

The execution times of the floating point instructions are specified in under paragraph 3-40. These instructions are noninterruptible except during indirect address resolution; any attempted interrupt is held off for the full execution time of the currently active floating point instruction. However, DMA operation is not held off.

3-35. SINGLE PRECISION OPERATIONS. Overflow for single precision operations occurs if the result lies outside the range of representable single precision floating point numbers $[-2^{127}, (1-2^{-23})2^{127}]$. In such a case, the overflow flag is set and the result $(1-2^{-23})2^{127}$ is returned to the A- and B-registers. Underflow occurs if the result lies inside the range $[-2^{-129}, 1+2^{-22}]$. In such a case, the overflow flag is set and the result 0 is returned to the A- and B-registers.

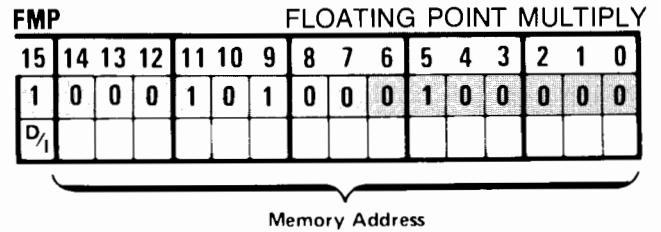

Multiplies the floating point quantity in the A- and B-registers by the floating point quantity in the specified memory locations. The floating point result is returned to the A- and B-registers.

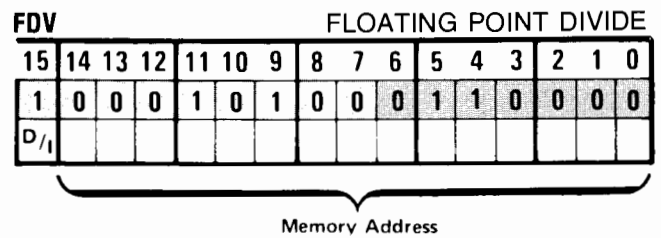

Divides the floating point quantity in the A- and B-registers by the floating point quantity in the specified memory locations. The floating point result is returned by the A- and B-registers.

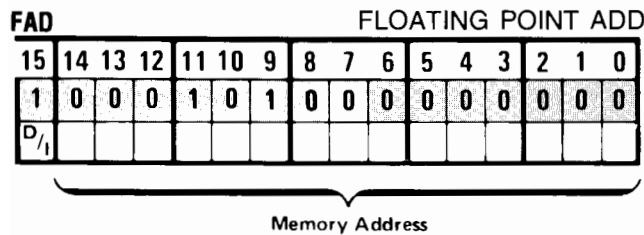

Adds the floating point quantity in the A- and B-registers to the floating point quantity in the specified memory locations. The floating point result is returned to the A- and B-registers.

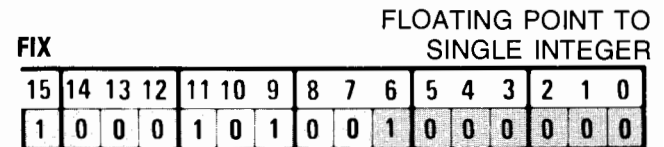

Converts the floating point quantity in the A- and B-registers to single integer format. The integer result is returned to the A-register. If the magnitude of the floating point number is < 1 , regardless of sign, the integer 0 is returned. If the magnitude of the exponent of the floating point number is ≥ 16 , regardless of sign, the integer 32767 (077777 octal) is returned as the result and the overflow flag is set.

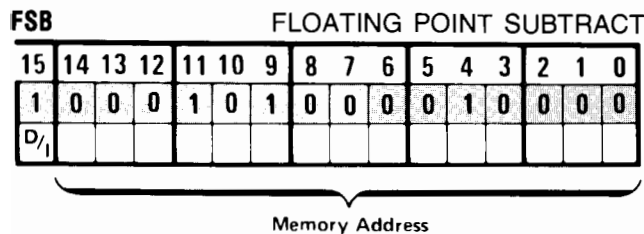

Subtracts the floating point quantity in the specified memory locations from the floating point quantity in the A- and B-registers. The floating point result is returned to the A- and B-registers.

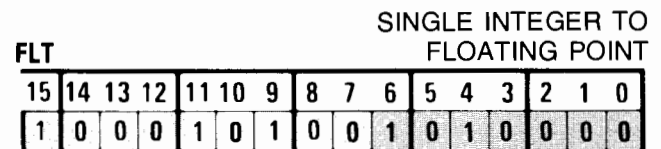

Converts the single integer quantity in the A-register to single precision floating point format. The floating point result is returned to the A- and B-registers.

.FIXD* FLOATING POINT TO DOUBLE INTEGER
(A600+ only)

15	14	13	12	11	10	9	8	7	6	5	4	3	2	1	0
1	0	0	0	1	0	1	0	0	1	0	0	0	1	0	0

Converts the floating point quantity in the A- and B-registers to double integer format. The integer result is returned to the A- and B-registers. (The A-register contains the most-significant word and the B-register contains the least-significant word.) If the magnitude of the floating point number is <1, regardless of sign, the integer 0 is returned. If the magnitude of the floating point number is ≥32, regardless of sign, the integer 2²³-1 is returned as the result and the overflow flag is set.

.FLTD* DOUBLE INTEGER TO FLOATING POINT
(A600+ only)

15	14	13	12	11	10	9	8	7	6	5	4	3	2	1	0
1	0	0	0	1	0	1	0	0	1	0	1	0	1	0	0

Converts the double integer quantity in the A- and B-registers to single precision floating point format. The floating point result is returned to the A- and B-registers.

3-36. LANGUAGE INSTRUCTION SET

The The Language Instruction Set consists of fourteen (seventeen for A600+) instructions that perform certain frequently used high-level language operations including parameter passing, array address calculations, and floating point conversion, packing, rounding and normalization operations.

For multiple-word instructions, indirect addressing to any number of levels is permitted for the word(s) indicated as a memory address. A logic 0 in bit position 15 specifies direct addressing; a logic 1 specifies indirect addressing.

The following paragraphs provide machine language coding and definitions for the Language Instruction Set. Data formats are shown in Figure 3-1. For a more detailed description of instructions in the Language Instruction Set, refer to the Relocatable Library Reference Manual, HP part no. 92077-90037.

.ZFER* TRANSFER EIGHT WORDS

15	14	13	12	11	10	9	8	7	6	5	4	3	2	1	0
1	0	0	0	1	0	1	0	1	0	0	1	1	1	1	1
D ₁															
D ₁															

Memory Address

Transfers eight consecutive words from one memory location to another. The source address + 8 is returned to the

A-register; the destination address +8 is returned to the B-register. This is a three word instruction where:

- Word 1 = Instruction code.
- Word 2 = Destination address.
- Word 3 = Source address.

Wraparound of either address produces undefined results. Under CDS, the source and/or destination addresses may be adjusted for base relativity.

.CFER* TRANSFER COMPLEX OR DOUBLE FLOATING POINT

15	14	13	12	11	10	9	8	7	6	5	4	3	2	1	0
1	0	0	0	1	0	1	0	1	0	0	1	1	0	0	1
D ₁															
D ₁															

Memory Address

Transfers a double precision floating point quantity (four consecutive words) from one memory location to another. The source address +4 is returned to the A-register; the destination address +4 is returned to the B-register. This is a three word instruction where:

- Word 1 = Instruction code.
- Word 2 = Destination address.
- Word 3 = Source address.

Wraparound of either address produces undefined results. Under CDS, the source and/or destination addresses may be adjusted for base relativity.

.DFER* TRANSFER THREE CONSECUTIVE WORDS

15	14	13	12	11	10	9	8	7	6	5	4	3	2	1	0
1	0	0	0	1	0	1	0	1	0	0	0	0	1	0	1
D ₁															
D ₁															

Memory Address

Transfers three consecutive words from one memory location to another. The source address +3 is returned to the A-register; the destination address +3 is returned to the B-register. This is a three word instruction where:

- Word 1 = Instruction code.
- Word 2 = Destination address.
- Word 3 = Source address.

Wraparound of either address produces undefined results. Under CDS, the source and/or destination addresses may be adjusted for base relativity.

.ENTP* TRANSFER PARAMETER ADDRESSES

15	14	13	12	11	10	9	8	7	6	5	4	3	2	1	0
1	0	0	0	1	0	1	0	1	0	0	1	0	1	0	0

Transfers the true addresses of parameters from a calling sequence into a subroutine; adjusts return address to the true return point. There must be exactly two words between the subroutine entry point and the .ENTP instruction. A true address is determined by eliminating all indirect references. The true return address is returned to the A-register. Used for privileged or re-entrant subroutines. This instruction has undefined results if executed with CDS mode enabled.

.ENTR* TRANSFER PARAMETER ADDRESSES

15	14	13	12	11	10	9	8	7	6	5	4	3	2	1	0
1	0	0	0	1	0	1	0	1	0	0	1	0	0	1	1

Transfers the true addresses of parameters from a calling sequence into a subroutine; adjusts return address to the true return point. A true address is determined by eliminating all indirect references. No more than three levels of indirect addressing are allowed per parameter. This instruction has undefined results if executed with CDS mode enabled.

.XFER* TRANSFER THREE CONSECUTIVE WORDS

15	14	13	12	11	10	9	8	7	6	5	4	3	2	1	0
1	0	0	0	1	0	1	0	1	0	0	1	0	0	0	0

Transfers three consecutive words from one memory location to another. The A-register must contain the source address and the B-register must contain the destination address. The source address +3 is returned to the A-register; the destination address +3 is returned to the B-register. Wraparound of either address produces undefined results. Under CDS, the source and/or destination addresses may be adjusted for base relativity.

.SETP* SET A TABLE

15	14	13	12	11	10	9	8	7	6	5	4	3	2	1	0
1	0	0	0	1	0	1	0	1	0	0	0	0	1	1	1
0	Count ≥ 0														

Sets a table of increasing numbers in consecutive memory locations. The A-register must contain the initial number and the B-register must contain the initial memory address (direct only); the contents of the succeeding memory location must define the number of memory locations

*For HP Assembly Language usage, refer to paragraph 3-41.

(count ≥ 0). Entries in the table are established by incrementing the initial address and number by one (1) for each successive entry until the last number, initial number, the initial address+COUNT and the A-register equals the initial value+COUNT. Wraparound will produce undefined results. This instruction is interruptible. On return the B-register equals the initial address +COUNT. Under CDS, the memory addresses may be adjusted for base relativity.

NOTE

If the initial address +COUNT -1 results in an address which is beyond the end of logical memory, addresses within the base page are destroyed.

..FCM* COMPLEMENT AND NORMALIZE SINGLE FLOATING POINT

15	14	13	12	11	10	9	8	7	6	5	4	3	2	1	0
1	0	0	0	1	0	1	0	1	0	0	1	1	0	1	0

Complements and normalizes in place a packed single precision floating point quantity located in the A- and B-registers. The result is returned to the A- and B-registers.

.BLE* SINGLE FLOATING POINT TO DOUBLE FLOATING POINT (A600+ only)

15	14	13	12	11	10	9	8	7	6	5	4	3	2	1	0
1	0	0	0	1	0	1	0	1	0	0	0	0	1	1	1
D ₁															
D ₁															
D ₁															

Memory Address

Converts the single precision floating point quantity in specified memory locations to a double-precision floating point quantity. The result is returned to other specified memory locations. This is a four-word instruction where:

- Word 1 = Instruction code.
- Word 2 = Return address.
- Word 3 = Address of result.
- Word 4 = Address of operand.

.FLUN* UNPACK FLOATING POINT QUANTITY

15	14	13	12	11	10	9	8	7	6	5	4	3	2	1	0
1	0	0	0	1	0	1	0	1	0	0	1	0	1	1	0

Unpacks a floating point quantity. The lower part of the floating point quantity must be in the B-register. The exponent is returned to the A-register, the lower part of the mantissa is returned to the B-register.

.NGL* DOUBLE FLOATING POINT TO SINGLE FLOATING POINT
(A600+ only)

15	14	13	12	11	10	9	8	7	6	5	4	3	2	1	0
1	0	0	0	1	0	1	0	1	0	0	0	1	1	0	0
D ₁															
D ₁															

Memory Address

Converts the double precision floating point quantity in the specified memory locations to a single precision floating point quantity. The result is placed in the A- and B-registers. Overflow is cleared unless, during execution, rounding results in overflow or underflow of the exponent, in which case overflow is set and the result is truncated to the greatest positive number. This is a three word instruction where:

- Word 1 = Instruction code.
- Word 2 = Return address.
- Word 3 = Address of operand.

.PACK* NORMALIZE FLOATING POINT QUANTITY

15	14	13	12	11	10	9	8	7	6	5	4	3	2	1	0
1	0	0	0	1	0	1	0	1	0	0	1	1	0	0	0

Converts the signed mantissa of a floating point quantity into a normalized format. The floating point quantity must be in the A- and B-registers. The succeeding instruction must reserve one word of memory for temporary storage of the exponent. The first word of the two word floating point result is returned to the A-register; the second word, to the B-register.

.PWR2* X TIMES 2 TO THE POWER N

15	14	13	12	11	10	9	8	7	6	5	4	3	2	1	0
1	0	0	0	1	0	1	0	1	0	0	1	0	1	0	1

Calculates for floating point x and integer n: $y = x \cdot 2^n$. The floating point quantity must be in the A- and B-registers; the succeeding instruction must define integer n. The first word of the two word floating point result is returned to the A-register; the second word, to the B-register.

..TCM* NEGATE DOUBLE FLOATING POINT
(A600+ only)

15	14	13	12	11	10	9	8	7	6	5	4	3	2	1	0
1	0	0	0	1	0	1	0	1	0	0	1	1	0	1	1
D ₁															

Memory Address

Negates a packed double precision floating point quantity located in the specified memory locations. The result is returned to the same specified memory locations.

.ENTN TRANSFER PARAMETER ADDRESSES

15	14	13	12	11	10	9	8	7	6	5	4	3	2	1	0
1	0	0	0	1	0	1	0	1	0	0	1	1	1	0	0

Transfers the true addresses of parameters from a calling sequence into a subroutine; adjusts return address to the true return point. The return address stored in the SUB entry point references the word following the last parameter DEF in the calling routine. A true address is determined by eliminating all indirect references. This instruction has undefined results if executed with CDS mode enabled.

.ENTC TRANSFER PARAMETER ADDRESSES

15	14	13	12	11	10	9	8	7	6	5	4	3	2	1	0
1	0	0	0	1	0	1	0	1	0	0	1	1	1	0	1

Transfers the true addresses of parameters from a calling sequence into a subroutine; adjusts return address to the true return point. The return address stored in the SUB entry point references the word following the last parameter DEF in the calling routine. There must be exactly two words between the subroutine entry point and the .ENTC instruction. A true address is determined by eliminating all indirect references. The true return address is returned to the A-register. Used for privileged or re-entrant subroutines. This instruction has undefined results if executed with CDS mode enabled.

.CPM* SINGLE INTEGER ARITHMETIC COMPARE

15	14	13	12	11	10	9	8	7	6	5	4	3	2	1	0
1	0	0	0	1	0	1	0	1	0	0	1	1	1	1	0
D ₁															
D ₁															
Return if operand 1 = operand 2															
Return if operand 1 < operand 2															
Return if operand 1 > operand 2															

Arithmetically compares operands addressed by second and third word. Does not skip if operands are equal; however, skips one instruction if the first operand is less than the second, or skips two instructions if the first operand is greater than the second.

3-37. DOUBLE INTEGER INSTRUCTIONS

The double integer instructions allow arithmetic and test operations on 32-bit integer quantities. The data format for double integer values is shown in Figure 3-1. Double integer values contained in the (A,B) registers have the most significant bits in the A-register. Values stored in

*For HP Assembly Language usage, refer to paragraph 3-41.

memory require two locations. The operand address in a double integer instruction points to the first memory location, which contains the most significant bits. Double integer instructions clear the overflow register upon entry, and will set the O-register if an overflow occurs. The E-register is never cleared by a double integer instruction.

.DAD* DOUBLE INTEGER ADD

15	14	13	12	11	10	9	8	7	6	5	4	3	2	1	0
1	0	0	0	1	0	1	0	0	0	0	0	1	1	0	0
O/I															

Memory Address

Performs the double integer operation:

$$(A,B) = (A,B) + \langle OPND \rangle$$

The contents of <OPND> are unaltered. In the event of overflow, the overflow bit is set and the returned result contains the lower 32-bits of the actual sum, in unsigned form. The extend bit will be set if an unsigned carry out of the A-register occurs.

.DSB* DOUBLE INTEGER SUBTRACT

15	14	13	12	11	10	9	8	7	6	5	4	3	2	1	0
1	0	0	0	1	0	1	0	0	0	0	1	1	1	0	0
O/I															

Memory Address

Performs the double integer operation:

$$(A,B) = (A,B) - \langle OPND \rangle$$

The contents of <OPND> are unaltered. In the event of overflow, the overflow bit is set and the returned result contains the lower 32-bits of the actual difference, in unsigned form. The extend bit will be set if an unsigned borrow out of the A-register occurs.

.DSBR* DOUBLE INTEGER SUBTRACT REVERSE

15	14	13	12	11	10	9	8	7	6	5	4	3	2	1	0
1	0	0	0	1	0	1	0	0	1	0	0	1	1	0	0
O/I															

Memory Address

Performs the double integer operation:

$$(A,B) = \langle OPND \rangle - (A,B)$$

The contents of <OPND> are unaltered. In the event of overflow, the overflow bit is set and the returned result contains the lower 32-bits of the actual difference, in unsigned form. The extend bit will be set if an unsigned borrow occurs.

DOUBLE INTEGER DECREMENT AND SKIP IF ZERO

.DDS*

15	14	13	12	11	10	9	8	7	6	5	4	3	2	1	0
1	0	0	0	1	0	1	0	1	0	0	0	1	0	1	1
O/I															

Memory Address

Performs the double integer operation:

$$\langle OPND \rangle = \langle OPND \rangle - 1$$



If the new value of <OPND> equals zero, the next instruction will be skipped. The value in <OPND> is treated as an unsigned number, and a borrow out of the <OPND> is ignored.

.DNG DOUBLE INTEGER NEGATE

15	14	13	12	11	10	9	8	7	6	5	4	3	2	1	0
1	0	0	0	1	0	1	0	1	0	0	0	0	0	1	1
O/I															

Performs the double integer operation:

$$(A,B) = - (A,B)$$

An input value of (100000, 000000) is left unchanged and overflow is set. An input value of zero will cause the extend bit to be set.

.DCO DOUBLE INTEGER COMPARE

15	14	13	12	11	10	9	8	7	6	5	4	3	2	1	0
1	0	0	0	1	0	1	0	1	0	0	0	0	1	0	0
O/I															

Memory Address

Compares the double integers (A,B) and <OPND>

- If (A,B) = <OPND> Return to P+2
- If (A,B) < <OPND> Return to P+3
- If (A,B) > <OPND> Return to P+4

where P is the address of the .DCO instruction. The value of both double integers and the overflow bit are unaltered.

.DIN DOUBLE INTEGER INCREMENT

15	14	13	12	11	10	9	8	7	6	5	4	3	2	1	0
1	0	0	0	1	0	1	0	1	0	0	0	1	0	0	0
O/I															

Performs the double integer operation:

$$(A,B) = (A,B) + 1$$

An input value of (077777, 177777) will return a result of (100000, 000000) and set overflow. An input value of (177777, 177777) will return a result of zero and cause the extend bit to be set.

*For HP Assembly Language usage, refer to paragraph 3-41.

.DDE DOUBLE INTEGER DECREMENT

15	14	13	12	11	10	9	8	7	6	5	4	3	2	1	0
1	0	0	0	1	0	1	0	1	0	0	0	1	0	0	1

Performs the double integer operation:

$$(A,B) = (A,B) - 1$$

An input value of (100000,000000) will return the result (077777, 177777) and set overflow. An input value of zero will return the result (177777, 177777) and cause the extend bit to be set.

.DIS DOUBLE INTEGER INCREMENT AND SKIP IF ZERO

15	14	13	12	11	10	9	8	7	6	5	4	3	2	1	0
1	0	0	0	1	0	1	0	1	0	0	0	1	0	1	0
D _i															

Memory Address

Performs the double integer operation:

$$\langle OPND \rangle \omega \langle OPND \rangle \zeta 1$$

If the new value of <OPND> equals zero, the next instruction will be skipped. The value in <OPND> is treated as an unsigned number, and a carry out of the <OPND> is ignored.

.DDI* (A600+ only) DOUBLE INTEGER DIVIDE

15	14	13	12	11	10	9	8	7	6	5	4	3	2	1	0
1	0	0	0	1	0	1	0	0	0	1	1	1	1	0	0
D _i															

Memory Address

Performs the double integer operation:

$$(A,B) = (A,B) \div \langle OPND \rangle$$

The contents of <OPND> are unaltered. If overflow or divide by zero occurs, the result (077777, 177777) is returned and overflow is set.

.DDIR* (A600+ only) DOUBLE INTEGER DIVIDE REVERSE

15	14	13	12	11	10	9	8	7	6	5	4	3	2	1	0
1	0	0	0	1	0	1	0	0	1	0	1	1	1	0	0
D _i															

Memory Address

Performs the double integer operation:

$$(A,B) = \langle OPND \rangle \div (A,B)$$

The contents of <OPND> are unaltered. If overflow or divide by zero occurs, the result (077777, 177777) is returned and overflow is set.

.DMP* (A600+ only) DOUBLE INTEGER MULTIPLY

15	14	13	12	11	10	9	8	7	6	5	4	3	2	1	0
1	0	0	0	1	0	1	0	0	0	1	0	1	1	0	0
D _i															

Memory Address

Performs the double integer operation:

$$(A,B) = (A,B) \times \langle OPND \rangle$$

The contents of <OPND> are unaltered. If overflow occurs, the result (077777, 177777) is returned and overflow is set.

3-38. VIRTUAL MEMORY INSTRUCTIONS

The Virtual Memory Instructions perform accesses to virtual memory and the extended area, which are extensions of logical memory. If an addressed data item is in physical memory, the instructions perform the required mapping, including modification of map registers and entry of the appropriate page numbers into the user's logical address space. If an addressed data item is not in physical memory, a fault is generated to a macrocode routine which swaps the data from the disc into physical memory and then restarts the VMA instruction. The fault sequence generated depends on whether the CDS mode is enabled. If CDS mode is disabled, a JSB,I through memory location 04 in the user map is effected. Memory location 04 is expected to contain the address of the entry point of the VMA fault-handler in the user space (indirect addressing is not allowed). If CDS mode is enabled, an interrupt is generated to trap cell 12 octal in the system map. As the VMA fault interrupt is the lowest priority interrupt, any other pending interrupts will be serviced first.

NOTE

VMA always maps the page that the requested VMA address is on in addition to the next page, ensuring that entire data items up to 1k words in size are mapped-in. The exception to this is .PMAP, which only maps-in the requested page.

*For HP Assembly Language usage, refer to paragraph 3-41.

.PMAP*																MAP SPECIFIED PAGE															
15	14	13	12	11	10	9	8	7	6	5	4	3	2	1	0	15	14	13	12	11	10	9	8	7	6	5	4	3	2	1	0
1	0	0	0	1	0	1	0	1	0	1	0	0	0	0	0	1	0	0	0	1	0	1	0	1	0	0	0	0	0	0	
Error return																															
Normal return																															

On entry, the A-register is loaded with the number of the user-map register to be altered and the B-register is loaded with the page ID, which are the parameters passed to the routine. If an attempt is made to map in the last+1 page, that PMR is mapped read and write protected. When no error occurs, a normal return occurs to the second word after the instruction; mapping is complete; and the contents of the A- and B-registers are incremented. If a fault occurs and the sign bit is set in the A-register, an error return to the word that follows the instruction occurs. If a fault occurs, and the sign bit is not set in the A-register, a normal fault sequence is generated. The O-register is undefined. The E-register is set if an attempt was made to map the last+1 page; otherwise it is cleared.

The .PMAP instruction uses the last user page (31) of memory and then maps that logical page read and write protected. After a .PMAP call, memory references to address >75777 octal will cause memory protect violations.

.IMAP*																16-BIT SUBSCRIPT MAPPING															
15	14	13	12	11	10	9	8	7	6	5	4	3	2	1	0	15	14	13	12	11	10	9	8	7	6	5	4	3	2	1	0
1	0	0	0	1	0	1	0	1	0	1	0	1	0	0	0	1	0	0	0	1	0	1	0	1	0	1	0	0	0	0	
D ₁																															
Word 2 = DEF dope vector																															
Word 3 = Subscript N																															
Word N+2 = Subscript 1																															

Performs a subscript calculation and maps the result into logical memory. Each of the subscripts and dimensions are 16-bit integers. However, the calculation uses 32-bit adds and multiplies. The subscripts are sign-extended to 32 bits. The subscript words cannot address the A- or B-register.

Word 2 points to a table that specifies in order the number of dimensions, dimension sizes, the number of words per element, and a two-word offset.

On a normal return, the A-register is undefined and the B-register contains the logical address.

.IRES*																16-BIT SUBSCRIPT RESOLUTION															
15	14	13	12	11	10	9	8	7	6	5	4	3	2	1	0	15	14	13	12	11	10	9	8	7	6	5	4	3	2	1	0
1	0	0	0	1	0	1	0	1	0	1	0	0	1	0	0	1	0	0	0	1	0	1	0	1	0	0	1	0	0	0	
Word 2 = DEF dope vector																															
Word 3 = Subscript N																															
Word N+2 = Subscript 1																															

Performs a subscript calculation. Each of the subscripts and dimensions are 16-bit integers. However, the calculation uses 32-bit adds and multiplies. The subscripts are sign-extended to 32 bits. The subscript words cannot address the A- or B-register.

Word 2 points to a table that specifies in order the number of dimensions, dimension sizes, the number of words per element, and a two-word offset.

On a normal return, the A- and B-registers contain the address of the array element in double-integer format (most significant word in the A-register).

.JMAP*																32-BIT SUBSCRIPT MAPPING															
(A600+ only)																15	14	13	12	11	10	9	8	7	6	5	4	3	2	1	0
																1	0	0	0	1	0	1	0	1	0	1	0	1	0	1	0
																D ₁															
Word 2 = DEF dope vector																															
Word 3 = Subscript N																															
Word N+2 = Subscript 1																															

Performs a subscript calculation and maps the result into logical memory. Each of the subscripts and dimensions are 32-bit integers, and the calculation uses 32-bit adds and multiplies. The subscript words cannot address the A- or B-register.

Word 2 points to a table that specifies the number of dimensions, dimension sizes, the number of words per element, and a two-word offset.

On a normal return, the A-register is undefined and the B-register contains the logical address.

.JRES*																32-BIT SUBSCRIPT RESOLUTION															
(A600+ only)																15	14	13	12	11	10	9	8	7	6	5	4	3	2	1	0
																1	0	0	0	1	0	1	0	1	0	1	0	0	1	0	1
																D ₁															
Word 2 = DEF dope vector																															
Word 3 = Subscript N																															
Word N+2 = Subscript 1																															

Performs a subscript calculation. Each of the subscripts and dimensions are 32-bit integers, and the calculation uses 32-bit adds and multiplies. The subscript words cannot address the A- or B-register.

Word 2 points to a table that specifies the number of dimensions, dimension sizes, the number of words per element, and a two-word offset.

*For HP Assembly Language usage, refer to paragraph 3-41.

On a normal return, the A- and B-registers contain the address of the array element in double-integer format (most significant word in the A-register).

.LPXR* INDEXED MAPPING WITH DEF

15	14	13	12	11	10	9	8	7	6	5	4	3	2	1	0
1	0	0	0	1	0	1	0	1	0	1	0	1	1	0	0
D ₁															
D ₁															

Memory Address

On entry, the pointer specified by the second instruction word is resolved, and the double word it points to is loaded into the A- and B-registers. The offset specified in the third instruction word is resolved, and the double word it points to is added to the contents of the A- and B-registers. The result is treated as a 26-bit VMA pointer and is mapped. On exit, the B-register contains the logical address of the data item, and the A-register is undefined. The offset word cannot refer to the A- or B-register.

.LPX* INDEXED MAPPING WITH REGISTERS

15	14	13	12	11	10	9	8	7	6	5	4	3	2	1	0
1	0	0	0	1	0	1	0	1	0	1	0	1	1	0	1
D ₁															

Memory Address

On entry, the second instruction word either directly or indirectly points to a double integer in memory, which is to be added to the double integer in the A- and B-registers to form a double-word VMA pointer. If bit 15 of the A-register is set, the B-register contains the address of a data item presently residing in logical memory and the .LPX instruction does nothing; otherwise, the data item is mapped. On exit, the B-register contains the logical address of the data item, and the A-register is undefined.

.LBPR* MAPPING WITH DEF

15	14	13	12	11	10	9	8	7	6	5	4	3	2	1	0
1	0	0	0	1	0	1	0	1	0	1	0	1	1	1	0
D ₁															

Memory Address

On entry, the pointer specified by the second instruction word is resolved and the double word it points to is loaded into the A- and B-registers. This value is treated as a 26-bit VMA pointer and is mapped. On exit, the B-register contains the logical address of the data item, and the A-register is undefined.

*For HP Assembly Language usage, refer to paragraph 3-41.

.LBP* MAPPING WITH REGISTERS

15	14	13	12	11	10	9	8	7	6	5	4	3	2	1	0
1	0	0	0	1	0	1	0	1	0	1	0	1	1	1	1

On entry, the 26-bit VMA pointer is contained in the A-register (most significant word) and B-register; if bit 15 of the A-register is set, the B-register contains the address of a data item presently residing in logical memory; otherwise, the data item is mapped. On exit, the B-register contains the logical address of the data item, and the A-register is undefined.

3-39. OPERATING SYSTEM INSTRUCTION SET

The operating system instructions provide instructions for ascertaining the CPU and firmware identification, and instructions for interrupt conditions.

.CPUID PROCESSOR IDENTIFICATION

15	14	13	12	11	10	9	8	7	6	5	4	3	2	1	0
1	0	0	0	1	0	1	0	1	1	0	0	0	0	0	0

The A-register is loaded with a number that identifies the type of processor installed in the computer system, where:

- Octal 2 = A600
- Octal 3 = A700
- Octal 4 = A900
- Octal 5 = A600+

.FWID* FIRMWARE IDENTIFICATION

15	14	13	12	11	10	9	8	7	6	5	4	3	2	1	0
1	0	0	0	1	0	1	0	1	1	0	0	0	0	0	1

On exit, the A-register contains a number that identifies the revision code of the firmware.

.WFI* WAIT FOR INTERRUPT

15	14	13	12	11	10	9	8	7	6	5	4	3	2	1	0
1	0	0	0	1	0	1	0	1	1	0	0	0	0	1	0

This instruction is equivalent to a JMP * except that the processor does not perform memory accesses, which would decrease the effective bandwidth of the memory backplane. This instruction is interruptible.

.SIP* SKIP IF INTERRUPT PENDING

15	14	13	12	11	10	9	8	7	6	5	4	3	2	1	0
1	0	0	0	1	0	1	0	1	1	0	0	0	0	1	1

The processor skips if an I/O interrupt is pending (INTRQ- is asserted on the A-series backplane), which is independent of the Level 2 and Level 3 interrupt masks.

3-40. EXECUTION TIMES

Table 3-5 lists the execution times required for the various base set instructions.

3-40A. DOUBLE-PRECISION FLOATING POINT INSTRUCTIONS (A600+ ONLY)

The double-precision floating point instructions are standard in the A600+ base set and provide for add, subtract, multiply and divide operations on a double-precision value, as well as instructions that convert double-precision floating point values to or from single and double integer fixed values.

Overflow for double precision operations occurs if the result lies outside the range of representable double precision floating point numbers $[-2^{127} \cdot (1-2^{-55})2^{-127}]$. In such a case, the overflow flag is set and $(1-2^{-55})2^{127}$ is returned as the result. Underflow occurs if the result lies inside the range $[-2^{-129}(1+2^{-54}), 2^{-129}]$. In such a case, the overflow flag is set and 0 is returned as the result.

.TADD* (A600+ only) DOUBLE FLOATING POINT ADD

15	14	13	12	11	10	9	8	7	6	5	4	3	2	1	0
1	0	0	0	1	0	1	0	0	0	0	0	0	0	1	0
D ₁															
D ₁															
D ₁															

Memory Address

Adds two double precision floating point quantities (augend plus addend). This is a four-word instruction where:

- Word 1 = Instruction code.
- Word 2 = Address of result.
- Word 3 = Address of augend.
- Word 4 = Address of addend.

.TDIV* (A600+ only) DOUBLE FLOATING POINT DIVIDE

15	14	13	12	11	10	9	8	7	6	5	4	3	2	1	0
1	0	0	0	1	0	1	0	0	0	1	1	0	0	1	0
D ₁															
D ₁															
D ₁															

Memory Address

Divides one double precision floating point quantity by another (dividend by divisor). This is a four-word instruction where:

- Word 1 = Instruction code.
- Word 2 = Address of result.
- Word 3 = Address of dividend.
- Word 4 = Address of divisor.

.TFTD* (A600+ only) DOUBLE INTEGER TO DOUBLE FLOATING POINT

15	14	13	12	11	10	9	8	7	6	5	4	3	2	1	0
1	0	0	0	1	0	1	0	0	1	0	1	0	1	1	0
D ₁															

Memory Address

Converts the double integer quantity in the A- and B-registers to double precision floating point format. The floating point result is returned to the specified memory locations.

.TFTS* (A600+ only) SINGLE INTEGER TO DOUBLE FLOATING POINT

15	14	13	12	11	10	9	8	7	6	5	4	3	2	1	0
1	0	0	0	1	0	1	0	0	1	0	1	0	0	1	0
D ₁															

Memory Address

Converts the single integer quantity in the A-register to double precision floating point format. The floating point result is returned to the specified memory locations.

.TFXD* (A600+ only) DOUBLE FLOATING POINT TO DOUBLE INTEGER

15	14	13	12	11	10	9	8	7	6	5	4	3	2	1	0
1	0	0	0	1	0	1	0	0	1	0	0	0	1	1	0
D ₁															

Memory Address

Converts the double precision floating point quantity in the specified memory locations to double integer format. The integer result is returned to the A- and B-registers. (The A-register contains the most-significant word and the B-register contains the least-significant word.) If the magnitude of the floating point number is < 1 , regardless of sign, 0 is returned as the result. If the magnitude of the exponent of the floating point number is ≥ 32 , regardless of sign, the integer $2^{31}-1$ is returned as the result and the overflow flag is set.

*For HP Assembly Language usage, refer to paragraph 3-41.

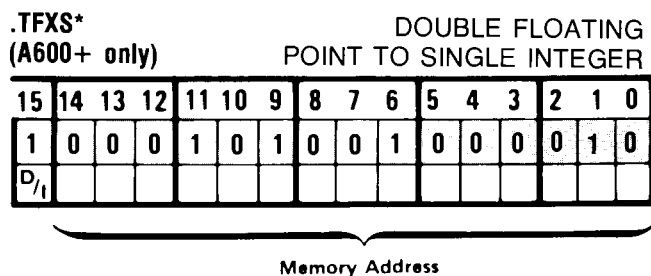

Converts the double precision floating point quantity in the specified memory locations to single integer format. The integer result is returned to the A-register. If the magnitude of the floating point number is <1, regardless of sign, 0 is returned as the result. If the magnitude of the exponent of the floating point number is ≥16, regardless of sign, the integer 2¹⁵ - 1 is returned as the result and the overflow flag is set.

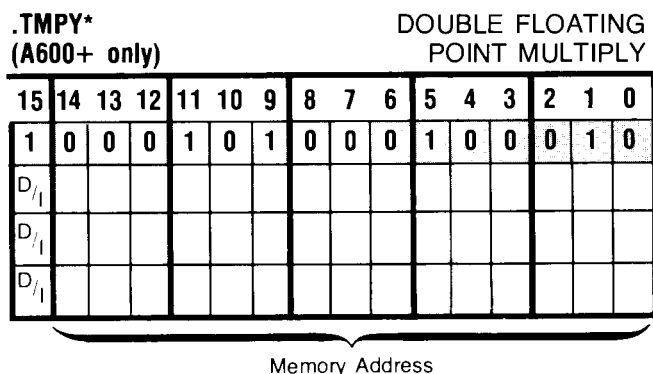

Multiplies one double precision floating point quantity by another (multiplicand by multiplier). This is a four-word instruction where:

- Word 1 = Instruction code.
- Word 2 = Address of result.
- Word 3 = Address of multiplicand.
- Word 4 = Address of multiplier.

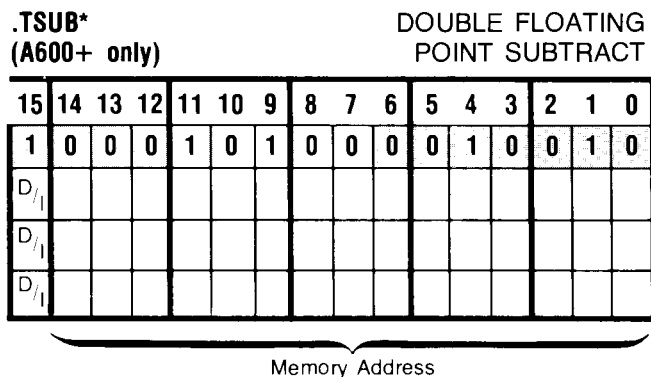

Subtracts one double precision floating point quantity from another (minuend minus subtrahend). This is a four-word instruction where:

- Word 1 = Instruction code.
- Word 2 = Address of result.
- Word 3 = Address of minuend.
- Word 4 = Address of subtrahend.

3-41. ASSEMBLY LANGUAGE

New instructions not recognized by the HP Macroassembler require different handling in HP Assembly Language programming. These instructions are asterisked in the preceding paragraphs and must be used in the form: JSB x where x is the instruction. (The instruction, x, must be declared as an external at the beginning of the assembly language program). Most of these instructions correspond to library subroutines** and must be implemented into HP RTE systems (as described in the following paragraph) to enable their execution in firmware instead of software.

3-42. RTE IMPLEMENTATION

New instructions are implemented in an RTE-A system by changing library entry points during the parameter input phase of system generation. (Refer to the appropriate RTE manual for the system generation procedures.) Using the list of entry point opcodes given in Table 3-6, make the entry changes as indicated below:

```
LPMR,RP,105700
SPMR,RP,105701
.
.
.
.ADQB,RP,105413
```

Alternatively, entry points may be changed by loading (via LINK) a "replacement" module when user programs are loaded. Opcode replacement modules RPL60 through RPL63 are included in the RTE-A system.

**Refer to the Relocatable Library Reference Manual, HP part no. 92077-90037.

*For HP Assembly Language usage, refer to paragraph 3-41.

Table 3-5. Typical Base Set Instruction Execution Times, A600/A600+

INSTRUCTION	EXECUTION TIME (μ sec)
Memory Reference Group	
(Direct)	
LDA/B, ADA/B, IOR, XOR, AND	0.908/0.908
STA/B, ISZ, JSB	1.362/1.362
CPA/B without skip	1.135/1.135
with skip	1.588/1.588
JMP	0.681/0.681
(Indirect)	
JSB,I	1.816/1.589
JMP,I	1.589/1.362
Each indirect address level except the first for JMP,I	0.454/0.454
Alter/Skip Group	
INA/B, SZA/B, SSA/B, SLA/B, SEZ, RSS, or any combination without skip	0.908/1.135 to 1.362
with skip	1.362/1.135 to 1.362
CCA/B/E, CLA/B/E, CMA/B/E, or any combination within group without skip	1.135/1.135 to 1.362
with skip	1.589/1.135 to 1.362
Shift/Rotate Group	
NOP, A/BLF, A/BRS, ELA/B, ERA/B, RAR, RBR, or any combination	1.135/1.135 to 2.270
with SLA and skip	1.816/1.135 to 2.270
with SLA and no skip	1.589/1.135 to 2.270
with SLA, CLE and skip	1.816/1.135 to 2.270
with SLA, CLE and no skip	1.589/1.135 to 2.270
A/BLR, A/BLS, CLE alone	1.362/1.135 to 2.270
combinations within subgroup	1.816/1.135 to 2.270
combinations with other subgroup	1.362 to 2.043/ 1.135 to 2.270
combinations with SLA, no skip	1.816 to 2.270
combinations with SLA, skip	1.135 to 2.270 2.043 to 2.497 1.135 to 2.270
Extended Arithmetic Group (A600 only)	
ASL with one shift	2.043 plus 0.454/shift
ASR with one shift	1.362 plus 0.227/shift
DIV	2.724 to 10.670
DLD	2.724
DST	2.497
JLA/B	2.043
LSL/R, RRL/R with one shift	1.135 plus 0.227/shift
MPY	5.902
LSR with one shift	1.135 plus 0.227/shift
RRR with one shift	1.135 plus 0.227/shift
(A600+ only)	
ASL with one shift	1.816
ASR with one shift	1.362
DIV	2.497 to 10.44
DLD	1.816
DST	2.043

Table 3-5. Typical Base Set Instruction Execution Times A600/A600+ (Continued)

INSTRUCTION	EXECUTION TIME* (μ sec)
(A600+ only) (Continued)	
JLA/B	1.362
LSL/R, RRL/R with one shift	1.135
MPY	5.498
LSR with one shift	1.135
RRR with one shift	1.589
Input/Output Group	
HLT	29.97/17.49
By select code	
SC0: CLF, STF	2.724/1.362
SFC, SFS without skip	2.951/1.589
with skip	3.178/1.589
LIA/B	10.90/6.356
OTA/B	7.945/4.944
CLC	2.951/1.362
SC1: CLF, STF	1.816/1.362
SFC, SFS without skip	2.043/1.362
with skip	2.270/1.362
LIA/B	2.270/1.675
OTA/B	1.816/2.275
SC2: STF, CLF	4.767/2.043
SFC, SFS without skip	2.951/1.589
with skip	3.228/1.589
LIA/B	10.90/6.356
OTA/B	7.945/4.767
STC	4.540/2.043
SC3: LIA/B	10.90/6.356
OTA/B	12.03/5.488
SC4: SFC, SFS without skip	2.951/1.362
with skip	3.178/1.362
LIA/B	3.632/1.362
OTA/B	4.086/1.362
CLC, STC	2.724/1.589
SC5: SFC, SFS without skip	2.951/1.589
with skip	3.228/1.589
STF, CLF	2.724/1.362
LIA/B	2.951/1.589
CLC, STC	2.497/1.362
SC6: SFC, SFS without skip	2.951/1.589
with skip	3.228/1.589
STF, CLF	2.497/1.362
STC	2.951/1.362
CLC	3.632/1.362
SC7: LIA/B, STC	2.497/1.362
SC20 and up:	
CLC, CLF, STC, STF	5.448/2.951
SFC, SFS without skip	5.448/2.951
with skip	7.040/4.086
LIA/B	8.170/5.902
MIA/B	8.390/5.902
OTA/B	7.260/4.994

Table 3-5. Typical Base Set Instruction Execution Times, A600/A600+ (Continued)

INSTRUCTION	EXECUTION TIME* (μsec)
Extended Instruction Group (Index Register Instructions)	
ADX/Y, LDX/Y	1.816/1.589, 1.362
CAX/Y, CBX/Y, CXA/B, CYA/B	0.908/0.908
DSX/Y, ISX/Y without skip	0.908/1.135
with skip	1.362/1.135
JLY, JPY	2.043/1.135
LAX/Y, LBX/Y, STX/Y	2.270/1.589
SAX/Y, SBX/Y	2.497/1.816
XAX/Y, XBX/Y	1.135/1.135
Each indirect address level	0.454/0.454
Bit/Byte/Word Manipulation Group (Bit Manipulation Instructions)	
CBS, SBS	3.859/2.724
TBS without skip	3.859/2.951
with skip	4.086/2.951
(Byte Manipulation Instructions)	
CBT	2.597/2.270
Each additional byte	4.313/3.589
LBT (even or odd byte address)	2.724/2.270 or 1.816
MBT	3.641/4.313-6.129
Each additional byte	3.859/0.454-1.022
SBT if even byte address	3.405/2.724
If odd byte address	2.951/2.270
SFB for compare exit	1.816/2.497
For terminal exit	2.043/2.724
Each added byte, either exit	2.270/1.135
(Word Manipulation Instructions)	
CMW	2.951/2.755
Each additional word	2.0433/1.135
MVW	2.951/2.270
Each additional word	1.135/0.908
Floating Point Group	
.FAD	7.0 to 27.7/8.8 to 17.7
.FDV	6.1 to 30.0/5.4 to 27.9
.FIX	2.5 to 10.2/2.4 to 6.3
.FLT	1.6 to 13.4/2.2 to 5.6
.FMP	16.6 to 26.6/17.0 to 21.1
.FSB	8.2 to 27.7/9.5 to 18.8
Dynamic Mapping Instruction Group	
	Refer to Section IV for detailed descriptions and execution times.
Double Integer Instruction Group (Typical Values)	
.DAD, .DSB, .DSBR	3.178/2.497
.DCO	4.086/2.497-2.951
.DDE, .DIN	1.135/1.135-1.589
.DDS, .DIS	4.313/3.859
.DNG	1.589/1.589
.DMP (A600+)	3.178-13.847

Table 3-5. Typical Base Set Instruction Execution Times, A600/A600+ (Continued)

INSTRUCTION	EXECUTION TIME* (μsec)
Double Integer Instruction Group (Continued) (Typical Values)	
.DDI (A600+)	3.632-16.344
.DDIR (A600+)	4.540-17.479
Virtual Memory Instructions†	
.IMAP	13.62/23.15
Additional per subscript	11.62/10.44
.IRES	3.859/13.39
Additional per subscript	11.12/10.44
.LBP	10.442/10.67
.LBPR, .LPX	12.935/11.80, 12.03
.LPXR	15.209/13.85
.PMAP	7.718/7.264
†Note: The times listed do not include access time to bring data in from the disc.	
Program Language Support Group	
.CFER	6.583/5.675
.CPM	2.951/2.951
.DFER	5.675/4.767
.ENTC	4.086/2.270
Additional per parameter‡	1.589/0.908
.ENTN, .ENTP	3.632/2.270, 2.951
Additional per parameter‡	1.589/0.908
.ENTR	3.405/2.724
Additional per parameter‡	1.589/0.908
..FCM	1.1 to 5.675/1.135 to 5.448
.SETP	1.816/2.924
Additional per table entry	0.681/0.454
.XFER	5.902/3.859
.ZFER	11.35/9.761
‡Assumes no indirect reference on parameter; add 0.454 for each indirect level.	
Operating System Instructions	
.CPUID, .FWID	0.908/0.908
.SIP without skip	0.908/0.908
with skip	1.362/1.362
.WFI	Until interrupt
Note: Actual times may vary from those listed above for several reasons. Memory refresh during a processor memory access can make an instruction approximately 3% slower. Heavy DMA activity can also degrade instruction times due to contention for memory.	

Table 3-5A. Typical and Maximum Execution Times of Selected Instructions

EXECUTION TIME (μ s)		
INSTRUCTION	TYPICAL	MAXIMUM
Single-Precision Floating Point		
	(A600/A600+)	(A600/A600+)
.FIXD	7.5/1.8	9.5/7.9
.FLTD	7.0/1.5	7.7/7.0
.FAD	NA/8.8	NA/17.7
.FSB	NA/9.5	NA/18.8
.FMP	NA/17.0	NA/21.1
.FDV	NA/5.4	NA/27.9
FLOAT	NA/2.2	NA/5.6
FIX	NA/2.4	NA/6.3
Double-Precision Floating Point (A600+ only)		
.TADD	11.3	27.9
.TDIV	12.9	65.1
.TFTD	5.2	9.9
.TFTS	4.5	8.8
.TFXD	4.3	9.7
.TFXS	4.0	8.6
.TMPY	11.3	64.0
.TSUB	12.9	29.5
Language Instruction Set		
	(A600/A600+)	(A600/A600+)
.BLE	6.4/5.2	6.4/—
.FLUN	1.4/1.3	1.4/—
.NGL	8.2/4.5	8.6/8.3
.PACK	7.7/1.8	21.3/9.9
.PWR2	3.2/1.3	3.6/3.1
..TCM	10.4/9.7	10.9/10.4
Double-Integer Instructions		
	(A600/A600+)	(A600/A600+)
.DDI	14.5/3.632	15.4/16.344
.DDIR	15.4/4.570	16.3/17.479
.DMP	13.6/3.178	14.8/13.847
.DAD, .DSB, .DSBR	NA/2.497	—
.DIN, .DDE/.DNG	NA/1.135	NA/1.589
.DIS, .DDS	NA/3.859	—
.DCO	NA/2.497	NA/2.951

Table 3-6. Instructions and Opcodes for RTE-A Implementation

INSTRUCTION MNEMONIC	OCTAL OPCODE	INSTRUCTION MNEMONIC	OCTAL OPCODE	INSTRUCTION MNEMONIC	OCTAL OPCODE	INSTRUCTION MNEMONIC	OCTAL OPCODE
LPMR	105700	TBS	105775	.JRES	105252	.CZB	105410
SPMR	105701	MVW	105777	.JMAP	105245	.CAZ	101411
LDMP	105702	CMW	105776	.LPXR	105254	.CBZ	105411
STMP	105703	.XFER	105220	.LPX	105255	.CIQA	101412
LWD1	105704	.ENTR	105223	.LBPR	105256	.CIQB	105412
LWD2	105705	.ENTP	105224	.LBP	105257	.ADQA	101413
SWMP	105706	.ENTN	105234	.FAD	105000	.ADQB	105413
SIMP	105707	.ENTC	105235	.FAD	105000		
XJMP	105710	.DFER	105205	.FSB	105020		
XJCQ	105711	.CFER	105231	FSB	105020		
XLA1	101724	.FCM	105232	.FMP	105040		
XLA2	101421	.ZFER	105237	FMP	105040		
XLB1	105724	.SETP	105227	.FDV	105060		
XLB2	105721	\$.SETP	105227	FDV	105060		
XSA1	101725	.CPM	105236	.FIX	105100		
XSA2	101722	.DNG	105203	FIX	105100		
XSB1	105725	.DCO	105204	IFIX	105100		
XSB2	105722	.DIN	105210	.FLT	105120		
XCA1	101726	.DDE	105211	FLT	105120		
XCA2	101723	.DIS	105212	FLOAT	105120		
XCB1	105726	.DDS	105213	.CPU	105300		
XCB2	105723	.DAD	105014	.FWID	105301		
MW00	105727	.DSB	105034	.WFI	105302		
MW01	105730	.DSBR	105114	.SIP	105303		
MW02	105731	.PMAP	105240	.DLD	104200		
MW10	105732	CXA	101744	.DST	104400		
MW11	105733	CYA	101754	.MPY	100200		
MW12	105734	CXB	105744	.DIV	100400		
MW20	105735	CYB	105754	.TADD	105002		
MW21	105736	XAX	101747	.TSUB	105022		
MW22	105737	XAY	101757	.TMPY	105042		
MB00	101727	XBX	105747	.TDIV	105062		
MB01	101730	XBY	105757	.TCM	105233		
MB02	101731	STX	105743	.TFTS	105122		
MB10	101732	STY	105753	.TFTD	105126		
MB11	101733	LDX	105745	.TFXS	105102		
MB12	101734	LDY	105755	.TFXD	105106		
MB20	101735	ISX	105760	.NGL	105214		
MB21	101736	ISY	105770	.BLE	105207		
MB22	101737	DSX	105761	.FLUN	105226		
SAX	101740	DSY	105771	.PACK	105230		
SAY	101750	ADX	105746	.FIXD	105104		
SBX	105740	ADY	105756	.FLTD	105124		
SBY	105750	JLA	100600	.PWR2	105225		
CAX	101741	JLB	104600	.DMP	105054		
CAY	101751	XLA	101724	.DDI	105074		
CBX	105741	XLD	101724	.DDIR	105134		
CBY	105751	XLB	105724	.PCALI	105400		
LAX	101742	XSA	101725	.PCALX	105401		
LAY	101752	XST	101725	.PCALV	105402		
LBX	105742	XSB	105725	.PCALN	105404		
LBY	105752	XCA	101726	.PCALR	105406		
JLY	105762	XCB	105726	.EXIT	105417		
JPY	105772	MWF	105732	.EXIT1	105415		
LBT	105763	MWI	105730	.EXIT2	105416		
SBT	105764	MWW	105733	.SOSP	105406		
MBT	105765	MBF	101732	.CCQA	101406		
CBT	105766	MBI	101730	.CCQB	105406		
SFB	105767	MBW	101733	.CACQ	101407		
SBS	105773	.JMAP	105250	.CBCQ	105407		
CBS	105774	.IRES	105244	.CZA	101410		

DYNAMIC MAPPING SYSTEM

SECTION

IV

The basic addressing space of the HP 1000 A600 computer family is 32768 words, which is referred to as logical memory. The amount of memory actually installed in the computer system is referred to as physical memory. The Dynamic Mapping System (DMS) is standard logic in the HP 1000 A600 computer and provides an addressing capability for up to 16 million words of physical memory. The DMS allows logical memory to be mapped into physical memory through the use of dynamically-alterable memory maps.

4-1. MEMORY ADDRESSING

The basic memory addressing scheme provides for addressing 32 pages of logical memory, each of which consists of 1024 words. This memory is addressed through a 15-bit logical address bus as shown in the following figure. The upper 5 bits of this bus provide the logical page address and the lower 10 bits provide the relative word offset within the page.

Also associated with any memory access is a 5-bit logical map number. The DMS converts the logical map number and the logical page address into a 14-bit physical page number, thereby allowing 16k (2^{14}) pages of physical memory to be addressed. This conversion is accomplished by having the 5-bit logical map number and the 5-bit logical page address access 1024 page mapping registers (PMRs), each of which is 16 bits wide. Each of these map registers contains the user-specified (by DMS instructions) 14-bit page address. This new page address is combined with the original 10-bit page offset to form a 24-bit memory address as shown in the Figure 4-2.

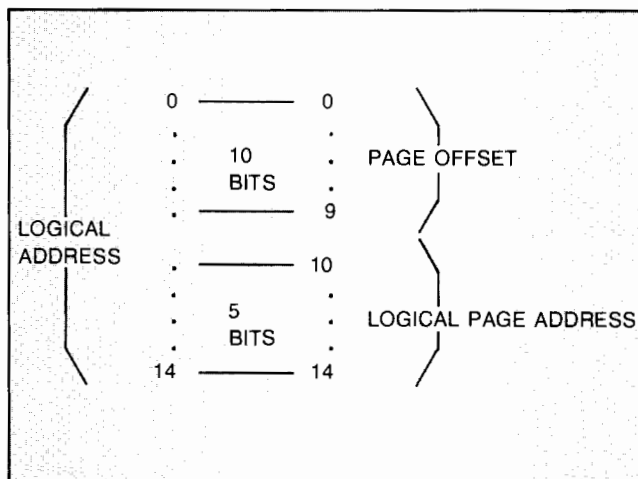

Figure 4-1. Basic Logical Memory Addressing Scheme

The PMRs also contain two bits of memory protection information. Bit 15 indicates that the page is read protected when the memory protect system is enabled. Bit 14 indicates that the page is write-protected when the memory protect system is enabled. Any attempt by the processor to write into a write-protected page or a read from a read-protected page will result in a memory protect violation. In the case of a read protect violation, the memory will return 177777. In the case of a write protect violation, memory will not be altered. However, DMA can access protected memory at any time.

If a memory protect violation occurs, the DMS signals the memory protect logic on the memory controller card that a violation has occurred, which causes the memory protect logic to generate an interrupt. As discussed in the Section VI, memory protect violations are interrupted to select code 07.

The width of the PMRs is limited to a 16-bit word, of which one bit specifies write protection and another specifies read protection, so the maximum width of the physical page address is 14 bits.

4-2. GENERAL DESCRIPTIONS

4-3. PAGE MAPPING REGISTER INSTRUCTIONS

The page mapping register instructions allow the privileged user to alter the PMRs, each of which have the following format:

PAGE MAPPING REGISTER FORMAT

0	}	physical page number	
•			
•			
13			
14			— write protect this page
15			— read protect this page (always zero on A600)

The page mapping register instructions are:

- LPMR — load a PMR indexed by register A from register B.
- SPMR — store a PMR indexed by register A to register B.
- LDMP — load a map from memory.
- STMP — store a map to memory.

4-4. WORKING MAP INSTRUCTIONS

The computer will maintain three logical maps, cumulatively called the Working Map Set (WMAP). The working map instructions allow the system to alter the logical maps, and also to initiate a user program.

The A600+ has an additional working map called the code map. The code map is defined as the Execute map that has been inclusively ORed with 1, following which the original Execute map is redefined as the data map. This use of separate maps for both code and data occurs only when CDS mode is enabled, and effectively doubles the logical address space for user programs.

The Execute map is the map number used for instruction fetches and normal memory accesses. The data maps (DATA1 and DATA2) are the map numbers used in cross-map memory references. There are two data maps to allow the system to do cross-map moves from one area of memory to another without having to go through the system map. In addition, this feature allows the system to be able to quickly access one area of memory (such as a System Available Memory map) while being able to also access another (such as the user's map). A memory reference to locations 0 or 1 in the Execute map are defined to access the A- or B-registers, respectively. References to 0 or 1 in the data maps are defined to access physical memory locations.

The format of WMAP is as follows:

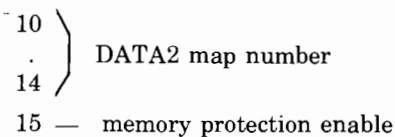
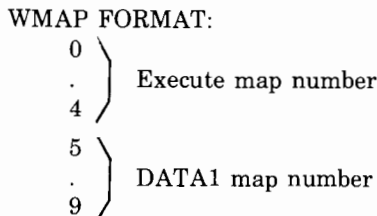

Upon servicing interrupts, the computer saves the currently executing WMAP in a register called IMAP, and loads WMAP with the following values:

- a. The DATA1 map is set to the old Execute map.
- b. The new Execute map is set to zero.
- c. The DATA2 map contains an undefined value.
- d. Memory protection is disabled.

The working map instructions are:

- XJCQ - cross jump and load CQ (A600+ only)
- XJMP - cross jump
- SWMP - store current WMAP into memory
- SIMP - store current IMAP into memory
- LWD1 - load WMAP field DATA1 from memory
- LWD2 - load WMAP field DATA2 from memory

4-5. CROSS-MAP INSTRUCTIONS

While the working map instructions provide a way to load the working map set, the cross-map instructions provide a means to use them.

These instructions are non-privileged. For all of these instructions, indirect DEF references are done through the Execute map, while the final reference is done through the specified map. When Code and Data Separation (CDS) is enabled, any memory accesses involving the Execute map number are considered to be data accesses, and the base register hardware will add the base (Q) register value to memory addresses from 2 through 1023. Memory accesses involving the DATA1 or DATA2 map numbers are done with CDS disabled, so accesses to the base page will not have the base register added.

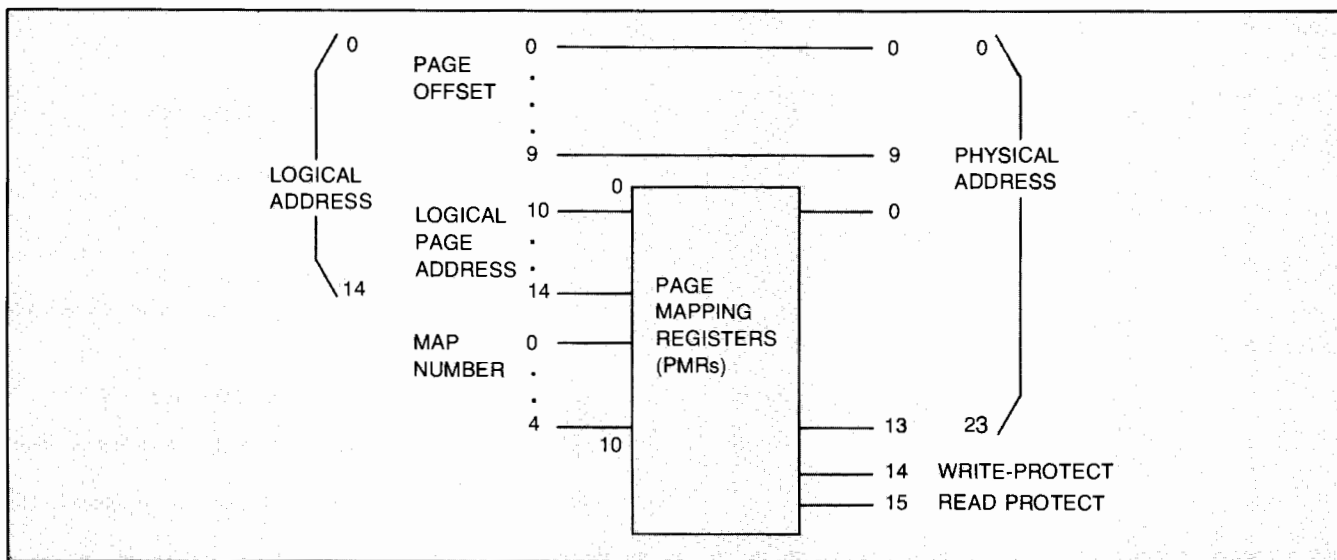

Figure 4-2. Expanded Memory Addressing Scheme



Abbreviations used are:

- "0" - means logical Execute map
- "1" - means logical DATA1 map
- "2" - means logical DATA2 map

The cross map instructions are:

- XLA1 - cross load A through the DATA1 map
- XLB1 - cross load B through the DATA1 map
- XLA2 - cross load A through the DATA2 map
- XLB2 - cross load B through the DATA2 map
- XSA1 - cross store A through the DATA1 map
- XSB1 - cross store B through the DATA1 map
- XSA2 - cross store A through the DATA2 map
- XSB2 - cross store B through the DATA2 map
- XCA1 - cross compare A through the DATA1 map
- XCB1 - cross compare B through the DATA1 map
- XCA2 - cross compare A through the DATA2 map
- XCB2 - cross compare B through the DATA2 map
- MW00 - cross move words from Execute to Execute
- MW01 - cross move words from Execute to DATA1
- MW02 - cross move words from Execute to DATA2
- MW10 - cross move words from DATA1 to Execute
- MW11 - cross move words from DATA1 to DATA1
- MW12 - cross move words from DATA1 to DATA2
- MW20 - cross move words from DATA2 to Execute
- MW21 - cross move words from DATA2 to DATA1
- MW22 - cross move words from DATA2 to DATA2
- MB00 - cross move bytes from Execute to Execute
- MB01 - cross move bytes from Execute to DATA1
- MB02 - cross move bytes from Execute to DATA2
- MB10 - cross move bytes from DATA1 to Execute
- MB11 - cross move bytes from DATA1 to DATA1
- MB12 - cross move bytes from DATA1 to DATA2
- MB20 - cross move bytes from DATA2 to Execute
- MB21 - cross move bytes from DATA2 to DATA1
- MB22 - cross move bytes from DATA2 to DATA2

If CDS mode is enabled, the base (Q) register will be added to base relative addresses in the Execute map only. Cross map references to addresses in one of the alternate maps are not checked for base relativity.

4-6. DETAILED DESCRIPTIONS

The following paragraphs provide machine language coding and definitions for the DMS instructions.

LPMR LOAD PAGE MAPPING REGISTER

15	14	13	12	11	10	9	8	7	6	5	4	3	2	1	0
1	0	0	0	1	0	1	1	1	1	0	0	0	0	0	0

Loads the contents of the B-register into the page mapping register (PMR) addressed by the contents of the A-register. Any attempt to address a PMR outside the range of 0 to 1023 produces undefined results. The format for the PMR contents is: bit 15 = read protect; bit 14 = write protect; and bits 13 to 0 = physical page number. This instruction is privileged. After the operation, the A-register is incremented.

SPMR STORE PAGE MAPPING REGISTER

15	14	13	12	11	10	9	8	7	6	5	4	3	2	1	0
1	0	0	0	1	0	1	1	1	1	0	0	0	0	0	1

Loads the contents of the page mapping register (PMR) addressed by the value in the A-register into the B-register. Any attempt to address a PMR outside the range of 0 to 1023 produces undefined results. The format for the PMR contents is: bit 15 = read protect; bit 14 = write protect; and bits 13 to 0 = physical page number. This instruction is privileged. After the operation, the A-register is incremented.

LDMP LOAD A MAP

15	14	13	12	11	10	9	8	7	6	5	4	3	2	1	0
1	0	0	0	1	0	1	1	1	1	0	0	0	0	1	0
D ₁															
D ₁															

Loads the map number specified by Word 2 from the 32-word block of memory specified by Word 3, where:

- Word 1 = Instruction code.
- Word 2 = Pointer to Map number.
- Word 3 = Pointer to Map image.

There are 32 maps of 32 PMRs each; the beginning PMR number of a map is related to the map number as follows:

$$\text{PMR number} = \text{Map number} \times 32$$

Undefined results occur when a map number outside the range of 0 to 31 is addressed, when modification of a currently executing map is tried, or when the resolved address of the map image is outside the range of 2 to 77740 octal.

All memory references are done in the Execute map and may include the A- and B-registers. This instruction is privileged and is interruptible in that it may be interrupted during indirect address resolution after three levels of indirection, and then restarted.

STMP STORE A MAP

15	14	13	12	11	10	9	8	7	6	5	4	3	2	1	0
1	0	0	0	1	0	1	1	1	1	0	0	0	0	1	1
D ₁															
D ₁															

Stores the map number specified by Word 2 to the 32-word block of memory specified by Word 3, where:

- Word 1 = Instruction code.
- Word 2 = Pointer to Map number.
- Word 3 = Pointer to Map image.

There are 32 maps of 32 PMRs each; the beginning PMR number of a map is related to the map number as follows:

$$\text{PMR number} = \text{Map number} \times 32$$

Undefined results occur when a map number outside the range of 0 to 31 is addressed, when modification of a currently executing map is tried, or when the resolved address of the map image is outside the range of 2 to 77740 octal.

All memory references are done in the Execute map and may include the A- and B-registers. This instruction is privileged and is interruptible in that it may be interrupted during indirect address resolution after three levels of indirection, and then restarted.

XJMP CROSS MAP JUMP

15	14	13	12	11	10	9	8	7	6	5	4	3	2	1	0
1	0	0	0	1	0	1	1	1	1	0	0	1	0	0	0
D ₁															
D ₁															

Resolves indirect references, sets the program counter to the resolved address specified by Word 3, and loads WMAP with the contents of Word 2, where:

- Word 1 = Instruction code.
- Word 2 = Pointer to new WMAP number.
- Word 3 = Pointer to next instruction (new PC value).

All memory references (direct and indirect) are done in the Execute map and may include the A- and B-registers. The next instruction will be fetched using the new WMAP. This instruction is privileged and is interruptible in that it may be interrupted during indirect address resolution after three levels of indirection, and then restarted.

XJCQ CROSS MAP JUMP (A600+ only) (AND LOAD C AND Q)

15	14	13	12	11	10	9	8	7	6	5	4	3	2	1	0
1	0	0	0	1	0	1	1	1	1	0	0	1	0	0	1
D ₁															
D ₁															

Resolves indirect references, sets the program counter to the resolved address specified by Word 3, loads the WMAP specified by Word 2, and loads the C- and Q-registers with new values addressed by Word 4, where:

- Word 1 = instruction opcode.
- Word 2 = pointer to new WMAP number.
- Word 3 = pointer to next instruction (new PC value).
- Word 4 = point to new C- and Q-register values.

All memory references (direct and indirect) are done in the Execute map and may include the A- and B-registers. The next instruction will be fetched using the new WMAP, under a CDS mode specified by the new C-register value. This instruction is privileged and is interruptible in that it may be interrupted during indirect address resolution after three levels of indirection, and then restarted.

SWMP SAVE WORKING MAP

15	14	13	12	11	10	9	8	7	6	5	4	3	2	1	0
1	0	0	0	1	0	1	1	1	1	0	0	0	1	1	0
D ₁															

Stores WMAP at the memory location pointed to by Word 2, where:

- Word 1 = Instruction code.
- Word 2 = Pointer to destination in memory.

All memory references are done in the Execute map and may include the A- and B-registers. This instruction is privileged and is interruptible in that it may be interrupted during indirect address resolution after three levels of indirection, and then restarted.

SIMP SAVE INTERRUPTED MAP

15	14	13	12	11	10	9	8	7	6	5	4	3	2	1	0
1	0	0	0	1	0	1	1	1	1	0	0	0	1	1	1
D ₁															

Stores IMAP at the location pointed to by Word 2, where:

- Word 1 = Instruction code.
- Word 2 = Pointer to destination in memory.

All memory references are done in the Execute map and may include the A- and B-registers. This instruction is privileged and is interruptible in that it may be interrupted during indirect address resolution after three levels of indirection, and then restarted.

LWD1 LOAD DATA1/8 MAP

15	14	13	12	11	10	9	8	7	6	5	4	3	2	1	0
1	0	0	0	1	0	1	1	1	1	0	0	0	1	0	0
D ₁															

Loads the DATA1 register from the memory location pointed to by Word 2, where:

- Word 1 = Instruction code.
- Word 2 = Pointer to new DATA1 map.

All memory references are done in the Execute map and may include the A- and B-registers. This instruction is privileged and is interruptible in that it may be interrupted during indirect address resolution after three levels of indirection. Map numbers outside the range of 0-31 produce undefined results.

LWD2 LOAD DATA2 MAP

15	14	13	12	11	10	9	8	7	6	5	4	3	2	1	0
1	0	0	0	1	0	1	1	1	1	0	0	0	1	0	1
D ₇ /I ₁															

Loads the DATA2 register from the memory location pointed to by Word 2, where:

- Word 1 = Instruction code.
- Word 2 = Pointer to new DATA2 map.

All memory references are done in the Execute map and may include the A- and B-registers. This instruction is privileged and is interruptible in that it may be restarted during indirect address resolution after three levels of indirection. Map numbers outside the range of 0-31 produce undefined results.

XLA1 CROSS LOAD A THROUGH DATA1 MAP

15	14	13	12	11	10	9	8	7	6	5	4	3	2	1	0
1	0	0	0	0	0	1	1	1	1	0	1	0	1	0	0
D ₇ /I ₁															

Loads the A-register from the memory location pointed to by Word 2, where:

- Word 1 = Instruction code.
- Word 2 = Pointer to memory location in DATA1 map.

All indirect memory references are done in the Execute map and may include the A- and B-registers and will be checked for base relativity if CDS mode is enabled. The direct memory reference is done in the DATA1 map. Because A- and B-register addressing and base relative checking are disabled in the DATA1 map, direct addresses 0 and 1 and 2 through 1777 refer to physical memory locations. This instruction is interruptible in that it may be interrupted during indirect address resolution after three levels of indirection, and then restarted.

XLA2 CROSS LOAD A THROUGH DATA2 MAP

15	14	13	12	11	10	9	8	7	6	5	4	3	2	1	0
1	0	0	0	1	0	1	1	1	1	0	1	0	1	0	0
D ₇ /I ₁															

Loads the A-register from the memory location pointed to by Word 2, where:

- Word 1 = Instruction code.
- Word 2 = Pointer to memory location in DATA2 map.

All indirect memory references are done in the Execute map and may include the A- and B-registers and will be checked for base relativity if CDS mode is enabled. The direct memory reference is done in the DATA2 map. Because A- and B-register addressing and base relative checking are disabled in the DATA2 map, direct addresses 0 and 1 and 2 through 1777 refer to physical memory locations. This instruction is interruptible in that it may be interrupted during indirect address resolution after three levels of indirection, and then restarted.

XLB1 CROSS LOAD B THROUGH DATA1 MAP

15	14	13	12	11	10	9	8	7	6	5	4	3	2	1	0
1	0	0	0	0	0	1	1	1	1	0	1	0	0	0	1
D ₇ /I ₁															

Loads the B-register from the memory location point to by Word 2, where:

- Word 1 = Instruction code.
- Word 2 = Pointer to memory location in DATA1 map.

All indirect memory references are done in the Execute map and map include the A- and B-registers and will be checked for base relativity if CDS mode is enabled. The direct memory reference is done in the DATA1 map. Because A- and B-register addressing and base relative checking are disabled in the DATA1 map, direct addresses 0 and 1 and 2 through 1777 refer to physical memory locations. This instruction is interruptible in that it may be interrupted during indirect address resolution after three levels of indirection, and then restarted.

XLB2 CROSS LOAD B THROUGH DATA2 MAP

15	14	13	12	11	10	9	8	7	6	5	4	3	2	1	0
1	0	0	0	1	0	1	1	1	1	0	1	0	0	0	1
D ₇ /I ₁															

Loads the B-register from the memory location pointed to by Word 2, where:

- Word 1 = Instruction code.
- Word 2 = Pointer to memory location in DATA2 map.

All indirect memory references are done in the Execute map and may include the A- and B-registers and will be checked for base relativity if CDS mode is enabled. The direct memory reference is done in the DATA2 map. Because A- and B-register addressing and base relative checking are disabled in the DATA2 map, direct addresses 0 and 1 and 2 through 1777 refer to physical memory locations. This instruction is interruptible in that it may be interrupted during indirect address resolution after three levels of indirection, and then restarted.

XSA1 CROSS STORE A THROUGH DATA1 MAP

15	14	13	12	11	10	9	8	7	6	5	4	3	2	1	0
1	0	0	0	0	0	1	1	1	1	0	1	0	1	0	1
D _i /I															

Stores the A-register contents in the memory location pointed to by Word 2, where:

- Word 1 = Instruction code.
- Word 2 = Pointer to memory location in DATA1 map.

All indirect memory references are done in the Execute map and may include the A- and B-registers and will be checked for base relativity if CDS mode is enabled. The direct memory reference is done in the DATA1 map. Because A- and B-register addressing and base relative checking are disabled in the DATA1 map, direct addresses 0 and 1 and 2 through 1777 refer to physical memory locations. This instruction is interruptible in that it may be interrupted during indirect address resolution after three levels of indirection, and then restarted.

XSB1 CROSS STORE B THROUGH DATA1 MAP

15	14	13	12	11	10	9	8	7	6	5	4	3	2	1	0
1	0	0	0	1	0	1	1	1	1	0	1	0	1	0	1
D _i /I															

Stores the B-register contents in the memory location pointed to by Word 2, where:

- Word 1 = Instruction code.
- Word 2 = Pointer to memory location in DATA1 map.

All indirect memory references are done in the Execute map and may include the A- and B-registers and will be checked for base relativity if CDS mode is enabled. The direct memory reference is done in the DATA1 map. Because A- and B-register addressing and base relative checking are disabled in the DATA1 map, direct addresses 0 and 1 and 2 through 1777 refer to physical memory locations. This instruction is interruptible in that it may be interrupted during indirect address resolution after three levels of indirection, and then restarted.

XSA2 CROSS STORE A THROUGH DATA2 MAP

15	14	13	12	11	10	9	8	7	6	5	4	3	2	1	0
1	0	0	0	0	0	1	1	1	1	0	1	0	0	1	0
D _i /I															

Stores the A-register contents in the memory location pointed to by Word 2, where:

- Word 1 = Instruction code.
- Word 2 = Pointer to memory location in DATA2 map.

All indirect memory references are done in the Execute map and may include the A- and B-registers and will be checked for base relativity if CDS mode is enabled. The direct memory reference is done in the DATA2 map. Because A- and B-register addressing and base relative checking are disabled in the DATA2 map, direct addresses 0 and 1 and 2 through 1777 refer to physical memory locations. This instruction is interruptible in that it may be interrupted during indirect address resolution after three levels of indirection, and then restarted.

XSB2 CROSS STORE B THROUGH DATA2 MAP

15	14	13	12	11	10	9	8	7	6	5	4	3	2	1	0
1	0	0	0	1	0	1	1	1	1	0	1	0	0	1	0
D _i /I															

Stores the B-register contents in the memory location pointed to by Word 2, where:

- Word 1 = Instruction code.
- Word 2 = Pointer to memory location in DATA2 map.

All indirect memory references are done in the Execute map and may include the A- and B-registers and will be checked for base relativity if CDS mode is enabled. The direct memory reference is done in the DATA2 map. Because A- and B-register addressing and base relative checking are disabled in the DATA2 map, direct addresses 0 and 1 and 2 through 1777 refer to physical memory locations. This instruction is interruptible in that it may be interrupted during indirect address resolution after three levels of indirection, and then restarted.

XCA1 CROSS COMPARE A THROUGH DATA1 MAP

15	14	13	12	11	10	9	8	7	6	5	4	3	2	1	0
1	0	0	0	0	0	1	1	1	1	0	1	0	1	1	0
D _i /I															

Compares the A-register contents with a value in the memory location pointed to by Word 2 and skips if the values are not equal, where:

- Word 1 = Instruction code.
- Word 2 = Pointer to memory location in DATA1 map.

All indirect memory references are done in the Execute map and may include the A- and B-registers and will be checked for base relativity if CDS mode is enabled. The direct memory reference is done in the DATA1 map. Because A- and B-register addressing and base relative checking are disabled in the DATA1 map, direct addresses 0 and 1 and 2 through 1777 refer to physical memory locations. This instruction is interruptible in that it may be interrupted during indirect address resolution after three levels of indirection, and then restarted.

XCB1 CROSS COMPARE B THROUGH DATA1 MAP

15	14	13	12	11	10	9	8	7	6	5	4	3	2	1	0
1	0	0	0	1	0	1	1	1	1	0	1	0	1	1	0
D ₇ /I ₁															

Compares the B-register contents with a value in the memory location pointed to by Word 2 and skips if the values are not equal, where:

- Word 1 = Instruction code.
- Word 2 = Pointer to memory location in DATA1 map.

All indirect memory references are done in the Execute map and may include the A- and B-registers and will be checked for base relativity if CDS mode is enabled. The direct memory reference is done in the DATA1 map. Because A- and B-register addressing and base relative checking are disabled in the DATA1 map, direct addresses 0 and 1 and 2 through 1777 refer to physical memory locations. This instruction is interruptible in that it may be interrupted during indirect address resolution after three levels of indirection, and then restarted.

XCA2 CROSS COMPARE A THROUGH DATA2 MAP

15	14	13	12	11	10	9	8	7	6	5	4	3	2	1	0
1	0	0	0	0	0	1	1	1	1	0	1	0	0	1	1
D ₇ /I ₁															

Compares the A-register contents with a value in the memory location pointed to by Word 2 and skips if the values are not equal, where:

- Word 1 = Instruction code.
- Word 2 = Pointer to memory location in DATA2 map.

All indirect memory references are done in the Execute map and may include the A- and B-registers and will be checked for base relativity if CDS mode is enabled. The direct memory reference is done in the DATA2 map. Because A- and B-register addressing and base relative checking are disabled in the DATA2 map, direct addresses 0 and 1 and 2 through 1777 refer to physical memory locations. This instruction is interruptible in that it may be interrupted during indirect address resolution after three levels of indirection, and then restarted.

XCB2 CROSS COMPARE B THROUGH DATA2 MAP

15	14	13	12	11	10	9	8	7	6	5	4	3	2	1	0
1	0	0	0	1	0	1	1	1	1	0	1	0	0	1	1
D ₇ /I ₁															

Compares the B-register contents with a value in the memory location pointed to by Word 2 and skips if the values are not equal, where:

- Word 1 = Instruction code.
- Word 2 = Pointer to memory location in DATA2 map.

All indirect memory references are done in the Execute map and may include the A- and B-registers and will be checked for base relativity if CDS mode is enabled. The direct memory reference is done in the DATA2 map. Because A- and B-register addressing and base relative checking are disabled in the DATA2 map, direct addresses 0 and 1 and 2 through 1777 refer to physical memory locations. This instruction is interruptible in that it may be interrupted during indirect address resolution after three levels of indirection, and then restarted.

MW00 CROSS MOVE WORDS, EXECUTE TO EXECUTE

15	14	13	12	11	10	9	8	7	6	5	4	3	2	1	0
1	0	0	0	1	0	1	1	1	1	0	1	0	1	1	1

Moves a block of words from the Execute map to the Execute map. The A-register specifies the source address, the B-register specifies the destination address, and the X-register specifies the number of words to be moved (which must be a positive integer equal to or greater than zero). Address bit 15 must be zero, as indirect source and destination references are not allowed. On return, the A-register contains the last memory address in the source block moved plus one, the B-register contains the last memory address in the destination block moved plus one, and the X-register is zero.

If CDS mode is enabled, the A- and B-registers will be checked for base relativity before execution. Upon exit these registers will contain the base relative address, incremented by the count in the X-register.

This instruction produces undefined results if the source or destination address rolls over. It is interruptible, with the context saved in the A-, B- and X-registers.

MW01 CROSS MOVE WORDS, EXECUTE TO DATA1

15	14	13	12	11	10	9	8	7	6	5	4	3	2	1	0
1	0	0	0	1	0	1	1	1	1	0	1	1	0	0	0

Moves a block of words from the Execute map to the DATA1 map. The A-register specifies the source address in the Execute map, the B-register specifies the destination address in the DATA1 map, and the X-register specifies the number of words to be moved (which must be a positive integer equal to or greater than zero). Address bit 15 must be zero, as indirect source and destination

references are not allowed. On return, the A-register contains the last memory address in the source block moved plus one, the B-register contains the last memory address in the destination block moved plus one, and the X-register is zero.

If CDS mode is enabled, the A-register will be checked for base relativity before execution. Upon exit this register will contain the base relative address, incremented by the count in the X-register.

This instruction produces undefined results if the source or destination address rolls over. It is interruptible, with the context saved in the A-, B- and X-registers.

MW02 CROSS MOVE WORDS, EXECUTE TO DATA2

15	14	13	12	11	10	9	8	7	6	5	4	3	2	1	0
1	0	0	0	1	0	1	1	1	1	0	1	1	0	0	1

Moves a block of words from the Execute map to the DATA2 map. The A-register specifies the source address in the Execute map, the B-register specifies the destination address in the DATA2 map, and the X-register specifies the number of words to be moved (which must be a positive integer equal to or greater than zero). Address bit 15 must be zero, as indirect source and destination references are not allowed. On return, the A-register contains the last memory address in the source block moved plus one, the B-register contains the last memory address in the destination block moved plus one, and the X-register is zero.

If CDS mode is enabled, the A-register will be checked for base relativity before execution. Upon exit this register will contain the base relative address, incremented by the count in the X-register.

This instruction produces undefined results if the source or destination address rolls over. It is interruptible, with the context saved in the A-, B- and X-registers.

MW10 CROSS MOVE WORDS, DATA1 TO EXECUTE

15	14	13	12	11	10	9	8	7	6	5	4	3	2	1	0
1	0	0	0	1	0	1	1	1	1	0	1	1	0	1	0

Moves a block of words from the DATA1 map to the Execute map. The A-register specifies the source address in the DATA1 map, the B-register specifies the destination address in the Execute map, and the X-register specifies the number of words to be moved (which must be a positive integer equal to or greater than zero). Address bit 15 must be zero, as indirect source and destination references are not allowed. On return, the A-register

contains the last memory address in the source block moved plus one, the B-register contains the last memory address in the destination block moved plus one, and the X-register is zero.

If CDS mode is enabled, the B-register will be checked for base relativity before execution. Upon exit this register will contain the base relative address, incremented by the count in the X-register.

This instruction produces undefined results if the source or destination address rolls over. It is interruptible, with the context saved in the A-, B- and X-registers.

MW11 CROSS MOVE WORDS, DATA1 TO DATA1

15	14	13	12	11	10	9	8	7	6	5	4	3	2	1	0
1	0	0	0	1	0	1	1	1	1	0	1	1	0	1	1

Moves a block of words from one location in the DATA1 map to another in the DATA1 map. The A-register specifies the source address, the B-register specifies the destination address, and the X-register specifies the number of words to be moved (which must be a positive integer equal to or greater than zero). Address bit 15 must be zero, as indirect source and destination references are not allowed. On return, the A-register contains the last memory address in the source block moved plus one, the B-register contains the last memory address in the destination block moved plus one, and the X-register is zero.

This instruction produces undefined results if the source or destination address rolls over. It is interruptible, with the context saved in the A-, B- and X-registers.

MW12 CROSS MOVE WORDS, DATA1 TO DATA2

15	14	13	12	11	10	9	8	7	6	5	4	3	2	1	0
1	0	0	0	1	0	1	1	1	1	0	1	1	1	0	0

Moves a block of words from the DATA1 map to the DATA2 map. The A-register specifies the source address in the DATA1 map, the B-register specifies the destination address in the DATA2 map, and the X-register specifies the number of words to be moved (which must be a positive integer equal to or greater than zero). Address bit 15 must be zero, as indirect source and destination references are not allowed. On return, the A-register contains the last memory address in the source block moved plus one, the B-register contains the last memory address in the destination block moved plus one, and the X-register is zero.

This instruction produces undefined results if the source or destination address rolls over. It is interruptible, with the context saved in the A-, B- and X-registers.

MW20**CROSS MOVE WORDS,
DATA2 TO EXECUTE**

15	14	13	12	11	10	9	8	7	6	5	4	3	2	1	0
1	0	0	0	1	0	1	1	1	1	0	1	1	1	0	1

Moves a block of words from the DATA2 map to the Execute map. The A-register specifies the source address in the DATA2 map, the B-register specifies the destination address in the Execute map, and the X-register specifies the number of words to be moved (which must be a positive integer equal to or greater than zero). Address bit 15 must be zero, as indirect source and destination references are not allowed. On return, the A-register contains the last memory address in the source block moved plus one, the B-register contains the last memory address in the destination block moved plus one, and the X-register is zero.

If CDS mode is enabled, the B-register will be checked for base relativity before execution. Upon exit this register will contain the base relative address, incremented by the count in the X-register.

This instruction produces undefined results if the source or destination address rolls over. It is interruptible, with the context saved in the A-, B- and X-registers.

MW21 CROSS MOVE WORDS, DATA2 TO DATA1

15	14	13	12	11	10	9	8	7	6	5	4	3	2	1	0
1	0	0	0	1	0	1	1	1	1	0	1	1	1	1	0

Moves a block of words from the DATA2 map to the DATA1 map. The A-register specifies the source address in the DATA2 map, the B-register specifies the destination address in the DATA1 map, and the X-register specifies the number of words to be moved (which must be a positive integer equal to or greater than zero). Address bit 15 must be zero, as indirect source and destination references are not allowed. On return, the A-register contains the last memory address in the source block moved plus one, the B-register contains the last memory address in the destination block moved plus one, and the X-register is zero.

This instruction produces undefined results if the source or destination address rolls over. It is interruptible, with the context saved in the A-, B- and X-registers.

MW22 CROSS MOVE WORDS, DATA2 TO DATA2

15	14	13	12	11	10	9	8	7	6	5	4	3	2	1	0
1	0	0	0	1	0	1	1	1	1	0	1	1	1	1	1

Moves a block of words from the DATA2 map to the DATA2 map. The A-register specifies the source address, the B-register specifies the destination address, and the X-register specifies the number of words to be moved (which must be a positive integer equal to or greater than zero). Address bit 15 must be zero, as indirect source and destination references are not allowed. On return, the A-register contains the last memory address in the source block moved plus one, the B-register contains the last memory address in the destination block moved plus one, and the X-register is zero.

This instruction produces undefined results if the source or destination address rolls over. It is interruptible, with the context saved in the A-, B- and X-registers.

MB00**CROSS MOVE BYTES,
EXECUTE TO EXECUTE**

15	14	13	12	11	10	9	8	7	6	5	4	3	2	1	0
1	0	0	0	0	0	1	1	1	1	0	1	0	1	1	1

Moves a block of bytes from one location in the Execute map to another in the Execute map. The A-register specifies the source address and the B-register specifies the destination address. The X-register specifies the number of bytes to be moved (which is an unsigned 16-bit number that may equal zero). Indirect addressing is not allowed because a byte address uses all 16 bits. A byte address is two times the word address plus zero or one, which specifies the high order (bits 15 to 8) or low order (bits 7 to 0) position, respectively. On return, the A-register contains the last memory byte address in the source block moved plus one, the B-register contains the last byte address in the destination block moved plus one, and the X-register is zero.

If CDS mode is enabled, the A- and B-registers will be checked for base relativity before execution. Upon exit these registers will contain the base relative address, incremented by the count in the X-register.

This instruction produces undefined results if the source or destination address rolls over. It is interruptible, with the context saved in the A-, B- and X-registers.

MB01**CROSS MOVE BYTES,
EXECUTE TO DATA1**

15	14	13	12	11	10	9	8	7	6	5	4	3	2	1	0
1	0	0	0	0	0	1	1	1	1	0	1	1	0	0	0

Moves a block of bytes from a location in the Execute map to one in the DATA1 map. The A-register specifies the source address in the Execute map, and the B-register specifies the destination address in the DATA1 map. The X-register specifies the number of bytes to be moved (which is an unsigned 16-bit number that may equal zero). Indirect addressing is not allowed because a byte address

uses all 16 bits. A byte address is two times the word address plus zero or one, which specifies the high order (bits 15 to 8) or low order (bits 7 to 0) position, respectively. On return, the A-register contains the last memory byte address in the source block moved plus one, the B-register contains the last byte address in the destination block moved plus one, and the X-register is zero.

If CDS mode is enabled, the A-register will be checked for base relativity before execution. Upon exit this register will contain the base relative address, incremented by the count in the X-register.

This instruction produces undefined results if the source or destination address rolls over. It is interruptible, with the context saved in the A-, B- and X-registers.

MB02 CROSS MOVE BYTES, EXECUTE TO DATA2

15	14	13	12	11	10	9	8	7	6	5	4	3	2	1	0
1	0	0	0	0	0	1	1	1	1	0	1	1	0	0	1

Moves a block of bytes from a location in the Execute map to one in the DATA2 map. The A-register specifies the source address in the Execute map, and the B-register specifies the destination address in the DATA2 map. The X-register specifies the number of bytes to be moved (which is an unsigned 16-bit number that may equal zero). Indirect addressing is not allowed because a byte address uses all 16 bits. A byte address is two times the word address plus zero or one, which specifies the high order (bits 15 to 8) or low order (bits 7 to 0) position, respectively. On return, the A-register contains the last memory byte address in the source block moved plus one, the B-register contains the last byte address in the destination block moved plus one, and the X-register is zero.

If CDS mode is enabled, the A-register will be checked for base relativity before execution. Upon exit this register will contain the base relative address, incremented by the count in the X-register.

This instruction produces undefined results if the source or destination address rolls over. It is interruptible, with the context saved in the A-, B- and X-registers.

MB10 CROSS MOVE BYTES, DATA1 TO EXECUTE

15	14	13	12	11	10	9	8	7	6	5	4	3	2	1	0
1	0	0	0	0	0	1	1	1	1	0	1	1	0	1	0

Moves a block of bytes from a location in the DATA1 map to one in the Execute map. The A-register specifies the source address in the DATA1 map, and the B-register specifies the destination address in the Execute map. The X-register specifies the number of bytes to be moved (which is an unsigned 16-bit number that may equal zero). Indirect addressing is not allowed because a byte address uses all 16 bits. A byte address is two times the word

address plus zero or one, which specifies the high order (bits 15 to 8) or low order (bits 7 to 0) position, respectively. On return, the A-register contains the last memory byte address in the source block moved plus one, the B-register contains the last byte address in the destination block moved plus one, and the X-register is zero.

If CDS mode is enabled, the B-register will be checked for base relativity before execution. Upon exit this register will contain the base relative address, incremented by the count in the X-register.

This instruction produces undefined results if the source or destination address rolls over. It is interruptible, with the context saved in the A-, B- and X-registers.

MB11 CROSS MOVE BYTES, DATA1 TO DATA1

15	14	13	12	11	10	9	8	7	6	5	4	3	2	1	0
1	0	0	0	0	0	1	1	1	1	0	1	1	0	1	1

Moves a block of bytes from one location in the DATA1 map to another in the DATA1 map. The A-register specifies the source address and the B-register specifies the destination address. The X-register specifies the number of bytes to be moved (which is an unsigned 16-bit number that may equal zero). Indirect addressing is not allowed because a byte address uses all 16 bits. A byte address is two times the word address plus zero or one, which specifies the high order (bits 15 to 8) or low order (bits 7 to 0) position, respectively. On return, the A-register contains the last memory byte address in the source block moved plus one, the B-register contains the last byte address in the destination block moved plus one, and the X-register is zero.

This instruction produces undefined results if the source or destination address rolls over. It is interruptible, with the context saved in the A-, B- and X-registers.

MB12 CROSS MOVE BYTES, DATA1 TO DATA2

15	14	13	12	11	10	9	8	7	6	5	4	3	2	1	0
1	0	0	0	0	0	1	1	1	1	0	1	1	1	0	0

Moves a block of bytes from a location in the DATA1 map to one in the DATA2 map. The A-register specifies the source address in the DATA1 map, and the B-register specifies the destination address in the DATA2 map. The X-register specifies the number of bytes to be moved (which is an unsigned 16-bit number that may equal zero). Indirect addressing is not allowed because a byte address uses all 16 bits. A byte address is two times the word address plus zero or one, which specifies the high order (bits 15 to 8) or low order (bits 7 to 0) position, respectively. On return, the A-register contains the last memory byte address in the source block moved plus one, the B-register contains the last byte address in the destination block moved plus one, and the X-register is zero.

This instruction produces undefined results if the source or destination address rolls over. It is interruptible, with the context saved in the A-, B- and X-registers.

MB20 CROSS MOVE BYTES, DATA2 TO EXECUTE

15	14	13	12	11	10	9	8	7	6	5	4	3	2	1	0
1	0	0	0	0	0	1	1	1	1	0	1	1	1	0	1

Moves a block of bytes from a location in the DATA2 map to one in the Execute map. The A-register specifies the source address in the DATA2 map, and the B-register specifies the destination address in the Execute map. The X-register specifies the number of bytes to be moved (which is an unsigned 16-bit number that may equal zero). Indirect addressing is not allowed because a byte address uses all 16 bits. A byte address is two times the word address plus zero or one, which specifies the high order (bits 15 to 8) or low order (bits 7 to 0) position, respectively. On return, the A-register contains the last memory byte address in the source block moved plus one, the B-register contains the last byte address in the destination block moved plus one, and the X-register is zero.

If CDS mode is enabled, the B-register will be checked for base relativity before execution. Upon exit this register will contain the base relative address, incremented by the count in the X-register.

This instruction produces undefined results if the source or destination address rolls over. It is interruptible, with the context saved in the A-, B- and X-registers.

MB21 CROSS MOVE BYTES, DATA2 TO DATA1

15	14	13	12	11	10	9	8	7	6	5	4	3	2	1	0
1	0	0	0	0	0	1	1	1	1	0	1	1	1	1	0

Moves a block of bytes from a location in the DATA2 map to one in the DATA1 map. The A-register specifies the source address in the DATA2 map, and the B-register specifies the destination address in the DATA1 map. The X-register specifies the number of bytes to be moved (which is an unsigned 16-bit number that may equal zero). Indirect addressing is not allowed because a byte address uses all 16 bits. A byte address is two times the word

address plus zero or one, which specifies the high order (bits 15 to 8) or low order (bits 7 to 0) position, respectively. On return, the A-register contains the last memory byte address in the source block moved plus one, the B-register contains the last byte address in the destination block moved plus one, and the X-register is zero.

This instruction produces undefined results if the source or destination address rolls over. It is interruptible, with the context saved in the A-, B- and X-registers.

MB22 CROSS MOVE BYTES, DATA2 TO DATA2

15	14	13	12	11	10	9	8	7	6	5	4	3	2	1	0
1	0	0	0	0	0	1	1	1	1	0	1	1	1	1	1

Moves a block of bytes from one location in the DATA2 map to another in the DATA2 map. The A-register specifies the source address and the B-register specifies the destination address. The X-register specifies the number of bytes to be moved (which is an unsigned 16-bit number that may equal zero). Indirect addressing is not allowed because a byte address uses all 16 bits. A byte address is two times the word address plus zero or one, which specifies the high order (bits 15 to 8) or low order (bits 7 to 0) position, respectively. On return, the A-register contains the last memory byte address in the source block moved plus one, the B-register contains the last byte address in the destination block moved plus one, and the X-register is zero.

This instruction produces undefined results if the source or destination address rolls over. It is interruptible, with the context saved in the A-, B- and X-registers.

4-7. DMS INSTRUCTION EXECUTION TIMES

Tables 4-1 and 4-2 list the execution times for the various DMS instructions.

4-8. ASSEMBLY LANGUAGE AND RTE IMPLEMENTATION

Refer to paragraphs 3-42 and 3-43 for information on implementing the DMS instructions in HP Assembly Language and in an HP RTE-A operating system.

Table 4-1. Dynamic Mapping Instructions Execution Times (A600 Only)

INSTRUCTION	EXECUTION TIME (μ s)
XLA1/XLB1, XSA1/XSB1	2.75
XLA2/XLB2, XSA2/XSB2	3.178
XCA1/XCB1, skip/no skip	3.405/2.951
XCA2/XCB2, no skip	3.178
MB00/MB01/MB10/MB11	2.043 plus 4.086 per byte moved
MB02/MB12/MB20/MB21/MB22	2.724 plus 4.086 per byte moved
MW00/MW01/MW10/MW11	2.043 plus 1.362 per word moved
MW02/MW12/MW20/MW21/MW22	2.724 plus 1.362 per word moved
LPMR/SPMR	4.086
LDMP/STMP	40.4
LWD1	3.632
LWD2	3.859
SWMP	4.767
SIMP	3.859
XJMP	7.037
<p>Note: Memory refresh during a processor memory access can make an instruction approximately 3% slower. Heavy DMA activity can also degrade instruction times due to contention for memory.</p>	

Table 4-2. Dynamic Mapping Instruction Execution Times (A600+ Only)

INSTRUCTION	EXECUTION TIME (μ s)
XLA1/B1/A2/B2 XSA1/B1/A2/B2	1.589 — 1.816 plus 0.681 per indirect
XCA1/B1/A2/B2 Skip/No Skip	1.816
MB00/01/02/10/11/12/20/21/22	1.589 — 3.405 plus 2.270 — 2.720 per byte
MW00/11/12	2.724 plus 0.908 per additional word
MW01/02/10/12/20/22	2.724 plus 1.135 per additional word
LPMR/SPMR	3.632
LDMP/STMP	38.15/38.36
LWD1/LWD2	1.362
SWMP/SIMP	3.859/2.724
XJMP	3.859
XJCQ	5.448

CODE AND DATA SEPARATION (A600+ ONLY)

SECTION

V

The basic logical address space of the HP 1000 A-Series architecture is 32768 words, in which both code and data reside. Code and Data Separation (CDS) is an enhancement to the A-Series architecture which separates code and data into separate logical address spaces. The main benefit of CDS is that it provides support of programs that may have up to 4M words of code, and this code may be either memory-resident or disc-resident. The optional HP 92078A package for RTE-A provides software support for CDS. Refer to the RTE-A Programmer's Reference Manual for a description of how to take advantage of CDS by using Macro/1000 and other HP languages.

5-1. CODE AND DATA ADDRESSING

CDS utilizes the Dynamic Mapping System environment of the A-Series architecture, and uses separate DMS maps to reference code and data. The term "code" refers to opcodes, DEFs to parameters, in-line constants, current-page links and constants for Memory Reference Group (MRG) instructions. The term "data" refers to variables and constants used by a program.

When CDS is disabled, both code and data are accessed through the logical address space of the computer, which is 32k words. The DMS maps this logical address space into the physical address space of up to 16M words. This is accomplished through the use of 32 memory maps of 32 pages each. A program executes in a single map, which is called the Execute map, although it may access memory through other maps using DMS instructions.

When CDS is enabled, code and data are accessed through separate maps. The Execute map number specifies which map is used to access data, and the Execute map number inclusive-ORed with '1' is used to access code. The Execute map number must be an even number between 0 and 30, inclusive. In all subsequent descriptions, DATA[n] and CODE[n] refers to memory locations in data space and code space, respectively. In addition, when CDS is enabled the base register (Q) is enabled, and all Execute map memory addresses that lie in the range 2 through 1023 have the Q-register added by the memory accessing hardware before the memory location is accessed. Locations 0 and 1 of data space are still defined to reference the A- and B-registers. Cross-map memory accesses, such as XLA1, are done with CDS disabled.

As an example, consider a DLD 500 instruction that is executed with CDS on, with an Execute map number of 2, and with the Q-register equal to 5000. The DLD opcode and the DEF 500 are read from memory using map number 3, because these words are considered to be code. The memory values loaded into A and B will be read through map number 2, because these words are consi-

dered to be data. The actual address of the memory locations to be loaded is 5500, because the hardware automatically adds the Q-register to memory addresses between 2 and 1023.

Most instructions separate code and data as was described for the previous example, but the Memory Reference Group has some exceptions. The JSB, STA current page direct, STB current page direct, and ISZ current page direct instructions may not be used when CDS is enabled because they attempt to write into code space. MRG references to base page always access memory in the data space, but MRG references to the current page always access code space for the first memory access and data space for all subsequent direct/indirect levels. That means that an LDA current page direct will load a constant from code space, that an LDA current page indirect will access a current page link in code space and then data in data space, and so on for the other MRG instructions. Note also that base page MRG references are useful for accessing variables that are Q-relative, such as the local variables or parameter pointers in a stack frame (to be described later).

The following restrictions must be met when CDS is enabled, otherwise undefined results may occur. The Q-register value must lie in the range of 1024 through 32767. The program counter must lie in the range 1024 to 32767, which means that jump instructions may not jump to the base page or to the A- or B-register.

Support for linking of relocatable code is provided by the RTE-A LINK program.

5-2. GENERAL DESCRIPTIONS

5-3. PROCEDURE CALL INSTRUCTIONS

The procedure call (PCAL) instructions are used to invoke a procedure, which may reside in code or data space. All of the PCAL instructions adjust the Q-register to allocate and set up a new stack marker (memory locations used to link procedure invocations and exits), and branch to the new procedure.

The PCAL instructions are:

- PCALI - procedure call to current segment
- PCALX - procedure call to any segment
- PCALV - procedure call to any segment (variable)
- PCALR - procedure call to .ENTR-compatible non-CDS code in data space
- PCALN - procedure call to .ENTN-compatible non-CDS code in data space

The PCALI instruction is the fastest PCAL instruction, and it is used to call a procedure that resides in the current code address space.

Two of the PCAL instructions (PCALX, PCALV) are capable of remapping the logical code space to another area of physical memory. Each logical code space is called a segment, and these PCALs are called cross-segment PCAL instructions.

The last two PCAL instructions (PCALR, PCALN) are used to call code that is not CDS-compatible. Such code resides in the data space, and must follow the .ENTR or .ENTN procedure call sequence.

The standard PCAL call sequence is:

```

PCAL opcode (PCALI, PCALX, PCALV, PCALR, or PCALN)
LABEL PE
DEC AC [,I]
DEF A_1 [,I]
:
DEF A_AC [,I]
(return point from procedure PE)
:
:
PE DEC FS
(next instruction to be executed in procedure PE)
:
EXIT opcode (EXIT, EXIT1, or EXIT2)

```

The PCAL opcode is the appropriate opcode to be used to access the new procedure. If the new procedure is in the same segment, then PCALI should be used. If the new procedure is in another segment, then PCALX or PCALV should be used. If the new procedure is not CDS-compatible, then PCALR or PCALN should be used. Note that the selection of the PCAL opcode is done automatically by the RTE-A LINK program, which will also automatically segment your program for you.

The LABEL to the new procedure points to the location of the new procedure. In the case of PCALI, PCALR, PCALN, the LABEL is a DEF (a 15-bit logical address, possibly indirect) to the new procedure. In the case of PCALX, the LABEL consists of a word which contains information that determines how the logical code space must be remapped to get to the new procedure. In the case of PCALV, the DEF (which may be indirect) points to a word in data space which specifies how code space should be remapped.

AC is a word which specifies how many parameter pointers follow. Parameter pointers are 15-bit logical addresses (with the 16th bit specifying indirection) which

point to variables that are being passed as parameters to the new procedure. From 0 to 255 parameter pointers may be passed in the PCAL call sequence.

5-4. PROCEDURE EXIT INSTRUCTIONS

There are three procedure exit instructions (EXIT, EXIT1, EXIT2). These instructions will remap the logical code space if necessary, adjust the Q-register value back to that of the calling procedure, and set the P-register to the return point in the calling procedure.

The EXIT instructions are:

```

EXIT - procedure exit with no skips
EXIT1 - procedure exit with one skip
EXIT2 - procedure exit with two skips

```

5-5. C, Q, Z, AND IQ INSTRUCTIONS

Other instructions are provided to access the C-, Q-, Z- and IQ-registers. These are:

```

CCQA (CCQB) - copy C and Q to A (or B)
CACQ (CBCQ) - copy A (or B) to C and Q
CZA (CZB) - copy Z to A (or B)
CAZ (CBZ) - copy A (or B) to Z
CIQA (CIQB) - copy IQ to A (or B)
ADQA (ADQB) - add Q to A (or B)
SDSP - store display

```

5-6. STACK FRAME DESCRIPTION

A stack frame is an area of memory in the logical data space that contains variables local to a procedure and pointers to variables of other procedures. The stack frame also contains six words of information called the stack marker, which links the procedure call chain from one procedure invocation to the next. The general layout of a stack frame is shown in Figure 5-1.

The Z-register, also called the bounds register, increases the reliability of CDS software. The bounds register detects the growth of a stack frame past the end of the allowed data space into areas used by VMA or memory used for other purposes. On every PCAL instruction, the microcode checks that the NEXT_Q value of a created stack marker is less than the Z-register. If this check fails then the program will interrupt to the memory protect handler (see PCALI description for more detail).

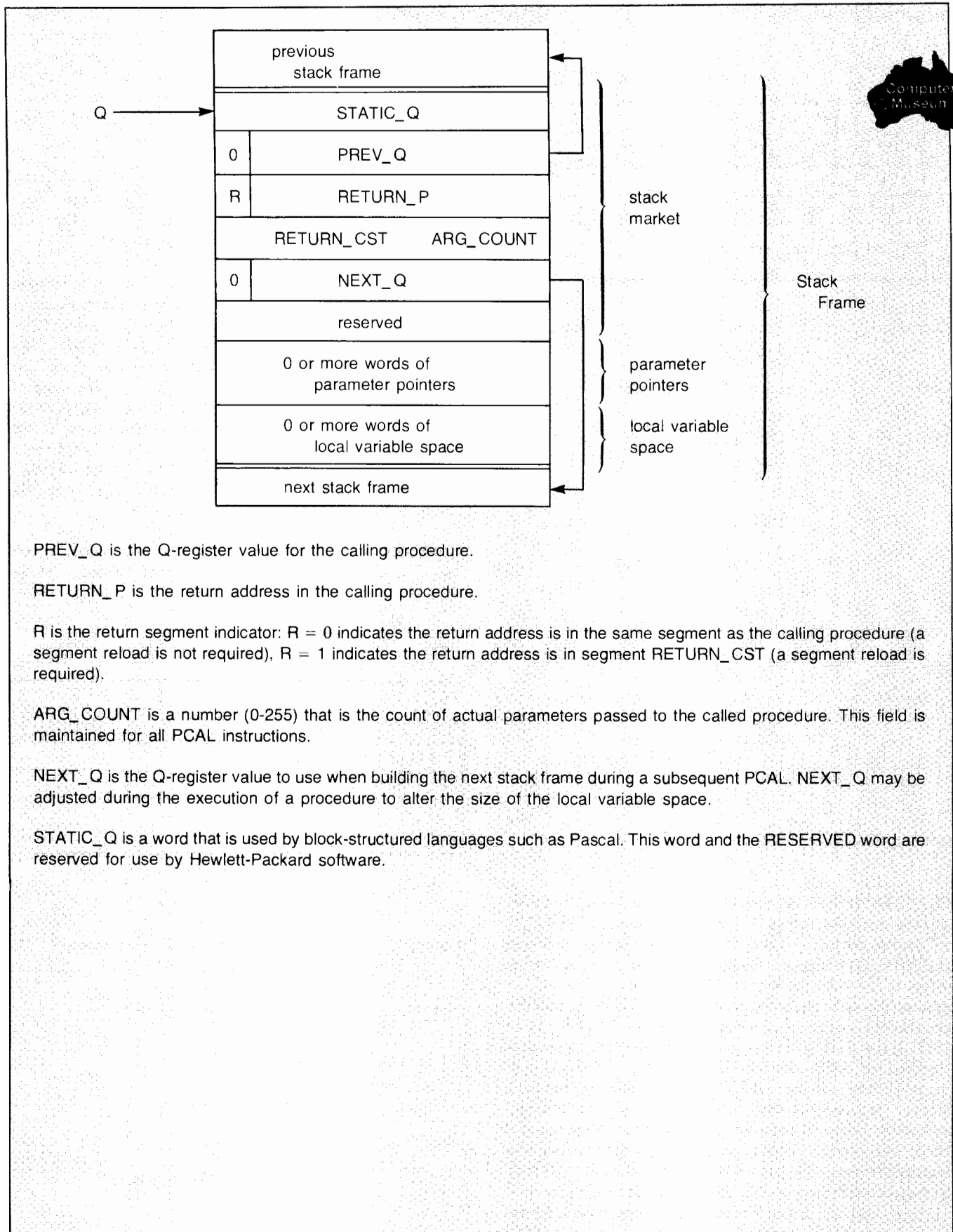

PREV_Q is the Q-register value for the calling procedure.

RETURN_P is the return address in the calling procedure.

R is the return segment indicator: R = 0 indicates the return address is in the same segment as the calling procedure (a segment reload is not required), R = 1 indicates the return address is in segment RETURN_CST (a segment reload is required).

ARG_COUNT is a number (0-255) that is the count of actual parameters passed to the called procedure. This field is maintained for all PCAL instructions.

NEXT_Q is the Q-register value to use when building the next stack frame during a subsequent PCAL. NEXT_Q may be adjusted during the execution of a procedure to alter the size of the local variable space.

STATIC_Q is a word that is used by block-structured languages such as Pascal. This word and the RESERVED word are reserved for use by Hewlett-Packard software.

Figure 5-1. Stack Frame General Layout

5-7. DETAILED DESCRIPTIONS

PCALI INTERNAL PROCEDURE CALL

15	14	13	12	11	10	9	8	7	6	5	4	3	2	1	0
1	0	0	0	1	0	1	1	0	0	0	0	0	0	0	0
D/I		DEF to subroutine													
N = argument count (0 ≤ N ≤ 255)															
D/I		N DEFs to arguments													
D/I															

Function: Procedure call to current code segment

Use: *Current Code Segment*

```
PCALI
DEF pe [,I]
DEC ac
DEF a_1 [,I]
:
DEF a_ac [,I]
```

Current Code Segment

```
pe EQU *
DEC fs
:
:
```

Operands: pe : Procedure entry point
ac : Actual argument count
a_i: Actual argument i
(multiple indirects are supported)
fs : Frame size in words

Interruptible: Yes

PCALI determines the new Q-register value for the called stack frame, which may be found at the current NEXT_Q value. The old Q value is written into the new stack frame at PREV_Q, which provides a link from the new stack frame to the old stack frame. The argument count (AC) of parameters to be passed is read from CODE[P+2], and the parameter pointers are copied from CODE[P+3] to DATA[new Q+6] after the parameter pointers have been resolved for indirection and base relativity. The value of AC is written into the ARG_COUNT location of the stack marker. Indirects are followed in memory until a direct address is found. If the (direct) address is between 2 and 1023, the current Q-register value is added before the parameter pointer is copied into data space. PCALI may be interrupted during parameter pointer resolution and copying, and the PCALI instruction may simply be restarted after the interrupt has been processed because the actual state of the calling procedure (specifically the P- and Q-registers) has not been altered.

The actual parameter count (AC) is stored in the ARG_COUNT field of the new stack frame, and the upper byte of that word (RTN_CST) is undefined. The return point of the procedure (P+3+AC) is stored in the RETURN_P location of the new stack frame. The 'R' bit contains zero, which designates that a subsequent EXIT instruction should exit without loading a new segment.

The called procedure entry (PE) is found by resolving the address at CODE[P+1], and CODE[PE] contains the called frame size (FS). The NEXT_Q value of the new stack frame is set to the new Q value plus FS.

If the new NEXT_Q is greater than or equal to the bounds register (Z), stack overflow has occurred and a memory protect interrupt will be executed to memory location 07 of map zero. After the interrupt, the instruction violation register is equal to the fetch address of the PCAL instruction, and the program counter value at the time of the interrupt is undefined. The Q-register and IQ-register point to the offending stack marker. The new stack marker and formal arguments may have been written into memory locations at addresses greater than the Z-register value. To provide a safety zone, set the Z-register to 264 words below the area you want to protect.

If stack overflow did not occur, PCALI branches to the called procedure by setting the program counter, P, to PE+1 and the Q-register to the new Q value.

PCALX EXTERNAL PROCEDURE CALL

15	14	13	12	11	10	9	8	7	6	5	4	3	2	1	0
1	0	0	0	1	0	1	1	0	0	0	0	0	0	0	1
0		Code label to subroutine													
N = argument count (0 ≤ N ≤ 255)															
D/I		N DEFs to arguments													
D/I															

Function: Procedure call to procedure in external segment.

Use: *Current Code Segment*

```
PCALX
LABEL pe
DEC ac
DEF a_1 [,I]
:
DEF a_ac [,I]
```

External Code Segment

```
pe EQU *
DEC fs
:
:
```

Operands: pe : Code label (Code Segment Table index and Segment Transfer Table index) to procedure.
 ac : Actual argument count
 a_i : Actual argument i
 fs : Frame size in words

Interruptible: Yes

PCALX determines the new Q-register value for the called stack frame, which may be found at the current NEXT_Q value. The old Q value is written into the new stack frame at PREV_Q, which provides a link from the new stack frame to the old stack frame. The actual count (AC) of parameters to be passed is read from CODE[P+2], and the parameter pointers are copied from CODE[P+3] to DATA[new Q+6] after the parameter pointers have been resolved for indirection and base relativity. PCALX may be interrupted during the parameter pointer resolution and copying, and the PCALX instruction may simply be restarted after the interrupt has been processed because the actual state of the calling procedure (specifically the P- and Q-registers) has not been altered.

The return point of the procedure (P+3+AC) is stored in the RETURN_P location of the new stack frame. The 'R' bit contains one, which designates that a subsequent EXIT instruction should load the new segment indicated by RETURN_CST in the stack marker. The current segment number is read from CODE[2000B], ANDed with 177400B, inclusive ORed with AC, and stored in DATA[new Q+3].

PCALX now attempts to load the external segment. The upper byte of CODE[P+1] contains the CST (Code Segment Table) index. The PCALX instruction looks up the CST entry through the base page of the code map set. (The code map set number is the Execute map number inclusive ORed with one.) The memory address of the CST entry is the CST index shifted left two times. Restriction: the CST index must be in the range 0 through 127. Note that this process of looking up a CST entry is done with the base register hardware and A/B addressability off. If bit 15 of the CST entry is '1', then the called procedure is not in memory. PCALX will interrupt to memory location 13 octal of map zero and this location must contain a JSB to the segment interrupt handler. The program counter at the time of the interrupt points to the offending PCALX instruction, and the Q value is unchanged. After the segment is loaded, the PCALX instruction may be re-executed. The CDS segment interrupt is the lowest priority interrupt, and if other interrupts are present when a fault is detected, the instruction is simply restarted after the other interrupts are serviced. The following paragraphs describe what PCALX does if the segment is present in memory.

This paragraph describes how a code segment is 'mapped in'. The lower 14 bits of the CST entry contain the starting physical page of the new code segment, which the

microcode maps in by setting the PMRs (page mapping registers) of code page 1 to the physical page number, code page 2 to the physical page number plus 1, code page 3 to the physical page number plus 2, and so on. These page mapping registers are write-protected to protect the code against alteration. The base page PMR of the code map is *not* altered.

After the new code segment has been mapped in, the entry point of the called procedure is determined. The low byte of the external label (in CODE[P+1] in the old segment) contains the STT (Segment Transfer Table) index. Beginning at location 2001B in code space is a table of address pointers (with bit 15 set to zero) that point to the externally accessible procedures in this segment. Location 2001B plus the STT index contains the 15 bit address of the called subroutine, and this value is the called procedure entry (PE).

CODE[PE] contains the called frame size (FS). The NEXT_Q value of the new stack frame is set to the new Q value plus FS. If the new NEXT_Q is greater than or equal to the bounds register (Z) then stack overflow has occurred, and a memory protect interrupt will be executed at memory location 07 of map zero. After the interrupt, the instruction violation register is equal to the fetch address of the PCALX instruction, and the program counter contains an undefined value. The Q-register and IQ-register point to the offending stack marker. The new stack marker and formal arguments may have written into memory locations at addresses greater than the Z-register value.

Now that the new stack marker is complete, PCALX branches to the called procedure by setting the program counter, P, to PE+1 and the Q-register to the new Q value.

PCALV VARIABLE EXTERNAL PROCEDURE CALL

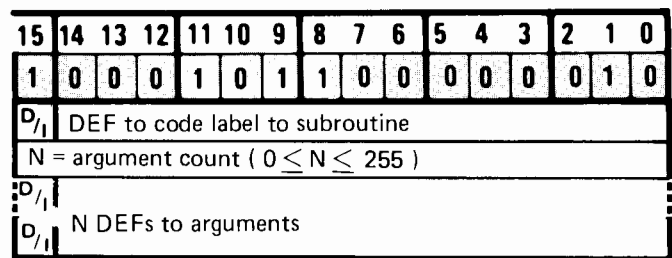

Function: Procedure call, Code to Code, External procedure

Use: *Current Code Segment*

- PCALV
- DEF xl [,I]
- DEC ac
- DEF a_1 [,I]
- :
- DEF a_ac [,I]

External Code Segment

```
pe EQU *
  DEC fs
  :
```

Data Segment

```
xl LABEL pe
  :
```

Operands: pe : Procedure entry point
 xl : Procedure variable
 ac ;; Actual argument count
 a_i: Actual argument i
 fs : Frame size in words

Interruptible: Yes

The difference between the PCALX and PCALV instructions is that the code label is in the call sequence in PCALX, while in PCALV it is in the data space. The pointer to the external label may be a multi-level indirect. See PCALX for a description of segment loading.

PCALR PROCEDURE CALL, .ENTR COMPATIBLE

15	14	13	12	11	10	9	8	7	6	5	4	3	2	1	0
1	0	0	0	1	0	1	1	0	0	0	0	0	0	1	1
$D_{/I}$ DEF to subroutine															
N = argument count ($0 \leq N \leq 255$)															
$D_{/I}$ N DEFs to arguments															

Function: Procedure call, Code to Data, .ENTR compatible

Use: *Current Code Segment*

```
PCALR
DEF pe [,I]
DEC ac
DEF a_1 [,I]
:
DEF a_ac [,I]
```

Data Segment

```
BSS fc
pe NOP
JSB .ENTR
DEF pe-fc
:
```

Operands: pe : Procedure entry point
 ac : Actual argument count
 a_i: Actual argument i
 fc : Formal argument count

Interruptible: Yes

PCALR is similar to PCALI except it is used for invoking procedures in the data segment that are .ENTR compatible. The mechanism for calling non-CDS-code involves copying a .ENTR call sequence (minus the JSB) into the stack frame. PCALR then turns off CDS, and executes the function of a JSB to the non-CDS-code procedure by writing a return address into the new procedure entry and branching to the procedure entry plus one. The procedure entry address must be between 1024 and 32766.

A "DEF *+AC+1" is written into the reserved word location (of the stack marker) for PCALR so as to follow the .ENTR calling convention.

The stack frame created by PCALR (and PCALN) is:

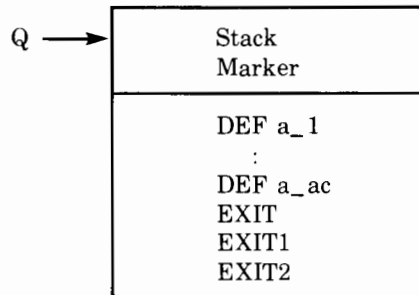

NEXT_Q in the stack marker is undefined.

PCALN PROCEDURE CALL, .ENTN COMPATIBLE

15	14	13	12	11	10	9	8	7	6	5	4	3	2	1	0
1	0	0	0	1	0	1	1	0	0	0	0	0	1	0	0
$D_{/I}$ DEF to subroutine															
N = argument count ($0 \leq N \leq 255$)															
$D_{/I}$ N DEFs to arguments															

Function: Procedure call, Code to Data, Constant Internal procedure, .ENTN compatible

Use: *Code Segment*

```
PCALN
DEF pe [,I]
DEC ac
DEF a_1 [,I]
:
DEF a_ac [,I]
```

Data Segment

```
BSS fc
pe NOP
JSB .ENTN
DEF pe-fc
:
```

CACQ COPY A TO C AND Q

15	14	13	12	11	10	9	8	7	6	5	4	3	2	1	0
1	0	0	0	0	0	1	1	0	0	0	0	0	1	1	1

Function: Copy A- to C- and Q-registers

Use: CACQ

Operands: A : value to load into C and Q

Interruptible: No

The value contained in the A-register is copied to the C- and Q-registers. Bits 14 through 0 are copied into the Q-register. If bit 15 of the A-register is one, then CDS is turned off before the next instruction is fetched; otherwise, CDS is turned on.

CBCQ COPY B TO C AND Q

15	14	13	12	11	10	9	8	7	6	5	4	3	2	1	0
1	0	0	0	1	0	1	1	0	0	0	0	0	1	1	1

Function: Copy B- to C- and Q-registers

Use: CBCQ

Operands: B : value to load into C and Q

Interruptible: No

The value contained in the B-register is copied to the C- and Q-registers. Bits 14 through 0 are copied into the Q-register. If bit 15 of the B-register is one, then CDS is turned off before the next instruction is fetched; otherwise, CDS is turned on.

CCQA COPY C AND Q TO A

15	14	13	12	11	10	9	8	7	6	5	4	3	2	1	0
1	0	0	0	0	0	1	1	0	0	0	0	0	1	1	0

Function: Copy C- and Q-registers to A-register

Use: CCQA

Operands: A gets values in C and Q

Interruptible: No

The C- and Q-registers are copied into the A-register. If CDS is enabled (C = 0), then bit 15 of the A-register is set to zero, otherwise, it is set to logic one.

CCQB COPY C AND Q TO B

15	14	13	12	11	10	9	8	7	6	5	4	3	2	1	0
1	0	0	0	1	0	1	1	0	0	0	0	0	1	1	0

Function: Copy C- and Q-registers to B-register

Use: CCQB

Operands: B gets values in C and Q

Interruptible: No

The C- and Q-registers are copied into the B-register. If CDS is enabled (C = 0), then bit 15 of the B-register is set to zero, otherwise, it is set to logic one.

CAZ COPY A TO Z

15	14	13	12	11	10	9	8	7	6	5	4	3	2	1	0
1	0	0	0	0	0	1	1	0	0	0	0	1	0	0	1

Function: Copy A-register to Z-register

Use: CAZ

Operands: Z gets value in A

Interruptible: No

The contents of the A-register are copied into the Z-register. The results of setting bit-15 of the Z-register are undefined.

CBZ COPY B TO Z

15	14	13	12	11	10	9	8	7	6	5	4	3	2	1	0
1	0	0	0	1	0	1	1	0	0	0	0	1	0	0	1

Function: Copy B-register to Z-register

Use: CBZ

Operands: Z gets value in B

Interruptible: No

The contents of the B-register are copied into the Z-register. The results of setting bit-15 of the Z-register are undefined.

CZA COPY Z TO A

15	14	13	12	11	10	9	8	7	6	5	4	3	2	1	0
1	0	0	0	0	0	1	1	0	0	0	0	1	0	0	0

Function: Copy Z-register to A-register
 Use: CZA
 Operands: A gets value in Z
 Interruptible: No

The contents of the Z-register are copied into the A-register.

CIQB COPY INTERRUPTED Q TO B

15	14	13	12	11	10	9	8	7	6	5	4	3	2	1	0
1	0	0	0	1	0	1	1	0	0	0	0	1	0	1	0

Function: Copy interrupted Q-register to B-register
 Use: CIQB
 Operands: IQ : interrupted Q and C values
 Interruptible: No

The B-register is loaded with the value of the IQ-register, which is the value of the C- and Q-registers at the time of the last interrupt or fault.

CZB COPY Z TO B

15	14	13	12	11	10	9	8	7	6	5	4	3	2	1	0
1	0	0	0	1	0	1	1	0	0	0	0	1	0	0	0

Function: Copy Z-register to B-register
 Use: CZB
 Operands: B gets value in Z
 Interruptible: No

The contents of the Z-register are copied into the B-register.

ADQA ADD Q TO A

15	14	13	12	11	10	9	8	7	6	5	4	3	2	1	0
1	0	0	0	0	0	1	1	0	0	0	0	1	0	1	1

Function: Add Q-register to A-register
 Use: ADQA
 Interruptible: Yes

The Q-register is added to the A-register (A = A+Q). The ADQA instruction produces undefined results if executed while CDS is disabled.

CIQA COPY INTERRUPTED Q TO A

15	14	13	12	11	10	9	8	7	6	5	4	3	2	1	0
1	0	0	0	0	0	1	1	0	0	0	0	1	0	1	0

Function: Copy interrupted Q-register to A-register
 Use: CIQA
 Operands: IQ : interrupted Q and C values
 Interruptible: No

The A-register is loaded with the value of the IQ-register, which is the value of the C- and Q-registers at the time of the last interrupt or fault.

ADQB ADD Q TO B

15	14	13	12	11	10	9	8	7	6	5	4	3	2	1	0
1	0	0	0	1	0	1	1	0	0	0	0	1	0	1	1

Function: Add Q-register to B-register
 Use: ADQB
 Interruptible: Yes

The Q-register is added to the B-register (B = B+Q). The ADQB instruction produces undefined results if executed while CDS is disabled.

5-8. ASSEMBLY LANGUAGE AND RTE IMPLEMENTATION

Refer to the Assembly Language and RTE Implementation paragraphs in Section III for information on implementing the CDS instructions in HP Assembly Language and in an HP RTE-A operating system.

5-9. EXECUTION TIMES

Table 5-1 shows the execution times for the CDS instructions.

Table 5-1. CDS Instruction Execution Times

INSTRUCTION	TIME (usec)
EXIT	
no segment mapping	2.27
with segment mapping	19.522
EXIT1	
no segment mapping	2.497
with segment mapping	19.749
EXIT2	
no segment mapping	2.73
with segment mapping	19.976
PCALI (no parameters)	4.54
per parameter passed	0.908
per indirect	0.45
PCALX (includes segment mapping)	22.7
per parameter	0.908
per indirect	0.45
PCALV (includes segment mapping)	23.154
per parameter	0.908
per indirect	0.45
PCALR	7.264
per parameter	0.908
per indirect	0.45
PCALN	6.81
per parameter	0.908
per indirect	0.45
CACQ,CBCQ	1.362 - 1.589
CCQA,CCQB	0.908
CAZ,CBZ	0.908
CZA,CZB	0.908
CIQA,CIQB	1.589
ADQA,ADQB	0.908
SDSP	
display size = 0	2.043
per element of display	0.908

INTERRUPT SYSTEM

SECTION

VI

The vectored priority interrupt system has up to 53 distinct interrupt levels, each of which has a unique priority assignment. In the A600/A600+ computer, the interrupt priority of an I/O card is based on the card's proximity to the processor card and is independent of the card's select code. The I/O card in the slot nearest to the processor card has the highest interrupt priority. Each I/O card has higher interrupt priority than I/O cards farther from the processor card and lower priority than cards closer to the processor card. As shown in Table 6-1, the select code of an interrupt level is associated with an interrupt location in memory.

Any device can be selectively enabled or disabled under program control, thus switching the device into or out of the interrupt structure. In addition, the interrupt system is divided into types of interrupts (Table 6-1). Interrupt Type 3 can be enabled or disabled under program control using a single instruction, and interrupt Types 2 and 3 combined can be enabled or disabled using a single instruction. Interrupt Type 4 cannot be disabled, but is lower priority than Types 1 through 3.

When a qualified interrupt is serviced, the state of the interrupted routine is saved in the IMAP and IQ registers, CDS mode and memory protect are turned off, the Execute map is set to 0 (System map), and the DATA1 map is set to the Execute map of the interrupted process. After this new state of the machine is set up, a fetch from the appropriate trap cell is performed. Trap cells are expected to contain a JSB to an appropriate routine which will then service the interrupt and restore the state of the interrupted process before restarting it. If a JSB or JMP instruction is not contained in the trap cell, instruction execution will proceed at the address which was interrupted, but in the System map.

6-1. POWER FAIL INTERRUPT

The computer power supply is equipped with power-sensing circuits. When primary line power fails or drops below a predetermined level while the computer is running, an interrupt to memory location 00004 is automatically generated. Memory location 00004 is intended to contain a jump-to-subroutine (JSB) instruction referencing the entry point of a user-supplied power fail subroutine (included in RTE-A). The interrupt capability of lower-priority (all Type 2 and 3) operations is automatically inhibited while a power fail subroutine is in process.

Table 6-1. A600/A600+ Interrupt Assignments

SELECT CODE (OCTAL)	INTERRUPT LOCATION	ASSIGNMENT	INTERRUPT TYPE
04	00004	Power Fail Interrupt	2
05	00005	Memory Parity Interrupt	1
06	00006	Time Base Generator Interrupt	3
07	00007	Memory Protect Interrupt	2
10	00010	Unimplemented Instruction Interrupt	1
11	00011	Reserved	
12	00012	VMA page fault	4
13	00013	CDS segment fault	4
14-17	00014-00017	Reserved	
20-77	00020-00077	I/O Card Interrupts	3

A minimum of five milliseconds is available between the detection of a power failure and the loss of usable power supply power to execute a power fail subroutine; the purpose of such a routine is to transfer the current state of the computer system into memory and then halt the computer. A sample power fail subroutine is given in Table 6-2. The optional battery backup card/module will supply enough power to preserve the contents of memory for a sustained line power outage of at least 20 minutes.

The user has a switch-selectable option of what action the computer will take upon restoration of primary power. When processor switch U1S8 is closed, the computer will execute either a loader or the Virtual Control Panel routine, depending on the setting of the Start-Up switches.

NOTE

Switch U1S8 is mounted on the processor card and is not an operator control. The setting of this switch is normally determined by the System Manager prior to or during system installation.

Table 6-2. Sample Power Fail Subroutine

LABEL	OPCODE	OPERAND	COMMENTS
PFAR	NOP		Power Fail/Auto Restart Subroutine.
	SFC	4B	Skip if interrupt was caused by power failure.
	JMP	UP	Power being restored; reset state of system.
DOWN	CLC	0B	Shut down any DMA or I/O.
	STA	SAVA	Save A-register contents.
	CCA		Set flag indicating that computer was running when power failed.
	STA	PFFLG	
	STB	SAVB	Save B-register contents.
	ERA,ALS		Transfer E-register content to A-register bit 15.
	SOC		Increment A-register if Overflow is set.
	INA		
	STA	SAVEO	Save E- and O-register contents.
	LDA	PFAR	Save contents of P-register at time of power failure.
	STA	SAVP	
	SIMP		Save IMAP contents.
	DEF	SAVI	
	.		
	.		Insert user-written routine to save I/O states.
	.		
	SFS	4B	
UP	JMP	*-1	Wait in case power comes back up.
	LDA	PFFLG	Was computer running when power failed?
	SZA,RSS		
	HLT	4B	No, then halt.
	CLA		Yes, then reset computer Run flag to initial state.
	STA	PFFLG	
	.		
	.		Insert user-written routine to restore I/O devices.
	.		
	LDA	SAVEO	Restore the contents of the E-register and O-register.
	CLO		
	SLA,ELA		
	STF	1B	Set O-register.
	LDA	SAVA	Restore A-register contents.
	LDB	SAVB	Restore B-register contents.
	STC	4B	Reset power fail logic for next power failure.
	XJMP		Cross jump to program executing at power failure.
	DEF	SAVI	
	DEF	SAVP,I	
SAVEO	OCT	0	Storage for E and O.
SAVA	OCT	0	Storage for A.
SAVB	OCT	0	Storage for B.
SAVP	OCT	0	Storage for P.
PFFLG	OCT	0	Storage for Run flag.
SAVI	OCT	0	Storage for IMAP.

Note: The memory maps used must be saved and restored, as must (if used) the states of the interrupt mask register, memory protect (conditional restore), and Global Register.

When switch U1S8 is open, the automatic restart feature is enabled. After the self-test is executed following the return to normal power levels, an interrupt to location 00004 occurs. This time the power-down portion of the subroutine is skipped and the power-up portion begins. (Refer to Table 6-2.) Those conditions existing at the time of the power fail interrupt are restored and the computer continues the program from the point of the interruption.

Note that an auto-restart interrupt to location 00004 occurs only if that location's contents are not zero; otherwise, the system is re-booted. This is done so that if power fails and is restored during a boot, an attempt to restart a partially loaded program can be avoided. To enable this to happen the program being loaded should initially load location 00004 with zero and load the power-fail JSB instruction only when the load is otherwise complete.

If the computer memory does not contain a subroutine to service the power fail interrupt, location 00004 should contain a JSB to a routine to restart the interrupted process.

At the end of a restart routine, consideration should be given to re-initializing the power-fail logic and to restoring the interrupt capability of the lower priority functions.

6-2. PARITY ERROR INTERRUPT

Parity checking of memory is a standard feature in the A600/A600+ computer. The parity logic continuously generates correct parity for all words written into memory and monitors the parity of all words read out of memory. Parity can be programmatically set to even parity (STF 05) or to odd parity (CLF 05). Correct odd parity is defined as having the total number of "1" bits in a 17-bit memory word (16 data bits plus the parity bit) equal to an odd value. If a "1" bit (or any odd number of "1" bits) is either dropped or added in the transfer process involving a standard memory array card, a Parity Error signal is generated when that word is read out of memory.

The Parity Error signal will generate an interrupt to memory location 00005 if the parity system was previously enabled by a STC 05 instruction. Parity interrupts turn off the Parity system. Location 00005 may contain either a JSB instruction referencing the entry point of a user-supplied parity error subroutine (included in RTE-A) or a JMP instruction pointing to a HLT instruction (I/O instructions, including a HLT instruction may not be in a trap cell). A parity error during a DMA transfer will cause an interrupt to the memory location corresponding to the select code of the I/O card making the transfer if the proper bit has been set in the control word.

The address of the parity error will be loaded automatically into the parity register which is accessible to the user by a programmed LIA 05 or LIB 05 instruction for bits 0 to 15 and by a LIA 05,C or LIB 05,C for bits 16 to 23.

If a parity error occurs in the A600+ during a fetch of an instruction, that instruction is not executed. If a parity error occurs during the execution of an instruction, memory writes are disabled. When a parity error occurs, it is recommended that the entire program or set of data containing the error location be reloaded.

6-3. MEMORY PROTECT INTERRUPT

The memory protect feature provides the capability of protecting selected pages of memory against access or entry by programmed instructions, except that A- and B-registers may always be referenced as memory locations 0 and 1.

The memory protect logic, when enabled by an STC 07 instruction, also prohibits the execution of all I/O instructions except those referencing I/O select code 01 (the processor card switch and LED registers and the overflow register). (Execution of all HLTs is prohibited.) Thus, an executive or privileged program residing in protected memory can have exclusive control of the I/O system.

The memory protect system is disabled automatically by any interrupt and must be re-enabled by an STC 07 or XJMP instruction at the end of each interrupt subroutine.

Programming rules pertaining to the use of memory protect are as follows (assuming that an STC 07 instruction has been given):

- a. Locations 00000 and 00001 in the Execute map are the A- and B-registers and are not in protected memory. Locations 00000 and 00001 in the DATA1 and DATA2 map are real memory locations (not the A- and B-registers) and may reside in a protected page.
- b. A user-specified 1024-word page of memory is protected by Page Mapping Register instructions described in Section IV.
- c. Execution will be inhibited and an interrupt to location 07 will occur if any instruction attempts to access a location in protected memory, or if any privileged instruction is attempted (excluding those addressing select code 01 but not HLT 01).

Following a memory protect interrupt, the address of the offending instruction will be present in the violation register. This address is made accessible to the programmer by an LIA 07 or LIB 07 instruction, which loads the address into the A- or B-register.

Note that DMA operation is not affected by memory protect.

6-4. UNIMPLEMENTED INSTRUCTION INTERRUPT

An unimplemented instruction interrupt (to memory location 00010) is requested when the CPU signals that the last instruction fetched was not recognized. This interrupt provides a straightforward entry to software routines for the execution of instruction codes not recognized by the computer hardware. The unimplemented instruction interrupt must receive immediate service in order to recover the instruction code that caused it. For this reason, and because it is desirable to permit the use of unimplemented instructions anywhere, the unimplemented instruction interrupt is never inhibited.

6-5. TIME BASE GENERATOR INTERRUPT

A time base generator interrupt request is made when the CPU signals that its internal clock divider chain has rolled over. The clock divider is set to roll over at 10-millisecond intervals for maintaining a real-time clock. The interrupt occurs through location 00006 and can be masked (inhibited) by using bit 1 of the interrupt mask register. (The interrupt mask register allows interrupts from the TBG and the I/O cards to be selectively masked. For details on the interrupt mask register, refer to the *HP 1000 L-Series Computer I/O Interfacing Guide*, part no. 02103-90005.) The TBG can also be turned on by an STC 06 instruction and turned off by a CLC 06 or CLC 00 instruction. The A600+ provides a programmable TBG.

6-6. VIRTUAL MEMORY AREA INTERRUPT

During the execution of a VMA instruction, the hardware may determine that the desired VMA address does not reside in physical memory and needs to be loaded from disc. This causes a VMA interrupt to memory location 000012 (octal). This interrupt can occur only when Code and Data Separation (CDS) is enabled.

6-7. CDS SEGMENT INTERRUPT

During the execution of a CDS instruction, the hardware may determine that a desired CDS segment does not reside in physical memory and needs to be loaded from disc. This causes a CDS segment interrupt to memory location 000013 (octal).

6-8. INPUT/OUTPUT INTERRUPT

Interrupt locations 20 through 77 (octal) are reserved for I/O devices. In a typical I/O operation, the computer issues a programmed command such as Set Control/Clear Flag (STC,C) to one or more external devices to initiate an input (read) or an output (write) operation, via either

programmed I/O or DMA. While the I/O card is in the process of transferring data, the computer may be either running a program or looping, waiting for a flag to get set. Upon completion of the read or write operation, the interface flag is set. If the corresponding control bit is set, the interface will interrupt. Its request will be passed through a priority network so that only the highest priority interrupting device will receive service. The computer will acknowledge the interrupt and the highest priority device will receive service when the current instruction has finished executing, except under the following circumstances:

- a. Interrupt system disabled or interface card interrupt disabled (or masked).
- b. JMP indirect or JSB indirect instruction not sufficiently executed. These instructions inhibit all interrupts except power fail, parity error or memory protect until the succeeding instruction is executed. After three successive levels of indirect addressing, the logic will allow a pending I/O interrupt.
- c. A DMA (direct memory access) data transfer is in process.
- d. Current instruction is any I/O instruction. The interrupt in this case must wait until the succeeding instruction is executed.

After an interface card has been issued a Set Control (STC instruction) and its flag bit becomes set, all interrupt requests from lower-priority devices are inhibited until this flag bit is cleared by a Clear Flag (CLF) instruction. A service subroutine in process for any device can be interrupted only by a higher-priority device; then, after the higher-priority device is serviced, the interrupted service subroutine can continue. In this way it is possible for several service subroutines to be in the interrupt state at one time; each of these service subroutines will be allowed to continue after the higher-priority device is serviced. All such service subroutines normally end with a JMP indirect or XJMP instruction to return the computer to the point of interrupt.

Note that interrupt trap cells must contain a JMP or JSB instruction because maps change on interrupt.

6-9. INTERRUPT PRIORITY

The interrupt servicing priority among the system interrupts is as follows:

- a. Parity error (select code 5).
- b. Unimplemented instruction (select code 10).
- c. Memory protect (select code 7).
- d. Power fail (select code 4).

- e. Time base generator (select code 6).
- f. I/O interrupts (select codes 20 through 77).
- g. Virtual Memory Area (select code 12) and CDS Segment (select code 13).

6-10. CENTRAL INTERRUPT REGISTER

Each time an interrupt occurs, the address of the interrupt location is stored in the central interrupt register. The contents of this register are accessible by executing an LIA 04/LIB 04 or MIA 04/MIB 04 instruction. This loads (or merges) the address of the most recent interrupt into the A- or B-register.

6-11. PROCESSOR STATUS REGISTER

The processor status register is two registers: one for input and one for output. The input register shows the status of the processor card switches and is read into the upper eight bits of the A- or B-register by an LIA/B 01 instruction. The switch, bit, and function relationships are as follows:

<u>SWITCH</u>	<u>BIT</u>	<u>MEANING</u>
U1S1	8	Boot select
U1S2	9	Boot select
U1S3	10	Boot select
U1S4	11	Boot select
U1S5	12	VCP program select
U1S6	13	Not used
U1S7	—	Not used
U1S8	15	Auto-restart enabled (1)/ disabled (0)
—	14	Interrupt mask bit 1 (1 = TBG interrupt masked)

The output register drives the processor card LEDs. The output of the lower eight bits of the A- or B-register are sent to the LEDs by an OTA/B 01 instruction. A logic 1 in the appropriate register lights the corresponding LED.

6-12. INTERRUPT TYPE CONTROL

I/O address 00 is the master control address for Type 3 interrupts (TBG and I/O cards). An STF 00 instruction enables Type 3 interrupts and a CLF 00 disables Type 3 interrupts. (Type 3 interrupts are disabled when power is initially applied.) I/O address 04 is the master control address for Type 2 interrupts (power fail and memory protect) and Type 3 interrupts combined. An STC 04 instruction enables Type 2 interrupts and a CLC 04 disables Type 2 and 3 interrupts.

6-13. INSTRUCTION SUMMARY

Table 6-3 is a summary of instructions for select codes 00 through 07. For a summary of instructions used with the I/O cards, refer to an I/O card reference manual.

The Type 2 and 3 interrupt mask from I/O address 04 is a different Type-3 mask than the Type-3 mask at I/O address 00. If either of these two masks are set, Type 3 interrupts will be disabled. In addition to these two interrupt masks, the Time Base Generator flag interrupt can also be masked by bit 0 of the Interrupt Mask Register. If any of these three masks are set then the TBG flag interrupt will be disabled.



Table 6-3. Instructions for Select Codes 00 through 07

INSTRUCTION	FUNCTION	INSTRUCTION	FUNCTION
STC 0	NOP	STC 4	Enable Type 2 and 3 interrupts
CLC 0	System reset	CLC 4	Disable Type 2 and 3 interrupts
STF 0	Enable Type 3 interrupts	STF 4	NOP
CLF 0	Disable Type 3 interrupts	CLF 4	NOP
SFS 0	Skip if Type 3 interrupts enabled	SFS 4	Skip if power is stable
SFC 0	Skip if Type 3 interrupts disabled	SFC 4	Skip if power going down
LI* 0	Load from interrupt mask register	LI* 4	Load from central interrupt register
MI* 0	NOP	MI* 4	Merge from CIR (A600+)
OT* 0	Output to interrupt mask register	OT* 4	Output to central interrupt register
STC 1	NOP	STC 5	Enable parity error interrupts
CLC 1	NOP	CLC 5	Disable parity error interrupts
STF 1	Same as Set Overflow (STO)	STF 5	Set parity sense to even parity
CLF 1	Same as Clear Overflow (CLO)	CLF 5	Clear parity sense to odd parity
SFS 1	Same as Skip if Overflow Set (SOS)	SFS 5	Skip if parity sense is even
SFC 1	Same as Skip if Overflow Clear (SOC)	SFC 5	Skip if parity sense is odd
LI* 1	Load from processor switch register	LI* 5	Load from parity register (bits 0-15)
MI* 1	Merge from processor status register	LI* 5,C	Load from parity register (bits 16-23)
OT* 1	Output to processor LED register	MI* 5	NOP
STC 2	Enable break feature	OT* 5	NOP
CLC 2	NOP	STC 6	Turn on time base generator
STF 2	Disable Global Register	CLC 6	Turn off time base generator
CLF 2	Enable Global Register	STF 6	Set time base generator flag
SFS 2	Skip if Global Register disabled	CLF 6	Clear time base generator flag
SFC 2	Skip if Global Register enabled	SFS 6	Skip if time base generator flag set
LI* 2	Load from Global Register	SFC 6	Skip if time base generator flag clear
MI* 2	NOP	LI* 6	Load TBG frequency (A600+)
OT* 2	Output to Global Register (Note 1)	MI* 6	NOP
STC 3	NOP	OT* 6	Set TBG frequency (A600+)
CLC 3	NOP	STC 7	Enable memory protect
STF 3	NOP	CLC 7	NOP
CLF 3	NOP	STF 7	NOP
SFS 3	NOP	CLF 7	NOP
SFC 3	NOP	SFS 7	NOP
LI* 3	Load from P SAVE	SFC 7	NOP
MI* 3	NOP	LI* 7	Load from violation register
OT* 3	Output to P SAVE	MI* 7	NOP
LI* 3,C	Load from ROM P	OT* 7	NOP
OT* 3,C	Output to ROM P		

* = A or B.

Note 1. An OTA/B 2 with A/B equal to one through seven establishes a diagnose mode; refer to paragraph 7-22 for details.

The purpose of the input/output system is to transfer data between the computer and external devices. As shown in Figure 7-1, data can be transferred either by a direct memory access (DMA) feature or through the A- or B-register in the CPU (non-DMA). Each A/L-series I/O card has DMA logic and DMA is normally used for most I/O data transfers. Once the DMA logic has been initialized, no programming is involved and the transfer occurs in two distinct steps as follows:

- a. Between the external device and its I/O interface card in the computer;
- b. Between the I/O card and memory via the backplane data bus. This two-step process also applies to a DMA output transfer except in reverse order.

As mentioned above, data may be transferred under program control without using the DMA feature. This type of transfer allows the computer to manipulate the data during the transfer process. A non-DMA input transfer is a three-step process as follows:

- a. Between the external device and its I/O card;
- b. Between the I/O card and the A- or B-register via the data bus and the processor card; and
- c. Between the A- or B-register and memory via the processor and the data bus.

Note that in the DMA transfer the processor card is bypassed. Since a DMA transfer eliminates programmed loading and storing via the accumulators, the time involved is very short. Further information on the DMA feature is given in paragraph 7-9.

7-1. INPUT/OUTPUT ADDRESSING

As shown in Figure 7-2, an external device is connected by cable directly to an interface card located in the computer mainframe. The interface card, in turn, plugs into one of the input/output slots, each of which is assigned a fixed interrupt priority. Note, however, that the select code of the A/L-Series interface cards is independent of the priority. The computer communicates with a specific device on the basis of its select code which is set by switches on the interface card.

Figure 7-2 shows an interface card inserted in the I/O slot having the highest priority. If it is decided that the associated device should have lower priority, its interface

card and cable may simply be exchanged with those occupying some other I/O slot. This will change the priority but not the I/O address (select code). Due to priority chaining, there can be no vacant slots from the highest priority slot to the lowest priority slot used. Only select codes 20 through 77 (octal) are available for input/output cards; the lower select codes (00 through 17) are reserved for other features.

7-2. INPUT/OUTPUT PRIORITY

The plug-in card slots of the A600/A600+ computers are numbered 1 through 20 (HP 2156A/B and 2196A/B/C/D) or 1 through 8 (HP 2136A/B/C/D and 2186A/B/C/D). Generally, slots 1 and 2 are used for the memory controller and processor cards and the remaining slots are available for I/O cards, with slot 3 having the highest I/O interrupt priority. Also, in the 16-slot computer (HP 2436A/E and HP 2486A) slots 8 and 16 are reserved for the 25 kHz power module and the battery backup card, respectively. An I/O channel consists of an I/O device (or devices) and its I/O card and is assigned the number of the card slot.

When an input/output device is ready to be serviced, it causes its interface card to request an interrupt so that the computer will interrupt the current program and service the device. Since many device interface cards will be requesting service at random times, it is necessary to establish an orderly sequence for granting interrupts. Also, it is desirable that high-speed devices should not have to wait for low-speed device transfers. Both of these requirements are met by a series-linked priority structure illustrated by Figure 7-3. The bold line, representing a priority enabling signal, is routed in series through each card capable of causing an interrupt. The card cannot interrupt unless this enabling signal is present at its input.

Each device (or other interrupt function) can break the enabling line when it requests an interrupt. If two devices simultaneously request an interrupt, the device with the highest priority will be the first one that can interrupt because it has broken the enable line for the lower-priority device. The other device cannot begin its service routine until the first device is finished. However, a still higher-priority device (one interfaced through a lower-numbered slot) may interrupt the service routine of the first device. Figure 7-4 illustrates a hypothetical case in which several devices request service by interrupting a CPU program. Both simultaneous and time-separated interrupt requests are considered.

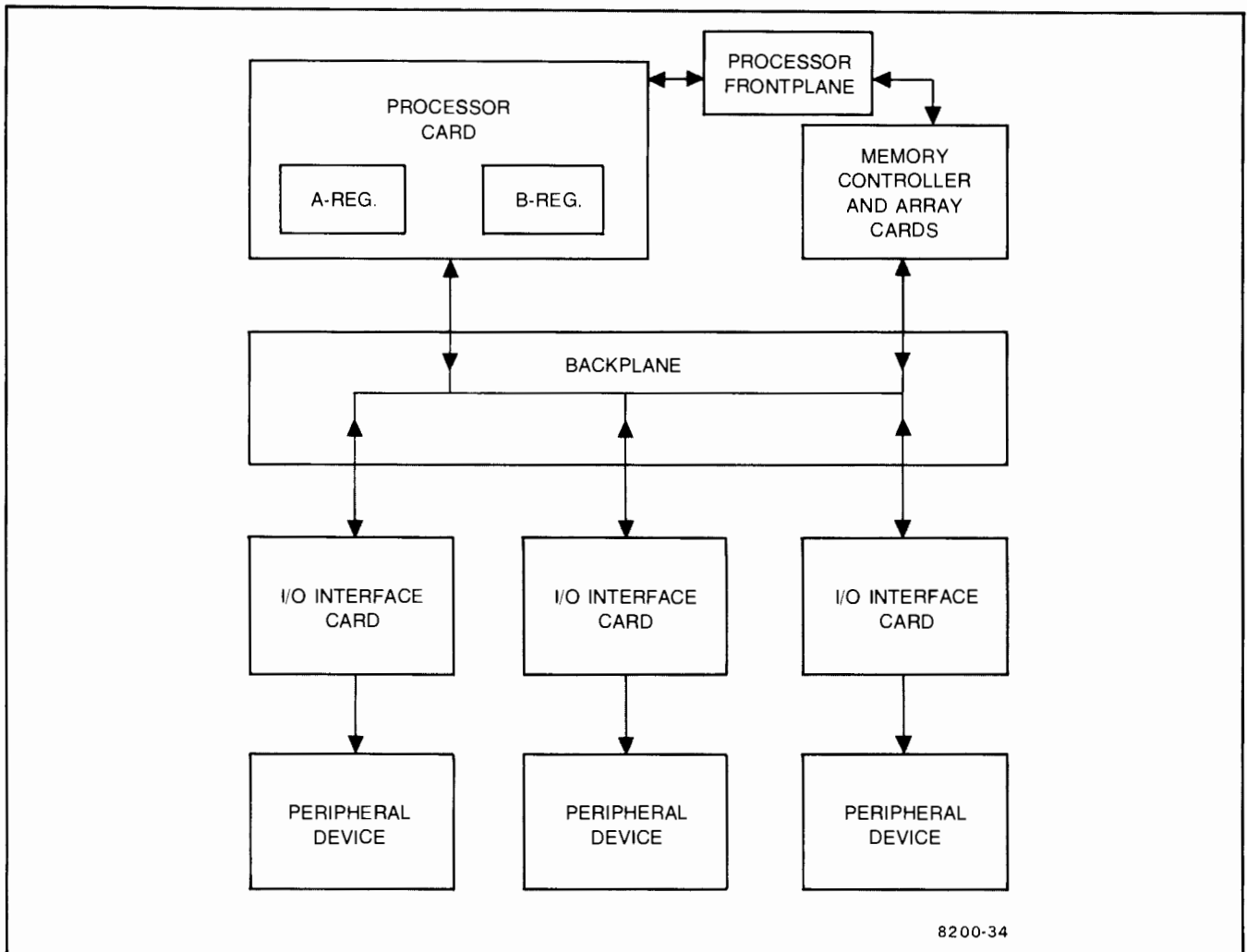

Figure 7-1. Input Output System

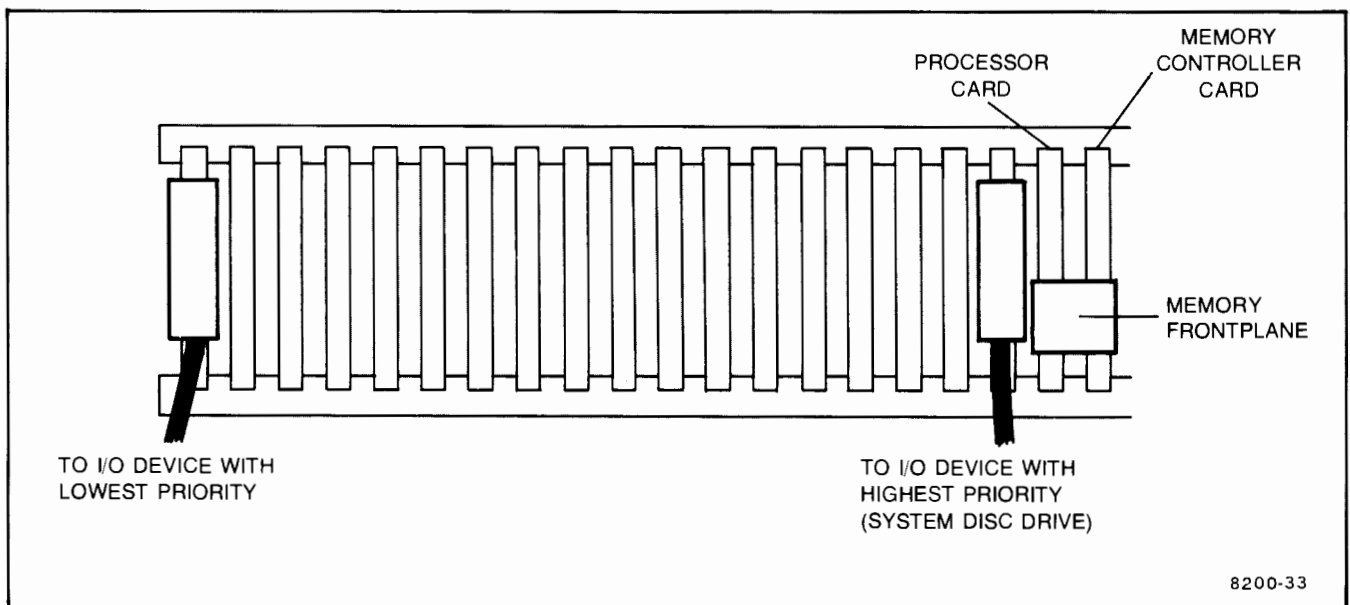

Figure 7-2. I/O Priority Assignment

Assume that the computer is running a CPU program when an interrupt from I/O channel 5 occurs (at reference time t_1), and that the card in slot 5 is assigned select code 22. With the I/O card supplying the select code as the memory address, a JSB instruction in the interrupt location for select code 22 causes a program jump to the service routine for the channel-5 device (select code 22). The JSB instruction automatically saves the return address (in a location which the programmer must reserve in his routine) for a later return to the CPU program.

The routine for channel 5 (select code 22) is still in progress when several other devices request service (set flag). First, channels 6 and 7 request simultaneously at time t_2 ; however, since neither one has priority over channel 5, their flags are ignored and channel 5 continues transfer. But at t_3 , a higher priority device on channel 3 requests service. This request interrupts the channel 5 transfer and causes the channel 3 transfer to begin. The JSB instruction saves the return address for return to the channel 5 routine.

During the channel 3 transfer, the channel 4 flag is set

(t_4). Since it has lower priority than channel 3, channel 4 must wait until the end of the channel 3 routine. And since the channel 3 routine, when it ends, contains a return address to the channel 5 routine, program control temporarily returns to channel 5 (even though the waiting channel 4 has higher priority). The JMP,I instruction used for the return inhibits all interrupts until fully executed. At the end of this short interval, the channel 4 interrupt request is granted.

When channel 4 has finished its routine, control is returned to channel 5, which at last has sufficient priority to complete its routine. Since channel 5 has been saving a return address in the main CPU program, it returns control to this point.

The two waiting interrupt requests from channels 6 and 7 are now enabled. Channel 6 has the higher priority and goes first. At the end of the channel 6 routine control is temporarily returned to the CPU program. Then the lowest priority channel (channel 7) interrupts and completes its transfer. Finally, control is returned to the CPU program, which resumes processing.

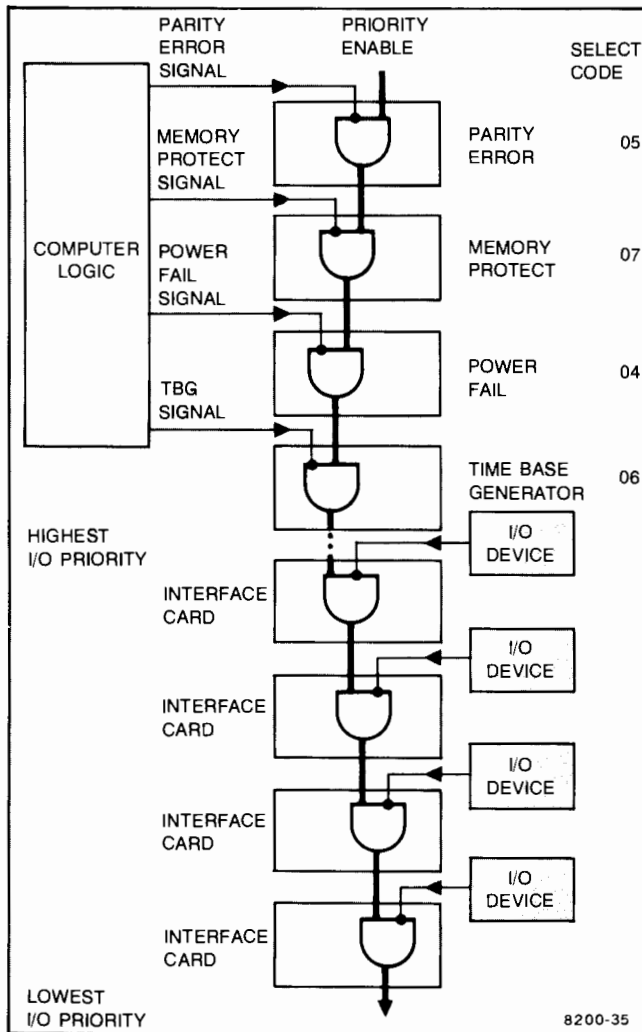

Figure 7-3. Priority Linkage (Simplified)

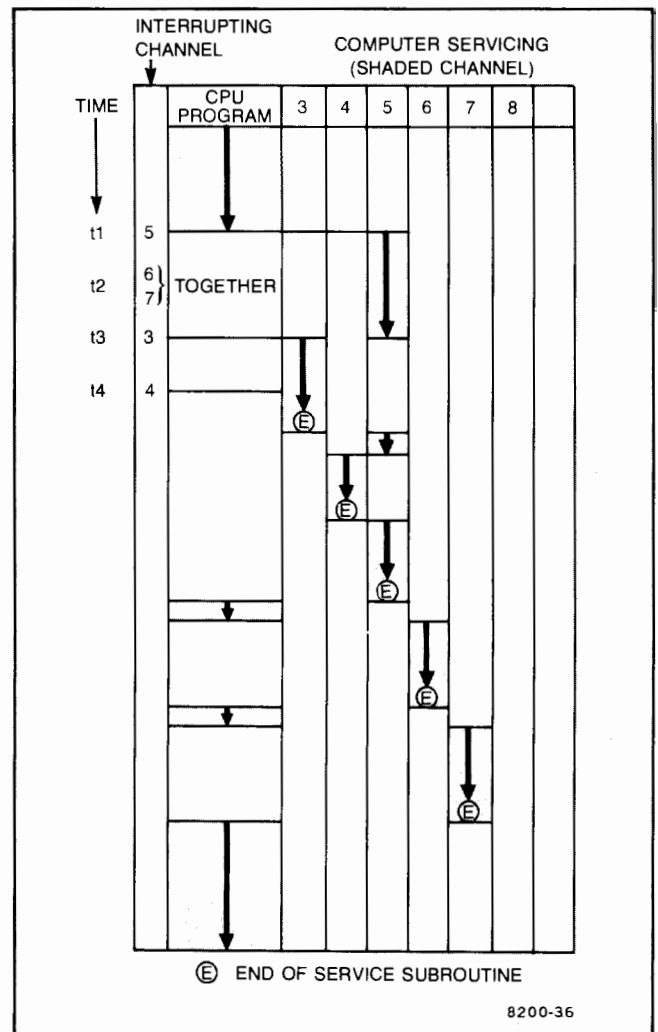

Figure 7-4. Interrupt Sequences

7-3. INTERFACE ELEMENTS

The interface card provides the communication link between the computer and one or more external devices. The interface card includes several basic elements which either the computer or the device can control in order to effect the necessary communication. These basic elements are the Global Register, control bits, flag bits, data buffer register, and control register. Other registers, associated only with DMA, are discussed in paragraph 7-9. The control and flag bits and the data buffer and control registers of an interface card can be addressed directly when the card's select code is in the Global Register (GR) and the GR is enabled. Refer to the interface card reference manuals for specific information on the data and control registers.

7-4. GLOBAL REGISTER

In the A-Series computers, the select code that is in the Global Register specifies which I/O card is enabled to execute I/O instructions. The Global Register (GR) is a register on each I/O card that can be loaded with the select code of any one of the I/O cards. (At any given time, the GR on all I/O cards is loaded with the same select code.) When the GR is enabled, an I/O instruction is executed only by the I/O card whose select code matches the select code in its GR. Also, the GR allows other registers on the selected I/O card to be accessed programmatically by I/O instructions. The Global Register on all I/O cards may be simultaneously loaded with an OTA/B 02 instruction, enabled with a CLF 02 instruction, and disabled with an STF 02 instruction.

7-5. CONTROL BITS

The control bits on an interface card are used to turn on a specific I/O function. In addition, a control bit must be set to allow the corresponding flag bit to interrupt. There are three control bits associated with each I/O select code: control 20, 21, and 30. Control 30 is the only control bit that can be accessed with or without the Global Register being enabled. When control 30 is set it generates an action command, allowing one word or character to be read or written. Control 20 and 21 can only be accessed when the Global Register is enabled. When control 20 is set it turns on DMA self-configuration. The setting of control 21 enables DMA transfers.

7-6. FLAG BITS

The flag bits (when set) are used primarily to interrupt or to signal completion of a task. Flag 30, the only flag bit accessible without using the Global Register, signals either one data element has been transferred or that an interrupting condition has been detected. There are three other flags, all of which must be accessed with the Global Register enabled. Flag 20 signals DMA self-configuring

transfer complete; flag 21 signals DMA transfer complete; and flag 22 signals parity error during DMA. The device cannot clear the flag bit. If the corresponding control bit is set, priority is high, and the interrupt system is enabled, then setting the flag bit will cause an interrupt to the location corresponding to the I/O card's select code.

7-7. DATA BUFFER REGISTER

The data buffer register (designated Register 30) is used for the intermediate storage of data during an I/O transfer. Typically, the data capacity is 16 bits.

7-8. CONTROL REGISTER

The control register (designated Register 31) enables a general purpose interface card to be configured for compatibility with a specific I/O device or to be programmed for particular modes of operation. The control register must be programmatically set up for a particular application. Refer to the interface card manuals for specific information on the control register.

7-9. DIRECT MEMORY ACCESS

The direct memory access (DMA) capability of each A/L-Series interface card provides a direct data path between memory and a peripheral device, making it practical to use DMA for most data transfers. The use of DMA to perform I/O data transfers reduces the number of interrupts from one per byte or word to one per complete DMA block transfer. (Maximum DMA block size is 65,536 bytes.)

The maximum DMA transfer rate is 4.27 million bytes per second; this is also the combined limit for DMA transfers by two or more I/O cards. Except when the DMA feature is operating at full bandwidth, the central processor can interleave memory cycles with the DMA operation. The DMA feature is provided by the following elements:

- a. The common backplane that links the processor, memory, and I/O cards;
- b. The capability of the I/O cards to execute I/O instructions; and
- c. The Global Register which:
 1. Enables only the I/O card whose select code is in the Global Register to execute I/O instructions, freeing the address bits of the I/O instruction; and
 2. Enables the I/O-instruction address bits to be used to access registers on the I/O card specified by the Global Register.

Each I/O card has four registers associated with DMA. Three of them must be loaded with control words that specify the DMA operation. The fourth register is used for a special type of DMA operation called self-configured DMA which is discussed later. All of these registers can be accessed only when the select code of the desired I/O card is in the Global Register. The DMA registers and their functions are as follows:

- a. Register 20, DMA Self-Configuration Address Register;
- b. Register 21 (for Control Word 1), DMA Control Register;
- c. Register 22 (for Control Word 2), DMA Address Register; and
- d. Register 23 (for Control Word 3), Word/Byte Count Register.

7-10. CONTROL WORD 1

Control Word 1 (CW1) must be loaded into Register 21 of the desired I/O card as part of the DMA initialization process. The general definitions of the bits in Control Word 1 are given in Figure 7-5. Note that the requirements of individual I/O cards may vary slightly from the general definitions and that it is necessary to refer to the I/O card reference manuals for specific programming information.

7-11. CONTROL WORD 2

Control Word 2 (CW2) loads into Register 22 the address of the first memory location to be read from or stored into when the DMA operation is initiated. The most significant bit, bit 15, is not used by the DMA control logic; when CW2 is read for status, bit 15 is the complement of bit 7 in CW1 (Figure 7-5).

7-12. CONTROL WORD 3

Control Word 3 (CW3) loads into Register 23 the two's-complement number of data elements to be transferred by DMA. Data elements may be either words or bytes as specified by bit 13 of CW1 (Figure 7-5). The end of a DMA data transfer is indicated by the transition from -1 to 0 of the value in Register 23 (the Word/Byte Count Register); this causes the I/O card to generate a completion interrupt if enabled to do so by Control Word 1. (A DMA transfer can also be terminated in other ways as described in the interface card manuals.)

7-13. DMA TRANSFER INITIALIZATION

A DMA data transfer is started by:

- a. Loading the Global Register with the select code of the desired I/O card;
- b. Loading the three DMA registers: DMA control into Register 21, DMA address into Register 22, and word/byte count into Register 23;
- c. Loading the control register (Register 31) of the I/O card (described in the individual interface card reference manuals); and
- d. Issuing an STC instruction to Register 21 (DMA Control Register).

A typical programming sequence to configure the DMA logic for a DMA transfer is as follows:

LDA SC	Load select code
OTA 2,C	Set up and enable Global Register
CLC 21B	Disable DMA transfers for this card
LDA CW1	Load DMA control word
OTA 21B	Output DMA control word
LDA CW2	Load DMA starting address
OTA 22B	Output DMA starting address
LDA CW3	Load DMA word/byte count
OTA 23B	Output DMA word/byte count
LDA CNTL	Load I/O card control word
OTA 31B	Output I/O card control word
STC 21B,C	Start DMA and device

(continue any other processing)

7-14. SELF-CONFIGURED DMA

Each I/O card also has logic that can automatically load the DMA registers discussed previously with the DMA control words from sequential locations in memory. This process is performed by using the I/O card's Register 20, the Self-Configuration Register. The DMA self-configuration feature is initialized by setting the value of Register 20 to the memory address of a list of DMA "triplets" or "quadruplets".

A triplet is of the form: DMA control word, DMA transfer address, and word/byte count. The triplet words are the words to be loaded into Registers 21, 22, and 23, respectively. A quadruplet is of the form: DMA control word, I/O-card control word, transfer address, and word/byte count. Bit 8 of the DMA control word (Control Word 1) determines whether a triplet or quadruplet is loaded. (A quadruplet is used only when the I/O-card control word must be changed; refer to the interface card manuals for detailed information.) As each register is loaded, the contents of Register 20 are incremented, leaving it pointing to the memory location to be loaded into the next register.

DMA self-configuration can be chained to enable consecutive DMA transfers via the same I/O card with a minimum of interrupts. If bit 15 of Control Word 1 in a triplet (or quadruplet) is a logic 1, the DMA registers will

15	14	13	12	11	10	9	8	7	6	5	4	0
CONT	DVCMD	BYTE	RES	CINT	REM	FOUR	AUTO	IN	Various		ADDR EXT BUS	

CONT (Continue), bit 15.

Bit 15 = 1: Enable a DMA re-configuration upon completion of a self-configured DMA transfer.

Bit 15 = 0: Stop DMA after current transfer.

DVCMD (Device Command), bit 14.

Bit 14 = 1: Issue a Device Command signal for each data element transferred.

Bit 14 = 0: No Device Command signal issued.

BYTE (Byte/word transfer), bit 13.

Bit 13 = 1: Conduct DMA transfer in byte mode.

Bit 13 = 0: Conduct DMA transfer in word mode.

RES (Residue), bit 12.

Bit 12 = 1: Write word/byte count back into memory.

Bit 12 = 0: Word/byte count is not written.

CINT (Completion Interrupt), bit 11.

Bit 11 = 1: Inhibit DMA completion interrupt.

Bit 11 = 0: Request completion interrupt when word/byte count goes from -1 to 0 and bit 15 equals 0.

REM (Remote), bit 10.

Bit 10 = 1: Enable remote (non-standard) memory for DMA transfer.

Bit 10 = 0: Remote memory not enabled.

FOUR (Fetch four control words), bit 9.

Bit 9 = 1: Causes DMA self-configuration to fetch four control words; i.e., three DMA control words and one I/O card control word.

Bit 9 = 0: Fetch three control words for DMA self-configuration.

AUTO (Automatic), bit 8. This bit is read only during self-configured DMA.

Bit 8 = 1: Initiate first data transfer once DMA is configured to output, without waiting for an SRQ. For input transfers, enable a Device Command signal after the last data element is transferred.

Bit 8 = 0: For output transfers, wait for a Service Request (SRQ) signal before performing the first transfer. For input transfers, the last data element is not followed by a Device Command.

IN (Transfer In), bit 7.

Bit 7 = 1: Perform DMA transfer from I/O device to memory.

Bit 7 = 0: Perform DMA transfer from memory to I/O device.

Various, bits 5 and 6, User definable.

ADDR EXT BUS, bits 4-0

These five bits allow DMA accesses to physical memory by referencing one map set of 32 registers each.

8200-53

Figure 7-5. General Bit Definitions for Control Word 1

be loaded with the next triplet or quadruplet in memory (as pointed to by Register 20) upon completion of the current DMA block transfer. When bit 15 (and bit 11) is a logic 0, the current DMA block transfer is followed by a completion interrupt if enabled by Control Word 1.

7-15. DMA DATA TRANSFER

Figure 7-6 illustrates, in general, the sequence of operations for a DMA input data transfer (the minor differences for an output transfer are explained in text). Note that the Global Register has been enabled and loaded with the I/O card's select code.

The initialization routine sets up the DMA control registers on the I/O card (1) and issues the start command (STC 21,C) to the DMA Control Bit (Control 21). (If the operation is an output, the I/O card buffer is also loaded at this time.) The DMA logic is now turned on and the computer program continues with other instructions.

Setting the DMA Control bit (2) causes the I/O card to send a Start signal (with a data word if it is an output transfer) to the external device (3). The device goes through a read or write cycle and returns a Done signal (with a data word if it is an input transfer). The Done signal (4) requests the DMA logic (5) to transfer a word into (or out of) memory (6). The process now loops back to step 3 to transfer the next word.

After the specified number of words has been transferred, the DMA logic generates a completion interrupt (7). The program control is now forced to a completion routine (8), the content of which is the programmer's responsibility.

For more detailed information on DMA, refer to the I/O interfacing guide, part no. 02103-90005.

7-16. NON-DMA DATA TRANSFER

The following paragraphs describe how data is transferred between memory and input/output devices without using DMA. The sequences presented are simplified in order to present an overall view without the involvement of software operating systems or device drivers.

7-17. INPUT DATA TRANSFER (INTERRUPT METHOD)

Figure 7-7 illustrates the sequence of events required to input data using the interrupt method. Note that some operations are under control of the computer program (programmer's responsibility) and some of the operations are automatic. Note also that the Global Register has been loaded and enabled and the I/O card's control register has been loaded.

The operations begin (1) with the programmed instruction STC 30,C which sets the Control bit (Control 30) and

clears the Flag bit (Flag 30) on the I/O card. Since the next few operations are under control of the hardware, the computer program may continue the execution of other instructions. Setting the Control bit causes the card to output a Start signal (2) to the device, which reads out a data character and asserts the Done signal (3).

The device Done signal sets the Flag bit, which in turn generates an interrupt (4) provided that the interrupt conditions are met; i.e., the interrupt system must be on (STF 00 previously given), no higher priority interrupt is pending, and the Control bit is set (done in step 1).

The interrupt causes the current computer program to be suspended and control is transferred to a service subroutine (5). It is the programmer's responsibility to provide the linkage between the interrupt location (which agrees with the select code) and the service subroutine. It is also the programmer's responsibility to include in his service subroutine the instructions for processing the data (loading into an accumulator, manipulating if necessary, and storing into memory).

The subroutine may then issue further STC 30,C instructions to transfer additional data characters. One of the final instructions in the service subroutine must be CLC 30,C. This step (6) restores the interrupt capability to lower priority devices and returns the I/O card to its static "reset" condition (Control clear and Flag clear). This condition is initially established by the computer at power turn-on and it is the programmer's responsibility to return the I/O card to the same condition on the completion of each data transfer operation. At the end of the subroutine, control is returned to the interrupted program via previously established linkages.

The subroutine may then output further data to the I/O card and reissue the STC 30,C command for additional data character transfers. One of the final instructions in the service subroutine must be a clear control (CLC 30,C). This step (7) allows lower priority devices to interrupt and restores the I/O card to its static "reset" condition (Control clear and Flag clear). At the end of the subroutine, control is returned to the interrupted program via the previously established linkages.

7-18. OUTPUT DATA TRANSFER (INTERRUPT METHOD)

Figure 7-8 illustrates the sequence of events required to output data using the interrupt method. Again note the distinction between programmed and automatic operations. Note also that the Global Register has been loaded and enabled and that the I/O card's control register has been loaded. It is assumed that the data to be transferred has been loaded into the A-register and is in a form suitable for output.

The output operation begins with a programmed instruction (OTA 30) to transfer the contents of the

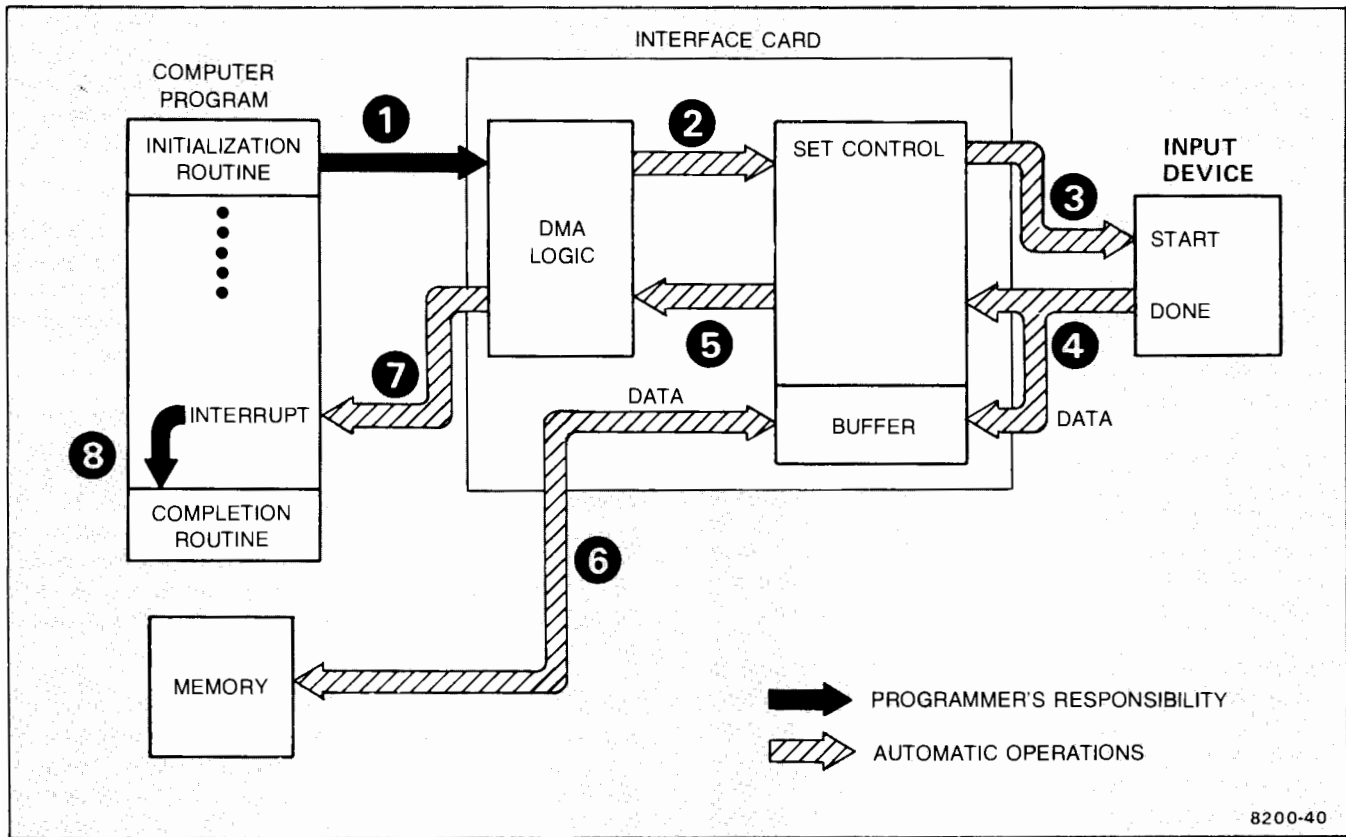

Figure 7-6. DMA Input Data Transfer

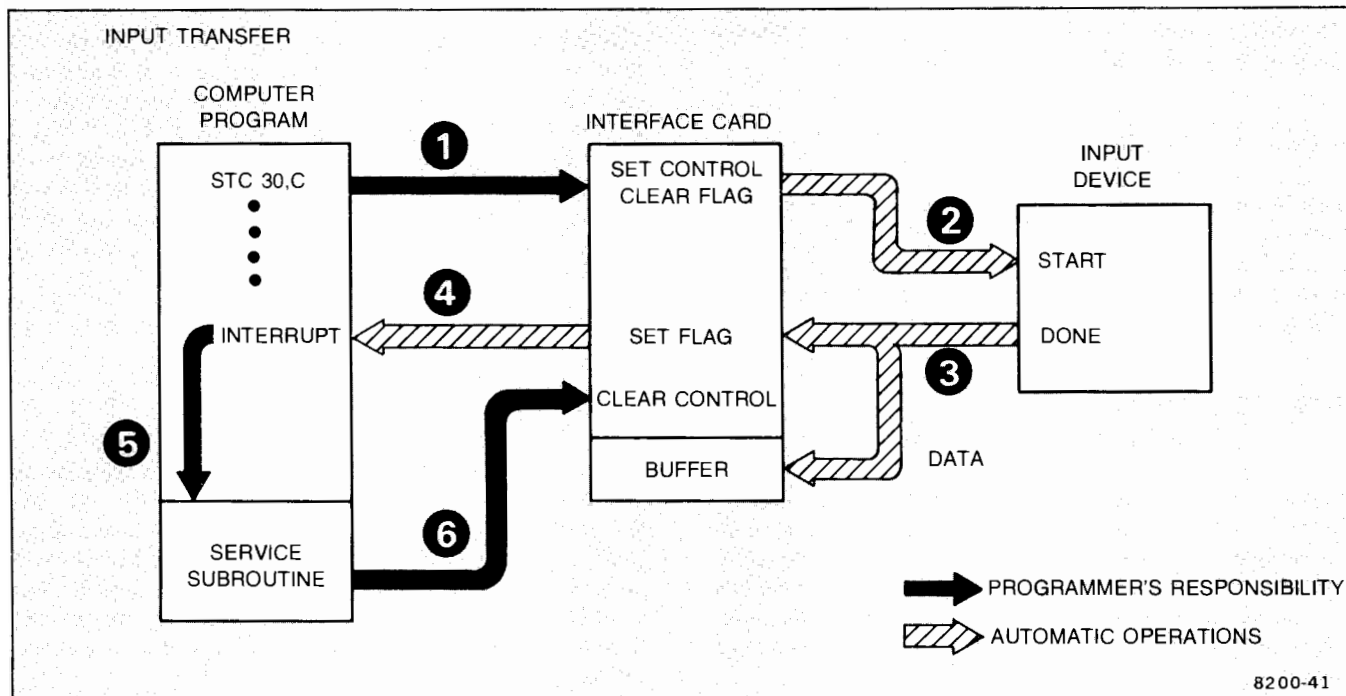

Figure 7-7. Input Data Transfer (Interrupt Method)

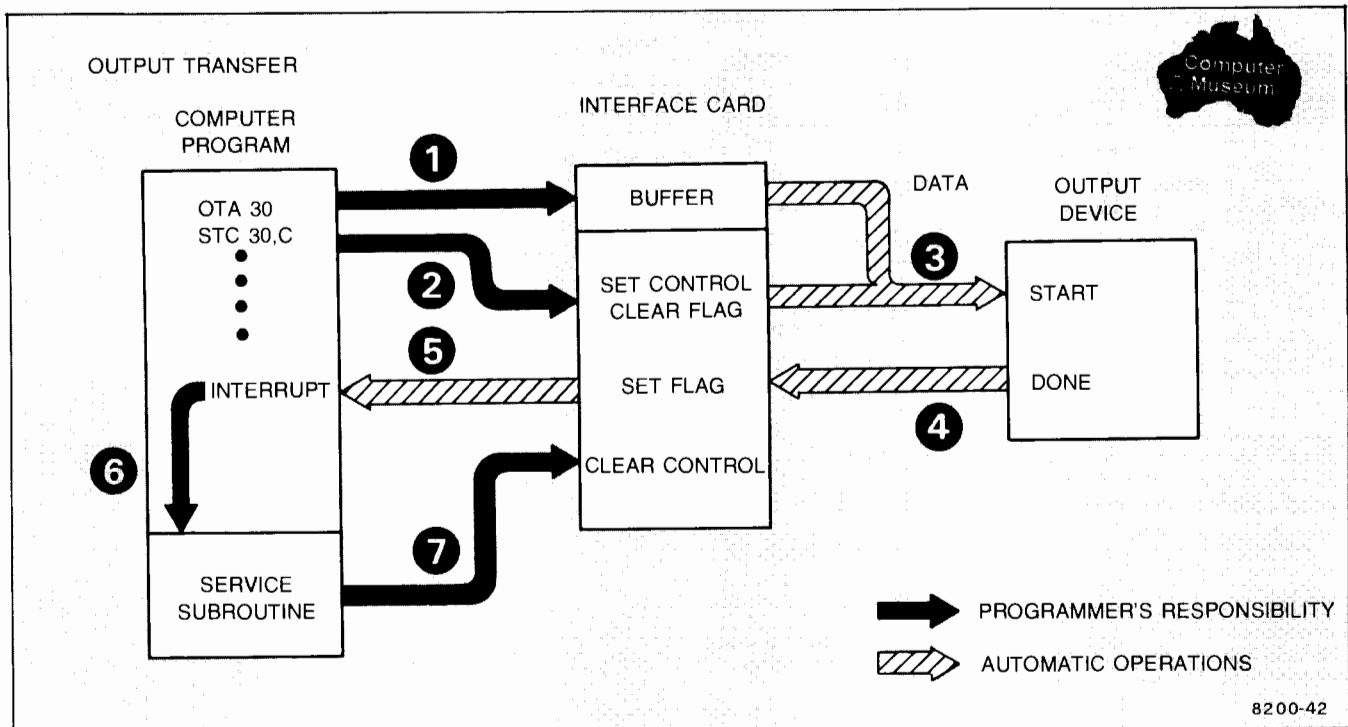

Figure 7-8. Output Data Transfer (Interrupt Method)

A-register to the I/O card buffer (1). This is followed (2) by the instruction STC 30,C which sets the Control bit (Control 30) and clears the Flag bit (Flag 30) on the I/O card. Since the next few instructions are under control of the hardware, the computer program may continue the execution of other instructions. Setting the Control bit causes the card to output the buffered data and a Start signal (3) to the device, which writes (e.g., records, stores, etc.) the data character and asserts the Done signal (4).

The device Done signal sets the card's Flag bit, which in turn generates an interrupt (5) provided that the interrupt system is on, priority is high, and the Control bit is set (done in step 2). The interrupt causes the current computer program to be suspended and control is transferred to a service subroutine (6). It is the programmer's responsibility to provide the linkage between the interrupt location (which agrees with the select code) and the service subroutine. The detailed contents of the subroutine are also the programmer's responsibility and the contents will vary with the type of device.

The subroutine may then output further data to the I/O card and reissue the STC 30,C command for additional data character transfers. One of the final instructions in the service subroutine must be a clear control (CLC 30,C). This step (7) allows lower priority devices to interrupt and restores the I/O card to its static "reset" condition (Control clear and Flag clear). At the end of the subroutine, control is returned to the interrupted program via the previously established linkages.

7-19. NON-INTERRUPT DATA TRANSFER

It is also possible to transfer data without using the interrupt system. This involves a "wait-for-flag" method in which the computer commands the device to operate and then waits for the completion response. In using this method to transfer data, computer time is relatively unimportant. It is assumed that the interrupt system is turned off (STF 00 not previously given). It is also assumed that the Global Register has been loaded and enabled and that the I/O card's control register has been loaded. As shown in Table 7-1, the programming is very simple; each of the routines will transfer one word or character of data.

7-20. INPUT. As described in paragraph 7-17, an STC 30,C instruction begins the operation by commanding the device to read one word or character. The computer then goes into a waiting loop, repeatedly checking the status of the Flag bit (Flag 30). If the Flag bit is not set, the JMP *-1 instruction causes a jump back to the SFS instruction. (The *-1 operand is assembler notation for "this location minus one.") When the Flag bit is set, the skip condition for SFS is met and the JMP instruction is skipped. The computer thus exits from the waiting loop and the LIA 30 instruction loads the device input data into the A-register.

7-21. OUTPUT. The first step, which transfers the data to the I/O card buffer, is the OTA 30 instruction. Then STC 30,C commands the device to operate and accept the data.

Table 7-1. Noninterrupt Transfer Routines

INSTRUCTIONS	COMMENTS
INPUT ROUTINE	
STC 30,C	Start device
SFS 30	Is input ready?
JMP *-1	No, repeat previous instruction
LIA 30	Yes, load input into A-register
OUTPUT ROUTINE	
OTB 30	Output data to I/O card's data register
STC 30,C	Start device
SFS 30	Has device accepted the data?
JMP *-1	No, repeat previous instruction
NOP	Yes, proceed

The computer then goes into a waiting loop as described in the preceding paragraph. When the Flag bit becomes set, indicating that the device has accepted the output data, the computer exits from the loop. (The final NOP is for illustration purposes only.)

7-22. DIAGNOSE MODES

A diagnose mode allows the I/O cards to be accessed for diagnostic or test purposes. A diagnose mode is established when an OTA/B 2 instruction (output to the Global Register) is executed with the A- or B-register value equal to one through seven. (The diagnose mode is terminated when an OTA/B 2 instruction is executed with the A- or B-register equal to zero.) When establishing a diagnose mode the current contents of the Global Register (GR) is not altered. The diagnose mode can be on an individual I/O card or on all I/O cards. If the GR is disabled then all I/O cards accept the diagnose mode. If the GR is enabled, only the I/O card whose select code is in the GR will accept the diagnose mode. Diagnose Mode 7 is used to disable any service request (SRQ) signal coming into the I/O chip which may cause DMA to cycle during a test. (Mode 7 can be disabled only by a CRS signal (CLC 0).) Diagnose Modes 4 through 6 are reserved for future definition. Diagnose Modes 1 through 3 are described in the following paragraphs.

7-23. DIAGNOSE MODE 1

When an OTA/B 2 instruction is executed with the A- or B-register equal to one each I/O card responds by turning off priority to the next I/O card. When the instruction is

complete the only I/O card receiving priority will be the highest priority I/O card (i.e., the one directly under the processor card. When a subsequent LIA/B 2 instruction is executed, the I/O card receiving priority sets the A- or B-register equal to its select code and identification data (ID) and passes priority to the next I/O card. Having responded once it will not respond again unless Mode 1 is established again. The next LIA/B 2 executed sets the A- or B-register equal to the second I/O card's select code and

Table 7-2. Diagnose Mode 1

A/B BITS	MEANING
15	Intelligent interface
14	Interface card type identification number
13	
12	
11	
10	
9	Interface card revision code
8	
7	
6	Interface card select code
5	
0	

ID. The second I/O card at completion of the instruction passes priority to the next I/O card. This process continues until the last I/O card responds. After the last I/O card responds the next LIA/B 2 will not affect the A- or B-register and therefore can be detected as a no response. (An OTA/B 2 with the A- or B-register equal to 0 terminates this sequence.)

Table 7-3. Diagnose Mode 2

A/B BITS	MEANING
15	Always zero
14	
13	
12	1 = Break feature is enabled
11	1 = Receiving interrupt priority
10	Always zero
9	Control bit
8	Flag bit
7	1 = Global register equals select code of interface card
6	Global register enabled/disabled
5	Current global register value
4	
3	
2	
1	
0	

Mode 1 can also be used to retrieve the select code and ID of a desired I/O card without going through the priority process. This is accomplished by establishing Mode 1 and then executing an LIA/B xx, where xx is the I/O card select code. This procedure will not modify a priority sequence already in process. The Mode 1 select code and ID format is shown in Table 7-2.

7-24. DIAGNOSE MODE 2

Diagnose Mode 2 causes an I/O card to respond to an LIA/B 2 instruction in the same manner as in Mode 1 except that the data set into the A- or B-register is as shown in Table 7-3.

7-25. DIAGNOSE MODE 3

Diagnose Mode 3 allows an I/O chip to do a DMA transfer without affecting the I/O card. When Mode 3 is entered the I/O chip does a DMA input transfer of the data in the configuration address register to the location in memory pointed to by the DMA address register. The configuration address register is incremented after each transfer so that the data can be verified. The transfer continues until the DMA count is incremented to zero. Mode 3 also prevents any STC instructions from generating a device command to the I/O card.

CHARACTER CODES

ASCII Character	First Character Octal Equivalent	Second Character Octal Equivalent
A	040400	000101
B	041000	000102
C	041400	000103
D	042000	000104
E	042400	000105
F	043000	000106
G	043400	000107
H	044000	000110
I	044400	000111
J	045000	000112
K	045400	000113
L	046000	000114
M	046400	000115
N	047000	000116
O	047400	000117
P	050000	000120
Q	050400	000121
R	051000	000122
S	051400	000123
T	052000	000124
U	052400	000125
V	053000	000126
W	053400	000127
X	054000	000130
Y	054400	000131
Z	055000	000132
a	060400	000141
b	061000	000142
c	061400	000143
d	062000	000144
e	062400	000145
f	063000	000146
g	063400	000147
h	064000	000150
i	064400	000151
j	065000	000152
k	065400	000153
l	066000	000154
m	066400	000155
n	067000	000156
o	067400	000157
p	070000	000160
q	070400	000161
r	071000	000162
s	071400	000163
t	072000	000164
u	072400	000165
v	073000	000166
w	073400	000167
x	074000	000170
y	074400	000171
z	075000	000172
0	030000	000060
1	030400	000061
2	031000	000062
3	031400	000063
4	032000	000064
5	032400	000065
6	033000	000066
7	033400	000067
8	034000	000070
9	034400	000071
NUL	000000	000000
SOH	000400	000001
STX	001000	000002
ETX	001400	000003
EOT	002000	000004
ENQ	002400	000005

ASCII Character	First Character Octal Equivalent	Second Character Octal Equivalent
ACK	003000	000006
BEL	003400	000007
BS	004000	000010
HT	004400	000011
LF	005000	000012
VT	005400	000013
FF	006000	000014
CR	006400	000015
SO	007000	000016
SI	007400	000017
DLE	010000	000020
DC1	010400	000021
DC2	011000	000022
DC3	011400	000023
DC4	012000	000024
NAK	012400	000025
SYN	013000	000026
ETB	013400	000027
CAN	014000	000030
EM	014400	000031
SUB	015000	000032
ESC	015400	000033
FS	016000	000034
GS	016400	000035
RS	017000	000036
US	017400	000037
SPACE	020000	000040
!	020400	000041
"	021000	000042
#	021400	000043
\$	022000	000044
%	022400	000045
&	023000	000046
'	023400	000047
(024000	000050
)	024400	000051
*	025000	000052
+	025400	000053
,	026000	000054
-	026400	000055
.	027000	000056
/	027400	000057
:	035000	000072
;	035400	000073
<	036000	000074
=	036400	000075
>	037000	000076
?	037400	000077
@	040000	000100
[055400	000133
\	056000	000134
]	056400	000135
^	057000	000136
_	057400	000137
`	060000	000140
{	075400	000173
	076000	000174
}	076400	000175
~	077000	000176
DEL	077400	000177

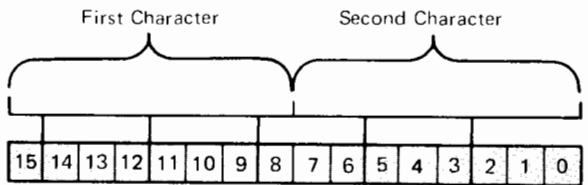

OCTAL ARITHMETIC

ADDITION

TABLE

0	01	02	03	04	05	06	07
1	02	03	04	05	06	07	10
2	03	04	05	06	07	10	11
3	04	05	06	07	10	11	12
4	05	06	07	10	11	12	13
5	06	07	10	11	12	13	14
6	07	10	11	12	13	14	15
7	10	11	12	13	14	15	16

EXAMPLE

```

Add:    3677  OCTAL
      + 1331  OCTAL
      -----
      (111-) CARRIES
      -----
      5230  OCTAL

```

MULTIPLICATION

TABLE

1	02	03	04	05	06	07
2	04	06	10	12	14	16
3	06	11	14	17	22	25
4	10	14	20	24	30	34
5	12	17	24	31	36	43
6	14	22	30	36	44	52
7	16	25	34	43	52	61

EXAMPLE

```

Multiply: 657  OCTAL
          × 54  OCTAL
          -----
          3274
          4153
          -----
          45024  OCTAL

```

(Reminder: add in octal)

COMPLEMENT

To find the two's complement form of an octal number. (Same procedure whether converting from positive to negative or negative to positive.)

RULE

1. Subtract from the maximum representable octal value.
2. Add one.

EXAMPLE

Two's complement of 556_8

```

      177777
      - 000556
      -----
      177221
      + 1
      -----
      1772228

```

OCTAL/DECIMAL CONVERSIONS

OCTAL TO DECIMAL

TABLE

OCTAL	DECIMAL
0-7	0-7
10-17	8-15
20-27	16-23
30-37	24-31
40-47	32-39
50-57	40-47
60-67	48-55
70-77	56-63
100	64
200	128
400	256
1000	512
2000	1024
4000	2048
10000	4096
20000	8192
40000	16384
77777	32767

EXAMPLE

Convert 463_8 to a decimal integer.

$$\begin{aligned}
 400_8 &= 256_{10} \\
 60_8 &= 48_{10} \\
 3_8 &= \underline{3}_{10} \\
 &307 \text{ decimal}
 \end{aligned}$$

DECIMAL TO OCTAL

TABLE

DECIMAL	OCTAL
1	1
10	12
20	24
40	50
100	144
200	310
500	764
1000	1750
2000	3720
5000	11610
10000	23420
20000	47040
32767	77777

EXAMPLE

Convert 5229_{10} to an octal integer.

$$\begin{aligned}
 5000_{10} &= 11610_8 \\
 200_{10} &= 310_8 \\
 20_{10} &= 24_8 \\
 9_{10} &= \underline{11}_8 \\
 &12155_8 \\
 &\uparrow \\
 &\text{(Reminder: add in octal)}
 \end{aligned}$$

NEGATIVE DECIMAL TO TWO'S COMPLEMENT OCTAL

TABLE

DECIMAL	2's COMP
-1	177777
-10	177766
-20	177754
-40	177730
-100	177634
-200	177470
-500	177014
-1000	176030
-2000	174060
-5000	166170
-10000	154360
-20000	130740
-32768	100000

EXAMPLE

Convert -629_{10} to two's complement octal.

$$\begin{aligned}
 -500_{10} &= 177014_8 \\
 -100_{10} &= 177634_8 \\
 -20_{10} &= 177754_8 \text{ (Add in octal)} \\
 -9_{10} &= \underline{177767}_8 \\
 &176613_8
 \end{aligned}$$

For reverse conversion (two's complement octal to negative decimal):

1. Complement, using procedure on facing page.
2. Convert to decimal, using OCTAL TO DECIMAL table.

MATHEMATICAL EQUIVALENTS

2 ± n IN DECIMAL

2 ⁿ	n	2 ⁻ⁿ				
			65 536	16	0.00001	52587 89062 5
1	0	1.0	131 072	17	0.00000	76293 94531 25
2	1	0.5				
4	2	0.25	262 144	18	0.00000	38146 97265 625
			524 288	19	0.00000	19073 48632 8125
8	3	0.125	1 048 576	20	0.00000	09536 74316 40625
16	4	0.0625				
32	5	0.03125	2 097 152	21	0.00000	04768 37158 20312 5
			4 194 304	22	0.00000	02384 18579 10156 25
64	6	0.01562 5	8 388 608	23	0.00000	01192 09289 55078 125
128	7	0.00781 25				
256	8	0.00390 625	16 777 216	24	0.00000	00596 04644 77539 0625
			33 554 432	25	0.00000	00298 02322 38769 53125
512	9	0.00195 3125	67 108 864	26	0.00000	00149 01161 19384 76562 5
1 024	10	0.00097 65625				
2 048	11	0.00048 82812 5	134 217 728	27	0.00000	00074 50580 59692 38281 25
			268 435 456	28	0.00000	00037 25290 29846 19140 625
4 096	12	0.00024 41406 25	536 870 912	29	0.00000	00018 62645 14923 09570 3125
8 192	13	0.00012 20703 125				
16 384	14	0.00006 10351 5625	1 073 741 824	30	0.00000	00009 31322 57461 54785 15625
			2 147 483 648	31	0.00000	00004 65661 28730 77392 57812 5
32 768	15	0.00003 05175 78125	4 294 967 296	32	0.00000	00002 32830 64365 38696 28906 25

10 ± n IN OCTAL

10 ⁿ	n	10 ⁻ⁿ		10 ⁿ	n	10 ⁻ⁿ
1	0	1.000 000 000 000 000 00		112 402 762 000	10	0.000 000 000 006 676 337 66
12	1	0.063 146 314 631 463 146 31		1 351 035 564 000	11	0.000 000 000 000 537 657 77
144	2	0.005 075 341 217 270 243 66		16 432 451 210 000	12	0.000 000 000 000 043 136 32
1 750	3	0.000 406 111 564 570 651 77		221 411 634 520 000	13	0.000 000 000 000 003 411 35
23 420	4	0.000 032 155 613 530 704 15		2 657 142 036 440 000	14	0.000 000 000 000 000 264 11
303 240	5	0.000 002 476 132 610 706 64		34 327 724 461 500 000	15	0.000 000 000 000 000 022 01
3 641 100	6	0.000 000 206 157 364 055 37		434 157 115 760 200 000	16	0.000 000 000 000 000 001 63
46 113 200	7	0.000 000 015 327 745 152 75		5 432 127 413 542 400 000	17	0.000 000 000 000 000 000 14
575 360 400	8	0.000 000 001 257 143 561 06		67 405 553 164 731 000 000	18	0.000 000 000 000 000 000 01
7 346 545 000	9	0.000 000 000 104 560 276 41				

MATHEMATICAL EQUIVALENTS

2^x IN DECIMAL

x	2^x	x	2^x	x	2^x
0.001	1.00069 33874 62581	0.01	1.00695 55500 56719	0.1	1.07177 34625 36293
0.002	1.00138 72557 11335	0.02	1.01395 94797 90029	0.2	1.14869 83549 97035
0.003	1.00208 16050 79633	0.03	1.02101 21257 07193	0.3	1.23114 44133 44916
0.004	1.00277 64359 01078	0.04	1.02811 38266 56067	0.4	1.31950 79107 72894
0.005	1.00347 17485 09503	0.05	1.03526 49238 41377	0.5	1.41421 35623 73095
0.006	1.00416 75432 38973	0.06	1.04246 57608 41121	0.6	1.51571 65665 10398
0.007	1.00486 38204 23785	0.07	1.04971 66836 23067	0.7	1.62450 47927 12471
0.008	1.00556 05803 98468	0.08	1.05701 80405 61380	0.8	1.74110 11265 92248
0.009	1.00625 78234 97782	0.09	1.06437 01824 53360	0.9	1.86606 59830 73615

$\eta \log_{10} 2, \eta \log_2 10$ IN OCTAL

η	$\eta \log_{10} 2$	$\eta \log_2 10$	η	$\eta \log_{10} 2$	$\eta \log_2 10$
1	0.30102 99957	3.32192 80949	6	1.80617 99740	19.93156 85693
2	0.60205 99913	6.64385 61898	7	2.10720 99696	23.25349 66642
3	0.90308 99870	9.96578 42847	8	2.40823 99653	26.57542 47591
4	1.20411 99827	13.28771 23795	9	2.70926 99610	29.89735 28540
5	1.50514 99783	16.60964 04744	10	3.01029 99566	33.21928 09489

MATHEMATICAL CONSTANTS IN OCTAL SCALE

$\pi = (3.11037 552421)_{(8)}$	$e = (2.55760 521305)_{(8)}$	$\gamma = (0.44742 147707)_{(8)}$
$\pi^{-1} = (0.24276 301556)_{(8)}$	$e^{-1} = (0.27426 530661)_{(8)}$	$\ln \gamma = -(0.43127 233602)_{(8)}$
$\sqrt{\pi} = (1.61337 611067)_{(8)}$	$\sqrt{e} = (1.51411 230704)_{(8)}$	$\log_2 \gamma = -(0.62573 030645)_{(8)}$
$\ln \pi = (1.11206 404435)_{(8)}$	$\log_{10} e = (0.33626 754251)_{(8)}$	$\sqrt{2} = (1.32404 746320)_{(8)}$
$\log_2 \pi = (1.51544 163223)_{(8)}$	$\log_2 e = (1.34252 166245)_{(8)}$	$\ln 2 = (0.54271 027760)_{(8)}$
$\sqrt{10} = (3.12305 407267)_{(8)}$	$\log_2 10 = (3.24464 741136)_{(8)}$	$\ln 10 = (2.23273 067355)_{(8)}$

OCTAL COMBINING TABLES

MEMORY REFERENCE INSTRUCTIONS

INDIRECT ADDRESSING

Refer to octal instruction codes given on the following page.

To combine code for indirect addressing, merge "100000" with octal instruction code.

REGISTER REFERENCE INSTRUCTIONS

SHIFT-ROTATE GROUP (SRG)

1. select to operate A or B.
2. select 1 to 4 instructions, not more than one from each column.
3. combine octal codes (leading zeros omitted) by inclusive or.
4. order of execution is from column 1 to column 4.

A OPERATIONS

1	2	3	4
ALS (1000)	CLE (40)	SLA (10)	ALS (20)
ARS (1100)			ARS (21)
RAL (1200)			RAL (22)
RAR (1300)			RAR (23)
ALR (1400)			ALR (24)
ERA (1500)			ERA (25)
ELA (1600)			ELA (26)
ALF (1700)			ALF (27)

B OPERATIONS

1	2	3	4
BLS (5000)	CLE (4040)	SLB (4010)	BLS (4020)
BRS (5100)			BRS (4021)
RBL (5200)			RBL (4022)
RBR (5300)			RBR (4023)
BLR (5400)			BLR (4024)
ERB (5500)			ERB (4025)
ELB (5600)			ELB (4026)
BLF (5700)			BLF (4027)

ALTER-SKIP GROUP (ASG)

1. select to operate on A or B.
2. select 1 to 8 instructions, not more than one from each column.
3. combine octal codes (leading zeros omitted) by inclusive or.
4. order of execution is from column 1 to column 8.

A OPERATIONS

1	2	3	4
CLA (2400)	SEZ (2040)	CLE (2100)	SSA (2020)
CMA (3000)		CME (2200)	
CCA (3400)		CCE (2300)	

5	6	7	8
SLA (2010)	INA (2004)	SZA (2002)	RSS (2001)

B OPERATIONS

1	2	3	4
CLB (6400)	SEZ (6040)	CLE (6100)	SSB (6020)
CMB (7000)		CME (6200)	
CCB (7400)		CCE (6300)	

5	6	7	8
SLB (6010)	INB (6004)	SZB (6002)	RSS (6001)

INPUT/OUTPUT INSTRUCTIONS

CLEAR FLAG

Refer to octal instruction codes given on the following page.

To clear flag after execution (instead of holding flag), merge "001000" with octal instruction code.

INSTRUCTION CODES IN OCTAL

Memory Reference		Input/Output		Ext. Inst. Group		Language Inst. Set		Dynamic Map Syst.	
ADA	04(0XX)—	CLC	1067—	ADX	105746	.BLE*	105207	LDMP	105702
ADB	04(1XX)—	CLF	1031—	ADY	105756	.CFER	105231	LPMP	105700
AND	01(0XX)—	CLO	103101	CAX	101741	.DFER	105205	LWD1	105704
CPA	05(0XX)—	HLT	1020—	CAY	101751	.CPM	105236	LWD2	105705
CPB	05(1XX)—	LIA	1025—	CBS	105774	.ENTC	105235	MB00	101727
IOR	03(0XX)—	LIB	1065—	CBT	105766	.ENTN	105234	MB01	101730
ISZ	03(1XX)—	MIA	1024—	CBX	105741	.ENTP	105224	MB02	101731
JMP	02(1XX)—	MIB	1064—	CBY	105751	.ENTR	105223	MB10	101732
JSB	01(1XX)—	OTA	1026—	CMW	105776	.FCM	105232	MB11	101733
LDA	06(0XX)—	OTB	1066—	CXA	101744	.FLUN*	105226	MB12	101734
LDB	06(1XX)—	SFC	1022—	CXB	105744	.NGL*	105214	MB20	101735
STA	07(0XX)—	SFS	1023—	CYA	101754	.PACK*	105230	MB21	101736
STB	07(1XX)—	SOC	102201	CYB	105754	.PWR2*	105225	MB22	101737
XOR	02(0XX)—	SOS	102301	DSX	105761	.SETP	105227	MW00	105727
		STC	1027—	DSY	105771	.TCM*	105233	MW01	105730
	Binary	STF	1021—	ISX	105760	.XFER	105220	MW02	105731
		STO	102101	ISY	105770	.ZFER	105237	MW10	105732
				JLY	105762			MW11	105733
	Shift-Rotate			JPY	105772			MW12	105734
				LAX	101742	Double Integer		MW20	105735
ALF	001700			LAY	101752	.DAD	105014	MW21	105736
ALR	001400			LBT	105763	.DCO	105204	MW22	105737
ALS	001000	ASL	1000(01X)—	LBX	105742	.DDE	105211	SIMP	105707
ARS	001100	ASR	1010(01X)—	LBY	105752	.DDS	105213	STMP	105703
BLF	005700	DIV	100400	LDX	105745			SPMR	105701
BLR	005400	JLA	100600	LDY	105755	.DDI*	105074	SWMP	105706
BLS	005000	DLD	104200	LDZ	105755	.DDIR*	105134	XCA1	101726
BRS	005100	DST	104400	MBT	105765	.DIN	105210	XCA2	101723
CLE	000040	JLB	104600	MVW	105777	.DIS	105212	XCB1	105726
ELA	001600	LSL	1000(10X)—	SAX	101740	.DMP*	105054	XCB2	105723
ELB	005600	LSR	1010(10X)—	SAY	101750	.DNG	105203	XJMP	105710
ERA	001500	MPY	100200	SBS	105773	.DSB	105034	XJCQ	105711
ERB	005500	RRL	1001(00X)—	SBT	105764	.DSBR	105114	XLA1	101724
NOP	000000	RRR	1011(00X)—	SBX	105740			XLA2	101721
RAL	001200			SBY	105750	VMA/EMA		XLB1	105724
RAR	001300			SFB	105767	.IMAP	105250	XLB2	105721
RBL	005200			STX	105743	.IRES	105244	XSA1	101725
RBR	005300			STY	105753	.LBP	105257	XSA2	101722
SLA	000010			TBS	105775	.LBPR	105256	XSB1	105725
SLB	004010			XAX	101747	.LPX	105255	XSB2	105722
				XAY	101757	.LPXR	105254		
				XBX	105747	.PMAP	105240		
				XBY	105757			Code and Data Sep.	
								ADQA	101413
								ADQB	105413
								CACQ	101407
								CAZ	101411
								CBCQ	105407
								CBZ	105411
								CCQA	101406
								CCQB	105406
								CIQA	101412
								CIQB	105412
								CZA	101410
								CZB	105410
								EXIT	105417
								EXIT1	105415
								EXIT2	105416
								PCALI	105400
								PCALN	105404
								PCALR	105403
								PCALV	105402
								PCALX	105401
								SDSP	105405

BASE SET INSTRUCTION CODES IN BINARY

15	14	13	12	11	10	9	8	7	6	5	4	3	2	1	0
MEMORY REFERENCE INSTRUCTIONS															
D/I	AND	001	0	Z/C	← MEMORY ADDRESS →										
D/I	XOR	010	0	Z/C											
D/I	IOR	011	0	Z/C											
D/I	JSB	001	1	Z/C											
D/I	JMP	010	1	Z/C											
D/I	ISZ	011	1	Z/C											
D/I	AD*	100	A/B	Z/C											
D/I	CP*	101	A/B	Z/C											
D/I	LD*	110	A/B	Z/C											
D/I	ST*	111	A/B	Z/C											
SHIFT/ROTATE GROUP															
0	000	A/B	0	D/E	*LS	000	†CLE	D/E	‡SL*	*LS	000				
		A/B	0	D/E	*RS	001		D/E		*RS	001				
		A/B	0	D/E	R*L	010		D/E		R*L	010				
		A/B	0	D/E	R*R	011		D/E		R*R	011				
		A/B	0	D/E	*LR	100		D/E		*LR	100				
		A/B	0	D/E	ER*	101		D/E		ER*	101				
		A/B	0	D/E	EL*	110		D/E		EL*	110				
		A/B	0	D/E	*LF	111		D/E		*LF	111				
		NOP	000			000		000			000				
ALTER/SKIP GROUP															
0	000	A/B	1	CL*	01	CLE	01	SEZ	SS*	SL*	IN*	SZ*	RSS		
		A/B		CM*	10	CME	10								
		A/B		CC*	11	CCE	11								
INPUT/OUTPUT GROUP															
1	000		1	H/C	HLT	000	← SELECT CODE →								
			1	0	STF	001									
			1	1	CLF	001									
			1	0	SFC	010									
			1	0	SFS	011									
		A/B	1	H/C	MI*	100									
		A/B	1	H/C	LI*	101									
		A/B	1	H/C	OT*	110									
		0	1	H/C	STC	111									
		1	1	H/C	CLC	111									
			1	0	STO	001	000							001	
			1	1	CLO	001	000							001	
			1	H/C	SOC	010	000							001	
			1	H/C	SOS	011	000							001	
EXTENDED ARITHMETIC GROUP															
1	000	MPY**	000	010	000	000	000					000			
		DIV**	000	100	000	000	000					000			
		JLA	000	110	000	000	000					000			
		DLD**	100	010	000	000	000					000			
		DST**	100	100	000	000	000					000			
		JLB	100	110	000	000	000					000			
		ASR	001	000	0	1	← NUMBER OF BITS →								
		ASL	000	000	0	1									
		LSR	001	000	1	0									
		LSL	000	000	1	0									
		RRR	001	001	0	0									
		RRL	000	001	0	0									
FLOATING POINT INSTRUCTIONS															
1	000		101	00	FAD	000	0	000							
					FSB	001									
					FMP	010									
					FDV	011									
					FIX	100									
					FLT	101									
Notes: * = A or B, according to bit 11. †CLE: Only this bit is required.															
D/I, A/B, Z/C, D/E, H/C coded 0/1. ‡SL*: Only this bit and bit 11 (A/B as applicable) are required.															
**Second word is Memory Address.															

BASE SET INSTRUCTION CODES IN BINARY (Continued)

EXTENDED INSTRUCTION GROUP

	15	14	13	12	11	10	9	8	7	6	5	4	3	2	1	0
SAX/SAY/SBX/SBY	1	0	0	0	A/B	0	1	1	1	1	1	0	X/Y	0	0	0
CAX/CAY/CBX/CBY	1	0	0	0	A/B	0	1	1	1	1	1	0	X/Y	0	0	1
LAX/LAY/LBX/LBY	1	0	0	0	A/B	0	1	1	1	1	1	0	X/Y	0	1	0
STX/STY	1	0	0	0	1	0	1	1	1	1	1	0	X/Y	0	1	1
CXA/CYA/CXB/CYB	1	0	0	0	A/B	0	1	1	1	1	1	0	X/Y	1	0	0
LDX/LDY	1	0	0	0	1	0	1	1	1	1	1	0	X/Y	1	0	1
ADX/ADY	1	0	0	0	1	0	1	1	1	1	1	0	X/Y	1	1	0
XAX/XAY/XBX/XBY	1	0	0	0	A/B	0	1	1	1	1	1	0	X/Y	1	1	1
ISX/ISY/DSX/DSY	1	0	0	0	1	0	1	1	1	1	1	1	X/Y	0	0	I/D
JUMP INSTRUCTIONS	1	0	0	0	1	0	1	1	1	1	1	1		0	1	0
	JLY = 0 JPY = 1															
BYTE INSTRUCTIONS	1	0	0	0	1	0	1	1	1	1	1	0				
	LBT = 0 1 1 SBT = 1 0 0 MBT = 1 0 1 CBT = 1 1 0 SFB = 1 1 1															
BIT INSTRUCTIONS	1	0	0	0	1	0	1	1	1	1	1	1				
	SBS = 0 1 1 CBS = 1 0 0 TBS = 1 0 1															
WORD INSTRUCTIONS	1	0	0	0	1	0	1	1	1	1	1	1	1	1		
	CMW = 0 MVW = 1															

BASE SET INSTRUCTION CODES IN BINARY (Continued)

15	14	13	12	11	10	9	8	7	6	5	4	3	2	1	0
DOUBLE INTEGER INSTRUCTIONS															
1	000			101			000			001			.DAD	100	
								001			011		.DSB	100	
								010			001		.DSBR	100	
											000		.DNG	011	
											001		.DCO	100	
													.DIN	000	
													.DDE	001	
													.DIS	010	
													.DDS	011	
LANGUAGE INSTRUCTION SET															
1	000			101			010			0	00		.DFER	101	
											10		.XFER	000	
													.ENTR	011	
													.ENTP	100	
													.SETP	111	
											11		.CFER	001	
													.FCM	010	
													.ENTN	100	
													.ENTC	101	
													.CPM	110	
													.ZFER	111	
VIRTUAL MEMORY INSTRUCTIONS															
1	000			101			010			100			.PMAP	000	
													.IRES	100	
												101	.IMAP	000	
													.LPXR	100	
													.LPX	101	
													.LBPR	110	
													.LBP	111	
OPERATING SYSTEM INSTRUCTION SET															
1	000			101			011			000			.CPUID	000	
													.FWID	001	
													.WFI	010	
													.SIP	011	
DMS INSTRUCTIONS															
1	000			1	01	111			000			LPMR	000		
				1									SPMR	001	
				1									LDMP	010	
				1									STMP	011	
				1									LWD1	100	
				1									SWMP	110	
				1									SIMP	111	
				1									XJMP	000	
				A/B						001			XL*1	100	
				A/B						010			XS*1	101	
				A/B									XC*1	110	
				B/W									M°00	111	
				B/W						011			M°01	000	
				B/W									M°10	010	
				B/W									M°11	011	

Notes: * = A (0) or B (1), according to bit 11.
 ° = B (0) or W (1), according to bit 11.

DOUBLE-PRECISION INSTRUCTION CODES IN BINARY

15	14	13	12	11	10	9	8	7	6	5	4	3	2	1	0
SINGLE-PRECISION FLOATING POINT INSTRUCTIONS															
1	000			101			001			000			.FIXD	100	
							010			010			.FLTD	100	
										011			.PWR2	101	
													.FLUN	110	
													.PACK	000	
DOUBLE-PRECISION FLOATING POINT INSTRUCTIONS															
1	000			101			000			000			.TADD	010	
										010			.TSUB	010	
										100			.TMPY	010	
										110			.TDIV	010	
						001			000			.TFXS	010		
										010			.TFXD	110	
													.TFTS	010	
													.TFTD	110	
						010			000			.BLE	111		
										001			.NGL	100	
										011			..TCM	011	
DOUBLE INTEGER INSTRUCTIONS															
1	000			101			000			101			.DMP	100	
										111			.DDI	100	
										011			.DDIR	100	
CODE AND DATA SEPARATION															
1	000			001			100			000			CCQA	110	
										001			CACQ	111	
													CZA	000	
													CAZ	001	
													CIQA	010	
													ADQA	011	
				101			100			000			PCALI	000	
													PCALX	001	
													PCALV	010	
													PCALR	011	
													PCALN	100	
													SDSP	101	
													CCQB	110	
													CBCQ	111	
										001			CZB	000	
													CBZ	001	
													CIQB	010	
													ADQB	011	
													EXIT1	101	
													EXIT2	110	
													EXIT	111	

EXTEND AND OVERFLOW EXAMPLES

SAME SIGN (POSITIVE)

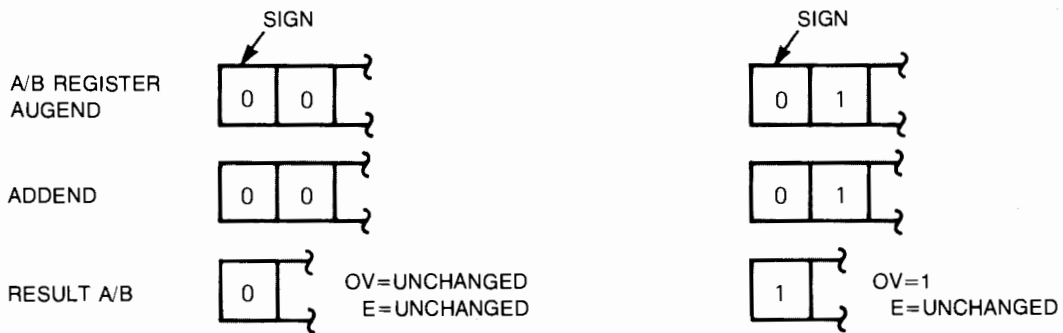

SAME SIGN (NEGATIVE)

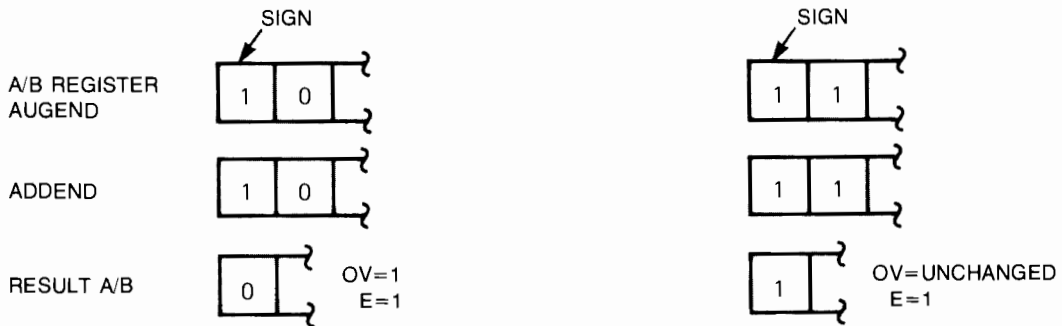

DIFFERENT SIGNS

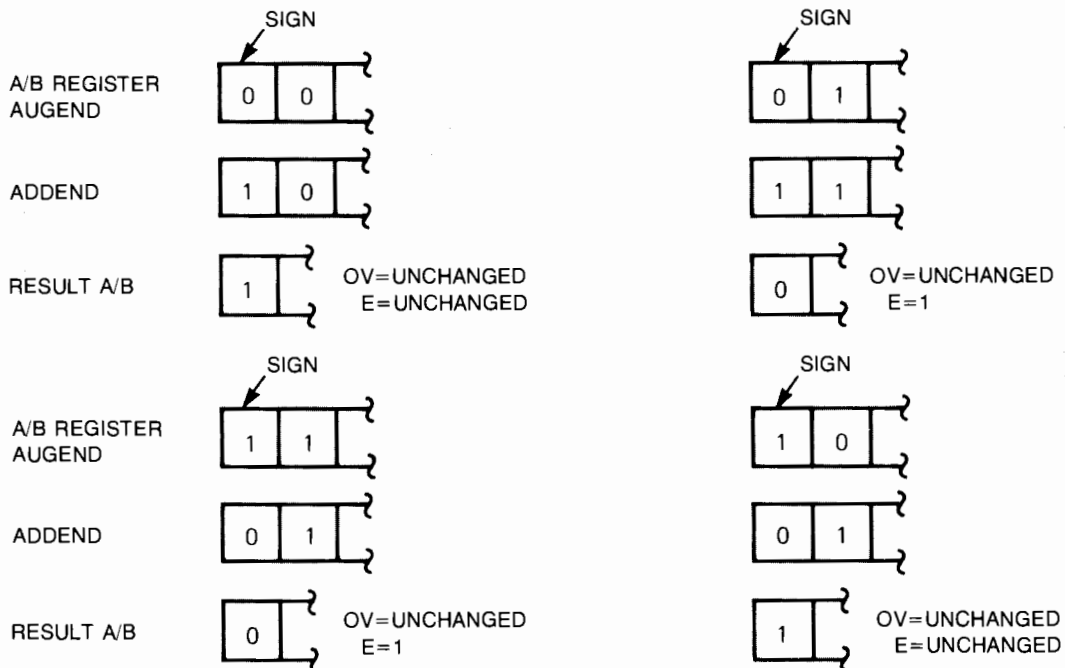

INTERRUPT AND CONTROL SUMMARY

INST	S.C. 00	S.C. 01	S.C. 02	S.C. 03	S.C. 04	S.C. 05	S.C. 06	S.C. 07
STC	NOP	NOP	Enable break mode.	NOP	Enable Type 2 and 3 interrupts.	Enable parity error interrupts.	Turn on Time Base Generator.	Turn on memory protect.
CLC	System reset.	NOP	NOP	NOP	Disable Type 2 and 3 interrupts.	Disable parity error interrupts.	Turn off Time Base Generator.	NOP
STF	Enable Type 3 interrupts.	STO	Disable Global Register.	NOP	NOP	Set parity sense to even parity.	Set Time Base Generator flag.	NOP
CLF	Disable Type 3 interrupts.	CLO	Enable Global Register.	NOP	NOP	Set parity sense to odd parity.	Clear Time Base Generator flag.	NOP
SFS	Skip if Type 3 interrupts are enabled.	SOS	Skip if Global Register is disabled.	NOP	Skip if power not going down	Skip if parity sense is even.	Skip if Time Base Generator flag is set.	NOP
SFC	Skip if Type 3 interrupts are disabled.	SOC	Skip if Global Register is enabled.	NOP	Skip if power is going down.	Skip if parity sense is odd.	Skip if Time Base Generator flag is clear.	NOP
LJ*	Load from interrupt mask register.	Load from processor switch register.	Load from Global Register.	Load from PSAVE or (with ,C) ROMP.	Load from central interrupt register.	Load bits 0-15 from parity error register, or (with ,C) bits 16-23.	NOP	Load from violation register.
MI*	NOP	Merge from processor switch register.	NOP	NOP	NOP	NOP	NOP	NOP
OT*	Output to interrupt mask register.	Output to processor LED register.	Output to Global Register. (Note 1)	Output to PSAVE or (with ,C) ROMP	Output to central interrupt register.	NOP	NOP	NOP

Note 1: An OTA/B 2 with A/B equal to one through seven establishes a diagnose mode; refer to paragraph 7-22 for details.

READER COMMENT SHEET

HP 1000 A600/A600+ COMPUTER
Reference Manual

02156-90001

December 1983

Update No. _____
(If Applicable)

We welcome your evaluation of this manual. Your comments and suggestions help us improve our publications. Please use additional pages if necessary. If you have technical questions or if you want to order publications, make your inquiries to a representative of your local HP office. Thank you for your comments! No postage necessary if mailed in the U.S.A.

FROM:

Name _____

Company _____

Address _____

Phone No. _____ **Ext.** _____

SALES & SUPPORT OFFICES

Arranged alphabetically by country



Product Line Sales/Support Key

Key Product Line

- A** Analytical
- CM** Components
- C** Computer Systems Sales only
- CH** Computer Systems Hardware Sales and Services
- CS** Computer Systems Software Sales and Services
- E** Electronic Instruments & Measurement Systems
- M** Medical Products
- MP** Medical Products Primary SRO
- MS** Medical Products Secondary SRO
- P** Personal Computation Products
- Sales only for specific product line
- “ Support only for specific product line

IMPORTANT: These symbols designate general product line capability. They do not insure sales or support availability for all products within a line, at all locations. Contact your local sales office for information regarding locations where HP support is available for specific products.

HP distributors are printed in italics.

HEADQUARTERS OFFICES

If there is no sales office listed for your area, contact one of these headquarters offices.

NORTH/CENTRAL AFRICA

Hewlett-Packard S.A.
7, Rue du Bois-du-Lan
CH-1217 **MEYRIN 2**, Switzerland
Tel: (022) 83 12 12
Telex: 27835 hpse
Cable: HEWPACKSA Geneve

ASIA

Hewlett-Packard Asia Ltd.
6th Floor, Sun Hung Kai Centre
30 Harbour Rd.
G.P.O. Box 795

HONG KONG

Tel: 5-832 3211
After Jan. 1, 1984
47th Floor, China Resources Bldg.
26 Harbour Rd., Wanchai

HONG KONG

Telex: 66678 HEWPA HX
Cable: HEWPACK HONG KONG

CANADA

Hewlett-Packard (Canada) Ltd.
6877 Goreway Drive
MISSISSAUGA, Ontario L4V 1M8
Tel: (416) 678-9430
Telex: 610-492-4246

EASTERN EUROPE

Hewlett-Packard Ges.m.b.h.
Liebiggasse 1
P.O.Box 72
A-1222 **VIENNA**, Austria
Tel: (222) 2365 110
Telex: 1 3 4425 HEPA A

NORTHERN EUROPE

Hewlett-Packard S.A.
Uilenstede 475
P.O.Box 999
NL-1180 **AZ AMSTELVEEN**
The Netherlands
Tel: 20 437771

SOUTH EAST EUROPE

Hewlett-Packard S.A.
7, Rue du Bois-du-Lan
CH-1217 **MEYRIN 2**, Switzerland
Tel: (022) 83 12 12
Telex: 27835 hpse
Cable: HEWPACKSA Geneve

OTHER EUROPE

Hewlett-Packard S.A.
P.O. Box
150, Rte du Nant-D'Avril
CH-1217 **MEYRIN 2**, Switzerland
Tel: (022) 83 8111
Telex: 22486 hpsa
Cable: HEWPACKSA Geneve

MEDITERRANEAN AND MIDDLE EAST

Hewlett-Packard S.A.
Mediterranean and Middle East
Operations
Atrina Centre
32 Kifissias Ave.
Paradissos-Amarousion, **ATHENS**
Greece
Tel: 682 88 11
Telex: 21-6588 HPAT GR
Cable: HEWPACKSA Athens

EASTERN USA

Hewlett-Packard Co.
4 Choke Cherry Road
ROCKVILLE, MD 20850
Tel: (301) 258-2000

MIDWESTERN USA

Hewlett-Packard Co.
5201 Tollview Drive
ROLLING MEADOWS, IL 60008
Tel: (312) 255-9800

SOUTHERN USA

Hewlett-Packard Co.
2000 South Park Place
P.O. Box 105005
ATLANTA, GA 30348
Tel: (404) 955-1500

WESTERN USA

Hewlett-Packard Co.
3939 Lankershim Blvd.
P.O. Box 3919
LOS ANGELES, CA 91604
Tel: (213) 506-3700

OTHER INTERNATIONAL AREAS

Hewlett-Packard Co.
Intercontinental Headquarters
3495 Deer Creek Road
PALO ALTO, CA 94304
Tel: (415) 857-1501
Telex: 034-8300
Cable: HEWPACK

ANGOLA

Telectra
Empresa Técnica de Equipamentos
R. Barbosa Rodrigues, 41-I DT.
Caixa Postal 6487
LUANDA
Tel: 35515,35516
E,P

ARGENTINA

Hewlett-Packard Argentina S.A.
Avenida Santa Fe 2035
Martinez 1640 BUENOS AIRES
Tel: 798-5735, 792-1293
Telex: 17595 BIONAR
Cable: HEWPACKARG
A,E,CH,CS,P
Biotron S.A.C.I.M. e l.
Av Paseo Colon 221, Piso 9
1399 BUENOS AIRES
Tel: 30-4846, 30-1851
Telex: 17595 BIONAR
M

AUSTRALIA

Adelaide, South Australia Office

Hewlett-Packard Australia Ltd.
153 Greenhill Road
PARKSIDE, S.A. 5063
Tel: 272-5911
Telex: 82536
Cable: HEWARD Adelaide
A*,CH,CM,,E,MS,P

Brisbane, Queensland Office

Hewlett-Packard Australia Ltd.
10 Payne Road
THE GAP, Queensland 4061
Tel: 30-4133
Telex: 42133
Cable: HEWARD Brisbane
A,CH,CM,E,M,P

Canberra, Australia Capital Territory Office

Hewlett-Packard Australia Ltd.
121 Wollongong Street
FYSHWICK, A.C.T. 2609
Tel: 80 4244
Telex: 62650
Cable: HEWARD Canberra
CH,CM,E,P

Melbourne, Victoria Office

Hewlett-Packard Australia Ltd.
31-41 Joseph Street
BLACKBURN, Victoria 3130
Tel: 895-2895
Telex: 31-024
Cable: HEWARD Melbourne
A,CH,CM,CS,E,MS,P

Perth, Western Australia Office

Hewlett-Packard Australia Ltd.
261 Stirling Highway
CLAREMONT, W.A. 6010
Tel: 383-2188
Telex: 93859
Cable: HEWARD Perth
A,CH,CM,E,MS,P

Sydney, New South Wales Office

Hewlett-Packard Australia Ltd.
17-23 Talavera Road
P.O. Box 308
NORTH RYDE, N.S.W. 2113
Tel: 887-1611
Telex: 21561
Cable: HEWARD Sydney
A,CH,CM,CS,E,MS,P

AUSTRIA

Hewlett-Packard Ges.m.b.h.
Grottenhofstrasse 94
A-8052 **GRAZ**
Tel: (0316) 291 5 66
Telex: 32375
CH,E
Hewlett-Packard Ges.m.b.h.
Liebiggasse 1
P.O. Box 72
A-1222 **VIENNA**
Tel: (0222) 23 65 11-0
Telex: 134425 HEPA A
A,CH,CM,CS,E,MS,P

BAHRAIN

Green Salon
P.O. Box 557
Manama
BAHRAIN
Tel: 255503-255950
Telex: 844 19
P

Wael Pharmacy

P.O. Box 648

BAHRAIN

Tel: 256123
Telex: 8550 WAEL BN
E,C,M

BELGIUM

Hewlett-Packard Belgium S.A./N.V.
Blvd de la Woluwe, 100
Woluwedal
B-1200 **BRUSSELS**
Tel: (02) 762-32-00
Telex: 23-494 paloben bru
A,CH,CM,CS,E,MP,P

BRAZIL

Hewlett-Packard do Brasil I.e.C. Ltda.
Alameda Rio Negro, 750
Alphaville
06400 **BARUERI SP**
Tel: (011) 421.1311
Telex: (011) 33872 HPBR-BR
Cable: HEWPACK Sao Paulo
A,CH,CM,CS,E,M,P
Hewlett-Packard do Brasil I.e.C. Ltda.
Avenida Epitacio Pessoa, 4664
22471 **RIO DE JANEIRO-RJ**
Tel: (021) 286.0237
Telex: 021-21905 HPBR-BR
Cable: HEWPACK Rio de Janeiro
A,CH,CM,E,MS,P*
ANAMED I.C.E.I. Ltda.
Rua Bage, 103
04012 SAO PAULO
Tel: (011) 570-5726
Telex: 021-21905 HPBR-BR
M

**GREAT BRITAIN (Cont'd)**

Hewlett-Packard Ltd.
Avon House
435 Stratford Road
Shirley, SOLIHULL, West Midlands
B90 4BL

Tel: 021 745 8800
Telex: 339105
CH,CS,E,P

Hewlett-Packard Ltd.
West End House
41 High Street, West End

SOUTHAMPTON
Hampshire SO3 3DQ
Tel: 04218 6767
Telex: 477138
CH,CS,P

Hewlett-Packard Ltd.
Eskdale Rd.
Winnersh, WOKINGHAM
Berkshire RG11 5DZ
Tel: 0734 696622
Telex: 848884
E

Hewlett-Packard Ltd.
King Street Lane
Winnersh, WOKINGHAM
Berkshire RG11 5AR
Tel: 0734 784774
Telex: 847178
A,CH,CS,E,M,MP,P

Hewlett-Packard Ltd.
Nine Mile Ride
Easthampstead, WOKINGHAM
Berkshire, RG11 3LL
Tel: 0344 773100
Telex: 848805
CH,CS,E,P

IRELAND**NORTHERN IRELAND**

Hewlett-Packard Ltd.
Cardiac Services Building
95A Finaghy Road South
BELFAST BT10 0BY
Tel: 0232 625-566
Telex: 747626
CH,CS

SCOTLAND

Hewlett-Packard Ltd.
SOUTH QUEENSFERRY
West Lothian, EH30 9TG
Tel: 031 331 1188
Telex: 72682
CH,CM,CS,E,M,P

UNITED STATES**Alabama**

Hewlett-Packard Co.
700 Century Park South, Suite 128
BIRMINGHAM, AL 35226
Tel: (205) 822-6802
A,CH,M

Hewlett-Packard Co.
420 Wynn Drive
HUNTSVILLE, AL 35805
P.O. Box 7700
HUNTSVILLE, AL 35807
Tel: (205) 830-2000
CH,CM,CS,E,M*

Arizona

Hewlett-Packard Co.
8080 Pointe Parkway West
PHOENIX, AZ 85044
Tel: (602) 273-8000
A,CH,CM,CS,E,MS

Hewlett-Packard Co.
2424 East Aragon Road
TUCSON, AZ 85706
Tel: (602) 889-4631
CH,E,MS**

California

Hewlett-Packard Co.
99 South Hill Dr.
BRISBANE, CA 94005
Tel: (415) 330-2500
CH,CS

Hewlett-Packard Co.
P.O. Box 7830 (93747)
5060 E. Clinton Avenue, Suite 102
FRESNO, CA 93727
Tel: (209) 252-9652
CH,CS,MS

Hewlett-Packard Co.
P.O. Box 4230
1430 East Orangethorpe
FULLERTON, CA 92631
Tel: (714) 870-1000
CH,CM,CS,E,MP

Hewlett-Packard Co.
320 S. Kellogg, Suite B
GOLETA, CA 93117
Tel: (805) 967-3405
CH

Hewlett-Packard Co.
5400 W. Rosecrans Boulevard
LAWDALE, CA 90260
P.O. Box 92105
LOS ANGELES, CA 90009
Tel: (213) 970-7500
Telex: 910-325-6608
CH,CM,CS,MP

Hewlett-Packard Co.
3155 Porter Oaks Drive
PALO ALTO, CA 94304
Tel: (415) 857-8000
CH,CS,E

Hewlett-Packard Co.
4244 So. Market Court, Suite A
P.O. Box 15976
SACRAMENTO, CA 95852
Tel: (916) 929-7222
A*,CH,CS,E,MS

Hewlett-Packard Co.
9606 Aero Drive
P.O. Box 23333
SAN DIEGO, CA 92139
Tel: (619) 279-3200
CH,CM,CS,E,MP

Hewlett-Packard Co.
2305 Camino Ramon "C"
SAN RAMON, CA 94583
Tel: (415) 838-5900
CH,CS

Hewlett-Packard Co.
3005 Scott Boulevard
SANTA CLARA, CA 95050
Tel: (408) 988-7000
Telex: 910-338-0586
A,CH,CM,CS,E,MP

Hewlett-Packard Co.
5703 Corsa Avenue
WESTLAKE VILLAGE, CA 91362
Tel: (213) 706-6800
E*,CH*,CS*

Colorado

Hewlett-Packard Co.
24 Inverness Place, East
ENGLEWOOD, CO 80112
Tel: (303) 649-5000
A,CH,CM,CS,E,MS

Connecticut

Hewlett-Packard Co.
47 Barnes Industrial Road South
P.O. Box 5007
WALLINGFORD, CT 06492
Tel: (203) 265-7801
A,CH,CM,CS,E,MS

Florida

Hewlett-Packard Co.
2901 N.W. 62nd Street
P.O. Box 24210
FORT LAUDERDALE, FL 33307
Tel: (305) 973-2600
CH,CS,E,MP

Hewlett-Packard Co.
6177 Lake Ellenor Drive
P.O. Box 13910
ORLANDO, FL 32859
Tel: (305) 859-2900
A,CH,CM,CS,E,MS

Hewlett-Packard Co.
5750B N. Hoover Blvd., Suite 123
P.O. Box 15200
TAMPA, FL 33614
Tel: (813) 884-3282
A*,CH,CM,CS,E*,M*

Georgia

Hewlett-Packard Co.
2000 South Park Place
P.O. Box 105005
ATLANTA, GA 30348
Tel: (404) 955-1500
Telex: 810-766-4890
A,CH,CM,CS,E,MP

Hawaii

Hewlett-Packard Co.
Kawaiahao Plaza, Suite 190
567 South King Street
HONOLULU, HI 96813
Tel: (808) 526-1555
A,CH,E,MS

Illinois

Hewlett-Packard Co.
304 Eldorado Road
P.O. Box 1607
BLOOMINGTON, IL 61701
Tel: (309) 662-9411
CH,MS**

Hewlett-Packard Co.
1100 31st Street, Suite 100
DOWNERS GROVE, IL 60515
Tel: (312) 960-5760
CH,CS

Hewlett-Packard Co.
5201 Tollview Drive
ROLLING MEADOWS, IL 60008
Tel: (312) 255-9800
Telex: 910-687-1066
A,CH,CM,CS,E,MP

Indiana

Hewlett-Packard Co.
7301 No. Shadeland Avenue
P.O. Box 50807
INDIANAPOLIS, IN 46250
Tel: (317) 842-1000
A,CH,CM,CS,E,MS

Iowa

Hewlett-Packard Co.
1776 22nd Street, Suite 1
WEST DES MOINES, IA 50265
Tel: (515) 224-1435
CH,MS**

Kansas

Hewlett-Packard Co.
7804 East Funston Road, #203
WICHITA, KS 67207
Tel: (316) 684-8491
CH

Kentucky

Hewlett-Packard Co.
10300 Linn Station Road, #100
LOUISVILLE, KY 40223
Tel: (502) 426-0100
A,CH,CS,MS

Louisiana

Hewlett-Packard Co.
160 James Drive East
ST. ROSE, LA 70087
P.O. Box 1449
KENNER, LA 70063
Tel: (504) 467-4100
A,CH,CS,E,MS

Maryland

Hewlett-Packard Co.
3701 Koppers Street
BALTIMORE, MD 21227
Tel: (301) 644-5800
Telex: 710-862-1943
A,CH,CM,CS,E,MS

Hewlett-Packard Co.
2 Choke Cherry Road
ROCKVILLE, MD 20850
Tel: (301) 948-6370
A,CH,CM,CS,E,MP

Massachusetts

Hewlett-Packard Co.
1775 Minuteman Road
ANDOVER, MA 01810
Tel: (617) 682-1500
A,C,CH,CS,CM,E,MP,P*

Hewlett-Packard Co.
32 Hartwell Avenue
LEXINGTON, MA 02173
Tel: (617) 861-8960
CH,CS,E

Michigan

Hewlett-Packard Co.
4326 Cascade Road S.E.
GRAND RAPIDS, MI 49506
Tel: (616) 957-1970
CH,CS,MS

Hewlett-Packard Co.
1771 W. Big Beaver Road
TROY, MI 48084
Tel: (313) 643-6474
CH,CS

Minnesota

Hewlett-Packard Co.
2025 W. Larpenteur Ave.
ST. PAUL, MN 55113
Tel: (612) 644-1100
A,CH,CM,CS,E,MP

Missouri

Hewlett-Packard Co.
11131 Colorado Avenue
KANSAS CITY, MO 64137
Tel: (816) 763-8000
A,CH,CM,CS,E,MS

Hewlett-Packard Co.
13001 Hollenberg Drive
BRIDGETON, MO 63044
Tel: (314) 344-5100
A,CH,CS,E,MP

SALES & SUPPORT OFFICES

Arranged alphabetically by country

3



FRANCE (Cont'd)

Hewlett-Packard France
125, rue du Faubourg Banner
F-45000 ORLEANS
Tel: 16 (38) 68 01 63

Hewlett-Packard France
Zone Industrielle de Courtaboeuf
Avenue des Tropiques
F-91947 Les Ulis Cedex ORSAY
Tel: (6) 907-78-25
Telex: 600048F

A,CH,CM,CS,E,MP,P

Hewlett-Packard France
Paris Porte-Maillet
15, Avenue de L'Amiral Bruix
F-75782 PARIS CEDEX 16
Tel: 16 (1) 502-12-20
Telex: 613663F
CH,MS,P

Hewlett-Packard France
124, Boulevard Tourasse
F-64000 PAU
Tel: 16 (59) 80 38 02

Hewlett-Packard France
2 Allée de la Bourgonnette
F-35100 RENNES
Tel: 16 (99) 51-42-44
Telex: 740912F
CH,CM,E,MS,P*

Hewlett-Packard France
98 Avenue de Bretagne
F-76100 ROUEN
Tel: 16 (35) 63-57-66
CH*,CS

Hewlett-Packard France
4 Rue Thomas Mann
Boîte Postale 56
F-67033 STRASBOURG Cedex
Tel: 16 (88) 28-56-46
Telex: 890141F
CH,E,MS,P*

Hewlett-Packard France
Le Péripole
20, Chemin du Pigeonnier de la
Cépière
F-31083 TOULOUSE Cedex
Tel: 16 (61) 40-11-12
Telex: 531639F
A,CH,CS,E,P*

Hewlett-Packard France
9, rue Baudin
F-26000 VALENCE
Tel: 16 (75) 42 76 16

Hewlett-Packard France
Carolor
ZAC de Bois Briand
F-57640 VIGY (Metz)
Tel: 16 (8) 771 20 22
CH

Hewlett-Packard France
Immeuble Péricentre
F-59658 VILLENEUVE D'ASCQ Cedex
Tel: 16 (20) 91-41-25
Telex: 160124F
CH,E,MS,P*

GERMAN FEDERAL REPUBLIC

Hewlett-Packard GmbH
Geschäftsstelle
Keithstrasse 2-4
D-1000 BERLIN 30
Tel: (030) 24-90-86
Telex: 018 3405 hpbln d
A,CH,E,M,P

Hewlett-Packard GmbH
Geschäftsstelle
Herrenberger Strasse 130
D-7030 BÖBLINGEN
Tel: (7031) 14-0
Telex:

A,CH,CM,CS,E,MP,P
Hewlett-Packard GmbH
Geschäftsstelle
Emanuel-Leutze-Strasse 1
D-4000 DUSSELDORF

Tel: (0211) 5971-1

Telex: 085/86 533 hpdd d
A,CH,CS,E,MS,P

Hewlett-Packard GmbH
Geschäftsstelle
Schleefstr. 28a
D-4600 DORTMUND-Aplerbeck
Tel: (0231) 45001

Hewlett-Packard GmbH
Vertriebszentrale Frankfurt
Berner Strasse 117
Postfach 560 140
D-6000 FRANKFURT 56
Tel: (0611) 50-04-1
Telex: 04 13249 hpfm d
A,CH,CM,CS,E,MP,P

Hewlett-Packard GmbH
Geschäftsstelle
Aussenstelle Bad Homburg
Louisenstrasse 115
D-6380 BAD HOMBURG
Tel: (06172) 109-0

Hewlett-Packard GmbH
Geschäftsstelle
Kapstadtring 5
D-2000 HAMBURG 60
Tel: (040) 63804-1
Telex: 021 63 032 hphh d
A,CH,CS,E,MS,P

Hewlett-Packard GmbH
Geschäftsstelle
Heidering 37-39
D-3000 HANNOVER 61
Tel: (0511) 5706-0
Telex: 092 3259
A,CH,CM,E,MS,P

Hewlett-Packard GmbH
Geschäftsstelle
Rosslauer Weg 2-4
D-6800 MANNHEIM
Tel: (0621) 70050
Telex: 0462105
A,C,E

Hewlett-Packard GmbH
Geschäftsstelle
Messerschmittstrasse 7
D-7910 NEU ULM
Tel: 0731-70241
Telex: 0712816 HP ULM-D
A,C,E*

Hewlett-Packard GmbH
Geschäftsstelle
Ehhericherstr. 13
D-8500 NÜRNBERG 10
Tel: (0911) 5205-0
Telex: 0623 860
CH,CM,E,MS,P

Hewlett-Packard GmbH
Geschäftsstelle
Eschenstrasse 5
D-8028 TAUFKIRCHEN
Tel: (089) 6117-1
Telex: 0524985
A,CH,CM,E,MS,P

GREAT BRITAIN

See United Kingdom

GREECE

Kostas Karayannis S.A.
8 Omirou Street
ATHENS 133
Tel: 32 30 303, 32 37 371
Telex: 215962 RKAR GR
A,CH,CM,CS,E,M,P

PLAISIO S.A.

G. Gerardos

24 Stournara Street

ATHENS
Tel: 36-11-160
Telex: 221871
P

GUATEMALA

IPESA
Avenida Reforma 3-48, Zona 9
GUATEMALA CITY
Tel: 316627, 314786
Telex: 4192 TELTRO GU
A,CH,CM,CS,E,M,P

HONG KONG

Hewlett-Packard Hong Kong, Ltd.
G.P.O. Box 795
5th Floor, Sun Hung Kai Centre
30 Harbour Road
HONG KONG
Tel: 5-8323211
Telex: 66678 HEWPA HX
Cable: HEWPACK HONG KONG
E,CH,CS,P

CET Ltd.
1402 Tung Wah Mansion
199-203 Hennessy Rd.

Wanchia, HONG KONG
Tel: 5-729376
Telex: 85148 CET HX
CM

Schmidt & Co. (Hong Kong) Ltd.
Wing On Centre, 28th Floor
Connaught Road, C.

HONG KONG
Tel: 5-455644
Telex: 74766 SCHMX HX
A,M

ICELAND

Elding Trading Company Inc.
Hafnarvoll-Tryggvagotu
P.O. Box 895
IS-REYKJAVIK
Tel: 1-58-20, 1-63-03
M

INDIA

Computer products are sold through
Blue Star Ltd. All computer repairs and
maintenance service is done through
Computer Maintenance Corp.

Blue Star Ltd.
Sabri Complex II Floor
24 Residency Rd.
BANGALORE 560 025
Tel: 55660
Telex: 0845-430
Cable: BLUESTAR
A,CH*,CM,CS*,E

Blue Star Ltd.
Band Box House
Prabhadevi
BOMBAY 400 025
Tel: 422-3101
Telex: 011-3751
Cable: BLUESTAR
A,M

Blue Star Ltd.
Sahas
414/2 Vir Savarkar Marg

Prabhadevi

BOMBAY 400 025

Tel: 422-6155
Telex: 011-4093
Cable: FROSTBLUE
A,CH*,CM,CS*,E,M

Blue Star Ltd.
Kalyan, 19 Vishwas Colony
Alkapuri, BORODA, 390 005
Tel: 65235
Cable: BLUE STAR
A

Blue Star Ltd.
7 Hare Street
CALCUTTA 700 001
Tel: 12-01-31
Telex: 021-7655
Cable: BLUESTAR
A,M

Blue Star Ltd.
133 Kodambakkam High Road
MADRAS 600 034
Tel: 82057
Telex: 041-379
Cable: BLUESTAR
A,M

Blue Star Ltd.
Bhandari House, 7th/8th Floors
91 Nehru Place
NEW DELHI 110 024
Tel: 682547
Telex: 031-2463
Cable: BLUESTAR
A,CH*,CM,CS*,E,M

Blue Star Ltd.
15/16:C Wellesley Rd.
PUNE 411 011
Tel: 22775
Cable: BLUE STAR
A

Blue Star Ltd.
2-2-47/1108 Bolarum Rd.
SECUNDERABAD 500 003
Tel: 72057
Telex: 0155-459
Cable: BLUEFROST
A,E

Blue Star Ltd.
T.C. 7/603 Poornima
Maruthankuzhi
TRIVANDRUM 695 013
Tel: 65799
Telex: 0884-259
Cable: BLUESTAR
E

Computer Maintenance Corporation
Ltd.
115, Sarojini Devi Road
SECUNDERABAD 500 003
Tel: 310-184, 345-774
Telex: 031-2960
CH**



MAYLAISIA (Cont'd)

Protel Engineering
P.O. Box 1917
Lot 6624, Section 64
23/4 Pending Road
Kuching, SARAWAK
Tel: 36299
Telex: MA 70904 PROMAL
Cable: PROTELENG
A,E,M

MALTA

Philip Toledo Ltd.
Notabile Rd.
MRIEHEL
Tel: 447 47, 455 66
Telex: Media MW 649
E,P

MEXICO

Hewlett-Packard Mexicana, S.A.
de C.V.
Av. Periferico Sur No. 6501
Tepepan, Xochimilco
16020 MEXICO D.F.
Tel: 6-76-46-00
Telex: 17-74-507 HEWPACK MEX
A,CH,CS,E,MS,P
Hewlett-Packard Mexicana, S.A.
de C.V.
Ave. Colonia del Valle 409
Col. del Valle
Municipio de Garza Garcia
MONTERREY, Nuevo Leon
Tel: 78 42 41
Telex: 038 410
CH
ECISA
José Vasconcelos No. 218
Col. Condesa Deleg. Cuauhtémoc
MEXICO D.F. 06140
Tel: 553-1206
Telex: 17-72755 ECE ME
M

MOROCCO

Dolbeau
81 rue Karatchi
CASABLANCA
Tel: 3041-82, 3068-38
Telex: 23051, 22822
E

Gerep

2 rue d'Agadir
Boite Postale 156

CASABLANCA
Tel: 272093, 272095
Telex: 23 739
P

NETHERLANDS

Hewlett-Packard Nederland B.V.
Van Heuven Goedhartlaan 121
NL 1181KK AMSTELVEEN
P.O. Box 667
NL 1180 AR AMSTELVEEN
Tel: (020) 47-20-21
Telex: 13 216 HEPA NL
A,CH,CM,CS,E,MP,P
Hewlett-Packard Nederland B.V.
Bongerd 2
NL 2906VK CAPELLE A/D IJSSEL
P.O. Box 41
NL 2900AA CAPELLE A/D IJSSEL
Tel: (10) 51-64-44
Telex: 21261 HEPAC NL
A,CH,CS,E

Hewlett-Packard Nederland B.V.
Pastoor Petersstraat 134-136
NL 5612 LV EINDHOVEN
P.O. Box 2342
NL 5600 CH EINDHOVEN
Tel: (040) 326911
Telex: 51484 hepae nl
A,CH*,E,M

NEW ZEALAND

Hewlett-Packard (N.Z.) Ltd.
5 Owens Road
P.O. Box 26-189
Epsom, AUCKLAND
Tel: 687-159
Cable: HEWPACK Auckland
CH,CM,E,P*

Hewlett-Packard (N.Z.) Ltd.

4-12 Cruickshank Street
Kilbirnie, WELLINGTON 3
P.O. Box 9443
Courtenay Place, WELLINGTON 3
Tel: 877-199
Cable: HEWPACK Wellington
CH,CM,E,P

Northrop Instruments & Systems Ltd.
369 Khyber Pass Road

P.O. Box 8602

AUCKLAND

Tel: 794-091
Telex: 60605
A,M

Northrop Instruments & Systems Ltd.
110 Mandeville St.

P.O. Box 8388

CHRISTCHURCH

Tel: 486-928
Telex: 4203
A,M

Northrop Instruments & Systems Ltd.
Sturdee House

85-87 Ghuznee Street

P.O. Box 2406

WELLINGTON

Tel: 850-091
Telex: NZ 3380
A,M

NORTHERN IRELAND

See United Kingdom

NORWAY

Hewlett-Packard Norge A/S
Folke Bernadottes vei 50
P.O. Box 3558
N-5033 FYLLINGSDALEN (Bergen)
Tel: 0047/5/16 55 40
Telex: 16621 hpnas n
CH,CS,E,MS

Hewlett-Packard Norge A/S

Østerdalen 16-18

P.O. Box 34

N-1345 ØSTERÅS

Tel: 0047/2/17 11 80
Telex: 16621 hpnas n
A,CH,CM,CS,E,M,P

OMAN

Khimjil Ramdas
P.O. Box 19

MUSCAT

Tel: 722225, 745601
Telex: 3289 BROKER MB MUSCAT
P

Suhail & Saud Bahwan
P.O. Box 169

MUSCAT

Tel: 734 201-3
Telex: 3274 BAHWAN MB

PAKISTAN

Mushko & Company Ltd.
1-B, Street 43
Sector F-8/1
ISLAMABAD
Tel: 51071
Cable: FEMUS Rawalpindi
A,E,M

Mushko & Company Ltd.
Osman Chambers

Abdullah Haroon Road
KARACHI 0302

Tel: 524131, 524132

Telex: 2894 MUSKO PK

Cable: COOPERATOR Karachi
A,E,M,P*

PANAMA

Electrónico Balboa, S.A.
Calle Samuel Lewis, Ed. Alfa
Apartado 4929
PANAMA 5
Tel: 63-6613, 63-6748
Telex: 3483 ELECTRON PG
A,CM,E,M,P

PERU

Cía Electro Médica S.A.
Los Flamencos 145, San Isidro
Casilla 1030
LIMA 1
Tel: 41-4325, 41-3703
Telex: Pub. Booth 25306
CM,E,M,P

PHILIPPINES

The Online Advanced Systems
Corporation
Rico House, Amorsolo Cor. Herrera
Street
Legaspi Village, Makati
P.O. Box 1510
Metro MANILA
Tel: 85-35-81, 85-34-91, 85-32-21
Telex: 3274 ONLINE
A,CH,CS,E,M
Electronic Specialists and Proponents
Inc.
690-B Epifanio de los Santos Avenue
Cubao, QUEZON CITY
P.O. Box 2649 Manila
Tel: 98-96-81, 98-96-82, 98-96-83
Telex: 40018, 42000 ITT GLOBE
MACKAY BOOTH
P

PORTUGAL

Mundinter
Intercambio Mundial de Comércio
S.A.R.L.
P.O. Box 2761
Av. Antonio Augusto de Aguiar 138
P-LISBON
Tel: (19) 53-21-31, 53-21-37
Telex: 16691 munter p
M
Soquímica
Av. da Liberdade, 220-2
1298 LISBOA Codex
Tel: 56 21 81/2/3
Telex: 13316 SABASA
P

Telectra-Empresa Técnica de
Equipamentos Eléctricos S.A.R.L.
Rua Rodrigo da Fonseca 103
P.O. Box 2531
P-LISBON 1
Tel: (19) 68-60-72
Telex: 12598
CH,CS,E,P

PUERTO RICO

Hewlett-Packard Puerto Rico
Ave. Muñoz Rivera #101
Esq. Calle Ochoa
HATO REY, Puerto Rico 00918
Tel: (809) 754-7800
Hewlett-Packard Puerto Rico
Calle 272 Edificio 203
Urb. Country Club
RIO PIEDRAS, Puerto Rico
P.O. Box 4407
CAROLINA, Puerto Rico 00628
Tel: (809) 762-7255
A,CH,CS

QATAR

Compute Arabia
P.O. Box 2750
DOHA
Tel: 883555
Telex: 4806 CHPARB
P
Eastern Technical Services
P.O. Box 4747
DOHA
Tel: 329 993
Telex: 4156 EASTEC DH
Nasser Trading & Contracting
P.O. Box 1563
DOHA
Tel: 22170, 23539
Telex: 4439 NASSER DH
M

SAUDI ARABIA

Modern Electronic Establishment
Hewlett-Packard Division
P.O. Box 22015
Thuobah
AL-KHOBAR
Tel: 895-1760, 895-1764
Telex: 671 106 HPMEEK SJ
Cable: ELECTA AL-KHOBAR
CH,CS,E,M
Modern Electronic Establishment
Hewlett-Packard Division
P.O. Box 1228
Redec Plaza, 6th Floor
JEDDAH
Tel: 644 38 48
Telex: 4027 12 FARNAS SJ
Cable: ELECTA JEDDAH
CH,CS,E,M
Modern Electronic Establishment
Hewlett-Packard Division
P.O. Box 22015
RIYADH
Tel: 491-97 15, 491-63 87
Telex: 202049 MEERYD SJ
CH,CS,E,M
Abdul Ghani El Ajou
P.O. Box 78
RIYADH
Tel: 40 41 717
Telex: 200 932 EL AJOU
P

SCOTLAND

See United Kingdom

SINGAPORE

Hewlett-Packard Singapore (Sales)
Pte. Ltd.
#08-00 Inchcape House
450-2 Alexandra Road
P.O. Box 58 Alexandra Rd. Post Office
SINGAPORE, 9115
Tel: 631788
Telex: HPSGSO RS 34209
Cable: HEWPACK, Singapore
A,CH,CS,E,MS,P

