



HP 4957A  
Protocol Analyzer

# Operating and Reference Manual

## HP 4957A Protocol Analyzer



**HEWLETT  
PACKARD**

**HP Part No. 04957-99901  
Microfiche Part No. 04957-98801  
Printed in U.S.A. July 1991**

**First Edition  
E0791**



---

## Manufacturer's Declaration

The following certification (shown in German, followed by an English translation) applies only to products shipped into Germany after June 1, 1985.

### Herstellerbescheinigung

Hiermit wird bescheinigt, daß das Gerät/System

#### HP 4957A Protocol Analyzer

in Übereinstimmung mit den Bestimmungen der Postverfügung 1046/84 funkentstört ist.

Der Deutschen Bundespost wurde das Inverkehrbringen dieses Gerätes/Systems angezeigt und die Berechtigung zur Überprüfung der Serie auf Einhaltung der Bestimmungen eingeräumt.

### Zusatzinformation für Meß- und Testgeräte

Werden Meß- und Testgeräte mit ungeschirmten Kabeln und/oder in offenen Meßaufbauten verwendet, so ist vom Betreiber sicherzustellen, daß die Funkentstörbestimmungen unter Betriebsbedingungen an seiner Grundstücksgrenze eingehalten werden.

### Manufacturer's Declaration

This is to certify that the equipment

#### HP 4957A Protocol Analyzer

is in accordance with the Radio Interference Requirements of Directive FTZ 1046/1984.

The German Bundespost was notified that this equipment was put into circulation. The right to check this model type for compliance with these requirements was granted.

### Additional Information for Test and Measurement Equipment

If Test and Measurement Equipment is operated with unshielded cables and/or used for measurements on open set-ups, the user has to assure that under operating conditions the Radio Interference Limits are still met at the border of his premises.

---

## Printing History

New editions are complete revisions of the manual. Update packages are issued between editions. They contain additional and replacement pages to be merged into the manual by the customer. The dates on the title page change only when a new edition or a new update is published. No information is incorporated into a reprinting unless it appears as a prior update. The edition does not change when an update is incorporated.

Many product updates and fixes do not require manual changes and, conversely, manual corrections may be done without accompanying product changes. Therefore, do not expect a one-to-one correlation between product updates and manual updates

July 1991

First Edition

---

# Safety

Prior to operation of the equipment you must examine the instrument and review this documentation to ensure you are completely familiar with all of the safety markings and the operating instructions.

The following WARNINGS define operating procedures, practices, etc., which, if not correctly followed, could result in the personal injury or loss of life.

---

**WARNING**

---

This product is a **Safety Class 1** instrument with a protective earth terminal.

---

**WARNING**

---

For protection from electric shock hazard, power cord ground must not be defeated.

---

## Operating Restrictions

The following general safety precautions must be observed during all phases of operation, service, and repair of this instrument. Failure to comply with these precautions with specific warnings in this manual violate safety standards of design, manufacture, and intended use of this instrument. Hewlett-Packard Company assumes no liability for the customer's failure to comply with these requirements.

---

## Grounding

To minimize shock hazard, the instrument chassis and cabinet must be connected to an electrical ground. The instrument is equipped with a three-conductor AC power cable compatible with an approved three-contact electrical outlet. The power jack and mating plug of the power cord must meet International Electrotechnical Commission (IEC) safety standards.

---

## Environment

Do not operate the instrument in the presence of flammable gases or fumes. Operation of any electrical instrument in such an environment constitutes a definite safety hazard.

---

## Service and Adjustment

Dangerous voltages exist within this instrument. Service and adjustment of this instrument is to be performed only by trained service personnel. Operating personnel are not authorized to remove the instrument covers or to perform any internal service or adjustment procedure.

Do not replace components with the power cable connected. Dangerous voltages may be present even when the power cable is disconnected.

Do not perform internal servicing or adjustment unless another person, capable of rendering first aid and resuscitation is present.

---

## CRT Handling

Rough handling or jarring of the instrument can break the CRT (cathode ray tube). The resulting implosion will scatter glass fragments at high velocity. Removal or installation of the CRT is to be performed only by qualified maintenance personnel using approved safety mask and gloves.

---

## Unauthorized Service

The installation of substitute parts or the installation of any instrument modification not authorized by Hewlett-Packard is specifically forbidden. The performance of such unauthorized service can negate the instrument warranty or any maintenance agreements.

Return the instrument to a Hewlett-Packard Sales and Service Office for authorized service and repair.



---

## About this manual . . .

This manual describes the HP 4957A protocol analyzer and explains how to use and implement the functionality of each feature. It is designed to assist you in using the protocol analyzer to troubleshoot your network quickly and efficiently.

This manual is divided into Part 1 and Part 2. Part 1 is comprised of Chapters 1 through 7. Each chapter details different aspects of using the protocol analyzer. In all cases, extensive use of real applications and examples are there to assist you.

Part 1 is designed to help you use the instrument with step-by-step instructions on all basic activities to support your measurement needs.

- *Chapter 1, Getting Started:* Explains how to set up, apply power, use the front panel, what is on the rear panel, how to use side panel, how to manage your storage devices, and how to move in the user interface.
- *Chapter 2, Analyzing Live Data:* Explains how to write programs to capture live data for monitoring and simulating.
- *Chapter 3, Analyzing Captured Data:* Explains how to evaluate data that you have captured. This chapter offers extensive use of the Examine Data menu and how to make specific measurements in all of the display formats.
- *Chapter 4, Making a BERT Measurement:* Explains how to make BERT measurements, both local and remote and how to interpret the results.
- *Chapter 5, Transfer and Control in Remote:* Explains how to connect and make remote measurements for both the controller and slave.
- *Chapter 6, Transfer and Control in Remote:* Explains how to use the HP 4957A as a terminal emulator using the VT100 application.
- *Chapter 7, Printing a Hardcopy:* Explains how to print your results, menus, and measurements to an ASCII printer.

Part 2 is a reference section to this manual. This section explains, completely and technically, all functions and how to implement them.

- *Chapter 8, Programming Reference:* Details all programming commands, where they appear, and how to implement them. This chapter also contains examples with some tips to expand your programming needs.
- *Chapter 9, Setup and Line Parameters:* Explains how the HP 4957A implements all line parameters and the best techniques to set the protocol analyzer to conform to the line.
- *Chapter 10, Supplied Software:* The HP 4957A is supplied with several ROM based applications, as well as the utility disk with several more frequently used applications. This chapter explains how and where to use them.
- *Chapter 11, Softkey Reference:* Explains what each softkey is used for and where to find them.
- *Chapter 12, Specifications and Accessories:* Lists all of the instrument specifications, operating characteristics, additional options and accessories that are available for the protocol analyzer.
- *Chapter 13, Error Messages:* Error messages and corrective actions.

---

# Printing Conventions

In all cases, throughout this manual, softkey labels are shown in **inverse video** exactly as they appear on the screen. Hardkeys that are on the keyboard are represented in standard **Keycap**.

In some cases, you must press two keys simultaneously, such as **CNTL Q**.

If certain actions present a danger:

---

## WARNING

---

An operating procedure, practice, etc., which, if not correctly followed, could result in personal injury or loss of life.

---

## CAUTION

---

An operating procedure, practice, etc., which, if not strictly observed, could result in damage to, or destruction of, equipment or software.

If additional or background information is appropriate or necessary:

**Boxed information**

Explanatory comments or supplementary instructions are presented in boxed format.

---

# Contents

<b>1. Getting Started</b>	
Initial Inspection . . . . .	1-3
Shipping the Instrument . . . . .	1-3
Front Panel and Keyboard . . . . .	1-4
Display . . . . .	1-4
Disk Drive . . . . .	1-4
LEDs . . . . .	1-6
Keyboard . . . . .	1-6
Side Panel . . . . .	1-7
Breakout Box . . . . .	1-7
Mark/Space Indicator . . . . .	1-7
Source Voltage . . . . .	1-7
Disconnect Switches . . . . .	1-8
Rear Panel . . . . .	1-9
To change the fuse: . . . . .	1-9
Applying Power . . . . .	1-10
To turn the analyzer on: . . . . .	1-10
To turn the analyzer off: . . . . .	1-11
Selecting the Physical Interface . . . . .	1-12
To select the interface: . . . . .	1-12
Connecting an External Interface . . . . .	1-14
To connect an external pod: . . . . .	1-14
Managing Mass Store Devices and Applications . . . . .	1-15
To delete a file: . . . . .	1-16
To delete all files on a disk: . . . . .	1-16
To recover a file: . . . . .	1-17
To rename a file: . . . . .	1-17
To format a disk: . . . . .	1-18
To pack disk: . . . . .	1-18
To copy a disk: . . . . .	1-19
Loading from Floppy Disk . . . . .	1-20
To load data from disk: . . . . .	1-20
To load an application: . . . . .	1-21
To back up your RAM Disk: . . . . .	1-22
Cleaning the Disk Drive . . . . .	1-23
To clean the disk drive: . . . . .	1-23

Resetting to Default Parameters . . . . .	1-24
To clear the buffer and application memory: . . . . .	1-24
Connecting an External Monitor . . . . .	1-25
To connect an external monitor: . . . . .	1-25
<b>2. Analyzing Live Data</b>	
Using your Protocol Analyzer Efficiently . . . . .	2-3
Ease of Programming . . . . .	2-4
Defining Triggers . . . . .	2-4
Setting up to Monitor . . . . .	2-5
To set up to monitor: . . . . .	2-6
Monitoring and Capturing Data . . . . .	2-8
To write a monitor program: . . . . .	2-8
To load a monitor program: . . . . .	2-10
Level 2 When String . . . . .	2-14
Capturing High Speed Data . . . . .	2-20
To capture high speed data: . . . . .	2-21
High Speed Capture Limits . . . . .	2-23
Setting up to Simulate . . . . .	2-24
To set up to Simulate: . . . . .	2-24
Simulating and Capturing Data . . . . .	2-26
To write a simulate program: . . . . .	2-26
Level 3 Send String . . . . .	2-28
Storing Instrument Configurations and Data . . . . .	2-34
To store to disk while running: . . . . .	2-34
To store to disk: . . . . .	2-35
<b>3. Analyzing Captured Data</b>	
Viewing Data . . . . .	3-3
To view data: . . . . .	3-3
Measuring Time . . . . .	3-4
To measure timing intervals: . . . . .	3-4
Changing Display Formats . . . . .	3-6
To change display format: . . . . .	3-7
Measuring Captured Data . . . . .	3-8
To post-process data: . . . . .	3-8
Timing Resolution . . . . .	3-10

**HP Computer Museum**  
**[www.hpmuseum.net](http://www.hpmuseum.net)**

**For research and education purposes only.**

<b>4. Making a BERT Measurement</b>	
Running a BERT Test . . . . .	4-3
To make a BERT measurement: . . . . .	4-4
To make a remote BERT test: . . . . .	4-6
BERT Results . . . . .	4-8
<b>5. Transfer and Control in Remote</b>	
Connecting for Remote Operation . . . . .	5-4
To connect for remote: . . . . .	5-4
Placing a Remote Call from the Controller . . . . .	5-6
To set up the controller: . . . . .	5-6
To place a call: . . . . .	5-7
To download applications: . . . . .	5-9
To download a menu: . . . . .	5-10
To download data: . . . . .	5-11
To upload to a controller: . . . . .	5-12
Receiving a Remote Call as a Slave . . . . .	5-13
To set up the slave: . . . . .	5-13
Ending Remote Operations . . . . .	5-15
To break a link: . . . . .	5-15
Remote Restrictions . . . . .	5-16
With Modems . . . . .	5-16
With an X.25 PAD . . . . .	5-17
<b>6. Using the VT100 Terminal Emulator</b>	
VT100 Emulator . . . . .	6-3
To load the emulator: . . . . .	6-4
To set up the emulator: . . . . .	6-5
To use the emulator: . . . . .	6-8
Working with Control Characters . . . . .	6-10
To use escape codes: . . . . .	6-11
<b>7. Printing a Hardcopy</b>	
Printing . . . . .	7-3
To set up to print: . . . . .	7-3
To print from menus: . . . . .	7-6
To print from the buffer: . . . . .	7-7
Printed Characters . . . . .	7-10
Hexadecimal Characters . . . . .	7-10
ASCII Control Characters . . . . .	7-10
Special Characters . . . . .	7-11

Lead Levels . . . . .	7-11
<b>8. Programming Reference</b>	
Editing Programs . . . . .	8-3
Executing Programs . . . . .	8-4
Restrictions . . . . .	8-4
Defining Triggers . . . . .	8-5
Triggers Provide a Reference . . . . .	8-6
Types Of Triggers . . . . .	8-7
Characters . . . . .	8-7
Leads . . . . .	8-10
Errors . . . . .	8-11
Softkeys . . . . .	8-12
Multiple Triggers . . . . .	8-13
ORing Triggers . . . . .	8-13
Sequencing Triggers . . . . .	8-14
Overlapping and Duplicate Triggers . . . . .	8-14
Marking Triggers . . . . .	8-16
Beep . . . . .	8-16
Highlight . . . . .	8-16
Measuring Time . . . . .	8-17
Time Stamps . . . . .	8-17
Timers . . . . .	8-17
The Effect Of the Data Filter On Timing . . . . .	8-18
Lead Changes . . . . .	8-19
Counting Events . . . . .	8-22
Countable Events . . . . .	8-22
Branching . . . . .	8-23
Conditional Branching . . . . .	8-23
Unconditional Branching . . . . .	8-25
Program Pauses . . . . .	8-26
Starting and Stopping . . . . .	8-27
Filtering Data With 'Start' and 'Stop' . . . . .	8-27
'Start' and 'Stop' Disk . . . . .	8-28
'Start' and 'Stop' Display . . . . .	8-29
Stop Tests . . . . .	8-29
Commenting . . . . .	8-30
Entering Messages . . . . .	8-30
Displaying Messages During Execution . . . . .	8-31
Subprograms . . . . .	8-32
Level 2 Programming . . . . .	8-34



Address Field . . . . .	8-34
Frame Type . . . . .	8-35
Level 3 Programming . . . . .	8-37
Selecting Level 3 Before Level 2 . . . . .	8-38
Conditions when Simulating . . . . .	8-40
Block Check Characters . . . . .	8-40
Frame Check Sequence . . . . .	8-41
Set Lead . . . . .	8-42
<b>9. Setup and Line Parameters</b>	
Using Auto Configure . . . . .	9-3
To use Auto Configure: . . . . .	9-3
Auto Configure Algorithm . . . . .	9-5
Auto Configure As a Starting Point . . . . .	9-7
Using the Setup Menu . . . . .	9-10
When To Use the Setup Menu . . . . .	9-11
Configuring to Protocols . . . . .	9-12
Bit Oriented Protocols (BOPs) . . . . .	9-12
Bisync (BSC) Setup Definitions . . . . .	9-14
Character-Oriented Protocols (COPs) . . . . .	9-15
Capturing Unknown Data . . . . .	9-20
Eliminating Superfluous Data . . . . .	9-21
Unusual Protocol Settings . . . . .	9-22
<b>10. Supplied Software</b>	
Counter Math . . . . .	10-3
To load the application: . . . . .	10-3
To use Counter Math: . . . . .	10-5
Using the IPARS Application . . . . .	10-9
IPARS Setup Menu . . . . .	10-10
Modified Error Check (MEC) . . . . .	10-11
DCE BERT . . . . .	10-12
Using DCE BERT . . . . .	10-13
X.25 Analysis and Filter . . . . .	10-15
To set up the filter: . . . . .	10-15
To run the application: . . . . .	10-18
To define the display format: . . . . .	10-18
To define header information: . . . . .	10-20
Using Extended Asynchronous Baud Rates . . . . .	10-24
To select the Extended Asynchronous Baud Rates: . . . . .	10-24

**11. Softkey Reference**

Softkeys . . . . . 11-3  
Softkey Menus in the Top Level . . . . . 11-3  
Embedded Softkeys . . . . . 11-4

**12. Specifications and Accessories**

Specifications . . . . . 12-3  
Physical Size . . . . . 12-3  
Electrical Requirements . . . . . 12-3  
Operating Characteristics . . . . . 12-4  
Protocols . . . . . 12-4  
Data Transmission Modes . . . . . 12-4  
Data Transfer Rates (bps) . . . . . 12-4  
Data Codes . . . . . 12-5  
Capture Memory (Circular) . . . . . 12-5  
Mass Storage . . . . . 12-5  
Lead Status . . . . . 12-6  
VT100 . . . . . 12-7  
Triggers . . . . . 12-8  
Setups . . . . . 12-8  
Physical Instrument . . . . . 12-9  
Remote Capability . . . . . 12-9  
Bit Error Rate Testing . . . . . 12-10  
Accessories . . . . . 12-11  
Options and other Accessories . . . . . 12-11

**13. Error and Status Messages**

Error Messages . . . . . 13-3  
Status Messages . . . . . 13-25

**Index**

---

# Figures



1-1. HP 4957A Keyboard and Front Panel . . . . .	1-5
1-2. The HP 4957A Side Panel . . . . .	1-8
1-3. The HP 4957A Rear Panel . . . . .	1-9
1-4. The Top Level Menu . . . . .	1-11
1-5. Interface Select . . . . .	1-12
1-6. The Application Load Menu . . . . .	1-21
1-7. The Reset Caution . . . . .	1-24
2-1. Hook up to Monitor the Line . . . . .	2-5
2-2. The Setup Menu (typical for BOPs) . . . . .	2-6
2-3. The Monitor Menu . . . . .	2-9
2-4. Defining a Trigger . . . . .	2-14
2-5. Selecting an Information Frame . . . . .	2-15
2-6. Defining Poll/Final Bit . . . . .	2-16
2-7. Defined Frame . . . . .	2-17
2-8. Setup Menu with High Speed Capture . . . . .	2-21
2-9. Selection Screen for High Speed Capture . . . . .	2-22
2-10. Hook up to Simulate . . . . .	2-25
2-11. Developing a Level 3 Send String . . . . .	2-28
2-12. Selecting GFI in Level 3 Send String . . . . .	2-29
2-13. Mod 8 and LCN in Level 3 Send String . . . . .	2-30
2-14. Entering Data in a Level 3 Send String . . . . .	2-31
3-1. Demonstration Data in Two Line Format . . . . .	3-3
3-2. Timing Interval in Data & State Format . . . . .	3-5
3-3. Data & State Format . . . . .	3-7
3-4. Measuring Frame Time from the Buffer . . . . .	3-9
3-5. Timers and Counters . . . . .	3-10
4-1. Connection for End-to-End Testing . . . . .	4-3
4-2. The BERT Setup Menu . . . . .	4-4
4-3. Connection for Loopback Testing . . . . .	4-5
5-1. Data Transfer . . . . .	5-3
5-2. The Remote Connection . . . . .	5-5
5-3. The Controller Setup Menu . . . . .	5-8
5-4. The Slave Menu . . . . .	5-14
6-1. Terminal Emulator Menu . . . . .	6-4
6-2. Terminal Setup Menu . . . . .	6-6
6-3. Automatic Setup . . . . .	6-7
6-4. Ready to Start a VT-100 Emulate Session . . . . .	6-9

## Contents

7-1. Print Setup Menu . . . . .	7-5
7-2. Printed Output in Two Line Format . . . . .	7-7
7-3. Printed Output in Data & State Format . . . . .	7-8
9-1. Auto Configure Algorithm . . . . .	9-6
9-2. The Setup Menu . . . . .	9-11
10-1. Counter Math Program . . . . .	10-4
10-2. DCE BERT Asynchronous Setup Menu . . . . .	10-12
10-3. DCE BERT Synchronous Setup Menu . . . . .	10-13
10-4. DCE BERT Isochronous Setup Menu . . . . .	10-14
10-5. X.25 Filter Setup Menu . . . . .	10-16
10-6. X.25 Display Definition Setup Menu . . . . .	10-18
10-7. X.25 Display Column Selections . . . . .	10-19
10-8. X.25 Header Selections . . . . .	10-20

---

## Tables

2-1. Information stored with Each File Type . . . . .	2-36
3-1. Timing Resolution . . . . .	3-10
4-1. Maximum Count Parameters . . . . .	4-5
6-1. Active Control Characters . . . . .	6-10
7-1. Available Print Data per Menu . . . . .	7-6
7-2. Displayed Special Characters . . . . .	7-11
8-1. Error Triggers per Setup Parameters . . . . .	8-11
8-2. Timing Resolution . . . . .	8-21
8-3. Cursor Timing Limits . . . . .	8-21
9-1. BOPs Setup from Auto Configure . . . . .	9-8
9-2. Synchronous COPs Setup from Auto Configure . . . . .	9-9
9-3. Asynchronous COPs Setup from Auto Configure . . . . .	9-9
9-4. Character Frame Sizes vs. Data Code . . . . .	9-21
9-5. Unusual Protocol Settings . . . . .	9-22
10-1. Display Definition Header Selections . . . . .	10-22
10-2. . . . .	10-23

## Contents



---



## Manual Update

for the HP 18283A/18284A User's Guide

HP Part Number 18283-99501

Please make the following changes to your manual:

Pages 2-5 through 2-8.

The HP 18283A/18284A ISDN Analysis software filenames have changed from:

ISDN_APPL	to	ISDN_2_AP
ISDN_LIB1	to	ISDN_2_L1
ISDN_LIB2	to	ISDN_2_L2
ISDN_LIB3	to	ISDN_2_L3

HP Part No. 5090-4039  
Microfiche No. 5090-4040

August 1990







---

## Getting Started

---

# Getting Started

The HP 4957A is a lightweight, general-purpose protocol analyzer that you can use to troubleshoot and maintain your network, anticipate trouble spots, and minimize down-time. It can be used to test your level 1 connections, level 2 data links, and level 3 packets. You can make measurements, run tests, and replace network devices through interactive programs, either locally or remotely.

Use this manual to learn how to use the HP 4957A. You can follow the step-by-step instructions in the first seven chapters and learn the user interface. The remaining five chapters offer detailed information and help for complex problem solving.

Chapter 1 explains how to use the protocol analyzer to better manage your data. You can:

- Unpackage the HP 4957A
- Plug it in
- Change the fuse
- Select the physical interface
- Hook up external video if you want a larger display
- Manage all memory and disks
- Maintain the disk drive

There are several functions you must be familiar with before capturing and evaluating data. As you use the protocol analyzer to capture data and troubleshoot your network you accumulate large amounts of data that will become cumbersome to work with. In this chapter you will learn how to maintain the protocol analyzer and manage your data.

---

## Initial Inspection

Inspect the shipping container for damage. Keep it until the contents have been checked mechanically and electrically. Pay close attention when opening the shipping container. Make sure you have received the entire shipment with all appropriate options and manuals. The standard HP 4957A is equipped with:

- RS-232C (V.24) cable
- RS-449 Y-cable
- V.35 Y-cable
- Protective Front Panel Cover
- Jumper wires for the RS-232C (V.24) breakout box
- Operating and Reference Manual
- Datacommunications Test Library
- Utility Disk

Notify the nearest Hewlett-Packard service representative if the contents are not complete or there is apparent mechanical damage or defects. Keep all shipping materials for the carrier's inspection. The Hewlett-Packard office will arrange for repair or replacement without waiting for claim settlement.

---

## Shipping the Instrument

Contact the nearest Hewlett-Packard Field Repair Center or Sales and Support office for complete shipping instructions if you must return your protocol analyzer for service.

### **Transportation Disk**

Always transport the HP 4957A with the yellow plastic transportation disk installed.

---

## Front Panel and Keyboard

The front panel and keyboard make the HP 4957A protocol analyzer easy to use.

---

### Display

The five inch screen displays 16 rows of 32 characters (unless you are using the VT-100 function). Softkey labels occupy the bottom two lines and correspond to the six unlabelled keys on the keyboard.

---

### Disk Drive

The 3 1/2 inch floppy disk drive is on the front panel for direct access and convenience.

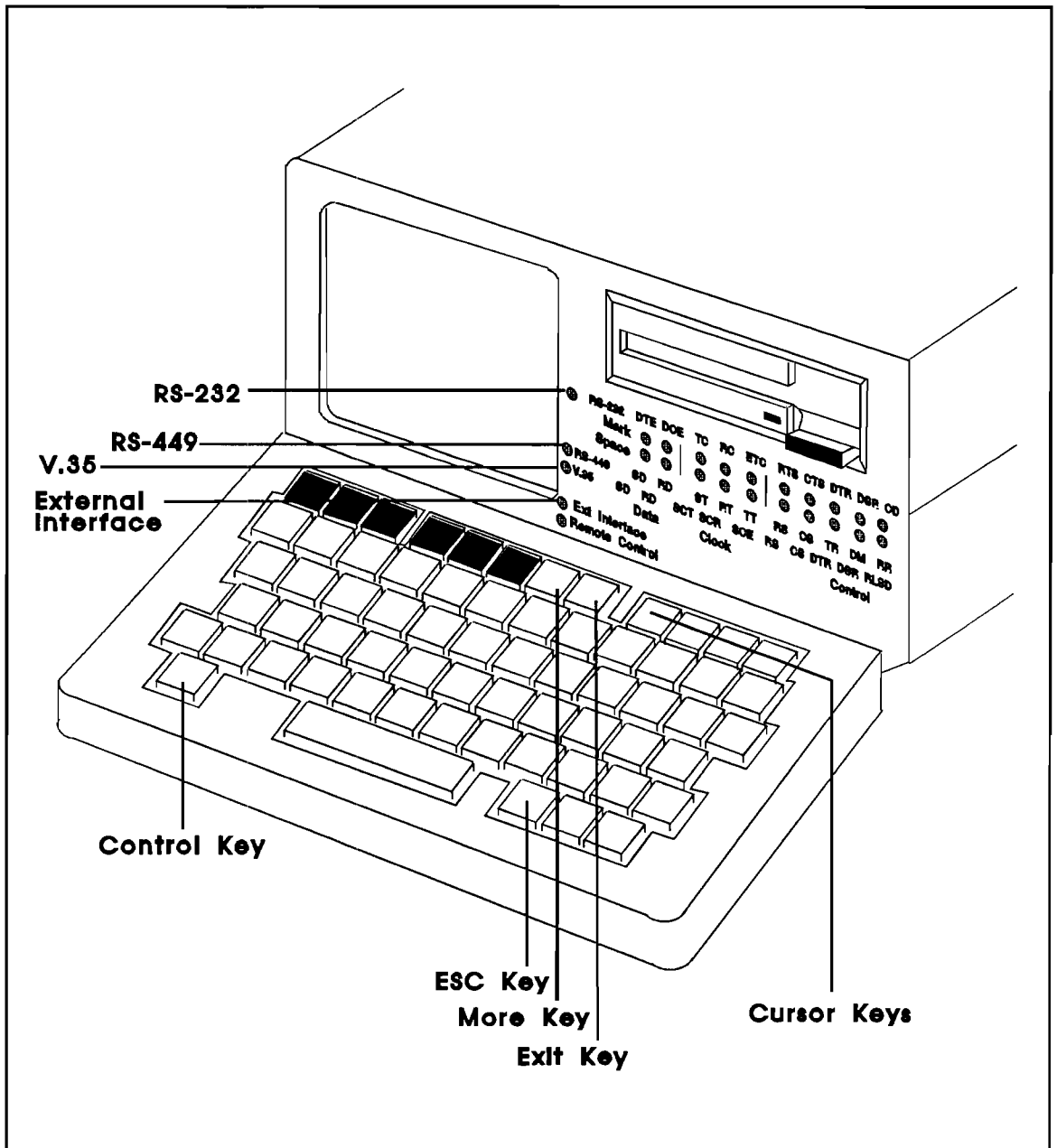

Figure 1-1. HP 4957A Keyboard and Front Panel

## LEDs

The HP 4957A has 10 pairs of LEDs to indicate lead status for all internal interfaces. Four LEDs indicate which interface is active; RS232, RS-449, V.35 or external. The last LED indicates if the protocol analyzer is operating in the remote mode.

The 10 pairs of lead status LEDs are three-state indicators:

- MARK - Red LED
- SPACE - Green LED
- High Impedance - Both LEDs off

---

## Keyboard

The keyboard is similar to a conventional typewriter keyboard. The **SHIFT** keys are used for capitalization while the **CNTL** key allows you to enter control characters directly from the keyboard.

Beside the six softkeys are the **MORE** and **EXIT** (HALT) keys. Press **MORE** for an extended selection of softkeys. MORE is displayed in the lower right corner of the screen . Press **EXIT** to back up a level in the menu structure or exit certain application programs. In the top right corner of the keyboard are the cursor movement keys used to move the cursor in the direction of the arrow between fields in the menu screens.

---

## Side Panel

The side panel of the HP 4957A is used to connect to an RS-232C/V.24 network. The connector on the right of the panel is used for a direct connection to the network, and the connector on the left of the panel is used to connect through the 25 pin breakout box.

---

## Breakout Box

The breakout box provides cross-patching, line-forcing, and monitoring capabilities for all RS-232C/V.24 lines. The switches isolate lines.

All 25 pins are brought out for jumpering on either side of the breakout switches. If your network cable has different pin assignments from the interface standard, use jumper wires to connect the interface lines to the desired pin on your cable.

---

## Mark/Space Indicator

Jumper any pin to this indicator to determine the state.

---

## Source Voltage

You may set any signal line on or off by jumpering to the available source voltage; +12 volts, or -12 volts.

## Disconnect Switches

Pins 2, 3, 4, 5, 6, 8, 15, 17, 20, and 24 can be individually disconnected from the data link by switches. This lets you isolate non-driven interface lines from the HP 4957A. Non-driven lines may develop crosstalk noise that can be mistaken for transitions by the protocol analyzer.

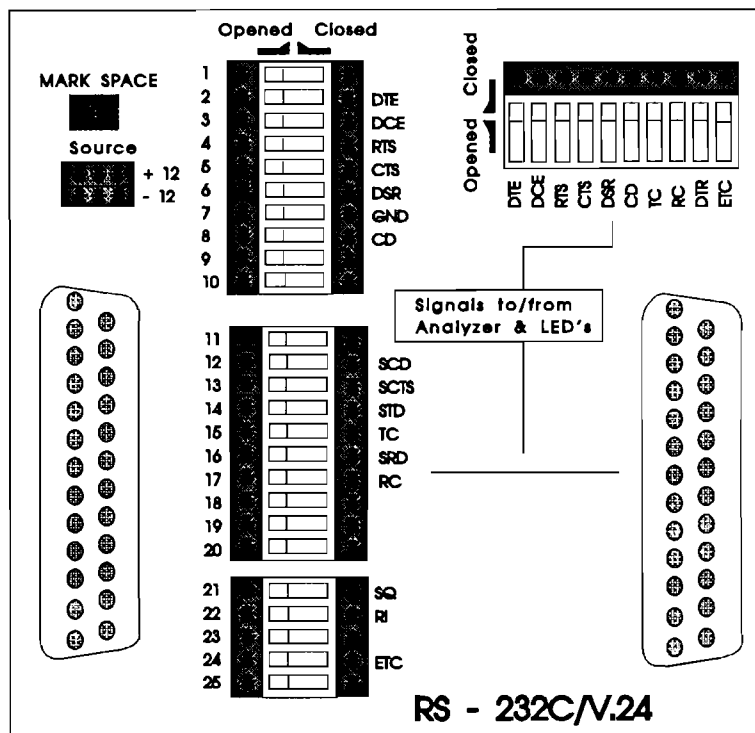

Figure 1-2. The HP 4957A Side Panel



---

## Rear Panel

The rear panel of the HP 4957A contains the V.35 and RS-449 interface connectors, external interface connector, remote/printer cable connector, external video BNC connector, and power switch.

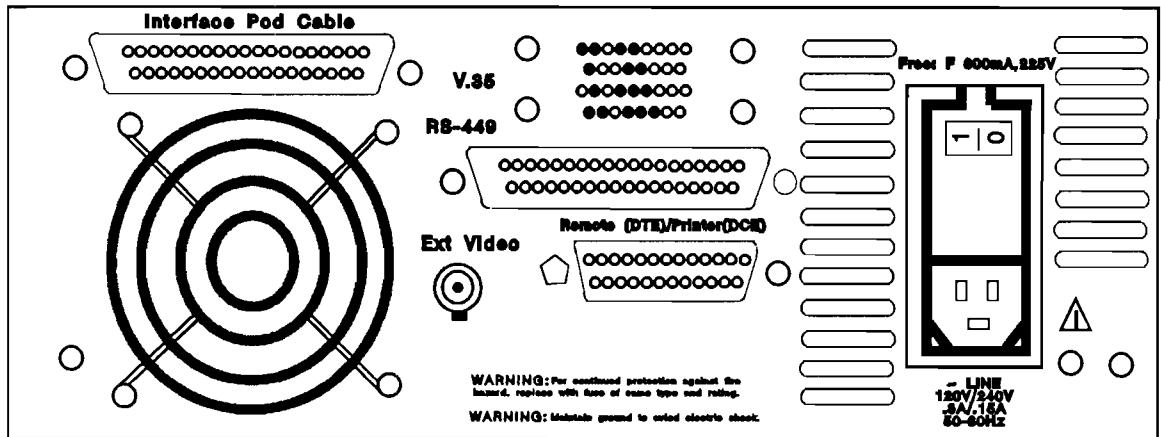

Figure 1-3. The HP 4957A Rear Panel

---

### To change the fuse:

1. Unplug the HP 4957A and remove the power cord.
2. Insert a small screwdriver in the slot at the top of the power switch and gently pry the cover from the switch.
3. Pull the gray fuse holder and replace the fuse. Use a 0.6A, 250V fuse for replacement (HP part number 2110-0758).
4. Insert the fuse holder and close the cover. Make sure the arrows are facing the same direction as the two arrows on the cover.

---

## Applying Power

Connect the HP 4957A to any AC power source from 90 to 264 volts and 48 to 66 Hz. An appropriate power cord is packaged with each analyzer. If your protocol analyzer has the wrong power cord, contact a Hewlett-Packard Sales and Support Office.

**Grounding Requirements.** The HP 4957A is equipped with a three-conductor power cable that grounds the protocol analyzer when connected to an appropriate power outlet.

---

### CAUTION

---

Do not operate while connected to line power with no ground protection.

---

### To turn the analyzer on:

1. Connect the AC power cord to the HP 4957A power cord connector and to an AC power source.
2. Set the power switch on the rear panel to the (1) position. After the protocol analyzer has completed the power up process, it should display the top level menu indicating that the instrument has passed a verification of its internal circuitry.

---

## To turn the analyzer off:

---

### CAUTION

---

To save setups, go to the top level menu before turning the instrument off. Otherwise, the analyzer may reset to default parameters when you turn it back on.

- Set the power switch on the rear panel to the (0) position from the Top Level Menu.

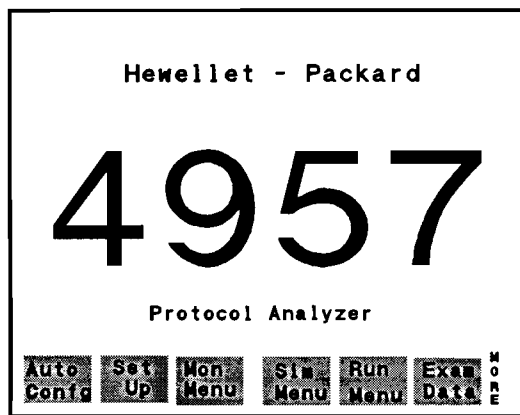

K1001

Figure 1-4. The Top Level Menu

---

# Selecting the Physical Interface

The HP 4957A can accommodate internal interfaces and external interfaces.

---

## To select the interface:

1. From the top level menu press **Run Menu**.
2. Press **Select Iface**.
3. Press the softkey corresponding to the interface you want to use.

The HP 4957A has three internal interfaces; RS-232, RS-449, and V.35. The green LED lights indicate which interface has been selected.

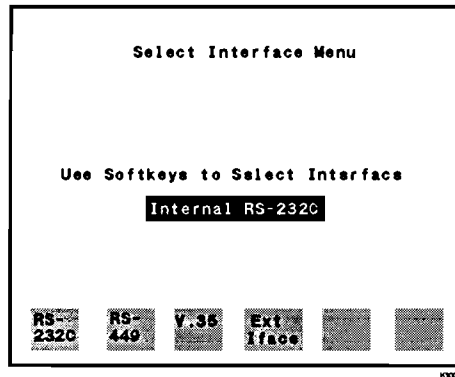

There are two connectors on the side panel for the RS-232 interface that has a complete 25 pin breakout capability (see Part 2, Chapter 12, Specifications and Characteristics). The RS-449, V.35, and external interface connectors are on the rear panel of the protocol analyzer.

**External Interfaces**

If you plan to work with X.21 or ISDN you need to connect an external pod. Make sure you have selected an external interface in the Interface menu.

The HP 4957A is compatible with all external interface pods used with the HP 4951C and HP 4952A.

---

## Connecting an External Interface

To use an external interface, such as X.21 or ISDN, you must connect an external pod and select an external interface. When you make the connection, the HP 4957A detects which pod is attached.

---

### To connect an external pod:

---

**CAUTION**

---

Make sure that instrument power is off when installing or removing any external interface pod.

1. Turn the HP 4957A protocol analyzer power off.
2. Connect the interface pod cable to the interface pod connector on the rear panel.
3. Tighten the connector screws so the cable will not easily pull off.
4. Connect the other end of the pod cable to the interface pod.

---

# Managing Mass Store Devices and Applications

The HP 4957A has two mass store devices (MSD), the floppy disk and the RAM disk. Both devices are accessible from the Mass Store menu. The floppy disk can be used to store data, menus, and applications; the RAM disk can store applications and menus.

**Floppy Disk.** A formatted floppy disk has 613 kbytes of memory and is given in 256 byte sectors (2452). You can use the floppy disk to store menus, extended menus, application programs, buffer data, and an undefined file type. The undefined file type indicates that either the application supporting the file is not loaded or that the file is from an unsupported instrument.

**RAM Disk.** The RAM disk has 128 kbytes of nonvolatile memory for menus, extended menus, and application programs. This memory is given in kbytes.

**Mass Store Menu.** The Mass Store menu of the HP 4957A allows you to manage the RAM disk and floppy disks efficiently. Any time you press **Mass Store**, the protocol analyzer displays a directory of the active Mass Store device (MSD). The active MSD is listed in the top right corner of the display, for example: **MSD = Disk** or **MSD = RAM**. Also, you can press the **Dir** softkey and get a directory at any time.

In the Mass Store menu you can:

- Get a directory listing of the active disk
- Delete a file from the directory
- Recover a file that has been marked for deletion
- Rename a file that is on the directory
- Format a disk
- Pack the disk

To properly manage your mass store devices you must be able to copy the entire disk contents to another disk. You can do this with the Copy\_Disk Application menu.

## To delete a file:

The delete function marks the file for deletion. The actual deletion is executed when you pack the disk. You can recover the file that has been marked for deletion by using the Recover function. The file is still recoverable by using Recover before you pack the disk.

1. From the top level menu, press **Mass Store**.
  2. Move the cursor and highlight the file want to delete or you can enter the file name from the keyboard.
  3. Press **Delete** and then press **Execute**. When the operation is complete, the directory is displayed again. Notice that the file you just deleted has not been removed but has been marked Del on the far right.
  4. Press **Pack Disk** and then press **Execute**. The directory is displayed again with the file removed.
- 

## To delete all files on a disk:

1. Mark each file for deletion and press **Pack Disk**.
2. Press **Execute** or press **Format**, **Execute** and reinitialize the disk.
3. If a disk is full with few files the fastest way to delete the contents of the disk is press **Delete**, **Execute**, **Pack Disk**, **Execute**.



### To recover a file:

This function recovers files that have been marked for deletion. You must execute Recover before you pack the disk.

1. From the top level menu, press **Mass Store**.
  2. Move the cursor and highlight the file you need to recover or you can enter the file name from the keyboard.
  3. Press **Recover** and then press **Execute**. The directory is displayed again and the Del in the far right column has been removed.
- 

### To rename a file:

1. From the top level menu, press **Mass Store**.
2. Press **Rename**.
3. Fill in the new name from the keyboard. You have the option of clearing and reentering the Comment field.
4. Press **Execute**. The directory reappears with the new file name.

### To format a disk:

The HP 4957A uses a unique disk format, Line Interchange Format (LIF). You must format disks to be used in this protocol analyzer on an HP 4957A, 4951C, 4952A, or 4954A.

1. From the top level menu, press **Mass Store**.
  2. Press **(MORE)** and then press **Format**.
  3. Press **Execute**.
- 

### To pack disk:

The HP 4957A can pack a disk for more efficient use of disk space. This compresses the data and removes files marked for deletion.

1. From the top level menu, press **Mass Store**.
  2. Press **(MORE)** and press **Pack Disk**. The directory reappears with deleted files removed.
-

---

## To copy a disk:

Copy Disk allows you to duplicate the information on your flexible disks. This utility creates an image copy of the source disk on the destination disk(s).

### non-reproducible

Some software applications are not reproducible. They will appear to be copied, but are non-executable. When you load this type of application, the HP 4957A displays 'Application Denied'.

Before starting the Copy Disk utility, make sure you are copying to a formatted empty disk that is not write protected.

---

### CAUTION

---

The copy disk utility overwrites the destination disk with the **Write Disk** command and any previous information on the destination flexible disk is destroyed during the Copy Disk operation.

1. From the top level menu, press **(MORE)** and then press **Load Appl.**
2. Press **(V)** arrow key to move the cursor to COPY\_DISC and press **Execute.**
3. Press **(MORE)** and then press **Copy Disc.**
4. Press the **Read Disc** key and the display prompts you to install a source flexible disk.
5. After installing the source disk, press **Execute.**
6. Remove the source disk and install the destination disk. Press the **Write Disk** key, and then press **Execute.**

Once the source disk has been read, you can make multiple copies of the source disk. Just insert each destination disk in the disk drive and press the **Write Disk** key, and then the **Execute** key.

---

## Loading from Floppy Disk

You can get data in the buffer two ways, capturing live data by monitoring a line or by loading data from disk. You can load directly from the floppy disk to the capture buffer. You cannot store data to the RAM disk, therefore, you cannot load data from RAM.

---

### To load data from disk:

1. Insert the data disk in the disk drive. For this example use the file DEMO\_DATA on the Utility Disk.
2. Press **(MORE)** and **Mass Store**. The protocol analyzer displays the directory of the selected MSD.
3. Press **(v)** to move the cursor to the file DEMO\_DATA.
4. Press **Execute**. The protocol analyzer returns to the disk directory when the data is loaded into the buffer.
5. Press **(EXIT)** to return to the top level menu.

The directory lists the file name, file type, and memory that is used. The DEMO\_DATA file is 32 kbytes (16 blocks) of data.

---

## To load an application:

To place an application in the RAM disk, you must load the application from the floppy disk, place it in memory and then copy it to the RAM disk.

1. Insert the application disk in the disk drive.
2. Press **(MORE)** and **Load Appl**. The protocol analyzer searches all mass store devices for available applications and displays a directory of all devices and applications. Figure 1-6 reflects the ROM applications and the HP 4957A Utility Disk.
3. Press **(v)** until you highlight the application you wish to load and press **Execute**. The application is now in memory. Press **(EXIT)** to return to the top level menu.
4. Press **Mass Store** and **MSD=RAM** to select the RAM disk as the active destination mass store device.
5. Press **Store** and press **Execute**. You must enter a name for the application and can enter an optional comment.

---

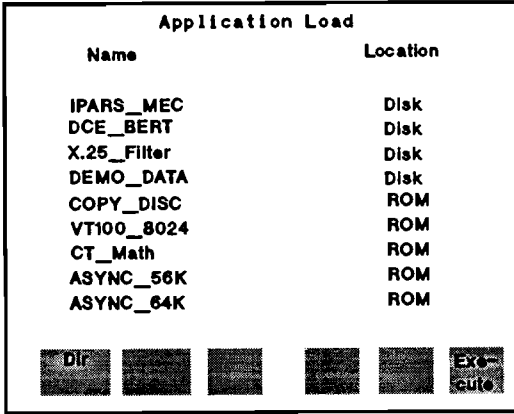

Application Load	
Name	Location
IPARS_MEC	Disk
DCE_BERT	Disk
X.25_Filter	Disk
DEMO_DATA	Disk
COPY_DISC	ROM
VT100_8024	ROM
CT_Math	ROM
ASYNc_56K	ROM
ASYNc_64K	ROM

Dir [ ] [ ] [ ] [ ] [ ] Execute

K1006

Figure 1-6. The Application Load Menu

## To back up your RAM Disk:

You can back up your RAM disk using the Archive function. This function resides in the Copy Disk utility. Archive creates a disk image of the entire contents of the RAM disk and writes it to floppy disk. Restore copies your archived disk contents back to the RAM disk.

**Archiving.** The protocol analyzer writes the entire RAM disk contents to floppy disk. The new file appears in the floppy disk directory as file type 4957Archive and takes 513 sectors.

1. Load the Copy Disk utility.
2. From the Copy Disk directory, press **(MORE)**, and press **Archive**.
3. The protocol analyzer prompts you for a file name. Enter the file name from the keyboard.
4. Change the Comment field (optional).
5. Press **Execute**.

**Restoring.** The protocol analyzer loads this file in RAM disk. Because the file type is unique, you cannot load this file back into the RAM disk using the Mass Store menu. You must:

1. Insert the archived disk into the disk drive.
2. Load the Copy Disk utility.
3. From the Copy Disk directory, press **(v)** and highlight the archive file.
4. Press **(MORE)** and **Restore**.

---

## Cleaning the Disk Drive

The disk drive does not need routine preventive maintenance, however, as with any mechanical device it can get dirty. A dirty disk drive usually means dirty heads that can cause excessive read errors from a disk.

Use a head cleaning disk (such as HP part number 09122-89415) to clean the heads of the HP 4957A.

---

### To clean the disk drive:

1. Turn the analyzer off and remove any floppy disks that are in the disk drive.
2. Turn the analyzer on and reset the menus.
3. Press **(MORE)** and then **Mass Store** .
4. Insert the cleaning disk in the disk drive.
5. Press **Dir** to activate the cleaning process.

An on-screen message indicates the cleaning disk is a single-sided disk. The disk drive light will be on during the process.

**Disk Out**

The message Disk Out will blink on the screen indicating there is no disk in the drive.

---

## Resetting to Default Parameters

Once an application is loaded, you must reset the application before the **Load Appl** softkey reappears on the top level menu. When **Load Appl** reappears you can load another application.

---

To clear the buffer and application memory:

1. From the top level menu, press **(MORE)** and **Reset**.
2. Press **Reset Menu**.
3. From the top level menu, press **(MORE)** and **Reset**.
4. Press **Reset Applic** to remove any application programs.

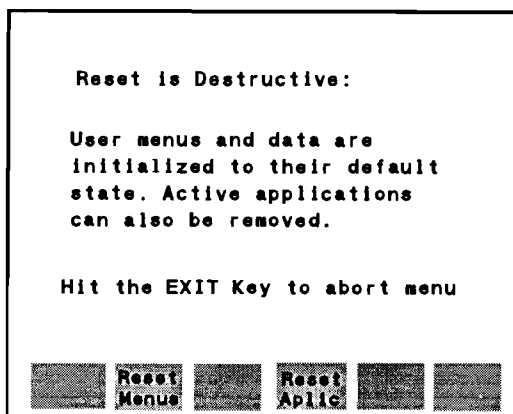

K1006

Figure 1-7. The Reset Caution



---

## Connecting an External Monitor

The HP 4957A has an external video connector on the rear panel. This can be used to connect a larger video monitor if you need a larger display. The monitor shows exactly the same data that is on the protocol analyzer display.

---

### To connect an external monitor:

1. Connect a 75 $\Omega$  coaxial cable with BNC connectors to the video output of the HP 4957A.
2. Connect the other end of the BNC cable to the video input connector of a video monitor.

The external video connector is on the rear panel of the HP 4957A.

#### **Video Monitor**

It is highly recommended that a video monitor is used (such as the HP 82913A) instead of a standard television. The HP 4957A displays 100% of the signal, a standard television only displays 90%. You will not see the entire signal on a television monitor.

The HP 4957A implements the RS-170 electrical characteristic for monochrome video monitors of 525 lines per frame, 60 Hz refresh rate, and a horizontal scan rate of 15.75 kHz.

Getting Started

**Connecting an External Monitor**



---

Analyzing Live Data

---

# Analyzing Live Data

The most common method of analyzing live data is simply to hook up to a line and watch data as it scrolls across the display. This shows that the line is active and there is data. While you are monitoring, the protocol analyzer is constantly filling its internal buffer. This data is available for post-run analysis. However, this is not always an effective technique to evaluate the data and troubleshoot the network.

Besides simple monitoring, this chapter explains how to develop and use monitor or simulate programs for more complex analysis. Examples are shown that you can use for specific applications. The programs are entered in the Monitor and Simulate menu and are executed from the Run Menu. After executing the programs you will learn how to store them for later use and how to save instrument configurations that were used to develop the programs.

---

# Using your Protocol Analyzer Efficiently

An effective method to analyze data is to tell the HP 4957A to look for specific events. You can filter unnecessary events and selectively store to disk. The protocol analyzer can 'trigger' on pertinent events and accumulate data that is useful for analyzing. This technique captures data and makes more efficient use of the buffer.

The HP 4957A can be used efficiently if you:

- Write monitor or simulate programs and observe specific events that occur on the line.
- Load saved programs from RAM or floppy disk and reuse them without rewriting.

Using programs to test your line will maximize the use of your protocol analyzer.

## **HP Programs**

A Data Communications Test Library is provided with the HP 4957A. This Library consists of programs that you can use to make common tests of your line. These tests can be loaded and used as they are, or you can customize them for your own specific needs.

## Ease of Programming

The capability to select trigger events allows you to efficiently analyze the data that you are capturing. Triggering is the basis for programming. Triggers are the events you want the protocol analyzer to look for, such as characters, lead changes, or errors.

Once the analyzer finds the designated event; it can:

- beep
- highlight the event in the buffer
- count events
- measure time between events
- send data and set leads (simulate mode only)
- display a message
- start or stop the disk

---

## Defining Triggers

Triggers must be defined as a reference point. You can define triggers with 'when' statements in your programs. The 'when' statement is used in conjunction with the desired trigger action.

You must tell the analyzer precisely when to start or stop an action or the measurement may be misleading or inaccurate. To use a trigger event as a point of reference, action commands must follow 'when' statements. For example, to start a timer when a certain event occurs, place the 'when' statement first.

---

## Setting up to Monitor

Monitoring the line is a non-intrusive method of seeing what data is on the line. In this manner you can sample the data and look at it without disrupting the data stream. The connection requires both ends of the Y-cable on the same node. This places the protocol analyzer in a non-intrusive position to sample data.

The HP 4957A can be set up by using Auto Configure. This tells the protocol analyzer to evaluate the line parameters, make the necessary interface settings, and begin monitoring. Auto Configure works with most protocols and data codes, however, it may not find all the parameters if the protocol is nonstandard, there is insufficient information, or the data present is not random. If you know the interface parameters, you can set them manually in the Setup menu.

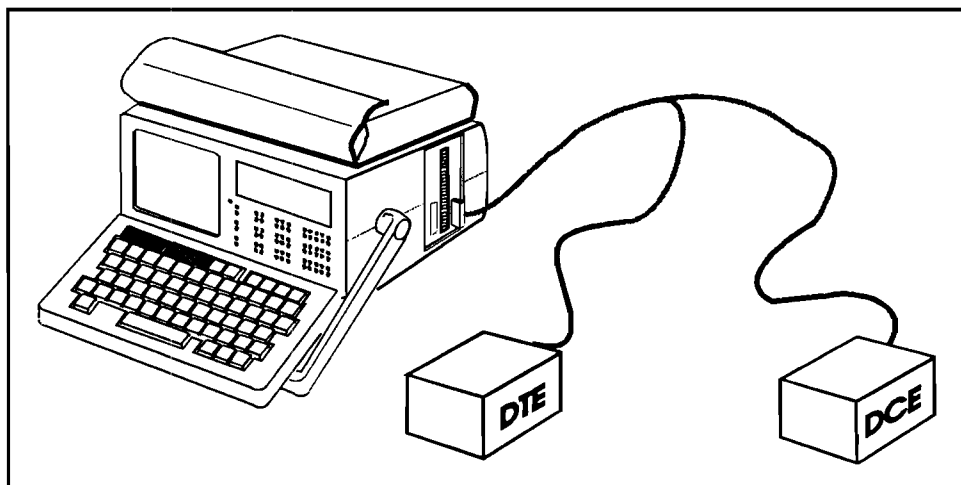
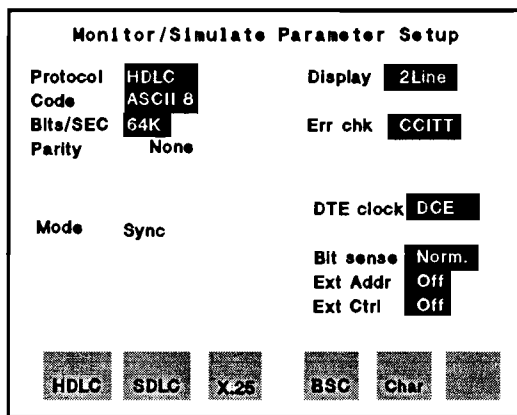

**Figure 2-1. Hook up to Monitor the Line**

---

## To set up to monitor:

1. Connect the HP 4957A to the line using the Y-cable (see Figure 2-1).
2. Turn off the HP 4957A and connect a pod (if you are using an external interface). Turn on, press **Run Menu**, **Select Iface** and select the physical interface.
3. Press **Auto Config**. The protocol analyzer displays a blinking asterisk to indicate that it is checking line data. If a good match is found, the protocol analyzer briefly displays the interface parameters and starts monitoring. If a good match is not found, the parameters that were previously set are restored.



K2002

Figure 2-2. The Setup Menu (typical for BOPs)



4. If a good match is not found or the data is unrecognizeable/inaccurate, press **EXIT** and then press **Setup Menu** to make any changes in the Setup, such as display mode.
5. Make any appropriate changes to the data parameters and press **EXIT**.
6. Return to monitoring by pressing **Run Menu** and then **Monitor Line**.

**Review the Setup**

While monitoring, you can, at any time press **Summary** to review the current parameters. You must exit and go to the Setup menu to change the display mode.

While monitoring, all data previously in the buffer is overwritten with new data.

---

## Monitoring and Capturing Data

When the protocol analyzer is set up to properly match the line parameters:

- From the top level menu, press **Run Menu** and then press **Monitor Line**. You can watch the data scroll across the screen.

This may satisfy your needs. However, if you want to evaluate specific data, you may want to write a monitor program and measure specific events.

---

### To write a monitor program:

The Monitor menu allows you to write programs by prompting you for softkey selections. For example, the following program measures the time from RTS on to CTS on.

1. From the top level menu, press **Mon Menu**.
2. Press **When Trig**, **Lead**, and then **▶** (or press **RTS**), and **On**. This defines a trigger event that is satisfied when RTS lead goes on. Press **RTN** to start a new Block.
3. Press **Start**, **Timer**, **1**.
4. Press **When Trig**, **Lead**, **CTS**, **On**, **RTN**. This specifies a second trigger condition.
5. Press **Stop** and **Tests**. When the second trigger event, CTS going on, is satisfied the test will stop, which also stops Timer 1. The result in Timer 1 is the time interval between RTS ON and CTS ON.

For example:

```
Block 1:  
When Lead RTS goes On      Timer 1 starts measuring  
    then goto Block 2  
Block 2:  
Start Timer 1  
When Lead CTS goes On      Timer 1 stops measuring  
    then goto Block 3  
Block 3:  
    Stop Tests
```

Notice that the Start and Stop statements are preceded by When. This causes the HP 4957A to set a trigger on these lead changes when the specific block is active.

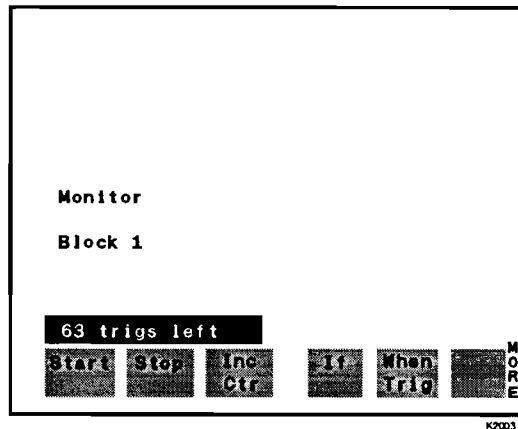

Figure 2-3. The Monitor Menu

## To load a monitor program:

This exercise shows you how to load a program from the Data Communications Test library (this disk is provided with each HP 4957A).

This program counts the DCE and DTE characters for 1 minute (or 10 minutes) and is useful for checking link throughput, file sizes, etc.

1. Insert the Data Communications Test Library disk into the disk drive.
2. Press **[MORE]** and then press **Mass Store**.
3. Press **[v]** to select and highlight the program A\_COUNTCHAR.
4. Press **Load** and **Execute**.

The protocol analyzer loads the program and returns to the floppy disk directory. You must go to the Monitor menu to view or modify the program .

For consistency and simplicity, all programs in this library are stored with a common set of data communications parameters. These parameters may be changed in the Setup menu to suit your system.

### **Changing Setup Parameters**

Changing some parameters, such as Data Code, Mode, or Character Framing may require corresponding changes to the Monitor or Simulate programs.

The parameters loaded with all library programs are:

- 9600 bps line speed
- ASCII7, Odd parity for async
- EBCDIC, DCE supplies DTE clock for SDLC
- ASCII8, DCE supplies DTE clock for X.25/HDLC

For example:

This program counts the number of parity errors on both the DTE and DCE lines and keeps track of the time the test has run (in minutes).

```
Block 1:
When DTE X
  or
When DCE X
  then goto Block 2
Block 2:
Start Timer 5
Block 3:
When Error Parity on DTE
  then goto Block 4
When Error Parity on DCE
  then goto Block 5
When Timer 5 is > 59999
  then goto Block 6
Block 4
Increment Counter 1
  and then
Goto Block 3
Block 5
Increment Counter 2
  and then
Goto Block 3

Block 6
Increment Counter 5
  and then
Reset Timer 5
  and then
Goto Block 2
```

*Timer 5 starts when any character is sent on DTE or DCE*

*Timer 5 counts to 1 minute (in milliseconds)*

*Counts DTE errors*

*Counts DCE errors*

*Total test time (in minutes)*

Analyzing Live Data  
**Monitoring and Capturing Data**

For example:

This program measures more than one RTS-CTS delay until stopped.

```
Block 1
  When Lead RTS goes On
    then goto Block 2

Block 2
  Reset Timer 1
    and then
  Start Timer 1
    Measures the first RTS/CTS delay
  When Lead CTS goes On
    then goto Block 3
  When Lead RTS goes Off
    then goto Block 6
    ORs the two When statements

Block 3
  Stop Timer 1
    Stops the timer so you can view it
  When Lead RTS goes On
    then goto Block 4
    Duplicates Blocks 1 and 2

Block 4
  Reset Timer 2
    and then
  Start Timer 2
    Timer 1 is reset
  When Lead CTS goes On
    then goto Block 5
    Measures the next RTS/CTS delay before
  When Lead RTS goes Off
    then goto Block 6
    If RTS goes off before CTS goes on,
    timers are reset and program beeps

Block 5
  Stop Timer 2
    and then
  Goto Block 1
    Timer 2 measures and stops
    so you can view it
    Returns to Block 1 to capture next RTS/CTS
    delay
```

```
Block 6
Reset Timer 1
    and then
Reset Timer 2
    and then
Beep
    and then
Goto Block 1
```

The RTS and CTS delay measurements are made by timers 1 and 2 alternately. This allows you to view the previous results while the current test is still being made. If only one timer were used, you would not have had enough time to see the timer before it was reset. To view the timers and counters press **Summary** in the Run Menu during run-time. After run-time press **Timer & Counter** in the Examine Data Menu.

---

## Level 2 When String

This program counts information frames on the DTE channel. It demonstrates the capability of the HP 4957A Frame and Packet level assisted programming softkeys. This allows you to enter level 2 and level 3 programs with softkey assistance.

1. From the top level menu, press **Mon Menu**.
  2. Press **When Trig** and then press **DTE** to define a trigger for the DTE.
- 

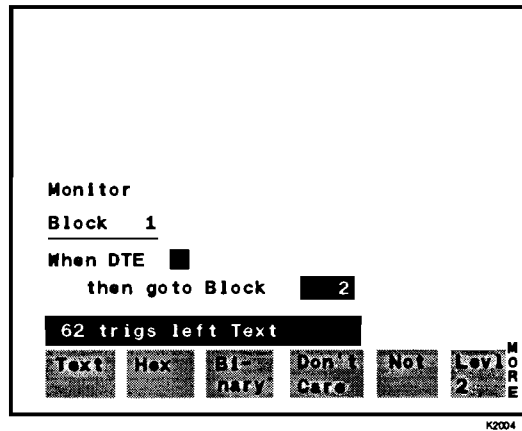

Figure 2-4. Defining a Trigger



3. Press **Level 2** to enter the level 2 assist mode. The beginning of a frame is displayed with the start flag and the first address character (in hex).
4. For this example, the address is a don't care. Press **Don't Care**.

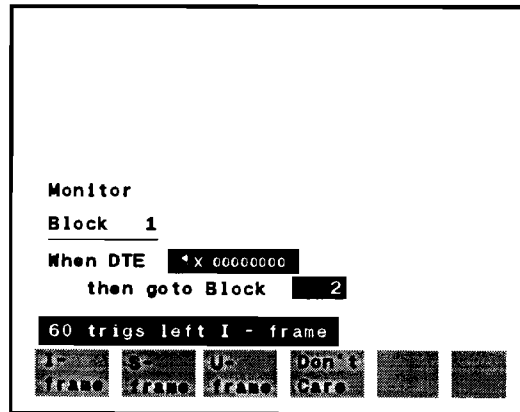
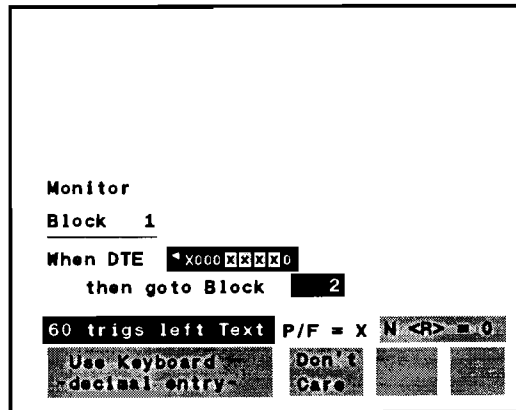

Figure 2-5. Selecting an Information Frame

5. Press **I-frame** to select an information frame.
6. The protocol analyzer prompts you for the send sequence number, N(S). Press **Don't Care**.
7. The protocol analyzer prompts you for the poll/final bit, P/F. Press **Don't Care**.



K2006

Figure 2-6. Defining Poll/Final Bit

8. The protocol analyzer prompts you for the receive sequence number, N(R). Press **Don't Care**.
9. Press **▼** two times to go to Block 2.
10. Press **Inc Ctr** and press **1** to select counter 1. Enter 1 from the keyboard.
11. Press **and then**, **(MORE)**, and **Goto Blk**

As soon as you make the N(R) entry the eight-bit control field collapses to an equivalent representation. Notice that a don't care condition is displayed as an X within a box. This byte represents a control field. The question mark indicates that there are 'don't cares' assigned to more than one field; N(S), N(R), and P/F.

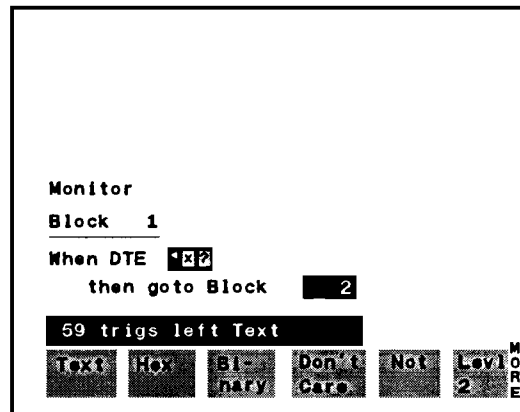

K2007

Figure 2-7. Defined Frame

Analyzing Live Data  
**Monitoring and Capturing Data**

For example:

```
Block 1
When DTE  x ?
    then goto Block 2
```

```
Block 2
Increment Counter 1 by 1
Goto Block 1
```

This program counts I-frames on the DTE line. If you need to count all frames on both the DTE and DCE you can add to the program. Complete Block 2 that corresponds to Block 1, except select an S-frame. Complete Block 3 as a U-frame.

For example:

```
Block 1
When DTE  X  ?
    then goto Block 2
When DCE  X  ?
    then goto Block 3
When DTE  X  ?
    then goto Block 4
When DCE  X  ?
    then goto Block 4

Block 2
Increment Counter 1 by 1 Counts I-frames
    and then
Goto Block 1
Block 3
Increment Counter 2 by 1 Counts S-frames
    and then
Goto Block 1
Block 4
Increment Counter 3 by 1 Counts U-frames
    and then
Goto Block 1
```

---

# Capturing High Speed Data

High Speed Capture is a ROM based application that is available only in the HP 4957A with Option 001. You can capture data at speeds above 64 kbps.

## **No Simulating**

Simulating above 64 kbps is not supported.

When the High Speed Capture application is loaded, it replaces the **Run Menu** softkey on the standard HP 4957A. This implies that the application is a direct replacement for the Run Menu, except at higher speeds. The Setup menu is changed with the new data rate speeds faster than 64 Kbps.

The High Speed Capture top level menu allows you to select store to buffer options, data filter options, and interface options.

## **Monitor menu**

When capturing data in High Speed Capture, triggers are inactive and the Monitor menu is disabled.

Timing resolution is 0.1 msec at all speeds from 64 kbps to 256 kbps.

---

## To capture high speed data:

1. From the top level menu, press **Load Appl.**, **▼** until you highlight **HS\_Capture**. Press **Execute**.
2. Press **Setup** and set the HP 4957A to match the line parameters and display format you want to use. When you select line speed you can make data rate softkey selections from 72k bits/second up to 256k bits/second. Press **(MORE)** if you need more softkey selections.

### External clock

If the clock source is external, **Mode Sync**, then bits/second does not need to be set.

---

Protocol Setup					
Protocol	HDLC	Display	2Line		
Code	ASCII 8	Err chk	CCITT		
Bits/sec	256K	DTE clock	DCE		
Parity	None	Bit sense	Norm.		
Mode	Sync	Ext Addr	Off		
		Ext Ctrl	Off		
72k	76.8k	100k	112k	128k	
kbps	kbps	kbps	kbps	kbps	

K2066

Figure 2-8. Setup Menu with High Speed Capture

3. Press **EXIT** to go to the top level menu with High Speed capture loaded. The **Run Menu** softkey has been replaced with **HS Capt**.
4. Press **HS Capt** to enter the new High Speed Capture run menu.

**Not RS-232**

If you try to run the application with RS-232 as the active interface, the HP 4957A will not let you capture data. A warning screen appears telling you that RS-232 is not valid for High Speed Capture.

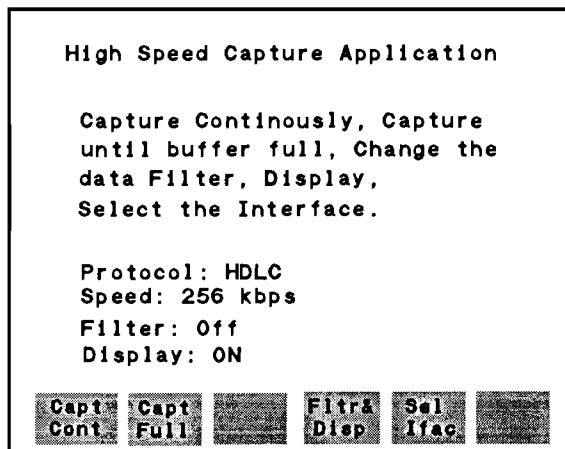

K20756

**Figure 2-9. Selection Screen for High Speed Capture**



Selections that are available for capturing high speed data are selected with the following softkeys:

- |           |   |
|-----------|---|
| Capt Cont | You can capture data and store to the buffer continuously. When the buffer becomes full it begins storing at the beginning overwriting older data. This is referred to as circular store to buffer.                                     |
| Capt Full | You can capture and fill the buffer. The HP 4957A stops storing data when the buffer becomes full (768 kbytes). The display is turned off while capturing data in this mode.  |
| Fltr&Disp | You can enable data filters that are available in the standard instrument with the high speed option: lead changes, timing information, or errors. If you turn off timing information, you also turn off leads.                         |
| Sel Ifac  | You can select all interfaces. High speed capture cannot be used with the RS-232 interface because of the line speed restrictions. To exit the Select Interface screen and return to the HS_Capture top level menu, press <b>EXIT</b> . |

You must set the bit rate if you are running asynchronous protocols, or when NRZI encoded data is to be monitored.



---

## High Speed Capture Limits

- Async only uses eight-bit data codes, no parity, no error check, LSB first.
- You cannot store directly to floppy disk while capturing data. When you store menus to disk, the high speed setup cannot be stored.
- Disregard bits/second in the Summary screen (runtime or examine data).
- High speeds present some utilization problems. If you encounter **Buffer Overflow** error message, turn off the display.
- If you encounter **Receiver Overflow**, turn off timing information.
- Time stamps are placed only on start flags. Measuring other characters return unpredictable results.

---

## Setting up to Simulate

Simulation allows the HP 4957A to become one of the devices on the line. This is the added capability of interactive testing by injecting data. You can write simulate programs so the analyzer acts as either a DTE or a DCE.

---

### To set up to Simulate:

1. Connect the HP 4957A to the link to be evaluated using the Y-cable (see Figure 2-10). Turn off the power if you need to connect an external interface pod and turn the power back on.
2. Press **Run Menu** and then press **Select Iface** to select the physical interface. Press **(EXIT)** two times to return to the top level menu.
3. Press **Setup Menu** and configure to the line parameters.

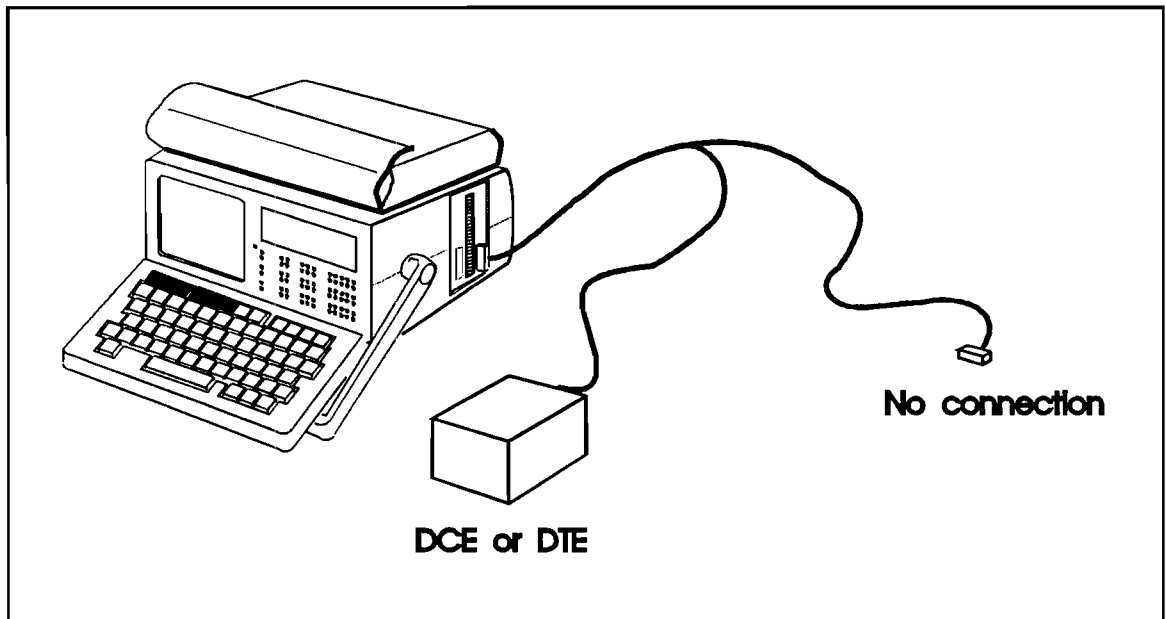

Figure 2-10. Hook up to Simulate

---

# Simulating and Capturing Data

When the protocol analyzer is set up to properly match the line parameters you must write or load a simulate program.

---

## To write a simulate program:

For example, in the following program the HP 4957A simulates a DTE. The program activates the DTR and RTS control signals and then sends data.

1. From the top level menu, press **Sim Menu**. You want to simulate a DTE, therefore, the first line is acceptable. You can press **DTE**, **▼**, **▶**, or **RTN**. All of these keystrokes will work to move the cursor to Block 1.
2. Press **(MORE)**, **Set Lead**, and then **DTR**, **On**.
3. Press **and then**.
4. Press **(MORE)**, **Set Lead**, and then **RTS** (or **▶**), **On**.
5. Press **and then** and **Send**. Fill in the displayed frame (flags and FCS) with data to send.
6. Press **(EXIT)** to go to the top level menu.
7. Press **Run Menu** and then press **Simulate**.

For example:

```
Simulate DTE

Block 1:
Set Lead DTR On
    and then
Set Lead RTS On
    and then
Send |ABCDEFGH GG|
```

The FOX Message checks the ability of asynchronous terminals and printers to receive and display data. The FOX message is transmitted to the terminal and the echo from the terminal is checked for parity errors.

For example:

**Simulate DCE**

**Block 1:**

**Send THE QUICK BROWN FOX  
JUMPS OVER A LAZY DOG 012  
3456789.**

*The Fox message is sent*

**Block 2:**

**When Error Parity on DTE  
    then goto Block 3  
When DCE  
    then goto Block 1**

*Waits until a When condition  
is satisfied*

*Sends the Fox message again  
and restart test*

**Block 3:**

**Increment Counter 1  
    and then  
Goto Block 2**

*If a parity error is detected*

*Waits for another parity error*

---

## Level 3 Send String

The send command is available only in the simulate menu. The setup protocol must be either SDLC, HDLC, or X.25.

1. From the top level menu, press **Set Up** and make sure that a bit-oriented protocol is selected; HDLC, SDLC, or X.25. Press **(EXIT)**.
2. Press **Sim Menu**, **DTE**, and **Send**.
3. Press **(MORE)** and **Level 3**.

The first two bytes are  $0^0$ . These are the level 2 address and control bytes, which default to 0. If you move the cursor back to change these bytes, you drop out of the level 3 assisted mode. Press **Level 2** for assistance in entering these bytes.

---

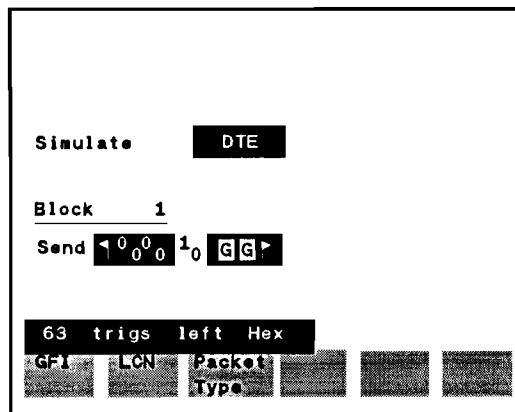

K200

Figure 2-11. Developing a Level 3 Send String

4. Press **GFI**. The far right byte is expanded to its binary components. The cursor is over the left-most bit, prompting you to enter the Q bit. Press the **0** softkey.
5. The cursor moves to the second bit from the left, prompting you to enter the D bit. Press the **1** softkey.

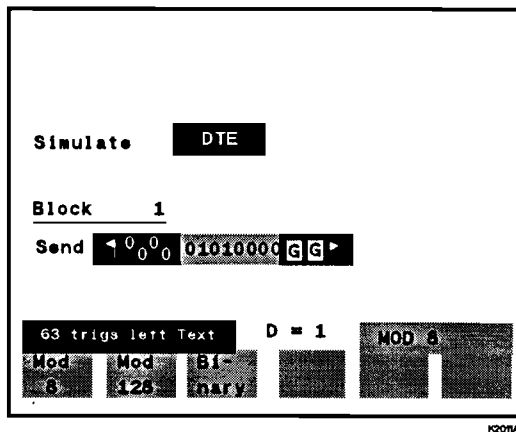
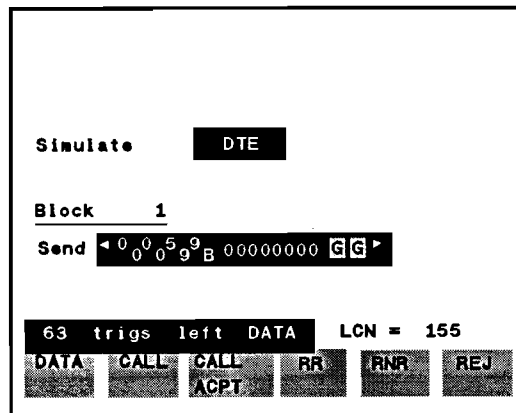

Figure 2-12. Selecting GFI in Level 3 Send String

Analyzing Live Data  
**Simulating and Capturing Data**

6. The cursor now moves to the two-bit mod field. Mod 8 is 01 binary and mod 128 is 10 binary. Press **Mod 8**.
7. The cursor now moves to far right and prompts you to enter an LCGN. This is a four-bit field, you can enter any number from 0 to 15. Type 09 (you must enter leading zeroes before the 9). The GFI field collapses to <sup>5</sup>9, and the next byte appears, prompting you to enter the LCN.
8. From the keyboard, type 155 decimal. You can enter any three decimal digits or any two hexadecimal digits for the eight-bit LCN field. If you enter a number greater than 255, the entry defaults to 255. The LCN field collapses to <sup>9</sup>B.



**Figure 2-13. Mod 8 and LCN in Level 3 Send String**



9. Press **Data** for the packet type. The right-most bit remains 0 and the prompt moves left to the three-bit P(S) field. Enter 7 for the P(S).
10. The cursor moves to the fifth bit from the right, prompting you to enter the M bit. Enter 0 for the M bit. The prompt now moves to the last three bits on the left, which is the P(R) field. Enter 5 for the P(R):
11. The packet-type byte collapses to its hex equivalent, <sup>A</sup>E and the cursor moves to the data field, prompting you to enter text.
12. From the keyboard type 'THIS IS A DATA PACKET.'

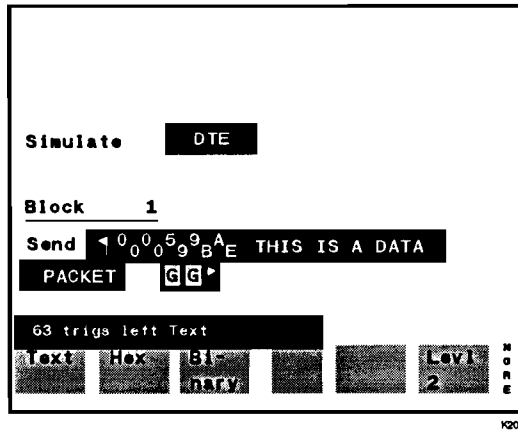

Figure 2-14. Entering Data in a Level 3 Send String

Analyzing Live Data  
**Simulating and Capturing Data**

For example:

This program tests a modem for isolation from the line by simulating a RTS/CTS delay. Note that all timers are measured in milliseconds.

Simulate DTE

Block 1:

Set Lead RTS On

When Lead RTS goes On  
    then goto Block 2

Block 2:

Reset Timer 1  
    and then

*The program loops back to this Block*

Start Timer 1  
    and then

*CTS response*

Start Timer 5

When Lead CTS goes On  
    then goto Block 3

When Timer 5 > 2000  
    then goto Block 4

*Beeps if CTS does not go on in 2 seconds*

Block 3:

Reset Timer 5  
    and then

Stop Timer 1  
    and then

Set Lead RTS Off  
    and then

*RTS is turned off and the test  
restarted after 30 seconds*

Wait 29999  
    and then

Goto Block 1

Block 4:  
Reset Timer 5  
    and then  
Reset Timer 1  
    and then  
Beep  
    and then  
Set Lead RTS Off  
    and then  
Wait 250  
    and then  
Goto Block 1

*Error Block*

*If CTS does not go on 2 seconds  
after RTS goes on, the test is restarted*

---

# Storing Instrument Configurations and Data

Data, menus, menus and data, applications, and extended menus can be stored to floppy or RAM disk.

---

## To store to disk while running:

You can store directly to floppy disk while monitoring or simulating under program control. Each 'start' and 'stop' command is effected when it satisfies the associated trigger condition.

1. From the top level menu, press **Mon Menu**.
2. Press **When Trig**, **Lead**, **▶**, and **On**, **(RTN)**.
3. Press **Start** and then **Disk**.
4. Press **When Trig**, **Lead**, **Off**, and **(RTN)**.
5. Press **Stop**, and **Disk**, and then, **Goto Blk**.

For example:

```
Block 1
When RTS goes On
    then goto Block 2
```

```
Block 2
Start Disk
```

```
When RTS goes Off
    then goto Block 3
```

```
Block 3
Stop Disk
    and then
Goto Block 1
```

When you enter the Run Menu and execute a monitor or simulate program with a 'start disk' statement, the protocol analyzer asks you to provide a file name and comment for the new file. The file type is always Menu & Data. Press **Execute** to begin running the program. If there are no 'when' statements in the program, the display continues until all 'wait', 'send', and 'set lead' statements have been executed.

---

### To store to disk:

1. From the top level menu, press **Mass Store**. If you are going to store applications or menus to the nonvolatile RAM disk, press **MSD=RAM**. This makes RAM the active disk. The active disk is displayed in the top right corner of the screen.
2. Insert a formatted disk in the disk drive. Look at the top right corner of the screen to make sure **MSD=Disk** is displayed.
3. Press **Store**.
4. Name the file you want to store (up to 10 characters), press **▼**, and press the softkey that corresponds to the file type (see Table 2-1 for what is actually stored in each file type).
5. Press **▼** and enter a comment for the program. This is optional.
6. Press **Execute**.

For example:

The protocol analyzer displays a status message; **Executing or Write Protected**.

**Storing Instrument Configurations and Data**

The HP 4957A stores different information depending upon the file type you chose.

**Table 2-1. Information stored with Each File Type**

<b>File Type</b>	<b>Stored Information</b>
Data	Data that was captured during a run
Menu	Setup, monitor, simulate and BERT menus
Menu & Data	Setup, monitor, simulate, BERT menu and data that was captured
Application Program	Application program resident in instrument memory
Extended Menu	Setup, monitor, simulate, BERT, remote, printer, data filter (including menus containing External NRZI or X.21 protocols)

Highlights from the buffer are not saved to disk.

---

Analyzing Captured Data

---

## Analyzing Captured Data

This chapter explains how to use the capture buffer, Examine Data menu, and programs to analyze data, make measurements, and manipulate data. For each example and exercise, it is assumed that data is already in the capture buffer. The examples use data that is on your Utility disk, file name DEMO\_DATA. Refer to chapter 1 for loading.

The capture buffer is memory dedicated to storing your data. It is used to hold your data until you can evaluate it. You can look at, examine, and measure the contents of the capture buffer in the Examine Data menu by scrolling through the data with the **Roll Up**, **Roll Down**, **Next Page**, and **Prev Page** softkeys. You can also analyze the contents of the buffer using monitor programs.

The capture buffer is divided into 384, 2 kbyte blocks totalling 768 kbytes of available memory. There are 16, 2 kbyte blocks of memory that comprise the nonvolatile memory and 736 kbytes of volatile memory.

The nonvolatile portion of the capture buffer is movable. It is approximately eight blocks before and eight blocks after the current cursor position. You can select the portion you wish to protect at power-off by moving the cursor through the blocks, 1 through 384, using the **Next Segmt**, **Prev Segmt**, **Specify Block**, and **Next Hilit** softkeys in the Examine Data menu. A segment equals approximately 16 blocks.



---

## Viewing Data

Use the Examine Data menu to view buffer data. Use the demonstration data, DEMO\_DATA, from the Utility disk.

---

### To view data:

1. From the top level menu, press **Exam Data**. The protocol analyzer searches the capture buffer for data and displays it using the most recent display format selected.
2. Press **▶** to highlight the 'A' in the data stream.

You can see the data is ABCDEFGH transmitted continuously. With the cursor highlighting the 'A' you can see the character decoded in binary, octal, and hexadecimal. The data is DCE data, so it is displayed in inverse video. The DTE data is displayed in normal video.

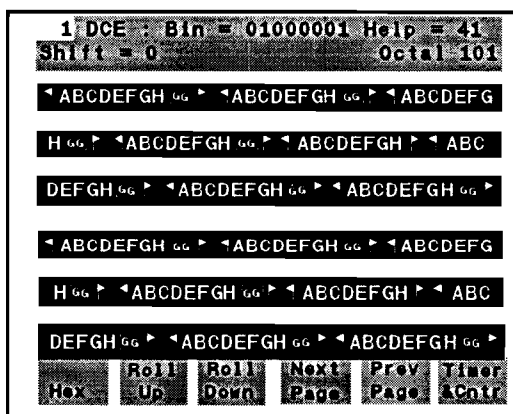

K300

Figure 3-1. Demonstration Data in Two Line Format

---

# Measuring Time

You can manually measure the intervals between specific characters using cursor timing in the Examine Data menu.

---

## To measure timing intervals:

1. With the cursor still highlighting the 'A', press **MORE** two times. This should display the **Start Time** softkey.
2. Press **Start Time**.
3. Press **▶** enough times so the 'A' in the next frame is highlighted.
4. Press **End Time**.

The time between the 'A's is displayed at the top of the display. The measurement should be 99.0 ms. Using this technique you can measure frame length, from start flag to end flag, 57.0 ms. This difference, from end flag to start flag, measures the delay between frames.

The GG displayed in a box indicates a good frame check, BB indicates bad frame check, and AA indicates abort.

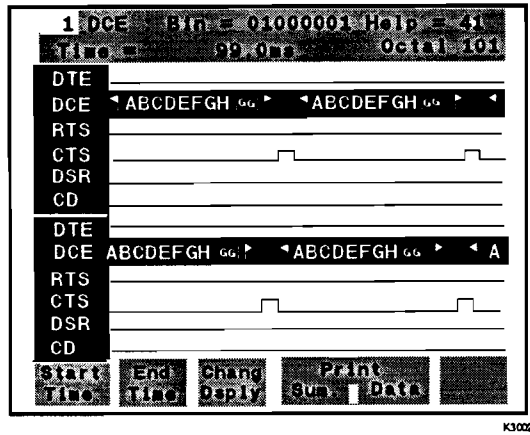

Figure 3-2. Timing Interval in Data & State Format

---

## Changing Display Formats

You have six options that allow flexibility and ease of viewing. Choose the display that best suits your needs.

- Two Line displays both DTE and DCE data
- DTE Only
- DCE Only
- Data & State displays DTE and DCE data with RTS, CTS, DSR, and CD waveforms
- Frame displays a breakdown of the frame information
- Packet displays a breakdown of the packet information

There are two menus you can use to change the display format. There is a field in the Examine Data menu with all display selections available. The Setup menu also contains a field where you can change the display format.

The HP 4957A is equipped with a smart cursor, whenever you change display formats the cursor stays at the same data location.

---

## To change display format:

1. In the Examine Data menu, press **Chang Dsply** to access the display format softkeys.
2. Press the softkey for the most meaningful data.

You can press the **Hex** softkey and change all data to hexadecimal display and press the same softkey, now labelled **Text** to change it back.

---

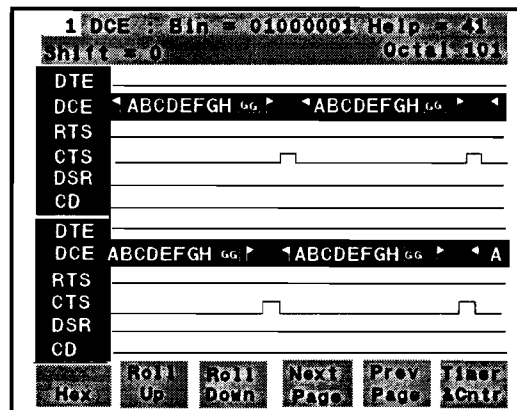

K3003

Figure 3-3. Data & State Format

---

# Measuring Captured Data

You can evaluate the same captured data, many times, and in many ways without corrupting the original data file. When the data is in the capture buffer you can view it, you can make manual measurements, you can write programs and look for specific events or you can run programs from the Datacommunications Test Library.

---

## To post-process data:

1. Write a program to measure the period of one frame. This will confirm the manual measurement you made. From the top level menu, press **Mon Menu**. Enter the program and press **(EXIT)** to go back to the top level menu.

Monitor

Block 1

When Lead CTS goes On

Start Timer 1

and then

Highlight

Block 2

When Lead CTS goes On

Highlight

and then

Stop Timer 1

and then

Stop Tests

2. Press **Run Menu**.

3. Press **Monitor Buff**.
4. When the program has finished executing, press **Exam Data**. You can see the transitions that were measured because the program highlighted them.
5. Press **Timer&Cntr**. This displays the results of timers and counters. In this case, you see the frame length is 99.0 ms.

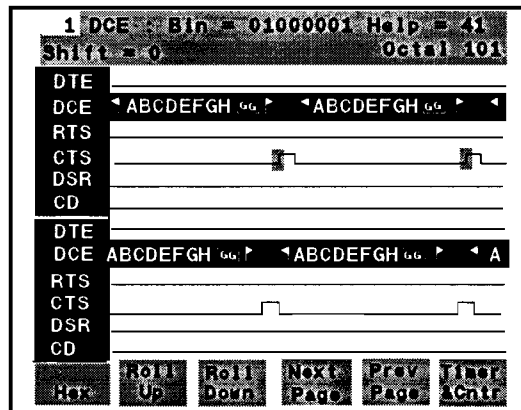

K3004

Figure 3-4. Measuring Frame Time from the Buffer

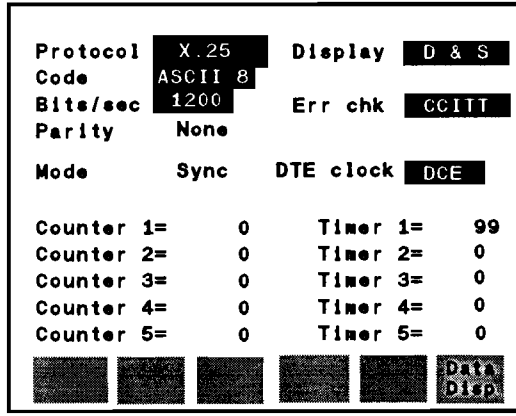

K3005

**Figure 3-5. Timers and Counters**

When you view the data in the Data & State display mode, you can see that CTS goes on between frames. Therefore, the time between CTS pulses equals the time for one frame.

## Timing Resolution

Timing resolution is the smallest unit of measurement that can be timed at a given speed. Use the Table 4-1 and the correction factor for speed ranges given. Multiply the time measured by the corresponding correction factor.

**Table 3-1. Timing Resolution**

Speed	Resolution	Factor
50-2400	1.0 msec	1.0004
3200-4800	0.5 msec	1.0008
7200-9600	0.2 msec	1.002
12000 - 256 kbps	0.1 msec	1.004



---

Making a BERT  
Measurement

---

# Making a BERT Measurement

Bit Error Rate testing is one of the most fundamental troubleshooting tools in a datacommunications network. BERT measures analog noise on a digital signal. Through the use of BERT tests you can determine how often highs are changed to lows and lows to highs in error. This chapter explains how to make BERT measurements with the HP 4957A performing as a DTE. To use the protocol analyzer as a DCE, see chapter 10, DCE BERT.

A BERT tester generates pseudo random bit sequences (PRBS) from a shift register of length  $L$ , where the sequence equals  $2^L - 1$  bits. A PRBS may be any length, but certain pattern lengths have become standard. The HP 4957A supports lengths of 63, 511, 2047, and 4095.

Bit error rate (bit errors  $\div$  bits received) does not measure error distribution. For example, if most errors occur grouped together, it might indicate that the line is functional but had been affected by a momentary phenomenon, such as a lightning strike. For this reason, bits are grouped in blocks for measuring block error rate (block errors  $\div$  blocks received). The Bell system uses 1000 bits per block; CCITT uses a block size equal to the PRBS pattern.

## **BERT Blocks**

Do not confuse BERT blocks with blocks in other menus.

---

## Running a BERT Test

If the line you are going to test is a true half-duplex line, you must hook up two protocol analyzers in an end-to-end configuration. If your line is full-duplex hook it up in a loopback configuration using only one protocol analyzer.

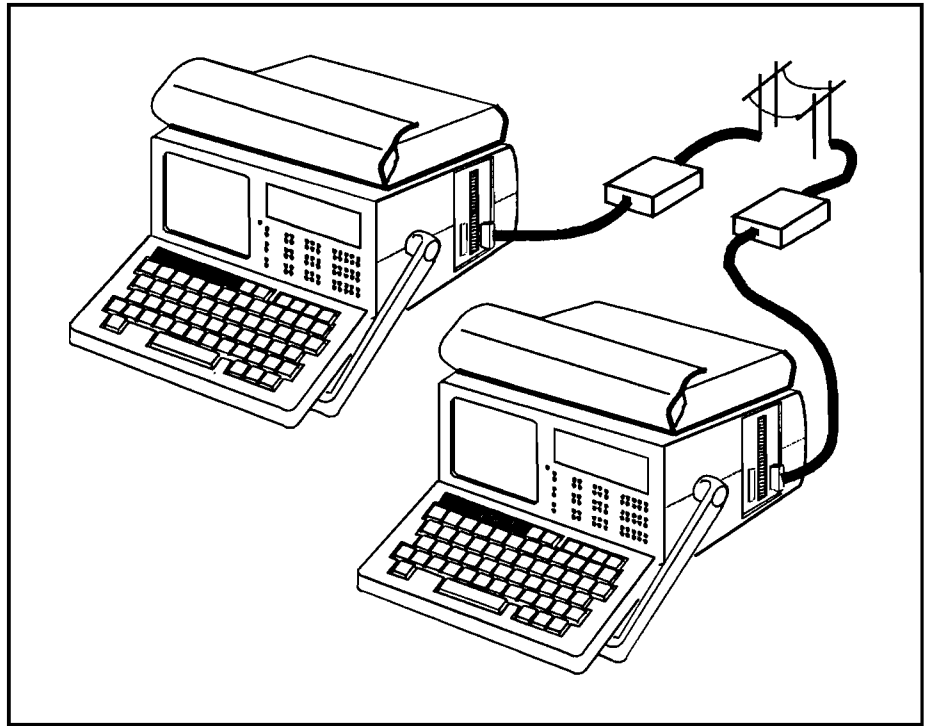

**Figure 4-1. Connection for End-to-End Testing**

---

## To make a BERT measurement:

You can set framing to send standard asynchronous characters with one start bit and two stop bits. The frame size is equal to the start and stop bits plus parity plus the selected character size. To select framing, choose the size of the data character (5, 6, 7, or 8 bits). An optional parity bit may be added after the data character, before the two stop bits. Each frame alternates with an idle (high) time which is the same length as the frame.

1. Connect the protocol analyzer(s) to accommodate your network (see Figures 4-1 or 4-3 as appropriate).
2. From the top level menu, press **MORE** and **BERT Menu**.
3. Fill in all fields in the BERT menu: PRBS Pattern, Block size, Duration of the test, Bits/sec to match the line, and Framing and Parity as necessary.
4. Press **EXIT** to return to the top level menu.
5. Press **Run Menu** and press **BERT** to start the test.

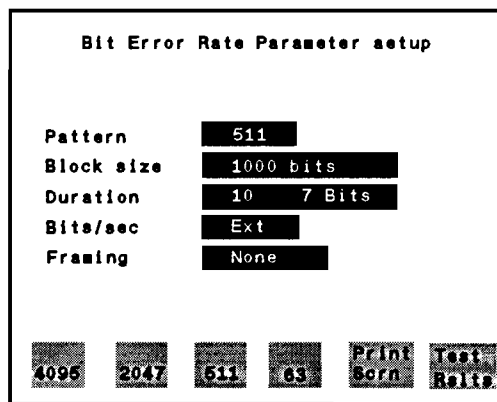
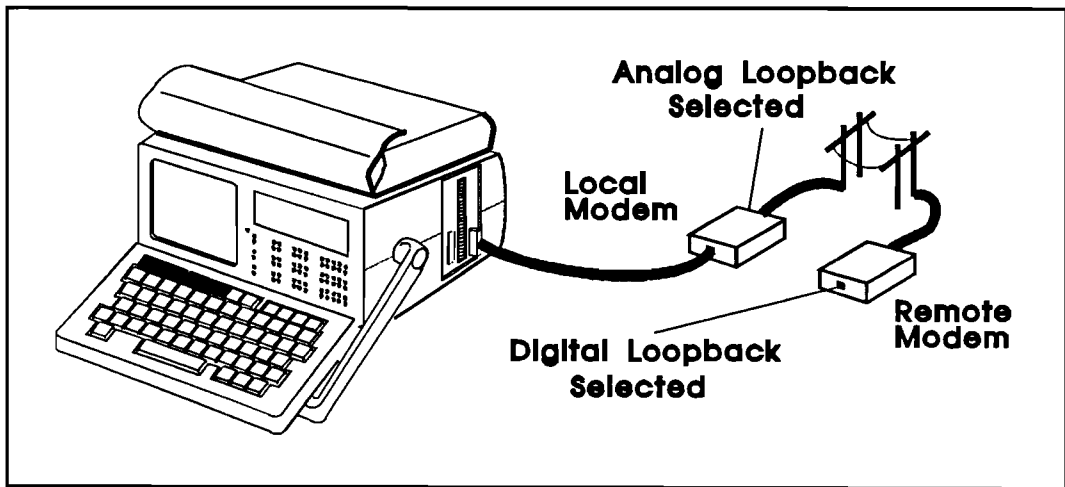

Figure 4-2. The BERT Setup Menu



**Figure 4-3. Connection for Loopback Testing**

When you are running a BERT test, a run-time data screen continuously displays test progress. You can press **Summary**, at any time, without stopping the test and review the test parameters you set or press **Inject Error** to insert known errors on the line. The receiving BERT tester stops the test when it receives all the bits required for the test, or when you press **EXIT**. The transmitter continues to transmit to ensure that the other receiver gets all needed test bits.

A flashing display indicates a 'rolled-over' condition. This occurs when a counter reaches its maximum and restarts at 0. Table 4-1 indicates the displayed data with maximum count registers.

**Table 4-1. Maximum Count Parameters**

Display	Maximum Count
Elapsed Seconds	65535 secs (approximately 18.2 hours)
Errored Seconds	65535 secs
Block Count	65535 count
Block Error	65535
Bit Count	99 X 10E9
Bit Error	65535 count

## To make a remote BERT test:

BERT tests can be executed by a controller over a remote connection. A remote BERT test requires the test be defined in the BERT menu and a remote connection with a controller and slave.

Set the BERT menu in the controller and download to the slave, then set the slave in the top level menu. If you are at the remote site, set the slave BERT menu and press **(EXIT)** until the top level menu is displayed.

1. Set the slave BERT menu.
2. From the top level menu of the controller, press **(MORE)**, **Remote&Print**, **Control**. Make sure the remote link is active; use the Identify Slave command.
3. Press **(v)**, **Exec BERT**. This selects the BERT menu as the operation.
4. Press **Execute**. The controller executes the slave BERT menu.

### Top Level Menu

The slave must be in the top level menu to execute a remote BERT test.

When **Exec BERT** is selected and you press **Execute** the slave's BERT menu is executed. The slave must be in the top level menu to execute the BERT menu.

When **BERT stat** is selected, the current BERT statistics (if the slave is running a test) are sent from the slave to the controller. If a test is not running, the slave sends the most recent statistics if it is in the top level menu. After the statistics have been uploaded to the controller, you can print them from the BERT menu.

**Cannot view percent error free seconds**

You cannot view percent error free seconds, but they can still be calculated.

o

## BERT Results

A BERT test returns the following results.

**Elapsed Seconds.** Elapsed time since receiver synchronization.

**Errored Seconds.** Elapsed seconds with error occurrences.

**Block Count.** Number of blocks sent in the test.

**Block Errors.** Number of blocks with at least one error. Divide block errors by block count to get Block Error Rate.

**Bit Count.** Number of actual data bits sent since synchronization (excluding framing, start, stop, and parity bits).

**Bit Errors.** Divide bit errors by bit count to get Bit Error Rate.

Error-Free Seconds are errored seconds  $\div$  elapsed seconds. These results are displayed at the end of the test.



————— Transfer and Control in  
Remote

---

# Transfer and Control in Remote

Remote operations are convenient with any protocol analyzer. The Remote Menu is used to configure the HP 4957A for remote operation. The controller and slave instruments can communicate, transfer data, menus, applications, test the remote data line, and test results from timers and counters.

You can use the HP 4957A as a controlling protocol analyzer in a point-to-point configuration with another HP slave analyzer. You can use the HP 4957A as one of up to 15 slaves in a multi-drop configuration. You can also use the HP 4957A as a slave to a PC. This enables the HP 4957A to be the eyes for the PC operating as a controller. The PC can initiate all standard remote operations, as well as control an HP 4957A operating in the virtual terminal mode.

**Only Hewlett-Packard**

The slave does not have to be the same model, but it must be an HP analyzer.

There are two basic transfer operations:

- Transfer from controller to slave (download)
- Transfer from slave to controller (upload)

The controller always initiates the functions and gives the slave instructions. As a controller, the HP 4957A can download menus, applications, and data to the slave and receive uploaded information from the slave.

**Overwrites**

Any upload or download operation overwrites the contents in the receiving protocol analyzer.

When operating protocol analyzers in the remote mode, a logical sequence is to download a menu to a slave, instruct the slave to execute the menu to capture data, tell the slave to transmit all captured data up to the controller for evaluation. In a configuration with a PC, you can configure the slave by VTR to capture data, and then use the standard remote functions to upload data or use VTR to review the captured data.

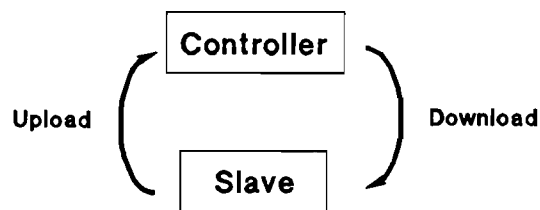

K5001

**Figure 5-1. Data Transfer**

---

## Connecting for Remote Operation

Both slave and controller are always a DTE and expect to be connected to a DCE (modem).

**Without modems**

You can connect without modems, however, you must use a modem eliminator cable.

---

### To connect for remote:

1. Connect the slave HP 4957A from the REMOTE/PRINTER connector on the rear panel through an asynchronous modem at the remote site with an RS-232 cable.
2. Connect the modem to a direct or telephone line that connects to a modem at the controller end.
3. Connect the controller from the asynchronous modem to the direct line to the slave.

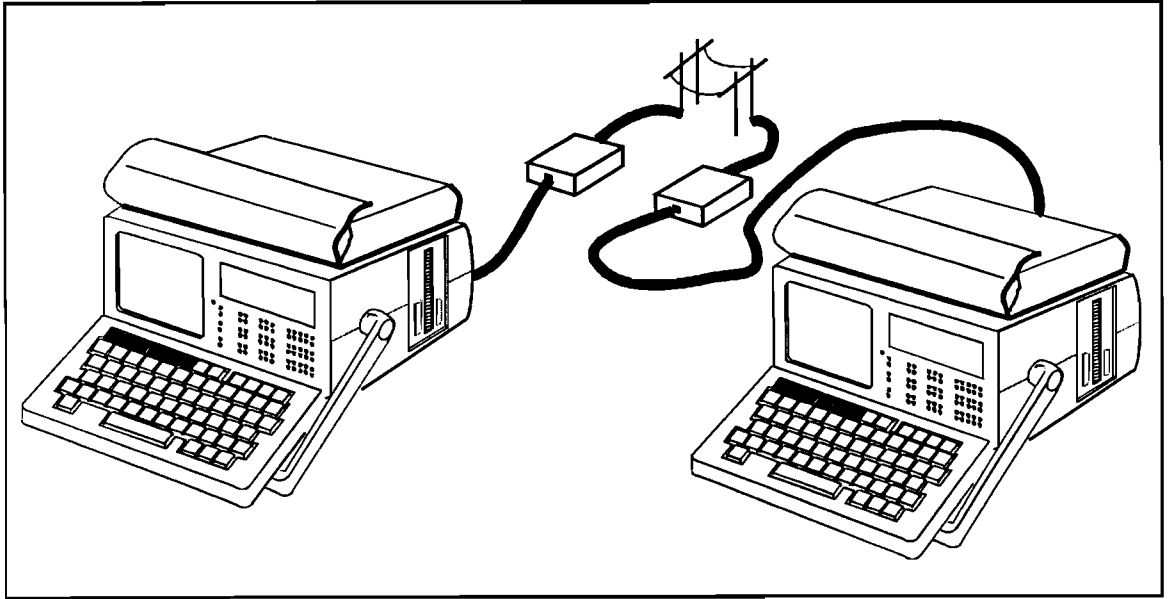

Figure 5-2. The Remote Connection

---

## Placing a Remote Call from the Controller

The HP 4957A can control another HP protocol analyzer in a point-to-point configuration. When you apply power to the protocol analyzers, they are in the slave command mode (default). At power-up, both protocol analyzers send a command telling their respective modems to auto-answer all calls.

---

### To set up the controller:

1. From the top level menu, press **(MORE)** and then press **Remote&Print**.
2. Press **Control** to enter the controller setup menu. When you enter the Controller menu, you place the HP 4957A in the controller mode.
3. Set the data rate (Bits/second). Make sure that the data rate you set in the controller menu is the same as the slave's data rate and is supported by the modems. The change takes effect when you exit this field.

4. Press **▼** or **(RTN)** and enter a modem string and phone number, if necessary (20 characters maximum). At the end of the modem string, enter **(CNTL) (M)**, for a carriage return if the modem expects a CR. You can get modem string information from the operator's manual for the modem you are using.
5. Press **Send Cnfg**.

**Carriage return**

Pressing **(RTN)** or CR does not send a  $C_R$  to the modem. You must enter **(CNTL) (M)**.

For example:

ATDT 5551212 **(CNTL) (M)**

---

## To place a call:

The controller always initiates any transfer functions. It either downloads or tells the slave to upload.

1. Press **ID Slave** and **Execute** to verify that the link is active. This may take several seconds, however, if the slave does not respond make sure all connections are secure and retry.
2. Press **▼** or **(RTN)** select **Reset Slave** and press **Execute**. This puts the slave in the top level menu.
3. Lockout the slave's keyboard. If the slave analyzer is also an HP 4957A, this is automatic. To lockout the keyboard, the slave must be in the top level menu.

This puts the slave on-line and can accept calls and commands from the controller.

Transfer and Control in Remote  
**Placing a Remote Call from the Controller**

**Lock the keyboard**

All operations except 'slave's status', 'identify slave', and 'reset slave' require the keyboard to be locked.

The screenshot shows a terminal window titled "Controller Menu". It contains the following text and options:

- Bits/sec: 9600
- Modem String: [REDACTED]
- Operation: Identify Slave
- Press EXIT to Save Configuration
- Bottom row of buttons: 19200, 9600, 4800, 2400, 1200, Save Cnfg, MORE

K5003

**Figure 5-3. The Controller Setup Menu**



---

## To download applications:

1. Load the application (see Chapter 1) you want to transfer in the controller and return to the top level menu.
2. Press **MORE** and press **Remote&Print** to access the Remote Menu.
3. Press **Control** to enter the controller menu.
4. Press **▼** and press **Dnld Appl** (download application).
5. Press **Execute**.

The controller displays the current block number being transferred. The size of an application is listed in sectors in the directory. To equate the two, one block equals approximately 8 sectors.

The analyzer will display the results of the command:

For example:

**Operation successful.**

---

### **CAUTION**

---

All applications for an HP 4952A can be downloaded and run on an HP 4957A. Applications for an HP 4951C are not compatible.

The application will be downloaded in the corresponding portion of nonvolatile memory in the slave. The slave will overwrite, as necessary, to accommodate the required memory.



## Placing a Remote Call from the Controller

---

### To download a menu:

1. Load or develop the program menu you want to transfer and return to the top level menu.
2. Press **Run Menu** and select the operation associated with this menu. When you tell the slave to execute a run, this operation is selected. Execute Run Monitor or Run Simulate and return to the top level menu. This will set an internal flag that dictates the operation when **Exec Run** is pressed in the controller menu.
3. Press **MORE** and press **Remote&Print** to access the Remote Menu.
4. Press **Control** to enter the controller menu.
5. Press **Dnld Menu** (download menu).
6. Press **Execute**.

The analyzer will display the results.

For example:

**Operation successful.**

---

### CAUTION

---

'CCITT Set 0s' error checking and X.21 menus can only be transferred to an HP 4952A or another HP 4957A. Extended menus cannot be downloaded to an HP 4951C.

---

### To download data:

1. Load the data you want to transfer and return to the top level menu.
2. Press **(MORE)** and press **Remote&Print** to access the Remote Menu.
3. Press **Control** to enter the controller menu.
4. Press **Dnld Data** (download data). Using the keyboard, enter the block numbers you want to download.
5. Press **Execute**.

A controller displays the current block number being transferred. The size of a data block is listed in sectors; one block equals approximately 8 sectors.

---

#### CAUTION

---

The HP 4957A has a 768 kbyte buffer. The HP 4952A may have the same size buffer (optional). The HP 4951C has a 32 kbyte buffer. Make sure the buffer sizes and data locations are compatible when downloading data.

The analyzer will display the results.

For example:

**Operation successful.**

---

## To upload to a controller:

When data is uploaded you must specify the slave's blocks to be transferred. If the slave is a non-HP 4957A, the slave may reject transfer requests that are not within the range of its buffer. Many other analyzers have different size buffers, such as 16 blocks in an HP 4951C. The slave will also reject requests for negative or 0 blocks.

The controller will place the received blocks of data in the corresponding controller blocks.

---

### CAUTION

---

All data in the controller buffer is overwritten when uploading data from a slave.

1. Press the desired upload operation from the controller menu. The available upload selections are **Upld Appl** (upload application), **Upld Menu** (upload menu), **Upld Data** (upload data), or **Timr Cntr** (data in the Timers and Counters).
2. Select the desired blocks to upload. The menu field is a three digit field, you must enter all three digits. If the number you want to enter is only one digit, you must enter 0 for the others.
3. Press **Execute**. The analyzer will display the results, for example, **Operation successful**.
4. Press **(EXIT)** two times and then press **Exam Data**. If you are not viewing uploaded data, use **Spec. Block** to go to the correct data.

---

## Receiving a Remote Call as a Slave

The HP 4957A can be a slave in a point-to-point configuration or one of up to 15 slaves in a multi-drop configuration.

The slave mode is the protocol analyzer default mode. It is in slave mode at power-up and the bits/sec field is set to the data rate that was set last. At power-up and when the data rate is changed, the slave sends a modem string,  $AT^C_RAT^C_RAT^C_R ATSO=1^C_R$ , telling the modem to auto-answer all calls on the first ring.

When all connections have been made, the HP 4957A can be used as a slave in unattended mode. It can be instructed to run in Virtual Terminal Remote as a slave to a PC.

---

### To set up the slave:

1. From the top level menu, press **(MORE)** and then press **Remote&Print**.
2. Press **Slave** to enter the Slave Menu.
3. Enter the slave address. If you are in a point-to-point configuration, enter 0 (default). If you are in a multi-drop configuration, set a unique address (0-15) so that the controller can find this specific analyzer.
4. Press **(v)** or **(RTN)** and set the Bits/sec. This must be the same setting as the controller. When you move the cursor out of the Bits/sec field the slave instructs the modem to auto-answer any incoming calls.

**Receiving a Remote Call as a Slave**

5. If the modem was attached after power-up or an incorrect modem string was sent, press **(V)** or **(RTN)** and enter the modem string (20 characters maximum). At the end of the modem string, enter **(CNTL) (M)** for a carriage return. You can get the modem string information from the operator's manual of the modem you are using.
6. Press **Send Cnfg** to send the configuration to the modem.
7. Reset the slave. If you are at the remote site you can press **(EXIT)** on the slave keyboard until the top level menu screen appears. Many operations cannot be executed unless the slave is in the top level menu.

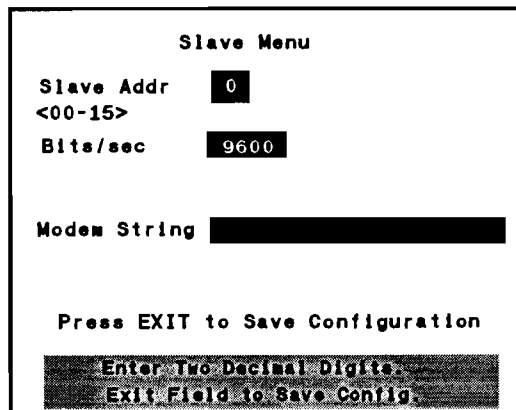

**Figure 5-4. The Slave Menu**

---

## Ending Remote Operations

To stop execution of any remote operation, press **(EXIT)** on the controller to return to the remote menu. This will abort the current slave operation immediately. The operation may not finish.

---

### To break a link:

The HP 4957A is compatible with most asynchronous modems. When a link has been established, the modem is in the command state. When a call is placed the modem is put on-line. You can break this connection from either the slave side or the controller side using the modem string field in the protocol analyzer.

For example:

- If you are using a Hayes Smartmodem, type

+++

in the modem string field and press **Send Cnfg** to place the protocol analyzer back in the command state.

- Type **ATO (CNTRL) (M)** to go back on-line.
- Type **ATH (CNTRL) (M)** to hang up the call.

---

## Remote Restrictions

When you are operating in the remote mode there are some restrictions you must be aware of.

---

### With Modems

- Use only asynchronous modems for remote operations. Modems can have various baud rate settings. Make sure the controller, slave, and modems have been set with the same Bits/sec data rate. If the baud rates are set differently remote communication is not possible.
- Make sure the slave is in the top level menu before sending controller commands. The controller can effect a Reset Slave command to put the slave in the top level menu.
- Controller operations without a valid slave response will abort after:
  - 24 seconds above 300 baud  
(first try and 2 retries with 8 second timeout each)
  - After 48 seconds at or below 300 baud  
(first try and 2 retries with 16 second timeout each)
  - After 3 CRC errors
- Monitor and simulate programs with 'message' statements cannot be uploaded to an HP 4951C, HP 4953A, HP 4954A, or HP 4955A. They will corrupt the controller menus. Monitor and Simulate programs with 'when softkey', 'gosub', and 'return' statements cause a non-HP 4957A or 4952A controller to see trigger in and trigger out statements in these menus.
- 'CCITT Set 0s' error checking can only be transferred to another HP 4957A or an HP 4952A.



- X.21 menus can only be transferred to another HP 4957A or an HP 4952A.
- All application programs for the HP 4952A are compatible with the HP 4957A (except PC Utilities).
- Application programs for the HP 4951C are not compatible with the HP 4957A.

---

## With an X.25 PAD

If you are using an X.25 pad instead of modems, the restrictions are:

- X.25 PADs are configured to be transparent to data. There is no additional processing of data, no messages sent back to the HP 4957A. You must establish a Permanent Virtual Circuit between the two analyzers for the duration of the data transfer. When the network connection is established you can upload data.
- The controller must receive a response from the slave for each operation within 24 seconds or it will abort. Excessive propagation will prohibit remote communications due to the protocol analyzer timeout.

Transfer and Control in Remote  
**Remote Restrictions**



———— Using the VT100 Terminal  
Emulator

---

# Using the VT100 Terminal Emulator

Often intelligent devices must be configured with an asynchronous terminal. In these cases the terminal emulator is used to establish a connection and perform a test over that connection. For example, some statistical multiplexers must be configured through an asynchronous terminal connected to them.

Simulate menus can be run from the emulator to troubleshoot a problem. In some cases, if the DTR/DSR lines drop, the connection is lost. In these cases this VT100 terminal emulator can execute the test by establishing a connection and then keeping the DTR/DSR lines up while allowing you to run a Simulate menu.

---

# VT100 Emulator

VT100 has four functions:

- **Setup**: Set communication parameters for communication for terminal.
- **Setup = Sim**: Copy parameters from simulate setup to terminal.
- **Simulate**: Run simulate menu and return, keeping leads up.
- **Execute**: Enter terminal mode.

When operating in the terminal mode, each character is transmitted immediately after it is typed.

### Lost connection

In some cases, if the DTR/DSR lines drop, the connection is lost. To avoid this problem, these lines are maintained while going between terminal mode and running a simulate menu.

VT100 will never act as a host. This means that ENQ/ACK is initiated by the host computer. The computer is set up to send a specified number of characters (e.g., 80) followed by an ENQ character (usually 05H). When the terminal has processed all received characters and is ready for more, it sends an ACK character (usually 06H). To support this type of handshake choose ENQ/ACK in the Terminal Setup menu.

In the terminal mode of operation, you can manually control the data flow using the Xon and Xoff characters. To stop the receipt of data, transmit an Xoff signal (usually press **CNTL S**). To resume the flow of incoming data, transmit an Xon signal (usually press **CNTL Q**). This method of flow control can be used with either ENQ/ACK or NONE handshaking.

The software handshake controls the flow of data between devices so that overflows do not occur. Although very few dumb terminals are designed to handle software handshaking, the terminal emulator application supports ENQ/ACK (for HP Computers).

## To load the emulator:

1. From the HP 4957A top level menu press **(MORE)**, press **Load Appl.**
  2. Press the **(v)** arrow key to move the cursor to highlight the VT100\_8024 application and press **Execute**.
  3. Press **(MORE)** and **VT-100**. This puts you in the VT100 top level menu.
- 

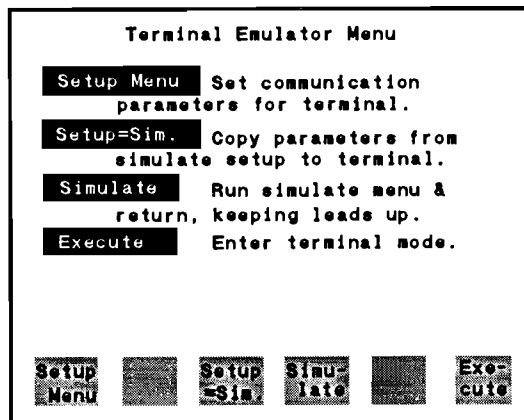

16002

Figure 6-1. Terminal Emulator Menu

---

## To set up the emulator:

The Asynchronous Terminal Emulator lets you use the HP 4957A as an asynchronous terminal. You must configure the Setup menu to correspond with the host.

### ASCII7 Only

The terminal emulator supports the ASCII7 character code.

**In the Setup menu.** From the VT100 top level menu:

1. Press **Setup Menu** to access the Terminal Setup menu.
2. Press **▼** and select **Parity: None, Odd, Even, Space, and Mark** or **Ignore**.
3. Press **▼** and select the data rate in **bits/sec: 75 ... 38400**.
4. Press **▼** and select the emulation **Mode: DTE** or **DCE**.
5. Press **▼** and select **Handshake: None** or **Enq/Ack**.

**VT100 Emulator**

6. Press **▼** and turn local Echo **On** or **Off**. If local echo or remote echo (echo from main office computer) is in effect, characters appear on the display as they are typed.
7. Press **▼** and turn Bell **On** or **Off**.
8. Press **▶** and turn Display Functions **On** or **Off**.
9. Press **▼** and turn Auto LF after CR **On** or **Off**.
10. Press **EXIT** to return to the VT-100 top level menu.

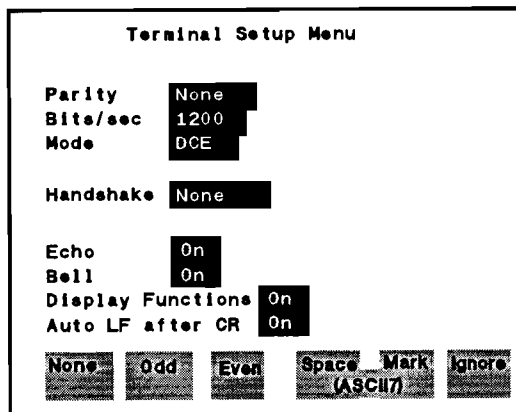

K6003

**Figure 6-2. Terminal Setup Menu**



**With Setup = Simulate.** You can transfer all setup parameters that were used when you developed a Simulate menu. This automatically makes all settings correspond to the Simulate menu. Instead of using the Setup menu:

1. Press **Setup=Sim.** to transfer the parameters from the Monitor/Simulate Setup and Simulate menus to the Terminal Emulator menu. The following terminal setup parameters are overwritten:
  - a. Parity of Monitor/Simulate Setup menu
  - b. Bits/sec of Monitor/Simulate Setup menu
  - c. Mode, DCE or DTE (first line of Simulate menu)
2. Press **Simulate**. The Simulate menu is executed.
3. To stop the execution of the Simulate menu press **EXIT** and return to the Terminal Emulator menu.

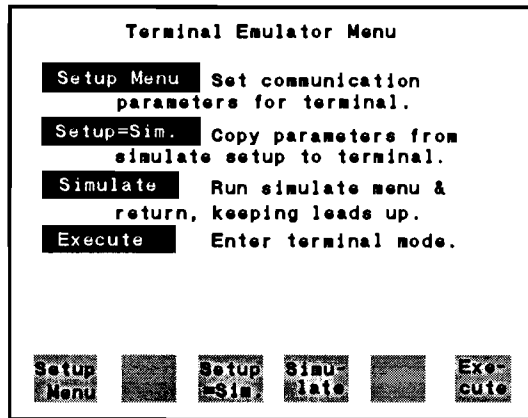

146002

Figure 6-3. Automatic Setup

## To use the emulator:

1. From the VT100 top level menu, press **Execute** to go to the terminal mode. The last terminal session appears on the display.
2. If no previous terminal emulator sessions have been initiated, the display is cleared and the cursor is placed in row 1, column 1 (top row, far left column). The terminal emulator softkeys appear at the bottom of the display.
3. Press **EXIT** in the terminal mode to get back to the VT100 top level menu. If you press **EXIT** one more time, you will go to the HP 4957A top level menu.

As an asynchronous terminal, the HP 4957A receives one or more stop bits and transmits two stop bits, making it compatible with all asynchronous devices. When using the application in DTE mode, the Data Terminal Ready (DTR) and the Request To Send (RTS) leads are set ON to ensure communications, however, the terminal emulator application will transmit regardless of the state of Data Set Ready (DSR), Clear To Send (CTS), and Carrier Detect (CD) from the other device. When operating in DCE mode, the DSR, CTS, and CD leads are set ON but the terminal emulator will transmit regardless of the state of DTR and RTS from the other device.

**Terminal Display.** The VT100 screen is 80 columns by 24 rows. The display buffer contains information for up to 96 rows. This means that you can scroll and display from the top of the first screen to the bottom of the fourth screen, through four entire screens.

### Scrolling

You must use commands that support scrolling to move the cursor from one screen to another. If scrolling commands are not used, the cursor remains at either the top or the bottom of the current screen.

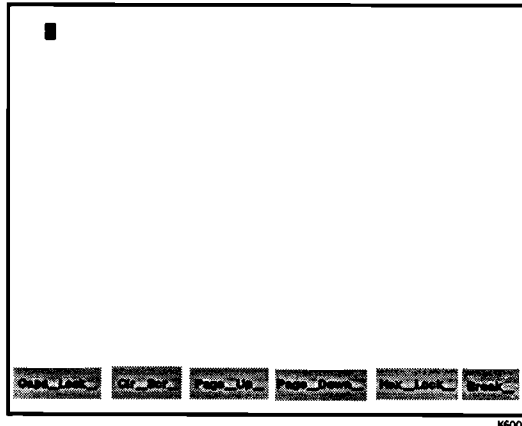

16004

**Figure 6-4. Ready to Start a VT-100 Emulate Session**

---

## Working with Control Characters

Control characters can be sent by simultaneously holding down **CNTL** and pressing the desired character key. The terminal ignores most of the control characters and does not display them. Control characters that the terminal does respond to are:

**Table 6-1. Active Control Characters**

<b>ASCII</b>	<b>Hex</b>	<b>Response</b>	<b>Keystroke</b>
ENQ	<sup>0</sup> 5	Transmit ACK	<b>CNTL</b> <b>E</b>
BELL	<sup>0</sup> 7	Beep	<b>CNTL</b> <b>G</b>
BS	<sup>0</sup> 8	Backspace	<b>CNTL</b> <b>H</b>
LF	<sup>0</sup> A	Line feed	<b>CNTL</b> <b>J</b>
CR	<sup>0</sup> D	Carriage return	<b>CNTL</b> <b>M</b>

---

## To use escape codes:

Special escape codes are used to perform the VT100 terminal operations. The HP 4957A VT100 terminal emulator can send and receive the escape sequences.

The convention <ESC> is used to show an escape character. Refer to the operating manual of your host computer for entering the escape character. To enter an escape code on the HP 4957A, press **CNTL** **ESC**. The square open bracket symbol ([]) is a literal entry to introduce the following parameter (p1).

Code	Definition
<ESC>[p1 A	Moves the cursor up by p1 lines in the same column. The screen does not scroll.
<ESC>[p1 B	Moves the cursor down by p1 lines in the same column. The screen does not scroll.
<ESC>[p1 C	Moves the cursor right by p1 spaces. If the cursor is at the right edge of the screen, it does not move.
<ESC>[p1 D	Moves the cursor left by p1 spaces. If the cursor is at the left edge of the screen, it does not move.
<ESC>[p1;p2 H	Moves the cursor to row p1 and column p2. Row 1 and column 1 are the top left corner of the screen. The cursor cannot be moved beyond row 24 or column 80.
<ESC>[p1 J	Blanks the screen according to p1 when: p1 = 0 from cursor position to bottom of screen p1 = 1 from start of screen to cursor position p1 = 2 entire screen
<ESC>[p1 K	Blanks the line according to p1 when: p1 = 0 from cursor position to end of line p1 = 1 from start of line to cursor position p1 = 2 entire line
<ESC>[p1;p2 f	Same as <ESC>[p1;p2 H
<ESC>7	Saves cursor position
<ESC>8	Restores parameters saved by <ESC>7

**Working with Control Characters**

- <ESC>D            Moves the cursor down 1 line. If the cursor is at the last line, the screen scrolls and displays subsequent buffer screens. If the current screen is the last (fourth) buffer screen, the cursor does not move.
- <ESC>E            Moves the cursor to the left margin, down 1 line
- <ESC>M            Moves the cursor up 1 line. If the current buffer screen is not the first buffer screen, the display screen scrolls. If the current display screen is the first buffer screen, the cursor does not move.
- <ESC>c            Resets to saved/power-on state and self test

———— Printing a Hardcopy

---

## Printing a Hardcopy

You can print:

- buffer data
- monitor and simulate menus
- timer and counter results
- remote and print menus
- disk directories

The HP 4957A display information is sent to a printer via the Remote/Printer (RS-232C/V.24) connector on the rear panel.

The HP 4957A always acts as a DCE when configured to print. Therefore, when the protocol analyzer receives a DTR from the DTE (printer) it starts sending data.



---

# Printing

Printing is an easy process. You must fill out the print menu to enable the HP 4957A to control the ASCII printer. Then, you can print from most menus or print buffer data.

---

## To set up to print:

**Always a DCE**

The HP 4957A always acts as a DCE. Connect the printer from the HP 4957A with an RS-232 cable.

1. Connect the ASCII printer to the Printer/Remote connector on the rear panel.
2. From the top level menu, press **Remote&Print**.
3. Press **Print Setup** to configure for proper communication with the printer.

**Character Code.** Select ASCII 8 or ASCII 7.

**Parity.** None, even, odd.

**Bits/sec.** You can send data to the printer at any one of the speeds shown on the softkeys.

## Printing

**Handshake.** XOn/XOff handshaking is initiated by the printer. When the printer is unable to continue receiving characters, it sends an XOff character (usually 13 hex). The HP 4957A then suspends transmission until the printer sends an XOn character (usually 11 hex). Some printers use a second XOff character (usually 15 hex). One XOn character and two Off characters can be specified in the printer menu. The XOn must occur within 60 seconds after the XOff or a timeout occurs and displays the message 'Hand Shake Error.'

Using Control Lead, the HP 4957A waits for CTS to become active for 60 seconds after it causes RTS. If CTS does not change a timeout occurs.

Using ENQ/ACK, the HP 4957A sends an ENQ character (usually 05 hex) to the printer after each block of 33 characters. The printer does not respond to an ENQ until it can accept more characters into its buffer. When it is ready, the printer responds by sending an ACK character (usually 06 hex). The ENQ and ACK characters may be different for various printers. You can specify the characters to be used in the Printer Menu. The ACK must occur within 60 seconds of the ENQ or the HP 4957A reports a timeout occurs.

**Line Termination Characters.** Type in the line termination characters the printer expects for all types of handshake. Two characters may be specified, blanks are ignored. The standard sequence of a carriage return and line feed is the default.

**Carriage Return Delay.** Sets the delay after a carriage return in milliseconds. This field defaults to zero, but some printers require a delay to avoid a loss of characters.

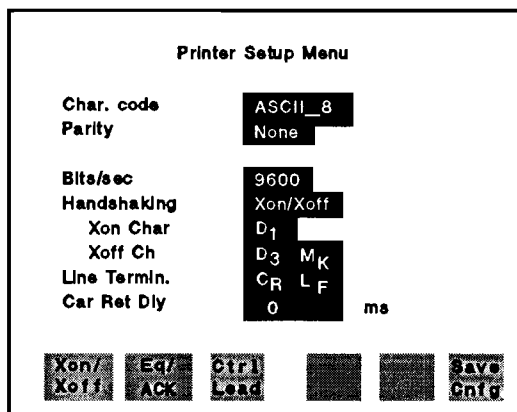

K7001

Figure 7-1. Print Setup Menu

---

To print from menus:

- When the print setup menu has been properly filled out, press the **Print** keys that are found in most of the HP 4957A menus (see Table 7-1).

**Table 7-1. Available Print Data per Menu**

<b>Menu</b>	<b>Printed Data</b>
Setup	Prints all setup parameters from the setup menu (13 lines)
Monitor	Prints the entire monitor program
Simulate	Prints the entire simulate program
Data Filter	Prints the data filter menu (first 13 lines)
Examine Data	<b>Print Sum</b> Prints Timers and Counters summary (first 14 lines) <b>Print Data</b> Prints selected number of pages (screenfuls of data) of data beginning at the current page or cursor position
BERT	Prints the BERT setup menu (first 13 lines)
BERT Results	Prints the BERT test results display (first 13 lines)
Remote	Prints the slave, controller or print setup menus (first 13 lines)
Mass Store Menu	Prints the file directory with the comments

## To print from the buffer:

You can print the entire buffer contents or partial buffer contents or disk files. You must specify the number of pages up to 9999.

You can press EXIT at any time to stop printing.

1. Press **Exam Data** and enter the Examine Data menu.
2. Press **(MORE)** two times and locate the **Print Data** softkey.
3. Using the arrow keys, position the beginning data on the top line of the screen.
4. Enter the number of pages you want printed. If you want to print the entire buffer contents enter 9999.
5. Press **Execute** . As the data is being printed, sent to the printer buffer, the display will show the current print page.

```

****  HP Printer Output  ****
Block 3          Print Page   1
ssseFssseF      sss/*SIGNONg4
yyyyqFyyyyqF    yyyyx      s7
                sssd7F      *
                yyyy10F     *
REMOTE73 RHPRHPre"CF  sssses
                sssd/F      *
                yyyy1 F     *
ssseF          ssss/*$DA
yyyyqF         yyyyx
                sssd7F      *
                yyyy10F     *
reN# F         ssss      sssd7F
sx F          yyyyt     yyyy10F
                sssd/F      sssseF      sssse*
                yyyy1 F     yyyyqF      yyyyx*

```

K7002

Figure 7-2. Printed Output in Two Line Format

**Printing**

Printing begins at the top of the displayed page, regardless of the location of the cursor. Position the data you want to start printing on the top line of the displayed page.

The printed output reflects the display exactly. No extra spaces are inserted and no abbreviations are expanded. Lines are 32 characters long unless the displayed line is completely in inverse video, in which case an asterisk is appended to the end of the line (DCE). It is not possible to print inverse video or half-bright video.

```
****  HP Printer Output  ****
Block 3      Print Page    1
DTE  sssseF  asseF
      yyyqF   yyyqF
DTE                                     sssd7F*
                                       yyyy1DF*
RSTD/111111\0/111111\00000000
CTS00/111111\0/111111\00000000
DSR/11111111111111111111111111111111
CD 000000000000000000000000/111111
DTE  sss/*signonG4remote73 rh
      yyyx      s7
DCE                                     *
RTS0/11111111111111111111111111111111
CTS00/11111111111111111111111111111111
DSR11111111111111111111111111111111
CD \00000000000000000000000000000000
```

10703

**Figure 7-3. Printed Output in Data & State Format**

Data is printed in 'display' pages or screen size. At the top of each page, the block number and the 'display' print page number are printed.

**Data Overlap**

Sometimes displayed data overlaps with data on the previous screen. This data is removed before being printed.

If you see the data you want printed scroll across the screen, press **EXIT** to stop print execution. By the time the print cycle stops, your desired data will have been printed. There is a delay from the time data is displayed until it is actually printed.

Data segments with no data to print will be printed as blank pages to verify that no data was missed.

---

## Printed Characters

The output format for the ASCII printer is the same as for the HP 4957A display except:

- All hex codes are in upper case. All ASCII control characters are in lower case. All other sequences are: top character upper case, and lower character lower case.
- All characters that have no ASCII representation are printed in hexadecimal mode.

---

## Hexadecimal Characters

Hexadecimal characters are printed in upper case, most significant digit over the least significant digit. For example, B7 hex is printed as:

B  
7

---

## ASCII Control Characters

ASCII control characters are printed in lower case with the same mnemonics as displayed except printed on two lines. For example, an ASCII acknowledge is printed as:

a  
k

DCE data that is displayed in total inverse video is printed with an asterisk printed at the end of the line. This is useful for differentiating between DCE and DTE data.



## Special Characters

Table 7-2 defines special characters and how they are displayed.

**Table 7-2. Displayed Special Characters**

Message	Display
Don't Care	x
Undefined Character	x
	?
	?
Good FCS	GG
	gg
Abort	AA
	aa
Highlighted Timer	H
	t
Discontinuity	D
	c
Start Flag	S
	f
End Flag	E
	f
Bad FCS	BB
	bb
Don't Care FCS	XX
	xx



## Lead Levels

Lead levels that are displayed are printed as follows: High = 1, Low = 0, Transition (rising or indeterminate) /, Transition (falling or indeterminate) \.

Printing a Hardcopy  
**Printed Characters**



---

Programming Reference

---

# Programming Reference

The Monitor and Simulate menus allow you to configure the HP 4957A to look for specific events, capture user defined data, and emulate datacommunications equipment. Softkeys provide all commands and conditions that you will need to develop these programs. As each softkey is selected new softkey selections appear that lead you through your program. For example, if you press **Start** the new softkey selections appear that allow you to tell the protocol analyzer what to start. In this case; Display, Disk, or Timer.

Always set up the analyzer with the proper parameters before programming. If the setup is incorrect the program may not work. For example, if the data code being monitored is EBCDIC, but your setup is ASCII, the data strings intended in these menus will be incorrect. If you change the setup menu after entering a program, the program may have blinking entry fields indicating those entries are inappropriate for the setup. If you change the setup data code or protocol after entering a character string, you must retype the string. The program will fail unless you change either the setup or the program.

Programs are organized in blocks. A maximum of 31 blocks is allowed per program. Blocks provide a reference for looping back or jumping ahead during program execution. When you insert and delete blocks, the numbering is automatically adjusted.

---

## Editing Programs

Use the **Insert Line/Block** and **Delete Line/Block/Prg** softkeys for editing programs. To insert or delete characters in a 'when' string, use the **Insert** or **Delete** softkey. The action is taken at the current cursor position.

The **Delete** key is continuous, the **Insert** key is not. Press the **Insert** key for each character you want to insert. You can delete several characters by holding the **Delete** key down.

---

## Executing Programs

To execute a program from the top level menu, press **Run Menu** and then the appropriate **Monitor Line**, **Monitor Buffer** or **Simulate** softkey.

---

## Restrictions

If you load an HP 4957A program into another HP protocol analyzer, either from disk or remote, the functions may be changed by the other analyzer. Before you use an HP 4957A Monitor menu or program on another HP protocol analyzer, verify the menu program to avoid any discrepancies.

---

**CAUTION**

---

Remove all 'Message' statements before transferring programs or menus from an HP 4957A to an HP 4951C, 4953A, 4954A, and 4955A.

---

## Defining Triggers

By telling the analyzer to trigger on an event, you are telling it to look for that event in the data stream. The HP 4957A can trigger on up to 63 different events simultaneously. Once the analyzer has found an event, it can:

- notify you by beeping
- mark a highlighted event in memory
- modify a counter
- start and stop a timer
- branch to another block
- start and stop storing data to disk
- start and stop displaying data on screen
- pause executing
- write a message to the screen
- stop testing

Only the 'when' statement can define a trigger. Press the **When Trig** softkey in the monitor and simulate menus to invoke the 'when' trigger.

## Triggers Provide a Reference

'When' statements provide a point of reference in the data stream. They tell the analyzer exactly when to start an action. All 'highlight', 'beep', 'start' and 'stop' statements reference the last preceding 'when' statement in the program. Without a preceding 'when' statement, the analyzer cannot determine the exact point to start, stop, beep, or highlight.

If you put a command at the beginning of the program, action starts at the beginning of execution. But, for an action to start at the precise time that some event occurs, you must use a preceding trigger for that event.

### **Enabling a trigger**

Triggers are locally active. They are enabled when the menu program is executing the block where a trigger is specified.



---

# Types Of Triggers

There are five different types of trigger conditions:

- Characters
- Leads
- Errors
- Timeouts
- Softkeys

---

## Characters

There are many conditions you can place on characters and character strings. This section explains what and how you can define your triggers.

Press the Text softkey for keyboard characters. Press SHIFT with another key to access lower case characters. Press CNTL and another key to access control characters .

**Edit Character Strings.** Use the cursor keys or the Delete and Insert softkeys to edit a string. Press MORE to access softkeys when the cursor is in the string.

**Setup After Typing a String.** If you change the data code or protocol in the setup menu after typing a character string, you must retype the string to avoid triggering on the wrong characters. Characters in one code may not have the same meaning in another code. The HP 4957A displays '?' if the newly selected code is not compatible with the previous code.

**Characters Not On the Keyboard.** EBCDIC and some other data codes have control characters not on the keyboard. Enter the hexadecimal equivalent of that character from the keyboard. Hexadecimal characters are displayed with a half-space underline, control characters are not underlined. This is to distinguish the two onscreen.

## Types Of Triggers

**Masking Out Characters.** Use the don't care condition to mask out string characters or bits of no interest. If any bit in a binary string is designated as 'don't care', the compressed character is denoted by a '?' in a box.

**Binary and Hex Characters.** Press **Hex** to enter characters in hexadecimal; enter two hex digits for each character. Press **Binary** to enter characters in binary. If the setup menu data code is less than eight bits, enter the correct binary digits, right-justified. The excess bits on the left are disregarded.

Use the **Hex** or **Binary** softkeys to enter hexadecimal characters or binary strings. Two hex numbers occupy each character position, requiring two keyboard entries. Hex characters are displayed with a half-space underline to distinguish them from text control characters with the same abbreviation.

When you press **Binary**, eight binary bits are displayed, allowing you to enter a 1, 0, or don't care in any bit position. When you move the cursor out of the binary string, it collapses to its hex equivalent but is double underlined to indicate it was entered in binary.

You can see the binary or hex value of a character by placing the cursor over that character and pressing **Hex** or **Binary**.

### Data Code

If the data code selected in the Setup Menu is less than eight bits (e.g., Baudot or Transcode), the appropriate number of higher order bits are disregarded.

**Excluding Characters.** To trigger on anything except a particular character, press **Not** before selecting the character. The analyzer places a bar over each character that you select until you press **Not\***.

**Flags and Frame Check Characters.** Flags and frame check characters are not automatically appended for 'when' strings. Enter these characters with the **Start Flag** and **End Frame**. End frame characters (the FCS characters and the last flag) may be useful if you wish to trigger on Bad FCS or Abort characters. Triggers for FCS errors or abort characters can only be programmed when a bit oriented protocol is selected on the setup menu.

**Parity.** The HP 4957A ignores the parity bit when triggering. You can see this by expanding the specified trigger character in binary when the setup is ASCII 7. The MSB (left) is designated 'don't care.' You can explicitly define this character by entering a 1 or 0 in binary to override the setup Menu. Parity error triggers can be entered only when a character oriented protocol is selected in the setup menu.

---

## Softkeys

The softkeys are numbered from 1 to 6 from left to right. The HP 4957A can trigger on the press of softkeys 3, 4, and 5.

'When Softkey' triggers can only be recognized when the program is executing the block in which they appear. 'When Softkey' triggers can cause a character trigger in the same block to be missed, if the character trigger is more than one character long. It is a good practice to have only error, lead, or timer triggers in the same block with softkey triggers.

---

## Multiple Triggers

You can combine triggers two ways:

- You can logically 'or' triggers by putting 'when' statements in the same block.
- You can 'sequence' triggers by putting 'when' statements in different blocks.

---

## ORing Triggers

'When' statements in the same block are ORed. To tell the HP 4957A to look for both events simultaneously put the 'when' statements in the same block. Once a trigger event is found all other triggers in that block are disabled. If two 'when' statements in the same block are satisfied simultaneously, only the one appearing first in the block is recognized.

```
Block 1:  
When DTE abcd  
    then goto Block 2  
When Error Parity on DTE  
    or  
When Error Parity on DCE  
    then goto Block 3  
When Lead RTS goes On  
    then goto Block 4
```

---

## Sequencing Triggers

In this example, the HP 4957A must find the string 'abcd' on the DCE before it can look for string 'efgh' on the DTE. To get to block 5, the analyzer must find both strings.

```
Block 1:  
When DCE abcd  
    then goto Block 2
```

```
Block 2:  
When DTE efgh  
    then goto Block 5
```

This allows the triggers to be conditionally enabled.

---

## Overlapping and Duplicate Triggers

For overlapping or duplicate triggers in the same block, the one found first disables the other triggers.

In the following example, if the data is 'yabc', only the first 'when' statement is satisfied. If the data is 'ybc' only the second 'when' statement is satisfied. If the data is 'yc', only the third 'when' statement is satisfied. The first 'when' statement to be satisfied disables the others.

```
Block 1:  
When DTE abc  
    then goto Block 2  
When DTE bc  
    then goto Block 3  
When DTE c  
    then goto Block 4
```

If the data is 'ybc', only the trigger 'c' is found.

```
Block 1:  
When DTE c  
    then goto Block 2  
When DTE bc  
    then goto Block 3
```

When there are multiple trigger strings in a block, some of the triggers may be partially matched at the time one of the triggers is satisfied. If the program loops back for the next 'when' statement, these partial matches are remembered when triggering resumes. This is useful when looking for strings on both sides of the line. This example, counts the number of times the string 'HELLO' occurs on the DTE and DCE side of the data line.

```
Block 1:  
When DTE HELLO  
    then goto Block 2  
When DCE HELLO  
    then goto Block 3
```

```
Block 2:  
Increment counter 1 by 1  
and then  
goto Block 1
```

```
Block 3:  
Increment counter 2 by 1  
and then  
goto Block 1
```

The HP 4957A begins matching triggers as the data comes in. When the 'O' comes in on DTE, the first when statement is matched. If at the same time, the first four characters of the second when statement are already matched. Since the program returns to block 1 for the next set of triggers. The partial match is remembered. When the final character on the DCE hello is received, the match on the second when statement is completed.

---

# Marking Triggers

The HP 4957A can mark each event you specify in the buffer, and it can beep whenever the event occurs. Each marking condition refers the last preceding trigger event.

---

## Beep

The 'beep' statement provides an audible sound for some specified condition. The analyzer can beep anytime, and as often as desired.

---

## Highlight

Use the 'highlight' command after a 'when' statement to mark trigger events in the buffer. Highlighted characters appear in half-bright, inverse video in the Examine Data menu.

Lead and timer transitions appear on the DCE line in the examine data menu if you are not using the **Data&State** display.

The HP 4957A remembers the last 64 highlights in the buffer. Only the last character of a trigger string is highlighted.

### **Not to Disk**

Highlights are not stored to floppy disk.



---

## Measuring Time

Timers measure the time between triggers. The HP 4957A monitor and simulate menus each contain five timers, 1, 2, 3, 4, and 5. Each timer can measure up to 65,535 milliseconds.

---

## Time Stamps

Timers measure by looking at time stamps that are inserted with the data entering the analyzer. Because data is stored in a 768 Kbyte first-in, first-out buffer, the time stamps are also stored. The timers measure the number of time stamps between trigger events.

Timing resolution yields character to character timing if bits/sec matches the line rate. Time stamps are stored in the buffer depending upon the bits/sec selection. If bits/sec is slower than the line rate timing measurement resolution is reduced. If bits/sec is faster than the line rate the buffer is filled with more time stamps than necessary and storage efficiency is reduced.

In bit oriented protocols, the start flag and address of a string have the same time mark. This is also true of the last character, the FCS, and the end flag.

---

## Timers

Timers measure the interval between trigger events. It must have a reference point to start and stop. Triggers provide a reference because they point to real events in the data stream.

To measure the time interval between two events, use two trigger statements to identify the events. After one trigger statement identifies the first event, start the timer. The second trigger statement identifies the second event, stop the timer.

## Measuring Time

Timers are set to zero at the start of program execution and can be reset during program execution with a 'reset' statement.

**Stop a Timer Without Resetting.** Timers can be stopped with either a 'stop timer' or a 'stop tests' statement.

### No Stop Tests

Do not use a 'Stop Tests' statement unless you want to stop program execution.

---

## The Effect Of the Data Filter On Timing

You cannot measure time if the data filter is turned on because the time stamps are filtered out of the data stream. And if you have 'timing information' turned off in the data filter your timing measurements will be inaccurate.

### Timing Information

Make sure 'timing information' is turned on in the data filter before you try to measure time.

If the timing information is disabled (turned off) in the data filter menu, then the cursor timing feature operates normally with three exceptions.

- The range within measurements that can be made is no longer 65,536 times the time stamp resolution, instead, is only 64 times the time stamp resolution (see Table 8-2).



- The range in item 1 above is absolute, not relative. So for any given start point, the total time before and after the start point is 64 times the resolution of the time stamps. For example, if the speed rate is 2400 bps, then the resolution is 1 millisecond.

#### Long Time Intervals

Long time intervals can still be calculated by knowing how many times the range or boundary is crossed and then adjusting the result accordingly.

Cursor timing is meant to be used only when timing information is enabled. Timers in Monitor and Simulate menus do not work at all if the timing information is disabled when data is captured.

Timing information should only be disabled to retain the maximum amount of data in the capture buffer, especially in low line use situations. One time stamp is inserted in the incoming data stream for each six bits. With low line usage, this will fill the buffer with more time stamps than is necessary.

---

## Lead Changes

Timing on lead changes is exact to the resolution provided by the data rate selection in the setup menu. Lead changes on the T and R lines (when an X.21 protocol is selected) are exceptions. Timing information for the T and R lines is delayed 16 bit times from the beginning of a steady state '1' or '0'. Timing on these signals represents when the lead should be recognized as a steady state '1' or '0', and not when the steady state signal began.

**COP Send Strings.** Data sent by the HP 4957A in character-oriented protocols (using send strings) has a two-bit offset in the timing information. Each transmitted character actually begins two bit times after the time reported by a cursor timing measurement.

## Measuring Time

Data received by the HP 4957A in character-oriented protocols is time stamped two bit times after each character is completed. So the delay from the start of each character to its time stamp is one character time plus two bit times.

The last character in a sync pattern has an added delay of one more character time. So the delay from the start of the last sync character to its time stamp is two character times plus two bit times.

The first character in a two character sync pattern has an added delay of still another character time.

**Bit-Oriented Protocols.** Data in bit-oriented protocols is time stamped in the same way whether it is sent or received by the HP 4957A.

The start flag time stamp has a delay equal to 26 bit times plus one bit time for each zero automatically inserted in the bit stream of the first two characters following the start flag. A zero is automatically inserted after a series of five consecutive ones.

The first byte (address) has a time stamp delay of 18 bit times plus one bit time for each zero inserted during its own transmission or during the following byte. The result is that a cursor timing measurement from the start flag to the first byte shows `time = 0.0 ms`.

All other bytes, except the Frame Check Sequence (FCS), are time stamped 34 bit times after they begin, plus one bit time for each zero inserted after any of these 34 bits.

The first byte of the FCS is time stamped 24 bit times after it begins plus one bit time for each inserted zero. The second FCS character is time stamped 16 bit times after it begins plus one bit time for each inserted zero.

The end flag time stamp has a delay of eight bit times.

**Timing Resolution.** Timing resolution is the smallest unit of measurement that can be timed at a given speed. The following table gives the resolution for speed ranges, and a correction factor for exact measurements. To get a more exact measurement, multiply the time measured by the corresponding correction factor.

**Table 8-2. Timing Resolution**

<b>Data Rate Selection</b>	<b>Resolution</b>	<b>Factor</b>
50-2400	1.0 msec	1.0004
3200-4800	0.5 msec	1.0008
7200-9600	0.2 msec	1.002
12000 - 256 kbps	0.1 msec	1.004

**Cursor Timing Limits.** The maximum cursor time that can be measured before an overflow will occur is given in the table below. To determine the maximum cursor time that can be measured, select the speed (Bits/sec) and the corresponding maximum cursor time is given to the right in the table. If an overflow does occur, you will have to use the Monitor menu timers and run from buffer data.

**Table 8-3. Cursor Timing Limits**

<b>Bits/sec</b>	<b>Maximum Cursor Time</b>
50 - 2400	66.24 seconds
3200 - 4800	33.14 seconds
7200 - 9600	13.28 seconds
12000 - 64 kbps	6.66 seconds

At 64 kbps full duplex, data may be time stamped so that occasional groups of two or three sequential characters appear to be simultaneous. This has no cumulative effect.

---

## Counting Events

The HP 4957A has five counters that can count five different events simultaneously. The counter can be incremented by any number up to 65,535. For example, if you increment counter 4 by 2 every time an event occurs, the statement looks like this:

**Increment Counter 4 by 2**

---

## Countable Events

Countable events can be characters or character strings, lead changes, timer changes, counter changes, or program loops. Almost any action the analyzer performs can be counted. Place the increment counter statement directly after the event of interest.

**Maximum Count.** Each counter counts to 65,535 and then starts over from zero. You can cascade counters by having one counter increment whenever a second counter overflows.

**Resetting Counters.** Counters are always reset to zero at the start of execution. Counters can be reset with the 'reset counter' statement. When they are reset during a program, they go to zero and do not restart unless you start them again with an "increment counter" statement.

**Decrementing Counters.** To decrement a counter by 1, set the increment value to 65,535 rather than 1. To decrement by 2, set the increment value to 65,534. And so on.

---

## Branching

You can cause a conditional branch in the program using the 'if' statement or an unconditional branch with a 'goto block' statement. The 'if' statement branches if a condition is satisfied. The 'goto block' statement forces a branch regardless of any conditions.

---

## Conditional Branching

Tell the analyzer when to test lead status with a trigger. 'If lead' statements always test the link at the time the last trigger was found. There should always be a trigger statement before the 'if' statement.

A trigger must be used to define the exact time, therefore a 'when' statement must appear earlier in the program when using 'if lead'. An 'if lead' statement always refers to the lead condition at the time of the last trigger.

**If Counter.** Counters run independently of line status. Therefore, 'if counter' statements do not need to be preceded by 'when' statements.

To use the 'if counter' command, press **Counter** and select the counter number. Then type the comparison number. You can enter any number from 0 to 65,534.

**How 'If' and 'When' Are Different.** Only 'when' can define a trigger and wait for an event. 'If' tests the current status. Unlike 'if', the 'when' statement pauses program execution until the trigger is satisfied.

**Branching**

**Combining 'If' Statements.** 'If' statements in the same block are 'ORed'. The analyzer looks for all the conditions at the same time. The first satisfied 'if' controls the branch.

**Combining 'If' and 'When'.** 'If' can be used to guarantee action. For example, if you enter:

```
When Lead RTS goes Off
    then goto Block 2
```

and RTS is already off, the program never moves. No program statements are executed until the trigger is satisfied. The 'when' statement requires a transition. On the other hand, if you enter:

```
If Lead RTS is Off
    then goto Block 2
```

and RTS is on when the 'if' statement is executed, the program will never go to block 2. Unlike the 'when' statement, 'if' does not wait for a condition to happen. To ensure that execution always moves to block 2 when RTS goes off, enter the following:

```
If Lead RTS is Off
    then goto Block 2
When Lead RTS goes Off
    then goto Block 2
```



---

## Unconditional Branching

An unconditional branch forces a jump in the program. Use the 'goto block' or 'gosub' command to branch to a different part of the monitor or simulate program.

**'If' and 'When' Always Force a Branch.** Both 'if' and 'when' commands automatically append a conditional 'goto block' statement.

You can use 'goto block' to loop continuously. In the following example, you increment counter 1 until it reaches 200 and then jump out of the loop.

```
Block 1:  
Increment Counter 1 by 1  
If Counter 1 > 199  
    then goto Block 3
```

```
Block 2:  
Goto Block 1
```

---

# Program Pauses

There are many times in a program you must enter a pause statement.

For example:

Wait 40 milliseconds for a relay to open before performing the next program command.

### **Not wait statement**

Do not use the 'wait' statement in the simulate menu to delay simulate programs. 'Wait' affects 'send' and 'set lead' output statements.

A timer is the best way to insert a program delay without multiple triggers.

```
Block 1:  
Beep  
    and then  
Start Timer 1  
When Timer 1 > 3000  
    then goto Block 2
```

```
Block 2:  
Reset Timer 1  
    and then  
Goto Block 1
```

Using a timer to delay is not always the right solution. Timer status can only be tested with a 'when' trigger. The trigger pointer moves through the data looking for the trigger event, but cannot move backwards.

---

## Starting and Stopping

You can control the display or the disk using 'start' and 'stop' commands. The 'stop tests' command halts program execution.

There are two ways to provide a reference point for 'start' and 'stop' commands:

- Start of execution. If you put a 'start' or 'stop' command at the beginning of the program, it becomes active when you begin program execution.
- Preceding trigger. The last 'when' statement in the program provides a reference.

A 'start' or 'stop' becomes active when the last trigger event was found. If you insert a program pause using a timer or counter, 'start' or 'stop' is delayed by the amount of the pause.

---

## Filtering Data With 'Start' and 'Stop'

The 'start' and 'stop' commands can filter events of interest. Define an event in a 'when' statement and then start or stop the display or disk when that event occurs.

## 'Start' and 'Stop' Disk

You can start and stop the disk to capture only events of interest as often as you like. The following rules apply to 'start' and 'stop' disk statements:

- The disk can be started and stopped more than once.
- The 'start' command stores 256 bytes of the buffer preceding the event. The 'stop' command stores 256 bytes of the buffer after the event (256 bytes may be up to 125 characters depending on time stamp frequency and line utility). There is no way to indicate the event on the disk because highlights are not stored to disk.
- Timing measurements should not be made across fragmented data segments. The results could be in error.

**Not from the buffer**

'Start Disk' is ignored when running from the buffer.

When you execute a monitor or simulate program with a 'start disk' statement, the analyzer asks you to provide a file name and comment for the new disk file. The file type is always 'Menu & Data' and cannot be changed.

---

## 'Start' and 'Stop' Display

The 'stop display' statement freezes the display after the occurrence of a trigger event. That trigger event and the preceding data are displayed on the screen. Execution is not stopped even though the display is turned off. The buffer is continually being filled with new data. To start the display again, use a 'start display' statement, or the **Start Display** softkey.

### **Turn the display off**

It is more efficient to turn the display off if you are running a program that causes buffer overflow errors.

---

## Stop Tests

The 'stop tests' statement halts program execution. No new data is loaded into the buffer, the disk stops, and any active timers stop.

- A 'stop tests' command is executed only after all the 'wait', 'send', and 'set lead' statements prior to it are performed.
- The 'stop tests' statement halts execution of all other program statements.
- If there are no 'when' statements in the program, the display will continue running until rule 1 is satisfied.
- The **(EXIT)** key is the only way to halt immediately.

---

## Commenting

The HP 4957A allows for commenting programs with the 'message' statement. These messages are also displayed at the bottom of the screen during execution. Messages are entered the same way as send strings, except that characters can only be inserted or deleted. Hex characters cannot be entered.

- You can insert comments in a long program to help you remember what different parts of the program do.
- You can have the analyzer display a message during execution for debugging programs. You can discover where program execution is locking up.
- You can have the analyzer tell you to perform some action during execution, such as pressing a softkey.
- You can label softkeys 3, 4, and 5, which are those used for softkey triggers.

---

## Entering Messages

Press **Message** and begin typing text after **Message**. Messages can be up to 16 characters long (including spaces).

You must enter something in the message field, even if it is only blanks. If you do not enter anything in the field, an error message appears when you try to execute.

**Fill the field**

It is recommended to fill in all 16 characters of the message field, using spaces as necessary.

If a message is not 16 characters, some characters of a previous message may still show on the display.

For example:

If your first message was EXIT RUN PROGRAM, and the second message was START PROGRAM, the display after the second message would be START PROGRAMRAM. Filling the rest of the second message with spaces would fix the problem.

If a message is used to label softkeys 3, 4, and 5, the problem just described becomes an advantage. A message can be sent to label the three softkeys. Later in the program, a new message can change one of the softkeys and leave the others.

---

## Displaying Messages During Execution

Messages are identified by their block number. When a block with a message, or multiple messages, is executed, the message(s) in that block are displayed. A message can therefore be displayed during execution in the following ways:

- The message block is executed during normal sequential execution.
- A 'goto block' command references the message block.
- 'If' or 'when' statements reference the message block.
- A 'gosub block' command references the message block.

---

# Subprograms

You can enter subprograms using the 'gosub block' and 'return' commands. You can nest up to eight subroutines. Subprograms are useful if a sequence of statements is used repeatedly in the program. Enter the sequence of statements once. If you put a 'return' statement at the end of the sequence, you can call that sequence anytime with a 'gosub block' statement.

The 'gosub block' statement causes a jump to the designated block. The 'return' statement causes a jump back to the line immediately following the 'gosub block' statement.

Let's assume there are several places in a program where one of three different error messages might need to be displayed. Instead of entering all of the different error messages in the program repeatedly you can enter three subprograms.

For example:

```
Block x:  
Message This is BCC Err  
    and then  
Return  
  
Block xx:  
Message This is Par. Err  
    and then  
Return  
  
Block xxx:  
Message This is Fram Err  
    and then  
Return
```



For example:

The same five second delay is used three times.

```
Block 5:  
Start Display  
    and then  
Gosub Block 25
```

```
Block 6:  
Stop Display  
    and then  
Gosub Block 25
```

```
Block 7:  
Start Display  
    and then  
Gosub Block 25
```

....

```
Block 25:  
Start Timer 1  
When Timer 1 > 5000  
    then goto Block 26
```

```
Block 26:  
Reset Timer 1  
    and then  
Return
```

---

## Level 2 Programming

The HP 4957A assists you in entering level 2 and level 3 'send' and 'when' strings. This extension of softkey programming is in the monitor and simulate menus.

### **Must be BOPs**

The setup menu protocol must be bit oriented, e.g., SDLC, HDLC, or X.25.

The 'send' command is available only in the simulate menu. However, the level 2 and 3 assisted mode is similar for 'when' and 'send' strings.

As you type in each entry the cursor automatically moves to the next entry position. A prompt appears to tell you the next entry and the previous entry. The prompting message also appears when you manually move the cursor with the cursor keys. For the cursor to move automatically to the next entry position, you must actually type in an entry, even if it is the same as the present entry. Of course, you can always move the left and right cursor keys to the adjacent field.

The Level 2 softkey allows the entry of the Address (Extended if present), Frame bits, Frame type, Poll/Final bit, N(S) (if present), and N(R) (if present).

---

## Address Field

You are prompted to enter (in hex) a value for the address field. This prompt is displayed at the bottom of the HP 4957A display. If the right-cursor key is pressed before entering an address, it defaults to 00 hex.

**Extended Addressing.** If extended addressing is on in the setup menu, two softkeys appear in the address field: **End Addr** and **Extend**. Pressing **Extend** sets the least significant bit (LSB) to 0 and then adds a new byte to the address field, if necessary. Pressing **End Addr** ends the address field by setting the LSB at the cursor position to 1.

## Frame Type

After entering the address, you are prompted to enter the frame type.

**I-Frame.** When you select I-frame, the LSB (farthest right) is set to zero. Then you are prompted to fill three fields: P/F is one bit, N(R) and N(S) are three bits each.

N(R) | P/F | N(S) | 0

N(S) Takes on values 0-7 if extended control (in the setup menu) is off; 0-127 if extended control is on. If a number greater than the upper limit is entered, N(S) defaults to the upper limit.

P/F Enter a 1 or 0 in the P/F field.

N(R) Same as N(S). Pressing the left-cursor key leaves the N(R) value unchanged. Entering a value for N(R) will exit you from level 2 entry.

**S-Frame.** When you select S-frame, the LSB (farthest right) are set to 01. Then you are prompted to fill the next three fields from right to left. S-frame type is two bits, P/F is one bit, N(R) is three bits.

N(R) | P/F | type | 01

S-frame types:

- RR
- RNR
- REJ
- SREJ

**Level 2 Programming**

After entering the S-frame type, you are then prompted to enter the P/F field and then the N(R) field. After entering N(R) the HP 4957A exits from the level 2 entry mode.

**U-Frame.** When you select U-frame, the two LSBs (farthest right) are set to 11. You are then prompted to select the type of U-frame:

- SARM
- SABM
- SNRM
- DISK
- RD
- UA
- DM
- FRMR
- SARME
- UI
- SIM
- UP
- RSET
- SABME
- SNRME
- RIM
- XID

The type of U-frame is defined by two 3-bit fields filled at the same time when you select U-frame type from the softkeys. The default value for the U-frame type is UI. The P/F field requires one bit.

**type | P/F | type | 11**

After entering P/F the analyzer exits you from the level 2 entry mode.

---

## Level 3 Programming

Packets are entered by selecting Level 3 and then the entry point, general format identifier (GFI), logical channel number (LCN), or packet type. When GFI is chosen, the Q and D bits and the modulo 8 or 128 can be entered. If packet type is chosen, softkeys appear for 17 different packet types.

The **Level 3** softkey enables you to enter the three fields of the packet header: GFI, LCN, and Packet Type. For most packets, these each take up one byte. Some packet types, however, require a longer packet header. The packet header normally follows the first two bytes of level 2 information, 'address' and 'control.'

flag | address | control | GFI | LCN | packet type

Of course, if either **extended address** or **extended control** in the setup menu are on, there may be more than two level 2 bytes. Frame type also determines the number of level 2 fields.

### Moving the cursor

If you move the cursor too far and drop out of assisted mode, press the **Level 2** or **Level 3** softkeys again. Then move the cursor to the desired field.

## Selecting Level 3 Before Level 2

In this case, zeroes are automatically appended for the level 2 bytes in send strings, and 'don't cares' in trigger strings. Unless **extended address** or **extended control** in the setup menu are on, the cursor is positioned on the third byte, 10 hex. Flags are shown by '|', and a good frame check sequence by GG.

| 000010GG |

When you press **Level 3**, three new softkeys appear allowing you to enter the packet header from three different points: GFI, LCN, and Packet Type. If LCN is selected before GFI (missing GFI), the Q and D bits are set to zero, modulo 8 is selected, and the LCGN is set to zero (don't cares for trigger strings). If Packet Type is selected first (missing GFI and LCN), GFI is set the same as above, and the LCN is also set to zeros (don't cares for trigger strings).

**GFI Field.** The GFI byte consists of three fields from left to right: Q, D, MOD, and LCGN. Q and D consist of one bit each, Mod is a 2-bit field, and LCGN is a 4-bit field.

Q | D | mod | LCGN

**Q Bit.** Pressing the GFI softkey prompts you to enter a 1 or 0 for the Q bit. When you enter a value for the Q bit or press the right-cursor key, the D-bit prompt appears.

**D bit.** When you enter the D bit or press the right-cursor key, the D prompt appears.

**Mod.** Press either **Mod 8** or **Mod 128** to select either 01 or 10 for the two-bit mod field. Entering a value for the mod field or pressing the **▶** causes the LCGN prompt to appear. Pressing **Mod 128** causes the packet type field to expand to two bytes for some packet types (see Data Packet Fields).

**LCGN Field.** The LCGN is a four-bit field which you can enter with a decimal value from 0 - 15.

**LCN Field.** The LCN field is the next byte to the right of the GFI byte. You can use either decimal or hex entry to select values from 0-255 or 00-FF.

**Packet Type Field.** When the last digit of the LCN is entered, the “packet-type” field appears, making the following softkeys available:

- DATA
- CALL
- CALL ACPT
- RR
- RNR
- REJ
- CLEAR
- CLR CNFM
- RSET
- RSET CNFM
- INT
- INT CNFM
- RSTRT
- RSTRT CNFM
- DIAGNOST
- REG
- REG CNFM



The default packet type is Data. If Mod 128 was chosen in the GFI field, the packet-type field expands to two bytes for some packet types, as described below.

The Packet-Type field for a data packet is like the control field for an I-frame. Entry of the P(S), M, and P(R) is just like the entry of N(S), P/F, and N(R) fields. When you select a Data packet, the LSB (far right) becomes zero. Then you are prompted to fill three fields from right to left. P(S) and P(R) each require three bits; M requires one bit.

P(R) | M | P(S) | 0

If you selected Mod 128 in the GFI, the packet-type field consists of two bytes rather than one. P(S) and P(R) each take up seven bits.

**Other Packet Types.** RR, REJ, and RNR packet types have a P(R) field. All other packet types do not have any such fields except Data.

---

## Conditions when Simulating

The line does not display idles or store idles in the buffer unless the send characters are explicitly placed in the send string.

---

## Block Check Characters

In character oriented protocols, the HP 4957A automatically appends the correct Block Check Characters (BCC) to 'send' strings. You can see this character at run-time or in the buffer after a run. In 'char' protocol setup you can select the characters on which error checking is to start and stop. In the setup menu, the 'start on' selection begins error checking following the designated character. The 'stop on' character includes the designated character in the error check.

### **Automatic for BSC**

Bisync automatically appends BCC characters. The start and stop characters are preset.

The BCC is automatically generated for the first required BCC. For any subsequent BCC blocks of text or data within the same sync pattern, you must enter BCC manually into the string.



---

## Frame Check Sequence

Flags and frame check sequence (FCS) characters are automatically added when a bit oriented protocol (HDLC, SDLC, X.25) is selected. The HP 4957A does not show you the actual frame check character.

For received data, GG, BB, or AA are displayed to indicate 'good FCS', 'bad FCS', or 'abort'. For 'send' strings, good FCS characters (GG) are automatically selected; but you may choose bad FCS (BB) characters or abort (AA) characters either by explicitly entering the frame check characters, or by using **End Frame**. Flags and frame check characters disappear if you change the setup to a character oriented protocol and again move the cursor into the string.

In bit oriented protocols, the HP 4957A automatically inserts a 0 (invisible to you) after five consecutive 1's before transmitting non-flag characters (invisible to the user). When receiving, it automatically removes any 0 bits inserted by the transmitter.

## Set Lead

The 'set lead' command turns a selected interface lead on (SPACE) or off (MARK). With an RS-232C/V.24 interface, a lead is on when the voltage is approximately +2V and off when the voltage is approximately -2V. The protocol idles in the SPACE condition.

**Lead Status During Simulation.** When simulating, only the appropriate lead softkeys are displayed. At the beginning of simulate execution, the HP 4957A sets all the leads it can drive to off. You must use 'set lead' statements to perform handshaking with the receiving device.

Because the HP 4957A always sets the appropriate DTE or DCE leads off at the beginning of the simulation run, 'set lead' statements are needed to turn the appropriate leads on before sending data. If this is not done, the receiving device might not accept data from the HP 4957A.

### **Set Leads**

Determine which interface leads must be set on or off before sending data. Otherwise, the receiving equipment may not accept the data.

———— Setup and Line Parameters

---

## Setup and Line Parameters

There are two ways to set up the HP 4957A. You can use Auto Configure to let the protocol analyzer evaluate the line. Or, if you know the line parameters you can use the Setup menu and manually make the settings.

Setup is the first step in using the HP 4957A. You must set several parameters so the instrument can understand and decode the data on the line. Before you can monitor a line, you must tell the HP 4957A what protocol, data code, data rate, and other parameters are being used.

Setup, whether performed manually or with Auto Configure, affects the settings in the other menus.

For example, error checking is performed during monitoring according to the current setup. The appropriate error checking characters are automatically appended to Send strings. Data is displayed in the Examine Data or Run Menus according to the current setup.

---

## Using Auto Configure

Auto Configure automatically configures the HP 4957A to a line. The protocol analyzer evaluates the data stream on the line, determine the setup based on the parameters it finds and place the instrument in the monitor mode.

The Auto Configure softkey is conveniently located in the top level menu. If the line parameters need to be changed or if you need to make any changes to the current setup you must use the Setup Menu.

---

### To use Auto Configure:

1. Connect the analyzer to the line for monitoring.
2. Press **Auto Config** in the top level menu.

Pressing **Auto Config** tells the HP 4957A to evaluate the line parameters, identify the presence and speed of clocks, look for common sync characters, identify parity and character length, and put these measurement results into the setup menu.

#### **Blinking asterisk**

A blinking asterisk is displayed whenever Auto Configure is working. This indicates that the instrument is still checking line data.

## Using Auto Configure

If a good parameter match is found, the HP 4957A briefly shows the setup menu with the new parameters, goes to the monitor mode, and begins displaying data. If a good match is not found the previous setups are restored.

You may at any time press the **Summary** softkey to review the set-up results. To change the display format, or any other setup parameter, halt the run by pressing **(EXIT)**, and then go to the Setup Menu to modify the setup. Go back to the Run menu to resume execution.

### Changes the Setup Menu

When monitoring begins, Auto Configure changes the setup menu and buffer data. If you need to save the present setup and buffer data, store them to floppy disk using the Mass Store menu.

**Auto Configure Results.** The HP 4957A Auto Configure function can have several results. It will evaluate data streams and correctly determine COPs such as BSC, BOPs such as SDLC (NRZ or NRZI), HDLC (X.25) and then determines appropriate data codes, ASCII, EBCDIC, Baudot.

### Inverted Data

Auto Configure cannot find IPARS or any inverted data case.

Data rates can be determined from 50 bps to 38.4 kbps for asynchronous and 1200 bps to 64 kbps synchronous.

---

## Auto Configure Algorithm

The HP 4957A does a thorough examination of the data stream when **Auto Config** is pressed. It is important for you to understand the process so you will understand the messages that may appear.

### Looks for clocks

The Auto Configure algorithm first looks for clock activity on the line. Crosstalk on the clock lines may result in the instrument thinking it has found a false clock.

**Synchronous Data.** The analyzer first looks for a clock to determine sync or async data. When a clock is present on the line:

1. The HP 4957A determines the data rate.
2. The analyzer will then look for idle types. When the data idles in NRZI 7E the analyzer automatically sets up in SDLC EBCDIC.
3. When the data idles in non-NRZI 7E the analyzer sets up for synchronous BOPs.
4. When the data idles in FF the analyzer sets the data code and parity and then checks for BSC. If the data is not BSC the instrument sets up for synchronous COPs.
5. When Auto Configure does not complete within 15 seconds, the HP 4957A will repeat the process and try to auto configure again.

**Asynchronous Data.** When there is no clock on the line:

1. The analyzer determines the data rate.
2. The analyzer looks at idles. If the idles are NRZI the setup is immediately set at SDLC EBCDIC.
3. If the data idles in FF the analyzer determines how many bits per character. The setup is made in ASYNC COPs depending on the bits/character.
4. When Auto Configure stops at any step for 45 seconds, it will begin the auto configure process again.

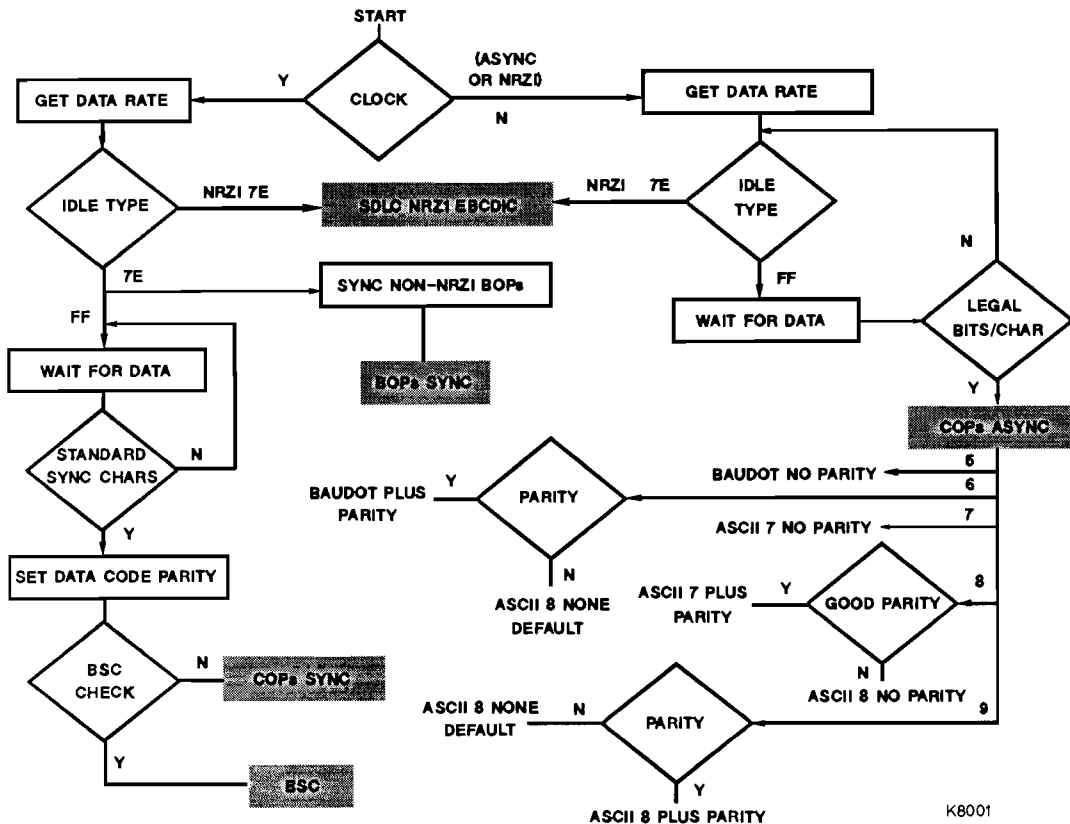

**Figure 9-1. Auto Configure Algorithm**

K8001



---

## Auto Configure As a Starting Point

Auto Configure works with most protocols and data codes, however, it may not find all the parameters if the protocol is nonstandard, there is insufficient information, or the data present is not random.

Auto Configure provides a starting point for setup because it always finds some of the line parameters. The setup parameters that Auto Configure finds are displayed as they are found, but you must reenter these parameters into the Setup menu if Auto Configure completes only a partial setup.

**Bit Oriented Protocols (BOPs).** Auto Configure will setup synchronous, NRZ, and NRZI BOPs. BOPs are assumed to idle the line in flags (7E). BOPs will be setup as:

**Table 9-1. BOPs Setup from Auto Configure**

Protocol	Data Code	Parity
X.25	ASCII8	none
HDLC	ASCII8	none
SDLC	EBCDIC (including clocked NRZI)	none

All BOPs default to frame display format.

**Configuring To Bit Oriented Lines.** When monitoring a BOP line, line indicators should be flashing with clock activity except in the case of monitoring an NRZI line, (when simulating NRZI, a clock is put on the interface).

**Auto Configure to set up**

Use Auto Configure for initial setup. You will have to change setups in the following cases.

- HDLC with Extended Address or Control. Change the protocol to HDLC with the following setup:

**Ext Addr and/or Ext Ctrl: On    Display:Frame**

- X.25 Packets if the address is not  $0_10_3$ . If the protocol is X.25, change the setup to the following. After capturing data, use the Examine Data Menu to observe packet decoding.

**Protocol: X.25                    Display: Packt**

You can use any of the six display formats for BOPs. For frame (level 2) decoding, use the Frame display. For packet (level 3) decoding, use the Packet display.

To observe extended address and control on HDLC lines, go to the setup menu and change the protocol to HDLC. Turn on extended address and/or extended control, and change the display format to Frame.

**Character Oriented Protocols (COPs).** Auto Configure always selects Char setup for character oriented protocols, unless it finds a match with BSC setup. The sync and control characters in COPs must be standard (i.e., ASCII sync =  $^1_6^1_6$  and EBCDIC sync =  $^3_2^3_2$ ). COPs must idle the line in FF. COPs will be setup as follows:

**Table 9-2. Synchronous COPs Setup from Auto Configure**

Protocol	Data Code	Parity	Sync on	Err Chk
BSC	ASCII8	none	$^1_6^1_6$	LRC or CRC16
BSC	ASCII7	odd	$^1_6^1_6$	LRC or CRC16
BSC	EBCDIC	none	$^3_2^3_2$	LRC or CRC16
CHAR	EBCDIC	odd/even	$^3_2^3_2$	
CHAR	EBCDIC	none	$^3_2^3_2$	
CHAR	ASCII8	odd/even	$^1_6^1_6$	
CHAR	ASCII8	none	$^1_6^1_6$	
CHAR	ASCII7	odd/even	$^1_6^1_6$ or $^9_6^9_6$	
CHAR	ASCII7	none	$^1_6^1_6$	

All COPs will default to 2 line display format.

**Table 9-3. Asynchronous COPs Setup from Auto Configure**

Protocol	Data Code	Parity
CHAR	ASCII8	odd/even/none
CHAR	ASCII7	odd/even/none
CHAR	Baudot	odd/even/none

---

## Using the Setup Menu

Press **Setup** in the top level menu to access the setup menu. Move the cursor to the protocol field and select the desired protocol. Those available are:

- HDLC
- SDLC
- X.25
- BSC
- Char
- X21 HDLC
- X21 SDLC
- X21 X.25
- X21 BSC
- X21 Char

You can manually change the setup at any time and from any menu by pressing **EXIT**, and then **Setup**. This puts you in the setup menu where you can reselect.

When you select a particular protocol, the menu fields change to let you make selections which are specific only to that protocol.

The setup menu may be used when Auto Configure cannot find all the parameters. You must use the setup menu for simulating or monitoring the buffer.

---

## When To Use the Setup Menu

Auto Configure automatically configures the HP 4957A to most lines. You may, of course, use the setup menu to manually configure. Generally, however, use the setup menu for:

- **Monitoring.** You cannot use Auto Configure to monitor the buffer.
- **Simulating.** You must use the setup menu to define a 'send' string.
- **Changing display formats.** Auto Configure always uses the display format currently selected in the setup menu. Use the setup menu to change display formats.
- **Supplementing Auto Configure.** Use the setup menu to modify any parameters after initial setup with Auto Configure.

**Saving Setups.** Menus are always saved in the HP 4957's nonvolatile buffer memory if you turn off the instrument while in the top level menu. You can store menus, or both menus and data to disk

---

Monitor/Simulate Parameter Setup			
Protocol	HDLC	Display	2Line
Code	ASCII 8	Err chk	CCITT
Bits/SEC	64K		
Parity	None		
Mode	Sync	DTE clock	DCE
		Bit sense	Norm.
		Ext Addr	Off
		Ext Ctrl	Off

HDLC SDLC X25 BSC Chv

K2022

Figure 9-2. The Setup Menu

---

## Configuring to Protocols

The HP 4957A can monitor and simulate BOPs, COPs, BSC, and NRZI.

---

### Bit Oriented Protocols (BOPs)

Code	The bit-oriented menus allow ASCII 8, EBCDIC or, using Hex 8, any 8-bit code.
Display	All six display formats are available for the bit oriented menus. Frame format decodes all control field bits. Packet format decodes packet information.
Bits/Sec	Data capture from 50 bps to 64 kbps. Except for NRZI, all the selections are supported. NRZI will not work at 16000, 12000, 2000, or 50 bps. With option 001, data capture up to 256 kbps.
Error Check	CRC-CCITT preset 1 or preset 0.
Mode	All bit-oriented protocols are synchronous. In NRZI, (HDLC and SDLC) the clock is encoded within the data. When NRZI mode is selected, the HP 4957A will derive its receive clocks from the data on each channel and will use the clock signals on RC and ETC.
DTE Clock	DTE data can be synchronized to either a DCE or DTE clock. If this selection is incorrect, only DCE data will be displayed.
Ext Addr (HDLC)	HDLC allows an extended address field. When an additional address octet (byte) is to follow, the first or least significant bit of the address octet is set to 0. The last address octet in a series has the LSB set to 1. Use Frame display format to see the extended address.
Ext Ctrl (HDLC)	HDLC allows a 16-bit control field to handle larger N(S) and N(R) counts. Use Frame display format to see the extended control field.

**X.21 Needs a Pod**

Do not select the X.21 protocols unless the HP 18294A or HP 18260A Interface pod is connected.

In bit-oriented setups, the HP 4957A performs automatic zero bit insertion/extraction.

## Bisync (BSC) Setup Definitions

Code	Only EBCDIC, Transcode, and ASCII7 and 8 are available.
Bits/sec	The bit rates for BSC are from 50 bps to 64 kbps.
Parity	The HP 4957A automatically sets correct parity for the chosen code: odd parity for ASCII 7, none for EBCDIC and Transcode. In the simulate mode, BSC is sent with the correct parity. However, if 'send' characters are specified in hex or binary, the parity is allowed to be different from the setup selection.
Mode	BSC is synchronous, half-duplex only. The CHAR protocol should be used for full-duplex BSC synchronous COPs.
Sync on	The HP 4957A automatically chooses the correct sync characters for each data code. The sync characters are: $^3_2^3_2$ (EBCDIC), $^1_6^1_6$ (ASCII), or $^3_A^3_A$ (Transcode). The HP 4957A requires at least two sync characters for proper framing.
Disp Mode	Frame and Packet display formats are not available in BSC.
Err Chk	Select LRC or CRC-16 for ASCII or EBCDIC, and select LRC or CRC-12 for Transcode.
clock	Can be either DTE or DCE.
Suppress	The BSC menu lets you suppress most combinations of text, control characters (blue characters on keyboard), idles ( $^0_0$ ), and nulls ( $^F_F$ ) from the display. However, suppressed characters are not deleted from the buffer.
Bit sense	Either normal or inverted.



---

## Character-Oriented Protocols (COPs)

The Char menu is a general purpose setup menu used to capture most character-oriented protocols, synchronous or asynchronous. There are many codes available. You can select all the parameters to go with your data code. Of course, you can also create setups which make no sense: e.g., an 8-bit data code with a CRC-12 error check or synchronous Baudot.

Using COPs, you are able to see all bits on the line in synchronous mode if you **sync on idles**.

### **No Insertion**

The HP 4957A does not perform zero bit insertion or extraction for bit oriented protocols when in Char setup.

### **Char Setup Definitions.**

Code	You can select and define: ASCII8, Hex8, ASCII7, Hex7, Hex6, EBCDIC, Transcode, Hex5, IPARS0, IPARS1, Baudot, or EBCD. Do not make either IPARS selection unless you have loaded IPARS_MEC from the Utility Disk. The results may be incorrect.
Bits/sec	From 50 bps to 64 kbps synchronous. From 50 bps to 38.4 kbps asynchronous. Extended asynchronous available on the Utility Disk makes 56 kbps and 64 kbps available. With option 001, up to 256 kbps asynchronous.
Parity	None, Even, Odd, Ignore.
Transparent Text Char	You can define a transparent text character in either hex or text. The analyzer does not see the character for drop sync or error checking conditions. Same as DLE in BSC.

**Configuring to Protocols**

Mode	Select synchronous, monosynchronous, or asynchronous (1, 1.5, 2 stop bits during simulation). The HP 4957A needs only one stop bit for asynchronous monitoring, even if more are present.
Sync on	Selects the sync characters for proper framing. The HP 4957A requires at least two sync characters (or one for monosync setup) to capture data when monitoring or simulating character oriented protocols. In monosync, it is very important that the sync pattern not be found in the data stream.
Drop sync after	Tells the analyzer to drop sync (stop bringing in data) and start looking for sync characters again.
Display	Allows you to select the display format: Two Line, DTE Only, DCE Only, or Data&State.
Start on/Stop on	Error checking starts on the character immediately after either of the 'start on' characters, but includes the 'stop on' character. The fourth 'stop on' character is an intermediate text character (ITB). The first three 'stop on' characters normally cause sync to be dropped but the ITB character causes the channel to remain in sync. For IPARS and other 6-bit codes, setting the most significant bit in a 'stop on' character to 1 (e.g., changing 0D to 8D) will cause characters which were ITBs not to be ITBs, and vice versa. Press <b>CNTL</b> <b>/</b> to enter an ITB from the keyboard (US).
DTE Clock	Specifies the DTE clock source, DTE or DCE.
Suppress	Lets you suppress most combinations of text, control characters (blue characters on keyboard), idles ( <sup>0</sup> o), and nulls ( <sup>F</sup> F) from the display. However, suppressed characters are not deleted from the buffer.
Bit Order/Sense	In most protocols the least significant bit (LSB) is sent first and data is not inverted. However, some protocols (e.g., IPARS) may be different, so the char menu provides bit order and bit sense selections. Hex setup menu entries are always entered in normal bit order and sense. For example, because the standard IPARS is inverted, syncs would be entered as <sup>3</sup> F <sup>3</sup> E even though they are <sup>0</sup> o <sup>2</sup> o.

**Hexadecimal Entry and Parity.** There are several fields in the Char Menu which let you make hex entries:

- sync on
- drop sync
- transparent text
- start on/stop on

When you make a hexadecimal entry in one of these fields, the parity bit is determined by hexadecimal entry, not the parity setup selection.

For example:

When even parity is used with ASCII 7, the sync characters should be  ${}^9_6{}^9_6$ , rather than  ${}^1_6{}^1_6$ . Of course, your line may still use  ${}^1_6{}^1_6$ , even though this would result in a parity for sync characters that is different from other characters.

For hexadecimal entries, the resulting parity bit conforms to the following rules:

- For data codes of 7 bits or less (e.g., ASCII 7, Baudot) the parity bit is not automatically changed to conform with the parity setup selection.
- For 8-bit data codes (e.g., ASCII 8, EBCDIC) the parity bit always conforms to parity setup selection.
- For 8-bit data codes with parity, the selected sync characters must be the same as the last 16 bits to enter the analyzer before non-sync data. For example, in EBCDIC the normal sync pattern is  ${}^3_2{}^3_2$ . With even parity, the binary pattern would be 100110010 100110010, or 18 bits. Only the last 16 bits are used as the sync pattern. Because least significant bits are sent first, the two bits in brackets are excluded from the sync pattern; 1001100[10] 100110010. Thus, you must enter  ${}^4_C{}^9_9$  for the analyzer to accept data. Of course, Auto Configure will find the correct sync characters if the line idles in FF.

**Sync Characters.** The Sync on selection determines what sync characters the analyzer looks for. Unless the sync pattern is correct, the HP 4957A will not capture data. The HP 4957A requires at least two sync characters (or one sync character in monosync setup) to capture data when monitoring and simulating.

When you do not know the sync characters **Sync on Idles** to capture line data even without the correct sync characters. Auto Configure will find the correct sync on characters. You will need to use Bit Shifting in the Examine Data menu to find the correct framing.

**COPs idle in FF**

The HP 4957A assumes that all character oriented protocols idle in FF. If your line uses some other condition, you must sync on that condition.

**Drop Sync Characters (Synchronous mode only).** The Drop sync entry determines where the analyzer drops sync and begins looking for sync characters. If the analyzer did not drop sync, it would bring in all activity on the line, including idles, and not resync properly.

For example:

**Drop sync 0 chrs after NONE**

Select seven characters on which to drop sync. The first character is the 'within text' character. The analyzer only looks for this character if you have chosen 'error checking.' Thus, if you Start on STX and Stop on ETX, the analyzer looks for the 'within text' character between STX and ETX.

To store all data, including idles, enter Drop sync 0 chrs after None. Then the analyzer never drops sync and brings in all line data, including idles.

**Drop Sync and Error Checking.** The Drop sync selection interacts with the Error check selection in the following ways:

- The first Drop sync character specifies 'within text.' The analyzer looks for this character between the 'Start on' and 'Stop on' error checking limits. When error checking is 'none', all text is outside, and the analyzer does not look for the first character (except IPARS).
- The first, or 'within text,' character takes precedence over the six 'outside text' characters. If the same character occurs both inside and outside the start on and stop on limits, the analyzer drops sync outside text.
- With error checking, the analyzer always drops sync after the BCC character(s) if it cannot find a 'within text' character. For example, if you select CRC-16 error checking, with 'Start on STX' and 'Stop on ETX', the analyzer drops sync after the two characters following ETX.

For example:

Drop sync 1 chrs after  $B_B F_F F_F F_F 5_D A_4 B_3$  causes the analyzer to drop sync one character after the first  $B_B$  character within the specified error checking limits. If the analyzer does not find the specified 'within text' character, it drops sync either one character after the BCC character(s) or one character after one of the six 'outside text' characters, whichever appears first. A Drop sync 0 after  $B_B F_F F_F F_F 5_D A_4 B_3$  causes the analyzer to drop sync immediately after the first  $B_B$  character within the specified error checking limits or 0 characters after one of the other characters.



---

## Capturing Unknown Data

If Auto Configure does not work:

- Try an 8-bit code, no parity, and no error checking.
- To monitor line data for study when you do not know the sync character, select **Sync on idles (F<sub>F</sub>) Drop sync 0 chrs after NONE**.

### **COPs idle in FF**

The HP 4957A assumes that all character oriented protocols idle in F<sub>F</sub>. If your line uses some other idle character, you must sync on that character.

- To store all data for study, including idles, enter **Drop sync 0 chrs after None**. The analyzer never drops sync and brings in all data, including idles.
- After making the above selections in the Char Menu, go to the Run menu and select **Monitor Line** to fill the buffer with data for study.
- Go to the Examine Data menu to view the data in buffer.

The buffer data will probably look meaningless because of incorrect character framing since the analyzer randomly framed the first character captured.

To make the data meaningful, go to the Examine Data Menu and select **Bit Shift** to see the data.

### **Bit shifting**

Bit shifting does not work when data is brought in Most Significant Bit (MSB) first or if any suppress functions are selected. The HP 4957A does not shift through the parity bit. Unless you use a code with no parity, you must use trial and error to find the correct framing.

If part of the data still does not become meaningful while bit shifting, change the data code to one without parity. When the data becomes meaningful, you can determine the correct sync characters. Change the **Sync on** selection to these characters.

## Eliminating Superfluous Data

When you have found the correct framing you can eliminate idles so the buffer will not fill with idles. To eliminate idles in 8 or 9-bit data codes, enter **Drop sync 0** chars after  $F_F F_F F_F F_F F_F F_F F_F$ . To eliminate idles in codes with frame sizes less than 8 bits, you must enter the correct number of 1's in any drop sync byte after the first byte (e.g.,  $7_F$  for a 7-bit code, or  $3_F$  for a 6-bit code). In other words, you must enter the correct character and frame size for the idle character.

**Table 9-4. Character Frame Sizes vs. Data Code**

<b>Data Code</b>	<b>No Parity</b>	<b>Even or Odd Parity</b>	<b>Ignore Parity</b>
Hex 5 Baudot	5 bits (no parity bit)	6 bits (including parity bit)	6 bits * (parity bit=0)
Hex 6 EBCD IPARS Transcode	6 bits (no parity bit)	7 bits (including parity bit)	7 bits * (parity bit=0)
Hex 7 ASCII 7	7 bits (no parity bit)	8 bits (including parity bit)	8 bits * (parity bit=0)
Hex 8 ASCII 8 EBCDIC	8 bits (no parity bit)	9 bits (including parity bit)	9 bits * (parity bit=odd)

(\* these settings are forced in Simulate)

## Unusual Protocol Settings

This is the build-your-own menu for Character oriented protocols. Select **Char** in the Setup menu. Use this table as reference, enter the settings given to the right of the protocol.

**Table 9-5. Unusual Protocol Settings**

Protocol	Code	Parity	ErrChk	Sync Char	Transparent Text Char	Mode
Burroughs BASIC	ASCII 7	odd	VRC	$1_6^1 6_6$	$d_1$	Sync Async 1
Burroughs Poll-Sel	ASCII 7	odd,SYNC even,ASYNC	LRC	$1_6^1 6_6$	None	Sync (or Async) Async1
HASP	EBCDIC	None	CRC-16	$3_2^3 2_2$	$d_1$	Sync
IPARS	IPARS	None	CRC-6	$3_F^3 E$	None	Sync Bit-sense invert Bit order-MSB first
MODE 4c	ASCII 7	odd	LRC	$1_6^1 6_6$	$d_1$	Sync
UNISCOPE	ASCII 7	odd,SYNC even,ASYNC	LRC	$1_6^1 6_6$	$d_1$	Sync Async 1
VIP7700	ASCII 7	odd,SYNC	LRC	$1_6^1 6_6$	$d_1$	Sync



————— Supplied Software

---

# Supplied Software

Five software applications are ROM-based and resident in the instrument:

- VT100 Terminal Emulator (see Chapter 6)
- Counter Math
- 56K Extended Async
- 64K Extended Async
- High Speed Data Capture w/option 001 (see Chapter 2)

**Cannot copy**

ROM-based applications cannot be copied from memory and stored to floppy disk.

The HP 4957A is supplied with software on two disks to help you make the most efficient use of the protocol analyzer.

The Utility Disk has three software applications:

- IPARS\_MEC
- DCE BERT
- X.25 Analysis and Filter

Also on the disk is demonstration data (filename DEMO\_DATA) that is used to help you learn the HP 4957A. This data is referenced in several examples and exercises in Part 1 of this manual.

The Datacommunications Test Library is also supplied on a disk. These tests can be used, edited to accommodate your needs, and reused to test and troubleshoot your line. The tests were developed to detect common problems you may encounter.

---

## Counter Math

Additional testing capabilities can be enabled in the Monitor and Simulate menus by loading the Counter Math application. This allows you to perform mathematical calculations on timers and counters. The calculations are:

- Add, subtract, multiply, or divide any two timers.
- Add, subtract, multiply, or divide any two counters.
- Add, subtract, multiply, or divide a timer by a counter.
- Add, subtract, multiply, or divide a counter by a timer.
- Use an 'if timer' command.

The calculations cannot exceed 65,535 and the results are always unsigned integers. To avoid fractions or real numbers, first multiply by 10 (or 100) to embed the fraction within the integer.

---

### To load the application:

1. From the top level menu, press **(MORE)** and **Load Appl.**
2. Press **(v)** and highlight CT\_Math. Press **Execute.**
3. Press **(EXIT)** to return to the top level menu.
4. Press **(MORE)** and **C&T Enbl.**
5. Press **Enable.**

The HP 4957A returns to the top level menu with the enhanced Monitor and Simulate menus adding the math function, softkey **Set Ctr.**

The Set Counter command allows two counters to be added, subtracted, multiplied, and divided. You can also set a counter to the value of a timer, or reset (set to 0).

Supplied Software  
**Counter Math**

When you press **Set Ctr** five rows of softkeys appear. Each row offers a softkey for resetting counters and a different mathematical function:

- Addition
- Subtraction
- Multiplication
- Division
- Equating

**Must be loaded**

Counter math must be loaded to use the extended functions. The HP 4957A reads all Counter math functions as Reset commands when the application is not loaded.

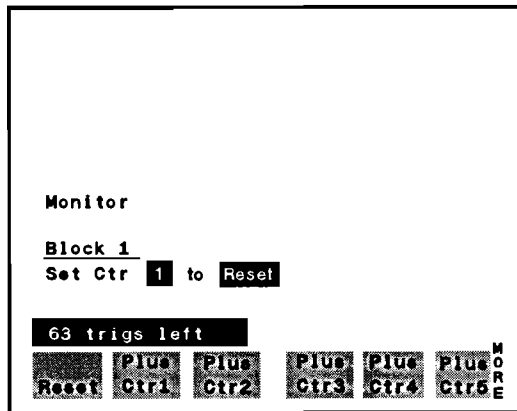

K10055

**Figure 10-1. Counter Math Program**

---

## To use Counter Math:

1. Load and enable the Counter math application.
2. Enter or load your Monitor or Simulate menu. The **Set Ctr** softkey appears in the menu.
3. Execute the program. Exit the Monitor or Simulate menu. From the top level menu, press **Run Menu** and press **Monitor Line**, **Monitor Buffer**, or **Simulate**.

For example:

Set Ctr [2] to [Reset]	$C2 = 0$
Set Ctr [1] to [=Tmr 1]	$C1 = T1$
Set Ctr [2] to [+Ctr 1]	$C2 = C2 + C1$
Set Ctr [3] to [=Tmr 2]	$C3 = T2$
Set Ctr [2] to [-Ctr 3]	$C2 = C2 - C3$
Set Ctr [4] to [Reset]	$C4 = 0$
Increment Counter [4] by [100]	$C4 = C4 + 100$
Set Ctr [2] to [*Ctr 4]	$C2 = C2 * C4$
Set Ctr [2] to [/Ctr 1]	$C2 = C2 / C1$

For example:

To use an 'If' timer:

Set Ctr 1 to [=Tmr 1]	<i>Set counter 1 to the value of timer 1</i>
If Counter 1 > x	<i>Tests timer 1 is greater than x msec</i>
then goto Block y	

For example:

To square a counter:

Set Ctr 1 to [\*Ctr 1]

Supplied Software  
**Counter Math**

For example:

An asynchronous file transfer between two DTEs is disconnecting in the middle of the transmission. The data streams are:

S	data	E	line idle	S	data	E
X		X		X		X

The theoretical delay between each of the data characters at 9600 bps is less than 2 msec. Probably, a longer delay is occurring causing the corrupt file transfer. The following program determines if the delay is greater than 5 msec.

```
Block 1
Reset Timer 1           Set timer 1 to 0 msec

When DCE S             Look for the beginning of string
  X
  then goto Block 2

Block 2
Start Timer 1          Begin timing measurement

When DCE E             Check for the end of the string
  X
  then goto Block 1

When DCE X             Look for the next character
  X
  then goto Block 3

Block 3
Set Ctr 1 to =Tmr 1
If Counter 1 > 5      Check if Counter 1 (Timer 1)
  then goto Block 5   exceeds 5 msec
```

Block 4  
Reset Timer 1  
Goto Block 2

*If timer value is not exceeded look  
at time for next character*

Block 5  
Highlight  
and then  
Beep  
and then

*Highlights exceeded thresholds*

*Beeps on exceeded thresholds*

Increment Counter 5 by 1  
and then  
Reset Timer 1  
and then  
Goto Block 2

*Counts exceeded thresholds*

Supplied Software  
**Counter Math**

For example:

In this example Counter 2 returns the average time for five RTS/CTS delays.

**Monitor**

**Block 1**

When Lead RTS goes On      *Look for lead going on*  
    then goto Block 2

**Block 2**

Highlight  
    and then

Beep

    and then

Start Timer 1              *Begin timing measurement*

    and then

Increment Counter 1 by 1    *Counts RTS/CTS transitions*

When Lead CTS goes On      *Look for CTS going on*  
    then goto Block 3

**Block 3**

Stop Timer 1

Highlight  
    and then

Beep

If Counter 1 > 4            *Test for 5 transitions*

    then goto Block 5

**Block 4**

Goto Block 1

**Block 5**

Set Ctr 2 to =Tmr1

Set Ctr 2 to /Ctr 1         *Divides total time*  
Stop Tests                  *by number of transitions*

Go to the Examine Data menu and look at Timer and Counter Summary.



---

## Using the IPARS Application

The IPARS application resides within the IPARS\_MEC application file, along with the Modified Error Check application. These two applications are loaded simultaneously, however, when one is active the other is not. If IPARS0 or IPARS1 is selected in the Setup menu, MEC is disabled. If some other Data Code is selected, then MEC is automatically enabled.

IPARS is a Character Oriented Protocol (COP). Load the IPARS application in the protocol analyzer (see Chapter 1). The top level menu will change.

Sync1 (S1 or <sup>3</sup>F Hex) characters are not captured. Triggering on the start of the message should only be made on the Sync2 (S2 or <sup>3</sup>E Hex) character.

### **IPARS Setup**

The IPARS0 and IPARS1 softkeys are always available in the Setup menu. The resident HP 4957A IPARS function can be selected and set up without the IPARS application loaded, but the results may be incorrect when monitoring or simulating.

## IPARS Setup Menu

Protocol	Char
Code	IPARS0 or IPARS1. The 0 or 1 refers to the idle state transmitted for normal bit sense. IPARS0 idles in 1's when transmitting if <b>Bit sense = Inverted</b> . IPARS1 idles in 0's if <b>Bit sense = Inverted</b> .
Bits/sec	Your bit rate
Parity	None
Transparent text char	None
Mode	Sync
Sync on	$^3F^3E$
Drop sync	Usually 0 after $^0_0^0_0^1_0^3_7^3F^3F^3F$ for IPARS0 or $^3F^0_0^1_0^3_7^3F^3F^3F$ for IPARS1. This field is used to specify conditions that will cause Drop sync and begin searching for sync.
Err chk	CRC 6
Start on $^3E^3E$	Each message begins with $^3F^3E$ . The HP 4957A needs two individual start characters, not a sequence. Both characters should be $^3E$ , last character of the only valid start sequence for IPARS.
Stop on $^0_D^1_D^2_D^3_D$	Specifies end-of-message characters. When one of these characters is detected, the HP 4957A stops accumulating CRC and expects the total CRC count. These four characters are individual stop characters, not a sequence DTE clock.
Suppress	User-defined
Bit sense	Usually set to Inverted.
Bit order	MSB sent first

---

## Modified Error Check (MEC)

### **MEC**

The Modified Error Check application is loaded when IPARS is loaded. However, if IPARS is active MEC is not active.

The Modified Error Check (MEC) application is useful when the Character Oriented Protocol selected (other than IPARS) being monitored has multiple 'Start on BCC' characters before data begins.

You can invoke MEC during a run when the data code is not IPARS0 or IPARS1 and both 'Start on BCC' characters are the same. The modified error calculation makes sure that CRC or LRC calculations begin only after the last 'Start on BCC' character is encountered. The normal technique for error checking begins calculating the error check after the first 'Start on BCC' character is encountered.

---

# DCE BERT

This application enables the HP 4957A to function as a DCE while running Bit Error Rate Tests. The standard instrument BERT only functions as a DTE. With this application loaded the HP 4957A emulates a DCE by transmitting and receiving PRBS patterns and appropriate clocks for asynchronous, synchronous, and isochronous links.

DCE BERT can be run in three modes:

- Asynchronous
- Synchronous
- Isochronous

**Asynchronous.**

---

DCE BERT Setup Menu

Mode:	ASync
Bits/sec	19200
Framing	None
PRBS Pattern :	511
Block Size :	1000
Test Duration :	5 MIN

SYNC ASync ISOC Print Test  
Scrn Relte

K0001

Figure 10-2. DCE BERT Asynchronous Setup Menu

---

## X.25 Analysis and Filter

The X.25 Analysis and Filter application provides the following capabilities:

- Filtering of timing and lead information
- Filtering LAPB Supervisory frames
- Filtering on X.25 LCN
- Filtering on X.25 called and calling addresses
- User-definable X.25 display formats
- LAPB modulo 128 support



---

### To set up the filter:

1. Load the X.25 Analysis and Filter application (see Chapter 1, To load an application:.) and press **EXIT** to return to the top level menu.

#### **Protocol Field**

To use the application, the Protocol field in the Setup Menu must be set to either 'X.25' or 'X.21 X.25', and the Extended Control field must be set to reflect whether the LAPB frames on your network are modulo 8 (Extended Control Off) or modulo 128 (Extended Control On).

2. Press **Run Menu** and **X.25 Filter** to access the X.25 Filter Setup Menu. If the **X.25 Filter** softkey is not present, check the Setup Menu Protocol field.

The Timing and Lead filter prevents all timestamps and lead status information from reaching the capture buffer. Cursor timing in Examine Data is not possible on data collected with this filter on.

The Supervisory Frame filter prevents all RR, RNR, and REJ frames from reaching the capture buffer; only Information and Unnumbered frames are collected.

The Logical Channel Number (LCN) filter permits only packets matching the specified LCN(s) to reach the capture buffer. The LCN value is a 12-bit binary value with 'Don't Care,' '1', or '0' allowed in any bit position. The term LCN in this application refers to the twelve bits that follow the General Format Identifier. These bits are sometimes referred to as the Logical Channel Group Number (first four bits) and the Logical Channel Number (remaining eight bits). For simplicity, the entire twelve bits will be referred to as the LCN.

If the Call filter is 'On', then the called/calling address conditions must be satisfied for a packet to be collected. The Call filter is always logically anded with the LCN filter. If the LCN filter is not satisfied it does not matter if the called/calling condition is true. If you just want a called/calling address filter, the LCN filter can be disabled by selecting all 'Don't Care' entries for its values.

The screenshot shows a terminal window titled "X.25 Filter Setup". The menu is as follows:

```
X.25 Filter Setup
-----
Timing & Leads Filter           On
Supervisory Frame Filter        On
Level 3 Filter                   On
LCN Value                       01XX10XX0011
Call Filter                       On
Called DTE Address
Length 17 12345678XX09876543
or
Called DTE Address
Length XX 11XX22XX33XX44XXX
0 1 Don't Care Print Screen
```

**Figure 10-5. X.25 Filter Setup Menu**

The Call filter waits for a Call Request/Incoming Call packet. When this packet arrives, the called and/or calling filter addresses are compared to the Address Block of the incoming packet. If the filter conditions are satisfied the LCN number for that packet is saved in an LCN table. From that point on, any packets with that LCN are collected. A DTE/DCE Clear Confirmation packet will remove an LCN value from the LCN table. Up to four LCN values can be maintained in the LCN table. If a Call Request/Incoming Call arrives and tries to put another LCN value in a full LCN table, the error message "LCN Overflow" is displayed. This does not affect the continued filtering and collection of other data.

If a 'Don't Care' value is specified for an address length, the filter automatically allows the maximum length entry of 17 values for the address. If the address length is less than 17 in the actual packet on the line, the additional address specification is then ignored. This application allows extended address lengths up to 17 values, as per the 1988 CCITT X.25 specification.

Packets with LCN values of 0 are always collected, whether they satisfy the filter or not. If a DTE/DCE Restart Confirmation packet is on the line then all values in the LCN table are cleared.

---

## To run the application:

- Press the **Monitor Line** to start filtering. The X.25 Analysis and Filter is a Monitor-Only application. Those packets which satisfy the conditions of the filter(s) are stored in the capture buffer and displayed. If selected, the information is also stored to disk.

---

## To define the display format:

1. Press **X.25 Disp** in the top level menu.
2. Select the X.25 display menu. Press a softkey, 1-5.

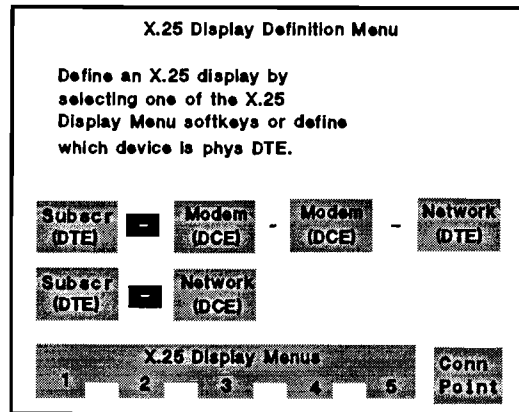

Figure 10-6. X.25 Display Definition Setup Menu



3. Select either a one or two column display format.

---

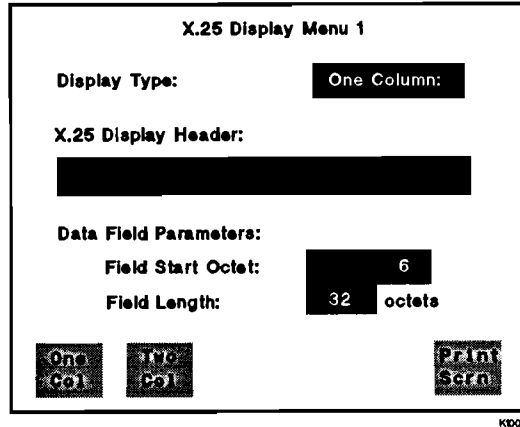

Figure 10-7. X.25 Display Column Selections

---

## To define header information:

Define the header information. Use the softkeys to assist you in making selections.

1. Define the Data Field Parameters. These parameters do not need to be set if data is not specified in the header.
2. Press **(EXIT)** to save the Display Definition menu and return to the top level menu.

**Display Type Field (Column Selection).** In one column format, information is displayed in normal video and network information is displayed in inverse video and can contain up to 32 characters per line. In two column format, information is displayed in the left half of the display and network information is displayed in the right half of the display and can contain up to 15 characters per line. When using the two column display, all fields entered appear in both left and right header blocks.

The screenshot shows a terminal window titled "X.25 Display Menu 1". It contains the following text and input fields:

- Display Type:** One Column:
- X.25 Display Header:** [Redacted]
- Data Field Parameters:**
  - Field Start Octet:** 6
  - Field Length:** 32 octets
- At the bottom, there are six softkey labels: **Addr.**, **FRAM Type**, **Na**, **Nr**, **Pr**, and **FCS**. To the right of these labels is a vertical label **MODE**.

K1007

**Figure 10-8. X.25 Header Selections**

Each field, i.e., Addr, Ns, P/F, data, etc., takes a certain amount of header space. For example: FType takes up five header spaces, Ns takes up three spaces, LCN takes up three spaces. With a space between each field, 14 spaces are used.

A field that ends after the header line will cause the error message **Field extends past header line**.

**X.25 Display Header Selection.** Fields are displayed in half bright video in the header block. Spaces between fields may be entered (use arrow key). Fields can not extend past end of line. You may overwrite a field by placing the cursor over that field and selecting another field.

The entire header can be cleared using the **Clear Header** softkey. The fields can be deleted by using the **Delete Field** softkey.

**Data Field Selection.** The **Field Start Octet** lets you define on which octet to start the data display (not counting the start flag). The **Field Length** field lets you specify how many octets (from the starting octet) you want to display.

**Header Field Descriptions.** Table 10-1 gives the abbreviation and amount of field space consumed in the header definition.

**Clear Headr.** The **Clear Header** softkey deletes the entire header field.

**Data.** You can define the Data field. The field can be any length (up to 32 characters in a one column display or 15 characters in a two column display) using the **Field Length** field. You must specify the Frame Start Octet where the field is to begin. The data field can be displayed in either the data code selected in the setup menu or in hex.

This field allows you to display as much of the data in a data packet as desired up to the limit. It is also possible to display decoded data and undecoded data at the same time.

For example:

Assume the data field has been set up to be 1 octet long and start at frame octet 5 (packet type identifier field), and the packet type has been selected to be displayed. The Data field decode will show the Packet Type Identifier in an undecoded format, and the Packet Type field will show the same information decoded to indicate the message type as a mnemonic.

**Table 10-1. Display Definition Header Selections**

<b>Field</b>	<b>Softkey Abbreviation</b>	<b>Display Abbreviation</b>	<b>Space Used</b>
D bit	D	D	1
Data	Data	d	1 to 32
Frame Address	Addr1	A	1
Frame Arrival Time	FrArrTime	FrTime	6
Frame Check Sequence	FCS	F	1
Frame Type	Frame Type	FType	5
LCN	LCN	LCN	3
Mod	Mod	Mod	3
M bit	M	M	1
N r	Nr	Nr	3
N s	Ns	Ns	3
Packet Type	Pack Type	Pk Type	9
Poll/Final	Pf	Pf	1
P r	Pr	Pr	3
P s	Ps	Ps	3
Q bit	Q	Q	1

**Del Field.** The **Delete Field** softkey will delete the cursor-highlighted field.

**D,M, and Q.** These fields are simply displayed as a 1 or a 0.

**FCS (F).** The FCS is displayed as 'G' for good, 'B' for bad and 'A' for abort. The 'B' and 'A' blink to indicate an error.

**Frame Address (Addr).** The frame address (A) is displayed as a hex character.

**Frame Arrival Time (FrArr Time).** The frame arrival time is displayed only during Examine Data. During run time it is left blank. The Frame Arrival Time is measured from the start of a data segment relative to the time between frames. It is measured in milliseconds.

**Frame Type (FType).** All frame types are decoded.

**Table 10-2.**

<b>Frame Type</b>	<b>Abbreviation</b>
Disconnect	DISC
Disconnected Mode	DM
Frame Reject	FRMR
Information	INFO
Receiver Not Ready	RNR
Receiver Ready	RR
Reject	REJ
Set Asynchronous Balanced Mode	SABM
Set Asynchronous Balanced Mode Extended	SABME
Unnumbered Acknowledgement	UA
Unnumbered Information	UI

**LCN.** LCN includes both the LCGN and the LCN as a hexadecimal number.

**Ns and Nr.** Ns (Send Sequence Number) Only I-Frames contain Ns. It uniquely identifies transmitted frames to ensure that they are received correctly (error free and sequentially).

Nr (Receive Sequence Number) All I-Frames and S-Frames contain Nr. Its value indicates the Ns number expected in the next I-frame. Nr indicates that the Layer 2 entity transmitting Nr has correctly received all I-Frames numbered up to and including Nr - 1.

Ns and Nr require three display spaces each, each displayed as a 3 digit decimal number regardless of extended control.

**P/F (Poll or Final bit).** All frames contain this bit. It is used as a poll (P) in common frames; and final (F) bit in response frames. P bits are set to one by the transmitting station. F bits are set to one to indicate that the response frame is being transmitted as a result of a poll.

The P/F bit is displayed as '1' if set and is left blank if not set.

**Ps and Pr.** Ps and Pr require three display spaces each whether the packet specifies mod8 or mod128. These values are displayed in decimal.

---

## Using Extended Asynchronous Baud Rates

The extended asynchronous baud rates, 56K and 64K bits per second, are supported as a special application which can be loaded from the Load Application menu (**Load Appl** softkey, filenames ASYNC\_56K and ASYNC\_64K) These applications are supplied with each HP 4957A protocol analyzer. These utilities extend the async capability beyond 38.4k bits/second.

You can monitor or simulate asynchronous data speeds of 56K or 64K bits per second. The HP 4957A retains its full capabilities for other data speeds when this application is loaded.

---

### To select the Extended Asynchronous Baud Rates:

1. Insert the Utility Disk in the disk drive, press **(MORE)** and **Load Appl**.
2. Press **(v)** until the application is highlighted. Press **Execute**.
3. From the application top level menu, press **Setup**.
4. Move the cursor to the Protocol field and press **Char**.
5. Move the cursor to the Mode field and press **Async**.
6. Move the cursor to the Bits/sec field. Select either **56000** or **64000** (whichever is available). The other data speeds are accessed by pressing **(MORE)**.

————— Softkey Reference

---

# Softkey Reference

This chapter explains all softkeys that are available in the HP 4957A. The first part of this chapter lists the menus and their functions. The second part of this chapter lists the softkeys alphabetically with the menu that they are located in listed in parentheses.



---

# Softkeys

This sections lists the menus and their functions.

---

## Softkey Menus in the Top Level

**Auto Config.** Tells the protocol analyzer to evaluate the line that is connected, and automatically set the line parameters in the Setup menu.

**Setup Menu.** Used to make all manual line parameter settings.

**Mon Menu.** Used to enter and develop monitor menus and programs.

**Sim Menu.** Used to enter and develop simulate menus and programs.

**Run Menu.** Used to start all Monitor programs, Simulate programs, BERT tests, and to turn Data Filters on and off.

**Examine Data Menu.** Used to view data that is in the buffer. In this menu you can view, measure, change display format, view timers and counters, and scroll through data that is in the capture buffer.

**Reset.** Reset menus (monitor or simulate programs) and reset applications that have been loaded. You must reset the application if you want to load a different application.

**BERT Menu (Bit Error Rate Test).** Used to define a BERT test.

**Remote&Print Menu.** Used to enter the Remote menu to define the controller and slave devices. Also used to define the printer interface and allow printing from the various menus.

**Mass Store Menu.** Used to load data from disk, store data to disk, select the active disk (RAM disk or floppy disk), and manage your disks.

**Load Appl (Load Application).** Used to select and load applications from floppy disk, RAM disk, or ROM.

**Self Test.** Internal diagnostic menu used to test the protocol analyzer, CRT, and keyboard.

---

## Embedded Softkeys

**Beep (Monitor and Simulate).** Available in the Monitor and Simulate menus. Audibly notifies you when the last preceding trigger is found.

**BERT (Run).** Starts the process of Bit Error Rate Tests that are defined in the BERT menu.

**Binary (Monitor and Simulate).** Allows you to input level 2 and level 3 strings in binary.

**Bit Shift (Examine Data).** Press the softkey and the entire data stream is shifted one bit per press of the softkey. If the displayed data is unrecognizable you may have to use this key to find the correct framing of unknown protocols. This softkey appears only in character oriented setups. When either Character or Bisync protocols are selected a field appears to suppress specific data, i.e., idles, nulls, control character, etc. When any of the suppress options are turned on, bit shifting is not available. Bit shifting is not available if bit order is MSB first.

**BSC (Setup).** Used to select the Bisync protocol.

**Capt Cont (High Speed Capture).** Selects continuous capture to the buffer when monitoring at 72 kbps or faster. This key is only available when the High Speed Capture application is loaded (option 001).

**Capt Full (High Speed Capture).** Selects capture until the buffer is full and then stop capturing data at 72 kbps or faster. This key is only available when the High Speed Capture application is loaded (option 001).

**Change Display (Examine Data).** Used to change the display format.

**Char (Setup).** Used to select a character oriented protocol.

**Control (Remote).** Used to select to the controller. After pressing this key you can set up the controller for a remote operation. Allows you to configure the protocol analyzer as a controller.

**Counter (Monitor and Simulate).** Softkey used to define the 'if' statement.

**CRT Tests (Self Test).** Utility that allows you to manually test the CRT with a series of tests.

**Data Fltr (High Speed Capture).** Allows you set filtering conditions in the High Speed Capture application. This key is only available when the High Speed Capture application is loaded (option 001).

**Data Filter (Run).** Accesses a menu with data filters used to filter lead changes or timing information.

**DCE.** Used to define the line that is to be monitored or simulated on.

**Delete (Monitor and Simulate).** Used to edit and develop a program and menu. You can delete program entries.

**Delete (Mass Store).** Pressing the **Delete** key and **Execute** key marks files for removal from the disk. The file is marked for deletion in the directory (a Del in the right most columns) but is actually not deleted until **Pack Disk** and **Execute** are pressed.

---

**CAUTION**

---

Undefined files cannot be restored or renamed after they have been deleted.

**Delete Application (Remote).** Deletes the current application in the slave's application memory.

**Delete Block (Monitor and Simulate).** Deletes a block when the cursor is at the beginning of a line.

**Delete Line (Monitor and Simulate).** Deletes a line when the cursor is at the beginning of a line.

**Delete Prg (Monitor and Simulate).** Deletes the entire monitor program when the cursor is at the beginning of a line.

**Directory (Mass Store).** The directory **Dir** operation lists the disk contents, giving File Name, File Type, and a Comment field. You can use the cursor keys to scroll through the files on the directory.

**Disc (Monitor and Simulate).** Used in conjunction with start and stop statements. Tells the analyzer what to start or stop.

**Disk Copy (Load Appl).** Internal utility that allows you to copy the contents of a 3 1/2 inch to another 3 1/2 inch disk.

**Display (Monitor and Simulate).** Used in conjunction with start and stop statements. Tells the analyzer what to start and stop.

## Softkeys

**Don't Care (Monitor and Simulate).** Used to develop a program and menu. Enters a 'don't care' condition in a trigger condition.

**Download Application (Remote).** Transmits the currently active application program from the controller's application memory to the slave. To execute the application on the slave, use **Run Appl.**

**Download Data (Remote).** Transmits test results from the controller buffer to the slave buffer.

**Download Menu (Remote).** Transmits the setup, monitor, simulate, and run menus to the slave.

**DTE (Monitor and Simulate).** Used to define the line to be monitored or simulated.

**Enable Keyboard (Remote).** After a 'lock keyboard' operation, this operation is necessary to restore the slave's keyboard to local control. This may be necessary if a menu, data, or application transfer is aborted by the controller.

**End Frame (Monitor and Simulate).** Used to enter the end frame condition in a level 2 string.

**Error (Monitor and Simulate).** Used to define a trigger condition. The analyzer will trigger on an error in the data stream.

**External (Run).** Selects the external interface and then must have an interface pod connected.

**Execute Run (Remote).** Executes the slave's run menu. The operation executed is the last operation that was run on the slave or the last operation set up on the slave.

**Format (Mass Store).** Pressing the **Format** key and **Execute** key initializes the disk, erases the disk directory, and places a new format on every track of the disk. Use this softkey to erase an entire disk and initialize new disks. The formatting process takes about 45 seconds.

The disks can be read by an HP series 200 computer but disks formatted in a series 200 cannot be written to during run-time on an HP 4957A.

**Gosub Block (Monitor and Simulate).** Causes a jump to a subroutine that ends in a 'return' statement. Without a 'return' statement 'Gosub Block' acts like a 'Goto Block' command.

**Goto Blk (Monitor and Simulate).** Causes an immediate unconditional branch to another block.

**HDLC (Setup).** Select the HDLC protocol.

**Help (High Speed Capture).** Selects the Help screen when in the High Speed Capture application. This key is only available when the High Speed Capture application is loaded.

**Hex/Text (Examine Data).** The **Hex** and **Text** softkeys toggle between the two. If the current display is in text (Text is default) the available softkey is **Hex**. Press **Text** to display the data in the code selected in the setup menu. Press **Hex** to display the data in hexadecimal. When one of the selections has been made, it will not change until the softkey is pressed again.

**Highlight (Monitor and Simulate).** Marks up to the last 63 trigger events in the buffer.

**High Speed Capture (Load Appl).** Only available on the HP 4958A, allows you to select capture rates that are faster than 64 Kbps, up to 256 Kbps.

**ID Slave (Remote).** The slave transmits its model number. This operation is often performed to test for an active link enabling remote communication.

**If (Monitor and Simulate).** An 'If Counter' causes a program branch according to the condition of a counter. An 'If Lead' causes a branch according to the condition of a lead at the time of the last trigger. If the statement is true the program will jump to a specified block. If the statement is false the program goes to the next block.

**Inc Ctr (Monitor and Simulate).** 'Increment Counter' uses one of the five counters to count events and select an increment value.

**Insert (Monitor and Simulate).** Used to edit and develop a program and menu. You can insert characters in a data stream.

**Insert Block (Monitor and Simulate).** Inserts a new block when the cursor is at the beginning of a line.

**Insert Line (Monitor and Simulate).** Inserts a new line when the cursor is at the beginning of a line.

**Internal (Run).** Selects the internal interface selections, RS232C, RS449, or V.35.

**Inverted (Setup).** Select inverted bit sense.

## Softkeys

**Keyboard Test (Self Test).** Allows you to test each key on the keyboard with an interactive test.

**Lead (Monitor and Simulate).** Used in conjunction with the 'if' statement to define a trigger condition.

**Level 2 (Monitor and Simulate).** Used to enter a level 2 when string for defining level 2 trigger conditions.

**Level 3 (Monitor and Simulate).** Used to enter a level 3 when and send string for defining a level 3 trigger condition.

**Load (Mass Store).** Pressing the **Load** key and key and **Execute** key effects a read-from-disk and write-to-buffer action. When the disk drive is being accessed the yellow indicator light is on.

File names may be entered from the keyboard or by moving the cursor to the file name before pressing the **Load** softkey.

**Lock Keyboard (Remote).** The slave's keyboard becomes inoperable. This is necessary before executing most operations, excepting 'slave status', 'identify slave', and 'reset slave'. Lock keyboard is performed automatically on HP 4957As operating as a slave.

**Loop (Self Test).** Allows you to manually test the internal circuitry with a loop diagnostic check. This is the same test that is run at power-up.

**Mass Store (Top Level).** Accesses the Mass Store function.

**Message (Monitor and Simulate).** Used for entering comments in a program.

**Mon Buff (High Speed Capture).** Allows you to monitor the buffer when the High Speed Capture application is loaded. This key is only available when High Speed capture is loaded.

**Monitor Buffer (Run).** The protocol analyzer will immediately begin monitoring the buffer (if there is data) when this key is pressed.

**Monitor Line (Run).** The protocol analyzer will immediately begin monitoring the line and filling the buffer when this key is pressed.

**Mon Menu (Top Level).** Selects the Monitor menu.

**Move Crsr (Monitor and Simulate).** Allows the cursor to be positioned at the start of a block.

**MSD = RAM (Mass Store).** The **MSD=RAM** and **MSD=Disk** alternate as the softkey label. Selects the mass store device, either the microflop disk or the 128 Kbyte RAM disk. When the selected mass store device is the RAM disk, the **MSD=Disk** softkey is available.

**Next Hilit (Examine Data).** The **Highlight** softkey in the monitor or simulate menus lets you mark trigger events. The **Next Hilit** softkey lets you move to the next highlighted events. You may have to press **next segment** in frame and packet displays to get to the remaining highlights.

Highlights are not retained when data is stored to disk.

**Next Page and Prev Page (Examine Data).** The **Next Page** and **Prev Page** softkeys move from one screen-full of data to the next immediate screen, either previous or successive. A page is one full screen of information.

**Next Segment and Prev Segment (Examine Data).** The **Next Segment** and **Prev Segment** softkeys appear when you have loaded a data file from disk that is too large to be entirely contained in the buffer. With this feature you can examine the disk like the buffer. These softkeys load either the next or the previous 16 Kbytes of data from disk into the buffer for examination.

**Normal (Setup).** Selects normal (uninverted) bit sense.

**Not (Monitor and Simulate).** Used to enter the 'not' condition of a trigger statement.

**Pack Disk (Mass Store).** Pressing the **Pack Disk** softkey and then **Execute** rearranges the files on the disk to accommodate lost space due to deleted files or when run-time files are created. This process allows you to regain disk space and use the disk more efficiently.

Once the pack disk operation has been completed there is no way to recover purged files.

**Print All (Remote).** Allows you to print the configuration and data.

**Print Directory.** Pressing the **Print Dir** and **Execute** softkeys allow you to print the directory if an ASCII printer is connected.

## Softkeys

**Print Screen (Setup and BERT).** You can print the entire in either menu with an ASCII printer connected.

**Print Setup (Remote).** You can print the print the slave, controller, or print setup menus.

**Print Prog (Monitor and Simulate).** Prints the program if an ASCII printer is connected.

**Print Setup (Remote).** Allows you to print the setup configuration.

**Print Summary and Data (Examine Data).** If you have an ASCII printer connected, you can print either the data display or the setup summary by pressing the **Print Sum.** or **Print Data** softkeys.

**Recover (Mass Store).** Pressing the **Recover** and **Execute** softkeys allows files marked for removal from the disk to be 'restored' as active files in the directory. Only files created on an HP 4951C/4952A/4953A/4954A/4957A may be recovered.

**Remote&Print (Top Level).** Accesses the Remote function and the Print setup function.

**Rename (Mass Store).** Pressing the **Rename** and **Execute** softkeys allow you to rename a file or change the comment associated with a file. Undefined files cannot be renamed.

**Reset (Monitor and Simulate).** Resets and stops a specified Timer or Counter.

**Reset Application (Reset).** Resets the Application memory to default and delete any loaded applications. This must be done if you want to load another application.

**Reset Menus (Reset).** Resets the Monitor and Simulate programs.

**Reset Slave (Remote).** Stops slave execution and resets the slave to its top level menu.

**Return (Monitor and Simulate).** A command that terminates a subroutine and returns the program to the command immediately following the 'Gosub Block' statement.

**Roll Up and Roll Down (Examine Data).** Press **Roll Up** or **Roll Down** to move the displayed data up or down one line at a time. You can view up to 32 Kbytes, the current contents of the display buffer.



**Run Application (Remote).** Loads the application that is currently resident in the slave into application memory. Use **Execute Run** to execute the application.

**SDLC (Setup).** Select the SDLC protocol.

**Self Test (Top Level).** Allows you to run internal diagnostics for CRT, keyboard, and Loop tests.

**Send (Simulate).** Tells the analyzer to send characters. You can enter the characters in text, hexadecimal, or binary. Level 2 or 3 assisted mode makes entry of frame and packet headers available.

**Sel Ifac (High Speed Capture).** Allows you to change the active interface when High Speed Capture is loaded.

**Select Iface (Run).** Accesses softkey selections for Internal or External interfaces.

**Set Lead (Monitor and Simulate).** Sets interface leads on or off.

**Setup (Top Level).** Allows you to enter the Setup menu.

**Simulate (Run).** The protocol analyzer will immediately begin running the active simulate program.

**Slave (Remote).** Allows you to configure the protocol analyzer as a slave.

**Slave Status (Remote).** Tells the slave to transmit its current menu and error status to the controller.

**Softkey (Monitor and Simulate).** Defines the trigger condition to be one of three softkey entries. You must press the softkey to satisfy the trigger condition.

**Specify Block (Examine Data).** The **Spec. Block** softkey lets you specify a particular 2 Kbyte block. The block number indicates the first character's position in the buffer. Some buffer information, like time marks, is not displayed, so **Next Page** may cause the block number to jump by several numbers. Buffer data loaded from disk may have block numbers as high as 384.

**Start (Monitor and Simulate).** The start softkey is available to start the Display, Disk, Timer. 'Start' and 'Stop' commands should be tied to the start of execution or the last preceding trigger.

## Softkeys

**Start Flag (Monitor and Simulate).** Enters the start flag in a level 2 string defining a trigger condition.

**Start Time and End Time (Examine Data).** The **Start Time** and **End Time** softkeys are used for cursor timing. To find the time interval between two events in the buffer, move the cursor to the first event and press **Start Time**. Move the cursor to the second event and press **End Time**. The time between the two events is displayed at the top of the screen border.

**Stop (Monitor and Simulate).** The **Stop** softkey is available to stop the Display, Disk, Timer and Tests. 'Start' and 'Stop' commands should be tied to the start of execution or the last preceding trigger.

**Store (Mass Store).** Pressing the **Store** key and then **Execute** causes a read-from-RAM write-to-disk action. When the disk drive is being accessed the yellow indicator light is on.

File names may be entered from the keyboard or by moving the cursor to a file in the directory before pressing **Store** and then modifying the name. File type must be specified. An optional comment field is provided to aid identification of the file.

**Tests (Monitor and Simulate).** Used in conjunction with the start and stop statements. Tells the analyzer to act upon the tests being run.

**Test Results (BERT).** Allows you view the BERT test results while the test is still being run.

**Timer (Monitor and Simulate).** Used in conjunction with the start and stop statements. Tells the analyzer to act upon the defined timer.

**Timer and Cntr (Examine Data).** With the **Timer&Cntr** softkey you can look at a summary of the setup parameters, as well as the status of the timers and counters at the end of the previous run.

**Timer and Counter (Remote).** The slave transmits the status of its timers and counters. This is an upload function only.

**Upload Application (Remote).** The current application program is transmitted from the slave's application memory and executes it on the controller.

**Upload Data (Remote).** Receives buffer data from the slave. You must specify the correct block limits in the slave.

**VT100 (Load Appl).** Allows you to use the protocol analyzer as a terminal.

**Wait (Simulate).** 'Wait' statements are used to delay 'Send' or 'Set Lead' commands by a specified number of milliseconds.

**When Trig (Monitor and Simulate).** Only statement that defines a trigger event. The analyzer can look for any event and then branch to a designated action. Program execution stops and waits until at least one 'When Trig' condition is satisfied. Triggers are the only way to provide a reference point in the data stream.

**X21 BSC (Setup).** Allows you to select X.21 BSC circuit-switched or leased-line operation.

**X21 Char (Setup).** Allows you to select X.21 Character circuit-switched or leased-line operation.

**X21 HDLC (Setup).** Allows you to select X.21 HDLC circuit-switched or leased-line operation.

**X21 SDLC (Setup).** Allows you to select X.21 SDLC circuit-switched or leased-line operation.

**X21 X.25 (Setup).** Allows you to select X.21 X.25 circuit-switched or leased-line operation.

**X.25 (Setup).** Allows you to select the X.25 protocol.



Softkey Reference  
**Softkeys**



— Specifications and  
Accessories

---

## Specifications and Accessories

This chapter outlines the specifications, performance that is guaranteed by Hewlett-Packard. Characteristics are performances that have been determined to be typical. Product enhancements, options, and other accessories that are available are also listed.

---

## Specifications

This section lists performance requirements that are guaranteed by Hewlett-Packard.

---

### Physical Size

**Weight.** Net Weight: 5.8 kg. (12.8 lbs.) Shipping Weight: 10.3 kg. (22.7 lbs.)

**Dimensions.** 16.0 x 27.9 x 34.3 cm. (6.3 x 11.0 x 13.5 in.)

**Operating Temperature.** 0° C to +55° C (+32° F to +131° F) \*\*

**Storage Temperature.** -40° C to +70° C (-40° F to +158° F)

\*\* The disk drive and memory should only be operated at temperatures of +5° C to +40° C (+41° F to +104° F) and stored at +4° C to +53° C (+39° F to +127° F).

---

### Electrical Requirements

**Power Requirements.** 100 to 240 VAC  $\pm$  10%: 48 to 64 Hz single phase, typically 18 watts with a maximum <30 watts.

**Electromagnetic Capability.** Complies with VDE 0871/6.78 Limit B, and is licensed per FTZ 1046/84 (effective January, 1992: EN 55011).

---

# Operating Characteristics

Operating characteristics are features and capabilities that the protocol analyzer exhibits. They are not specifications.

---

## Protocols

X.25, SNA (opt.), SDLC, BSC, HDLC, IPARS, X.21 (opt), DDCMP (opt), CCS#7 (opt), Frame Relay (opt), ISDN Basic and Primary rate (Q.921 and Q.931), and most character asynchronous or synchronous protocols.

---

## Data Transmission Modes

Synchronous, asynchronous, and synchronous NRZI.

---

## Data Transfer Rates (bps)

50, 75, 110, 134.5, 150, 200, 300, 600, 1200, 1800, 2000, 2400, 3200, 3600, 4800, 7200, 9600, 12000, 14400, 16000, 19200, 38400, 48000, 56000, 64000 and external for synchronous data lines up to 64000.

Line utilization supported at any data rate may vary depending on protocol and complexity of triggers.

Not Supported:

Asynchronous (bps): 16000, 48000



### **High Speed Data Capture Rates (with option 001).**

Internal clock speeds for 8-bit async and bit-oriented protocols (NRZI): 72000, 76800, 100000, 112000, 128000, 133000, 146000, 168000, 187500, 192000, 224000, 230400, 256000 and EXTERNAL up to 256000.

Internal clock accuracy -  $\pm 0.005\%$  for all speeds.

---

### **Data Codes**

ASCII, EBCDIC, Baudot, Six Bit Transcode (SBT), IPARS, EBCD, and Hex.

---

### **Capture Memory (Circular)**

To store data, timing, and lead status (circular)

768 Kbytes volatile

32 Kbytes nonvolatile RAM

---

### **Mass Storage**

Microfloppy disk stores 613 Kbytes of data, timing information, setups, and menu programs (fill and stop capturing)

RAM disk stores 128 Kbytes

## Lead Status

The status of five control leads are stored for each interface. They are RTS, CTS, DTR, DSR, and CD for RS-232C/V.24 and V.35 interfaces; CS, RS, RR, TR, and DM for RS-449 interface; T, R, I, and C for X.21 interface.

**LED Lead Indicator Pin Assignments.** For internal interfaces.

RS-232	RS-449	V.35
DTE (2)	SC (4/22)	SD (P/S)
DCE (3)	RD (6/24)	RD (R/T)
TC (15)	ST (5/23)	SCT (Y/AA)
RC (17)	RT (8/26)	SCR (V/X)
RTS (4)	RS (7/25)	RS (C)
CTS (5)	CS (9/27)	CS (D)
DTR (20)	TR (12/30)	DTR (H)
DSR (6)	DM (11/29)	DSR (E)
CD (2)	RR (13/31)	RLSD (F)
ETC (24)	TT (17/35)	SCE (U/W)

**Breakout Panel.** Full 25 pin matrix.

Test pin MARK threshold	-	-3V
Test pin SPACE threshold	-	+3V
Source voltage	-	± 12V

**RS-232.** Red LEDs = -3V.

Receive:	MARK	- > 2.0V
	SPACE	- < 1.0V
Transmit:	± 9V into 3KΩ	

**RS-449. Red LEDs - -3V.**

Receive:	MARK	-0.2V
	SPACE	-0.2V
Transmit:	$\geq 2.0V$ into 100	
	$\geq 5.0V$ into an open circuit	

**V.35. Red LEDs - -3V.**

Receive:	MARK	- 0.2V
	SPACE	- 0.2V
Transmit:	$\geq 0.475V$ to $0.625V$ into $100 \Omega$	
Output impedance	= $100 \Omega \pm 50 \Omega$	

---

**VT100**

For terminal emulation application only; 80 characters by 24 lines on display.

## Triggers

63 triggers for characters, errors, timeouts, interface lead transitions, and softkeys.

**Timers.** Five, each with a maximum count of 65535 msec. Resolution 1 msec. Cursor timing for measurements from 6 to 66 seconds, depending on data rate.

**Counters.** Five, maximum count 65535.

**Highlights.** Most recent 63 trigger events.

**Send Strings.** Up to 251 characters per string maximum, 1743 characters total (not including error checking or flags).

---

## Setups

**Character Framing.** 5, 6, 7, or 8 information bits, plus parity. For asynchronous systems select 1, 1.5, or 2 stop bits per character.

**Error Checking.** CRC-CCITT, CRC-CCITT preset 0, CRC-16, CRC-12, CRC-6, LRC, and parity.

**Parity.** Odd, even, none, ignore.

**Display Formats.**

- DTE data over DCE data (two line)
  - Data and Lead Status
  - DTE data only
  - DCE data only
  - X.21 data and state
  - Frame decode
  - Partial packet decode
-

---

## Physical Instrument

**Keyboard.** Full ASCII keyboard with six softkeys and cursor control.

**Display.** High resolution 13 cm (5 in) diagonal with 16 lines and 32 characters per line.

**Interfaces.** These interfaces are available:

### Internal

RS-232/V.24 with full 25 pin break-out  
RS-449  
V.35

### External

ISDN BRI  
ISDN PRI T1  
ISDN PRI CEPT  
MIL-188C

---

## Remote Capability

Remotely controlled by another HP protocol analyzer or a PC to transfer data, setups, and applications. Unattended remote control (command-mode or virtual-mode).

- **Command mode:** remotely controlled by another HP 495X protocol analyzer or a PC to transfer data from 768 kbyte buffer, menu setups, and applications. Remote BERT is possible between an HP 4957A and an HP 4952A.
- **Virtual mode:** Remotely controlled by a PC. All functions possible locally can be executed remotely. PC display is identical to the protocol analyzer display, with an update rate approximately once/second (depending upon the bandwidth of the interconnecting link).

---

## Bit Error Rate Testing

Simultaneously measures bit errors, block errors, errored seconds, and percent error free seconds for synchronous, asynchronous or isochronous data links.

**Block Size.** 511, 1000, 2047.

**Patterns.** 63, 511, 2047 or 4095 pseudo random sequence.

**Character Framing.** None, 5,6,7, or 8 bit per character and parity.

**Inject Errors Function.** Single errors or burst of ten errors.

---

## Accessories

The HP 4957A is equipped standard with the following:

- Power Cord
- RS-232C (V.24) Y-cable
- RS-449 Y-cable
- V.35 Y-cable
- Protective Front Panel Cover
- Jumper wires for the RS-232C (V.24 breakout box)
- Operating and Reference Manual
- Datacommunications Test Library
- Utility Disk
- Transportation Disk
- Interface cable for external pods

---

## Options and other Accessories

option W30	36 month service contract (24 month extension beyond the standard 12 month warranty)
option 001	Hi-speed performance data capture
option 003	Katakana character set
option 101	(delete) RS-449 Interface cable
option 104	HP 18294A X.21 Interface pod
option 105	(delete) V.35 Interface cable
option 108	HP 18280A S/T BRI Monitor pod (optional HP 18268A)
option 109	HP 18281A S/T BRI Monitor/Simulate pod and software
option 110	HP 18282A S/T PRI (T1) Monitor/Simulate pod and software
option 111	HP 18283A S/T PRI (CEPT, 3-pin) Monitor/Simulate pod
option 112	HP 18284A S/T PRI (CEPT, BNC) Monitor/Simulate pod
option 113	HP 18285A U interface BRI Monitor pod (AMI)
option 114	HP 18286A U interface BRI Monitor pod (2B1Q)
option 115	HP 18282T T1 Interface pod and software
option HO5	V.35 Y-cable (France only)

Specifications and Accessories

**Accessories**





---

Error and Status Messages

---

# Error and Status Messages

The HP 4957A displays messages that alert you to what it is currently executing. If the execution cannot be done due to complications, incomplete commands, or simply not understanding the command it will display the reason for not completing the command.

---

## Error Messages

This chapter explains what error messages mean and how to correct them.

---

### Application Denied

**Cause.** Occurs when an attempt is made to load or rename an illegal application. This might be an application copied on another device other than another HP 4957A.

**Action.** Check the application and ensure that it is correct.

---

### Application Not Compatible

**Cause.** Occurs when an attempt is made to store an application that is not compatible.

**Action.** Check application to ensure it is not copy protected.

---

### Bad Data - Cannot Sync

**Cause.** Indicates incoming data does not match selected pattern.

**Action.** Check for line errors, wrong speed selected, or wrong pattern selected.

## Bad Disk

**Cause.** The disk will not format because of too many bad tracks.

**Action.** A disk having one or more bad tracks is unusable.

---

## Buffer Empty

**Cause.** Slave buffer is empty.

**Action.** Verify contents of the slave buffer with examine data. Retry to upload.

---

## Buffer Overflow

**Cause.** Not processing data as fast as it comes in. Caused by disk or monitor program which have triggers found too often.

**Action.** Decrease number of triggers in setup.

---

## Can't Configure Within the Time Limit

**Cause.** For synchronous protocols the time limit is 15 seconds; NRZI or asynchronous protocols the limit is 45 seconds.

**Action.** After the time limit, Auto Configure resets and starts over.

---

---

## Checksum Error

**Cause.** Bit errors have occurred. A bad CRC check occurred when attempting to read or write a file on the disk. Data is assumed to be corrupt when this error occurs.

**Action.** Retry the operation. Disk may no longer be usable. Try another disk to help isolate the problem.

---

## Clock Slipped During Run

**Cause.** Corrupt data received. Part of the bit stream was lost.

**Action.** Either BERT detected error indicating bad line or the line is configured wrong.

---

## Controller Error

**Cause.** The disk controller is not working properly.

**Action.** Run disk self test to verify disk controller error.

---

## Conversion Error Menus Reset

**Cause.** Occur if the menus being transferred are invalid on the destination analyzer.

**Action.** Check menu compatibility. Retry menu transfer.

**Error Messages**

---

## Data Error - Sync Lost

**Cause.** Indicates that sync was lost after start of test.

**Action.** Check either line going bad, or if tester was changed on the other end of line.

---

## Directory too Large

**Cause.** Disk has a directory too large. Directory has ten sectors for 80 entries.

**Action.** Reduce the number of files.

---

## Directory Full

**Cause.** Disk directory is full and no other files can be written. The directory can contain eighty files.

**Action.** Reduce the number of file names.

---

---

## Disk Full

**Cause.** Disk is full of data and no more will fit. This error occurs during write operations.

**Action.** Pack the disk using the **Pack Disk** softkey to make enough space for the new file.

---

## Disk Not Formatted

**Cause.** The disk has not been formatted.

**Action.** Format the disk.

---

## Disk Out

**Cause.** Disk is out at the beginning of a disk operation, or the disk is taken out during a disk operation.

**Action.** Make sure a disk is installed in the drive. Press **Dir** .

---

## Disk Removed During a Read Operation

**Cause.** Disk was removed during a load operation; the buffer data is invalid.

**Action.** Reload data.

**Error Messages**

---

## Disk Read Error Buffer Data Invalid

**Cause.** Caused by checksum error, record not found, corrupt file, broken disk controller, or a worn out disk.

**Action.** Try another disk to help isolate the problem.

---

## DLC Error

**Cause.** HP 4957A hardware problem.

**Action.** Contact HP for service.

---

## Drive Error

**Cause.** Disk drive is not working or a hardware failure has occurred.

**Action.** Run disk self test to verify disk controller error.

---

## End of Data Segment

**Cause.** End of the current 16 blocks (32 Kbytes) of data.

**Action.** Use next data segment key.



---

## End of Disk File

**Cause.** Specified block number beyond the last block on disk.

**Action.** Change the block number to one on the disk.

---

## End of Valid Data

**Cause.** Scrolled to the end of buffer data.

**Action.** Scroll backward.

---

## EOF error

**Cause.** An attempt was made to read more records than exist in the file. The End Of File was found before the read completed.

**Action.** Retry, if it fails again - retry on a different disk. If the error persists, suspect a disk controller failure.

---

## File Already Exists

**Cause.** A file with name and type already exists.

**Action.** Recheck the name and/or type to ensure they are different from existing files.

## File Does Not Exist

**Cause.** Try to load a file that does not exist or has been deleted.

**Action.** Recheck the directory for the file name or use the **Recover** function of mass store menu to try to replace the file into the directory so that it may be accessed.

---

## File Not Compatible

**Cause.** File is not compatible with the HP 4957A. This file could have the correct type but might be an application not compatible.

**Action.** Recheck the file and ensure it's compatibility.

---

## File is Not Recoverable

**Cause.** File is not recoverable. Probably a file created on an instrument other than an HP 4957A type.

**Action.** Recheck file and compatibility to the HP 4957A.

---

---

## Framing Error

**Cause.** Could not find a '1' stop bit in an asynchronous protocol during autoconfigure. Error may occur because a transmit clock (TC or ETC) is missing in a synchronous protocol. The HP 4957A assumes an asynchronous protocol, but cannot then find the stop bit.

**Action.** Check transmit clock indicators on the pod. Check protocol setup. Retry the transmission.

---

## Handshake Error

**Cause.** Proper handshake responses were not present during printer operation.

**Action.** Check handshake line for correct responses. Press EXIT to return to the printer menu.

---

## Improper Format

**Cause.** The disk format is not compatible with the HP 4957A for run-time use. The disk format is LIF but not formatted on a compatible disk drive.

**Action.** Format the disk in an HP 4957A, HP 4952A, HP 4951C, HP 4954A.

## Insufficient Data to Configure

**Cause.** The analyzer cannot detect a clock or idles.

**Action.** Check the data stream. Go to the setup menu and check for non-standard protocols or data codes.

---

## Invalid asynchronous speed / Invalid synchronous speed

**Cause.** The bit rate is not within 5% of specification.

---

## Invalid Async Framing

**Cause.** The analyzer cannot determine the async data code.

**Action.** Check for a non-standard data code.

---

## Invalid File Name

**Cause.** Attempt to enter an invalid file name.

**Action.** Correct the file name. Allowable characters are A - Z, numbers, and the underscore character. The file name must start with a capital alpha-numeric character.

---

---

## Invalid File Type

**Cause.** Attempt to load or store a file type that is not valid on an HP 4957A.

**Action.** Correct the file type to match with a compatible file type on the HP 4957A.

---

## Invalid Mon/Sim menu

**Cause.** Occurs if you enter 'When DTE/DCE' without completing the trigger branching instruction or if there are incomplete program statements.

**Action.** Examine monitor/simulate menu for incorrect parameter. Correct the error and retry

---

## Invalid Sync Characters

**Cause.** Could not find any of the standard sync characters (ASCII =  $^1_6^1_6$ ; EBCDIC =  $^3_2^3_2$ ; IPARS =  $^3_F^3_E$ ).

**Action.** Try syncing on different characters. Auto Configure syncs on a selected set of sync characters. The data stream does not contain one of these sync characters.

## Issue ID Request to Enable Slave

**Cause.** Failure to issue ID request to enable an HP 4951 slave.

**Action.** Always execute this operation immediately after establishing phone communication to synchronize remote transfers. Required by the HP 4951A as a slave.

---

## Max Length

**Cause.** Appears if you attempt to specify more than 255 characters in a single string.

**Action.** Reduce the number of characters in the string.

---

## Max Strings

**Cause.** The Monitor and Simulate Menus combined contain strings which have a total of more than 2750 characters.

**Action.** Reduce the number of characters in the string.

---

## Media Wear Protected

**Cause.** Disk has become write protected because of excess wear.

**Action.** Copy to a new disk as soon as possible.

---

---

## Menu Full

**Cause.** Monitor and Simulate Menus combined contain more than 143 steps.

**Action.** Reduce the number of steps.

---

## Menus Incompatible with HP 4957A

**Cause.** Occur for certain menus created by a HP 4955A or HP 4953A.

**Action.** Modify the existing menu to run on the HP 4957A. Examine the menu for any illegal parameters, correct and retry.

---

## Must Reset Slave First

**Cause.** Slave must be reset.

**Action.** Press **Reset Slav** before continuing.

---

## Must Reset Slave to Top Level

**Cause.** Slave must be in the Top Level menu to continue operation.

**Action.** Reset slave.

## **New Name Already Exists**

**Cause.** File with a name and type already exists.

**Action.** Recheck the name and/or type to ensure either the name or the type is different from existing files.

---

## **No Application Loaded**

**Cause.** Attempt to store an application when no application was loaded in RAM.

**Action.** Load the application desired into the HP 4957A before trying to store it.

---

## **No Data in Buffer—Use EXIT Key to Exit**

**Cause.** Buffer is empty.

**Action.** Monitor On-Line, or load from the disk to fill the buffer.

---

## **No Data in Capture Buffer**

**Cause.** Buffer is empty when you try to store a Menus & Data file or a data file.

**Action.** Monitor On-Line, or load from the disk to fill the buffer.

---



---

## No Data Present

**Cause.** No line data.

**Action.** Both data and idle conditions must be present.

---

## No displayable data in buffer for the selected display format

**Cause.** Buffer contains non-displayable data, such as lead transitions, or if in the Packet display there are no packets.

**Action.** Use Data & State display format to see the lead transitions, and all other data, if any.

---

## No File; Run Aborted

**Cause.** The menu requesting the run-time disk data file was exited before being executed.

**Action.** None - Run-time disk data file was exited before being executed.

**Error Messages**

---

## No Idles

**Cause.** Insufficient idles on the line.

**Action.** Data and idles must be present. Asynchronous protocols must have at least two idle characters between messages.

---

## No More Highlights

**Cause.** When you press the **Next Hilit** key and there are no more highlights.

**Action.** View highlights again by returning to start of buffer (use **Spec Block** ) and then **Next Hilit** . For frame packet displays, try **Next Segment** then **Next Hilit** .

---

## Non LIF Format

**Cause.** The disk has been formatted, but the format is not the LIF format used by the HP 4957A.

**Action.** Format the disk on a HP 4957A.

---

---

## Nonstandard Baud Rate

**Cause.** The bit rate is not within 5% of the selected value.

**Action.** Adjust bit rate of IUT.

---

## No Pod Attached

**Cause.** An external interface has been selected and no pod is attached or the connection has come loose.

**Action.** Be sure to turn off the power before connecting the interface pod.

---

## No Sync Characters

**Cause.** Could not find any sync characters.

**Action.** Try to sync on idles to capture all the data on the line and then check the data with examine data menu for the presence of sync characters.

---

## Operation Not Valid for HP 4957A

**Cause.** Remote operation is one that only an HP 4955A or HP 4953A can perform.

**Action.** Amend operation to comply with HP 4957A capabilities.

**Error Messages**

---

## Printer Error

**Cause.** Other printer problems.

**Action.** Verify connections and printer setup. Press EXIT to return to the printer menu.

---

## Receiver Overrun

**Cause.** Line data too fast.

**Action.** Check configuration of line. May be noise on data or clock.

---

## Record Not Found

**Cause.** A track or sector was not found during a disk operation indicating a corrupt format or a worn disk.

**Action.** Retry the read or write operation.

---

## Remote Timeout

**Cause.** Print operation timed out.

**Action.** If persistent, contact your HP Sales/Service Office. Press EXIT to return to the print menu.

---

## Seek Error

**Cause.** The disk controller cannot find a location on the disk that it expects to find.

**Action.** Retry the operation. Retry the operation on another disk.

---

## Single Sided Disk

**Cause.** The disk has been formatted as a single-sided disk.

**Action.** The HP 4957A needs a double-sided format.

---

## Start of Data Segment

**Cause.** Start of the current 16 blocks (32 Kbytes) of data.

**Action.** Use previous data segment key.

---

## Start of Valid Data

**Cause.** When you scroll to the beginning of buffer data.

**Action.** Scroll forward.

**Error Messages**

---

## Sync Lost One or More Times

**Cause.** A 'Data Error - Sync Lost' error has occurred at least once.

**Action.** Check either line going bad, or if tester was changed on the other end of the line. Waiting for data.

---

## Trying Again to Capture Data

**Cause.** Analyzer does not capture data and cannot find a clock.

**Action.** Press **Auto Cnfg** again. If that does not work go to the Setup Menu and manually set up the instrument.

---

## Waiting for Data

**Cause.** No line data or the analyzer is still collecting data to make a determination.

**Action.** Both data and idle conditions must be present.

---

## Waiting for Frames

**Cause.** The analyzer has detected a bit-oriented protocol but cannot capture frames.

**Action.** Press **Auto Cnfg** and try to capture frames or go to the setup menu and manually configure the analyzer.

---

## Waiting for Idles

**Cause.** Insufficient idles on the line. Both data and idles must be present.

**Action.** Character oriented protocols must have a minimum of ten idle characters between messages, and bit oriented protocols must have ten flags between frames

---

## Waiting for Messages

**Cause.** The analyzer has detected a character-oriented protocol but cannot find the sync characters.

**Action.** Press **Auto Cnfg** or go to the Setup Menu and manually configure the analyzer.

---

## Write Protected

**Cause.** Disk write protect tab is in the protect position. The tab will not be visible and a physical hole will exist in that portion of the disk case.

**Action.** To store information on a write protected disk, slide the protect tab to the opposite position.



---

## Status Messages

Status Messages are different than Error Messages. There is no corrective that can be taken. The HP 4957A is telling you that there is still protocol analyzer activity.

---

## Application Already Loaded

The application is already loaded in slave memory.

---

## Binary

Enter eight bits from softkeys. If the Setup data code is less than eight bits, the most significant bits are ignored.

---

## Buf = n

Message indicating which 2 kbyte block of memory (1 to 16) is being displayed. When memory wraparound occurs, the next 2 kbyte block to be loaded becomes Block 1. When viewing the buffer after run-time with examine data, the oldest data becomes Block 1. In the examine data menu, block numbers may go as high 384 if loaded from the capture buffer).

**Status Messages**

---

## End Frame

Enter the FCS character (good, bad, abort, don't care).

---

## Exploding Diamond (<>)

Symbol indicating data is being processed.

---

## Hex

Enter two digits for each hex character.

---

## Hex/Text

Pressing **Hex** converts all subsequent displayed data to hex format. The softkey label then changes to **Text** for changing the display back to the current data code.

---

## Not Hex

Enter a hex character which should NOT be triggered on.

---

## Not Text

Enter a single keyboard character which should NOT be triggered on.

---

## Prg = n

Message indicating which monitor or simulate menu block is currently executing. This can tell you when the program is locked up or when the analyzer is looking for a trigger event. It may flash very rapidly.

---

## Start Flag

The cursor is over a start flag, delete this character if desired.

---

## Stop Display/Start Display

The **Stop Disp** alternates with **Start Disp**. **Stop Disp** freezes the display, and **Start Disp** causes the most recent incoming data to be displayed. These do not affect the run, but the continuity of the run-time display may be lost. This softkey works identically to the 'start/stop display' statements in the monitor and simulate menus.

---

## Summary/Data Display

These alternate to show either the data display or the setup summary. Press **Summary** without affecting the run, to review the current setup and observe the counters and timers. The summary tracks the current setup menu. Press **Data Disp** to return to the data screen. The timers and counters display is updated at least twice per second.

---

## Text

Enter a single keyboard character.

---



---

Glossary

---

# Glossary

This glossary is a general explanation of terms that are used in this manual. The terms are not necessarily Hewlett-Packard specific, but datacommunications in general.

## **Auto Configure**

The HP 4957A can Auto Configure, sample line data and automatically make protocol analyzer settings to correctly monitor the line.

## **BERT**

Bit Error Rate Tests (BERT) measures analog noise on a digital circuit. You can determine how often highs are erroneously changed to lows and lows to highs..

## **Bisync (BSC)**

Most common character-oriented protocol that predefines sync characters depending upon data code.

## **Bit Count**

The number of actual data bits sent since synchronization (excluding framing, start, stop, and parity bits).

## **Bit Errors**

Divide bit errors by bit count to get Bit Error Rate.

## **Bit Error Rate**

The number of bit errors divided by the number of bits received.

## **Bit-oriented Protocol (BOPs)**

HDLC, SDLC, X.25, LAPB, ADCCP.

## **Blocks**

Bit error rate does not give any indication of error distribution. For example, if most errors occur within a few moments of each other, it might indicate that the line was all right, but had perhaps been affected by a lightning hit or path switch. For this reason, bits are grouped in blocks for measuring block error rate, sometimes referred to as BLERT.

**Block Check Character (BCC)**

An error checking character that is appended to a character-oriented protocol by the transmitter. The BCC is automatically appended to send strings in the Simulate menu.

**Block Count**

Tells how many blocks have been sent thus far in the test.

**Block Errors**

Tells how many blocks had at least one error. Divide block errors by block count to get Block Error Rate.

**Block Error Rate**

The number of block errors divided by the number of blocks received. Whether there is one error or ten errors in a block, it is still counted as one block error.

**Block Sizes**

The Bell system uses a block size of 1000 bits. CCITT, the world-wide standard, uses a block size equal to the pattern size. For example, if the PRBS pattern is 511 bits, then the block size would also be 511 bits.

**Character-oriented protocol (COPs)**

Half-duplex protocol that utilizes each significant character.

**Control field**

Field used to identify an I-frame, S-frame, and U-frame and control the behavior of the frame.

**Cyclic Redundancy Check (CRC)**

A technique for error checking in the data stream where a serial data block is used to calculate for errors.

**DCE**

Data communication equipment.

**DTE**

Data terminal equipment.

**Download**

A remote operation that transfers data, menus, or applications from a controller to a remote slave.

**Elapsed Seconds**

Elapsed time since receiver synchronization.

**Errored Seconds**

Tells how many of the elapsed seconds had error occurrences.

**% Error-Free Seconds**

Errored Seconds divided by Elapsed Seconds. Displayed at the end of the test.

**Frame Check Sequence (FCS)**

An error checking character that is appended to a bit-oriented protocol by the transmitter.

**I-frame**

Information frame (level 2) used to carry user data.

**Inject Error**

Press **Inject Error** at any time during the test. The receiver at the other end should indicate one bit error. This function can be used at the beginning of the test to check for proper hookup.

**Inject 10 Errors**

Press **Inject 10 Err** to send a burst of errors. The receiver at the other end should have counted ten bit errors, one or two block errors, and one or two errored seconds.

**IPARS**

International Passenger Airline Reservation System is used by most airlines. IPARS is a character-oriented protocol with six-bit data code and inverted bit sense.

**Isochronous**

Isochronous transmission is BERT asynchronous data with the protocol analyzer acting as a DCE with an internal X1 clock.

**Leased Line**

Permanent connection for private use within a datacommunication network independent of the public switching and signalling equipment.



**Longitudinal Redundancy Check (LRC)**

A technique for error checking in the data stream where each character plus parity is used to calculate for errors.

**Mass Store Device**

Devices that are used to store menus, data, and applications. The HP 4957A has two MSDs; floppy disk for menus, data, and applications, RAM disk for applications.

**Monitor**

Non-intrusive method of looking at the data stream on a line.

**MSB**

Mass Store Device

**Multi-drop configuration**

A remote configuration that has a controlling protocol analyzer connected to more than one slave.

**NRZI**

Non-Return to Zero Inverted. No clock present, the clocking signal is embedded in the data stream.

**N(R)**

Receive Sequence Number.

**N(S)**

Send Sequence Number.

**Packet Switching**

A technique implemented by the Public Data Networks where all data transfers are broken up in fixed length blocks (usually 128 bytes) surrounded by control information.

**Permanent Virtual Circuit**

Permanent virtual circuit is a permanent association between two DTEs, established by the user when subscribing to a packet-switched network (similar to a leased line). This circuit is held permanently by the network for the use of the subscriber.

**P/F**

Poll/Final bit.

**Point-to-point configuration**

A remote configuration that has two protocol analyzers connected to each end.

**PRBS (Pseudo Random Bit Sequence)**

A BERT tester generates pseudo random bit sequences from a shift register of length L, where the sequence length equals  $2^L - 1$  bits. A PRBS may be of any length but certain pattern lengths have become standard. The HP 4957A uses PRBS lengths of 63, 511, 2047, or 4095.

**Protocol Analyzer**

A test and measurement device placed between the DTE and DCE to test the link.

**RS-232C/V.24**

Most common level 1 interface up to 20 kbps and 50 feet. It is a 25 pin interface and uses an unbalanced single end generator and receiver.

**RS-449**

Mechanical standard that defines 37 pins plus nine secondary channels. This mechanical standard uses two electrical standards; RS-423A/V.10 and RS-422A/V.11.

**S-frame**

Supervisory frame (level 2) used to acknowledge or reject frames.

**Simulation**

An intrusive technique that the protocol analyzer enters the network and replaces the DCE or DTE. This technique exercises the network with known (user defined) data.

**Switched Virtual Circuit**

Temporary association between two DTEs established by the calling DTE sending a call request packet to the packet-switched network. This circuit is held for the duration of the call.

**Timing Resolution**

Smallest unit of measurement that can be timed at a given speed.

**Transparent Text**

Text that is masked out in the data stream. You can selectively define transparent text so a receiver will accept unexpected characters.

**Trigger**

When a programming condition is defined, a trigger is used to alter program execution. The HP 4957A defines triggers with a 'when' condition.

**U-frame**

Unnumbered frames (level 2) used to initialize and disconnect the DTE/DCE link.

**Upload**

A remote operation that transfers data, menus, or applications from a remote slave to a controller.

**Vertical Redundancy Check (VRC)**

A technique for error checking in the data stream where each character plus parity is used to calculate for errors (similar to LRC).

**Virtual Circuit**

Bidirectional association between two DTEs across a packet switched network. It is not a direct connection, but a logical communication path.

**Virtual Terminal Remote**

A remote operation with the ability to display an exact duplicate of the slave screen on the controller. This allows for real-time viewing and troubleshooting from a remote site.

**V.35**

Most common high-speed (>20 kbps) 34 pin balanced interface. V.35 operates at 1.344 Mbps at 30 meters.

---



# Index

---

## Special characters

?, 8-8

## A

AA, 8-41  
Address Field, 8-34  
Application Already Loaded, 13-25  
Application Denied, 13-3  
Application Not Compatible, 13-3  
Archive, 1-22  
Archive Softkey, 1-22  
Archiving, 1-22  
ASCII control characters  
    printed, 7-10  
Asynchronous Data  
    Auto Configure, 9-6  
asynchronous DCE BERT, 10-12  
asynchronous modems, 5-16  
Asynchronous Terminal Emulator, 6-5  
auto-answer, 5-13  
Auto Configure, 2-5, **9-3**

## B

Backing up RAM Disk, 1-22  
Bad Data - Cannot Sync, 13-3  
Bad Disk, 13-4  
BB, 8-41  
beep, 8-6  
Beep, **8-16**  
BERT framing, 4-4  
Bert Menu, 4-4  
BERT results, 4-8

BERT stat, 4-7  
BERT statistics, 4-7  
Binary, 13-25  
Bisync, **9-14**  
bit count, 4-8  
bit error rate, **4-2**  
Bit Error Rate Testing, 4-2  
bit errors, 4-8  
bit shift, 9-20  
blinking asterisk, 2-6, 9-3  
Block Check Characters, 8-40  
block count, 4-8  
block error rate, 4-2  
block errors, 4-8  
block number, 5-9  
BOPs  
    Auto Configure, 9-8  
Branching, 8-23  
break a link, 5-15  
breakout box, 1-7, 1-13  
BSC, **9-14**  
buffer blocks, 3-2  
Buffer Empty, 13-4  
Buffer Overflow, 13-4  
Buf = n, 13-25

## C

Can't Configure Within the Time Limit,  
    13-4  
Capt Cont softkey, 2-23  
Capt Full softkey, 2-23  
capture buffer, **3-2**

carriage return delay, 7-4  
Chang Dsply, 3-7  
change display format, 3-6  
Character code, 7-3  
Characters Not On the Keyboard, 8-7  
Character Triggers, 8-7  
Checksum Error, 13-5  
circular store to buffer, 2-23  
Cleaning the Disk Drive, 1-23  
Clear Header Softkey, 10-21  
Clock Slipped During Run, 13-5  
CNTL key, 1-6  
Combining If and When, 8-24  
Combining If Statements, 8-24  
command state, 5-15  
Comment field, 1-22  
Commenting, 8-30  
compatible applications, 5-9  
Conditional Branching, 8-23  
Connecting an External Monitor, 1-25  
Connecting for Remote Operation, 5-4  
control characters  
  emulator, 6-10  
Control Lead, 7-4  
Controller Error, 13-5  
Conversion Error Menus Reset, 13-5  
COPs  
  Auto Configure, 9-9  
copy a disk, 1-19  
Copy Disk utility, 1-19, 1-22  
Countable Events, 8-22  
Counter math, 10-3  
Counter Softkey, 8-23  
Counting Events, 8-22  
C&T Enbl Softkey, 10-3  
cursor timing, 8-19  
Cursor Timing, 8-21

## D

Data Communications Library  
  parameters, 2-10

Data Communications Test Library,  
  2-3  
Data Display, 13-28  
Data Error - Sync Lost, 13-6  
Data Filter, 8-18  
D bit, 8-38  
D bits, 8-37  
DCE BERT, 10-12  
decrementing counters, 8-22  
default packet, 8-39  
defects, 1-3  
Defining Triggers, 8-5  
Delaying Output, 8-10  
delete a file, 1-16  
Delete Block Softkey, 8-3  
Delete Field Softkey, 10-21  
Delete Softkey, 1-16  
Directory Full, 13-6  
Directory too Large, 13-6  
Dir softkey, 1-15  
Dir Softkey, 1-23  
disk drive, 1-4  
Disk Full, 13-7  
Disk Not Formatted, 13-7  
Disk Out, 13-7  
Disk Read Error Buffer Data Invalid,  
  13-8  
Disk Removed During a Read Operation,  
  13-7  
display, 1-4  
Displaying Messages, 8-31  
DLC Error, 13-8  
Dnld Data, 5-11  
Don't Care, 2-15  
download, 5-2  
download a menu, 5-10  
download applications, 5-9  
download data, 5-11  
Drive Error, 13-8  
drop sync characters, 9-18  
Duplicate Triggers, 8-14

## E

- Edit Character Strings, 8-7
- Editing Programs, 8-3
- elapsed seconds, 4-8
- emulator, 6-8
- Enable Softkey, 10-3
- End Addr Softkey, 8-35
- End Frame, 8-41, 13-26
- End Frame Softkey, 8-9
- Ending Remote Operations, 5-15
- End of Data Segment, 13-8
- End of Disk File, 13-9
- End of Valid Data, 13-9
- ENQ/ACK, 6-3, 7-4
- entering binary characters, 8-8
- entering hex characters, 8-8
- Entering Messages, 8-30
- EOF error, 13-9
- errored seconds, 4-8
- error-free seconds, 4-8
- Error Message
  - Application Denied, 13-3
  - Application Not Compatible, 13-3
  - Bad Data - Cannot Sync, 13-3
  - Bad Disk, 13-4
  - Buffer Empty, 13-4
  - Buffer Overflow, 13-4
  - Can't Configure Within the Time Limit, 13-4
  - Checksum Error, 13-5
  - Clock Slipped During Run, 13-5
  - Controller Error, 13-5
  - Conversion Error Menus Reset, 13-5
  - Data Error - Sync Lost, 13-6
  - Directory Full, 13-6
  - Directory too Large, 13-6
  - Disk Full, 13-7
  - Disk Not Formatted, 13-7
  - Disk Out, 13-7
  - Disk Read Error Buffer Data Invalid, 13-8
  - Disk Removed During a Read Operation, 13-7
  - DLC Error, 13-8
  - Drive Error, 13-8
  - End of Data Segment, 13-8
  - End of Disk File, 13-9
  - End of Valid Data, 13-9
  - EOF error, 13-9
  - File Already Exists, 13-9
  - File Does Not Exist, 13-10
  - File is Not Recoverable, 13-10
  - File Not Compatible, 13-10
  - Framing Error, 13-11
  - Handshake Error, 13-11
  - Improper Format, 13-11
  - Insufficient Data to Configure, 13-12
  - Invalid Async Framing, 13-12
  - Invalid asynchronous speed / Invalid synchronous speed, 13-12
  - Invalid File Name, 13-12
  - Invalid File Type, 13-13
  - Invalid Mon/Sim menu, 13-13
  - Invalid Sync Characters, 13-13
  - Issue ID Request to Enable Slave, 13-14
  - Max Length, 13-14
  - Max Strings, 13-14
  - Media Wear Protected, 13-14
  - Menu Full, 13-15
  - Menus Incompatible with HP 4957A, 13-15
  - Must Reset Slave First, 13-15
  - Must Reset Slave to Top Level, 13-15
  - New Name Already Exists, 13-16
  - No Application Loaded, 13-16
  - No Data in Buffer—Use EXIT Key to Exit, 13-16
  - No Data in Capture Buffer, 13-16
  - No Data Present, 13-17
  - No displayable data in buffer for the selected display format, 13-17

- No File; Run Aborted, 13-17
- No Idles, 13-18
- No More Highlights, 13-18
- Non LIF Format, 13-18
- Nonstandard Baud Rate, 13-19
- No Pod Attached, 13-19
- No Sync Characters, 13-19
- Operation Not Valid for HP 4957A,  
13-19
- Printer Error, 13-20
- Receiver Overrun, 13-20
- Record Not Found, 13-20
- Remote Timeout, 13-20
- Seek Error, 13-21
- Single Sided Disk, 13-21
- Start of Data Segment, 13-21
- Start of Valid Data, 13-21
- Sync Lost One or More Times, 13-22
- Trying Again to Capture Data, 13-22
- Waiting for Data, 13-22
- Waiting for Frames, 13-23
- Waiting for Idles, 13-23
- Waiting for Messages, 13-23
- Write Protected, 13-24
- Error Messages, 13-3
- Error Triggers, 8-11
- escape codes
  - from emulator, 6-11
- Exam Data, 3-3
- Excluding Characters, 8-9
- Exec BERT, 4-7
- Exec Run, 5-10
- Execute Softkey, 6-3
- Executing Programs, 8-4
- Exploding Diamond, 13-26
- extended address, 8-37, 8-38, 9-9
- Extended Addressing, **8-35**
- extended asynchronous baud rates,  
10-24
- extended control, 8-37, 8-38, 9-9
- Extend Softkey, 8-35

- External clock
  - High speed capture, 2-21
- External Interfaces, 1-13

## F

- File Already Exists, 13-9
- File Does Not Exist, 13-10
- File is Not Recoverable, 13-10
- File Not Compatible, 13-10
- Flags, 8-9
- Floppy Disk, 1-15
- Fltr softkey, 2-23
- format a disk, 1-18
- Format Softkey, 1-18
- Frame Check Characters, 8-9
- Frame Check Sequence, 8-41
- Frame Type, 8-35
- Framing Error, 13-11
- front panel, 1-4
- full-duplex, 4-3

## G

- GFI, 8-37, 8-38, **8-38**
- GG, 8-41
- gosub block statement, 8-32
- grounding requirements, 1-10

## H

- half-duplex, 4-3
- Handshake
  - Printer, 7-4
- Handshake Error, 13-11
- Hex, 3-7, 13-26
- Hexadecimal characters
  - printed, 7-10
- hexadecimal entry, 9-17
- Hex codes
  - printed, 7-10
- Hex/Text, 13-26
- highlight, 8-6
- Highlight, **8-16**



high speed capture, 2-20  
High speed capture limits, 2-23  
High speed monitor, 2-20  
High speed simulate, 2-20  
HS Capt Softkey, 2-22  
HS\_Capture, 2-21

## I

ID Slave, 5-7  
If Counter, 8-23  
I-frame, 2-16  
I-Frame, **8-35**  
Improper Format, 13-11  
Initial Inspection, 1-3  
Inject Error, 4-5  
Insert Block Softkey, 8-3  
Insert Line, 8-3  
Insufficient Data to Configure, 13-12  
interactive testing, 2-24  
internal interfaces, 1-12  
Invalid Async Framing, 13-12  
Invalid asynchronous speed / Invalid  
    synchronous speed, 13-12  
Invalid File Name, 13-12  
Invalid File Type, 13-13  
Invalid Mon/Sim menu, 13-13  
Invalid Sync Characters, 13-13  
inverse video  
    printed, 7-10  
IPARS, 10-9  
IPARS Setup, 10-9-10  
isochronous, 10-14  
isochronous DCE BERT, 10-12  
Issue ID Request to Enable Slave, 13-14

## K

key, 1-6  
Key  
    CNTL, 1-6  
    EXIT, 1-6  
    MORE, 1-6

SHIFT, 1-6  
keyboard, 1-4

## L

LCGN, **8-38**  
LCN, 8-37, 8-38, **8-38**  
Lead Levels  
    printed, 7-11  
lead status, 1-6  
Lead Triggers, 8-10  
LEDs, 1-6  
Level 2 programming, 2-14  
Level 2 Programming, 8-34  
Level 3 programming, 2-28  
Level 3 Programming, 8-37  
Levl 2, 2-15  
LIF, 1-18  
Line Interchange Format, 1-18  
Line Termination Characters, 7-4  
Load, 1-21  
load an application, 1-21  
Load Appl, 1-21, 10-3  
Load Appl Softkey, 1-19, 2-21, 10-24  
Loading from Floppy, 1-20  
locked keyboard, 5-8  
Logical Channel Number, 10-16

## M

Marking Triggers, 8-16  
Masking Out Characters, 8-8  
Mass Store, 2-10, 2-35  
Mass Store Devices, 1-15  
Mass Store Menu, 1-15, 1-20  
maximum count, 8-22  
maximum cursor time, 8-21  
maximum highlights, 8-16  
maximum program blocks, 8-2  
maximum subroutines, 8-32  
maximum triggers, 8-5  
Max Length, 13-14  
Max Strings, 13-14

measure time intervals, 3-4  
Measuring Time, 8-17  
MEC, 10-11  
mechanical damage, 1-3  
Media Wear Protected, 13-14  
Menu  
    Mass Store, 1-15  
    Remote, 5-2  
Menu Full, 13-15  
Menus Incompatible with HP 4957A,  
    13-15  
Message Softkey, 8-30  
message statement, 8-30  
Mod, **8-38**  
Mod 8, 2-30  
modem, 5-4  
modem string, 5-13  
Modified Error Check, 10-9, 10-11  
modulo 128, 8-37  
modulo 8, 8-37  
Monitor Buffer, 3-9  
MORE key, 1-6  
MSD, 1-15  
MSD=Disk, 2-35  
MSD=RSM, 2-35  
multi-drop configuration, 5-2, 5-13  
Multiple Triggers, 8-13  
Must Reset Slave First, 13-15  
Must Reset Slave to Top Level, 13-15

**N**

New Name Already Exists, 13-16  
Next Page, 3-2  
No Application Loaded, 13-16  
No Data in Buffer—Use EXIT Key to  
    Exit, 13-16  
No Data in Capture Buffer, 13-16  
No Data Present, 13-17  
No displayable data in buffer for the  
    selected display format, 13-17  
No File; Run Aborted, 13-17

No Idles, 13-18  
No More Highlights, 13-18  
non-intrusive monitoring, 2-5  
Non LIF Format, 13-18  
Nonstandard Baud Rate, 13-19  
nonvolatile memory, 1-15, 3-2  
nonvolatile RAM disk, 2-35  
No Pod Attached, 13-19  
No Sync Characters, 13-19  
Not Hex, 13-26  
Not\* Softkey, 8-9  
Not Softkey, 8-9  
Not Text, 13-27  
N(R), 8-35  
NRZI encoded data  
    High speed capture, 2-23  
N(S), 8-35

**O**

on-line modem, 5-15  
Operation Not Valid for HP 4957A,  
    13-19  
ORing Triggers, 8-13  
Overlapping Triggers, 8-14

**P**

pack a disk, 1-18  
pack disk, 1-16  
Pack Disk Softkey, 1-18  
Packets, 8-37  
Packet Type, 8-38, **8-39**  
Parity  
    Triggering, 8-9  
partial trigger match, 8-15  
percent error free seconds, 4-7  
P/F, 8-35  
place a call, 5-7  
Placing a Remote Call, 5-6  
point-to-point configuration, 5-2, 5-13  
poll/final bit, 2-16  
post-process, 3-8

power cord, 1-10  
power source, 1-10  
Prev Page, 3-2  
Prg = n, 13-27  
print buffer contents, 7-7  
Printer Error, 13-20  
Print Setup, 7-3  
program blocks, 8-2  
programming, 2-4  
program pauses, 8-10  
Program Pauses, **8-26**  
pseudo random bit sequences, 4-2

## Q

Q bit, **8-38**  
Q bits, 8-37

## R

RAM disk, 1-15  
Read Disc Softkey, 1-19  
rear panel, 1-9  
Receiver Overrun, 13-20  
receive sequence number, 2-17  
receiving a call, 5-13  
Record Not Found, 13-20  
recover a file, 1-16, 1-17  
Recover Softkey, 1-17  
Remote, 5-9  
remote BERT, 4-6  
Remote menu, 5-2  
remote operations, 5-2  
REMOTE/PRINTER connector, 5-4,  
7-2  
Remote Restrictions, 5-16  
Remote Timeout, 13-20  
rename a file, 1-17  
Rename Softkey, 1-17  
Reset Aplic Softkey, 1-24  
Reset Menus Softkey, 1-24  
Reset Slave, 5-7  
Reset Softkey, 1-24

Resetting Counters, 8-22  
Resetting to Default Parameters, 1-24  
Restore Softkey, 1-22  
Restoring, 1-22  
Restrictions  
    Program, 8-4  
return statement, 8-32  
Roll Down, 3-2  
Roll Up, 3-2  
RS-170, 1-25  
RS-232 interface, 1-13  
Run menu, 2-6  
Run Menu, 8-4  
Run Menu Softkey, 1-12

## S

Saving Setups, 9-11  
scrolling, 6-8  
Seek Error, 13-21  
Select Iface, 2-6  
Select Iface Softkey, 1-12  
Selecting the Physical Interface, 1-12  
Sel Ifac softkey, 2-23  
send characters, 8-40  
Send Cnfg, 5-7  
send command, 8-34  
send sequence number, 2-16  
Sequencing Triggers, 8-14  
Set Ctr Softkey, 10-3, 10-5  
set lead command, 8-42  
Setup After Typing a String, 8-7  
Setup menu  
    High speed capture, 2-21  
Setup Menu, **9-10**  
Setup=Sim., **6-7**  
Setup=Sim. Softkey, 6-3  
S-frame, 2-18  
S-Frame, **8-35**  
S-Frame types, 8-35  
SHIFT key, 1-6  
shipping instructions, 1-3

side panel, 1-13  
 Sim Menu, 2-26  
 Single Sided Disk, 13-21  
 slave address, 5-13  
 slave command mode, 5-6  
 smart cursor, 3-6  
 Softkey  
   Archive, 1-22  
   Auto Confg, 2-6, 9-3  
   BERT, 4-4  
   BERT stat, 4-7  
   Binary, 8-8  
   Capt Cont, 2-23  
   Capt Full, 2-23  
   Chang Dsply, 3-7  
   Clear Header, 10-21  
   Counter, 8-23  
   C&T Enbl, 10-3  
   Data, 2-31  
   Delete, 1-16, 8-3  
   Delete Block, 8-3  
   Delete Field, 10-21  
   Delete Line, 8-3  
   Dir, 1-15  
   Dnld Appl, 5-9  
   Dnld Data, 5-11  
   Don't Care, 2-15  
   Enable, 10-3  
   End Addr, 8-35  
   End Frame, 8-9  
   Exam Data, 3-3  
   Exec BERT, 4-7  
   Exec Run, 5-10  
   Extend, 8-35  
   Fltr, 2-23  
   Format, 1-18  
   Hex, 3-7, 8-8  
   HS Capt, 2-22  
   I-frame, 2-16  
   Inject Error, 4-5  
   Insert, 8-3  
   Insert Block, 8-3  
   Insert Line, 8-3  
   Levl 2, 2-15  
   Levl 3, 8-37  
   Load, 1-21  
   Load Appl, 1-21, 2-21  
   Mass Store, 2-10  
   Message, 8-30  
   Mod 8, 2-30  
   Monitor Buffer, 3-9  
   Monitor Line, 2-8  
   MSD=Disk, 2-35  
   MSD=RSM, 2-35  
   Nex Hilit, 3-2  
   Nex Segmt, 3-2  
   Next Page, 3-2  
   Not, 8-9  
   Not\*, 8-9  
   Pack Disk, 1-18  
   Prev Page, 3-2  
   Prev Segmt, 3-2  
   Print, 7-6  
   Print Data, 7-7  
   Print Setup, 7-3  
   Read Disk, 1-19  
   Recover, 1-17  
   Remote, 5-9  
   Rename, 1-17  
   Reset, 1-24  
   Reset Aplic, 1-24  
   Reset Menus, 1-24  
   Restore, 1-22  
   Roll Down, 3-2  
   Roll Up, 3-2  
   Run Menu, 1-12, 2-6  
   Select Iface, 1-12, 2-6  
   Sel Ifac, 2-23  
   Send Cnfg, 5-7  
   Set Ctr, 10-3, 10-5  
   Setup, 9-10  
   Setup=Sim., 6-3

- S-frame, 2-18
- Sim Menu, 2-26
- Simulate, 2-26
- Specify Block, 3-2
- Start Flag, 8-9
- Summary, 2-7, 4-5, 9-4
- Text, 3-7, 8-7
- Timer, 3-9
- U-frame, 2-18
- Upld Appl, 5-12
- Upld Data, 5-12
- Upld Menu, 5-12
- VT100 Execute, 6-3
- VT100 Setup, 6-3
- VT100 Simulate, 6-3
- When Trig, 8-5
- Write Disk, 1-19
- X.25 Filter, 10-15
- softkey programming, 2-8, 8-2
- Softkey Reference, 11-2
- Softkey Triggers, 8-12
- start, 8-6
- Start Disk, 8-28
- Start Display, 8-29, 13-27
- Start Flag, 13-27
- Start Flag Softkey, 8-9
- start flag time stamp, **8-20**
- Start of Data Segment, 13-21
- Start of Valid Data, 13-21
- Status Message
  - Application Already Loaded, 13-25
  - Binary, 13-25
  - Buf = n, 13-25
  - Data Display, 13-28
  - End Frame, 13-26
  - Exploding Diamond, 13-26
  - Hex, 13-26
  - Hex/Text, 13-26
  - Not Hex, 13-26
  - Not Text, 13-27
  - Prg = n, 13-27
  - Start Display, 13-27
  - Start Flag, 13-27
  - Stop Display, 13-27
  - Summary, 13-28
  - Text, 13-28
- stop, 8-6
- stop bits
  - emulator, 6-8
- Stop Disk, 8-28
- Stop Display, 8-29, 13-27
- Stop Tests, 8-29
- storing to disk, 2-34
- Subprograms, 8-32
- Summary, 2-7, 13-28
  - BERT, 4-5
- Summary Softkey, 9-4
- Supervisory Frame filter, 10-16
- sync characters, 9-18
- Synchronous Data
  - Auto Configure, 9-5
- Sync Lost One or More Times, 13-22
- synchronous DCE BERT, 10-12

**T**

- terminal display, 6-8
- terminal mode, 6-3
- Terminal Setup menu, 6-5
- Text, 3-7, 13-28
- Text Softkey, 8-7
- Timeouts, 8-11
- Timer, 3-9
- timer interval, 8-17
- Timers, 8-17
- Time Stamps, 8-17
- timing information, **8-18**
- timing on lead changes, 8-19
- Timing resolution, **3-10**
  - High speed, 2-20
- Timing Resolution, 8-21
- transfer extended menus, 5-10
- transition

printed, 7-11  
transportation disk, 1-3  
triggers, 2-4  
Trying Again to Capture Data, 13-22  
Types of Triggers, 8-7

## **U**

U-frame, 2-18  
U-Frame, **8-36**  
unattended mode, 5-13  
Unconditional Branching, 8-25  
undefined file, 1-15  
Upld Appl, 5-12  
Upld Data, 5-12  
Upld Menu, 5-12  
upload, 5-2  
upload to a controller, 5-12

## **V**

Video Monitor, 1-25  
video output, 1-25  
Virtual Terminal Remote, 5-13  
VT100 Setup menu, 6-5  
VT100 Setup Softkey, 6-3

VT100 Simulate Softkey, 6-3

## **W**

Waiting for Data, 13-22  
Waiting for Frames, 13-23  
Waiting for Idles, 13-23  
Waiting for Messages, 13-23  
Wait statements, 8-10  
when statements, 2-4  
When Trig Softkey, 8-5  
within text, 9-19  
Write Disk Softkey, 1-19  
Write Protected, 13-24

## **X**

X.25 Filter Softkey, 10-15  
X.25 PAD, 5-17  
X.25 Timing and Lead filter, 10-16  
Xon/Xoff, 6-3, 7-4

## **Z**

zero bit deletion, 8-41  
zero bit insertion, 8-41

Copyright © 1991  
Hewlett-Packard  
Printed in USA 07/91

Reorder No. or  
Manual Part No.  
04957-99901

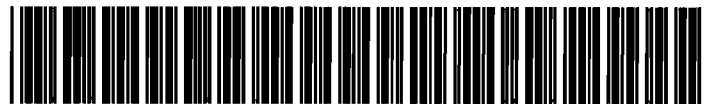

04957-99901E0791