

Acer TravelMate 540 Series

Service Guide

Service guide files and updates are available on the ACER/CSD web; for more information, please refer to <http://csd.acer.com.tw>

SERVICE CD PART NO.: VD.T34V5.001

PRINTED IN TAIWAN

Revision History

Please refer to the table below for the updates made on TravelMate 540 service guide.

Date	Chapter	Updates
2003/09/30	Chapter 1 page 30	Revise battery specification
2003/11/17	Chapter 4	Add POST codes

Copyright

Copyright © 2003 by Acer Incorporated. All rights reserved. No part of this publication may be reproduced, transmitted, transcribed, stored in a retrieval system, or translated into any language or computer language, in any form or by any means, electronic, mechanical, magnetic, optical, chemical, manual or otherwise, without the prior written permission of Acer Incorporated.

Disclaimer

The information in this guide is subject to change without notice.

Acer Incorporated makes no representations or warranties, either expressed or implied, with respect to the contents hereof and specifically disclaims any warranties of merchantability or fitness for any particular purpose. Any Acer Incorporated software described in this manual is sold or licensed "as is". Should the programs prove defective following their purchase, the buyer (and not Acer Incorporated, its distributor, or its dealer) assumes the entire cost of all necessary servicing, repair, and any incidental or consequential damages resulting from any defect in the software.

Acer is a registered trademark of Acer Corporation.

Intel is a registered trademark of Intel Corporation.

Pentium and Pentium II/III are trademarks of Intel Corporation.

Other brand and product names are trademarks and/or registered trademarks of their respective holders.

Conventions

The following conventions are used in this manual:

SCREEN MESSAGES	Denotes actual messages that appear on screen.
NOTE	Gives bits and pieces of additional information related to the current topic.
WARNING	Alerts you to any damage that might result from doing or not doing specific actions.
CAUTION	Gives precautionary measures to avoid possible hardware or software problems.
IMPORTANT	Reminds you to do specific actions relevant to the accomplishment of procedures.

Preface

Before using this information and the product it supports, please read the following general information.

1. This Service Guide provides you with all technical information relating to the BASIC CONFIGURATION decided for Acer's "global" product offering. To better fit local market requirements and enhance product competitiveness, your regional office MAY have decided to extend the functionality of a machine (e.g. add-on card, modem, or extra memory capability). These LOCALIZED FEATURES will NOT be covered in this generic service guide. In such cases, please contact your regional offices or the responsible personnel/channel to provide you with further technical details.
2. Please note WHEN ORDERING FRU PARTS, that you should check the most up-to-date information available on your regional web or channel. If, for whatever reason, a part number change is made, it will not be noted in the printed Service Guide. For ACER-AUTHORIZED SERVICE PROVIDERS, your Acer office may have a DIFFERENT part number code to those given in the FRU list of this printed Service Guide. You MUST use the list provided by your regional Acer office to order FRU parts for repair and service of customer machines.

Chapter 1	System Specifications	1
	Features	1
	System Block Diagram	3
	Board Layout	4
	Top View	4
	Bottom View	5
	Outlook View	6
	Front View	6
	Front Panel	8
	Left view	9
	Right view	10
	Rear Panel	11
	Bottom Panel	12
	Indicators	13
	Lock Keys	14
	Embedded Numeric Keypad	15
	Windows Keys	16
	Hot Keys	17
	The Euro Symbol	19
	Launch Keys	20
	E-mail Detection	20
	Touchpad	22
	Touchpad Basics	22
	Hardware Specifications and Configurations	24
Chapter 2	System Utilities	35
	BIOS Setup Utility	35
	Navigating the BIOS Utility	36
	Information	37
	Main	38
	Advanced	40
	Security	41
	Boot	45
	Exit	46
	BIOS Flash Utility	47
Chapter 3	Machine Disassembly and Replacement	49
	General Information	50
	Before You Begin	50
	Disassembly Procedure Flowchart	51
	Removing the Battery Pack	53
	Removing the HDD Module/FDD Module/ Optical Module/CPU/Middle Cover and LCD Module	54
	Removing the HDD Module	54
	Removing the Optical Disc Drive Module	54
	Removing the FDD (Card Reader) Module	54
	Removing the CPU	55
	Removing the Middle Cover	55
	Removing the LCD Module	56
	Disassembling the Main Unit	57
	Separate the main unit into the logic upper and the logic lower assembly	57
	Disassembling the logic upper assembly	58
	Disassembling the logic lower assembly	59
	Disassembling the LCD Module	61

Table of Contents

Disassembling the External Modules	63
Disassembling the HDD Module	63
Disassembling the Optical Disc Drive Module	63
Disassembling the Floppy Disc Drive Module	64
Chapter 4 Troubleshooting	65
System Check Procedures	66
External Diskette Drive Check	66
External CD-ROM Drive Check	66
Keyboard or Auxiliary Input Device Check	66
Memory check	67
Power System Check	67
Touchpad check	68
Power-On Self-Test (POST) Error Message	69
Index of Error Messages	70
POST Code	72
Index of Symptom-to-FRU Error Message	76
Intermittent Problems	80
Undetermined Problems	81
Chapter 5 Jumper and Connector Locations	83
Top View	83
Bottom View	84
Chapter 6 FRU (Field Replaceable Unit) List	85
TravelMate 540 Series	104
Appendix A Model Definition and Configuration	104
Appendix B Test Compatible Components	105
Microsoft® Windows® XP Pro Environment Test	106
Microsoft® Windows® 2000 Environment Test	110
Appendix C Online Support Information	115
Index	118

System Specifications

Features

This computer was designed with the user in mind. Here are just a few of its many features:

Performance

- Mobile Intel® Pentium® 4 Processor with 512 KB level 2 cache featuring the new Enhanced Intel SpeedStep® technology
- Standard 256 MB DDR333 SDRAM, upgradeable to 2GB on dual soDIMM sockets (Only one slot for user accessible)
- Integrated 24x CD-ROM, 8x DVD-ROM, 24/10/8/24x DVD/CD-RW combo or DVD-RW or DVD-Dual drive
- 30/40/60 GB or higher-capacity ATA/100 HDD
- Li-Ion main battery pack
- Power management system with ACPI (Advanced Configuration Power Interface) 1.0b supporting Standby and Hibernation power saving modes

Display

- 14.1" Thin-Film Transistor (TFT) liquid-crystal display (LCD) displaying 32-bit high colour up to 1024X768 eXtended Graphics Array (XGA) resolution
- 15" Thin-Film Transistor (TFT) liquid crystal display (LCD) displaying 32-bit high true color up to 1400X1050 Super eXtended Graphics Array + (SXGA+) resolution
- 3D capabilities
- Simultaneous LCD and CRT display support
- S-video for output to a television or display device that supports S-video input
- "Automatic LCD dim" feature that automatically decides the best settings for your display and conserves power
- Dual display capability

Multimedia

- 16-bit high-fidelity AC'97 stereo audio
- Built-in dual speakers
- Built-in microphone
- High-speed optical drive

Connectivity

- High-speed fax/data modem port
- Ethernet/Fast Ethernet port
- Fast infrared wireless communication
- USB 2.0 (Universal Serial Bus) ports
- IEEE 1394 port
- Docking port for port replicator
- Integrated InVilink wireless LAN module
- Integrated Bluetooth module

Keyboard and Pointing Device

- Internet 4-way scroll button
- Sleek, smooth and stylish design
- Acer FinTouch full-sized curved keyboard
- Ergonomically-centered touchpad pointing device

Expansion

- Two type II or one type III CardBus PC Card slot
- Upgradeable memory

I/O Ports

- Two type II or one type III CardBus PC Card slot
- One RJ-11 phone jack (V.90/92)
- One RJ-45 jack (Ethernet 10/100)
- One DC-in jack for AC adapter
- One parallel port
- One VGA port for external monitor
- One speaker/headphone-out jack (3.5mm mini jack)
- One audio line-in jack (3.5mm mini jack)
- One microphone-in jack
- One IEEE 1394 port
- One S-video TV-out port
- One 100-pin port replicator
- Three USB 2.0 ports
- One FIR port (IrDA)
- 5-in-1 Card Reader (Manufacture optional)

System Block Diagram

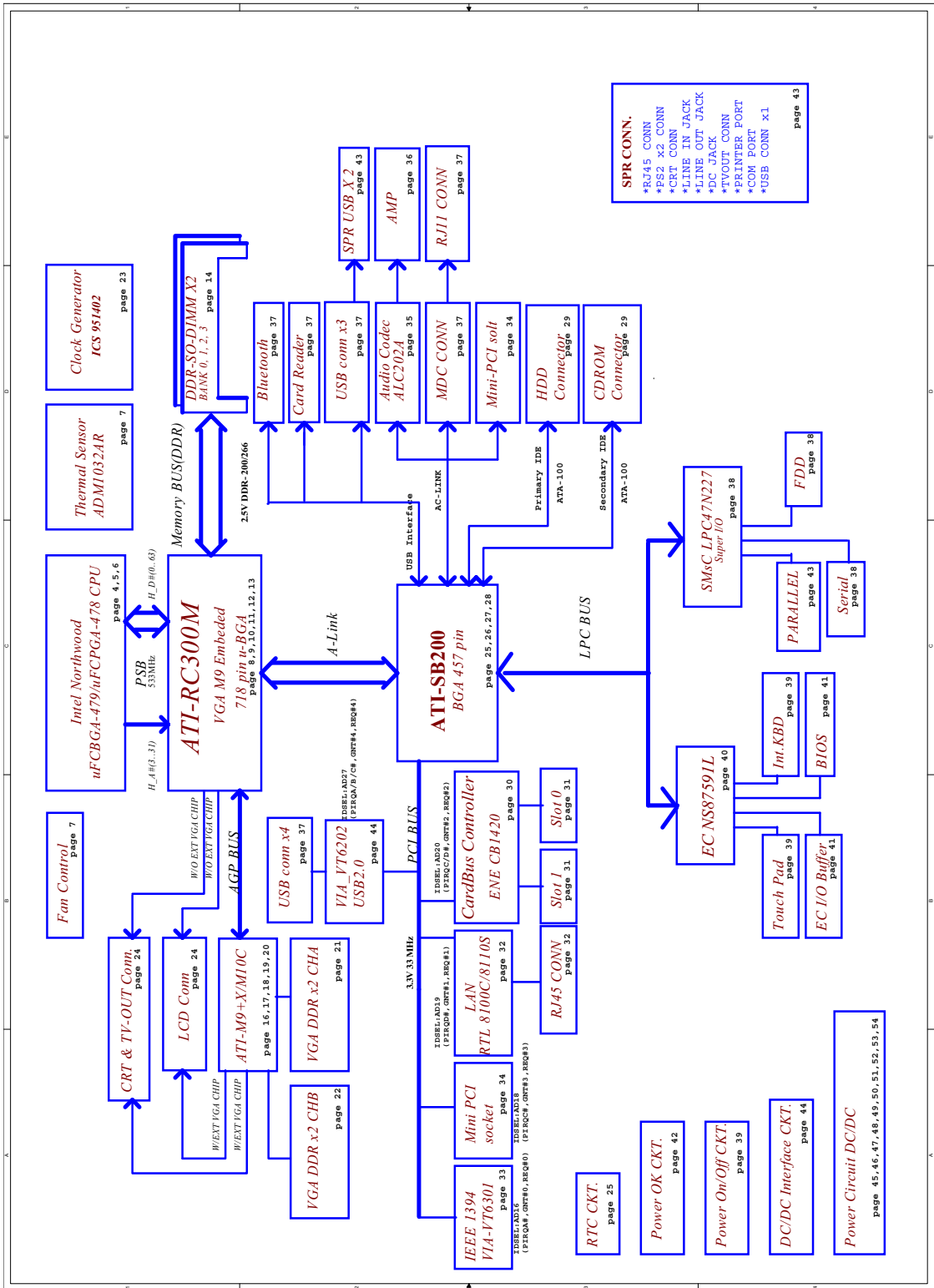

Board Layout

Top View

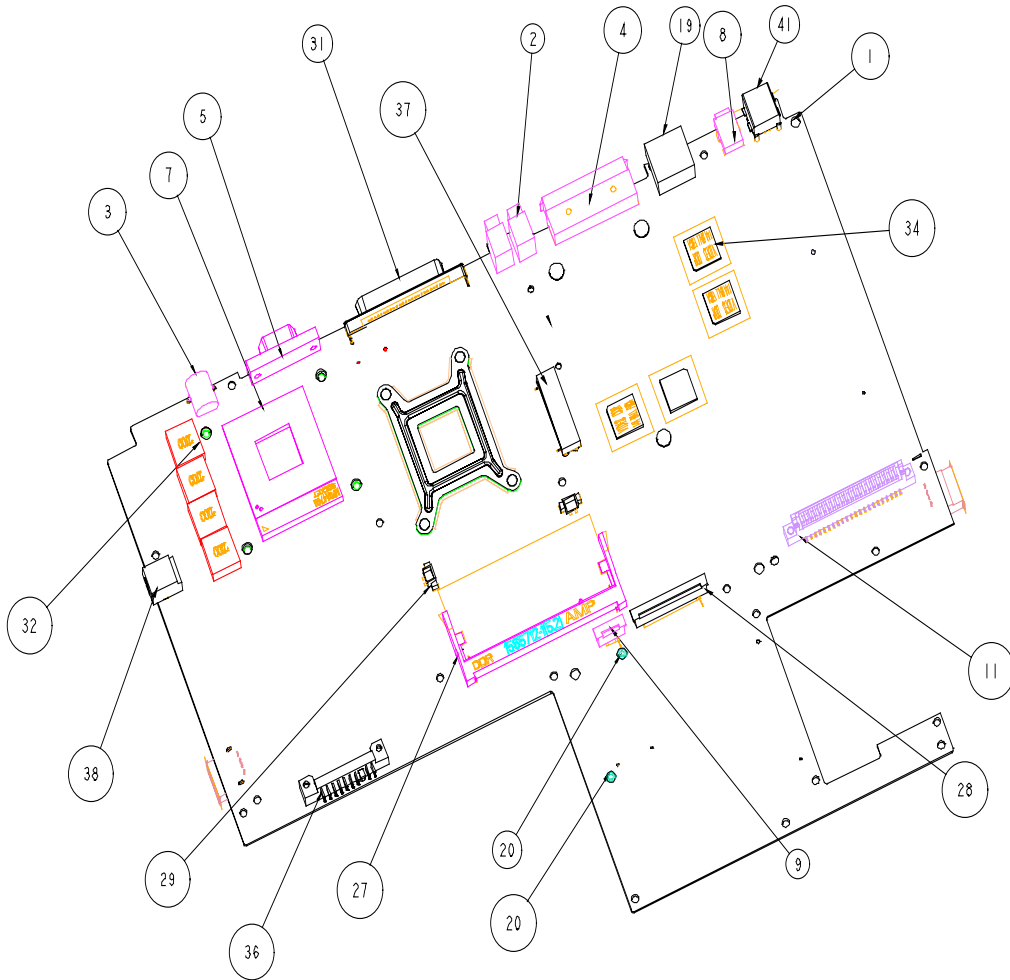

3 S-Video Port

7 CPU Socket

5 VGA Port

31 Print Port

37 ODD Module Connector

2 Two USB Ports

4 Docking Connector

19 RJ45

8 IEEE 1394 Port

41 RJ11

34 VGA Memory

11 HDD Connector

28 FDD Connector

9 Card Reader Connector

27 DIMM Socket

36 Battery Connector

29 Fan Connector

38 DC-In

Bottom View

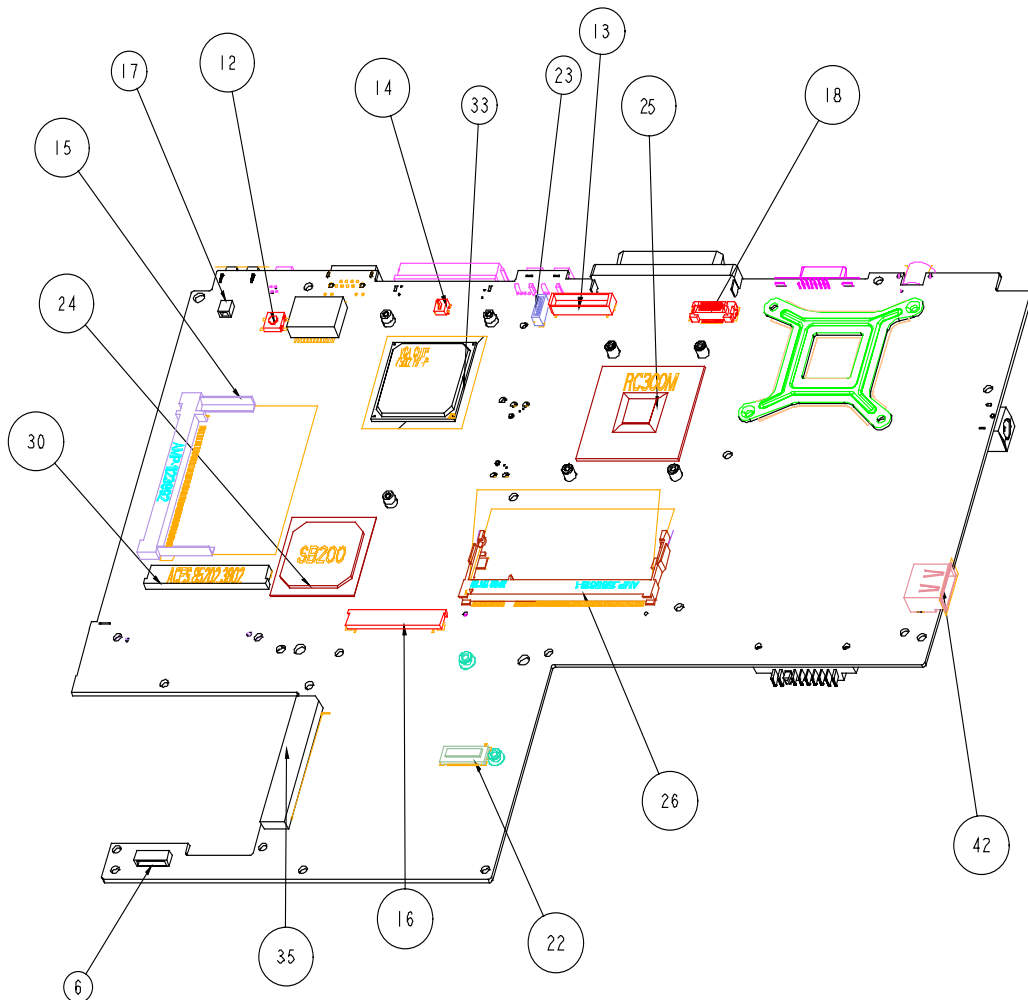

42	USB Port	25	North Bridge
30	Touchpad FFC Connector	13	LCD Cable Connector
24	South Bridge	18	Function Board Connector
15	Mini PCI Socket	26	DIMM Socket
17	Modem Connector	22	MDC Board Connector
12	Power Switch	16	Keyboard Connector
14	Lid Switch	35	PCMCIA Connector
33	VGA Chipset	6	Bluetooth FFC Connector
23	LCD Inverter Connector		

Outlook View

A general introduction of ports allow you to connect peripheral devices, as you would with a desktop PC.

Front View





#	Icon	Item	Description
1		Display screen	Also called LCD (liquid-crystal display), displays computer output.
2		Launch keys	Special keys for launching Internet browser, E-mail program and frequently used programs. Located at the top of the keyboard are five buttons. They are designated as P1, P2, P3, E-mail button and Web browser button. P1, P2 and P3 launch user-programmable applications; E-mail and Web browser launch E-mail and Internet browser applications.
3		Power Switch	Turns on the computer power.
4		Touchpad	Touch-sensitive pointing device which functions like a computer mouse.
5		Click buttons (left, center and right)	The left and right buttons function like the left and right mouse buttons; the center button serves as a 4-way scroll button.
6		Infrared port	Interfaces with infrared devices (e.g., infrared printer, IR-aware computer.)
7		Floppy disc drive (or card reader, if installed)	Reads/writes data from/to the media.
8		Floppy eject button	Ejects floppy disc. (N/A when card reader installed.)
9		Speakers	Outputs sound.

10		Palmrest	Comfortable support area for your hands when you use the computer.
11		Keyboard	Inputs data into your computer.
12		Status indicators	LEDs (light-emitting diode) that turn on and off to show the status of the computer, its functions and components.
13		Latch	Latch for opening and closing the laptop.

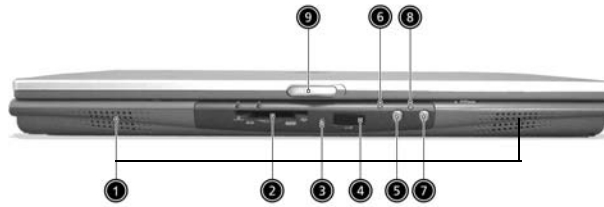

Front Panel



#	Icon	Item	Description
1		Left Speaker	Outputs sound for the left stereo speaker.
2		4-in-1 memory reader	Reads cards from Smart Media, Memory Stick, MultiMedia, and Secure Digital cards.
3		4-in-1 status indicator	Displays activity of 4-in-1 memory reader.
4		Infrared port	Interfaces with infrared devices (e.g., infrared printer, IR-aware computer).
5		Bluetooth button	Starts Bluetooth functionality.
6		Bluetooth indicator	Indicates that (optional) Bluetooth is enabled.
7		InviLink button	Enables or disables wireless LAN feature.
8		InviLink indicator	Indicates status of wireless LAN communication
9		Latch	Latch for opening and closing the laptop.

Left view



#	Icon	Item	Description
1		Optical drive	Houses an optical drive module (CD-ROM, DVD-ROM or DVD/CD-RW combo drive).
2		Optical drive indicator	Lights up when the optical drive is active.
3		Eject button	Ejects the drive tray.
4		Emergency eject slot	Ejects the drive tray when the computer is turned off.
5		PC card eject button	Ejects the PC card from the slot.
6		PC card slots	Accepts two type II or one type III PC cards.
7		Headphone/Speaker/ Line-out Jack	Connects to audio line-out devices (e.g., headphones, speakers).
8		Microphone/Line-in jack	Accepts audio line-in devices (e.g., microphone, audio CD player, stereo walkman).



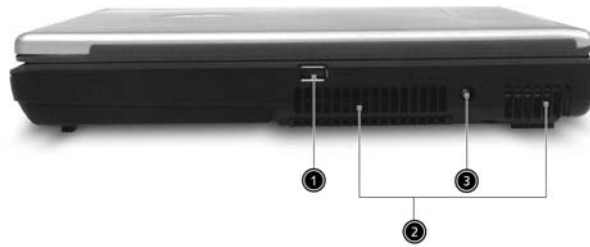



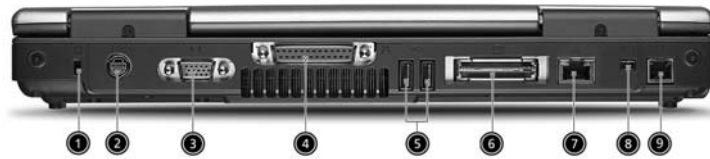

Right view



#	Icon	Item	Description
1		USB port	Connect to Universal Serial Bus devices (e.g., USB mouse, USB camera).
2		Ventilation slot	Lights up when the AcerMedia drive is active.
3		Power jack	Connects to an AC adapter.

Rear Panel



#	Icon	Item	Description
1		Security keylock	Connects to a Kensington-compatible computer security lock.
2		S-video	Connects to a television or display device with S-video input.
3		External display port	Connects to a display device (e.g., external monitor, LCD projector).
4		Parallel port	Connects to a parallel device (e.g., parallel printer).
5		USB ports	Connects to Universal Serial Bus devices (e.g., USB mouse, USB camera)
6		Expansion port	Connects to I/O port replicator or expansion devices (e.g., Acer EasyPort).
7		Network jack	Connects to an Ethernet 10/100-base network.
8		IEEE 1394 port	Connects to an IEEE 1394 device.
9		Modem jack	Connects to a phone line.

Bottom Panel









#	Icon	Item	Description
1		Battery bay	Houses the computer's battery pack.
2		Battery release latch	Unlatches the battery to remove the battery pack.
3		Cooling fans	Help keep the computer cool. Note: Don't cover or obstruct the opening of the fans.
4		HDD	Houses the computer's Hard Disk.
5		FDD/card reader cable connector cover	Accesses the cable connectors for the FDD or card reader.
6		AcerMedia Bay	Houses an AcerMedia drive module.
7		AcerMedia Bay release latch	Unlatches the AcerMedia drive for removing the optical drive.

Indicators

The computer has seven easy-to-read status icons below the display screen.





The status LCD displays icons that show the status of the computer and its components.

Icon	Function	Description
	Power	Lights green when the computer is on and lights orange when the computer is in Standby mode.
	Media Activity	Lights when the disc or AcerMedia is activated.
	Battery charge	Lights green when the battery is being charged. Lights orange when the battery power is low and is being charged.
	Wireless Communication (applicable only when Wireless LAN or Bluetooth installed)	Lights orange when the Wireless LAN capabilities are enabled. Lights blue when Bluetooth capabilities are enabled.
	Caps lock	Lights when Caps Lock is activated.
	Num loc	Lights when Num Lock is activated.
	Scroll lock	Lights when Scroll lock is activated.

Lock Keys

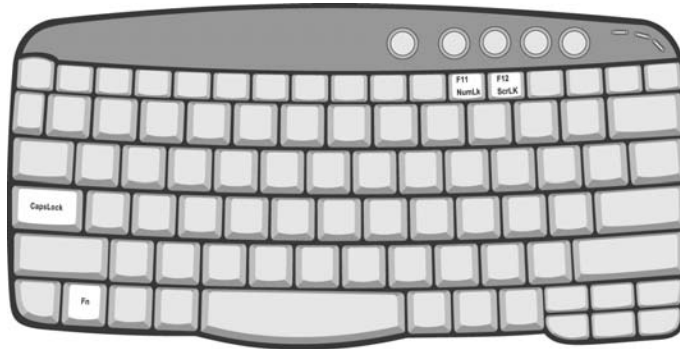
The keyboard has three lock keys which you can toggle on and off.



Lock Key	Description
Caps Lock	When Caps Lock is on, all alphabetic characters typed are in uppercase.
Num lock (Fn-F11)	When Num Lock is on, the embedded keypad is in numeric mode. The keys function as a calculator (complete with the arithmetic operators +, -, *, and /). Use this mode when you need to do a lot of numeric data entry. A better solution would be to connect an external keypad.
Scroll lock (Fn-F12)	When Scroll Lock is on, the screen moves one line up or down when you press  and  respectively. Scroll Lock does not work with some applications.

Embedded Numeric Keypad

The embedded numeric keypad functions like a desktop numeric keypad. It is indicated by small characters located on the upper right corner of the keycaps. To simplify the keyboard legend, cursor-control key symbols are not printed on the keys.











Desired Access	Num Lock On	Num Lock Off
Number keys on embedded keypad	Type numbers in a normal manner.	
Cursor-control keys on embedded keypad	Hold SHIFT while using cursor-control keys.	Hold Fn while using cursor-control keys.
Main keyboard keys	Hold Fn while typing letters on embedded keypad.	Type the letters in a normal manner.

Windows Keys

The keyboard has two keys that perform Windows-specific functions.



Key	Icon	Description
Windows logo key		Start button. Combinations with this key perform shortcut functions. Below are a few examples:  + Tab (Activates next taskbar button)  + E (Explores My Computer)  + F (Finds Document)  + M (Minimizes All) Shift +  + M (Undoes Minimize All)  + R (Displays the Run... dialog box)
Application key		Opens a context menu (same as a right-click).







Hot Keys

The computer uses hotkey or key combinations to access most of the computer's controls like sreen brightness, volume output.

To activate hot keys, press and hold the **Fn** key before pressing the other key in the hot key combination.



Hot Key	Icon	Function	Description
Fn-F1	?	Hot key help	Displays help on hot keys.
Fn-F2		System Property	Displays the System Property.
Fn-F3		Power Options	Display the Power Options Properties used by the computer (function available if supported by operating system). See "Power management" on page 25.
Fn-F4	Z ^z	Sleep	Puts the computer in Sleep mode. See "Power management" on page 25.
Fn-F5		Display toggle	Switches display output between the display screen, external monitor (if connected) and both the display screen and external monitor.
Fn-F6		Screen blank	Turns the display screen backlight off to save power. Press any key to return.
Fn-F7		Touchpad toggle	Turns the internal touchpad on and off.
Fn-F8		Speaker toggle	Turns the speakers on and off.
Fn-F9		Volume up	Increases the speaker volume.

Hot Key	Icon	Function	Description
Fn- 		Volume down	Decreases the speaker volume.
Fn- 		Brightness up	Increases the screen brightness.
Fn- 		Brightness down	Decreases the screen brightness

The Euro Symbol

If your keyboard layout is set to United States-International or United Kingdom or if you have a keyboard with a European layout, you can type the Euro symbol on your keyboard.



NOTE: For US keyboard users: The keyboard layout is set when you first set up Windows. For the Euro symbol to work, the keyboard layout has to be set to United States-International.

To verify the keyboard type in Windows Millennium Edition and Windows 2000, follow the steps below:

1. Click on **Start, Settings, Control Panel**.
2. Double-click on **Keyboard**.
3. Click on the **Language** tab.
4. Verify that keyboard layout used for "En English (United States)" is set to United States-International. If not, select and click on **Properties**; then select **United States-International** and click on **OK**.
5. Click on **OK**.

To verify the keyboard type in Windows XP, follow the steps below:

1. Click on **Start, Control Panel**.
2. Double-click on **Regional and Language Options**.
3. Click on the **Language** tab and click on **Details**.
4. Verify that the keyboard layout used for "En English (United States)" is set to United States-International. If not, select and click on **ADD**; then select **United States-International** and click on **OK**.
5. Click on **OK**.

To type the Euro symbol:

1. Locate the Euro symbol on your keyboard.
2. Open a text editor or word processor.
3. Hold **Alt Gr** and press the Euro symbol.

NOTE: Some fonts and software do not support the Euro symbol. Please refer to www.microsoft.com/typography/faq/faq12.htm for more information.

Launch Keys

Located at the top of keyboard are five buttons. These buttons are called launch keys. They are designated as the mail button, the web browser button and two programmable buttons (P1 and P2).



Launch Key	Default application
P1	User-programmable
P2	User-programmable
P3	User-programmable
Email	Email application
Web browser	Internet browser application

E-mail Detection

Click right button at the Launch Manager icon on the taskbar and click on E-Mail Detection. In this dialog box, you have the option to enable/disable mail checking, set the time interval for mail checking, etc. If you already have an e-mail account, you can fill in User Name, Password and POP3 server in the dialog box. The POP3 Server is the mail server where you get your email.

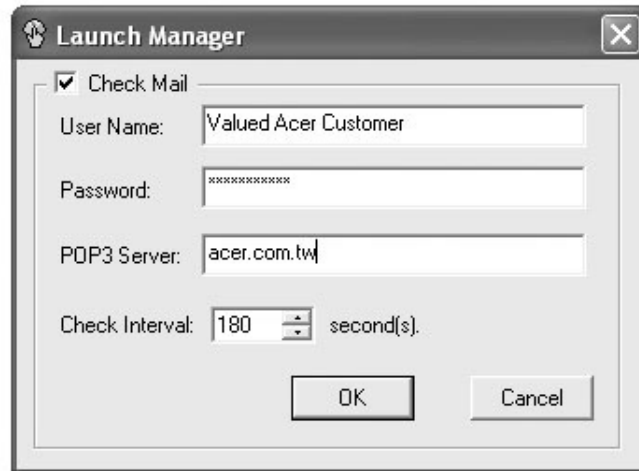

Aside from the email checking function, there is a mail button that is used to launch the email application. It is located above the keyboard right below the LCD.

Touchpad

The built-in touchpad is a pointing device that senses movement on its surface. This means the cursor responds as you move your finger on the surface of the touchpad. The central location on the palmrest provides optimal comfort and support.



NOTE: If you are using an external USB mouse, you can press **Fn-F7** to disable the touchpad.

Touchpad Basics

The following teaches you how to use the touchpad:



- Move your finger across the touchpad to move the cursor.
- Press the left (1) and right (3) buttons located on the edge of the touchpad to do selection and execution functions. These two buttons are similar to the left and right buttons on a mouse. Tapping on the touchpad produces similar results.
- Use the 4-way scroll (2) button (top/bottom/left/and right) to scroll.

Function	Left Button	Right Button	Scroll Button	Tap
Execute	Click twice quickly			Tap twice (at the same speed as double-clicking the mouse button)
Select	Click once			Tap once
Drag	Click and hold, then use finger to drag the cursor on the touchpad			Tap twice (at the same speed as double-clicking a mouse button) then hold finger to the touchpad on the second tap to drag the cursor
Access context menu		Click once		

Function	Left Button	Right Button	Scroll Button	Tap
Scroll			Click and hold the button in the desired direction (up/down/left/right)	

NOTE: Keep your fingers dry and clean when using the touchpad. Also keep the touchpad dry and clean. The touchpad is sensitive to finger movements. Hence, the lighter the touch, the better the response. Tapping too hard will not increase the touchpad's responsiveness.

Hardware Specifications and Configurations

Processor

Item	Specification
CPU type	Mobile Intel Pentium 4 at 2.40Ghz ~3.06Ghz or higher
CPU package	/μ -FCPGA package
CPU core voltage	1.468V (Full speed)

BIOS

Item	Specification
BIOS vendor	Phoenix
BIOS Version	V1.00
BIOS ROM type	Flash ROM
BIOS ROM size	512KB
BIOS package	PLCC
Supported protocols	ACPI 1.0b, PC Card 95, SM BIOS 2.3, EPP/IEEE 1284, ECP/IEEE 1284 1.7 & 1.9, PCI 2.2, PnP 1.0a, DMI 2.0, PS/2 keyboard and mouse, USB 2.0, VGA BIOS, CD-ROM bootable, IEEE 1394
BIOS password control	Set by setup manual

Second Level Cache

Item	Specification
Cache controller	Built-in CPU
Cache size	512KB
1st level cache control	Always enabled
2st level cache control	Always enabled
Cache scheme control	Fixed in write-back

System Memory

Item	Specification
Memory controller	ATI RC300M
Memory size	0MB (no on-board memory)
DIMM socket number	2 sockets
Supports memory size per socket	256MB, 512MB and 1G
Supports maximum memory size	2G (by two 1024MB DDR RAM module)
Supports DIMM type	DDR RAM
Supports DIMM Speed	333 MHz
Supports DIMM voltage	2.5V
Supports DIMM package	200-pin soDIMM
Memory module combinations	You can install memory modules in any combinations as long as they match the above specifications.

Memory Combinations

Slot 1	Slot 2	Total Memory
0MB	256MB	256MB
0MB	512MB	512MB
0MB	1024MB	1024MB
256MB	0MB	256MB
256MB	256MB	512MB
256MB	512MB	768MB
256MB	1024MB	1280MB
512MB	0MB	512MB
512MB	256MB	768MB
512MB	512MB	1024MB
512MB	1024MB	1536MB
1024MB	0MB	1024MB
1024MB	256MB	1280MB
1024MB	512MB	1536MB
1024MB	1024MB	2G

NOTE: Above table lists some system memory configurations. You may combine DIMMs with various capacities to form other combinations. On above table, the configuration of slot 1 and slot 2 could be reversed.

Modem Interface

Item	Specification
Data modem data baud rate (bps)	56K
Supports modem protocol	V.90/V92 MDC
Modem connector type	RJ11
Modem connector location	Rear panel

LAN Interface

Item	Specification
Chipset	RTL 8100C/8110S
Supports LAN protocol	10/100 Mbps
LAN connector type	RJ45
LAN connector location	Rear panel

Bluetooth-MODEM Interface

Item	Specification
Chipset	
Data throughput	200k bps (Blue-tooth)/56K bps (MODEM)
Protocol	Blue-tooth 1.1
Interface	USB 1.1+MDC
Connector type	RJ11 (MODEM)

Wireless Module 802.11b (optional device)

Item	Specification
Chipset	Realtek RTL8180L

Wireless Module 802.11b (optional device)

Item	Specification
Data throughput	11M bps
Protocol	802.11b
Interface	Mini-PCI type III

Five-in-One Card Reader

Item	Specification
Chipset	Phison PS1006C
Data throughput	USB 1.1
Protocol	Secure Digital (SD), SmartMedia, MultiMediaCard, Memory Stick, Compact Flash

Hard Disk Drive Interface

Item	Specification			
Vendor & Model Name	FUJITSU MHT2030AT TOSHIBA NEPTUNE MK3021GAS HGST MORAGA IC25N030ATMR04-0	TOSHIBA NEPTUNE MK4021GAS HGST MORAGA IC25N040ATMR04-0	FUJITSU MHT2060AT TOSHIBA NEPTUNE MK6021GAS HGST MORAGA IC25N060ATMR04-0	SEAGATE ST94011A
Capacity (GB)	30	40	60	40
Bytes per sector	512	512	512	512
Data heads	2	3	4	2 (Physical read/write head)
Drive Format				
Disks	1	2	2	1
Spindle speed (RPM)	4200 RPM	4200 RPM	4200 RPM	5400 RPM
Performance Specifications				
Buffer size	2048KB	2048KB	2048KB	2Mbyte
Interface	ATA-6 for FUJITSU ATA-5 for TOSHIBA MK series	ATA-5 for TOSHIBA MK series	ATA-6 for FUJITSU ATA-5 for TOSHIBA MK series	ATA-5
Max. media transfer rate (disk-buffer, Mbytes/s)	41.3 for FUJITSU 37.2 for Toshiba 43.7 for Hitachi	37.2 for Toshiba 43.7 for Hitachi	41.3 for FUJITSU 37.2 for Toshiba 43.7 for Hitachi	58 for Seagate
Data transfer rate (host-buffer, Mbytes/s)	100 MB/Sec. Ultra DMA mode-5	100 MB/Sec. Ultra DMA mode-5	100 MB/Sec. Ultra DMA mode-5	100 MB/Sec. Ultra DMA mode-5
DC Power Requirements				
Voltage tolerance	5V(DC) +/- 5%	5V(DC) +/- 5%	5V(DC) +/- 5%	5V(DC) +/- 5%

DVD/CDRW Interface

Item	Specification
Vendor & model name	DVD/CDRW COMBO MODULE QSI SBW-242 DVD/CDRW COMBO MODULE LITEON LSC-24082K

DVD/CDRW Interface

Item	Specification	
Performance Specification	With CD Diskette	With DVD Diskette
Transfer rate (KB/sec)	Sustained: Max 3.6Mbytes/sec	Sustained: Max 10.8Mbytes/sec
Data Buffer Capacity	128 KBytes	
Interface	IDE/ATAPI (ATA/ATAPI-5, MMC-3 and SFF8090 Ver5, Revision 1.2 for Liteon)	
Applicable disc format	DVD: DVD-ROM (DVD-5, DVD-9, DVD-10, DVD-18), DVD-R, DVD+R, DVD-RW, DVD+RW, DVD-RAM (optional) CD: CD-ROM Mode-1, CD-ROM XA, Mixed Mode CD-ROM (Audio and Data Combined), Photo-CD (Single and Multi-session) CD-1, Video CD, CD-Plus/CD-Extra, CD-Text, Super Video CD, CD-R disc, CD-RW disc, CD-Audio, Video CD	
Loading mechanism	Load: Manual Release: (a) Electrical Release (Release Button) (b) Release by ATAPI command (c) Emergency Release	
Power Requirement		
Input Voltage	5 V +/- 5 % (Operating)	

DVD-RW Interface

Item	Specification	
Vendor & model name	DVD-RW MODULE TEAC DV-W22E DVD-RW MODULE PIONEER DVR-K11	
Performance Specification	With CD Diskette	With DVD Diskette
Transfer rate (KB/sec)	Sustained: Max 3.6Mbytes/sec	Sustained: Max 10.8Mbytes/sec
Data Buffer Capacity	128 KBytes	
Interface	IDE/ATAPI	
Applicable disc format	DVD: DVD-ROM (DVD-5, DVD-9, DVD-10, DVD-18), DVD-R, DVD-RW, DVD-Video CD: Multi-session Photo CD, CD-I, Video CD, CD Extra (CD Plus), CD-TEXT	
Loading mechanism	Load: Manual Release: (a) Electrical Release (Release Button) (b) Release by ATAPI command (c) Emergency Release	
Power Requirement		
Input Voltage	5 V +/- 5 % (Operating)	

Speaker

Item	Specification
Number of speaker	2
Rating	1W, max; 4 ohm
Connector type	Headphone out, microphone in and line-in

Video Interface

Item	Specification
Chipset	ATI Radeon 9200IGP

Video Interface

Item	Specification
Interface	Integration
Supports ZV (Zoomed Video) port	No
Maximum resolution LCD	1600X1200 (UXGA)
Maximum resolution CRT	2048X1536@75HZ

Audio Interface

Item	Specification
Audio Controller	Realtek ALC202A
Audio onboard or optional	Built-in
Mono or Stereo	Stereo
Resolution	20 bit stereo Digital to analog converter 18 bit stereo Analog to Digital converter
Compatibility	AC97
Mixed sound source	Line-in, CD
Voice channel	8/16-bit, mono/stereo
Sampling rate	44,1 KHz (48K byte for AC97 interface)
Internal microphone	Yes
Internal speaker / Quantity	Yes/2
Supports PnP IRQ	IRQ10

Video Resolutions Mode (for both LCD and CRT)

Resolution	16 bits (High color)	32 bits (True color)
480x600	Yes	Yes
800x600	Yes	Yes
1024x768	Yes	Yes
1152x864	Yes	Yes
1280x1024	Yes	Yes
1400x1050 (SXGA+panel only)	Yes	Yes

Video Memory

Item	Specification
Fixed or Upgradeable	Fixed
Vendor	Samsung/ Hynix
Memory size	Default 16M (Adjust via BIOS)
Interface	DDR

Parallel Port

Item	Specification
Parallel port controller	SmsC LPC47N227

Parallel Port

Item	Specification
Number of parallel port	1
Location	Rear side
Connector type	25-pin D-SUB
Parallel port function control	Enable/Disable/Auto (BIOS or operating system chooses configuration) by BIOS Setup Note: Depending on your operating system, disabling an unused device may help free system resources for other devices.
Supports ECP/EPP/Bi-directional/Output only (PS/2 compatible)	Yes (set by BIOS setup) Note: When Mode is selected as EPP mode, "3BCh" will not be available.
Optional ECP DMA channel (in BIOS Setup)	DMA channel 3
Optional parallel port I/O address (in BIOS Setup)	378h, 278h, 3BCH
Optional parallel port IRQ (in BIOS Setup)	IRQ7, IRQ5

USB Port

Item	Specification
Chipset	VIA_VT6202
USB Compliancy Level	2.0
OHCI	USB 2.0
Number of USB port	3
Location	Two at rear side; one at right side
Serial port function control	Enable/Disable by BIOS Setup

IEEE 1394 Port

Item	Specification
Chipset	VIA-VT6301
InterfaceUSB Compliancy Level	IEEE 1394 1.0
Number of IEEE 1394 port	1
Location	Rear side
Connector type	IEEE 1394

PCMCIA Port

Item	Specification
PCMCIA controller	ENE CB1420
Supports card type	Two Type-II or one Type III
Number of slots	Two type-II
Access location	Right panel
Supports ZV (Zoomed Video) port	No ZV support
Supports 32 bit CardBus	Yes (IRQ10)

System Board Major Chips

Item	Controller
Core logic	ATI Mobility Radeon 9000IGP and ATI IXP 150

System Board Major Chips

Item	Controller
VGA	ATi M9+X
LAN	Realtek 8100C/8110S
IEEE 1394	VIA_VT6301
USB 2.0	VIA_VT6202
Super I/O controller	SMC 47N227
MODEM	International LU97 Chipset (Scorpio+CSP1037B)
Blue tooth	CSR BC02 Bluetooth chip set
Wireless 802.11 b	Realtek RTL8180L
PCMCIA	ENE CB1420
Audio	Realtek ALC202A
Five-in-one card reader	Phison PS1006C
Touchpad	Synaptic

Keyboard

Item	Specification
Keyboard controller	EC NS87591L
Keyboard vendor & model name	DARFON
Total number of keypads	84/85 key
Windows logo key	Yes
Internal & external keyboard work simultaneously	No Note: Internal and external keyboard can not work simultaneously by software specification.

Battery

Item	Specification
Vendor & model name	SANYO (4UR18650F-2-QC-ZG1)
Battery Type	Li-ion
Pack capacity	6300 Ah
Cell voltage	3.7V/cell
Number of battery cell	8
Package configuration	4 cells in series, 2 series in parallel
Package voltage	14.8

LCD

Item	Specification	
Vendor & model name	AU B141XG05 CMO X141X7-L07 Samsung LTN141XB	AU B150PG01 CMO N150P2-L04 Hitachi TX38D91VC1FAB
Mechanical Specifications		
LCD display area (diagonal, inch)	14.1	15.0
Display technology	TFT	TFT
Resolution	XGA (1024x768)	SXGA+ (1400x1050)

LCD

Item	Specification	
Supports colors	262K	262K
Optical Specification		
Brightness control	keyboard hotkey	keyboard hotkey
Contrast control	No	No
Electrical Specification		
Supply voltage for LCD display (V)	3.3	3.3

LCD Inverter

Item	Specification
Vendor & model name	Ambit/Tamura
Brightness conditions	Vadj=3.3V
Input voltage (V)	14.4
Input current (mA)	410 (max)
Output voltage (V, rms)	1400 (no load)
Output current (mA, rms)	5.6~5.4
Output voltage frequency (k Hz)	55~58K Hz

AC Adaptor

Item	Specification
Model number	API 90W (3 PIN) / API1AD43-380 LITEON 90W (3 PIN) PA-1900-05CA
Input rating	90VAC to 264VAC, 47Hz to 63Hz
Output rating	75W, 19V (18.8V, min to 20V, max), 4A (0A, min to 4A, max)

System Power Management

ACPI mode	Power Management
Mech. Off (G3)	All devices in the system are turned off completely.
Soft Off (G2/S5)	OS initiated shutdown. All devices in the system are turned off completely.
Working (G0/S0)	Individual devices such as the CPU and hard disk may be power managed in this state.
Suspend to RAM (S3)	CPU set power down VGA Suspend PCMCIA Suspend Audio Power Down Hard Disk Power Down CD-ROM Power Down Super I/O Low Power mode
Save to Disk (S4)	Also called Hibernation state. System saves all system states and data onto the disk prior to power off the whole system.

Memory Address Map

Memory Address	Size	Function
00100000h-000F0000h	512 KB	System BIOS

Memory Address Map

Memory Address	Size	Function
000CFFFFh-000C0000h		VGA BIOS
00009FFFFh-00000000h	640KB	Conventional memory

I/O Address Map

I/O Address	Function
0000-001F, 0080-008F, 00C0-00DF, 040B, 04D6	DMA controller
0000-0CF7	PCI bus
0020-0021, 00A0-00A1, 0C00-0C01, 04D0-04D1	Programmable interrupt controller
0040-0043	System timer
0060, 0064	Standard 101/102-Key or Microsoft Natural PS/2 keyboard
0061	System speaker
0062, 0066	Microsoft ACPI-Compliant Embedded Controller
0070-0073	System CMOS/real time clock
00F0-00FE	Numeric data processor
0170-0177, 0376	Secondary IDE Channel
01F0-01F7, 03F6	Primary IDE Channel
0274-0277, 0279, 0A79,	ISAPNP Read Data Port
0378-037B, 0778-077B	ECP Printer Port (LPT1)
03B0-03BB, 03C0-03DF, 9000-90FF	ATI RS300/RS300M Accelerated Graphics Port; Mobility Radeon 9200
03F0-03F5, 03F7	Standard floppy disk controller
0D00-FFFF	PCI bus
8040-804F	ATI SMBus
A000-A0FF	Realtek RTL8139/810x Family Fast Ethernet NIC
A400-A47F	VIA OHCI Compliant IEEE 1394 Host Controller
A480-A49F, A4A0-A4BF	VIA Rev 5 or later USB Universal Host Controller
F900-F9FF	ENE CB1420 Cardbus Controller
FFF0-FFFF	Standard Dual Channel PCI IDE Controller

IRQ Assignment Map

Interrupt Channel	System timer
IRQ00	System time
IRQ01	Keyboard
IRQ02	Programmable Interrupt Controller
IRQ03	FIR
IRQ04	Communications Port (COM1)
IRQ05	Winbond SD Controller
IRQ06	Standard Floppy Disk Controller
IRQ07	ECP Printer Port (LPT1)
IRQ08	Real Time Clock
IRQ09	SCI+PCI devices (LAN/Universal Serial Bus/PCI Audio/MODEM/PCMCIA/VGA)
IRQ10	Free
IRQ11	Winbond MS Controller

IRQ Assignment Map

Interrupt Channel	System timer
IRQ12	PS/2 Mouse
IRQ13	Numeric data processor
IRQ14	1st EIDE device (hard disk)
IRQ15	2nd EIDE device (optical drive)
IRQ16	ENE CB1420 Cardbus Controller MOBILITY RADEON 9200 VIA OHCI Compliant IEEE 1394 Host Controller VIA Rev 5 or later USB Universal Host Controller
IRQ17	Agere Systems AC'97 Audio ENE CB1420 Cardbus Controller Realtek AC'97 Audio VIA Rev 5 or later USB Universal Host Controller
IRQ18	VIA USB Enhanced Host Controller
IRQ19	Realtek RTL8139/810x Family Fast Ethernet NIC Standard OpenHCD USB Host Controller
IRQ21	Microsoft ACPI-Compliant System

DMA Channel Assignment

Item	Specification
Channel 2	Standard floppy disk controller
Channel 3	ECP printer port (LPT1)
Channel 4	DMA controller

System Utilities

BIOS Setup Utility

The BIOS Setup Utility is a hardware configuration program built into your computer's BIOS (Basic Input/Output System).

Your computer is already properly configured and optimized, and you do not need to run this utility. However, if you encounter configuration problems, you may need to run Setup. Please also refer to Chapter 4 Troubleshooting when problem arises.

To activate the BIOS Utility, press **F2** during POST (when "Press <F2> to enter Setup" message is prompted on the bottom of screen).

Press **F2** to enter setup. Press <F12> during POST to enter multi-boot menu. In this menu, user can change boot device without entering BIOS SETUP Utility.

PhoenixBIOS Setup Utility					
Information	Main	Advanced	Security	Boot	Exit
					Item specific Help
CPU Type		Intel® Pentium® 4			
CPU Speed		3.06 GHz			
Floppy Drive:		1.44/1.25 MB 3 1/2 "			
IDE1 Model Name		TOSHIBA MK3018GAP-(PM)			
IDE1 Serial Number		Y2554027T			
IDE2 Model Name		Slimtype DVD-ROM LSD-081-(SM)			
IDE2 Serial Number					
System BIOS Ver:		TM540 V1.00			
VGA BIOS Ver:		ATI M9+XC V0.1			
KBC Ver:		V1.00			
Serial Num:		xxxxxxxxxxxxxxxxxxxx		22 Byte	
Asset Tag Number:		N/A		32 Byte	
Product Name:		TravelMate 540		16 Byte	
Manufacturer Name:		Acer		16 Byte	
UUID:		xxxxxxxxxxxxxxxxxxxx		16 Byte	
F1 Help	↑↓ Select Item	F5/F6 Change Values	F9 Setup defaults		
Esc Exit	←→ Select Menu	Enter Select ▸ Sub-Menu	F10 Save and Exit		

Navigating the BIOS Utility

There are six menu options: Information, Main, Advanced, Security, Boot, and Exit.

Follow these instructions:

- To choose a menu, use the cursor left/right keys (← →).
- To choose a parameter, use the cursor up/down keys (↑ ↓).
- To change the value of a parameter, press F5 or F6.
- A plus sign (+) indicates the item has sub-items. Press ENTER to expand this item.
- Press ESC while you are in any of the menu options to go to the Exit menu.
- In any menu, you can load default settings by pressing F9. You can also press F10 to save any changes made and exit the BIOS Setup Utility.

NOTE: You can change the value of a parameter if it is enclosed in square brackets. Navigation keys for a particular menu are shown on the bottom of the screen. Help for parameters are found in the Item Specific Help part of the screen. Read this carefully when making changes to parameter values.

This menu provides you the information of the system.

Information

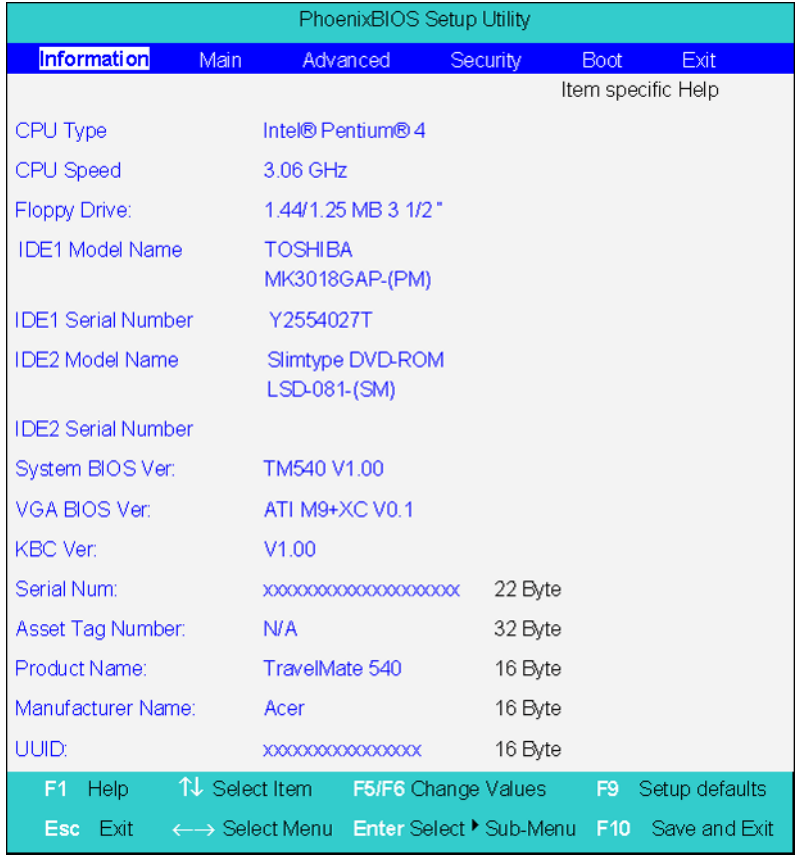

Parameter	Description
Floppy Disk Drive	Shows floppy drive type information. The Floppy Drive status is auto detected by system. 1.44MB, 3 1/2" If there exists floppy drive. Not installed If there is no floppy drive.
IDE1 Model Name	Shows the Model name of HDD installed on Primary IDE master. The hard disk model name is automatically detected by the system. If there is no hard disk present or unknown type, " None " should be shown on this field.
IDE1 Serial #	This field display the Serial number of HDD installed on Primary IDE master. If no Hard disk or other devices are installed on Primary IDE master, then it will display a blank line.
IDE2 Model Name	This item will show the Model name of device installed on Secondary IDE master. The hard disk or CD-ROM model name is automatically detected by the system. If there is no hard disk or CD-ROM present or unknown type, " None " should be shown on this field.
IDE2 Serial #	This item will show the Serial number of HDD installed on Secondary IDE master. If no hard disk or other devices are installed on Primary IDE master, then it will display a blank line.
Serial Number	This field displays the serial number of this unit.
UUID Number	UUID=32bytes

Main

The Main screen displays a summary of your computer hardware information, and also includes basic setup parameters. It allows the user to specify standard IBM PC AT system parameters.

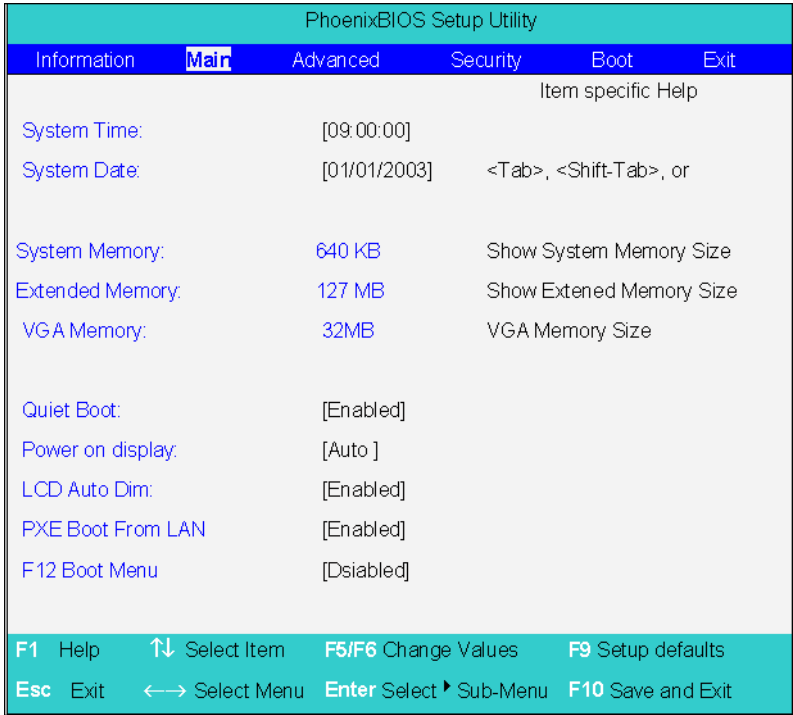

NOTE: The screen above is for reference only. Actual values may differ.

The table below describes the parameters in this screen. Settings in **boldface** are the default and suggested parameter settings.

Parameter	Description	Format/Option
System Time	Sets the system time.	Format: HH:MM:SS (hour:minute:second) System Time
System Date	Sets the system date.	Format MM/DD/YYYY (month/day/year) System Date
System Memory	This field reports the memory size of the system. Memory size is fixed to 640MB	
Extended Memory	This field reports the memory size of the extended memory in the system. Extended Memory size=Total memory size-1MB	
VGA Memory	Shows the VGA memory size. The default value is set to 16MB	Option: 16 /32MB
Quiet Boot	Determines if Customer Logo will be displayed or not; shows Summary Screen is disabled or enabled. Enabled: Customer Logo is displayed, and Summary Screen is disabled. Disabled: Customer Logo is not displayed, and Summary Screen is enabled.	Option: Enabled or Disabled
Power on display	Auto: During power process, the system will detect if any display device is connected on external video port. If any external display device is connected, the power on display will be in CRT (or projector) only mode. Otherwise it will be in LCD only mode. Both: Simultaneously enable both the integrated LCD screen and the system's external video port (for an external CRT or projector).	Option: Auto or Both
LCD Auto Dim	Determines if the system will automatically dim the LCD brightness in order to save power when AC is not present.	Option: Enabled or Disabled
PXE (Preboot Execution Environment) Boot From LAN	Indicates that whether the notebook can boot from LAN or not.	Option: Enabled or Disabled
F12 Boot Menu	Determines if the OEM POST screen will have "Press <F12> Change Boot Device" or not during user's quiet boot.	Option: Enabled or Disabled

NOTE: The sub-items under each device will not be shown if the device control is set to disable or auto. This is because the user is not allowed to control the settings in these cases.

Advanced

The Advanced menu screen contains parameters involving your hardware devices. It also provides advanced settings of the system.

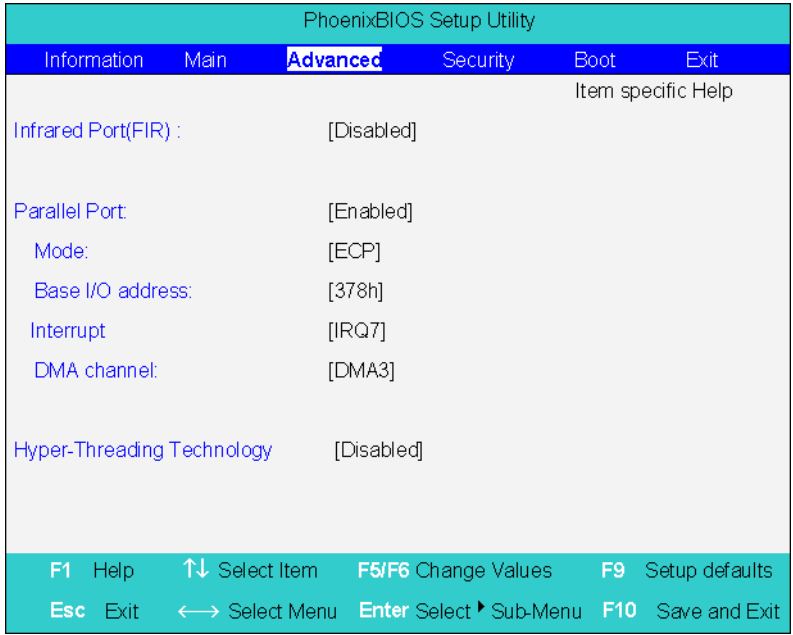

The table below describes the parameters in the screen. Settings in **boldface** are the default and suggested parameter settings.

Parameter	Description	Options
Infrared Port (FIR)	Enables, disables or auto detects the infrared port.	Enabled /Disabled/Auto
Base I/O address/IRQ	Sets I/O address of the infrared port.	3F8h/IRQ4; 2F8h/IRQ3; 3E8h/IRQ4; 2E8h/IRQ3
DMA	Sets a DMA channel of the infrared port.	DMA 1/DMA 3
Parallel Port	Enables, disables or auto detects the parallel port.	Enabled /Disabled/Auto
Mode	Sets the operation mode of the parallel port.	ECP , EPP, Output only or Bi-directional
Base I/O address	Sets the I/O address of the parallel port. This parameter is enabled only if Mode is set to ECP or Bi-directional. This parameter is enabled only if Mode is set to ECP.	378 /278/3BC
Interrupt	Sets the interrupt request of the parallel port.	IRQ7 /IRQ5
DMA channel	Sets a DMA channel for the printer to operate in ECP mode. This parameter is enabled only if Mode is set to ECP.	DMA3 /DMA1
Hyperthreading technology	This only support CPU 3.06G or above. BIOS should automatically hide this selection when detecting the CPU frequency is below 3.06G or the CPU does not support Hyperthreading technology. Even if Hyperthreading technology does not support on certain system configuration, this value is set "disabled" as default value.	Enabled/Disabled

Security

The Security screen contains parameters that help safeguard and protect your computer from unauthorized use.

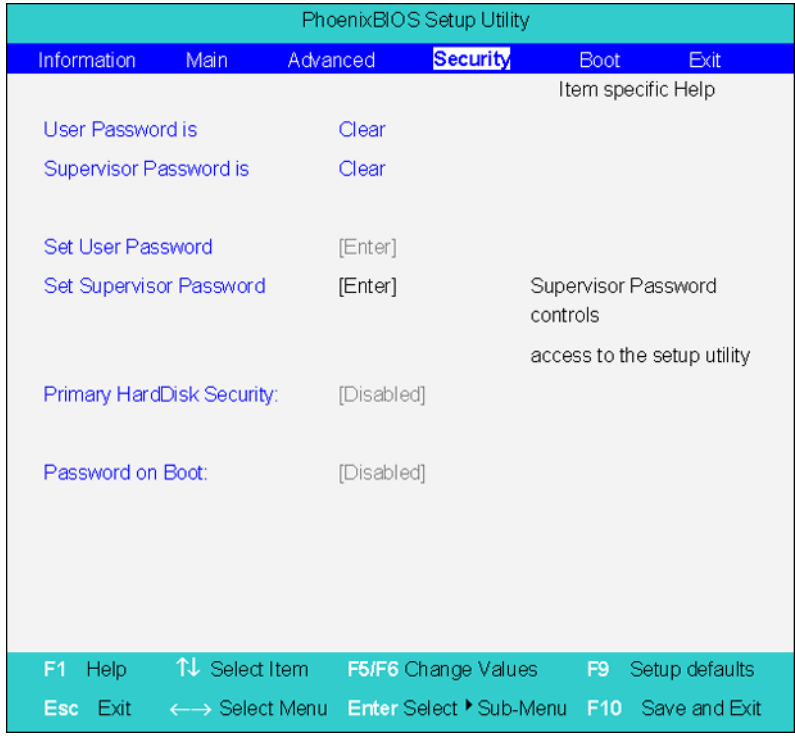

The table below describes the parameters in this screen. Settings in **boldface** are the default and suggested parameter settings.

Parameter	Description	Option
User Password is	Shows the setting of the user password.	Clear or Set
Supervisor Password is	Shows the setting of the Supervisor password	Clear or Set
Set User Password	Press Enter to set the user password. When set, this password protects the BIOS Setup Utility from unauthorized access.	
Set Supervisor Password	Press Enter to set the supervisor password. When set, this password protects the BIOS Setup Utility from unauthorized access.	
Primary Harddisk Security	This feature is available to user when Supervisor password is set. Password can be written on HDD only when Supervisor password or user password is set and password on HDD is set to enabled. Supervisor Password is written to HDD only when Supervisor password is being set. User password is written to HDD when both passwords are set. When both Supervisor and user password are present, both passwords can unlock the HDD.	Disabled or Enabled
Password on Boot	Defines whether a password is required or not while the events defined in this group happened. The following sub-options are all requires the Supervisor password for changes and should be grayed out if the user password was used to enter setup.	Disabled or Enabled

NOTE: When you are prompted to enter a password, you have three tries before the system halts. Don't forget your password. If you forget your password, you may have to return your notebook computer to your dealer to reset it.

Setting a Password

Follow these steps as you set the user or the supervisor password:

1. Use the **↑** and **↓** keys to highlight the Set Supervisor Password parameter and press the **ENTER** key. The Set Supervisor Password box appears:

Set Supervisor Password

Enter New Password []

Confirm New Password []

2. Type a password in the "Enter New Password" field. The password length can not exceeds 8 alphanumeric characters (A-Z, a-z, 0-9, not case sensitive). Retype the password in the "Confirm New Password" field.

IMPORTANT: Be very careful when typing your password because the characters do not appear on the screen.

3. Press **ENTER**.
After setting the password, the computer sets the User Password parameter to "Set".
4. If desired, you can opt to enable the Password on boot parameter.
5. When you are done, press **F10** to save the changes and exit the BIOS Setup Utility.

Removing a Password

Follow these steps:

1. Use the **↑** and **↓** keys to highlight the Set Supervisor Password parameter and press the **ENTER** key. The Set Password box appears:

Set Supervisor Password

Enter current password []

Enter New Password []

Confirm New Password []

2. Type the current password in the Enter Current Password field and press **ENTER**.
3. Press **ENTER** twice **without** typing anything in the Enter New Password and Confirm New Password fields. The computer then sets the Supervisor Password parameter to “Clear”.
4. When you have changed the settings, press **F10** to save the changes and exit the BIOS Setup Utility.

Changing a Password

1. Use the **↑** and **↓** keys to highlight the Set Supervisor Password parameter and press the **ENTER** key. The Set Password box appears:

Set Supervisor Password

Enter current password []

Enter New Password []

Confirm New Password []

2. Type the current password in the Enter Current Password field and press **ENTER**.
3. Type a password in the Enter New Password field. Retype the password in the Confirm New Password field.
4. Press **ENTER**. After setting the password, the computer sets the User Password parameter to “Set”.
5. If desired, you can enable the Password on boot parameter.
6. When you are done, press **F10** to save the changes and exit the BIOS Setup Utility.

If the verification is OK, the screen will display as following.

Setup Notice

Changes have been saved.

[continue]

The password setting is complete after the user presses **F10**.

If the current password entered does not match the actual current password, the screen will show you the Setup Warning.

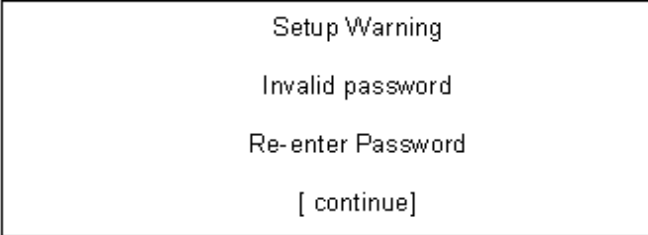

Setup Warning
Invalid password
Re-enter Password
[continue]

If the new password and confirm new password strings do not match, the screen will display the following message.

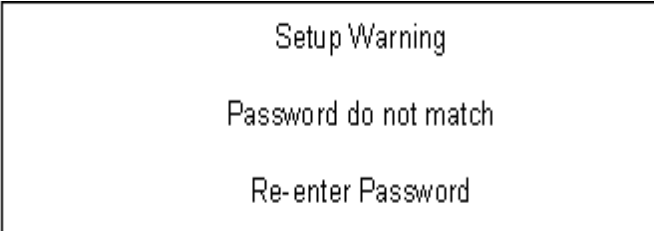

Setup Warning
Password do not match
Re-enter Password

Boot

This menu allows the user to decide the order of boot devices to load the operating system. Bootable devices includes the distette drive in module bay, the onboard hard disk drive and the CD-ROM in module bay.

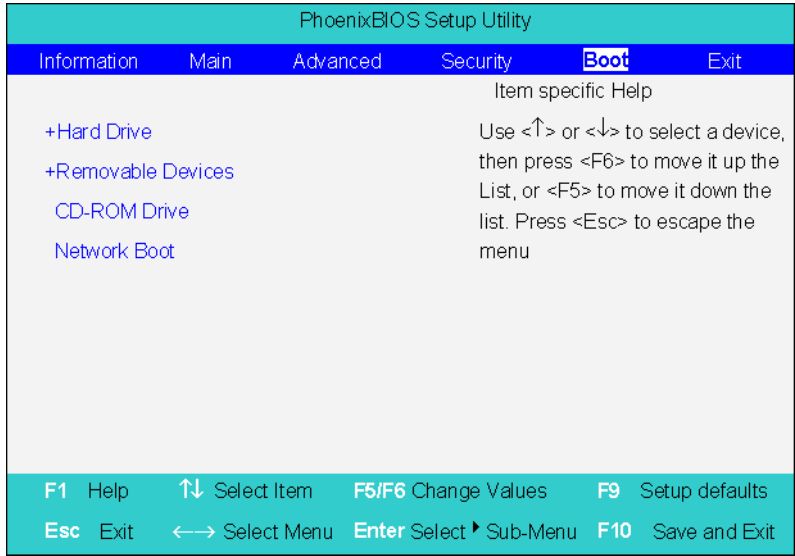

Exit

The Exit screen contains parameters that help safeguard and protect your computer from unauthorized use.

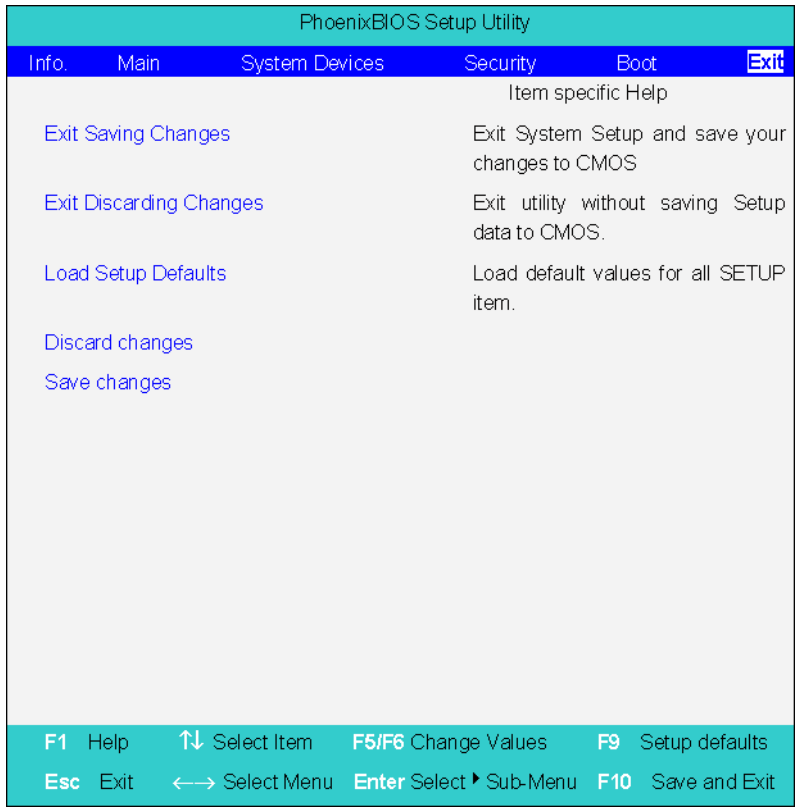

The table below describes the parameters in this screen.

Parameter	Description
Exit Saving Changes	Exit System Setup and save your changes to CMOS.
Exit Discarding Changes	Exit utility without saving setup data to CMOS.
Load Setup Default	Load default values for all SETUP item.
Discard Changes	Load previous values from CMOS for all SETUP items.
Save Changes	Save Setup Data to CMOS.

BIOS Flash Utility

The BIOS flash memory update is required for the following conditions:

- New versions of system programs
- New features or options
- Restore a BIOS when it becomes corrupted.

Use the Phlash utility to update the system BIOS flash ROM.

NOTE: If you do not have a crisis recovery diskette at hand, then you should create a **Crisis Recovery Diskette** before you use the Phlash utility.

NOTE: Do not install memory-related drivers (XMS, EMS, DPMS) when you use the Phlash.

NOTE: Please use the AC adaptor power supply when you run the Phlash utility. If the battery pack does not contain enough power to finish BIOS flash, you may not boot the system because the BIOS is not completely loaded.

Follow the steps below to run the Phlash.

1. Prepare a bootable diskette.
2. Copy the Phlash utilities to the bootable diskette.
3. Then boot the system from the bootable diskette. The Phlash utility has auto-execution function.

Machine Disassembly and Replacement

This chapter contains step-by-step procedures on how to disassemble the notebook computer for maintenance and troubleshooting.

To disassemble the computer, you need the following tools:

- Wrist grounding strap and conductive mat for preventing electrostatic discharge
- Philips screw driver
- Plastic flat head screwdriver
- Plastic tweezers
- Hex screw driver

NOTE: The screws for the different components vary in size. During the disassembly process, group the screws with the corresponding components to avoid mismatch when putting back the components. When you remove the middle cover, please be careful not to scrape the cover.

General Information

Before You Begin

Before proceeding with the disassembly procedure, make sure that you do the following:

1. Turn off the power to the system and all peripherals.
2. Unplug the AC adapter and all power and signal cables from the system.
3. Remove the battery pack.

NOTE: TravelMate 540 series product uses mylar or tape to fasten the FFC/FPC/connectors/cable, you may need to tear the tape or mylar before you disconnect different FFC/FPC/connectors.

NOTE: If you are disassembling a wireless unit, please remove the two screws that secure the mini PCI cover. Then disconnect the wireless antennas before you detach the entire LCD module.

Disassembly Procedure Flowchart

The flowchart on the succeeding page gives you a graphic representation on the entire disassembly sequence and instructs you on the components that need to be removed during servicing. For example, if you want to remove the system board, you must first remove the keyboard, then disassemble the inside assembly frame in that order.

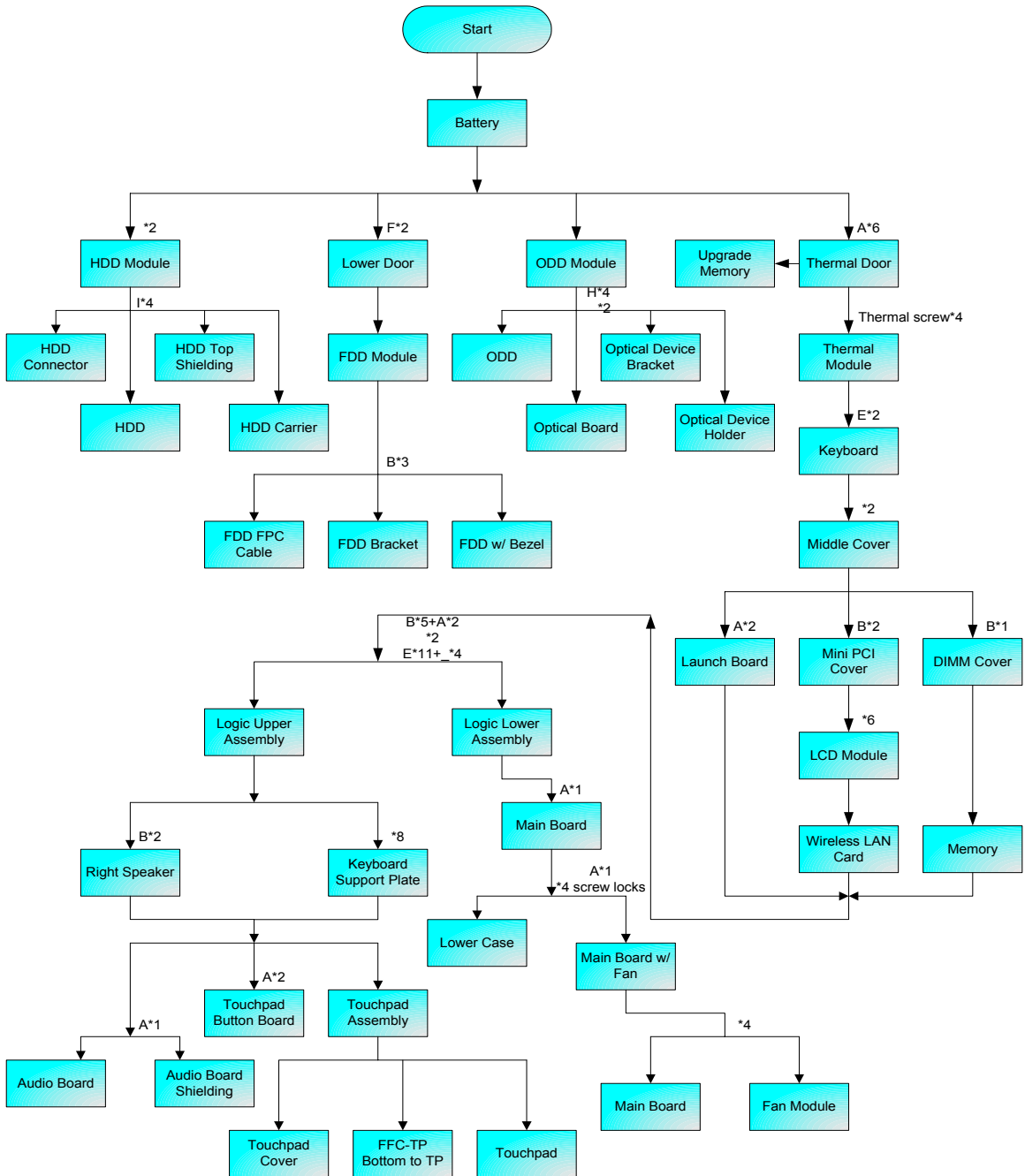

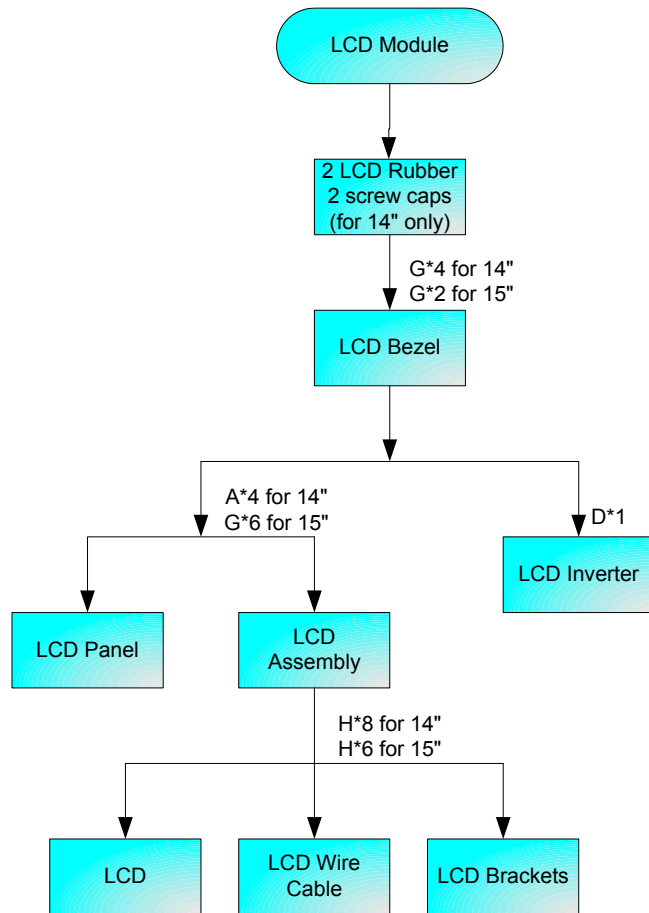

Screw List

Item	Description
A	SCREW M2.5 x 4-ZK
B	SCREW M2.5 x 3-NI
C	SCREW LOCK
D	SCREW M2.0 x 3-NI
E	SCREW M2.5 x 18-ZK
F	SCREW M2.5 x 7-ZK
G	SCREW M2.5 x 6-NI
H	SCREW M2.0 x 2.5-NI
I	SCREW M3.0 x 3 -NI
J	SCREW M2.5 x 5
K	SCREW M2.0 x 2.5
L	SCREW M2.0 X 0.4+6R
M	TPB2 x 4.5

Removing the Battery Pack

1. Slide the battery latch.
2. Then remove the battery.

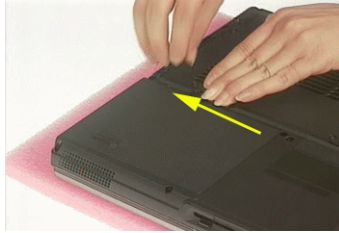

Removing the HDD Module/FDD Module/Optical Module/CPU/Middle Cover and LCD Module

Removing the HDD Module

1. Remove the two screws holding the HDD module.
2. Take out the HDD module.

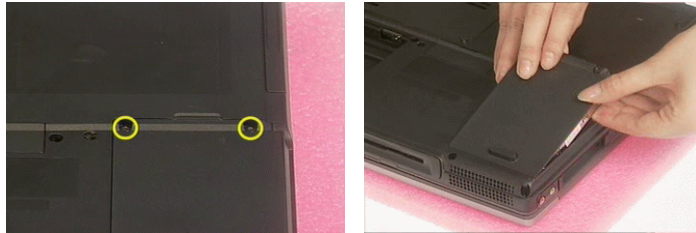

Removing the Optical Disc Drive Module

1. Slide the FDD latch then remove the module.



Removing the FDD (Card Reader) Module

1. Remove the lower door.
2. Remove the two screws that fasten the FDD module.

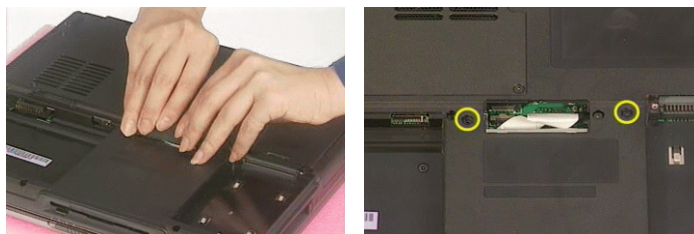

3. Disconnect the FDD cable.
4. Then take out the FDD module from the main unit.

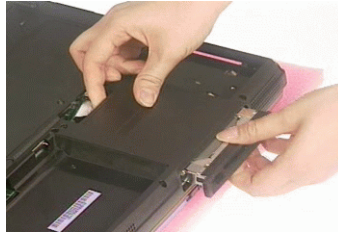
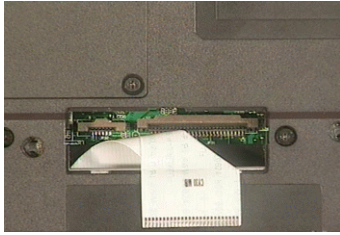

Removing the CPU

1. Remove the six screws that secure the thermal door.
2. Take the thermal door off the main unit.
3. Remove the four screws holding the thermal module.

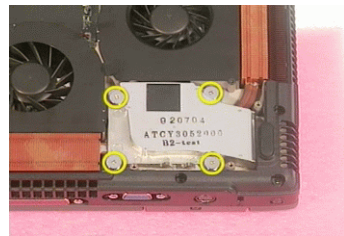
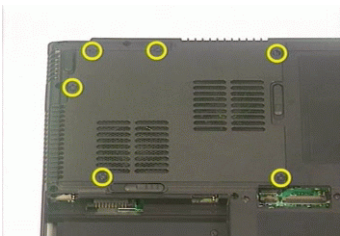

4. Take out the thermal module.
5. Release the CPU lock.
6. Take out the CPU from the socket..

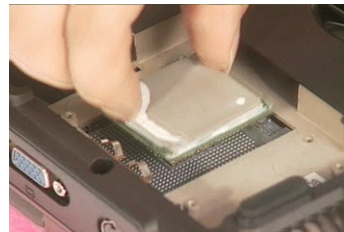
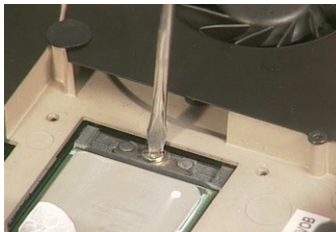
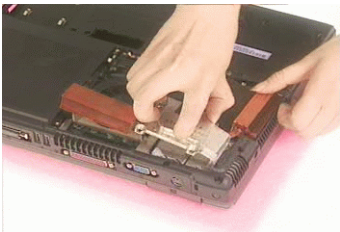

Removing the Middle Cover

1. Please remove the six screws holding the thermal door, then remove the thermal door before you remove the middle cover.
2. Take out the thermal cap as shown.
3. Remove the two screws holding the keyboard on the bottom.
4. Release the keyboard locks as shown..

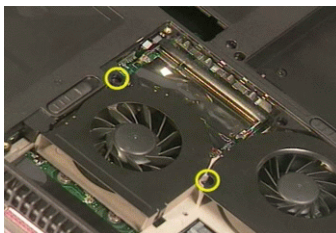
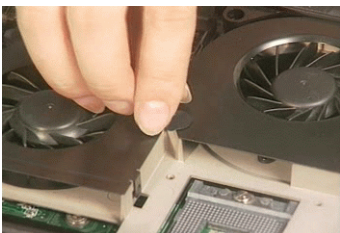

5. Disconnect the keyboard cable then remove the keyboard.
6. Remove the two screws holding the middle cover.
7. Then detach the middle cover carefully..

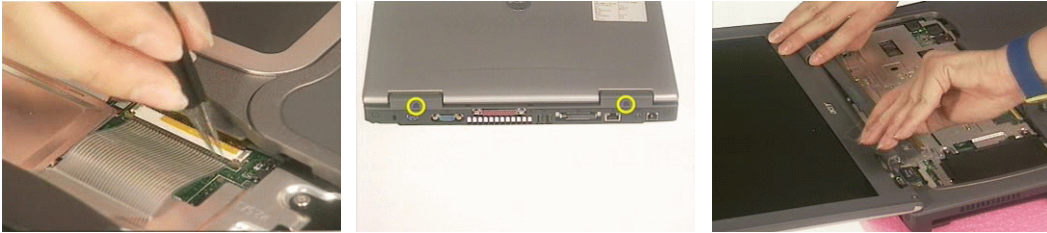

Removing the LCD Module

1. See “Removing the Middle Cover” on page 55.
2. Tear off the mylar fastening the LCD inverter cable.
3. Disconnect the inverter cable.

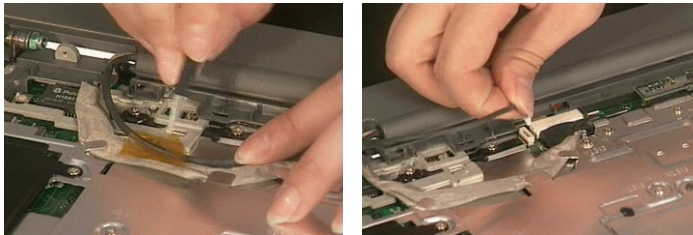

4. Remove the screw holding the LCD wire cable.
5. Take out the LCD wire cable from the fastening hooks as shown.
6. Disconnect the LCD wire cable.

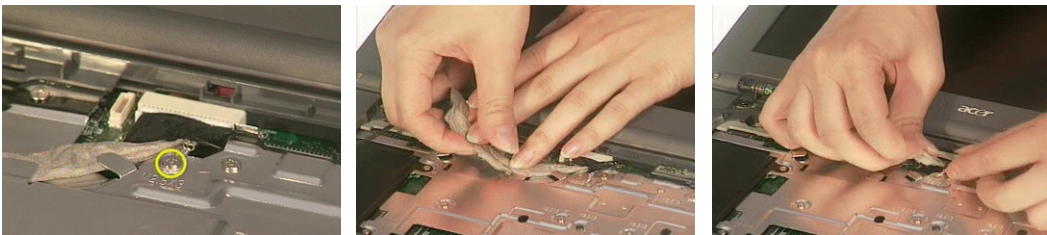

7. Remove the four screws as shown; two on each side.
8. Remove the two screws holding the LCD hinge; one on each side.
9. Then detach the entire LCD module..



NOTE: If you are disassembling a wireless unit, please remove the two screws that secure the mini PCI cover. Then disconnect the wireless antennas before you detach the entire LCD module.

Disassembling the Main Unit

Separate the main unit into the logic upper and the logic lower assembly

1. Remove the two screws holding the launch board.
2. Detach the launch board.
3. Then disconnect the microphone cable.



4. Remove the screw holding the DIMM cover then take out the DIMM cover.
5. Pop out the memory and remove it.
6. Turn over the keyboard. Disconnect the keyboard FFC then remove the keyboard.



7. Remove the three screws that secure the keyboard support plate.
8. Remove the two screws as shown.
9. Disconnect the main board to touchpad button board FFC.

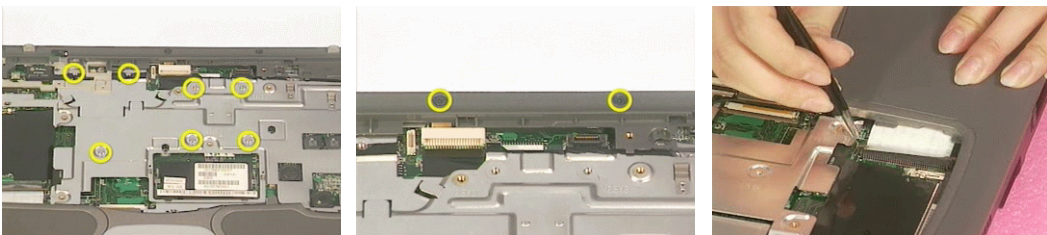

10. Remove the 15 screws on the bottom.
11. Then detach the logic upper assembly.

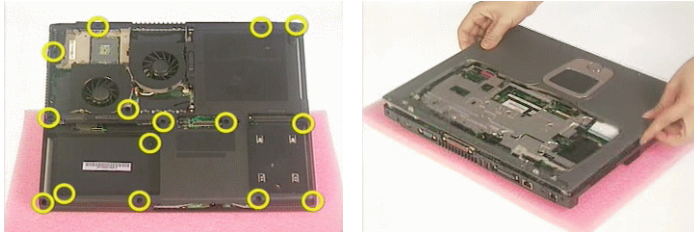

Disassembling the logic upper assembly

1. Disconnect the touchpad button board to touchpad FFC.
2. Tear off the mylar fastening the main board to touchpad button board FFC.
3. Detach the front bezel from the main unit.

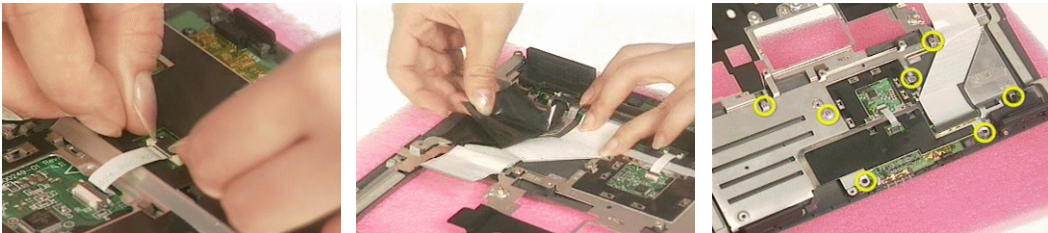

4. Remove one screw as shown.
5. Detach the keyboard support plate.
6. Disconnect the speaker cable.

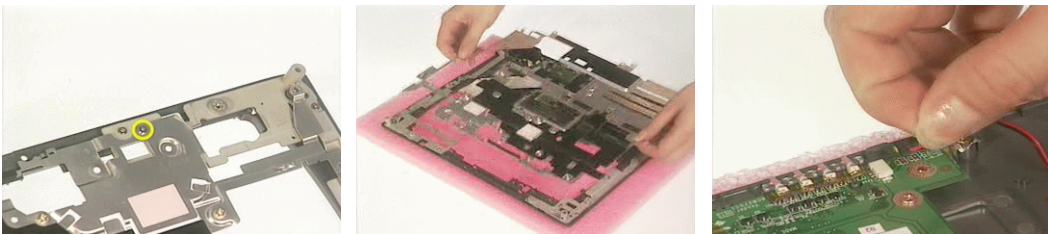

7. Remove the two screws holding the speaker.
8. Then place the speaker as shown.
9. Disconnect the speaker cable then remove the speaker.



10. Disconnect the touchpad button board to audio board FFC.
11. Remove the two screws that secure the touchpad button board.
12. Disconnect the main board to touchpad button board FFC.

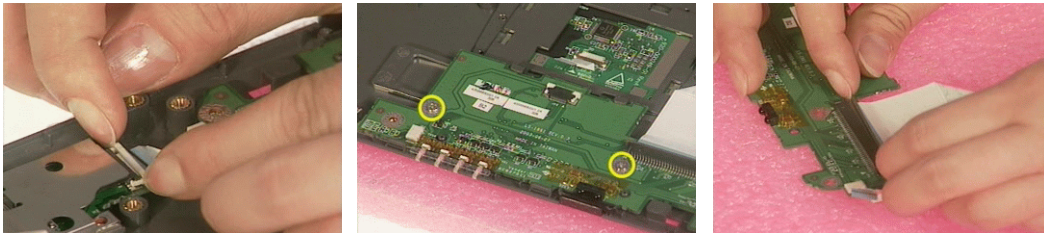

13. Disconnect the touchpad button board to audio board FFC.
14. Remove the screw that fastens the audio board then detach the audio board assembly.
15. Detach the the audio shielding from the audio board.



16. Detach the touchpad assembly.
17. Then detach the touchpad from the touchpad cover.
18. Disconnect the touchpad button to touchpad FFC.

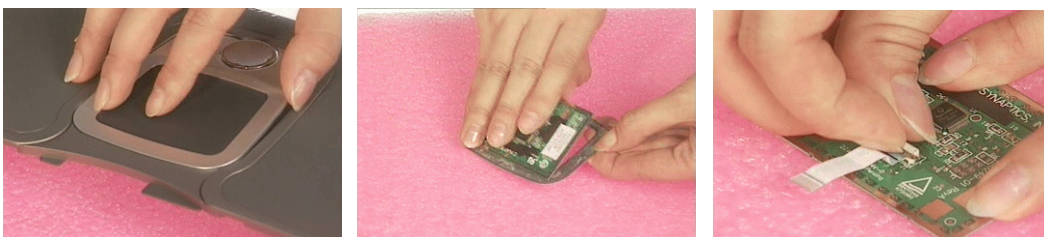

Disassembling the logic lower assembly

1. Tear off the mylar that fastens the modem board cable.
2. Remove the two screws holding the modem board..

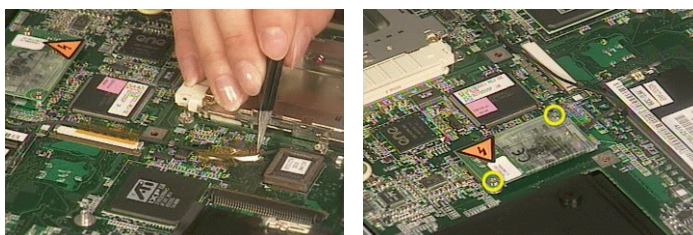

3. Detach the modem board.
4. Disconnect the modem board cable.
5. Disconnect the modem board cable from the main board then remove the modem board cable.

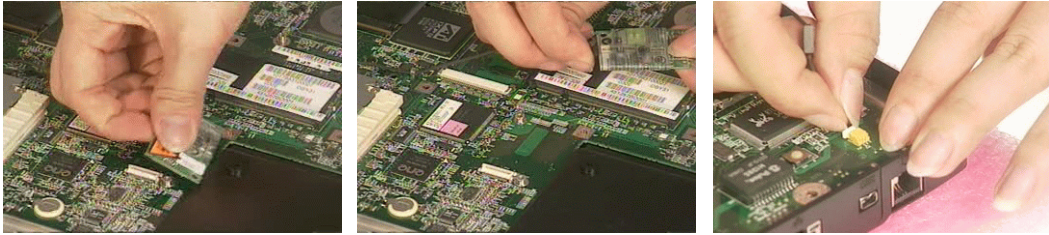

6. Remove the screw holding the main board.
7. Remove the four hex screw-nuts that secure the main board to the lower case.
8. Take out the main board from the lower case.

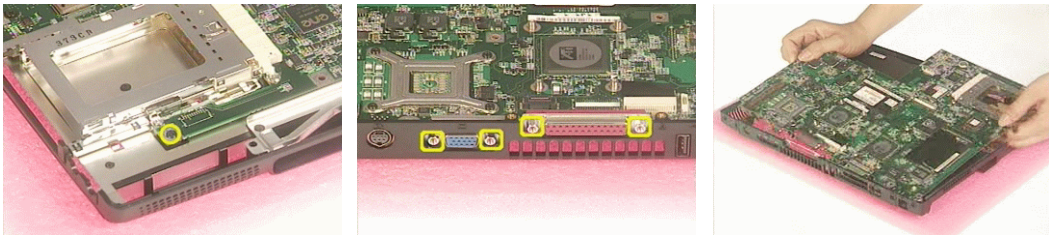

9. Remove the four screws that fasten the fan module.
10. Place the fan module as shown.
11. Disconnect the fan cable the remove the fan module.

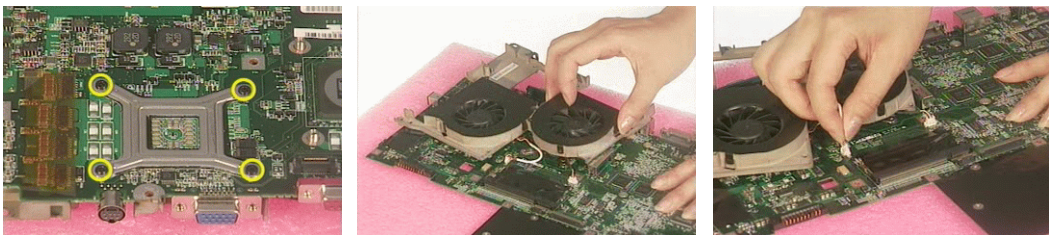

Disassembling the LCD Module

1. Remove the two LCD rubber and the two LCD screw caps.
2. Remove the four screws as shown.
3. Detach the LCD bezel carefully.



4. Remove one screw that secures the LCD inverter.
5. Disconnect the LCD inverter from the LCD.
6. Then disconnect the LCD inverter cable.

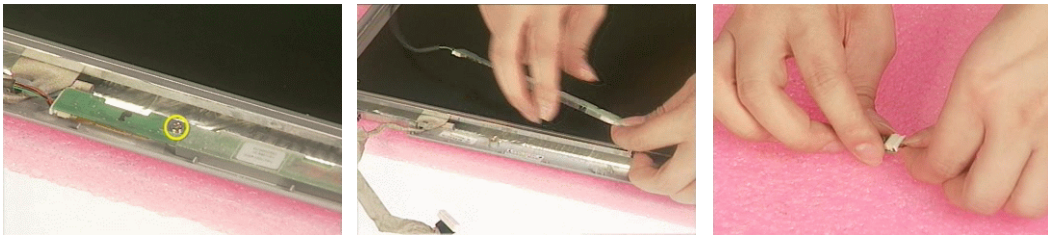

7. Remove the four screws holding the LCD hinges; two on each side.
8. Then take out the LCD assembly from the LCD panel.
9. Remove the eight screws holding the LCD brackets; four on the left and four on the right.



10. Remove the LCD brackets from the LCD.
11. Tear off the mylar fastening the LCD wire cable.
12. Disconnect the LCD wire cable.

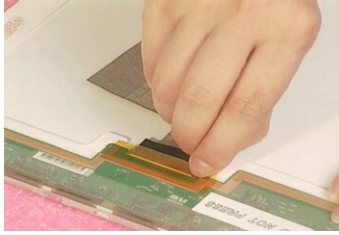
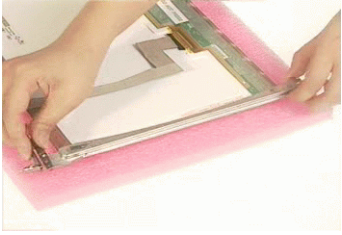

Disassembling the External Modules

Disassembling the HDD Module

1. Remove the two screws holding the HDD top shielding on one side.
2. Remove the two screws holding the HDD top shielding on the other side.

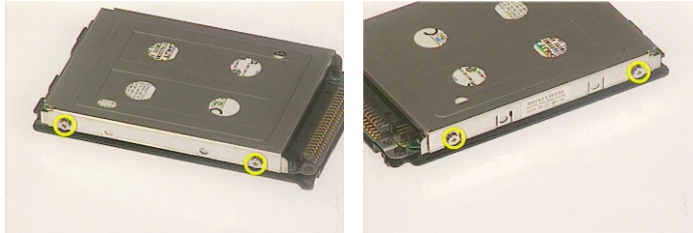

3. Remove the HDD top shielding.
4. Take out the HDD from the HDD carrier.
5. Disconnect the HDD connector.

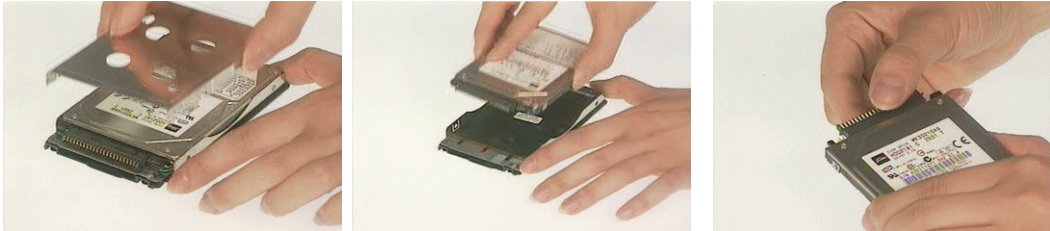

Disassembling the Optical Disc Drive Module

1. Remove the two screws holding the optical device holder.
2. Remove another two screws as shown.
3. Then remove the last two screws that secure the optical device holder.

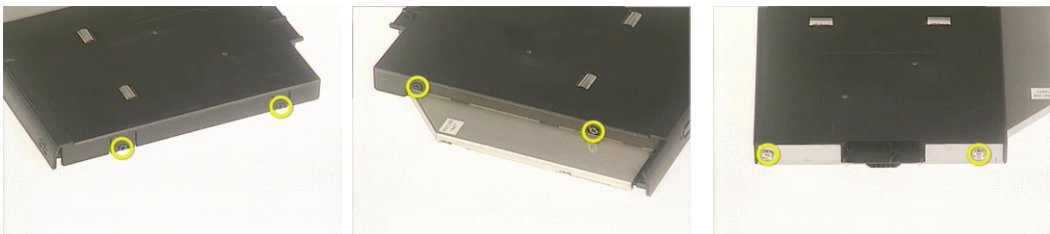

4. Detach the optical device holder.
5. Remove the optical device bracket.
6. Then disconnect device board.

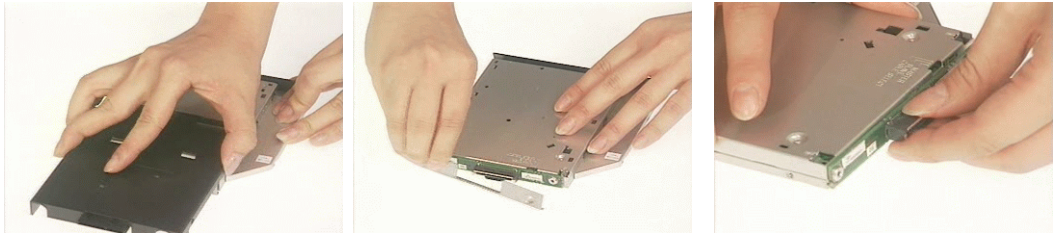

Disassembling the Floppy Disc Drive Module

1. Remove the two screws holding the FDD bracket.
2. Remove one screw that fastens the FDD bracket on the other side.

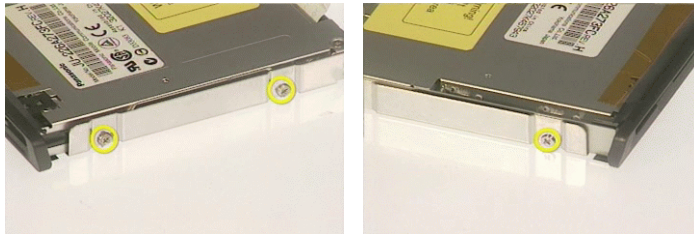

3. Detach the FDD bracket.
4. Then disconnect the FDD cable.

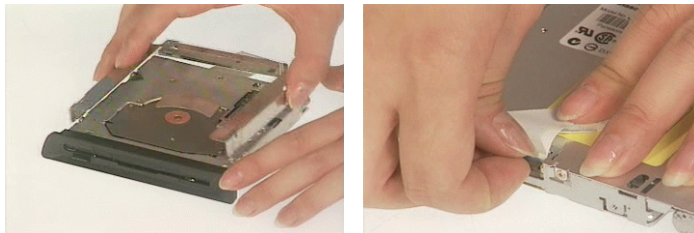

Troubleshooting

Use the following procedure as a guide for computer problems.

NOTE: The diagnostic tests are intended to test this model. Non-Acer products, prototype cards, or modified options can give false errors and invalid system responses.

1. Duplicate symptom and obtain the failing symptoms in as much detail as possible.
2. Distinguish symptom. Verify the symptoms by attempting to re-create the failure by running the diagnostic test or by repeating the same operation.
3. Disassemble and assemble the unit without any power sources.
4. If any problem occurs, you can perform visual inspection before you follow this chapter's instructions. You can check the following:
 - power cords are properly connected and secured;
 - there are no obvious shorts or opens;
 - there are no obviously burned or heated components;
 - all components appear normal.
5. Use the following table with the verified symptom to determine which page to go to.

Symptoms (Verified)	Go To
Power failure. (The power indicator does not go on or stay on.)	"Power System Check" on page 67.
POST does not complete. No beep or error codes are indicated.	"Power-On Self-Test (POST) Error Message" on page 69 "Undetermined Problems" on page 81
POST detects an error and displayed messages on screen.	"Error Message List" on page 70
Other symptoms (i.e. LCD display problems or others).	"Power-On Self-Test (POST) Error Message" on page 69
Symptoms cannot be re-created (intermittent problems).	Use the customer-reported symptoms and go to "Power-On Self-Test (POST) Error Message" on page 69 "Intermittent Problems" on page 80 "Undetermined Problems" on page 81

System Check Procedures

External Diskette Drive Check

Do the following to isolate the problem to a controller, driver, or diskette. A write-enabled, diagnostic diskette is required.

NOTE: Make sure that the diskette does not have more than one label attached to it. Multiple labels can cause damage to the drive or cause the drive to fail.

Do the following to select the test device.

1. Boot from the diagnostics diskette and start the diagnostics program.
2. See if FDD Test is passed as the program runs to FDD Test.
3. Follow the instructions in the message window.

If an error occurs with the internal diskette drive, reconnect the diskette connector on the system board.

If the error still remains:

1. Reconnect the external diskette drive/DVD-ROM module.
2. Replace the external diskette drive/CD-ROM module.
3. Replace the main board.

External CD-ROM Drive Check

Do the following to isolate the problem to a controller, drive, or CD-ROM. Make sure that the CD-ROM does not have any label attached to it. The label can cause damage to the drive or can cause the drive to fail.

Do the following to select the test device:

1. Boot from the diagnostics diskette and start the diagnostics program.
2. See if CD-ROM Test is passed when the program runs to CD-ROM Test.
3. Follow the instructions in the message window.

If an error occurs, reconnect the connector on the System board. If the error still remains:

1. Reconnect the external diskette drive/CD-ROM module.
2. Replace the external diskette drive/CD-ROM module.
3. Replace the main board.

Keyboard or Auxiliary Input Device Check

Remove the external keyboard if the internal keyboard is to be tested.

If the internal keyboard does not work or an unexpected character appears, make sure that the flexible cable extending from the keyboard is correctly seated in the connector on the system board.

If the keyboard cable connection is correct, run the Keyboard Test.

If the tests detect a keyboard problem, do the following one at a time to correct the problem. Do not replace a non-defective FRU:

1. Reconnect the keyboard cables.
2. Replace the keyboard.
3. Replace the main board.

The following auxiliary input devices are supported by this computer:

- Numeric keypad
- External keyboard

If any of these devices do not work, reconnect the cable connector and repeat the failing operation.

Memory check

Memory errors might stop system operations, show error messages on the screen, or hang the system.

1. Boot from the diagnostics diskette and start the doagmpstotics program (please refer to main board).
2. Go to the diagnostic memory in the test items.
3. Press F2 in the test items.
4. Follow the instructions in the message window.

NOTE: Make sure that the DIMM is fully installed into the connector. A loose connection can cause an error.

Power System Check

To verify the symptom of the problem, power on the computer using each of the following power sources:

1. Remove the battery pack.
2. Connect the power adapter and check that power is supplied.
3. Disconnect the power adapter and install the charged battery pack; then check that power is supplied by the battery pack.

If you suspect a power problem, see the appropriate power supply check in the following list:

- "Check the Battery Pack" on page 68

Check the Battery Pack

To check the battery pack, do the following:

From Software:

1. Check out the Power Management in control Panel
2. In Power Meter, confirm that if the parameters shown in the screen for Current Power Source and Total Battery Power Remaining are correct.
3. Repeat the steps 1 and 2, for both battery and adapter.
4. This helps you identify first the problem is on recharging or discharging.

From Hardware:

1. Power off the computer.
2. Remove the battery pack and measure the voltage between battery terminals 1(+) and 6(ground). See the following figure
3. If the voltage is still less than 7.5 Vdc after recharging, replace the battery.

To check the battery charge operation, use a discharged battery pack or a battery pack that has less than 50% of the total power remaining when installed in the computer.

If the battery status indicator does not light up, remove the battery pack and let it return to room temperature. Re-install the battery pack.

If the charge indicator still does not light up, replace the battery pack. If the charge indicator still does not light up, replace the DC/DC charger board.

Touchpad check

If the touchpad doesn't work, do the following actions one at a time to correct the problem. Do not replace a non-defective FRU:

1. After rebooting, run Tracking Pad PS2 Mode Driver. For example, run Syn touch driver.
2. Run utility with the PS/2 mouse function and check if the mouse is working.
3. If the the PS/2 mouse does not work, then check if the main board to switch board FPC is connected O.K.
4. If the main board to switch board FPC is connected well, then check if the FCC on touch pad PCB connects properly.
5. If the FFC on touch pad PCB connects properly, then check if LS851 JP1 Pin6=5V are pulese. If yes, then replace switch board. If no, then go to next step.
6. Replace touch pad PCB.
7. If the touch pad still does not work, then replace FPC on Track Pad PCB.

After you use the touchpad, the pointer drifts on the screen for a short time. This self-acting pointer movement can occur when a slight, steady pressure is applied to the touchpad pointer. This symptom is not a hardware problem. No service actions are necessary if the pointer movement stops in a short period of time.

Power-On Self-Test (POST) Error Message

The POST error message index lists the error message and their possible causes. The most likely cause is listed first.

NOTE: Perform the FRU replacement or actions in the sequence shown in FRU/Action column, if the FRU replacement does not solve the problem, put the original part back in the computer. Do not replace a non-defective FRU.

This index can also help you determine the next possible FRU to be replaced when servicing a computer.

If the symptom is not listed, see “Undetermined Problems” on page 81.

The following lists the error messages that the BIOS displays on the screen and the error symptoms classified by function.

NOTE: Most of the error messages occur during POST. Some of them display information about a hardware device, e.g., the amount of memory installed. Others may indicate a problem with a device, such as the way it has been configured.

NOTE: If the system fails after you make changes in the BIOS Setup Utility menus, reset the computer, enter Setup and install Setup defaults or correct the error.

Index of Error Messages

Error Message List

Error Messages	FRU/Action in Sequence
Struck Key	See “Keyboard or Auxiliary Input Device Check” on page 66
System CMOS checksum bad - Default configuration used	RTC battery Run BIOS Setup Utility to reconfigure system, then reboot system.
Real time clock error	RTC battery Run BIOS Setup Utility to reconfigure system time, then reboot system. Main board
Previous boot incomplete - Default configuration used	“Load Default Settings” in BIOS Setup Utility. RTC batter Main board.
Invalid System Configuration Data	“Load Default Settings” in BIOS Setup Utility. Main board.
Operating system not found	Enter Setup and see if fixed disk and drive A are properly identified. Dikette drive Hard disk drive Main board.

Error Message List

No beep Error Messages	FRU/Action in Sequence
Power-on indicator turns off and LCD is blank.	Power source (battery pack and power adapter.) See "Power System Check" on page 67 Ensure every connector is connected tightly and correctly. Reconnect the DIMM. Main board.
Power-on indicator turns on and LCD is blank.	Power source (battery pack and power adapter.) See "Power System Check" on page 67 Reconnect the LCD connector Hard disk drive LCD cable LCD inverter LCD Main board
Power-on indicator turns on and LCD is blank. But you can see POST on an external CRT.	Reconnect the LCD connectors. LCD cable LCD inverter LCD Main board
Power-on indicator turns on and a blinking cursor shown on LCD during POST.	Ensure every connector is connected tightly and correctly. Main board

POST Code

Code	Beeps	POST Routine Description
02h		Verify Real Mode
03h		Disable Non-Maskable Interrupt (NMI)
04h		Get CPU type
06h		Initialize system hardware
08h		Initialize chipset with initial POST values
09h		Set IN POST flag
0Ah		Initialize CPU registers
0Bh		Enable CPU cache
0Ch		Initialize caches to initial POST values
0Eh		Initialize I/O component
0Fh		Initialize the local bus IDE
10h		Initialize Power Management
11h		Load alternate registers with initial POST values
12h		Restore CPU control word during warm boot
13h		Initialize PCI Bus Mastering devices
14h		Initialize keyboard controller
16h	1-2-2-3	BIOS ROM checksum
17h		Initialize cache before memory autosize
18h		8254 timer initialization
1Ah		8237 DMA controller initialization
1Ch		Reset Programmable Interrupt Controller
20h	1-3-1-1	Test DRAM refresh
22h	1-3-1-3	Test 8742 Keyboard Controller
24h		Set ES segment register to 4 GB
26h		Enable A20 line
28h		Autosize DRAM
29h		Initialize POST Memory Manager
2Ah		Clear 215 KB base RAM
2Ch	1-3-4-1	RAM failure on address line xxxx
2Eh	1-3-4-3	RAM failure on data bits xxxx of low byte of memory bus
2Fh		Enable cache before system BIOS shadow
30h	1-4-1-1	RAM failure on data bits xxxx of high byte of memory bus
32h		Test CPU bus-clock frequency
33h		Initialize Phoenix Dispatch Manager
36h		Warm start shut down
38h		Shadow system BIOS ROM
3Ah		Autosize cache
3Ch		Advanced configuration of chipset registers
3Dh		Load alternate registers with CMOS values
42h		Initialize interrupt vectors
45h		POST device initialization
46h	2-1-2-3	Check ROM copyright notice

Code	Beeps	POST Routine Description
48h		Check video configuration against CMOS
49h		Initialize PCI bus and devices
4Ah		Initialize all video adapters in system
4Bh		QuietBoot start (optional)
4Ch		Shadow video BIOS ROM
4Eh		Display BIOS copyright notice
50h		Display CPU type and speed
51h		Initialize EISA board
52h		Test keyboard
54h		Set key click if enabled
58h	2-2-3-1	Test for unexpected interrupts
59h		Initialize POST display service
5Ah		Display prompt "Press F2 to enter SETUP"
5Bh		Disable CPU cache
5Ch		Test RAM between 512 and 640 KB
60h		Test extended memory
62h		Test extended memory address lines
64h		Jump to User Patch1
66h		Configure advanced cache registers
67h		Initialize Multi Processor APIC
68h		Enable external and CPU caches
69h		Setup System Management Mode (SMM) area
6Ah		Display external L2 cache size
6Bh		Load custom defaults (optional)
6Ch		Display shadow-area message
6Eh		Display possible high address for UMB recovery
70h		Display error messages
72h		Check for configuration errors
76h		Check for keyboard errors
7Ch		Set up hardware interrupt vectors
7Eh		Initialize coprocessor if present
80h		Disable onboard Super I/O ports and IRQs
81h		Late POST device initialization
82h		Detect and install external RS232 ports
83h		Configure non-MCD IDE controllers
84h		Detect and install external parallel ports
85h		Initialize PC-compatible PnP ISA devices
86h		Re-initialize onboard I/O ports
87h		Configure Motherboard Configurable Devices (optional)
88h		Initialize BIOS Area
89h		Enable Non-Maskable Interrupts (NMIs)
8Ah		Initialize Extended BIOS Data Area
8Bh		Test and initialize PS/2 mouse
8Ch		Initialize floppy controller

Code	Beeps	POST Routine Description
8Fh		Determine number of ATA drives (optional)
90h		Initialize hard-disk controllers
91h		Initialize local-bus hard-disk controllers
92h		Jump to UserPatch2
93h		Build MPTABLE for multi-processor boards
95h		Install CD ROM for boot
96h		Clear huge ES segment register
97h		Fixup Multi Processor table
98h	1-2	Search for option ROMs. One long, two short beeps on checksum failure.
99h		Check for SMART drive (optional)
9Ah		Shadow option ROMs
9Ch		Set up Power Management
9Dh		Initialize security engine (optional)
9Eh		Enable hardware interrupts
9Fh		Determine number of ATA and SCSI drives
A0h		Set time of day
A2h		Check key lock
A4h		Initialize Typematic rate
A8h		Erase F2 prompt
AAh		Scan for F2 key stroke
ACh		Enter SETUP
A Eh		Clear Boot flag
B0h		Check for errors
B2h		POST done- prepare to boot operating system
B4h	1	One short beep before boot
B5h		Terminate QuietBoot (optional)
B6h		Check password (optional)
B9h		Prepare Boot
BAh		Initialize DMI parameters
BBh		Initialize PnP Option ROMs
BCh		Clear parity checkers
BDh		Display MultiBoot menu
BEh		Clear screen (optional)
BFh		Check virus and backup reminders
C0h		Try to boot with INT 19
C1h		Initialize POST Error Manager (PEM)
C2h		Initialize error logging
C3h		Initialize error display function
C4h		Initialize system error handler
C5h		PnPnd dual CMOS (optional)
C6h		Initialize notebook docking (optional)
C7h		Initialize notebook docking late
C8h		Force check (optional)
C9h		Extended checksum (optional)
D2h		Unknown interrupt

Code	Beeps	For Boot Block in Flash ROM
E0h		Initialize the chipset
E1h		Initialize the bridge
E2h		Initialize the CPU
E3h		Initialize the system timer
E4h		Initialize system I/O
E5h		Check force recovery boot
E6h		Checksum BIOS ROM
E7h		Go to BIOS
E8h		Set Huge Segment
E9h		Initialize Multi Processor
EAh		Initialize OEM special code
EBh		Initialize PIC and DMA
ECh		Initialize Memory type
EDh		Initialize Memory size
EEh		Shadow Boot Block
EFh		System memory test
F0h		Initialize interrupt vectors
F1h		Initialize Run Time Clock
F2h		Initialize video
F3h		Initialize System Management Mode
F4h	1	Output one beep before boot
F5h		Boot to Mini DOS
F6h		Clear Huge Segment
F7h		Boot to Full DOS

Index of Symptom-to-FRU Error Message

LCD-Related Symptoms

Symptom / Error	Action in Sequence
LCD backlight doesn't work	First, plug a monitor to CRT port. Next, enter BIOS utility to running "Load Default Settings" then reboot the system. Reconnect the LCD connectors. Keyboard (if the brightness function key doesn't work). LCD cable LCD inverter LCD Main board
LCD is too dark LCD brightness cannot be adjusted	Enter BIOS Utility to execute "Load Setup Default Settings", then reboot system. Reconnect the LCD connectors. Keyboard (if the brightness function key doesn't work). LCD cable LCD inverter LCD Main board
Unreadable LCD screen Missing pels in characters Abnormal screen Wrong color displayed LCD has extra horizontal or vertical lines displayed.	Reconnect the LCD cable LCD cable LCD Main board

Indicator-Related Symptoms

Symptom / Error	Action in Sequence
Indicator incorrectly remains off or on, but system runs correctly	Main board
HDD/CD-ROM active indicators cannot work	HDD/CD-ROM drive Device driver Main board

Power-Related Symptoms

Symptom / Error	Action in Sequence
Power shuts down during operation	Power source (battery pack and power adapter). See "Power System Check" on page 67. Battery pack AC adapter See if the thermal module is overheat (Heat sink or fan). Main board
The system cannot power-on.	Power source (battery pack and power adapter). See "Power System Check" on page 67. Battery pack Power adapter CPU Main board
The system cannot power-off.	In Windows XP operating system, hold and press the power switch for more than 4 seconds. If the system can power off, then the main board is OK. Verify OS in the HDD. Main board

Power-Related Symptoms

Symptom / Error	Action in Sequence
Battery can't be charged or discharged	See "Check the Battery Pack" on page 68. Battery pack Main board
System hang during POST	ODD/HDD/FDD/RAM module Main board

PCMCIA-Related Symptoms

Symptom / Error	Action in Sequence
System cannot detect the PC Card (PCMCIA)	PCMCIA slot assembly Main board
PCMCIA slot pin is damaged.	PCMCIA slot assembly
PC Card cannot be inserted or ejected	Check if the PCMCIA slot is blocked Main board

Memory-Related Symptoms

Symptom / Error	Action in Sequence
Memory count (size) appears different from actual size.	Enter BIOS Setup Utility to execute "Load Default Settings" then reboot system. RAM module Main board Check BIOS revision
System can power on, but you hear two long beeps: "B--, B--" and the LCD is blank.	Reinsert DIMM DIMM Main board

Speaker-Related Symptoms

Symptom / Error	Action in Sequence
In Windows, multimedia programs, no sound comes from the computer.	OS volume control Audio driver Speaker Main board
Internal speakers make noise or emit no sound.	Speaker Main board
Microphone cannot work	Audio driver Volume control in Windows XP Main board

Power Management-Related Symptoms

Symptom / Error	Action in Sequence
The system will not enter hibernation mode	Power option in Windows XP Hard disk drive Main board
The system doesn't enter standby mode after closing the lid of the portable computer.	Driver of Power Option Properties Lid close switch in upper case Main board

Power Management-Related Symptoms

Symptom / Error	Action in Sequence
The system doesn't resume from hibernation/standby mode.	Connect AC adapter then check if the system resumes from Standby/Hibernation mode. Check if the battery is low. Hard disk drive Main board
The system doesn't resume from standby mode after opening the lid of the portable computer.	LCD cover switch Main board
Battery fuel gauge in Windows doesn't go higher than 90%.	Refresh battery (continue use battery until power off, then charge battery). Battery pack Main board
System hangs intermittently.	Reconnect hard disk/CD-ROM drives. Main board

Peripheral-Related Symptoms

Symptom / Error	Action in Sequence
System configuration does not match the installed devices.	Enter BIOS Setup Utility to execute "Load Setup defaults", then reboot system. Reconnect hard disk/CD-ROM drives/FDD or other peripherals. Main board
External display does not work correctly.	Press Fn+F5, LCD/CRT/Both display switching Keyboard Main board
USB does not work correctly	Main board
Print problems.	Enter BIOS Setup Utility to execute "Load Default Settings" then reboot the system. Run printer self-test. Printer driver Printer cable Printer Main board
Parallel port device problems	Enter BIOS Setup Utility to execute "Load Default Settings" then reboot the system. Device driver Device cable Device Main board

Keyboard/Touchpad-Related Symptoms

Symptom / Error	Action in Sequence
Keyboard (one or more keys) does not work.	Reconnect the keyboard cable. Keyboard Main board
Touchpad does not work.	Reconnect touchpad cable. Touchpad board Main board

Modem/LAN-Related Symptoms

Symptom / Error	Action in Sequence
Internal modem does not work correctly.	Phone cable Driver Reconnect the Internal modem cable to the main board tightly. Main board
Internal LAN does not work correctly	Lan cable Driver Main board

NOTE: If you cannot find a symptom or an error in this list and the problem remains, see “Undetermined Problems” on page 81.

Intermittent Problems

Intermittent system hang problems can be caused by a variety of reasons that have nothing to do with a hardware defect, such as: cosmic radiation, electrostatic discharge, or software errors. FRU replacement should be considered only when a recurring problem exists.

When analyzing an intermittent problem, do the following:

1. Run the diagnostic test for the system board in loop mode at least 10 times.
2. If no error is detected, do not replace any FRU.
3. If any error is detected, replace the FRU. Rerun the test to verify that there are no more errors.

Undetermined Problems

The diagnostic problems does not identify which adapter or device failed, which installed devices are incorrect, whether a short circuit is suspected, or whether the system is inoperative.

Follow these procedures to isolate the failing FRU (do not isolate non-defective FRU).

NOTE: Verify that all attached devices are supported by the computer.

NOTE: Verify that the power supply being used at the time of the failure is operating correctly. (See “Power System Check” on page 67):

1. Power-off the computer.
2. Visually check them for damage. If any problems are found, replace the FRU.
3. Remove or disconnect all of the following devices:
 - Non-Acer devices
 - Printer, mouse, and other external devices
 - Battery pack
 - Hard disk drive
 - DIMM
 - PC Cards
4. Power-on the computer.
5. Determine if the problem has changed.
6. If the problem does not recur, reconnect the removed devices one at a time until you find the failing FRU.
7. If the problem remains, replace the following FRU one at a time. Do not replace a non-defective FRU:
 - System board
 - LCD assembly

Jumper and Connector Locations

Top View

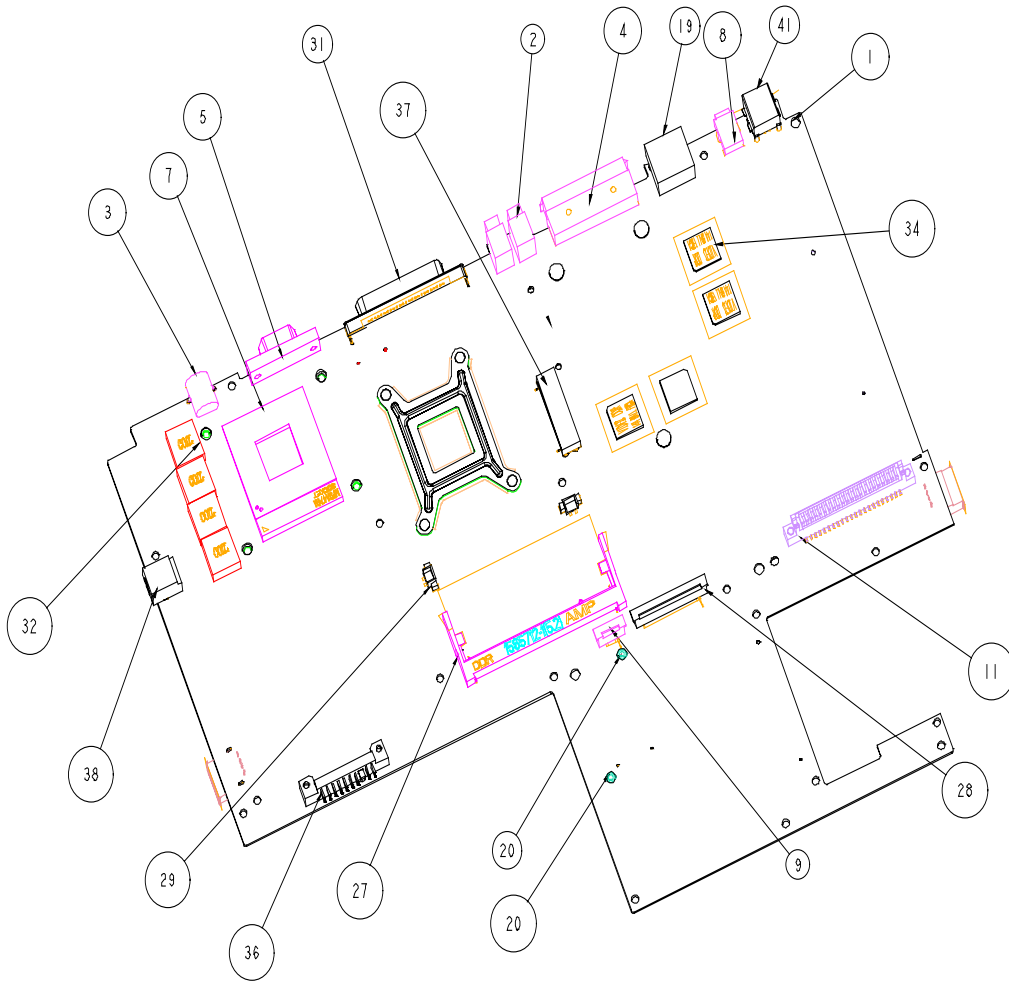

3-JP19	S-Video Port	41-JP22	RJ11
7-U32	CPU Socket	34-U29	VGA Memory
5-JP20	VGA Port	11-JP30	HDD Connector
31-JP1	Print Port	28-JP31	FDD Connector
37-JP26	ODD Module Connector	9-JP32	Card Reader Connector
2-JP17	Two USB Ports	27-JP29	DIMM Socket
4-JP24	Docking Connector	3-PCN2	Battery Connector
19-JP18	RJ45	29-JP28	Fan Connector
8-JP23	IEEE 1394 Port	38-PCN1	DC-In

Bottom View

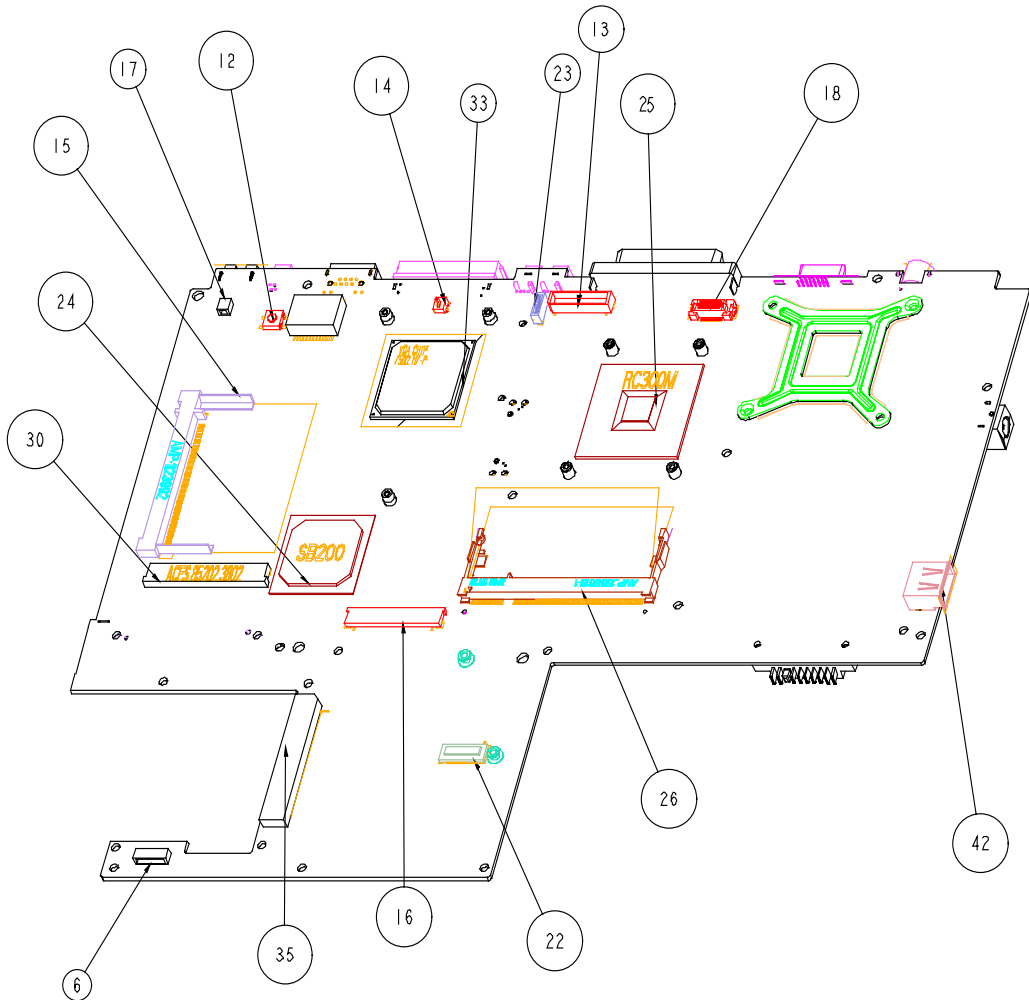

42-JP11	USB Port	25-U11	North Bridge
30-JP9	Touchpad FFC Connector	13-JP5	LCD Cable Connector
24-U15	South Bridge	18-JP3	Function Board Connector
15-JP8	Mini PCI Socket	26	DIMM Socket
17-JP4	Modem Connector	22-JP14	MDC Board Connector
12-SW2	Power Switch	16-JP12	Keyboard Connector
14-SW1	Lid Switch	35	PCMCIA Connector
33-U7	VGA Chipset	6-JP16	Bluetooth FFC Connector
23-JP2	LCD Inverter Connector		

FRU (Field Replaceable Unit) List

This chapter gives you the FRU (Field Replaceable Unit) listing in global configurations of TravelMate 540 series products. Refer to this chapter whenever ordering for parts to repair or for RMA (Return Merchandise Authorization).

Please note that WHEN ORDERING FRU PARTS, you should check the most up-to-date information available on your regional web or channel. For whatever reasons a part number change is made, it will not be noted on the printed Service Guide. For ACER AUTHORIZED SERVICE PROVIDERS, your Acer office may have a DIFFERENT part number code from those given in the FRU list of this printed Service Guide. You MUST use the local FRU list provided by your regional Acer office to order FRU parts for repair and service of customer machines.

NOTE: To scrap or to return the defective parts, you should follow the local government ordinance or regulations on how to dispose it properly, or follow the rules set by your regional Acer office on how to return it.

Exploded Diagram

The System-1

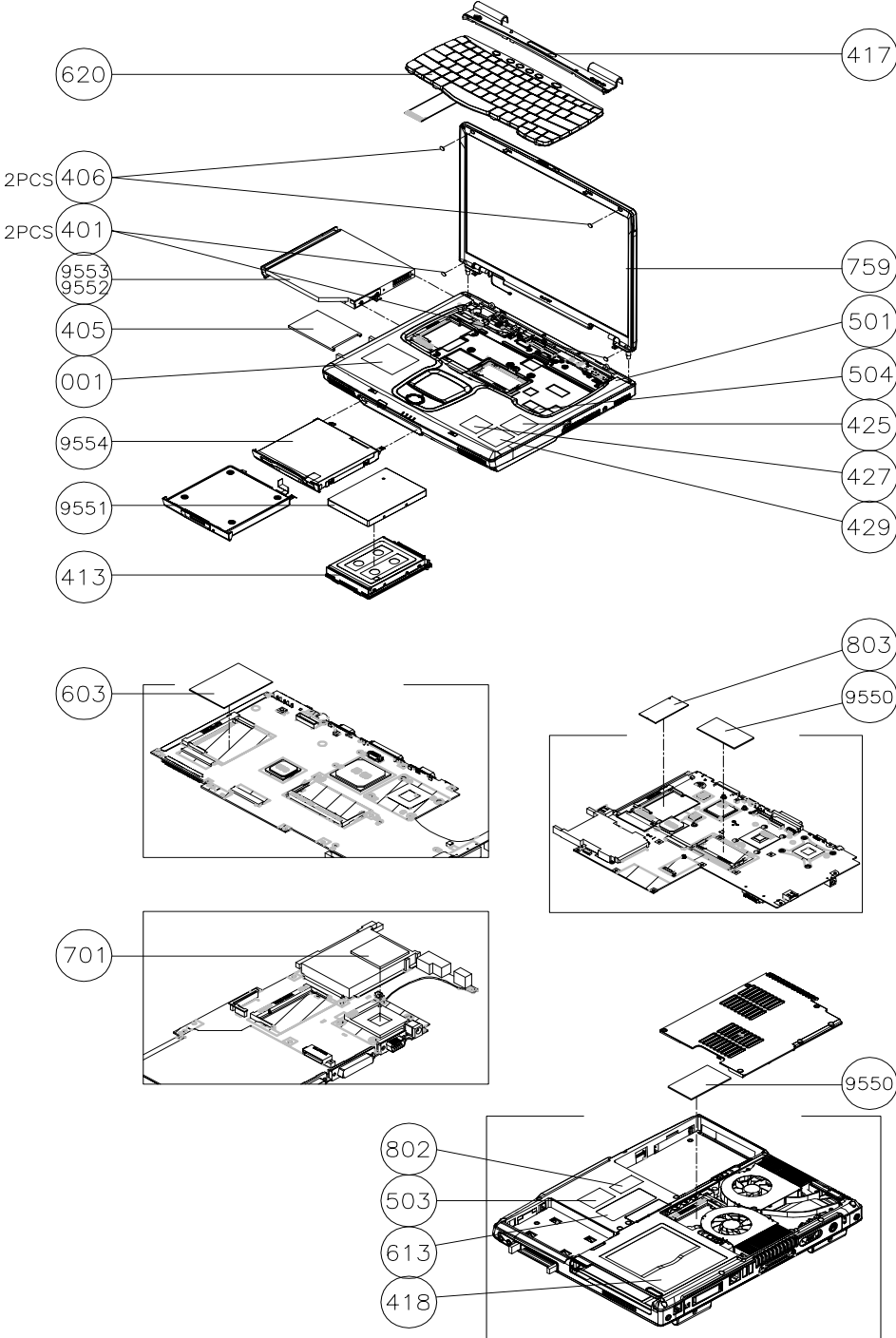

The System-2

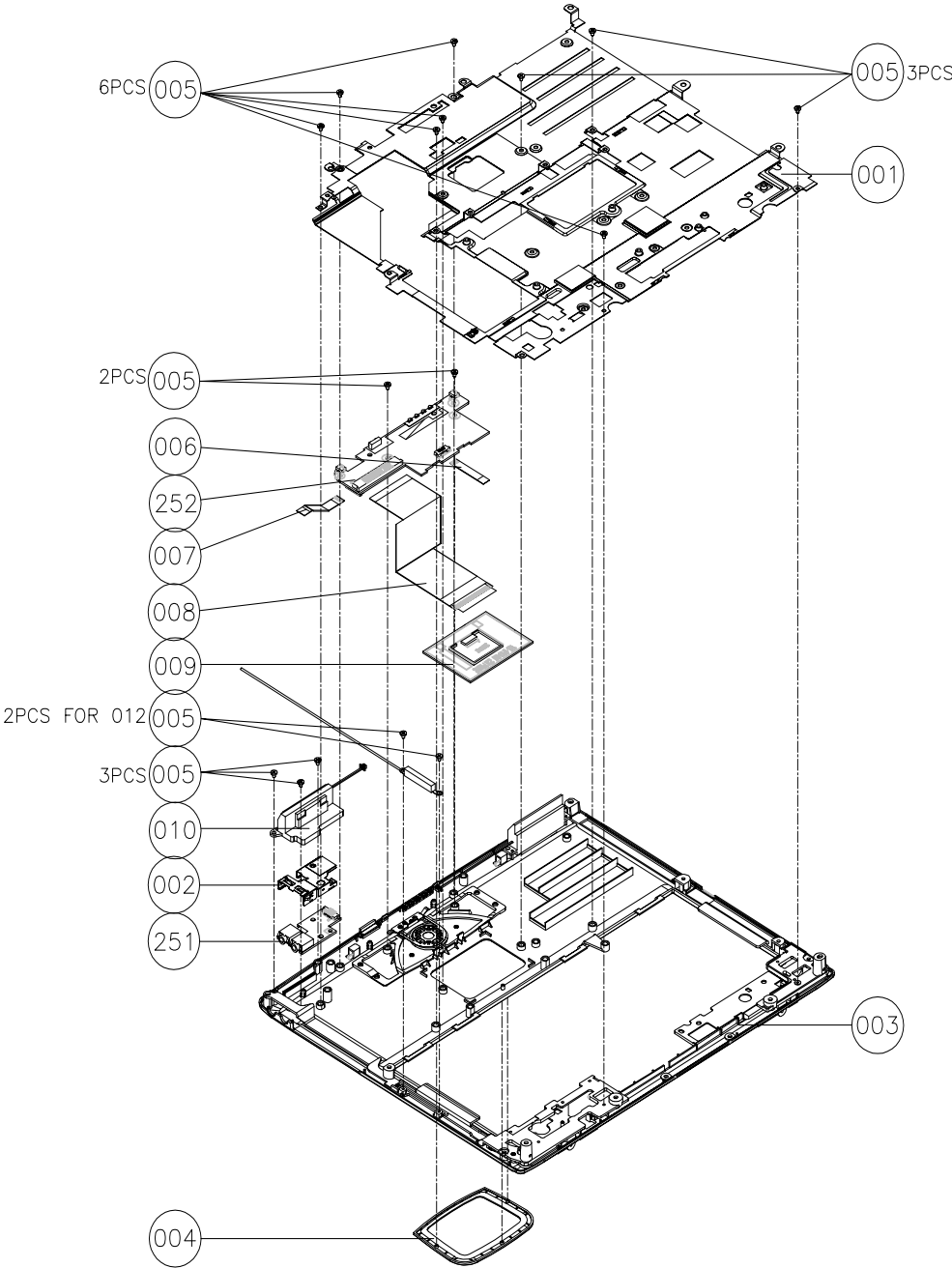

LCD Module-14"

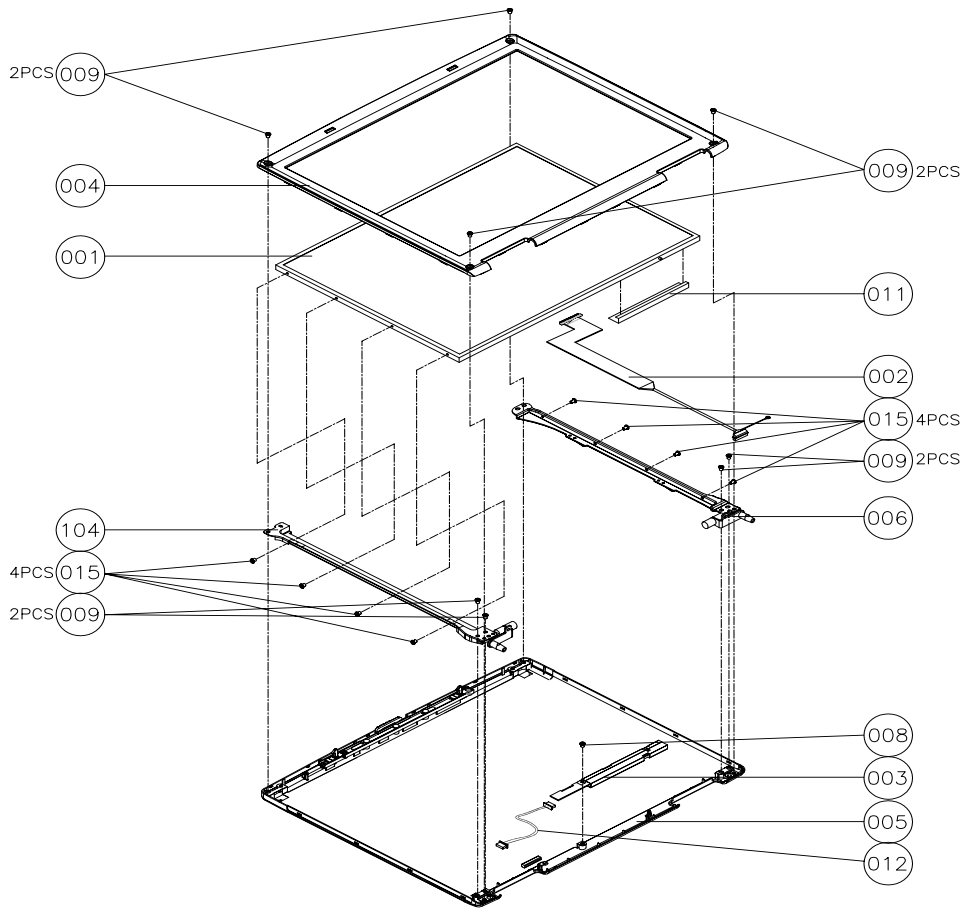

LCD Module-15"

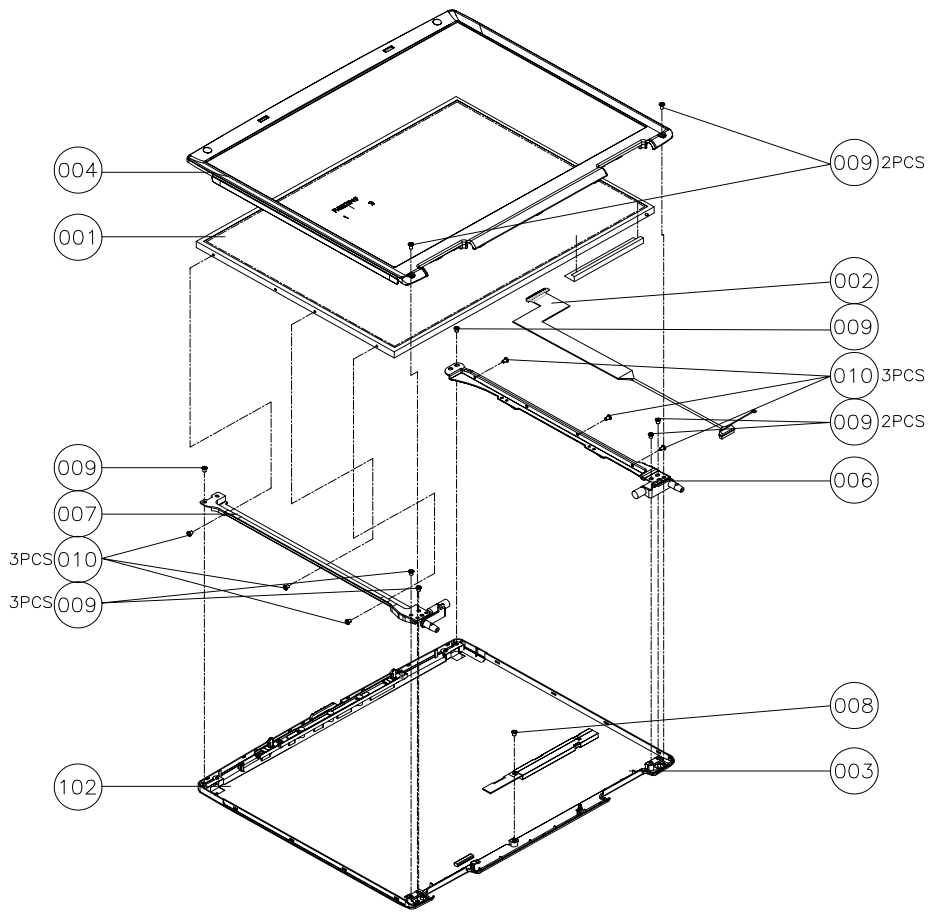

ODD Module

CD-ROM

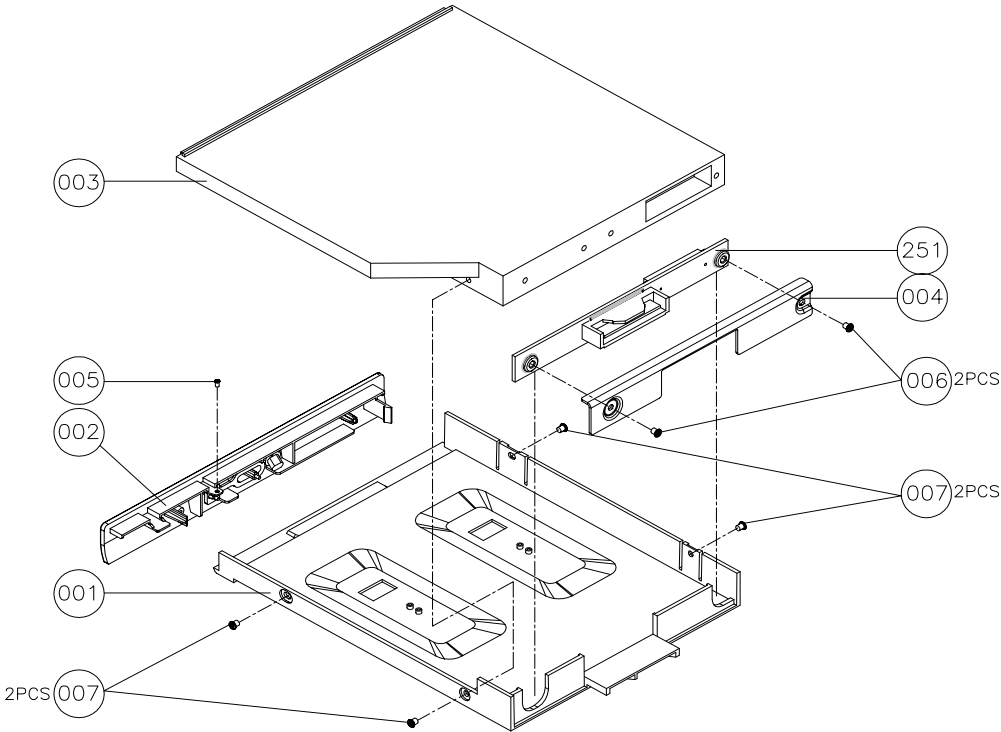

DVD-ROM

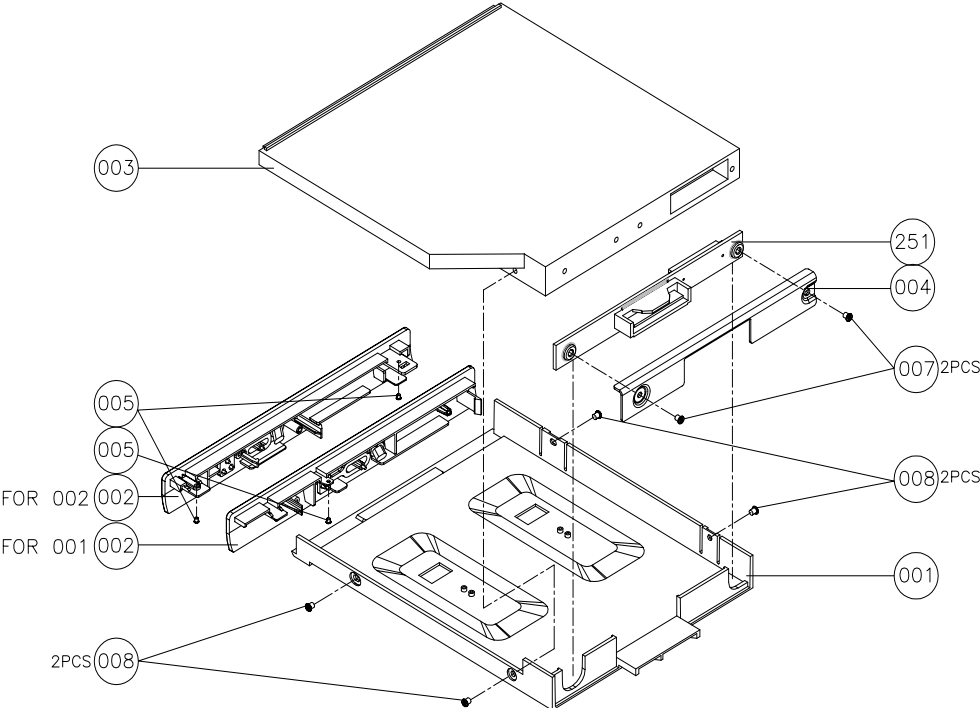

Combo Drive

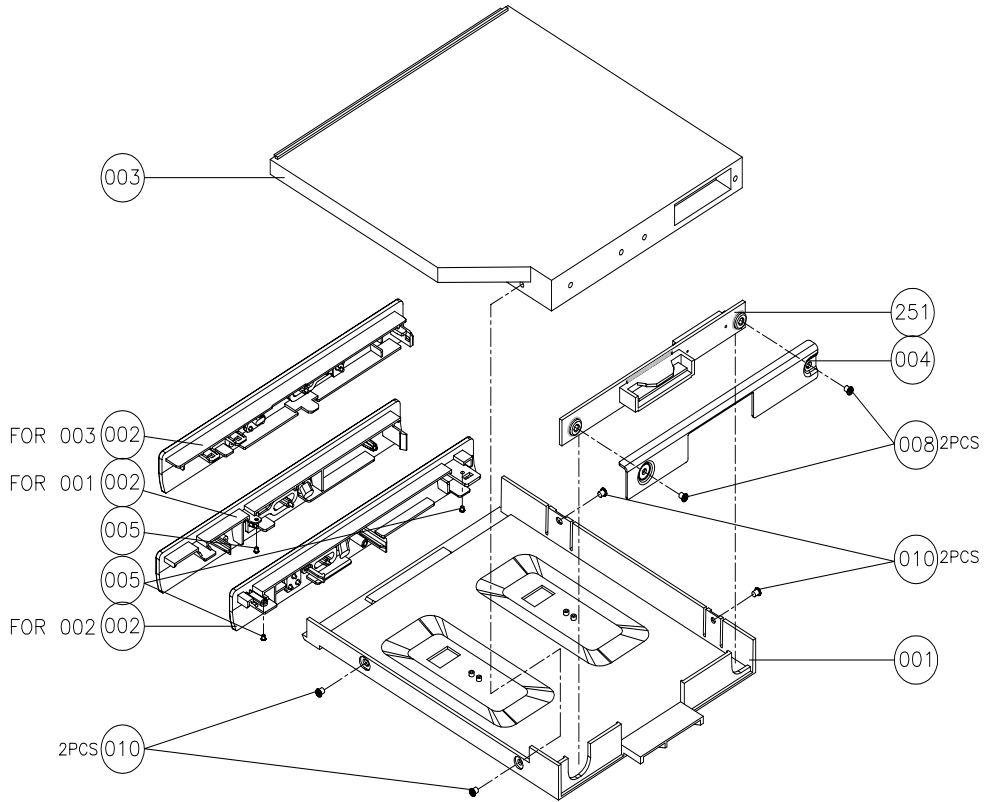



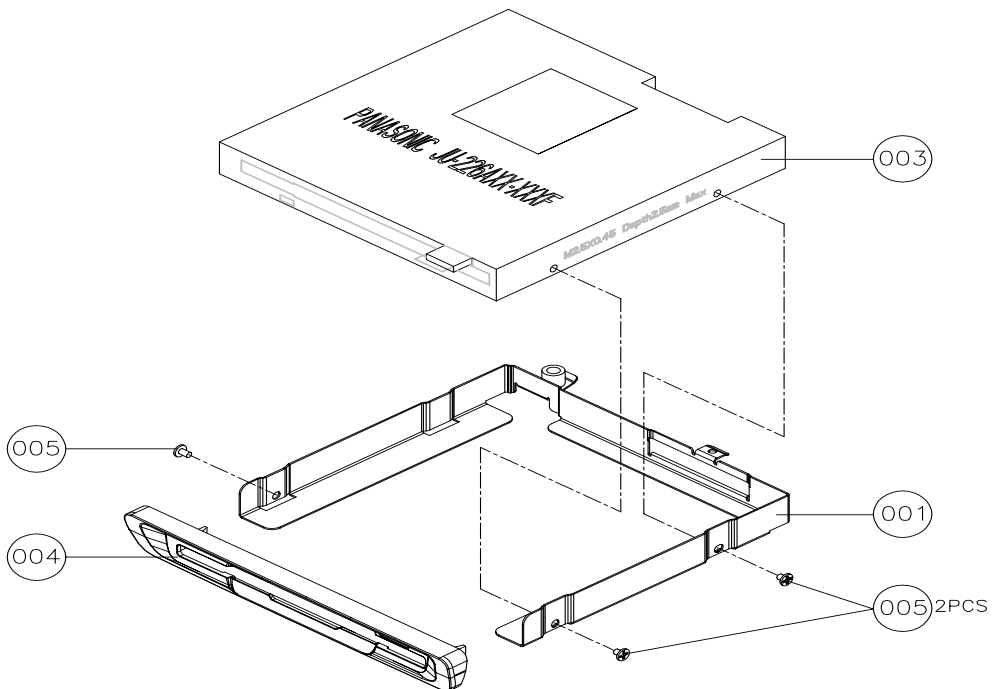



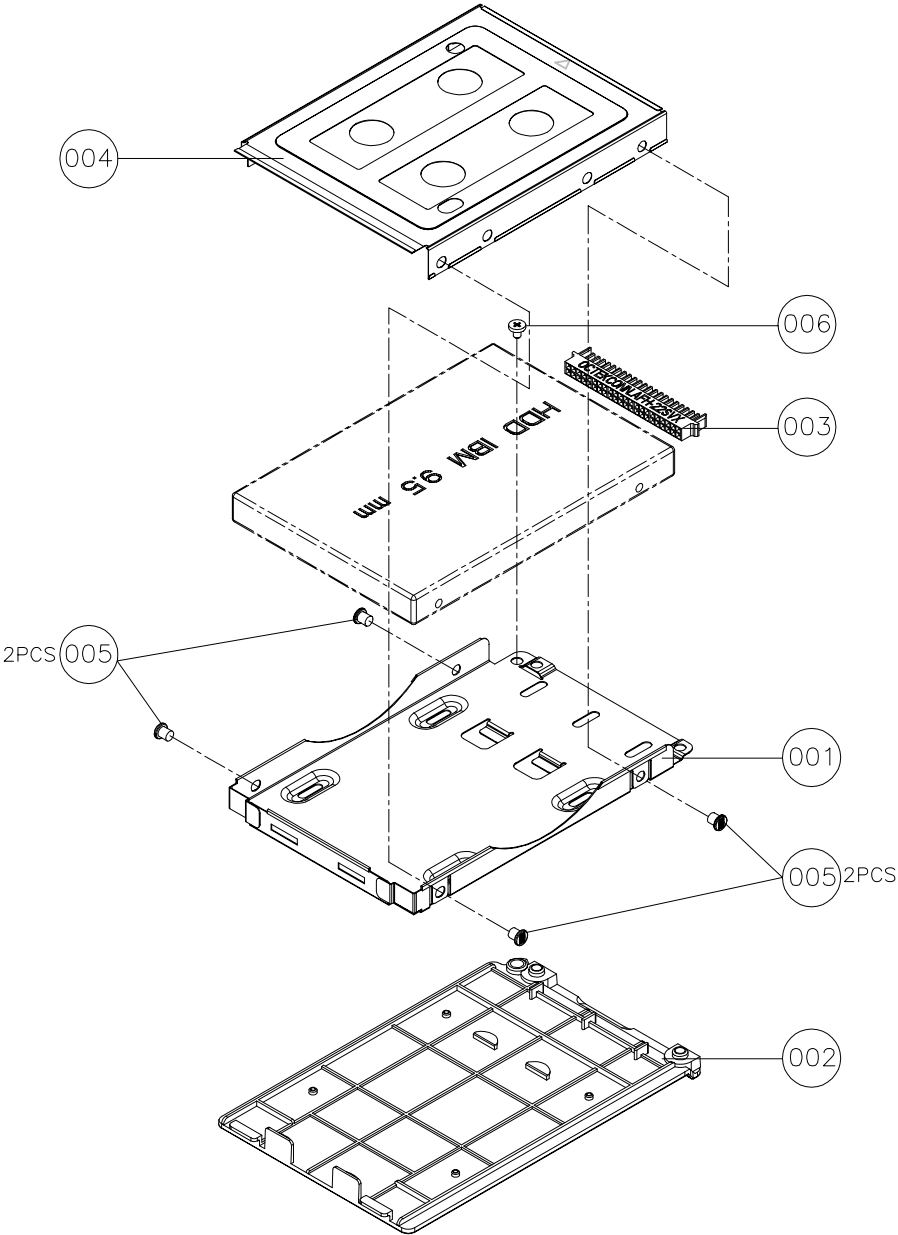

FDD Module



HDD Module







Picture	No.	Partname And Description	Part Number
Adapter			
	NS	ADPATER DELTA 75W 3PAPD-75FB BA PFC	AP.T2301.001
		ADPATER LITEON 75W 3P PA-1750-02CA PFC	AP.T2303.001
Battery			



Picture	No.	Partname And Description	Part Number
	NS	BATTERY LI-ION 9 CELLS-SANYO, 6300 mAH US18650F	BT.T3402.001
		BATTERY LI-ION 9 CELLS-SONY , 6300 mAH UR18650G5	BT.T3404.001
Boards			
	NS	MODEM BOARD AMBIT T60M283.10	54.T34V5.001
	NS	MODEM / BLUETOOTH COMBO BOARD AMBIT T60M665.00	54.T34V5.002
	The System- 1 803	MINI PCI WIRELESS BOARD (802.11b) AMBIT T60H771.00	54.T34V5.003
	The System- 2 252	TOUCHPAD BUTTON BOARD	55.T34V5.001
	The System- 2 251	AUDIO BOARD	55.T34V5.002
	NS	LAUNCH BOARD	55.T34V5.003
Cables			
	The System- 2 008	FFC -MB TO T/P BUTTON BOARD	50.T34V5.001
	The System- 2 006	FFC -T/P BUTTON BOARD TO T/P	50.T34V5.002
	The System- 2 007	FFC -T/P BUTTON BOARD TO AUDIO BOARD	50.T34V5.003

Picture	No.	Partname And Description	Part Number
	NS	MODEM CABLE	50.T34V5.004
		POWER CORD US (3pin)	27.T34V5.001
		POWER CORD EC (3pin)	27.T34V5.002
		POWER CORD Aus(3pin)	27.T34V5.003
		POWER CORD UK (3pin)	27.T34V5.004
		POWER CORD SWISS (3pin)	27.T34V5.005
		POWER CORD CHINA (3pin)	27.T34V5.006
		POWER CORD ITALIAN (3pin)	27.T34V5.007
		POWER CORD DENMARK(3pin)	27.T34V5.008
Case/Cover/Bracket Assembly			
	The System-1 417	MIDDLE COVER W/Name Plate	42.T34V5.001
	The System-2 003	LOWER CASE	60.T34V5.001
	NS	DIMM COVER	42.T34V5.002
	NS	UPPER CASE W/SPEAKER R	60.T34V5.002
	NS	MINI PCI COVER	42.T34V5.003
	The System-2 004	TOUCHPAD COVER	42.T34V5.004

Picture	No.	Partname And Description	Part Number
	The System-2 002	AUDIO SHIELDING	33.T34V5.001
	The System-2 001	K/B SUPPORT PLATE	33.T34V5.002
	The System-1	THERMAL COVER	42.T34V5.005
	NS	LOWER DOOR	42.T34V5.006
Communication Module			
	NS	ANTENNA - BLACK	50.T34V5.013
	NS	ANTENNA - WHITE	50.T34V5.014
CPU			
	NS	MOBILE PENTIUM 4 3.06GHZ 512K	KC.NP001.306
		MOBILE PENTIUM 4 2.8GHZ 512K	KC.NP001.2G8
		MOBILE PENTIUM 4 2.66GHZ 512K	KC.NP001.266
		MOBILE PENTIUM 4 2.4GHZ 512K	KC.NP001.2G4
		CELERON (PORTABILITY) 2.6GHZ/128K/400FSB	KC.NCP01.26G
		CELERON (PORTABILITY) 2.5GHZ/128K/400FSB	KC.NCP01.25G
		CELERON (PORTABILITY) 2.4GHZ/128K/400FSB	KC.NCP01.24G
		CELERON (PORTABILITY) 2.3GHZ/128K/400FSB	KC.NCP01.23G
		CELERON (PORTABILITY) 2.2GHZ/128K/400FSB	KC.NCP01.22G
		CELERON (PORTABILITY) 2.0GHZ/128K/400FSB	KC.NCP01.20G
FDD Module			
	FDD Module	FDD MODULE PANASONIC JU-226A273FC	6M.T34V5.009

Picture	No.	Partname And Description	Part Number
	FDD Module 003	FDD DRIVE PANASONIC JU-226A273FC	KF.22602.001
	FDD Module 004	FDD BEZEL FOR PANASONIC	42.T34V5.015
	FDD Module 001	FDD BRACKET FOR PANASONIC	33.T34V5.004
	NS	FDD FPC CABLE FOR PANASONIC	50.T34V5.007
Card Reader			
	NS	5 IN 1 MEMORY CARD READER MODULE	LC.T3405.001
	NS	5-IN-1 MEMORY CARD READER BOARD	55.T34V5.005
	NS	CARD READER HOLDER	60.T34V5.004
	NS	CARD READER COVER	33.T34V5.005
	NS	CARD READER BRACKET ASSEMBLY	33.T34V5.006
	NS	MEMORY CARD READER FFC CABLE	50.T34V5.008
HDD/ Hard Disk Drive			
	HDD Module	HDD 2.5" 30G FUJITSU MHT2030AT 4200RPM	KH.03006.002
		HDD 2.5" 60G FUJITSU MHT2060AT 4200RPM	KH.06006.002
		HDD 2.5" TOSHIBA 30GB NEPTUNE MK3021GAS	KH.33004.001
		HDD 2.5" TOSHIBA 40GB NEPTUNE MK4021GAS	KH.34004.001
		HDD 2.5" TOSHIBA 60GB NEPTUNE MK6021GAS	KH.36004.001
		HDD 2.5" HGST MORAGA 30GB IC25N030ATMR04-0	KH.03007.002
		HDD 2.5" HGST MORAGA 40GB IC25N040ATMR04-0	KH.04007.004
		HDD 2.5" HGST MORAGA 60GB IC25N060ATMR04-0	KH.06007.002
		HDD 2.5" 40G SEAGATE ST94011A 5400RPM	KH.04001.004
	HDD Module 004	HDD TOP SHIELDING	33.T34V5.007

Picture	No.	Partname And Description	Part Number
	HDD Module 001+002	HDD CARRIER	60.T34V5.005
	HDD Module 003	HDD CONNECTOR	55.T34V5.006
Keyboard			
	The System- 1 620	KEYBOARD DARFON ARABIC	KB.T3407.010
		KEYBOARD DARFON BELGIUM	KB.T3407.012
		KEYBOARD DARFON CHINESE	KB.T3407.005
		KEYBOARD DARFON CZECH	KB.T3407.014
		KEYBOARD DARFON DANISH	KB.T3407.017
		KEYBOARD DARFON FRENCH	KB.T3407.006
		KEYBOARD DARFON GERMAN	KB.T3407.003
		KEYBOARD DARFON HUNGAIAN	KB.T3407.015
		KEYBOARD DARFON ITALIAN	KB.T3407.004
		KEYBOARD DARFON NORWAY	KB.T3407.016
		KEYBOARD DARFON PORTUGUESE	KB.T3407.009
		KEYBOARD DARFON RUSSIAN	KB.T3407.020
		KEYBOARD DARFON SPANISH	KB.T3407.008
		KEYBOARD DARFON SWEDEN	KB.T3407.013
		KEYBOARD DARFON SWISS/G	KB.T3407.007
		KEYBOARD DARFON THAI	KB.T3407.011
		KEYBOARD DARFON TURKISH	KB.T3407.018
KEYBOARD DARFON UK	KB.T3407.002		
KEYBOARD DARFON US INTERNATIONAL	KB.T3407.001		
KEYBOARD DARFON BRAZILIAN PORTUGUESE	KB.T3407.021		
KEYBOARD DARFON GREEK	KB.T3407.019		

Picture	No.	Partname And Description	Part Number
	The System-1 620	KEYBOARD CHICONY ARABIC	KB.T3407.031
		KEYBOARD CHICONY BELGIUM	KB.T3407.033
		KEYBOARD CHICONY CHINESE	KB.T3407.026
		KEYBOARD CHICONY CZECH	KB.T3407.035
		KEYBOARD CHICONY DANISH	KB.T3407.038
		KEYBOARD CHICONY FRENCH	KB.T3407.027
		KEYBOARD CHICONY GERMAN	KB.T3407.024
		KEYBOARD CHICONY HUNGAIAN	KB.T3407.036
		KEYBOARD CHICONY ITALIAN	KB.T3407.025
		KEYBOARD CHICONY NORWAY	KB.T3407.037
		KEYBOARD CHICONY PORTUGUESE	KB.T3407.030
		KEYBOARD CHICONY RUSSIAN	KB.T3407.041
		KEYBOARD CHICONY SPANISH	KB.T3407.029
		KEYBOARD CHICONY SWEDEN	KB.T3407.034
		KEYBOARD CHICONY SWISS/G	KB.T3407.028
		KEYBOARD CHICONY THAI	KB.T3407.032
		KEYBOARD CHICONY TURKISH	KB.T3407.039
		KEYBOARD CHICONY UK	KB.T3407.023
KEYBOARD CHICONY US INTERNATIONAL	KB.T3407.022		
KEYBOARD CHICONY BRAZILIAN PORTUGUESE	KB.T3407.042		
KEYBOARD CHICONY GREEK	KB.T3407.040		
LCD			
	LCD Module 14" and LCD Module 15"	ASSY LCD MODULE 14.1" XGA AU (B141XG05)	6M.T34V5.012
		ASSY LCD MODULE 14.1" XGA AU (B141XG05) FOR WIRELESS	6M.T34V5.022
		ASSY LCD MODULE 14.1" XGA CMO (N141X7-L07)	6M.T34V5.011
		ASSY LCD MODULE 14.1" XGA CMO (N141X7-L07) FOR WIRELESS	6M.T34V5.021
		ASSY LCD MODULE 14.1" XGA SAMSUNG (LTN1411XB)	6M.T34V5.013
		ASSY LCD MODULE 14.1" XGA SAMSUNG (LTN1411XB) FOR WIRELESS	6M.T34V5.023
		ASSY LCD MODULE 15" SXGA AU (B150PG01)	6M.T34V5.017
		ASSY LCD MODULE 15" SXGA AU (B150PG01) FOR WIRELESS	6M.T34V5.027
		ASSY LCD MODULE 15" SXGA CMO (N150P2-L04)	6M.T34V5.018
		ASSY LCD MODULE 15" SXGA CMO (N150P2-L04) FOR WIRELESS	6M.T34V5.028
		ASSY LCD MODULE 15" SXGA HITACHI (TX38D91VC1FAB)	6M.T34V5.019
		ASSY LCD MODULE 15" SXGA HITACHI (TX38D91VC1FAB) FOR WIRELESS	6M.T34V5.029

Picture	No.	Partname And Description	Part Number
	LCD Module 14" and LCD Module 15" 001	LCD 14.1" XGA AU (B141XG05)	LK.14105.006
		LCD 14.1" XGA CMO (N141X7-L07)	LK.1410H.001
		LCD 14.1" XGA SAMSUNG (LTN1411XB)	LK.14106.001
		LCD 15" SXGA AU (B150PG01 - SPWG-B Type)	LK.15005.002
		LCD 15" SXGA CMO (N150P2-L04)	LK.1500D.003
		LCD 15" SXGA HITACHI (TX38D91VC1FAB)	LK.15004.005
	LCD Module 14" 003	LCD INVERTER	19.T34V5.001
	LCD Module 14" 012	LCD INVERTER CABLE	50.T34V5.009
	LCD Module 14" 005 LCD Module 15" 003	LCD PANEL WITH LOGO W/ANTENNA	60.T34V5.007
		LCD PANEL WITH LOGO W/O ANTENNA	60.T34V5.006
	LCD Module 14" and LCD Module 15" 004	LCD BEZEL - 14"	42.T34V5.016
		LCD BEZEL - 15"	42.T34V5.017
	LCD Module 14" 104 LCD Module 15" 007	LCD BRACKET L - 14"	33.T34V5.008
		LCD BRACKET L 15"	33.T34V5.010
	LCD Module 14" and LCD Module 15" 006	LCD BRACKET R - 14"	33.T34V5.009
		LCD BRACKET R 15"	33.T34V5.011
	LCD Module 14" and LCD Module 15" 002	LCD WIRE CABLE - 14.1"	50.T34V5.010
		LCD WIRE CABLE - 15" SXGA	50.T34V5.012
	LCD Module 14" 009	LCD RUBBER 14"	47.T34V5.001
	NS	LCD SCREW PAD	47.T34V5.002
	NS	LCD RUBBER 15" - TOP	47.T34V5.003
Main Board			

Picture	No.	Partname And Description	Part Number
	The System-1	MAINBOARD W/ PCMCIA SLOT 10/100 (W/O CPU, MEMORY)	MB.T3402.001?
	The System-1 701	PCMCIA SLOT	22.T34V5.001
Memory			
	The System-1 9550	256MB DDR333 HYS64D32020GDL-6-B INFINEON	KN.25602.009
		512MB DDR333 HYS64D64020GBDL-6-B INFINEON	KN.51202.007
		256MB DDR333 MT8VDDT3264HDG-335C3 MICRON	KN.25604.009
		512MB DDR333 MT16VDDS6464HG-335C2 MICRON	KN.51204.006
		256MB DDR333 NT256D64SH8BAGM-6K NANYA	KN.25603.009
		512MB DDR333 NT512D64S8HBAFM-6K NANYA	KN.51203.005
		256MB DDR333 BD26UC6AKSA6BZZNZZ ELPIDA	KN.25609.002
Optical Drive			
	ODD Module	DVD/CDRW COMBO MODULE 24X QSI (SBW-242U)	6M.T34V5.004
		DVD/CDRW COMBO MODULE 24X TEAC (DW-224E-A85)	6M.T34V5.005
		DVD/CDRW COMBO MODULE 24X LITEON LSC-24082K	6M.T34V5.006
		DVD-RW MODULE TEAC DV-W22E-183	6M.T34V5.007
		DVD-RW MODULE PIONEER DVR-K11	6M.T34V5.008
	Combo Drive 003	DVD/CDRW COMBO DRIVE 24X QSI (SBW-242U)	KO.24X07.003
		DVD/CDRW COMBO DRIVE 24X TEAC (DW-224E-A85)	KO.24X02.002
		DVD/CDRW COMBO DRIVE 24X LITEON LSC-24082K	KO.T2109.001
		DVD-RW DRIVE TEAC DV-W22E-183	KW.02X0D.003
		DVD-RW DRIVE PIONEER DVR-K11	KW.02X05.001
	Combo Drive 002	DVD/CDRW COMBO BEZEL FOR QSI	42.T34V5.010
		DVD/CDRW COMBO BEZEL FOR TEAC	42.T34V5.011
		DVD/CDRW COMBO BEZEL FOR LITEON	42.T34V5.012
		DVD-RW BEZEL FOR TEAC	42.T34V5.013
		DVD-RW BEZEL FOR PIONEER	42.T34V5.014

Picture	No.	Partname And Description	Part Number
	CD-ROM, DVD-ROM, Combo Drive 001	OPTICAL DEVICE HOLDER	60.T34V5.003
	CD-ROM, DVD-ROM, Combo Drive 004	OPTICAL DEVICE BRACKET	33.T34V5.003
	CD-ROM, DVD-ROM, Combo Drive 251	OPTICAL DEVICE BOARD	55.T34V5.004
Pointing Device			
	The System- 2 009	TOUCHPAD	55.T34V5.007
Speaker			
	NS	SPEAKER R	23.T34V5.001
	NS	SPEAKER L	23.T34V5.002
FAN			
	NS	FAN MODULE	60.T34V5.008
Heatsink			
	NS	THERMAL MODULE	60.T34V5.009
Microphone			
	NS	MICROPHONE	23.T34V5.003

Picture	No.	Partname And Description	Part Number
Others			
	NS	RUBBER FOOT - FRONT	47.T34V5.004
	NS	RUBBER FOOT - REAR	47.T34V5.005
	NS	SCREW RUBBER FOR K/B	47.T34V5.006
	NS	T/P LED SPONGE	47.T34V5.007
	NS	TP FFC MYLAR	47.T34V5.008
	NS	MIDDLE COVER SCREW PAD	47.T34V5.009
	NS	LOWER CASE SCREW PAD - L	47.T34V5.010
	NS	LOWER CASE SCREW PAD - R	47.T34V5.011
Screws			
	NS	SCREW M2.5 x 4-ZK	86.T34V5.001
	NS	SCREW M2.5 x 3-NI	86.T34V5.002
	NS	SCREW LOCK	86.T34V5.003
	NS	SCREW M2.0 x 3-NI	86.T34V5.004
	NS	SCREW M2.5 x 18-ZK	86.T34V5.005
	NS	SCREW M2.5 x 7-ZK	86.T34V5.006
	NS	SCREW M2.5 x 6-NI	86.T34V5.007
	NS	SCREW M2.0 x 2.5-ZK	86.T34V5.008
	NS	SCREW M2.0 x 2.5-NI	86.T34V5.009
	NS	SCREW M2.0 x 7-ZK	86.T34V5.010
	NS	SCREW M3.0 x 3 -NI	86.T34V5.011
	NS	SCREW M2.5 x 5	86.T34V5.012
	NS	SCREW M1.7 x 2.5	86.T34V5.013
	NS	SCREW M1.7 x 586.T34V5.014	86.T34V5.014
	NS	SCREW M2.0 x 2.5	86.T34V5.015
	NS	SCREW M2.0 X 0.4+6R	86.T34V5.016
	NS	TPB2 x 4.5	86.T34V5.017

Model Definition and Configuration

TravelMate 540 Series

Model Number	CPU	LCD	Memory	HDD (GB)	ODD	Wireless LAN	MDC
541XCi	Mobile Pentium 4 2.66GHz	14.1 XGA	1x256M	30	24x CDRW+DVD	11b	Modem +BT
541XC	Mobile Pentium 4 2.66GHz	14.1 XGA	1x256M	30	24x CDRW+DVD	N	N
541LCi	Mobile Pentium 4 2.66GHz	15.0 SXGA	2x256M	40	24x CDRW+DVD	11b	Modem +BT
543LCi	Mobile Pentium 4 3.06GHz	15.0 SXGA	2x256M	60	24x CDRW+DVD	11b	Modem +BT
541LMi	Mobile Pentium 4 2.66GHz	15.0 SXGA	2x256M	40	4X DVD Dual	11b	Modem +BT
543LMi	Mobile Pentium 4 3.06GHz	15.0 SXGA	2x256M	60	4X DVD Dual	11b	Modem +BT

Test Compatible Components

This computer's compatibility is tested and verified by Acer's internal testing department. All of its system functions are tested under Windows® XP Home, Windows® XP Pro and Windows® 2000 environment.

Refer to the following lists for components, adapter cards, and peripherals which have passed these tests. Regarding configuration, combination and test procedures, please refer to the TravelMate 660 series Compatibility Test Report released by the Acer Mobile System Testing Department.

Microsoft® Windows® XP Pro Environment Test

Item	Specifications
Display	LCD Philips 109P 10 CRT Philips Brilliance 109P 19" CRT Dell Trinitron 21" CRT Silicon Graphics 21" CRT ViewSonic GS773 CRT ViewSonic GS790 CRT Trinitron D1626HT 21" for DELL LCD FPD 1530 CRT DELL 12000FP
Parallel Port	Printer: HP Laser Jet 5M HP Desk Jet 930C HP Desk Jet 840C HP Laser Jet 2100 IOMega ZIP 250 (LPT Port)
Parallel Port	Cable: ECP Cable
1394 Port	HDD: 1394 4GB HDD\VST FireWire Hard Drive 1394 HDD /IEEE 1394 (Fire Wire)/USB 1.1 Combo Hard Drive\FUJITSU MHS2030AT;18.6GB 1394 CCD: Stealth Fire 1394 HUB: Aten 1394 HUB/FH-600 1394 External HDDCase: Storage BOX (2500E) 1394Video Camera: 1394 SONY DV/DCR-PC100 1394 MO: FUJITSU LIMITED MDF3130EE
Projector	Panasonic PT_L757U Acer 7755c
USB 2.0	HUB: Highspeed\4 Port Adaptec\4 Port (XHUB4) for DELL
USB 2.0	HDD: logear HI-SPEE HDD USB 2.0 Enclosure\GHE125U logear HI-SPEE HDD USB 2.0 EXTERNAL LACIE For DELL USB DRIVE 128MB USB DRIVE 256MB CardBus Card: logear GPU202 USB CDR/W: YAMAHA CRW-70 Ricoh MP5125A DVD+RW/+R LACIE (16*10*40) For DELL USB DVD/CD-RW (Pioneer DVR-104)
GB LAN HUB	3 Com GB LAN Hub
PS/2 Port	Keyboard: Microsoft Natural Keyboard Gateway SK-9920 Acer 6311-TW

Item	Specifications
	Keypad: PC Concepts Keypad KB-5640
	Mouse: COMPAQ Mouse M-SF14-2 COMPAQ Mouse M-S48a Logitech Mouse \M-S35 PSC QUICKSCAN 6000plus Only Support S3,Hut Plug
S-Video	TV: DELL \2000FP
PC Card	Modem Card: Xircom CreditCard Modem 56 (CM-56G) 3Com 56K Modem (3CXM556) 3Com 56K Modem (3CXM356) 3Com 56K Modem (3CXM756) Billionton 56K Modem (FM56C-BF) Gold Card Glabal 56K+Fax
	LAN Card: D-Link Fast Ethernet DFE-650 D-Link CardBus DFE-660 3COM 10/100 CardBus LAN Card (3CCFE575CT) 3COM 10/100 CardBus LAN Card (3CCFE575BT) Xircom CreditCard Ethernet 10/100 (CE3B-100) Xircom CardBus Ethernet II 10/100 (CBE2-100)/32bit Linksys EtherFast PC Card PCM100 RATOC REX-CB80 Accton 16bit Ethernet (EN2216-2) Pci_ Fast Ethernet Card FNW-3602-TX
	SCSI: Adaptec SlimSCSI APA-1460D Card Adaptec SlimSCSI 1480A CardBus UltraSCSI Card
	LAN+Modem Card: 3COM 10/100 LAN+56k Modem Card (3CCFEM556B) 3COM 10/100 LAN+56k Modem Card (3CXFEM656C) Xircom CreditCard Ethernet + Modem 56k (CEM56-100)
	ATA Card: IBM Microdrives 340MB PCMCIA IDE/ATAPI Controller(FLASH/32MB) IOMEGA CliK! PC CARD DRIVE Passport CardBus + HDD Travel HDD 3.2GB + Passport CardBus /ACCURITE Compaq 1394 CardBus Card IEEE 1394 CardBus Card\DV Magician\UPMOST
	1394 CardBus Card: Compaq Flash 96MB
	Wireless LAN Card: COMPAQ Wireless LAN Card \WL 100 Wireless LAN Card \ WL-211F CISCO AIRONET 350 SERIES\AIR-PCM350
	Bluetooth Card: 3Com BlueTooth Card(3CRWB6096)

Item	Specifications
	MMC Card: SanDisk 64MB PQI 64MB Apacer 32MB Apacer 64MB
	MS Card: SONY 128MB Apacer 128MB
	SD Card: SanDisk 128MB Apacer 128MB Toshiba 128MB
	SM Card: SanDisk 128MB Transcend 128MB Apacer 128MB
	CF Card: SanDisk 4MB SanDisk 4MB Canon FC-16M
USB Port	USB Mouse: Microsoft Optical Mouse\IET78CJ TARGUS Wheel Mouse Logitech Wheel Mouse BE-58 Logitech Optical Mouse M-BD58 Logitech Optical Mouse M-un58a Acer USB Mouse M012BO eenius USB Mouse
	USB Keyboard: Microsoft Internet Keyboard Pro SILITEK K/B SK-6000 NMB K/B
	USB Camera: Logitech QuickCam Home Dlink DSC 350 USB CCD Intel YC72 CREATIVE Video BLASTER WEBCAM GO Plus
	USB CCD: Intel USB CCD /CS430
	USB HDD: USB DRIVE 128MB Apacer HandyDrive 256MB HITACHI DK23EA-60 (60GB) IEEE 1394 (Fire Wire)/USB 1.1 Combo Hard Drive\FUJITSU MHS2030AT;18.6GB
	USB CD-ROM/W: YAMAHA CRW-70 PHILIPS JR24CDRW/17
	USB Printer: HP DeskJet 930C HP DeskJet 840C

Item	Specifications
	USB FDD: MIC USB FDD YD-8U10 Logitech USB FDD Teac USB FDD(FD-05PUB)
	USB LAN: Billionton USB-10/100 FastEthernet USB-100B BUFFALD USB-10/100M Ethernet LUA-TX
	USB Zip: Iomega ZIP 250 Iomega ZIP-100
	USB Scanner: HP ScanJet 5300C
	USB Speaker: Philips UPS DSS330 Speaker
	USB Hub: PCI_ USB HUB\UH-400 General purpose USB Hub /UH-9124
	USB Gamepad: Microsoft Sidewinder Gamepad Logitech WingMan GAMEPAD EXTREME Logitech WingMan RUMBLEPAD
	USB Card Reader: CARRY 6 in 1 Image Card Reader \POCFSM-USB Pro Compact Flash Card Reader KINOMAX Compact Flash Card Reader
Audio Jack	JS-100 Jazz 3D Speaker J-S 3D Speaker /J-2201W J-S 3D Speaker /J-2202 SANYO 3D Speaker/OTTO-301 DELL harman/kardon Ladtec ELITE-840 SONY Earphone MDR-CD60 Panasonic Earphone RP-H1254 Philips Earphone Alwa Earphone
Microphone	Alwa Mini Microphone Labtec Verse 504
Access Point	Intel Access Point
Bluetooth	Bluetooth mobile phone: Sony Ericsson Fujitsu PDA Nokia Mobile phone : 8910
Port Replicator	Acer Port Replicator

Microsoft® Windows® 2000 Environment Test

Item	Specifications
Display	LCD Philips 109P 10 CRT Philips Brilliance 109P 19" CRT Dell Trinitron 21" CRT Silicon Graphics 21" CRT ViewSonic GS773 CRT ViewSonic GS790 CRT Trinitron D1626HT 21" for DELL LCD FPD 1530 CRT DELL \2000FP
Parallel Port	Printer: HP Laser Jet 5M HP Desk Jet 930C HP Desk Jet 840C HP Laser Jet 2100 IOMega ZIP 250 (LPT Port)
Parallel Port	Cable: ECP Cable
1394 Port	HDD: 1394 4GB HDD\VST FireWire Hard Drive 1394 HDD /IEEE 1394 (Fire Wire)/USB 1.1 Combo Hard Drive\FUJITSU MHS2030AT;18.6GB 1394 CCD: Stealth Fire 1394 HUB: Aten 1394 HUB/FH-600 1394 External HDDCase: Storage BOX (2500E) 1394Video Camera: 1394 SONY DV/DCR-PC100 1394 MO: FUJITSU LIMITED MDF3130EE
Projector	Panasonic PT_L757U Acer 7755c
USB 2.0	HUB: Highspeed\4 Port Adaptec\4 Port (XHUB4) for DELL
USB 2.0	HDD: logear HI-SPEE HDD USB 2.0 Enclosure\GHE125U logear HI-SPEE HDD USB 2.0 EXTERNAL LACIE For DELL USB DRIVE 128MB USB DRIVE 256MB CardBus Card: logear GPU202 USB CDR/W: YAMAHA CRW-70 Ricoh MP5125A DVD+RW/+R LACIE (16*10*40) For DELL USB DVD/CD-RW (Pioneer DVR-104)
GB LAN HUB	3 Com GB LAN Hub
PS/2 Port	Keyboard: Microsoft Natural Keyboard Gateway SK-9920 Acer 6311-TW

Item	Specifications
	Keypad: PC Concepts Keypad KB-5640
	Mouse: COMPAQ Mouse M-SF14-2 COMPAQ Mouse M-S48a Logitech Mouse \M-S35 PSC QUICKSCAN 6000plus Only Support S3,Hut Plug
S-Video	TV: DELL \2000FP
PC Card	Modem Card: Xircom CreditCard Modem 56 (CM-56G) 3Com 56K Modem (3CXM556) 3Com 56K Modem (3CXM356) 3Com 56K Modem (3CXM756) Billionton 56K Modem (FM56C-BF) Gold Card Global 56K+Fax
	LAN Card: D-Link Fast Ethernet DFE-650 D-Link CardBus DFE-660 3COM 10/100 CardBus LAN Card (3CCFE575CT) 3COM 10/100 CardBus LAN Card (3CCFE575BT) Xircom CreditCard Ethernet 10/100 (CE3B-100) Xircom CardBus Ethernet II 10/100 (CBE2-100)/32bit RATOC REX-CB80 Accton 16bit Ethernet (EN2216-2) Pci_ Fast Ethernet Card FNW-3602-TX
	SCSI: Adaptec SlimSCSI APA-1460D Card Adaptec SlimSCSI 1480A CardBus UltraSCSI Card
	LAN+Modem Card: 3COM 10/100 LAN+56k Modem Card (3CCFEM556B) 3COM 10/100 LAN+56k Modem Card (3CXFEM656C) Xircom CreditCard Ethernet + Modem 56k (CEM56-100)
	ATA Card: IBM Microdrives 340MB PCMCIA IDE/ATAPI Controller(FLASH/32MB) IOMEGA CliK! PC CARD DRIVE Passport CardBus + HDD Travel HDD 3.2GB + Passport CardBus /ACCURITE Compaq 1394 CardBus Card IEEE 1394 CardBus Card\DV Magician\UPMOST
	1394 CardBus Card: Compaq Flash 96MB
	Wireless LAN Card: COMPAQ Wireless LAN Card \WL 100 Wireless LAN Card \ WL-211F
	Bluetooth Card: 3Com BlueTooth Card(3CRWB6096)

Item	Specifications
	MMC Card: SanDisk 64MB PQI 64MB Apacer 32MB Apacer 64MB
	MS Card: SONY 128MB Apacer 128MB
	SD Card: SanDisk 128MB Apacer 128MB Toshiba 128MB
	SM Card: SanDisk 128MB Transcend 128MB Apacer 128MB
	CF Card: SanDisk 4MB SanDisk 4MB Canon FC-16M
USB Port	USB Mouse: Microsoft Optical Mouse\IET78CJ TARGUS Wheel Mouse Logitech Wheel Mouse BE-58 Logitech Optical Mouse M-BD58 Logitech Optical Mouse M-un58a Acer USB Mouse M012BO eenius USB Mouse
	USB Keyboard: Microsoft Internet Keyboard Pro SILITEK K/B SK-6000 NMB K/B
	USB Camera: Logitech QuickCam Home Dlink DSC 350 USB CCD Intel YC72 CREATIVE Video BLASTER WEBCAM GO Plus
	USB CCD: Intel USB CCD /CS430
	USB HDD: USB DRIVE 128MB Apacer HandyDrive 256MB HITACHI DK23EA-60 (60GB) IEEE 1394 (Fire Wire)/USB 1.1 Combo Hard Drive\FUJITSU MHS2030AT;18.6GB
	USB CD-ROM/W: YAMAHA CRW-70 PHILIPS JR24CDRW/17
	USB Printer: HP DeskJet 930C HP DeskJet 840C

Item	Specifications
	USB FDD: MIC USB FDD YD-8U10 Logitech USB FDD Teac USB FDD(FD-05PUB)
	USB LAN: Billionton USB-10/100 FastEthernet USB-100B BUFFALD USB-10/100M Ethernet LUA-TX
	USB Zip: Iomega ZIP 250 Iomega ZIP-100
	USB Scanner: HP ScanJet 5300C
	USB Speaker: Philips UPS DSS330 Speaker
	USB Hub: PCI_ USB HUB/UH-400 General purpose USB Hub /UH-9124
	USB Gamepad: Microsoft Sidewinder Gamepad Logitech WingMan GAMEPAD EXTREME Logitech WingMan RUMBLEPAD
	USB Card Reader: CARRY 6 in 1 Image Card Reader \POCFSM-USB Pro Compact Flash Card Reader KINOMAX Compact Flash Card Reader
Audio Jack	JS-100 Jazz 3D Speaker J-S 3D Speaker /J-2201W J-S 3D Speaker /J-2202 SANYO 3D Speaker/OTTO-301 DELL harman/kardon Ladtec ELITE-840 SONY Earphone MDR-CD60 Panasonic Earphone RP-H1254 Philips Earphone Alwa Earphone
Microphone	Alwa Mini Microphone Labtec Verse 504
Access Point	Intel Access Point
Bluetooth	Bluetooth mobile phone: Sony Ericsson Fujitsu PDA Nokia Mobile phone : 8910
Port Replicator	Acer Port Replicator

Online Support Information

This section describes online technical support services available to help you repair your Acer Systems.

If you are a distributor, dealer, ASP or TPM, please refer your technical queries to your local Acer branch office. Acer Branch Offices and Regional Business Units may access our website. However some information sources will require a user i.d. and password. These can be obtained directly from Acer CSD Taiwan.

Acer's Website offers you convenient and valuable support resources whenever you need them.

In the Technical Information section you can download information on all of Acer's Notebook, Desktop and Server models including:

- Service guides for all models
- User's manuals
- Training materials
- Bios updates
- Software utilities
- Spare parts lists
- TABs (Technical Announcement Bulletin)

For these purposes, we have included an Acrobat File to facilitate the problem-free downloading of our technical material.

Also contained on this website are:

- Detailed information on Acer's International Traveler's Warranty (ITW)
- Returned material authorization procedures
- An overview of all the support services we offer, accompanied by a list of telephone, fax and email contacts for all your technical queries.

We are always looking for ways to optimize and improve our services, so if you have any suggestions or comments, please do not hesitate to communicate these to us.

A

ACPI 1.0a 24
 AFLASH Utility 47

B

Battery Pack 53
 BIOS 24

- package 24
- password control 24
- ROM size 24
- ROM type 24
- vendor 24
- Version 24

 BIOS Setup Utility 35
 BIOS Supports protocol 24
 BIOS Utility 35

- Basic System Settings 40
- Navigating 36
- Onboard Device Configuration 42
- Startup Configuration 41
- System Information 36
- System Security 46

 Board Layout 4

- Bottom View 5
- Top View 4

C

Cache

- controller 24
- size 24

 CardBus 29
 CPU

- core voltage 24
- package 24
- type 24

D

DIMM

- Combinations 25
- external 54
- removing 54

 Disassembly

- Battery Pack 52
- CD-ROM/DVD-ROM Module 57
- Floppy Disk Drive 61
- Procedure Flowchart 51

 Display 3

E

Error Symptom-to-Spare Part Index 69
 External CD-ROM Drive Check 66
 External Diskette Drive Check 66

F

Features 1
 Flash Utility 47
 Floppy Disk

- removing the 61

 FRU (Field Replaceable Unit) List 85

H

Hard disk 26
 HDD 26
 Hot Keys 14

I

Indicators 13
 Intermittent Problems 80

J

Jumper and Connector Locations 83

- Top View 83

K

Keyboard 30
 Keyboard or Auxiliary Input Device Check 66

L

L2 cache 24

M

Memory Check 67
 Model Definition 104
 Modem 25

O

Online Support Information 115

P

Panel 6

- Bottom 12
- left 6
- Rear 10
- right 10

 Parallel Port 28

PC Card 13, 29
PCMCIA 29
Pentium III 24
Power System Check 67
 Battery Pack 68
Processor 24

R

RMA 85

S

Second Level Cache 24
System
 Block Diagram 3
 Layout 4
System Diagnostic Diskette 47
System Memory 24
System Utilities 35
System Utility Diskette 47

T

Test Compatible Components 105
Touchpad Check 68
Troubleshooting 65

U

Undetermined Problems 81
USB 29
utility
 BIOS 35

V

Video
 Resolutions 28

W

Windows 2000 Environment Test 106, 110

