

Aspire 5530/5530G Series Service Guide

Service guide files and updates are available on the ACER/CSD web; for more information, please refer to <http://csd.acer.com.tw>

PRINTED IN TAIWAN

Revision History

Please refer to the table below for the updates made on Aspire 5530/5530G Series service guide.

Date	Chapter	Updates

Copyright

Copyright © 2008 by Acer Incorporated. All rights reserved. No part of this publication may be reproduced, transmitted, transcribed, stored in a retrieval system, or translated into any language or computer language, in any form or by any means, electronic, mechanical, magnetic, optical, chemical, manual or otherwise, without the prior written permission of Acer Incorporated.

Disclaimer

The information in this guide is subject to change without notice.

Acer Incorporated makes no representations or warranties, either expressed or implied, with respect to the contents hereof and specifically disclaims any warranties of merchantability or fitness for any particular purpose. Any Acer Incorporated software described in this manual is sold or licensed *as is*. Should the programs prove defective following their purchase, the buyer (and not Acer Incorporated, its distributor, or its dealer) assumes the entire cost of all necessary servicing, repair, and any incidental or consequential damages resulting from any defect in the software.

Acer is a registered trademark of Acer Corporation.

Intel is a registered trademark of Intel Corporation.

Pentium and Pentium II/III are trademarks of Intel Corporation.

Other brand and product names are trademarks and/or registered trademarks of their respective holders.

Conventions

The following conventions are used in this manual:

SCREEN MESSAGES	Denotes actual messages that appear on screen.
NOTE	Gives bits and pieces of additional information related to the current topic.
WARNING	Alerts you to any damage that might result from doing or not doing specific actions.
CAUTION	Gives precautionary measures to avoid possible hardware or software problems.
IMPORTANT	Reminds you to do specific actions relevant to the accomplishment of procedures.

Preface

Before using this information and the product it supports, please read the following general information.

1. This Service Guide provides you with all technical information relating to the BASIC CONFIGURATION decided for Acer's *global* product offering. To better fit local market requirements and enhance product competitiveness, your regional office MAY have decided to extend the functionality of a machine (e.g. add-on card, modem, or extra memory capability). These LOCALIZED FEATURES will NOT be covered in this generic service guide. In such cases, please contact your regional offices or the responsible personnel/channel to provide you with further technical details.
2. Please note WHEN ORDERING FRU PARTS, that you should check the most up-to-date information available on your regional web or channel. If, for whatever reason, a part number change is made, it will not be noted in the printed Service Guide. For ACER-AUTHORIZED SERVICE PROVIDERS, your Acer office may have a DIFFERENT part number code to those given in the FRU list of this printed Service Guide. You MUST use the list provided by your regional Acer office to order FRU parts for repair and service of customer machines.

System Specifications	1
Features	1
System Block Diagram	4
Your Acer Notebook tour	5
Front View	5
Closed Front View	6
Left View	7
Right View	8
Rear View	8
Bottom View	9
Indicators	10
Easy-Launch Buttons	10
Touchpad Basics (with fingerprint reader)	11
Using the Keyboard	12
Lock Keys and embedded numeric keypad	12
Windows Keys	13
Hot Keys	14
Special Key	15
Using the System Utilities	16
Acer GridVista (dual-display compatible)	16
Hardware Specifications and Configurations	18
 System Utilities	 27
BIOS Setup Utility	27
Navigating the BIOS Utility	27
Information	28
Main	29
Advanced	30
Security	32
Power	35
Boot	36
AMD	37
Exit	38
BIOS Flash Utility	39
DOS Flash Utility	40
WinFlash Utility	41
Removing HDD Passwords	42
Removing BIOS Passwords:	45
 Machine Disassembly and Replacement	 47
Disassembly Requirements	47
General Information	48
Pre-disassembly Instructions	48
Disassembly Process	48
External Module Disassembly Process	49
External Modules Disassembly Flowchart	49
Removing the Battery Pack	50
Removing the SD dummy card	51
Removing the ExpressCard dummy card	52
Removing the Lower Covers	53
Removing the DIMM Modules	55
Removing the WLAN Module	56
Removing the TV tuner Module	58
Removing the Hard Disk Drive Module	60

Table of Contents

Removing the Optical Drive Module	62
Main Unit Disassembly Process	64
Main Unit Disassembly Flowchart	64
Removing the Switch Cover	66
Removing the Keyboard	67
Removing the Antenna	68
Removing the LCD Module	70
Removing the Upper Cover	72
Removing the Finger Print Reader	76
Removing the Upper Right Saddle	77
Removing the Left Speaker Module	78
Removing the Upper Left Saddle	79
Removing the Touch Pad Bracket	80
Removing the Launch Board	82
Removing the Media Board	82
Removing the eKey Board	83
Removing the Switch Board	85
Removing the Right Speaker Module	86
Removing the TV Board	87
Removing the Bluetooth Module	88
Removing the USB Board	89
Removing the Modem Module	90
Removing the Subwoofer Module	91
Removing the Main Board	92
Removing the RJ-11 Port	94
Removing the Thermal Module	95
Removing the CPU	97
Removing the VGA Module	98
LCD Module Disassembly Process	99
LCD Module Disassembly Flowchart	99
Removing the LCD Bezel	100
Removing the Inverter Board	101
Removing the Camera Module	103
Removing the LCD Panel	105
Removing the LCD Brackets and FPC Cable	106
Removing the Antennas	107
Removing the MIC Module	108
LCD Module Reassembly Procedure	109
Replacing the LCD Panel	109
Replacing the LCD Bezel	113
Main Module Reassembly Procedure	114
Replacing the VGA Module	114
Replacing the CPU	114
Replacing the Thermal Module	115
Replacing the RJ-11 Port	115
Replacing the Mainboard	117
Replacing Subwoofer Module	118
Replacing the Modem Module	118
Replacing the Bluetooth Board	120
Replacing the TV Board	120
Replacing the Right Speaker Module	121
Replacing the Switch Board	122
Replacing the eKey Board	122
Replacing the Media Board	124
Replacing the Upper Right Saddle	125

Table of Contents

Replacing the Launch Board	126
Replacing the Finger Print Reader	126
Replacing the Touch Pad Bracket	128
Replacing the Left Speaker Module	129
Replacing the Upper Cover	129
Replacing the LCD Module	131
Replacing the Antenna Cables	133
Replacing the Keyboard	134
Replacing the Switch Cover	134
Replacing the TV Tuner Module	135
Replacing the WLAN Module	137
Replacing the Hard Disk Drive Module	137
Replacing the DIMM Modules	138
Replacing the ODD Module	139
Replacing the Lower Covers	140
Replacing the Express and SD Card Trays	141
Troubleshooting	143
Common Problems	143
Power On Issue	144
No Display Issue	145
Random Loss of BIOS Settings	146
LCD Failure	147
Built-In Keyboard Failure	147
Touchpad Failure	148
Internal Speaker Failure	148
Internal Microphone Failure	150
HDD Not Operating Correctly	151
ODD Failure	152
USB Failure (Rightside)	155
Modem Function Failure	155
Wireless Function Failure	156
EasyTouch Button Failure	156
MediaTouch Button Failure	157
Fingerprint Reader Failure	157
Thermal Unit Failure	158
HDTV Switch Failure	158
External Mouse Failure	159
Other Failures	159
Intermittent Problems	160
Undetermined Problems	160
POST Codes Tables	161
Chipset POST Codes	161
Jumper and Connector Locations	165
Top View	165
Bottom View	166
Clearing Password Check and BIOS Recovery	167
Clearing Password Check	167
BIOS Recovery by Crisis Disk	168
FRU (Field Replaceable Unit) List	171
Aspire 5530 Exploded Diagrams	172
Discrete SKU	172
UMA SKU	173

Table of Contents

Aspire 5530 FRU List	174
Model Definition and Configuration	184
Aspire 5530 Series	184
Test Compatible Components	187
Microsoft® Windows® Vista Environment Test	188
With Fingerprint Reader SKU	188
Without Fingerprint Reader SKU	190
Online Support Information	193
Index	195

System Specifications

Features

Below is a brief summary of the computer's many feature:

NOTE: Items marked with * denote only selected models.

Operating System

- Windows® Vista™

Platform

- AMD Better By Design program, featuring:
 - AMD Turion™ Dual-Core Processor*
 - AMD Athlon™ Dual-Core Processor*
 - AMD M780G Chipset
 - Acer InviLink™ 802.11b/g*
 - Acer InviLink™ Nplify™ 802.11b/g/Draft-N*

System Memory

- Dual-Channel DDR2 support
- Up to 2 GB of DDR2 667 MHz memory, upgradeable to 4 GB using two soDIMM modules

Display and graphics

- 15.4" WXGA 1280 x 800
- ATI Mobility Radeon™ HD 3200/3470/3650 Graphics (for Aspire 5530G only)

TV Tuner

- Digital TV-tuner supporting DVB-T*

Storage subsystem

- 2.5" hard disk drive
- Optical drive options:
 - Blu-ray Disc™ /DVD-Super Multi double-layerdrive
 - DVD-Super Multi double-layer drive
- 5-in-1 card reader

Dimensions and Weight

- 364.6 (W) x 272.3 (D) x 30.8/43.7 (H) mm (14.3 x 10.6 x 1.2/1.7 inches)
- 3.0 kg (6.61 lbs)

Audio

- Dolby® certified surround sound system with two built-in stereo speakers and one subwoofer supporting low-frequency effects
- S/PDIF (Sony/Philips Digital Interface) support for digital speakers
- True5.1-channel surround sound output
- High-definition audio support
- MS-Sound compatible
- Built-in microphone

Communication

- Acer Video Conference, featuring:
 - Integrated Acer Crystal Eye webcam
 - Optional Acer Xpress VoIP phone
- WLAN:
 - Acer InViLink™ 802.11b/g*
 - Acer InViLink™ Nplify™ 802.11b/g/Draft-N*
- WPAN: Bluetooth® 2.0+EDR
- LAN: Gigabit Ethernet, Wake-on-LAN ready
- Modem: 56K ITU V.92

Privacy control

- Acer Bio-Protection fingerprint solution
- BIOS user, supervisor, HDD passwords
- Kensington lock slot

Power subsystem

- ACPI 3.0
- 71 W 4800 mAh
- 48.8 W 4400 mAh
- 3-pin 65/90 W AC adapter*
- Energy Star 4.0

Special keys and controls

- 88-/89-/93-key keyboard
- Touchpad pointing device
- Empowering Key
- Easy-launch buttons: WLAN, Internet, email, Bluetooth, Acer Arcade™
- Acer MediaTouch keys: play/pause, stop, previous, next
- Volume wheel
- Acer Media Center remote control*

I/O interface

- ExpressCard™/54 slot
- 5-in-1 card reader (SD™, MMC, MS, MS PRO, xD)
- Four USB 2.0 ports
- HDMI™ port with HDCP support
- Consumer infrared (CIR) port
- External display (VGA) port
- RF-in jack*
- Headphone/speaker/line-out jack with S/PDIF support
- Microphone-in jack
- Line-in jack
- Ethernet (RJ-45) port
- Modem (RJ-11) port
- DC-in jack for AC adapter
- Acer EasyPort IV connector

Environment

- Temperature:
 - Operating: 5 °C to 35 °C
 - Non-operating: -20 °C to 65 °C
- Humidity (non-condensing):
 - Operating: 20% to 80%
 - Non-operating: 20% to 80%

NOTE: Items marked with * denote only selected models.

Your Acer Notebook tour

After knowing your computer features, let us show you around your new computer.

Front View





No.	Icon	Item	Description
1		Microphone	Internal microphone for sound recording.
2		Acer Crystal Eye	Web camera for video communication.
3		Display screen	Also called Liquid-Crystal Display (LCD), displays computer output.
4		Power button	Turns the computer on and off.
5		Speakers	Left and right speakers deliver stereo audio output.
6		Easy-launch buttons	Buttons for launching frequently used program.
7		Keyboard	For entering data into your computer.
8		Palmrest	Comfortable support area for your hands when you use the computer.
9		Touchpad	Touch-sensitive pointing device which functions like a computer mouse.

No.	Icon	Item	Description
10		Click buttons (left, center* and right)	The left and right buttons function like the left and right mouse buttons. *The center button serves as Acer Bio-Protection fingerprint reader supporting Acer FingerNav 4-way control function (only for certain models).
11		Status indicators	Light-Emitting Diodes (LEDs) that light up to show the status of the computer's functions and components.
12		Acer MediaTouch keys	For use with Acer Arcade and other media playing programs.
13		Empowering key	Launch Acer Empowering Technology.
14		Status indicators	Light-Emitting Diodes (LEDs) that light up to show the status of the computer's functions and components.

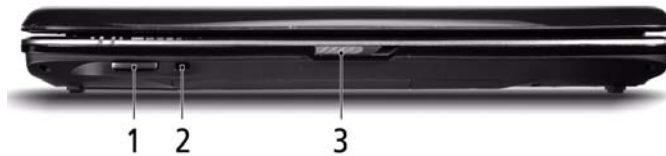





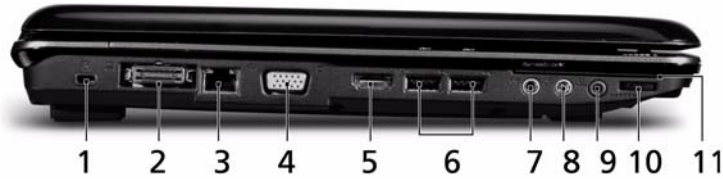

Closed Front View



No.	Icon	Item	Description
1		5-in-1 card reader	Accepts Secure Digital (SD), MultiMediaCard (MMC), Memory Stick (MS), Memory Stick PRO (MS PRO), xD-Picture Card (xD).
2		CIR receiver	Receives signals from a remote control.
3		Latch	Locks and releases the lid





Left View

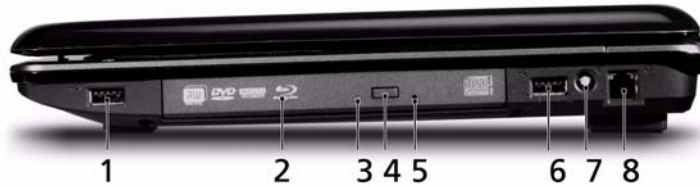

No.	Icon	Item	Description
1		Kensington lock slot	Connects to a Kensington-compatible computer security lock.
2		Acer EasyPort IV connector	Connects to Acer EasyPort IV.
3		Ethernet (RJ-45) port	Connects to an Ethernet 10/100/1000-based network.
4		External display (VGA) port	Connects to a display device (e.g. external monitor, LCD projector).
5	HDMI	HDMI	Connects to a television or display device with HDMI input.
6		2 USB 2.0 ports	Connect to USB 2.0 devices (e.g. USB mouse, USB camera).
7		Line-in jack	Accepts audio line-in devices (e.g. audio CD player, stereo walkman).
8		Microphone-in jack	Accepts input from external microphones.
9		Headphones/speaker/line-out jack with S/PDIF support	Connects to audio line-out devices (e.g. speakers, headphones).
10		Unlimited volume control wheel	Adjust the volume of the audio-out.
11	ExpressCard / 54	ExpressCard/54 slot	Accepts one ExpressCard/54 module.

Right View



No.	Icon	Item	Description
1		USB 2.0 port	Connect to USB 2.0 devices (e.g. USB mouse, USB camera).
2		Optical drive	Internal optical drive; accepts CDs or DVDs.
3		Optical disk access indicator	Lights up when the optical drive is active.
4		Optical drive eject button	Ejects the optical disk from the drive.
5		Emergency eject hole	Ejects the optical drive tray when the computer is turned off. Note: Insert a paper clip into the emergency eject hole to eject the optical drive tray when the computer is off.
6		USB 2.0 port	Connect to USB 2.0 devices (e.g. USB mouse, USB camera).
7		RF-in Port	Accepts input signals from digital TV tuner devices (only for certain models).
8		Modem (RJ-11) port	Connects to a phone line.





Rear View

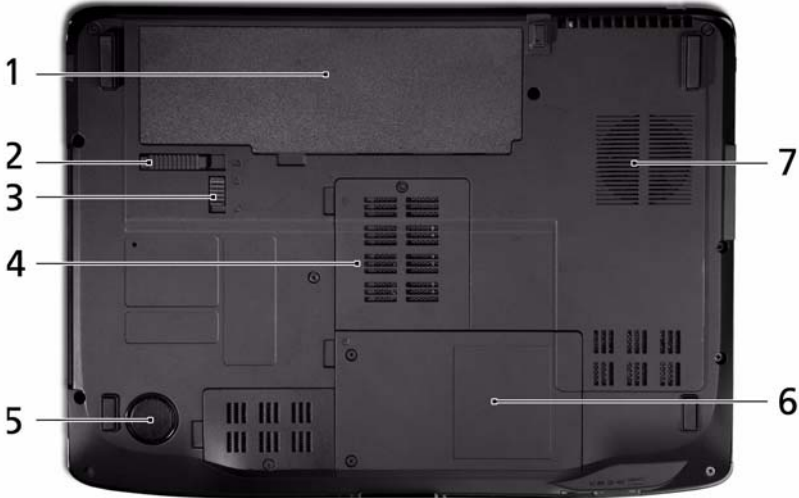

No.	Icon	Item	Description
1		DC-in jack	Connects to an AC adapter
2		Ventilation slots	Enable the computer to stay cool, even after prolonged use.

Bottom View







No.	Icon	Item	Description
1		Battery bay	Houses the computer's battery pack.
2		Battery release latch	Releases the battery for removal.
3		Battery lock	Locks the battery in position.
4		Memory compartment	Houses the computer's main memory.
5		Sub-woofer	Emits low frequency sound output.
6		Hard disk bay	Houses the computer's hard disk (secured with screws).
7		Ventilation slots and cooling fan	Enable the computer to stay cool, even after prolonged use. Note: Do not cover or obstruct the opening of the fan.

Indicators

The computer has several easy-to-read status indicators:

The front panel indicators are visible even when the computer cover is closed.







Icon	Function	Description
	Power	Indicates the computer's power status.
	Battery	Indicates the computer's battery status.
	HDD	Indicates when the hard disk drive is active.
	Num Lock	Lights up when Num Lock is activated.
	Caps Lock	Lights up when Caps Lock is activated.

NOTE: 1. **Charging:** The light shows amber when the battery is charging. 2. **Fully charged:** The light shows green when in AC mode.

Easy-Launch Buttons

Located beside the keyboard are application buttons. These buttons are called easy-launch buttons. They are: WLAN, Internet, email, Bluetooth, Arcade and Acer Empowering Technology.

The mail and Web browser buttons are pre-set to email and Internet programs, but can be reset by users. To set the Web browser, mail and programmable buttons, run the Acer Launch Manager.

Icon	Function	Description
	Empowering Technology	Launch Acer Empowering Technology. (user-programmable)
	Acer Arcade	Launch Acer Arcade utility
	Wireless communication button/indicator	Enables/disables the wireless function. Indicates the status of wireless LAN communication.
	Web browser	Internet browser (user-Programmable)
	Mail	Email application (user-Programmable)
	Bluetooth communication button/indicator	Enables/disables the Bluetooth function. Indicates the status of Bluetooth communication.

Touchpad Basics (with fingerprint reader)

The following items show you how to use the touchpad with Acer Bio-Protection fingerprint reader:

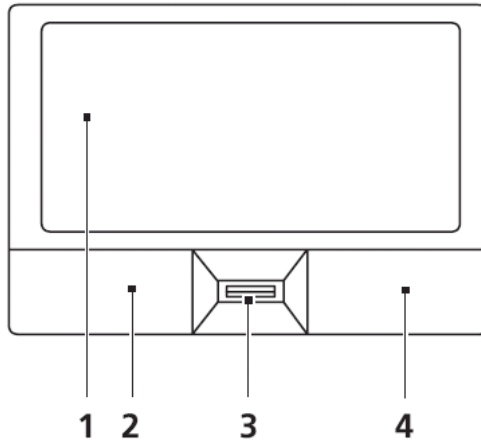

- Move your finger across the touchpad (2) to move the cursor.
- Press the left (1) and right (4) buttons located beneath the touchpad to perform selection and execution functions. These two buttons are similar to the left and right buttons on a mouse. Tapping on the touchpad is the same as clicking the left button.
- Use Acer Bio-Protection fingerprint reader (3) supporting Acer FingerNav 4-way control function (only for certain models) or the 4-way scroll (3) button (only for certain models) to scroll up or down and move left or right a page. This fingerprint reader or button mimics your cursor pressing on the right scroll bar of Windows applications.

Function	Left Button (1)	Right Button (3)	Main touchpad (2)
Execute	Quickly click twice.		Tap twice (at the same speed as double-clicking a mouse button).
Select	Click once.		Tap once.
Drag	Click and hold, then use finger on the touchpad to drag the cursor.		Tap twice (at the same speed as double-clicking a mouse button); rest your finger on the touchpad on the second tap and drag the cursor.
Access context menu		Click once.	

NOTE: When using the touchpad, keep it - and your fingers - dry and clean. The touchpad is sensitive to finger movement; hence, the lighter the touch, the better the response. Tapping too hard will not increase the touchpad's responsiveness.

Using the Keyboard

The keyboard has full-sized keys and an embedded numeric keypad, separate cursor, lock, Windows, function and special keys.

Lock Keys and embedded numeric keypad

The keyboard has three lock keys which you can toggle on and off.





















Lock key	Description
Caps Lock	When Caps Lock is on, all alphabetic characters typed are in uppercase.
Num Lock <Fn> + <F11>	When Num Lock is on, the embedded keypad is in numeric mode. The keys function as a calculator (complete with the arithmetic operators +, -, *, and /). Use this mode when you need to do a lot of numeric data entry. A better solution would be to connect an external keypad.
Scroll Lock <Fn> + <F12>	When Scroll Lock is on, the screen moves one line up or down when you press the up or down arrow keys respectively. Scroll Lock does not work with some applications.

The embedded numeric keypad functions like a desktop numeric keypad. It is indicated by small characters located on the upper right corner of the keycaps. To simplify the keyboard legend, cursor-control key symbols are not printed on the keys.

Desired access	Num Lock on	Num Lock off
Number keys on embedded keypad	Type numbers in a normal manner.	
Cursor-control keys on embedded keypad	Hold <Shift> while using cursor-control keys.	Hold <Fn> while using cursor-control keys.
Main keyboard keys	Hold <Fn> while typing letters on embedded keypad.	Type the letters in a normal manner.

Windows Keys

The keyboard has two keys that perform Windows-specific functions.

Key	Description
 Windows key	<p>Pressed alone, this key has the same effect as clicking on the Windows Start button; it launches the Start menu. It can also be used with other keys to provide a variety of functions:</p> <ul style="list-style-type: none"> <  >: Open or close the Start menu <  > + <D>: Display the desktop <  > + <E>: Open Windows Explore <  > + <F>: Search for a file or folder <  > + <G>: Cycle through Sidebar gadgets <  > + <L>: Lock your computer (if you are connected to a network domain), or switch users (if you're not connected to a network domain) <  > + <M>: Minimizes all windows <  > + <R>: Open the Run dialog box <  > + <T>: Cycle through programs on the taskbar <  > + <U>: Open Ease of Access Center <  > + <X>: Open Windows Mobility Center <  > + <BREAK>: Display the System Properties dialog box <  > + <SHIFT+M>: Restore minimized windows to the desktop <  > + <TAB>: Cycle through programs on the taskbar by using Windows Flip 3-D <  > + <SPACEBAR>: Bring all gadgets to the front and select Windows Sidebar <CTRL> + <  > + <F>: Search for computers (if you are on a network) <CTRL> + <  > + <TAB>: Use the arrow keys to cycle through programs on the taskbar by using Windows Flip 3-D <p>Note: Depending on your edition of Windows Vista, some shortcuts may not function as described.</p>
 Application key	<p>This key has the same effect as clicking the right mouse button; it opens the application's context menu.</p>

Hot Keys

The computer employs hotkeys or key combinations to access most of the computer's controls like screen brightness, volume output and the BIOS utility.

To activate hot keys, press and hold the <Fn> key before pressing the other key in the hotkey combination.



Hotkey	Icon	Function	Description
<Fn> + <F1>	?	Hotkey help	Displays help on hotkeys.
<Fn> + <F2>		Acer eSettings Management	Launches Acer eSettings Management in Acer Empowering Technology.
<Fn> + <F3>		Acer ePower Management	Launches Acer ePower Management in Acer Empowering Technology.
<Fn> + <F4>	Z ^z	Sleep	Puts the computer in Sleep mode.
<Fn> + <F5>		Display toggle	Switches display output between the display screen, external monitor (if connected) and both.
<Fn> + <F6>		Screen blank	Turns the display screen backlight off to save power. Press any key to return.
<Fn> + <F7>		Touchpad toggle	Turns the internal touchpad on and off.
<Fn> + <F8>		Speaker toggle	Turns the speakers on and off.
<Fn> + <D>		Brightness up	Increases the screen brightness.
<Fn> + <D>		Brightness down	Decreases the screen brightness.
<Fn> + <F1>	?	Hotkey help	Displays help on hotkeys.
<Fn> + <F2>		Acer eSettings Management	Launches Acer eSettings Management in Acer Empowering Technology.

Special Key

You can locate the Euro symbol and the US dollar sign at the upper-center and/or bottom-right of your keyboard.



The Euro symbol

1. Open a text editor or word processor.
2. Hold <Alt Gr> and then press the <5> key at the upper-center of the keyboard.

NOTE: Note: Some fonts and software do not support the Euro symbol. Please refer to www.microsoft.com/typography/faq/faq12.htm for more information.

The US dollar sign

1. Open a text editor or word processor.
2. Hold <Shift> and then press the <4> key at the upper-center of the keyboard.

NOTE: This function varies by the operating system version.

Using the System Utilities

Acer Bio-Protection (only for certain models) Acer Bio-Protection Fingerprint Solution is a multi-purpose fingerprint software package integrated with the Microsoft Windows operating system. Utilizing the uniqueness of one's fingerprint features, Acer Bio-Protection Fingerprint Solution has incorporated protection against unauthorized access to your computer with centralized password management with Password Bank, easy music player launching with Acer MusicLaunch, secure Internet favorites via Acer MyLaunch, and fast application/website launching and login with Acer FingerLaunch, while Acer ProfileLaunch can launch up to three applications/websites from a single finger swipe.

Acer Bio-Protection Fingerprint Solution also allows you to navigate through web browsers and documents using Acer FingerNav. With Acer Bio-Protection Fingerprint Solution, you can now enjoy an extra layer of protection for your personal computer, as well as the convenience of accessing your daily tasks with a simple swipe of your finger!

For more information refer to the Acer Bio-Protection help files.



Acer GridVista (dual-display compatible)

NOTE: This feature is only available on certain models.

To enable the dual monitor feature of the notebook, first ensure that the second monitor is connected, then select **Start, Control Panel, Display** and click on **Settings**. Select the secondary monitor (**2**) icon in the display box and then click the check box **Extend my windows desktop onto this monitor**. Finally, click **Apply** to confirm the new settings and click **OK** to complete the process.

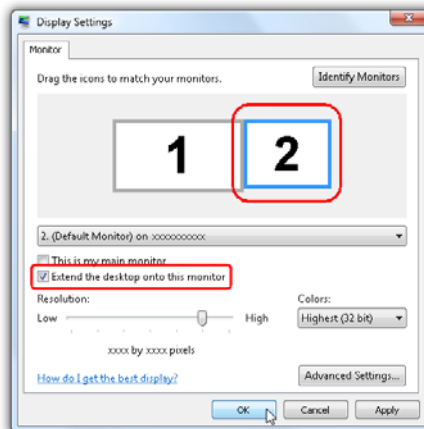

Acer GridVista is a handy utility that offers four pre-defined display settings so you can view multiple windows on the same screen. To access this function, please go to **Start → All Programs** and click on **Acer GridVista**. You may choose any one of the four display settings indicated below:



Double (vertical), Triple (primary at left), Triple (primary at right), or Quad Acer Gridvista is dual-display compatible, allowing two displays to be partitioned independently.

Acer Gridvista is dual-display compatible, allowing two displays to be partitioned independently.

AcerGridVista is simple to set up:

1. Run Acer GridVista and select your preferred screen configuration for each display from the task bar.
2. Drag and drop each window into the appropriate grid.
3. Enjoy the convenience of a well-organized desktop.

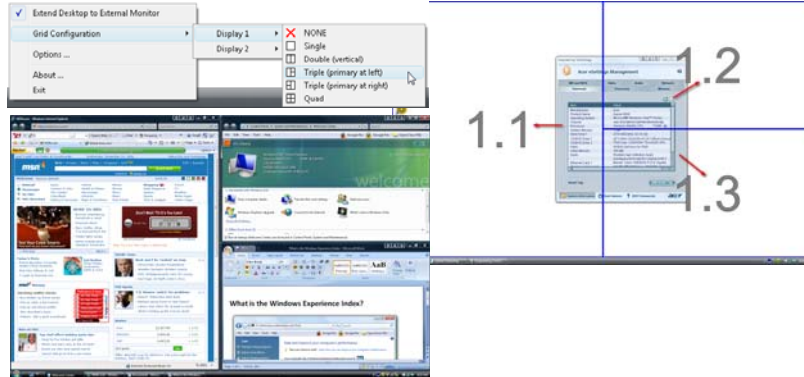

NOTE: Please ensure that the resolution setting of the second monitor is set to the manufacturer's recommended value.

Hardware Specifications and Configurations

Processor

Item	Specification
CPU type	Griffin - Turionx2 / Athlonx2 for MS/Griffin - Athlonx2 / Sempron for Value
Core logic	NB/SB AMD M780M/SB700
CPU package	Sig2 uPGA638
CPU core voltage	1.2V~0.8V

CPU Fan True Value Table

DTS (degree C°)	Fan Speed (rpm)	Acoustic Level (dBA)
55	2800	31
65	3200	34
75	3600	37
90	4000	40
100	4000	40

- CPU DTS Throttling 50% point = 100C; /recover 85C

BIOS

Item	Specification
BIOS vendor	Phoenix
BIOS Version	V0.19T1
BIOS ROM type	Flash
BIOS ROM size	2MB
BIOS package	ACPI 2.0 compliance with Intel Speed Step Support C1, C2, C3, C4, C6 and S3, S4 for mobile CPU
Supported protocols	<ul style="list-style-type: none"> • Support ISIPP • Support Acer UI • Support multi-boot • Suspend to RAM (S3)/Disk (S4) • Various hot-keys for system control • Support SMBUS 2.0, PCI2.3 • Support PXE • Support Y2K solution • Support Win Flash Wake on LAN from S3 • Wake on LAN form S4 in AC mode • System information • Support ASF 2.0 • Support iTPM (GM / PM Sku)

Cache

Item	Specification
Cache controller	CPU
Cache size	1MB for Turionx2/Athlonx2, 512KB for Simpron

System Memory

Item	Specification
Memory controller	Built-in

Item	Specification
Memory size	0MB (no on-board memory)
DIMM socket number	2 sockets
Supports memory size per socket	2 GB
Supports maximum memory size	4G for 64bit OS (with two 2GB SODIMM)
Supports DIMM type	DDR 2 Synchronous DRAM 667/800 MHz
Memory module combinations	You can install memory modules in any combinations as long as they match the above specifications.

Memory Combinations

Slot 1	Slot 2	Total Memory
0MB	512MB	512MB
0MB	1024MB	1024MB
0MB	2048MB	2048MB
512MB	512MB	1024MB
512MB	1024MB	1536MB
512MB	2048MB	2560MB
1024MB	0MB	1024MB
1024MB	512MB	1536MB
1024MB	1024MB	2048MB
1024MB	2048MB	3072MB
2048MB	0MB	2048MB
2048MB	512MB	2560MB
2048MB	1024MB	3072MB
2048MB	2048MB	4096MB

NOTE: Above table lists some system memory configurations. You may combine DIMMs with various capacities to form other combinations. On above table, the configuration of slot 1 and slot 2 could be reversed.

LAN Interface

Item	Specification
LAN Chipset	Broadcom BCM5764MKMLG
Supports LAN protocol	IEEE 802.3, 802.3u, 802.3ab, 802.3p
LAN connector type	RJ-45
LAN connector location	RJ-45 (right-rear side on the system)
Features	Gigabit Ethernet

Bluetooth Interface

Item	Specification
Chipset	BCM2045
Data throughput	3Mbps
Protocol	IEEE 802.15
Interface	USB
Connector type	mini-USB

Wireless Module 802.11b/g

Item	Specification
Chipset	BCM4312
Data throughput	54Mbps
Protocol	802.11b/g
Interface	pci-E

Hard Disk Drive Interface

Item	Specification				
Vendor & Model Name	Seagate ST9250827AS	Seagate ST9160310AS	Toshiba MK1246GSX	Toshiba MK1652GSX	Hitachi 5K320-320 5K320-250
Capacity (MB)	250	160	120	160	320, 250
Bytes per sector	512	512	512	512	512
Data heads	4	2	2	2	4, 4 or 3
Drive Format					
Disks	2	1	1	1	2, 2
Spindle speed (RPM)	5400	5400	5400	5400	5400
Performance Specifications					
Buffer size	8 MB	8 MB	8 MB	8 MB	8 MB
Interface	SATA	SATA	SATA	SATA	SATA
Internal transfer rate (Mbits/sec, max)	778	352	370 ~ 730 typical	400 ~ 794 typical	674 ~ 775
I/O data transfer rate (Mbytes/sec max)	300	150	300	300	1.5 / 3.0
DC Power Requirements					
Voltage tolerance	5V ±5%	5V ±5%	5V ±5%	5V ±5%	5V ±5%

Super-Multi Combo Module

Item	Specification
Manufacturer and Model	Sony DL 8X AD-7560S Toshiba DL 8X TS-L633A
Type	Drawer type
Interface	SATA
Data Transfer Modes	<ul style="list-style-type: none"> • PIO Mode4 • DMA Multiword Mode2 • ULTRA DMA Mode2
Buffer Memory Size	2 MB
Maximum Write Speed	<ul style="list-style-type: none"> • CD-R Max. 24X (3,600 KB/sec) • DVD+RW Max 8X (10,800 KB/sec)
Maximum Read Speed	<ul style="list-style-type: none"> • CD 3,600 KB/sec • DVD 10,800 KB/sec
Format Compatibility	<p>CD</p> <ul style="list-style-type: none"> • CD-DA (Red Book) - Standard Audio CD & CD-TEXT • CD-ROM (Yellow Book Mode1 & 2) - Standard Data • CD-ROM XA (Mode2 Form1 & 2) - Photo CD, Multi-Session • CD-I (Green Book, Mode2 Form1 & 2, Ready, Bridge) • CD-Extra/ CD-Plus (Blue Book) - Audio & Text/Video • Video-CD (White Book) - MPEG1 Video • CD-R (Orange Book Part 1 & 2) • CD-RW & HSRW (Orange Book Part IV Volume1 & Volume2) • Super Audio CD (SACD) Hybrid type • US & US+ RW <p>DVD</p> <ul style="list-style-type: none"> • DVD-ROM (Book 1.02), DVD-Dual • DVD-Video (Book 1.1) • DVD-R (Book 1.0, 3.9G) • DVD-R (Book 2.0, 4.7G) - General & Authoring • DVD+R (Version 1.0) • DVD+RW • DVD-RW (Non CPRM & CPRM) • DVD±R Dual • DVD-RAM
Power Supply	DC +5V / 1.3A
Voltage Allowance	DC +5V (5% (Operating), DC +5V(8% (Start Up)))

Combo Drive Module

Item	Specification
Manufacturer and Model	Sony NEC Optiarc BC-5500S-AR
Type	Drawer loading
Interface	SATA
Data Transfer Modes	<ul style="list-style-type: none"> PIO mode DMA Ultra DMA33
Buffer Memory Size	4.5 MB
Maximum Write Speed	11 Mbytes/sec
Maximum Read Speed	9 Mbytes/sec
Formats Supported	<p>Read</p> <ul style="list-style-type: none"> BD-Video (12cm, Single and Dual Layer), BD-ROM (12cm, Single and Dual Layer) DVD-Video (8cm/12cm, Single and Dual Layer), DVD-ROM (8cm/12cm, Single and Dual Layer), Multi-Boarder, Multi-Session <p>CD Write</p> <ul style="list-style-type: none"> CD-R Media (48x/40x/32x/24x/16x/8x) Mitsubishi (Verbatim), Taiyo-Yuden, Mitsui, Ricoh, Fuji film, Sony, Hitachi Maxell, Memorex, RITEK, CMC, P.V.C, JVC, SKC, ACER, Prime Disc, TDK CD-RW Media (10x/4x) Ricoh, Mitsubishi (Verbatim), ACER, OPTROM, Memorex, P.V.C, RITEK, CMC, LEADDATA, GigaStorage, Prodisc, Fornex, Samsung, Philips <p>DVD Write</p> <ul style="list-style-type: none"> DVD+R Media (16x/8x/4x/2.4x) Taiyo-Yuden, Mitsubishi (Verbatim), Ricoh, TDK DVD+R Double Layer Media (8x/2.4x) Mitsubishi (Verbatim) DVD+RW Media (8x/4x/2.4x) Mitsubishi (Verbatim), Ricoh, TDK DVD-R Media (16x/8x/4x/2x) Mitsubishi (Verbatim), TDK, Taiyo-Yuden, PVC, Fuji Film, Ritek DVD-R DL Media (8x/4x) Mitsubishi (Verbatim) DVD-RW Media (6x/4x/2x/1x) JVC, PVC, Mitsubishi (Verbatim), TDK DVD-RAM Ver2.2 Media (5x/3x/2x) Panasonic, Hitachi Maxell
Power Supply	+5V (DC)
Voltage Allowance	+5V (DC) ±5%

Audio Interface

Item	Specification
Audio Controller	Realtek ALC888S
Audio onboard or optional	Onboard
Mono or Stereo	Stereo
Resolution	DAC support 16/20/24bit, ADC support 16/20bit
Compatibility	Microsoft WLP3.02, Vista WaveRT, Dolby Home Theater
Sampling rate	DAC support 192Kbit, ADC support 96Kbit sample rate
Internal microphone	Analog Microphone*1
Internal speaker / Quantity	2W Internal speakers*2, Subwoofer*1

Video Memory

Item	Specification
Chipset	RS780MN for UMA, M82ME-XT/M86ME for Discrete
Memory size	Up to 512MB for Discrete SKU

USB Interface

Item	Specification
Chipset	AMD SB700
USB Compliancy Level	Support USB 1.1 and 2.0
OHCI	5 OHCI and 2 EHCI controller
Number of USB port	Chipset support 12 port(4 external port on the system)
Location	2 ports on the right side, 2 ports on the left side
Serial port function control	N/A

System Board Major Chips

Item	Controller
Core logic	AMD RS780MN+SB700
VGA	AMD RS780MN for UMA, M82ME-XT/M86ME for Discrete
LAN	Broadcom BCM5764MKMLG
USB 2.0	SB700 embedded
Super I/O controller	N/A
MODEM	Foxconn T60M955
Bluetooth	Broadcom 2045
Wireless 802.11 b+g	Foxconn XB63 and 4312
PCMCIA/ 5 in 1 Card Reader	JMicron JMB385
Audio Codec	Realtek ALC888S

Keyboard

Item	Specification
Keyboard controller	LPC interface
Total number of keypads	88-/89-/93-key
Windows logo key	Yes
Internal & external keyboard work simultaneously	Plug USB keyboard to the USB port directly: Yes

Battery 6 Cell

Item	Specification			
Vendor & model name	Sanyo & AS07B31	Sony & AS07B41	Panasonic & AS07B51	Simplo & AS07B71
Battery Type	Li-ion	Li-ion	Li-ion	Li-ion
Pack capacity	4500mAh	4500mAh	4500mAh	4500mAh
Number of battery cell	6cell	6cell	6cell	6cell
Package configuration	3S2P	3S2P	3S2P	3S2P
Normal voltage	10.8V	11.1V	11.1V	11.1V
Charge voltage	12.6V	12.6V	12.6V	12.6V

Battery 8 Cell

Item	Specification			
Vendor & model name	Sanyo & AS07B32	Sony & AS07B42	Panasonic & AS07B52	Simplo & AS07B72
Battery Type	Li-ion	Li-ion	Li-ion	Li-ion
Pack capacity	4800mAh	4800mAh	4800mAh	4800mAh
Number of battery cell	8cell	8cell	8cell	8cell
Package configuration	4S2P	4S2P	4S2P	4S2P
Normal voltage	14.8V	14.8V	14.8V	14.8V
Charge voltage	16.8V	16.8V	16.8V	16.8V

LCD 15.4"

Item	Specification
Vendor/model name	Chimei N154I3-L03, Samsung LTN154AT01-A01, AUO B154EW08 V1(HW 3A), LG.Philips LP154WX4
Screen Diagonal (mm)	391
Active Area (mm)	331.2 X 207.0
Display resolution (pixels)	1280x (RGB) x 800
Pixel Pitch	0.2588 (H) x 0.2588 (V)
Pixel Arrangement	RGB vertical stripe
Display Mode	Normally white
Typical White Luminance (cd/m ²) also called Brightness	220 cd/m ² (Typ.5 point)
Luminance Uniformity	1.25 max. (5 points)
Contrast Ratio	300 Min 400 typical
Response Time (Optical Rise Time/Fall Time) msec	Rising: 6 Falling: 2
Nominal Input Voltage VDD	+3.3 typ.
Typical Power Consumption (watt)	6.0 max.(without inverter)
Weight (without inverter)	500 typ. 525 max.
Physical Size (mm)	344.0 typ. x 222.0 typ. x 6.1 max.
Electrical Interface	1 channel LVDS
Support Color	262K colors (RGB 6-bit)
Viewing Angle (degree) Horizontal: Right/Left Vertical: Upper/Lower	40/40 15/30
Temperature Range (°C) Operating Storage (shipping)	0 to +50 -20 to +60

LCD Camera

Item	Specification	
Vendor	Bison Electronics	Suyin
Model Name	BN30V4O7-010	CN0314-SN30-OV03-1
Type	Fixed	Fixed
Dimension (L x W x H mm)	W 9 * L 65 * H 5.3 mm	65* 9.0 * 5.30+/-0.20 mm
Sensor	Up to SXGA(1280x1024) size CMOS sensor	OV7725 CMOS Sensor 350K Pixel
Optical Size	1/4 inch	F/2.0
Pixel Resolution	640(H) X 480(V) VGA	640 x 480
Pixel Size	6.0µm X 6.0µm	6.0µm x 6.0µm

LCD Inverter

Item	Specification
Vendor & model name	YEC YNV-C02G
Brightness conditions	N/A
Input voltage (V)	9~20(V)
Input current (mA)	0.08~0.6
Output voltage (V, rms)	Typical 680Vrms
Output current (mA, rms)	2.0~6.8
Output voltage frequency (k Hz)	45~70

AC Adapter

Item	Specification
Input rating	100~240Vac, 50~60Hz
Maximum input AC current	1.7A
Inrush current	No damage
Efficiency	Meet EPA Energy Star level-4 requirement

System Power Management

ACPI mode	Power Management
Mech. Off (G3)	All devices in the system are turned off completely.
Soft Off (G2/S5)	OS initiated shutdown. All devices in the system are turned off completely.
Working (G0/S0)	Individual devices such as the CPU and hard disc may be power managed in this state.
Suspend to RAM (S3)	CPU set power down VGA Suspend PCMCIA Suspend Audio Power Down Hard Disk Power Down CD-ROM Power Down Super I/O Low Power mode
Save to Disk (S4)	Also called Hibernation Mode. System saves all system states and data onto the disc prior to power off the whole system.

System Utilities

BIOS Setup Utility

The BIOS Setup Utility is a hardware configuration program built into your computer's BIOS (Basic Input/Output System).

Your computer is already properly configured and optimized, and you do not need to run this utility. However, if you encounter configuration problems, you may need to run Setup. Please also refer to Chapter 4 Troubleshooting when problem arises.

To activate the BIOS Utility, press **F2** during POST (when "Press <F2> to enter Setup" message is prompted on the bottom of screen).

Press **F2** to enter setup. The default parameter of F12 Boot Menu is set to "disabled". If you want to change boot device without entering BIOS Setup Utility, please set the parameter to "enabled".

Press <F12> during POST to enter multi-boot menu. In this menu, user can change boot device without entering BIOS SETUP Utility.

Navigating the BIOS Utility

There are six menu options: Information, Main, Advanced, Security, Boot, and Exit.

Follow these instructions:

- To choose a menu, use the left and right arrow keys.
- To choose an item, use the up and down arrow keys.
- To change the value of a parameter, press **F5** or **F6**.
- A plus sign (+) indicates the item has sub-items. Press **Enter** to expand this item.
- Press **Esc** while you are in any of the menu options to go to the Exit menu.
- In any menu, you can load default settings by pressing **F9**. You can also press **F10** to save any changes made and exit the BIOS Setup Utility.

NOTE: You can change the value of a parameter if it is enclosed in square brackets. Navigation keys for a particular menu are shown on the bottom of the screen. Help for parameters are found in the Item Specific Help part of the screen. Read this carefully when making changes to parameter values. **Please note that system information is subject to different models.**

Information

The Information screen displays a summary of your computer hardware information.

PhoenixBIOS Setup Utility	
Information	Main Advanced Security Power Boot AMD Exit
CPU Type:	AMD Turion (tm) X2 Ultra Dual-Core Mobile ZM-84
CPU Speed:	2300 MHz
HDD Model Name:	Hitachi HTS542525K9SA00 -(PM)
HDD Serial Number:	071110BB0F00WDGS1K4C
ATAPI Model Name:	Slimtype DVD A DS8A2S -(PS)
System BIOS Version:	V1.01
VGA BIOS Version:	V010.080.000.000.027965
Serial Number:	
Asset Tag Number:	
Product Name:	
Manufacturer Name:	
UUID:	33643636336236356663001B38E109DB
F1 Help	↑↓ Select Item F5/F6 Change Item F9 Setup Default
ESC Exit	←→ Select Menu Enter Select (Submenu F10 Save and Exit

NOTE: The system information is subject to different models.

Parameter	Description
CPU Type	This field shows the CPU type and speed of the system.
CPU Speed	This field shows the speed of the CPU.
HDD Model Name	This field shows the model name of HDD installed on primary IDE master.
HDD Serial Number	This field displays the serial number of HDD installed on primary IDE master.
ATAPI Model Name	This field shows the model name of the Optical device installed in the system.
System BIOS Version	Displays system BIOS version (MP models display BIOS ver. 1.01).
VGA BIOS Version	This field displays the VGA firmware version of the system.
Serial Number	This field displays the serial number of this unit.
Asset Tag Number	This field displays the asset tag number of the system.
Product Name	This field shows product name of the system.
Manufacturer Name	This field displays the manufacturer of this system.
UUID Number	Universally Unique Identifier (UUID) is an identifier standard used in software construction, standardized by the Open Software Foundation (OSF) as part of the Distributed Computing Environment (DCE).

Main

The Main screen allows the user to set the system time and date as well as enable and disable boot option and recovery.

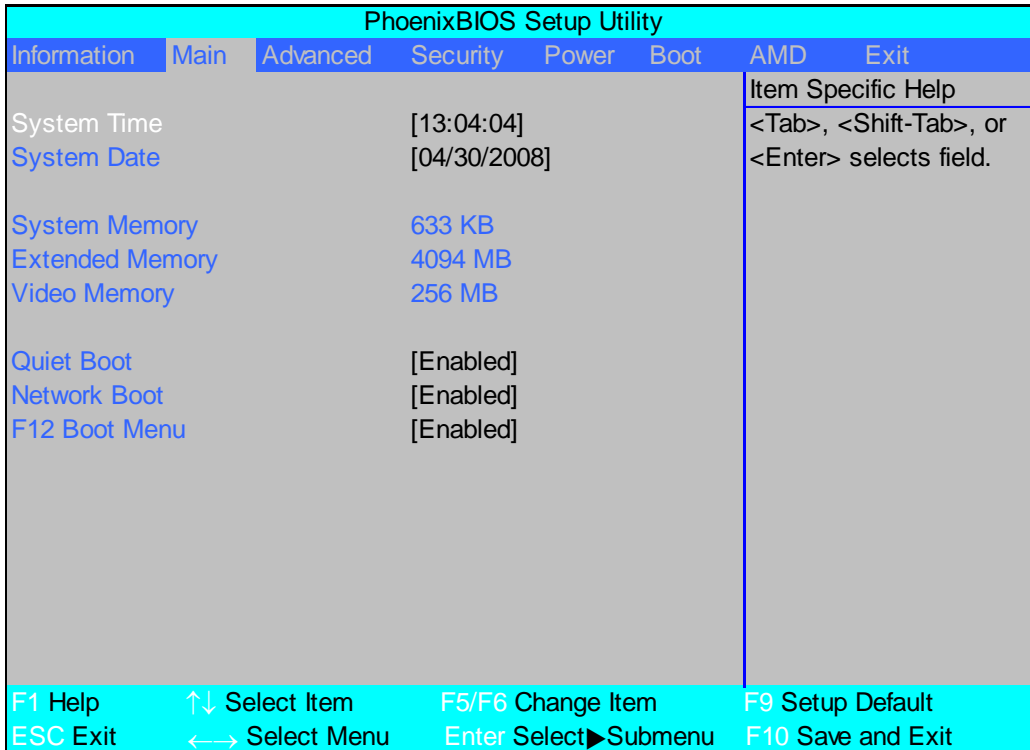

NOTE: The screen above is for your reference only. Actual values may differ.

The table below describes the parameters in this screen. Settings in **boldface** are the default and suggested parameter settings.

Parameter	Description	Format/Option
System Time	Sets the system time. The hours are displayed with 24-hour format.	Format: HH:MM:SS (hour:minute:second)
System Date	Sets the system date.	Format MM/DD/YYYY (month/day/year)
System Memory	This field reports the memory size of the system. Memory size is fixed to 633 KB.	N/A
Extended Memory	This field reports the Extended Memory size. Memory size is fixed to 4094 MB.	N/A
Video Memory	Shows the video memory size. VGA Memory size =256 MB	N/A
Quiet Boot	Displays the logo screen while booting.	Option: Enabled or Disabled
Network Boot	Enables, disables the system boot from LAN (remote server).	Option: Enabled or Disabled
F12 Boot Menu	Enables, disables Boot Menu during POST.	Option: Enabled or Disabled

NOTE: The sub-items under each device will not be shown if the device control is set to disable or auto. This is because the user is not allowed to control the settings in these cases.

Advanced

The Advanced screen allows the user to configure the various advanced BIOS options.

IMPORTANT: Making incorrect settings to items on these pages may cause the system to malfunction. Unless you have experience adjusting these items, we recommend that you leave these settings at the default values. If making settings to items on these pages causes your system to malfunction or prevents the system from booting, open BIOS and choose Load Optimal Defaults in the Exit menu to boot up normally.

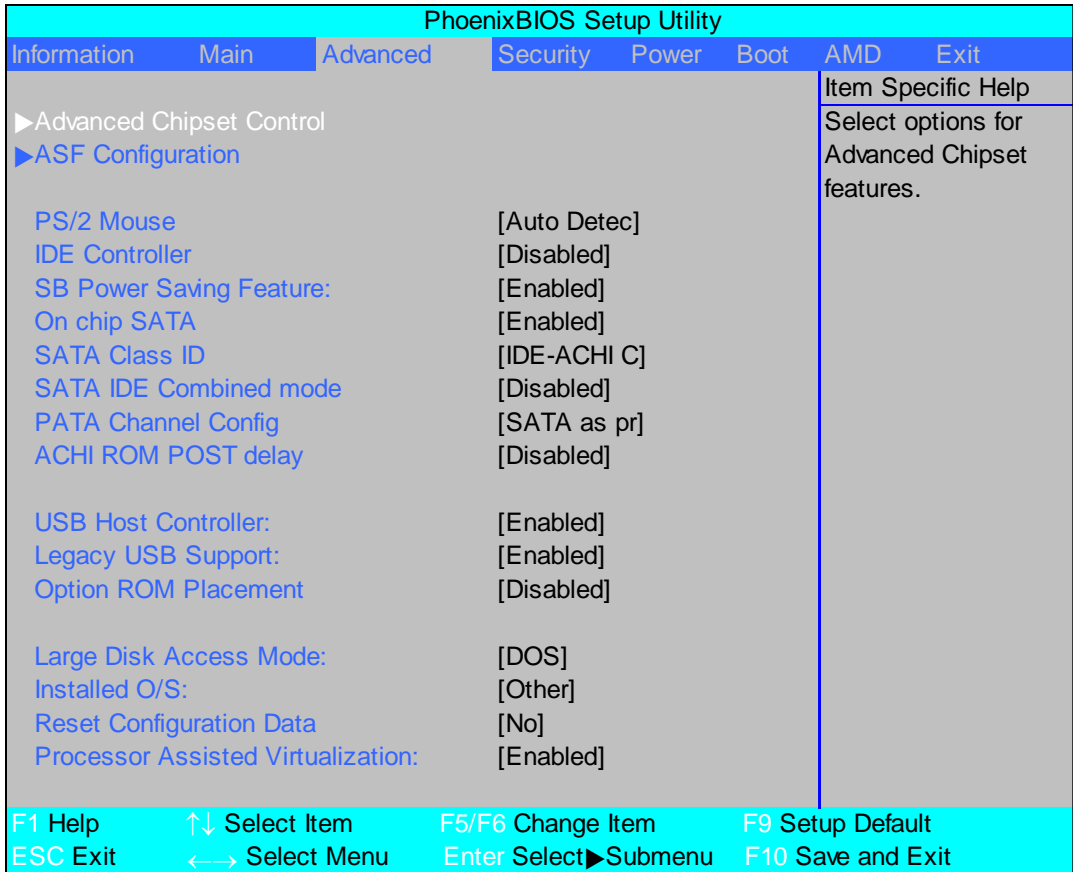

The table below describes the items, menus, and submenus in this screen. Settings in **boldface** are the default and suggested parameter settings.

Parameter	Description	Submenu Items
Advanced Chipset Control	Enter the Advanced Chipset Control menu.	<ul style="list-style-type: none"> Advanced NB Options Advanced SB Options
ASF Configuration	Enter the ASF Configuration menu.	<ul style="list-style-type: none"> ASF OS Device Availability Minimum Watchdog Timeout BIOS Boot Timeout OS Boot Timeout Power-on wait time
PS/2 Mouse	Enable or Disable PS/2 Mouse port IRQ12.	Option: Auto Detect , Enabled, or Disabled
IDE Controller	Configure the Integrated Local Bus IDE Controller.	Option: Disabled , Both, or Primary
SB Power Saving Feature	Enable SB Power Saving Feature.	Option: Enabled or Disabled

Parameter	Description	Submenu Items
On chip SATA	Enable On chip SATA.	Option: Enabled or Disabled
SATA Class ID	Select the SATA Class ID.	Option: IDE-ACHI Class , HyperFlash Class, IDE-HyperFlash Class, IDE Native Mode, Raid Class, ACHI Class, or IDE Legacy Mode
SATA IDE Combined mode	Set SATA IDE Combined mode.	Option: Disabled or Enabled
PATA Channel Config	Set the SATA channel as Primary or Secondary channel.	Option: SATA as primary or SATA as secondary
ACHI ROM POST delay	Select SATA option ROM POST delay.	Option: Disabled , 7, 6, 5, 4, 3, 2, or 1 second(s) delay
USB Host Controller	Enable or disable USB hardware.	Option: Enabled or Disabled
Legacy USB Support	Enable support for Legacy Universal Serial Bus.	Option: Enabled or Disabled
Option ROM Placement	Determines which peripheral devices can be booted. NOTE: Changes to this setting can cause the system to halt during boot.	Option: Disabled , Temporary, or E000 Extend
Large Disk Access Mode	Set the Large Disk Access mode. Different O/S require different drive geometry representations. Select Other for UNIX, Novell NetWare, or other O/S.	Option: DOS or Other
Installed O/S	Set the most commonly used O/S on the system.	Option: Other , Win2000, WinMe, Win98, or Win95
Reset Configuration Data	Clear Extended System Configuration Data (ESCD) area.	Option: No or Yes
Processor Assisted Virtualization	Enable the hardware visualization support.	Option: Enabled or Disabled.

Security

The Security screen contains parameters that help safeguard and protect your computer from unauthorized use.

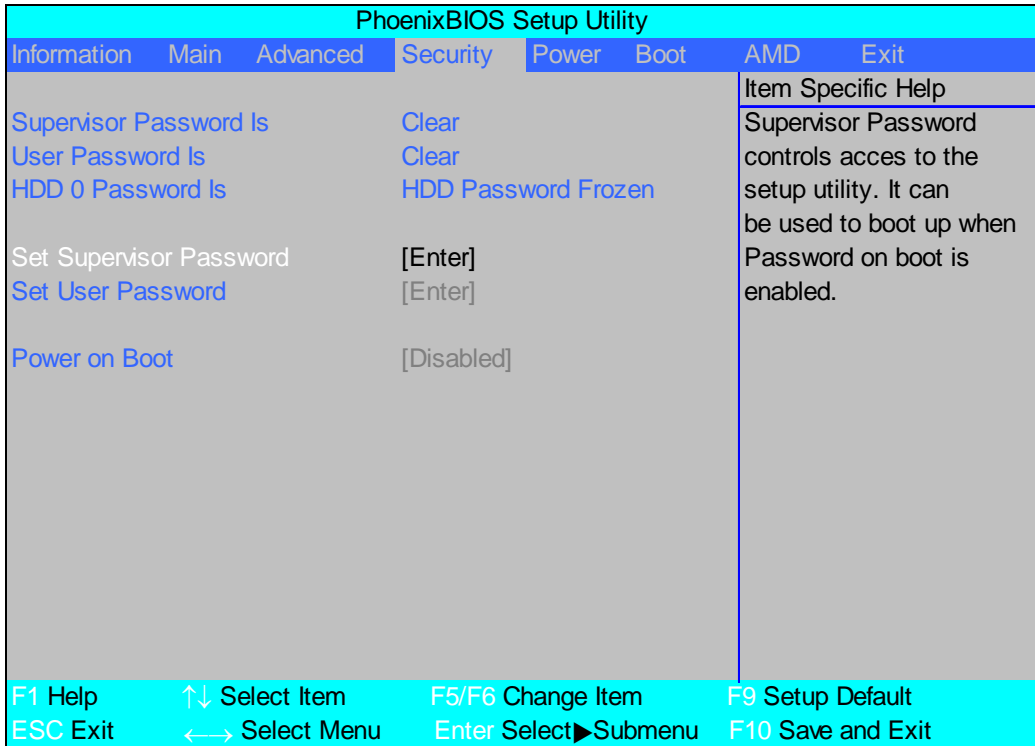

The table below describes the parameters in this screen. Settings in **boldface** are the default and suggested parameter settings.

Parameter	Description	Option
Supervisor Password Is	Shows the setting of the Supervisor password	Clear or Set
User Password Is	Shows the setting of the user password.	Clear or Set
HDD 0 Password Is	Shows the setting of the hard disk password.	Frozen
Set Supervisor Password	Press Enter to set the supervisor password. When set, this password protects the BIOS Setup Utility from unauthorized access. The user can not either enter the Setup menu nor change the value of parameters.	
Set User Password	Press Enter to set the user password. When user password is set, this password protects the BIOS Setup Utility from unauthorized access. The user can enter Setup menu only and does not have right to change the value of parameters.	
Password on Boot	Defines whether a password is required or not while the events defined in this group happened. The following sub-options are all requires the Supervisor password for changes and should be grayed out if the user password was used to enter setup.	Disabled or Enabled

NOTE: When you are prompted to enter a password, you have three tries before the system halts. Don't forget your password. If you forget your password, you may have to return your notebook computer to your dealer to reset it.

Setting a Password

Follow these steps as you set the user or the supervisor password:

1. Use the ↑ and ↓ keys to highlight the Set Supervisor Password parameter and press the **Enter** key. The Set Supervisor Password box appears:

Set Supervisor Password		
Enter New Password	[]
Confirm New Password	[]

2. Type a password in the “Enter New Password” field. The password length can not exceeds 8 alphanumeric characters (A-Z, a-z, 0-9, not case sensitive). Retype the password in the “Confirm New Password” field.

IMPORTANT: Be very careful when typing your password because the characters do not appear on the screen.

3. Press **Enter**. After setting the password, the computer sets the User Password parameter to “Set”.
4. If desired, you can opt to enable the Password on boot parameter.
5. When you are done, press F10 to save the changes and exit the BIOS Setup Utility.

Removing a Password

Follow these steps:

1. Use the ↑ and ↓ keys to highlight the Set Supervisor Password parameter and press the **Enter** key. The Set Password box appears:

Set Supervisor Password		
Enter current password	[]
Enter New Password	[]
Confirm New Password	[]

2. Type the current password in the Enter Current Password field and press **Enter**.
3. Press **Enter** twice **without** typing anything in the Enter New Password and Confirm New Password fields. The computer then sets the Supervisor Password parameter to “Clear”.
4. When you have changed the settings, press u to save the changes and exit the BIOS Setup Utility.

Changing a Password

1. Use the ↑ and ↓ keys to highlight the Set Supervisor Password parameter and press the **Enter** key. The Set Password box appears.

Set Supervisor Password		
Enter current password	[]
Enter New Password	[]
Confirm New Password	[]

2. Type the current password in the Enter Current Password field and press **Enter**.
3. Type a password in the Enter New Password field. Retype the password in the Confirm New Password field.
4. Press **Enter**. After setting the password, the computer sets the User Password parameter to “Set”.
5. If desired, you can enable the Password on boot parameter.
6. When you are done, press F10 to save the changes and exit the BIOS Setup Utility.

If the verification is OK, the screen will display as following.

Setup Notice
Changes have been saved.
[continue]

The password setting is complete after the user presses **Enter**.

If the current password entered does not match the actual current password, the screen will show you the Setup Warning.

Setup Warning
Invalid password
Re-enter Password
[continue]

If the new password and confirm new password strings do not match, the screen will display the following message.

Setup Warning
Password do not match
Re-enter Password

Power

The Power screen allows the user to configure CPU and power management options.

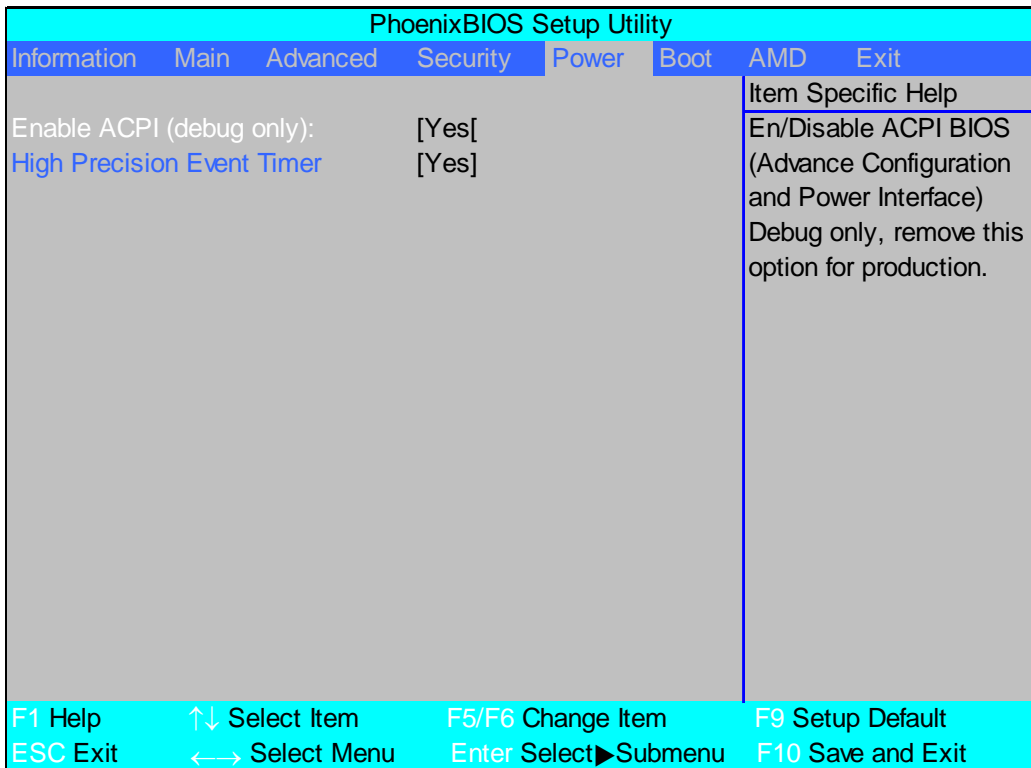

The table below describes the items, menus, and submenus in this screen. Settings in **boldface** are the default and suggested parameter settings.

Parameter	Description	Option
Enable ACPI (debug only)	Enable or disable ACPI BIOS.	Yes or No
High Precision Event Timer	Enable or disable HPET.	Yes or No

Boot

This menu allows the user to decide the order of boot devices to load the operating system. Bootable devices includes the USB diskette drives, the onboard hard disk drive and the DVD drive in the module bay.

PhoenixBIOS Setup Utility							
Information	Main	Advanced	Security	Power	Boot	AMD	Exit
Boot priority order:						Item Specific Help	
1. IDE0 : Hitachi HTS542525K9SA00- (S)						Use <↑> or <↓> to	
2. IDE1 : Slimtype DVD A DS8A2S- (S2)						select a device, then	
3. PCI LAN: MBA v1.0.3 Slot 0600						press <F6> to move it	
4. USB HDD :						up the List, or <F5>	
5. USB FDD :						to move it down the	
6. USB KEY :						list. Press <Esc> to	
7. USB CD/DVD ROM :						escape the menu.	
F1 Help	↑↓ Select Item	F5/F6 Change Item	F9 Setup Default				
ESC Exit	←→ Select Menu	Enter Select▶ Submenu	F10 Save and Exit				

AMD

The AMD screen allows the user to configure memory, thermal management options, and device wakeup behavior.

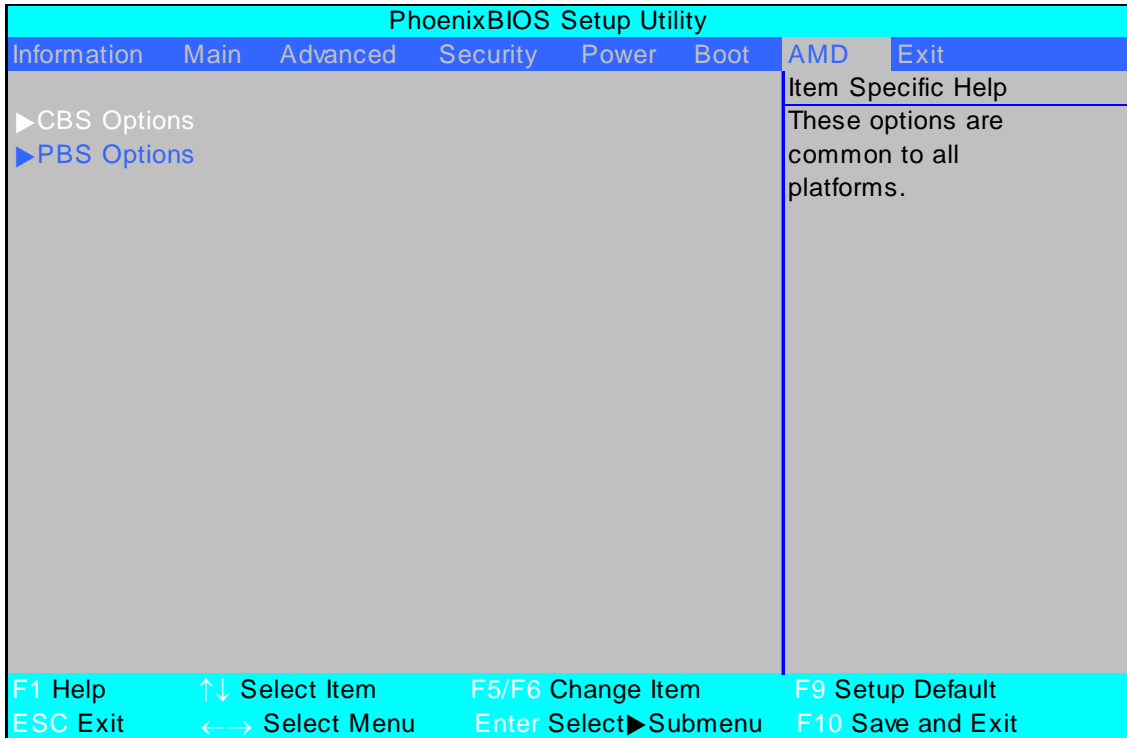

Parameter	Description	Submenu Items
CBS Options	Manage common platform BIOS settings.	<ul style="list-style-type: none"> • Power Management • Thermal Control • DDR2 Memory & Memory Controller
PBS Options		<ul style="list-style-type: none"> • Primary Display • Parallel ATA • On chip SATA • USB Host Controller • USB3 Controller • Legacy USB Support • OSC Support • System Time Lag Workaround • Thermal Fan Control

Exit

The Exit screen allows you to save or discard any changes you made and quit the BIOS Utility.

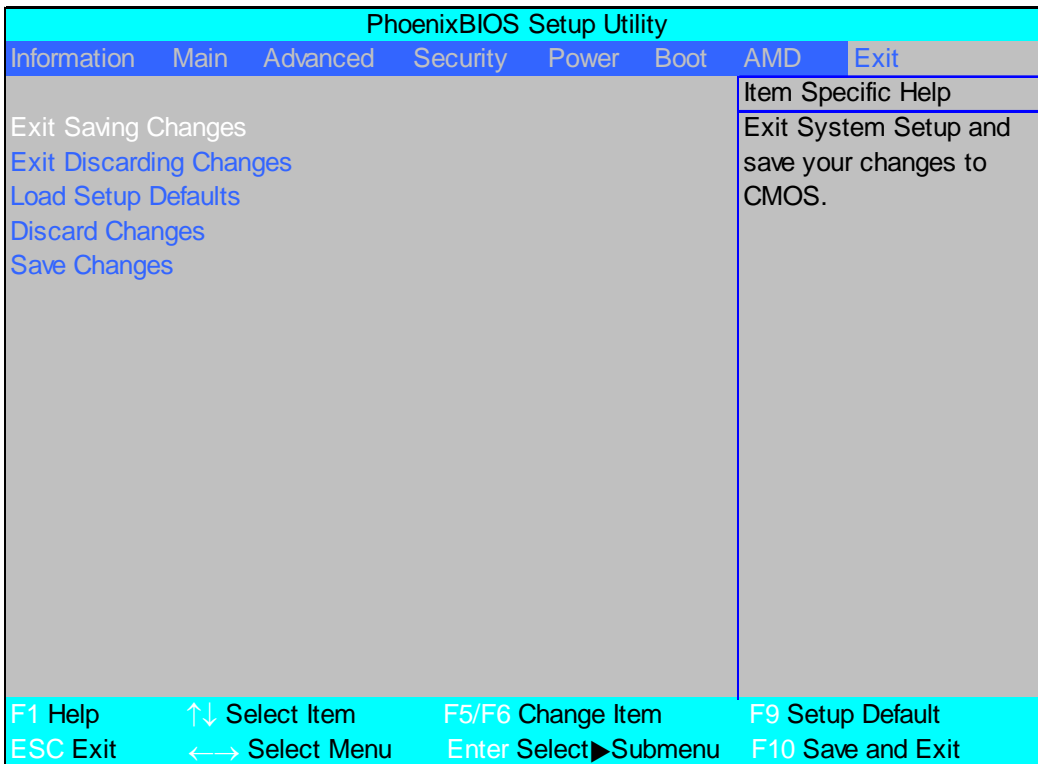

The table below describes the parameters in this screen.

Parameter	Description
Exit Saving Changes	Exit System Setup and save your changes to CMOS.
Exit Discarding Changes	Exit utility without saving setup data to CMOS.
Load Setup Default	Load default values for all SETUP item.
Discard Changes	Load previous values from CMOS for all SETUP items.
Save Changes	Save Setup Data to CMOS.

BIOS Flash Utility

The BIOS flash memory update is required for the following conditions:

- New versions of system programs
- New features or options
- Restore a BIOS when it becomes corrupted.

Use the Phlash utility to update the system BIOS flash ROM.

NOTE: If you do not have a crisis recovery diskette at hand, then you should create a **Crisis Recovery Diskette** before you use the Phlash utility.

NOTE: Do not install memory-related drivers (XMS, EMS, DPMI) when you use the Phlash.

NOTE: Please use the AC adaptor power supply when you run the Phlash utility. If the battery pack does not contain enough power to finish BIOS flash, you may not boot the system because the BIOS is not completely loaded.

Follow the steps below to run the Phlash.

1. Prepare a bootable diskette.
2. Copy the flash utilities to the bootable diskette.
3. Then boot the system from the bootable diskette. The flash utility has auto-execution function.

DOS Flash Utility

Perform the following steps to use the DOS Flash Utility:

1. Press F2 during boot to enter the Setup Menu.
2. Select **Boot Menu** to modify the boot priority order, for example, if using USB HDD to Update BIOS, move USB HDD to position 1.

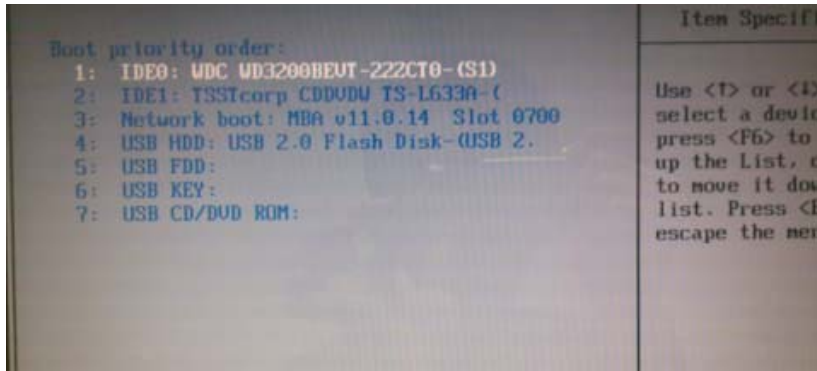

3. Execute the **JALB028.BAT** batch file from C:\JALB0_JALC0\BIOS\JALB028A to update BIOS.

The flash process begins as shown.



4. In flash BIOS, the message **Please do not remove AC Power Source** displays.

NOTE: If the AC power is not connected, the following message displays.

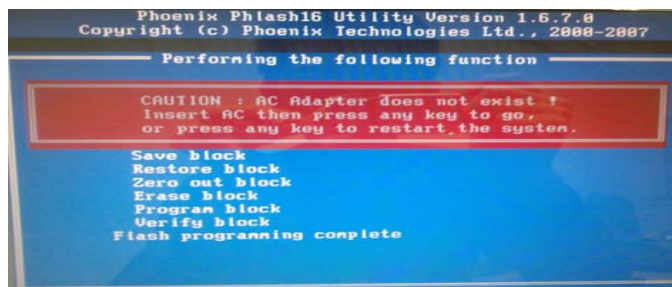

Plug in the AC power to continue.

5. Flash is complete when the message Flash programming complete displays.

WinFlash Utility

Perform the following steps to use the WinFlash Utility:

1. Double click the WinFlash executable.

The Destination Directory screen displays.

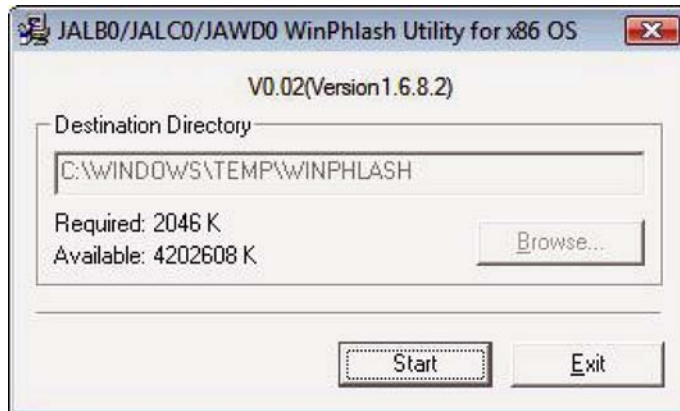

2. Click **Start**. A warning screen displays.

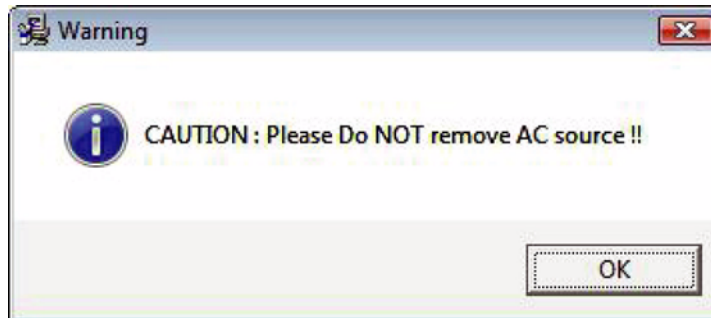

3. Click **OK** to begin the update. A progress screen displays.

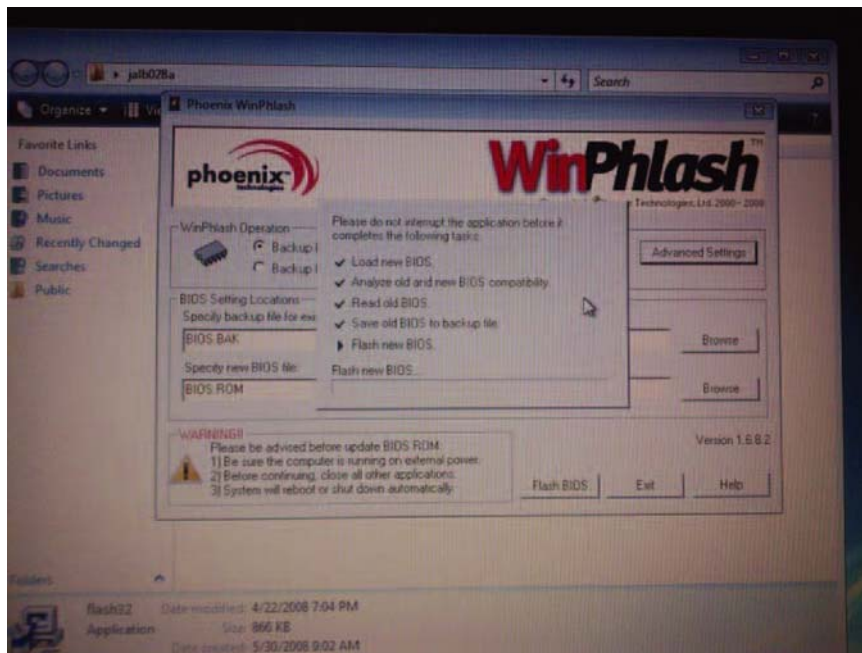

4. When the process is complete, close all programs and applications and reboot the system.

Removing HDD Passwords

This section provide you with removing HDD/BIOS password method:

Remove HDD Password:

If you key in the wrong HDD password three time, **HDD password error code** displays on the screen.

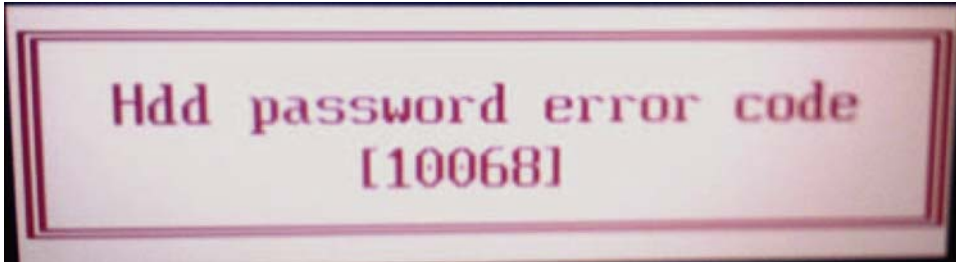

To reset the HDD password, perform the following steps:

1. From a DOS prompt, key in **Unlock6.exe 10068 00** and press **<Enter>**.

The **Unlock6** program runs.

2. Select option **2**, Upper case ASCII Code, and press **<Enter>**.

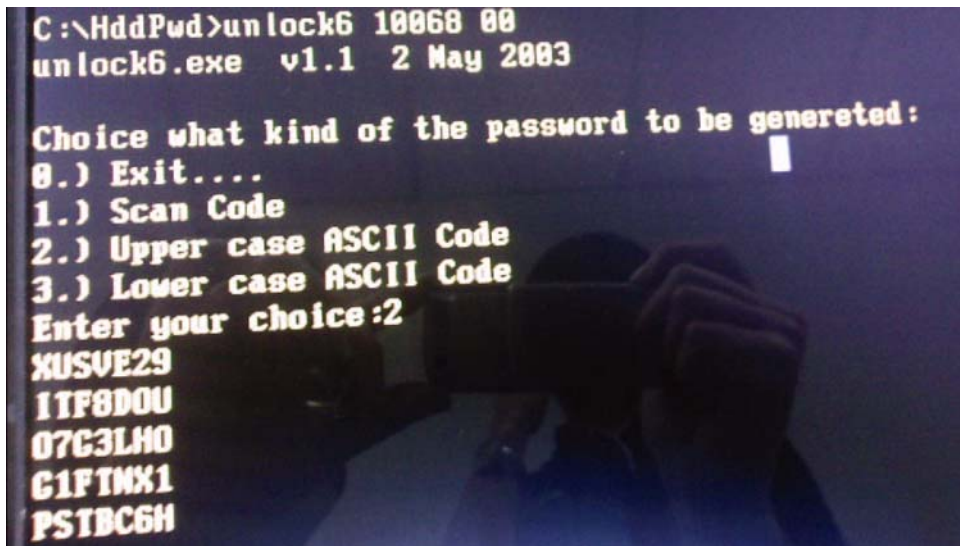

3. Make a note of one of the displayed passwords, for example XUSVE29, as shown.
4. Power off the system by holding down the power button for >4 seconds.
5. Reboot the system and key in the chosen password to unlock the HDD.

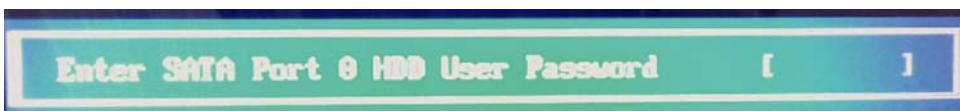

Remove BIOS Password:

- If you key in wrong Supervisor Password for three time, "System Disabled" would display on the screen. See the image below.

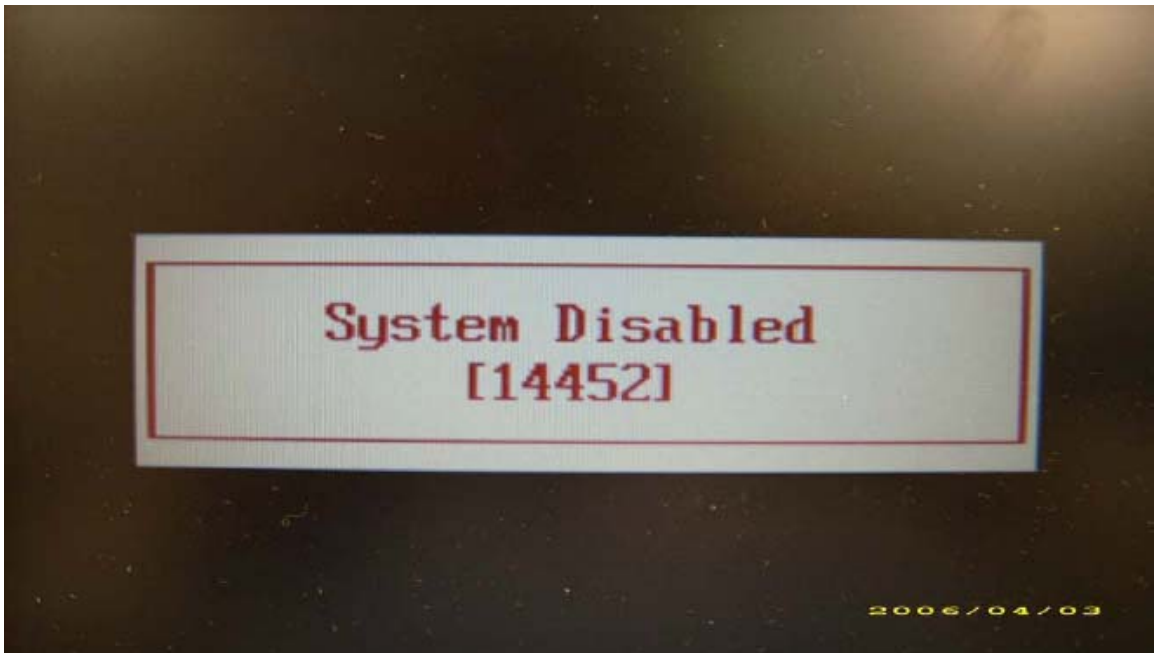

- If you need to solve BIOS password locked problem, you can run BIOS_PW.EXE
 1. Key in "bios_pw 14452 0"
 2. Choose one upper-case string



- Reboot the system and key in "qjjg9vy" or "07yqmjd" to BIOS user password.



Removing BIOS Passwords:

To clear the password, perform the following steps:

1. From a DOS prompt, Execute **clnpwd.exe**

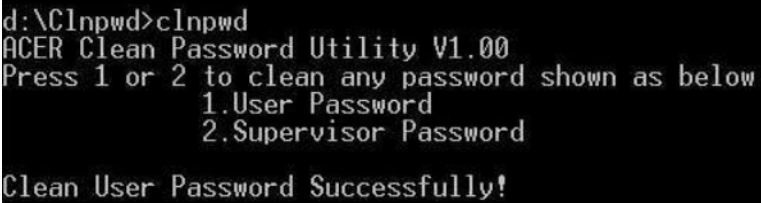

```
d:\Clnpwd>clnpwd
ACER Clean Password Utility V1.00
Press 1 or 2 to clean any password shown as below
    1.User Password
    2.Supervisor Password

Clean User Password Successfully!
```

2. Press 1 or 2 to clean the desired password shown on the screen.

The onscreen message determines whether the function is successful or not.

Machine Disassembly and Replacement

This chapter contains step-by-step procedures on how to disassemble the notebook computer for maintenance and troubleshooting.

Disassembly Requirements

To disassemble the computer, you need the following tools:

- Wrist grounding strap and conductive mat for preventing electrostatic discharge
- Flat screwdriver
- Philips screwdriver
- Plastic flat screwdriver
- Plastic tweezers

NOTE: The screws for the different components vary in size. During the disassembly process, group the screws with the corresponding components to avoid mismatch when putting back the components.

General Information

Pre-disassembly Instructions

Before proceeding with the disassembly procedure, make sure that you do the following:

1. Turn off the power to the system and all peripherals.
2. Unplug the AC adapter and all power and signal cables from the system.



3. Place the system on a flat, stable surface.
4. Remove the battery pack.

Disassembly Process

The disassembly process is divided into the following stages:

- External module disassembly
- Main unit disassembly
- LCD module disassembly

The flowcharts provided in the succeeding disassembly sections illustrate the entire disassembly sequence. Observe the order of the sequence to avoid damage to any of the hardware components. For example, if you want to remove the main board, you must first remove the keyboard, then disassemble the inside assembly frame in that order.

Main Screw List

Screw	Quantity	Part Number
M2.5*8 (NL)	15	
M2.5*5 (NL)	22	
M2.5*3 (NL)	2	
M2*3 (NL)	36	
M2.5*4 (NL)	2	
M2*6 (NL)	4	
M2*4-NI (NL)	5	
M3*3 (NL)	4	
M2*6.5	4	
M2.5*5.0	2	
M2.5*6.5	4	

External Module Disassembly Process

External Modules Disassembly Flowchart

The flowchart below gives you a graphic representation on the entire disassembly sequence and instructs you on the components that need to be removed during servicing. For example, if you want to remove the main board, you must first remove the keyboard, then disassemble the inside assembly frame in that order.

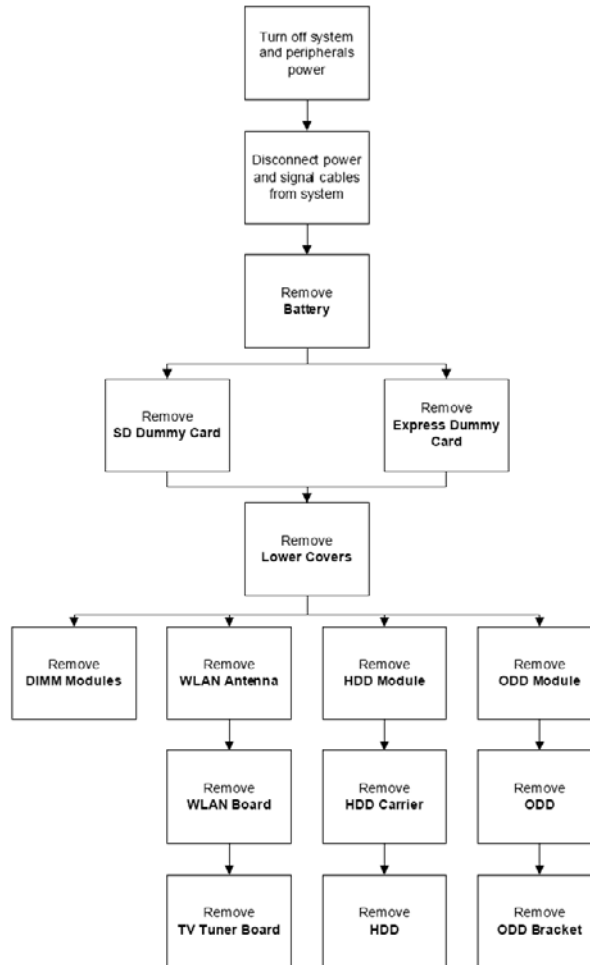

Screw List

Step	Screw	Quantity	Color	Part No.
Memory Cover	M2.5*8 (NL)	4	Black	
HDD Cover	M2*6 (NL)	2	Black	
WLAN Cover	M2.5*8 (NL)	4	Black	
WLAN Module	M2*3 (NL)	2	Black	
WLAN Bracket	M2*3 (NL)	1	Black	
TV Tuner Module	M2*3	2	Black	
HDD Carrier	M3*3 (NL)	4	Silver	
ODD Module	M2.5*5(NL)	1	Black	
ODD Bracket	M2*3 (NL)	3	Black	

Removing the Battery Pack

1. Turn computer over.
2. Slide the battery lock/unlock latch to the unlock position.



3. Slide and hold the battery release latch to the release position (1), then slide out the battery pack from the main unit (2).

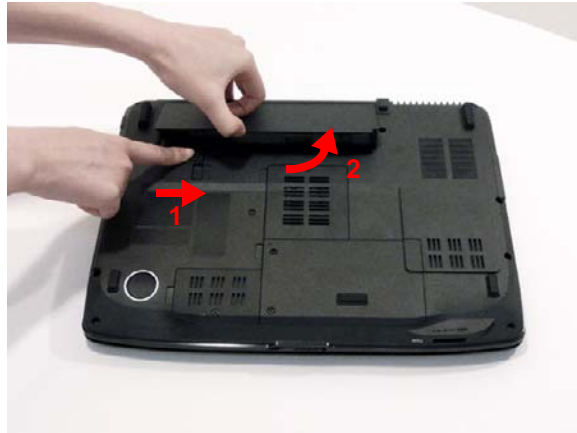

Removing the SD dummy card

1. Push the SD dummy card in to eject it.



2. Grasp the card and pull it out from the slot.



Removing the ExpressCard dummy card

1. Push the ExpressCard dummy card in to eject it.





2. Grasp the card and pull it out from the slot.

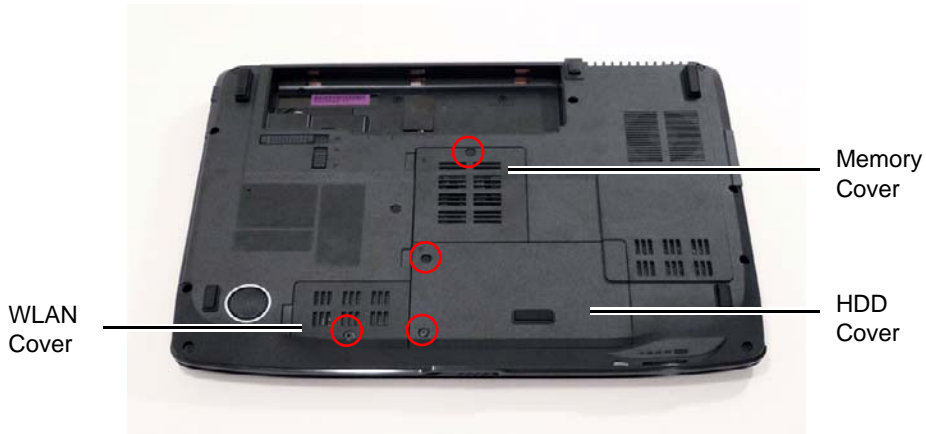

Removing the Lower Covers

1. See "Removing the Battery Pack" on page 50.
2. See "Removing the SD dummy card" on page 51.
3. See "Removing the ExpressCard dummy card" on page 52.
4. Remove the two screws from the memory and WLAN bays and loosen the two captive HDD bay screws.



Step	Size	Quantity	Screw Type
Memory Cover	M2.5*8 (NL)	1	
HDD Cover	M2.5*8 (NL)	2	
WLAN Cover	M2.5*8 (NL)	1	

5. Carefully open the memory cover.

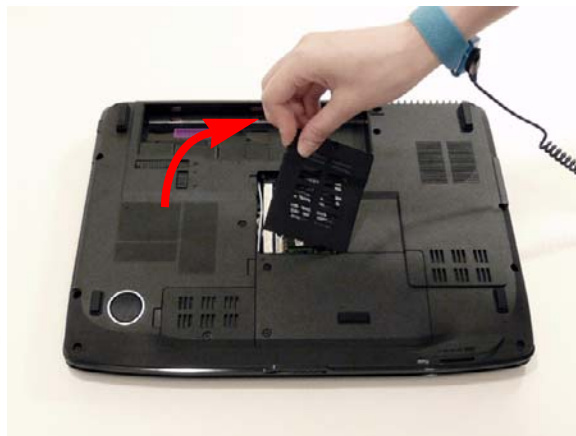

6. Remove the HDD cover as shown.



7. Remove the WLAN cover as shown.



Removing the DIMM Modules

1. Remove the Battery Pack. See “Removing the Battery Pack” on page 50.
2. Remove the Memory Module cover See “Removing the Lower Covers” on page 53.
3. Push out the release latches on both sides of the DIMM socket to release the DIMM module.

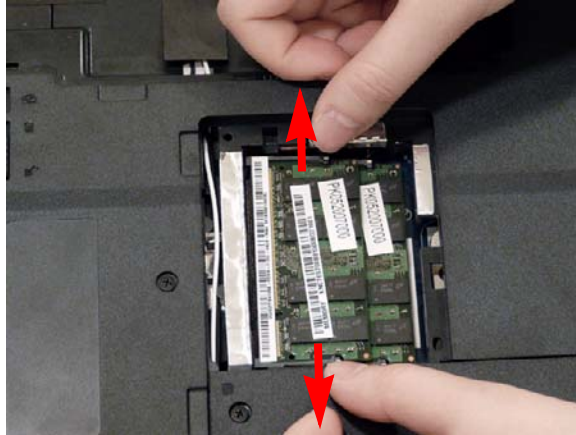

4. Remove the DIMM module.

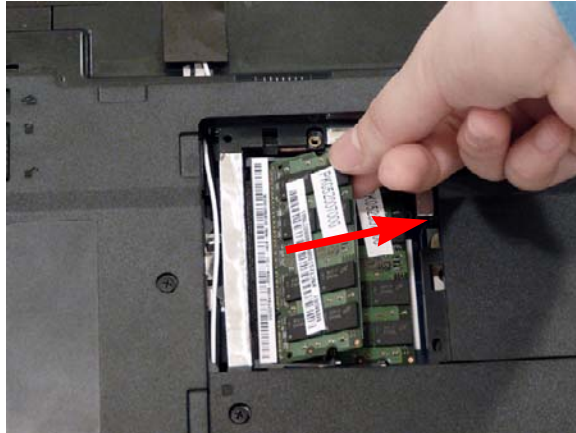

5. Repeat steps for the second DIMM module if present.

Removing the WLAN Module

1. See "Removing the Battery Pack" on page 50.
2. Remove the WLAN cover. See "Removing the Lower Covers" on page 53.
3. Disconnect the antenna cables from the WLAN board.



4. Move the antenna cables away and remove the two screws on the WLAN board to release the WLAN board.

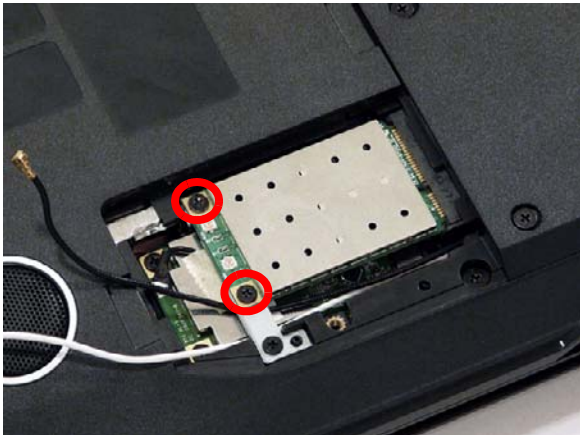

Step	Size	Quantity	Screw Type
WLAN Module	M2*3 (NL)	2	

5. Detach the WLAN board from the WLAN socket.

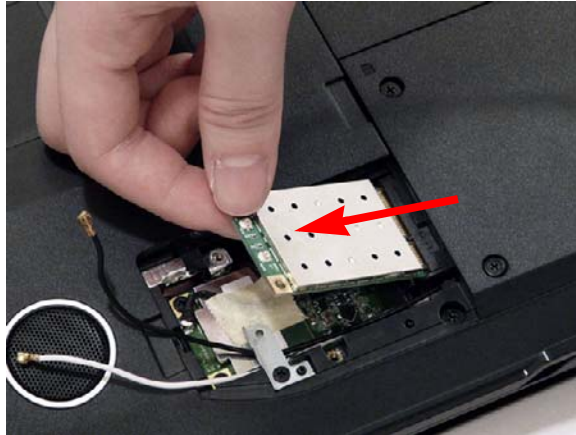

NOTE: When re-attaching the antenna to the WLAN board, make sure the cables are arranged under the WLAN bracket.

Removing the TV tuner Module

- 1. See "Removing the Lower Covers" on page 53.
- 1. Remove the securing screw, located on the WLAN bracket, and remove the bracket.
NOTE: Move the antenna cables out of the way to allow for easier access.



Step	Size	Quantity	Screw Type
WLAN Bracket	M2*3 (NL)	1	

- 2. Remove the adhesive strip to release the cable.

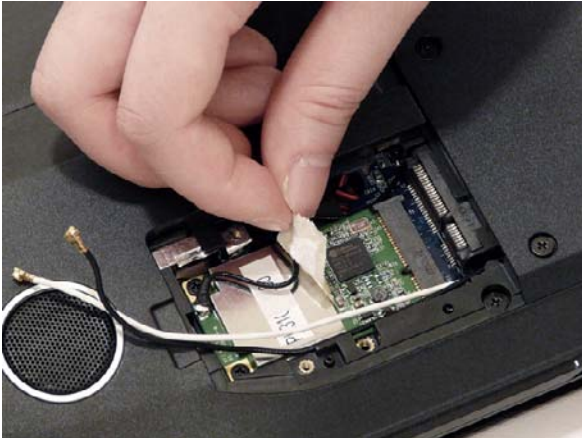



NOTE: Do not throw away the adhesive strip it is necessary to secure the cable on the new module.

3. Disconnect the cable from the TV tuner module.

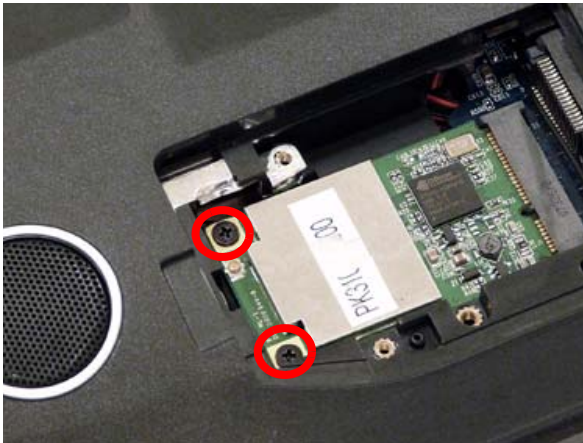

4. Remove the two securing screws.



Step	Size	Quantity	Screw Type
TV Tuner Module	M2*3 (NL)	2	

5. Remove the tv tuner module.

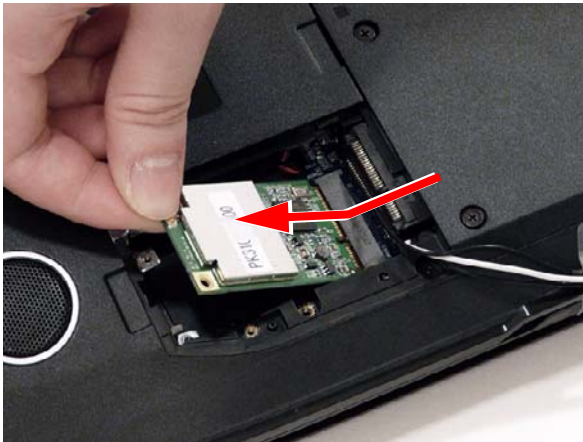

Removing the Hard Disk Drive Module

1. See “Removing the Battery Pack” on page 50.
2. Remove the HDD cover, See “Removing the Lower Covers” on page 53.
3. Use the mylar tab to slide and lift up the hard disk drive module to remove.

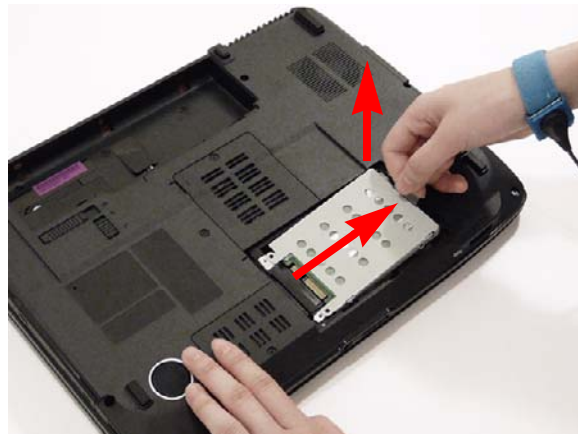
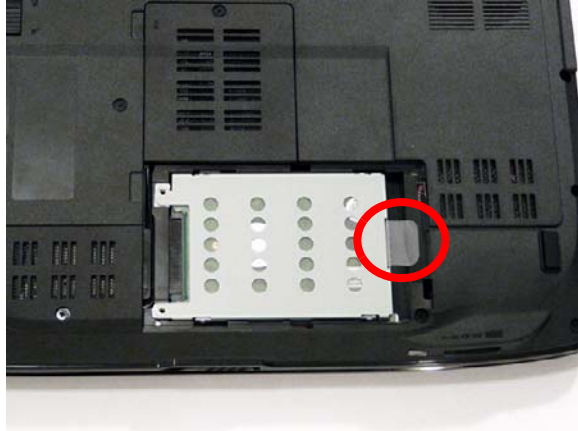

NOTE: To prevent damage to device, avoid pressing down on it or placing heavy objects on top of it.

4. Remove the four screws securing the hard disk to the carrier.

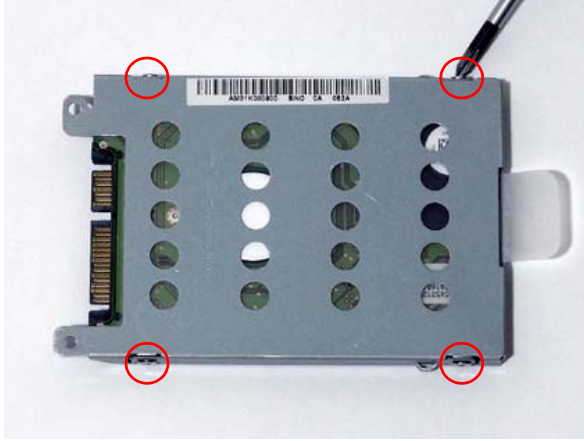

Step	Size	Quantity	Screw Type
HDD Carrier	M3*3 (NL)	4	

5. Remove the HDD from the carrier.

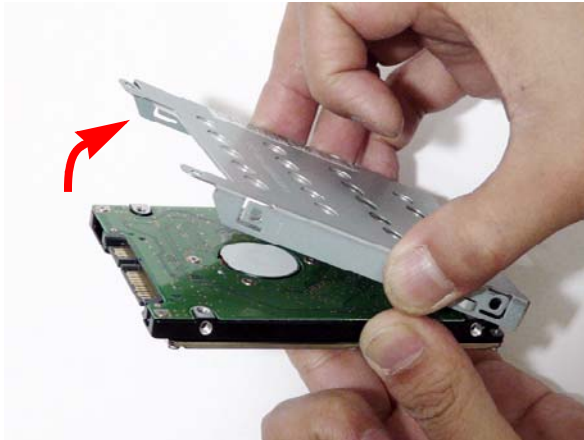

Removing the Optical Drive Module

1. Remove the Battery Pack. See “Removing the Battery Pack” on page 50.
2. Remove the Memory cover. See “Removing the Lower Covers” on page 53.
3. Remove the screw securing the ODD module.



Step	Size	Quantity	Screw Type
ODD Module	M2.5*5(NL)	1	

4. Grasp the front panel of the ODD and pull to remove from the main unit.

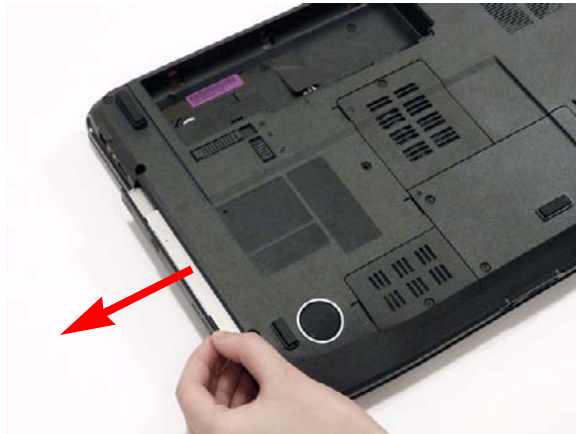

5. Remove the three screws securing the ODD bracket and remove the ODD bracket from the optical disk drive module.



Step	Size	Quantity	Screw Type
ODD Bracket	M2*3 (NL)	3	

6. Insert a pin in the eject hole of the ODD to eject the ODD tray.



7. Press down on the locking catch to release the ODD cover and remove.

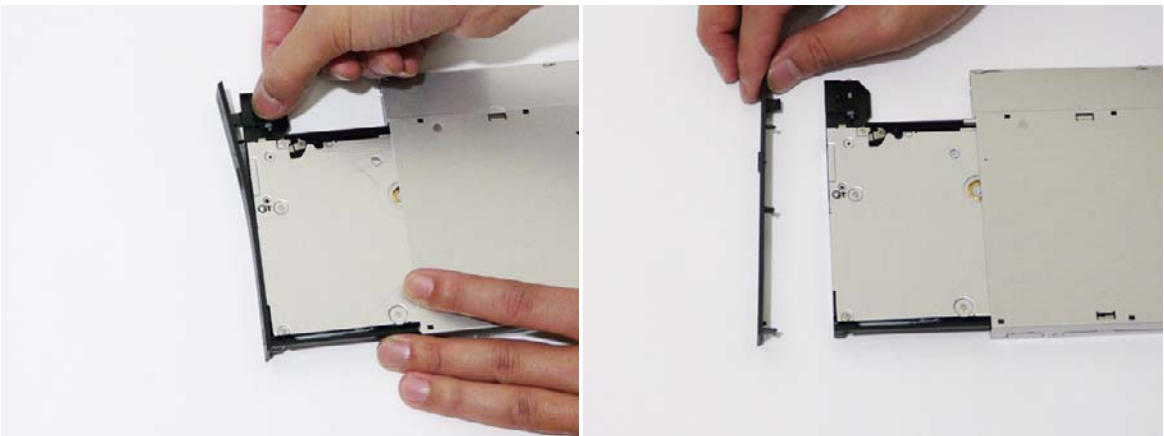

Main Unit Disassembly Process

Main Unit Disassembly Flowchart

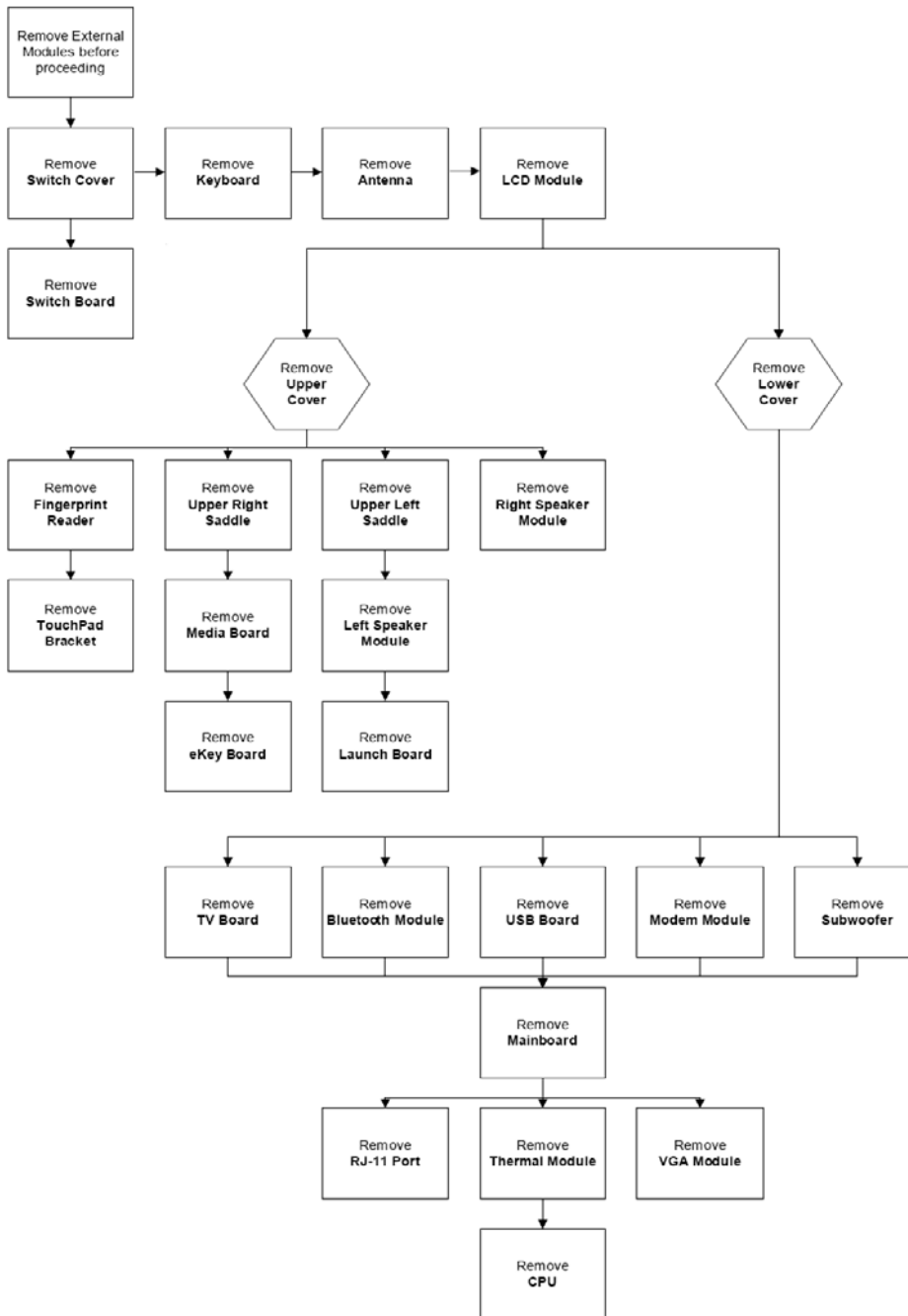

Screw List

Step	Screw	Quantity	Color	Part No.
Switch Cover	M2*3 (NL)	2		
LCD Module	M2.5*8(NL)	4		
	M2.5*5 (NL)	2		
Upper Cover	M2.5*8 (NL)	9		
	M2.5*5 (NL)	5		

Step	Screw	Quantity	Color	Part No.
Finger Print Reader	M2*3 (NL)	1		
Upper Right Saddle	M2*3 (NL)	2		
Left Speaker Module	M2.5*4 (NL)	2		
Upper left Saddle	M2.5*4 (NL)	2		
Touch Pad Bracket	M2*3 (NL)	2		
eKey Board	M2*3 (NL)	1		
Switch Board	M2.5*4 (NL)	1		
Right Speaker Module	M2.5*4 (NL)	2		
TV Board	M2.5*4 (NL)	2		
USB Board	M2.5*4 (NL)	2		
Modem Module	M2*3 (NL)	1		
Subwoofer	M2*3 (NL)	2		
Mainboard	M2.5*5 (NL)	2		
Thermal Module	M2*6.5	4		
	M2*L3	4		
VGA Module	M2*4-NI (NL)	2		

Removing the Switch Cover

CAUTION: Using tools to remove the Switch Cover may cause damage to the outer casing. It is recommended that only fingers are used to remove the Switch Cover.

1. See "Removing the Battery Pack" on page 50.
2. Locate and remove the three securing screws as shown.

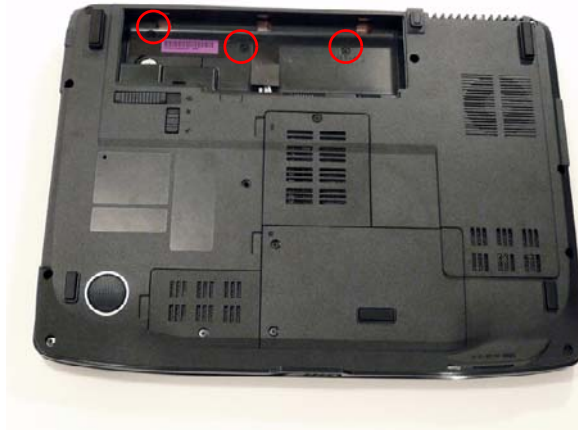

Step	Size	Quantity	Screw Type
Switch Cover	M2*3(NL)	3	

3. Turn the computer over and open the LCD module fully to expose the Switch Cover.
4. Lift the Switch Cover as shown, leftside first.



5. Lift the Switch Cover clear of the chassis.

Removing the Keyboard

1. See "Removing the Battery Pack" on page 50..
2. Push down on the two latches securing the keyboard to the upper case.



3. Turn the keyboard over and pull back the securing latch to release the FFC.



Removing the Antenna

WARNING: Do not attempt to pull the antenna cables under the WLAN bracket to prevent stripping of the cable.

1. See "Removing the WLAN Module" on page 56.
2. Remove the securing screw, located on the WLAN bracket, and remove the bracket.

NOTE: Move the antenna cables out of the way to allow for easier access.



3. Remove the Antenna Cables from the securing guides as shown.

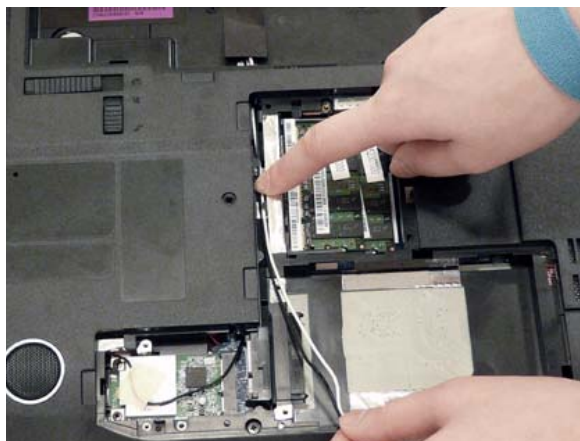
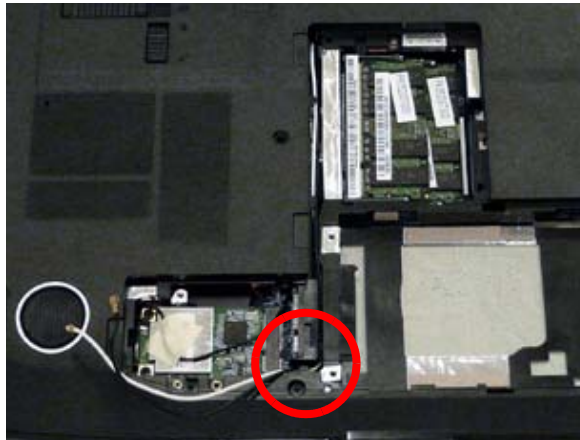

-
4. Using one hand, pull the cables completely through the battery housing.
NOTE: Do not remove the adhesive tape.

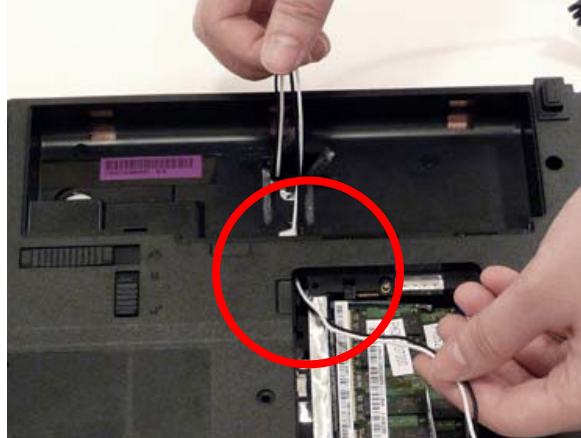



5. Push the cables through the chassis, then turn over the computer and pull them completely through.

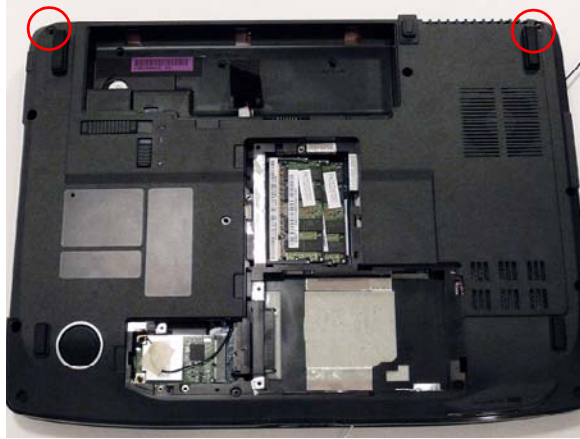

Removing the LCD Module

1. Remove the Antenna. Remove the Antenna. See "Removing the Antenna" on page 68.
2. Remove the two securing screws from the bottom of the chassis.



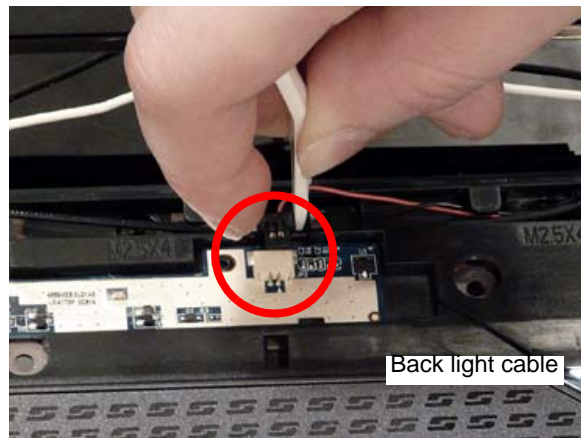
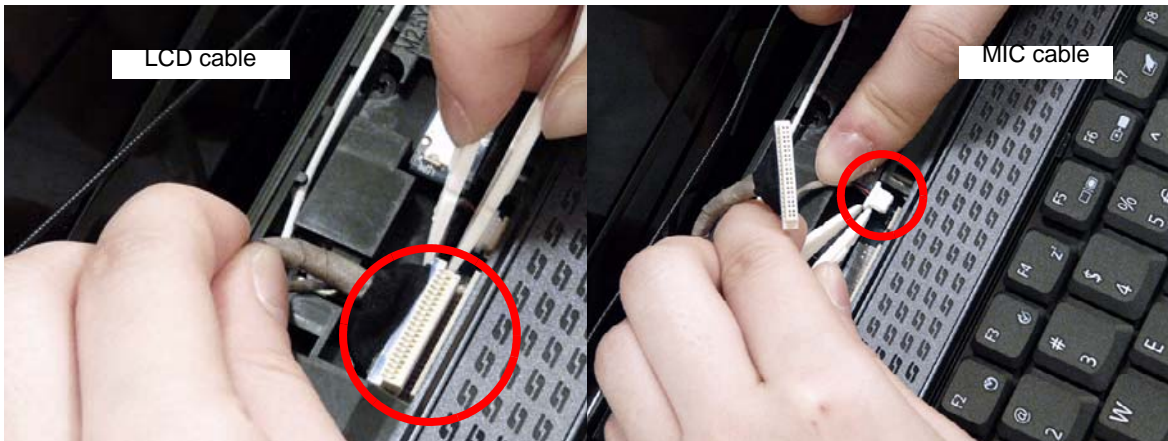

Step	Size	Quantity	Screw Type
LCD Module	M2.5*8(NL)	2	

3. Turn the computer over. Disconnect the LCD, MIC and back light cables from the top panel.

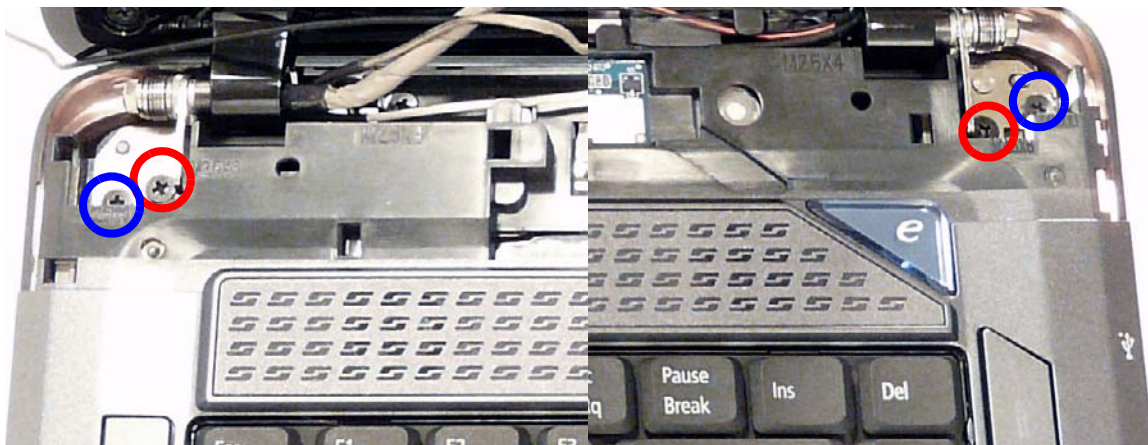

4. Remove the four securing screws (two on each side) connecting the LCD module.



Step	Size	Quantity	Screw Type
LCD Hinges (Red call out)	M2.5*6 (NL)	2	
LCD Hinges (Blue call out)	M2.5*10 (NL)	2	

5. Carefully remove the LCD module from the chassis.



Removing the Upper Cover

1. Remove the LCD Module. See "Removing the LCD Module" on page 70.
2. Turn the computer over. Remove the nine screws on the bottom panel.

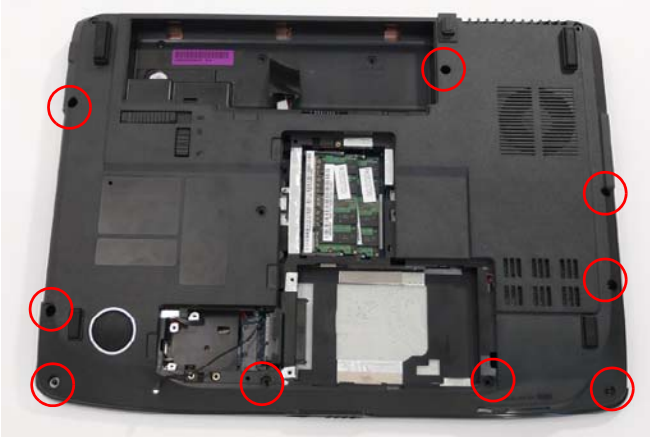

Step	Size	Quantity	Screw Type
Upper Cover	M2.5*10 (NL)	9	

3. Turn the computer over. Remove the five screws on the top panel.



Step	Size	Quantity	Screw Type
Upper Cover	M2.5*4 (NL)	5	

4. Disconnect the seven cables from the mainboard as shown.

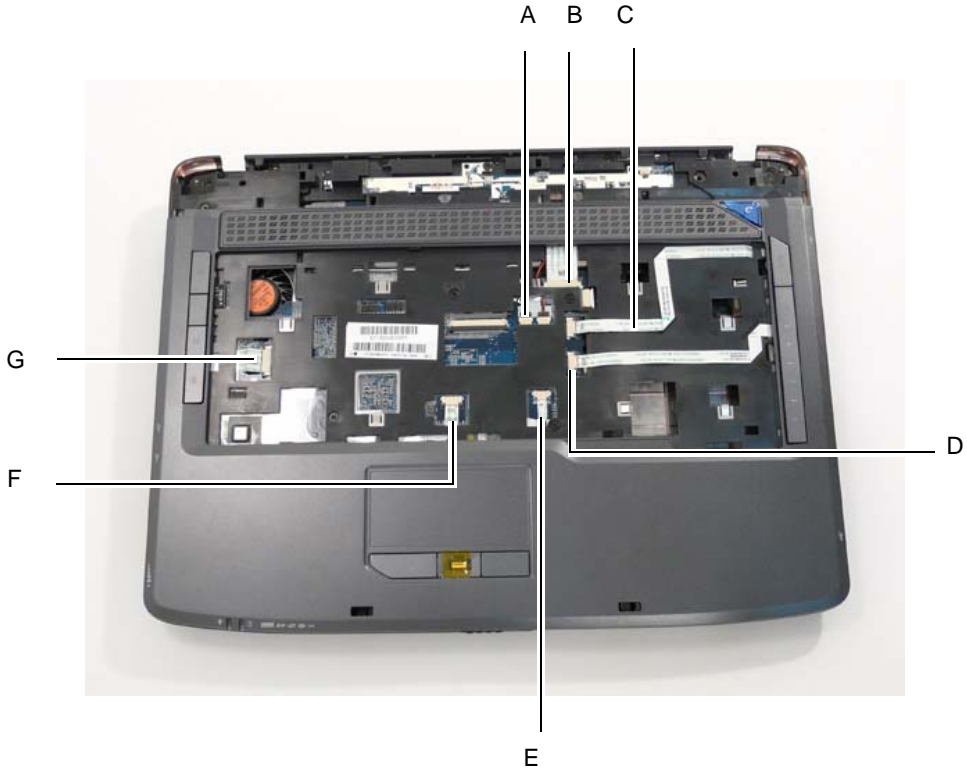

Disconnect A as shown.

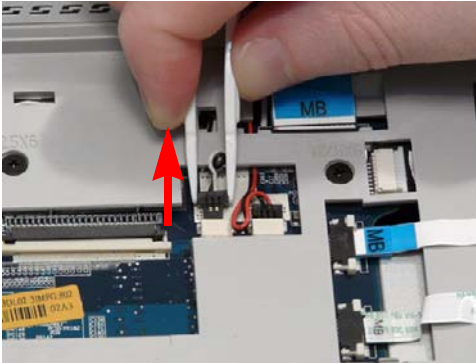

Release the securing latches and disconnect B as shown.

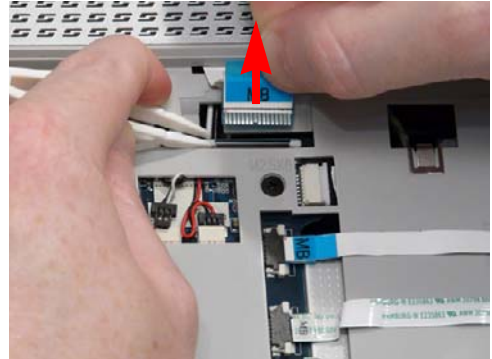

Release the securing latches and disconnect C as shown.

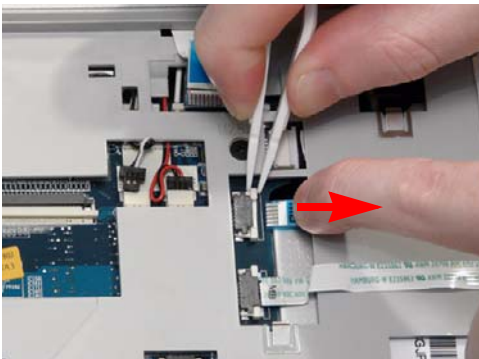

Release the securing latches and disconnect D as shown.

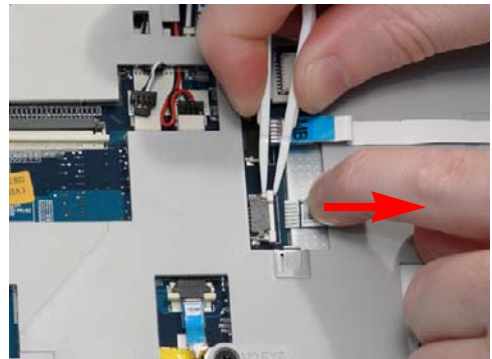

Release the securing latches and disconnect E as shown.

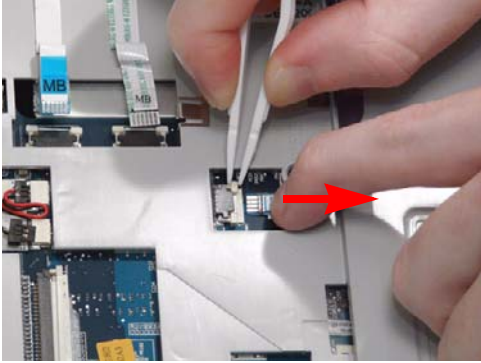

Release the securing latches and disconnect F as shown.

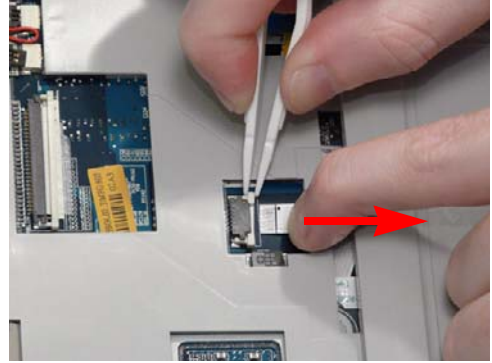

Release the securing latches and disconnect G as shown.



5. Remove the upper cover by lifting upward from the chassis, rear edge first.

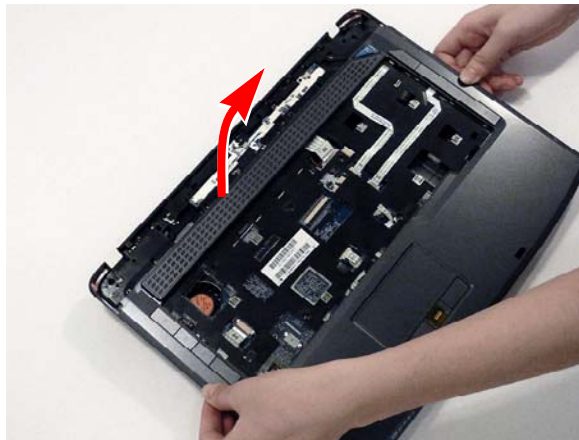

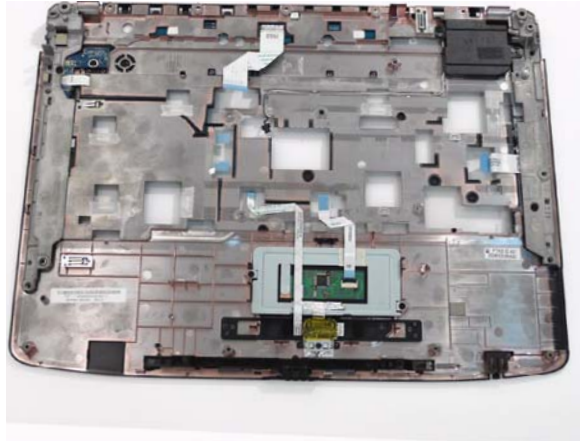

6. Turn the upper cover over. The upper cover appears as follows.

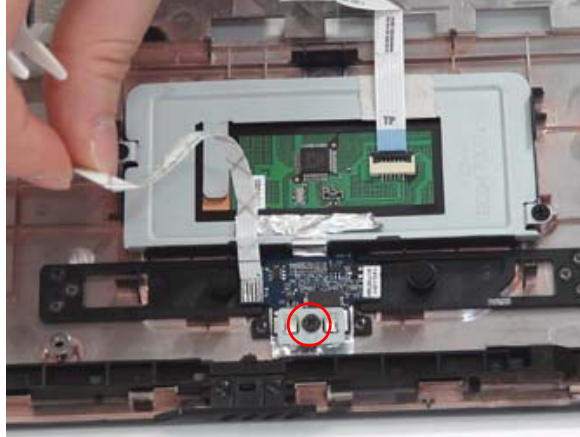

Removing the Finger Print Reader

1. See "Removing the Upper Cover" on page 72.
2. Remove the securing screw from the Finger Print Reader board, and ensure the FFC is free of the upper cover.



Step	Size	Quantity	Screw Type
Finger Print Reader	M2*3 (NL)	1	

3. Remove the board bracket from the Upper Cover.

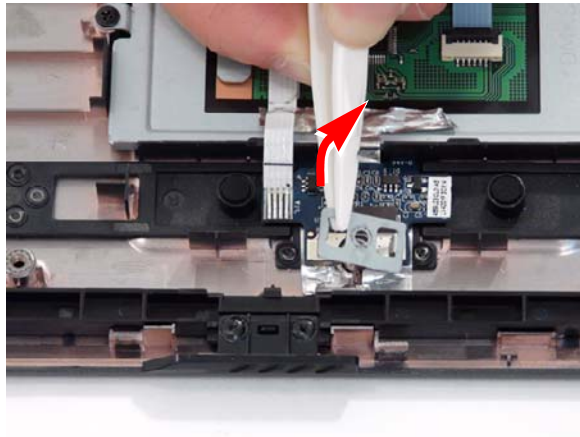

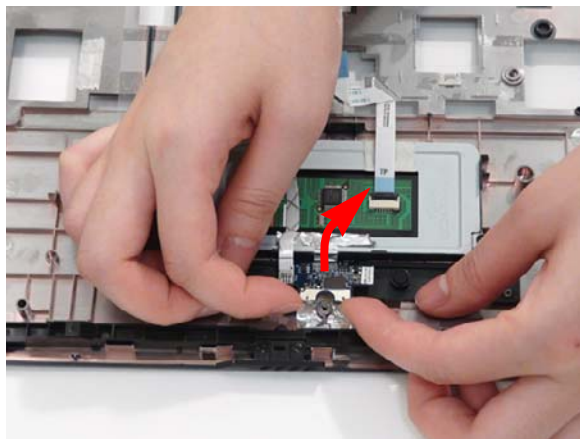

4. Using your fingers, gently lift the Finger Print Reader board from the Upper Cover.

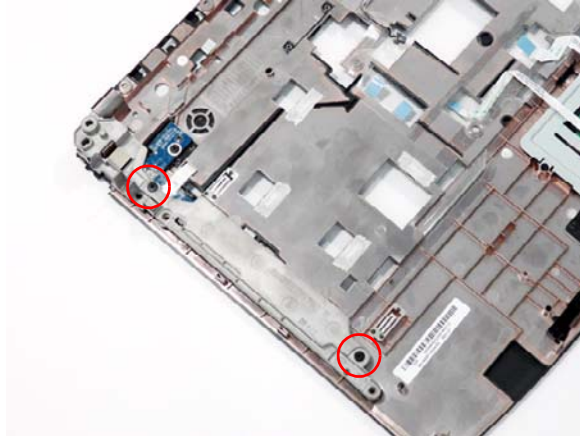

Removing the Upper Right Saddle

1. See "Removing the Upper Cover" on page 72.
2. Remove the two securing screws from the upper saddle.



Step	Size	Quantity	Screw Type
Upper Right Saddle	M2*3 (NL)	2	

3. Grasp the upper saddle and lift up to remove.

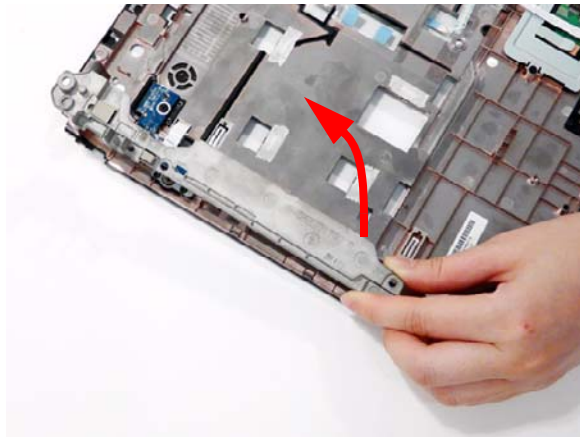

Removing the Left Speaker Module

1. See "Removing the Upper Cover" on page 72.
2. Remove the two securing screws from the left speaker.

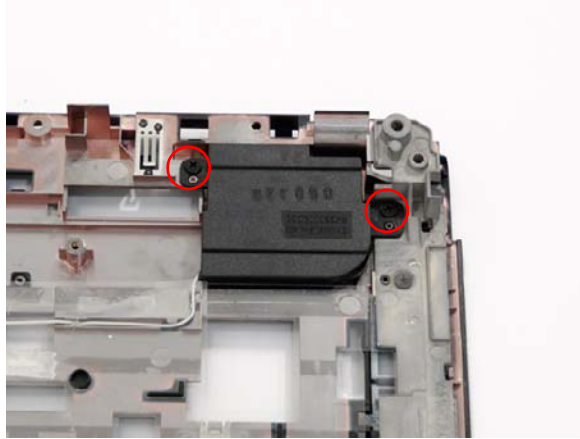

Step	Size	Quantity	Screw Type
Left Speaker Module	M2.5*4 (NL)	2	

3. Grasp both ends of the mylar cover and carefully pull back to expose the speaker cable.

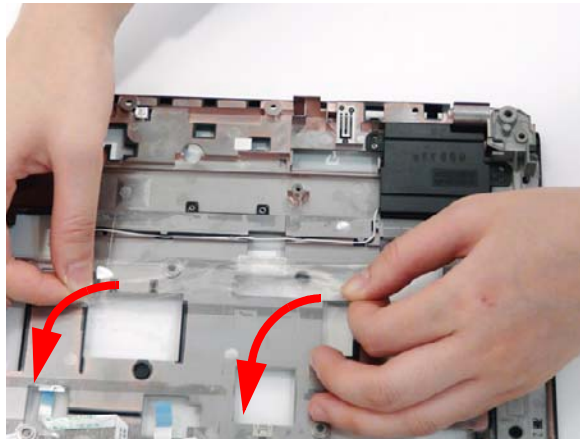

4. While holding the cover with one hand, pull back the speaker cable to remove it from the housing well.

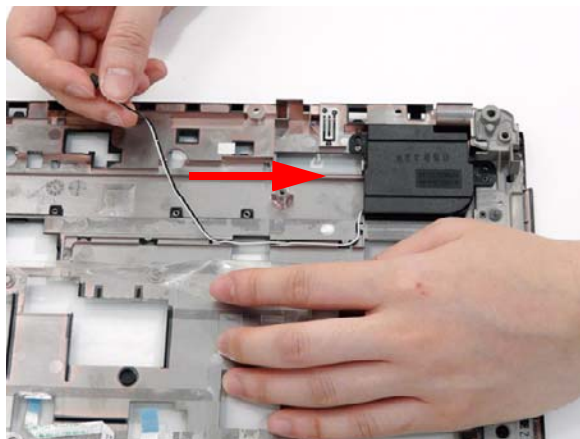

5. Remove the left speaker module as shown.

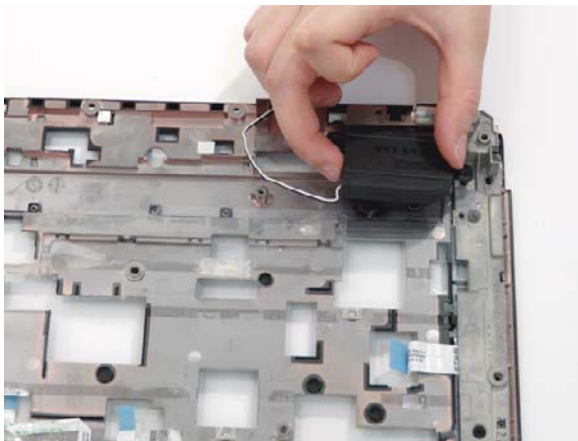

Removing the Upper Left Saddle

1. See "Removing the Upper Cover" on page 72.
2. Pull back the mylar cover to expose the top securing screw.

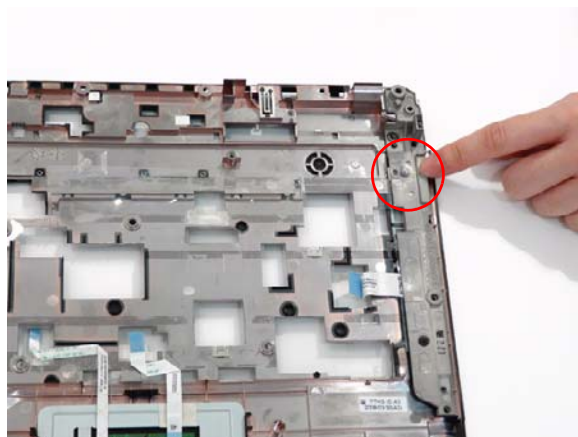

3. Remove the bottom securing screw.
4. While holding the cover back, remove the top securing screw.



Step	Size	Quantity	Screw Type
Left Speaker Module	M2.5*4 (NL)	2	

- Firmly lift and rotate the saddle counter-clockwise to remove, paying attention to the securing clip.

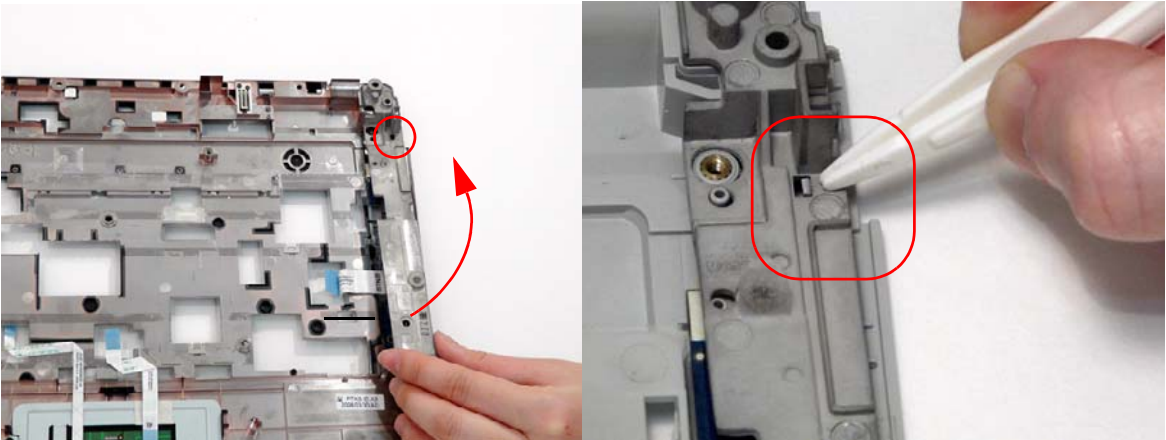

Removing the Touch Pad Bracket

- See "Removing the Upper Cover" on page 72.
- Disconnect the Touch Pad FFC from the Touch Pad board.

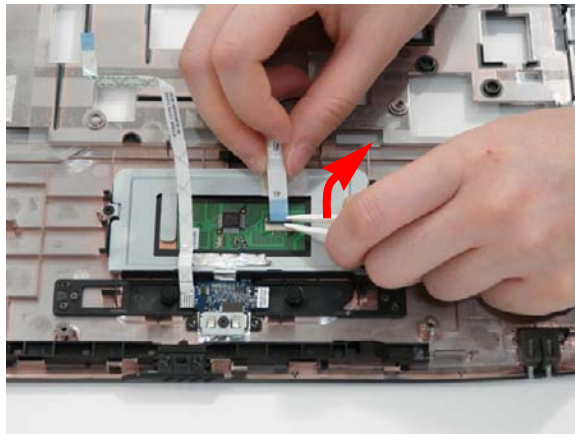

- Move the Finger Print Reader FFC cable out of the way to prevent damage, and pull back the securing foil on the bracket.

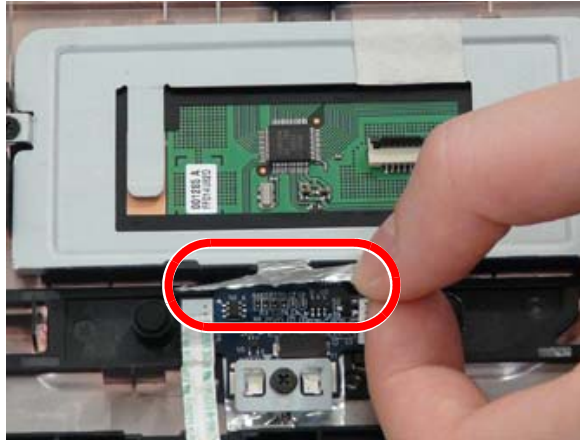

4. Remove the two securing screws from the Touch Pad bracket.

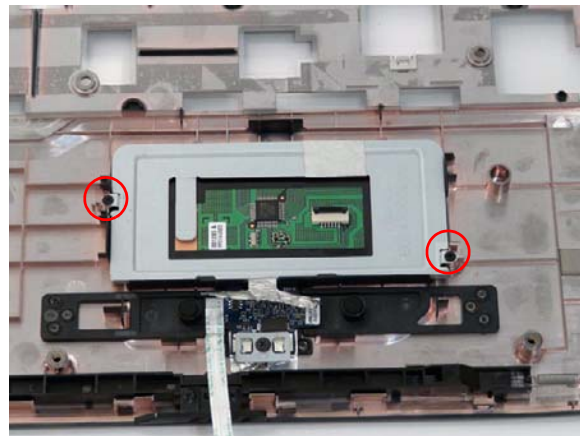

Step	Size	Quantity	Screw Type
Touch Pad Bracket	M2*3 (NL)	2	

5. Remove the Touch Pad bracket.

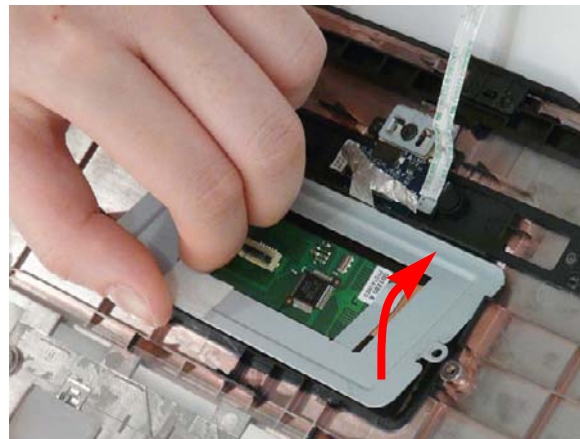

IMPORTANT:The Touch Pad cannot be removed individually. To replace the Touch Pad, replace the entire Upper Cover.

Removing the Launch Board

1. See "Removing the Upper Left Saddle" on page 79.
2. Grasp the Launch Board and lift up to remove from the Upper Cover.

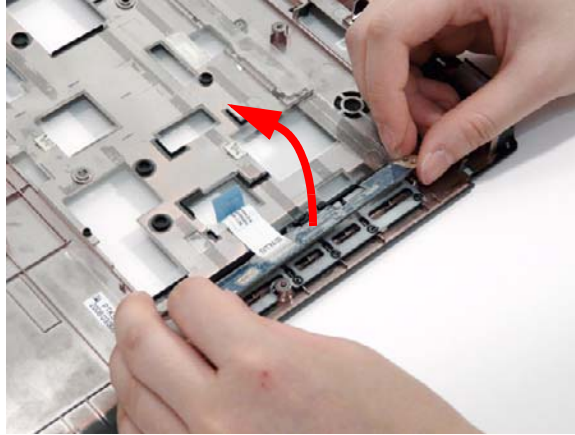

Removing the Media Board

1. See "Removing the Upper Left Saddle" on page 79.
2. Pull the FFC out of the chassis.

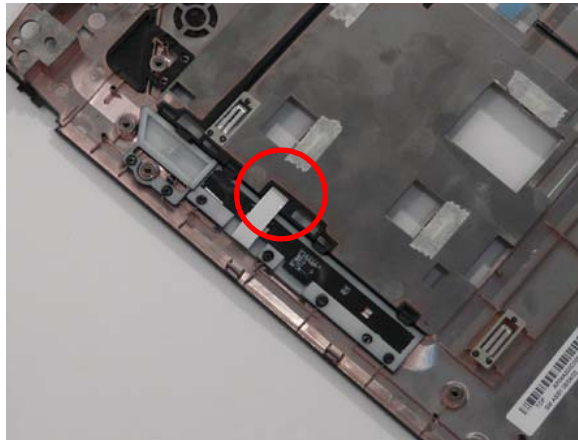

3. Insert the FFC flush with the connector and press the locking lever down to secure.

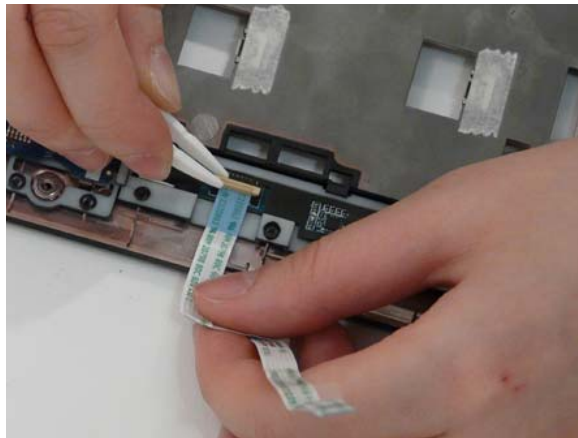

4. Use a pry to lift the Media board out of the Upper Cover.

IMPORTANT: Do not press on components to prevent damage.

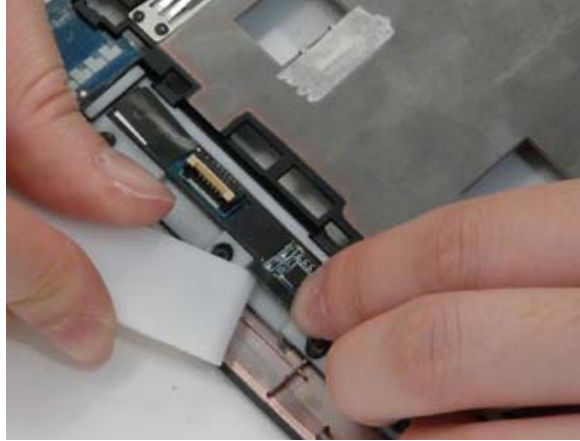

Removing the eKey Board

1. See “Removing the Upper Right Saddle” on page 77.
2. Turn the Upper Cover over and remove the FFC.

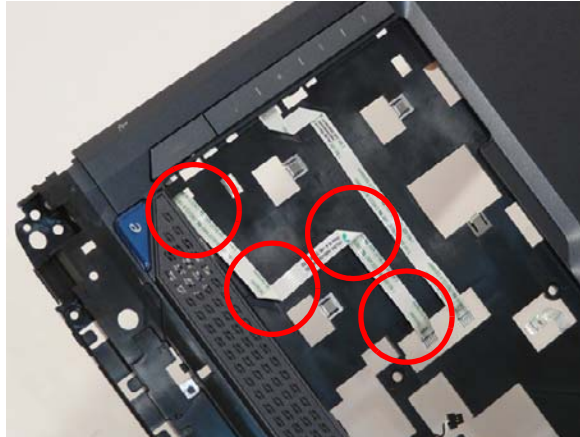

3. Remove the single screw



Step	Size	Quantity	Screw Type
eKey Board	M2*3 (NL)	1	

4. Pry the eKey board off the Upper Cover.

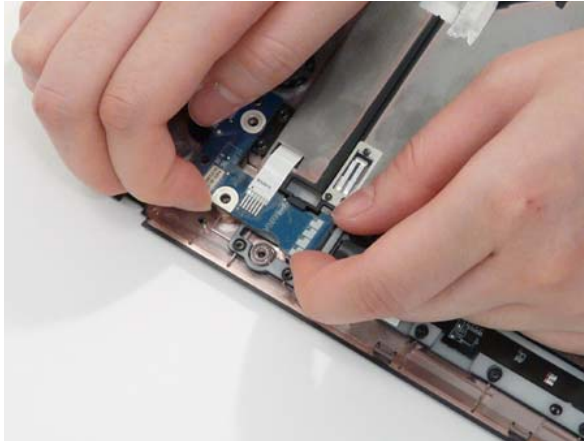

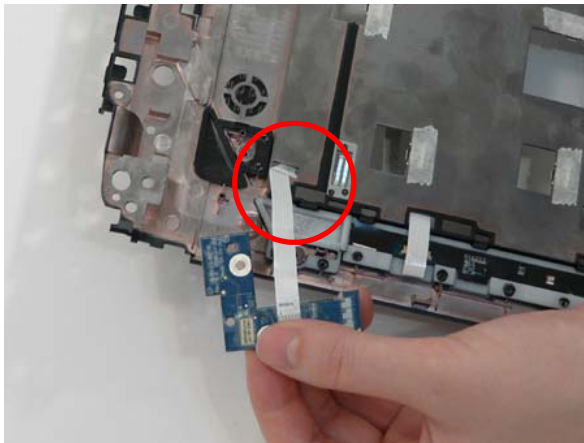

5. Grasp the board and gently pull the FFC through the Upper Cover.

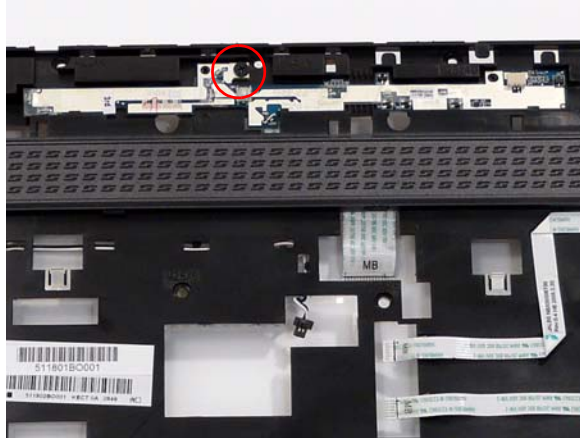

Removing the Switch Board

1. See "Removing the Upper Cover" on page 72.
2. Remove the single securing screw.



Step	Size	Quantity	Screw Type
Switch Board	M2.5*4 (NL)	1	

3. Lift the switch board and FFC up and away from the upper cover.

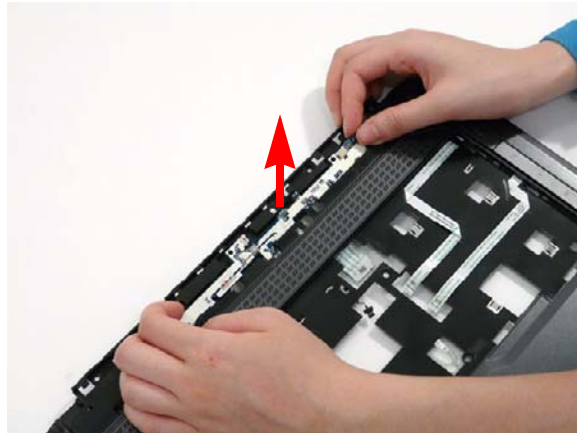

Removing the Right Speaker Module

1. Remove the Upper Cover. See “Removing the Upper Cover” on page 72.
2. Remove the two securing screws from the speaker module.

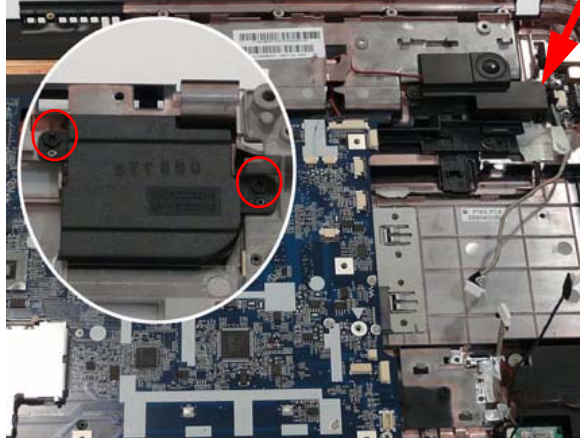

Step	Size	Quantity	Screw Type
Speaker	M2.5*4 (NL)	2	

3. Disconnect the speaker cable from the mainboard.



4. Pull the cable completely through the housing, and remove the speaker module.

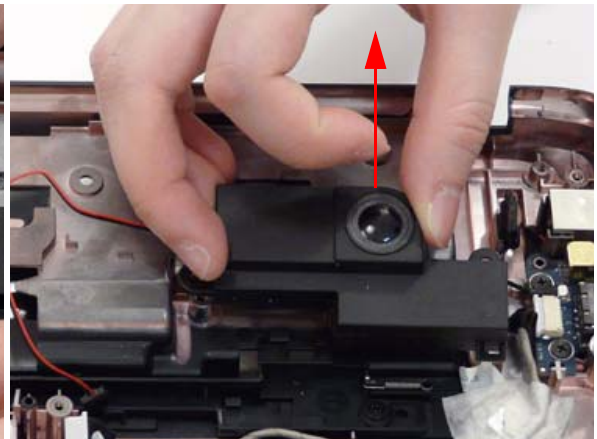
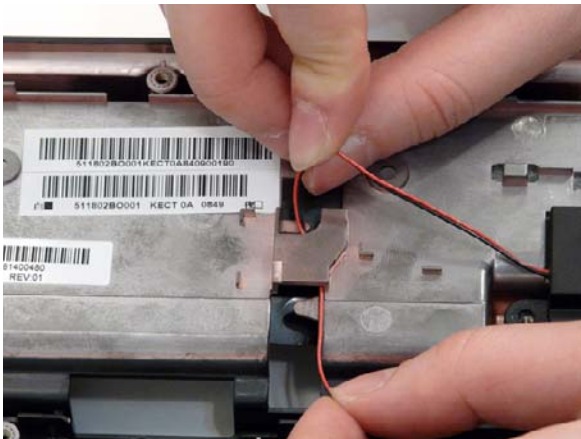

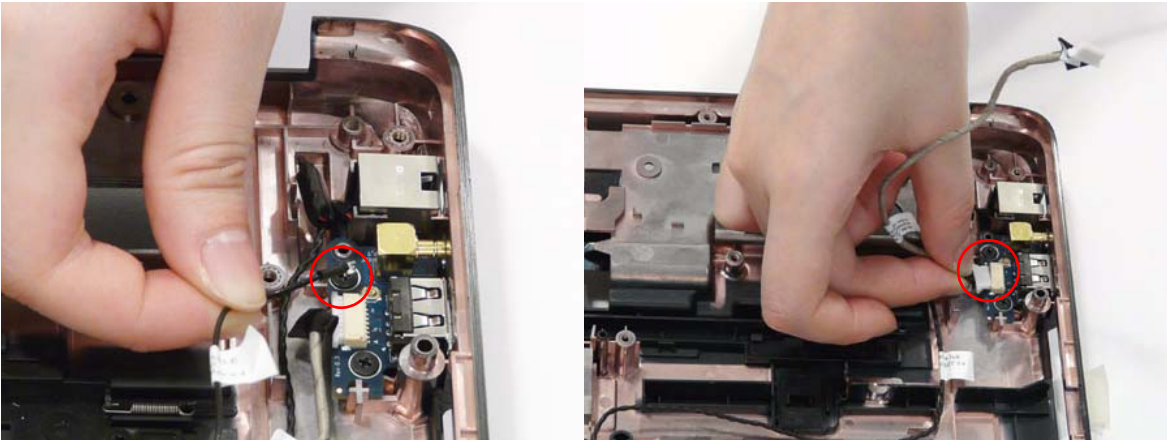

Removing the TV Board

1. See "Removing the Upper Cover" on page 72.
2. Disconnect the antenna and cable from the board.

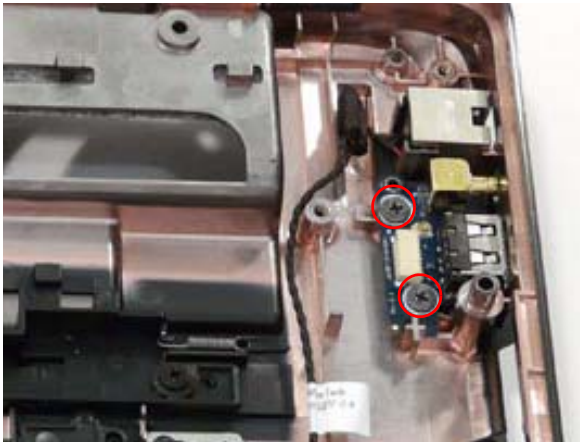

3. Remove the two securing screws from the TV board.



Step	Size	Quantity	Screw Type
TV Board	M2.5*4 (NL)	2	

4. Remove the TV board from the lower base.

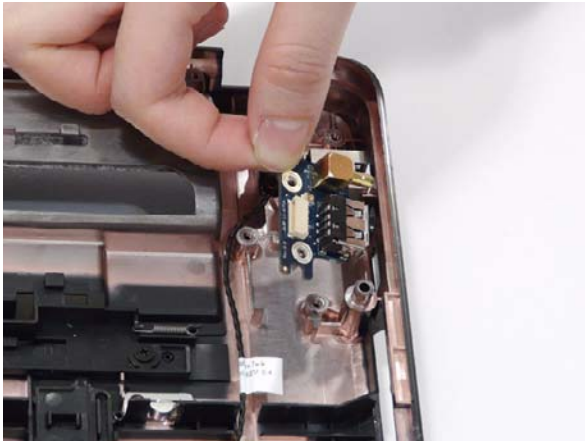

Removing the Bluetooth Module

1. See "Removing the Upper Cover" on page 72.
2. Grasp the Bluetooth module and lift to remove.

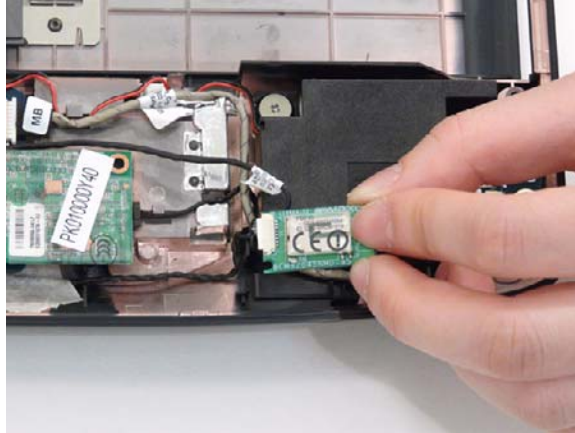

3. Lift the Bluetooth module away from the base and disconnect the bluetooth cable.

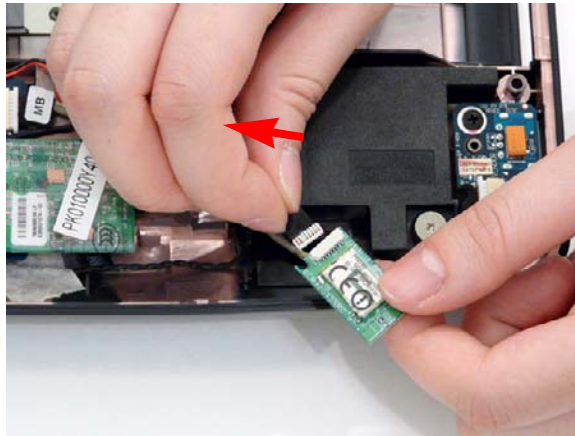

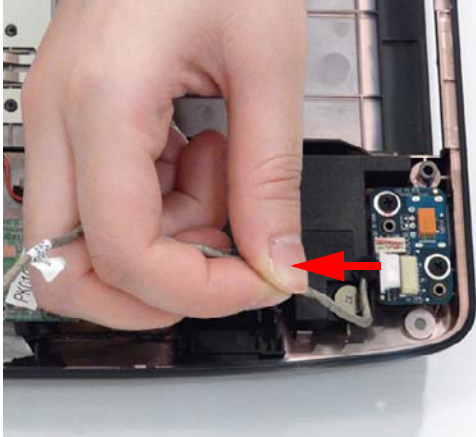

Removing the USB Board

1. See "Removing the Upper Cover" on page 72.
2. See "Removing the Bluetooth Module" on page 88.
3. Remove cable from the USB board.

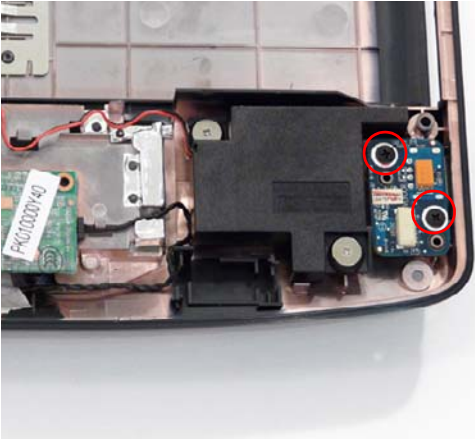

4. Remove the two securing screws from the USB board and lift clear of the chassis.



Step	Size	Quantity	Screw Type
USB board	M2.5*4 (NL)	2	

Removing the Modem Module

- 1. See "Removing the Upper Cover" on page 72.
- 2. Remove securing screw from the modem module.

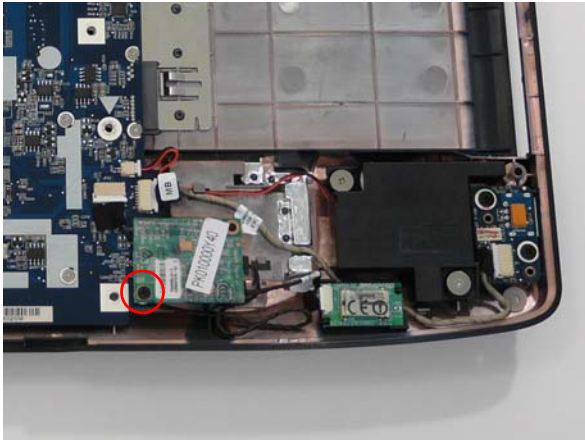

Step	Size	Quantity	Screw Type
Modem Module	M2*3 (NL)	1	

- 3. Lift the module and disconnect the modem cable as shown in the following images.

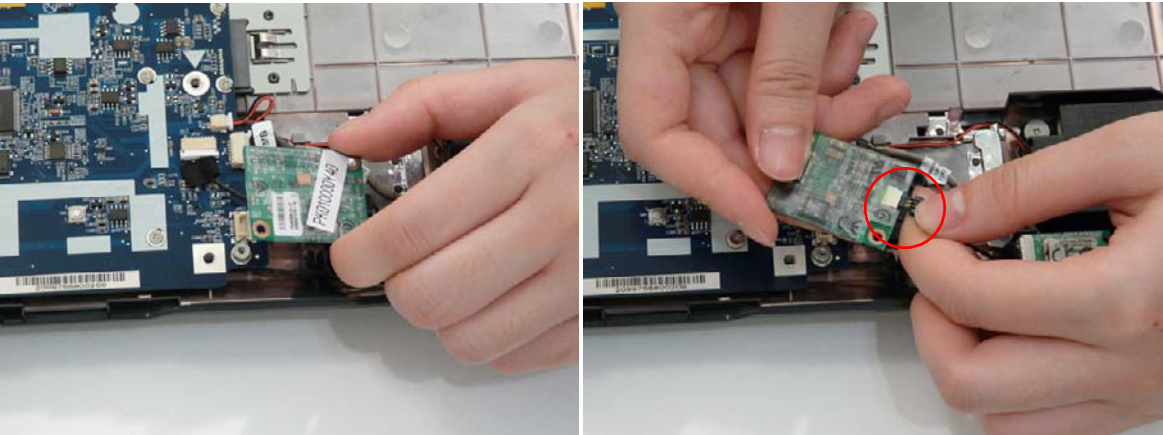

Removing the Subwoofer Module

1. See "Removing the Upper Cover" on page 72.
2. Disconnect the subwoofer cable as shown.

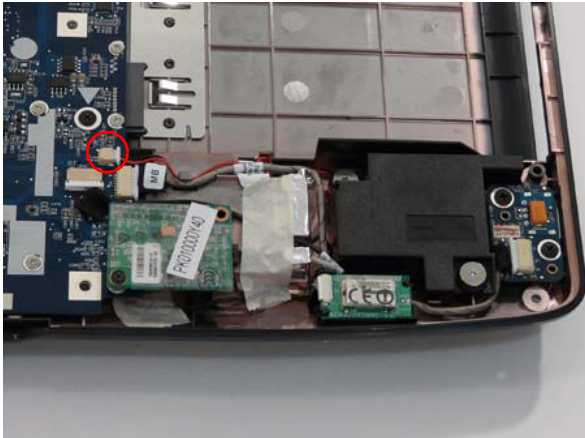

3. Remove the two securing screws from the subwoofer module and lift the subwoofer clear of the chassis.

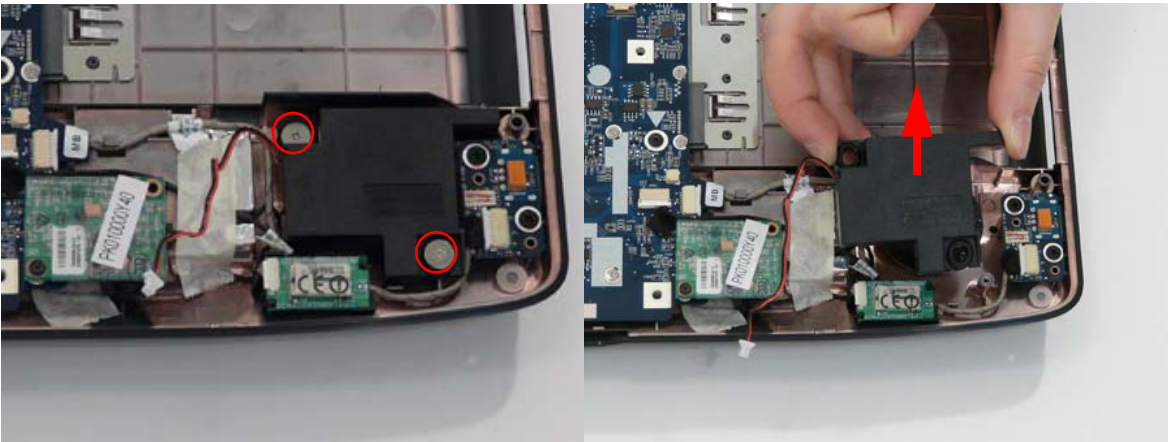

Step	Size	Quantity	Screw Type
Subwoofer	M2*3 (NL)	2	

Removing the Main Board

1. See “Removing the Battery Pack” on page 50.
2. See “Removing the Keyboard” on page 67.
3. See “Removing the LCD Module” on page 70.
4. See “Removing the Upper Cover” on page 72.
5. Disconnect the three cables from the bottom right of the mainboard as shown.

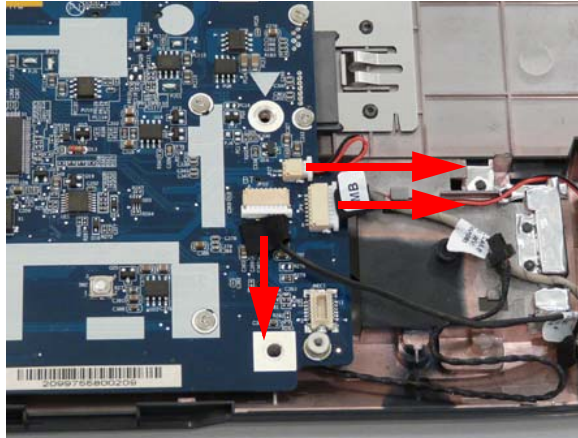

6. Disconnect the two cables from the top right of the mainboard as shown.

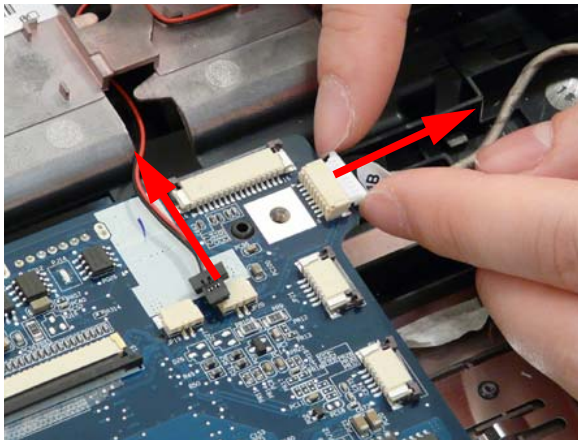

7. Remove the two securing screws from the Mainboard.

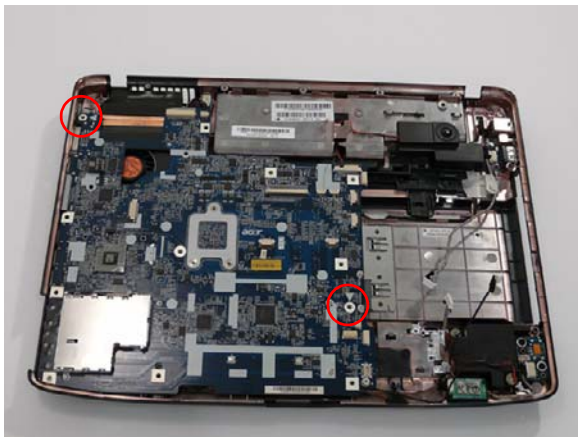

Step	Size	Quantity	Screw Type
Mainboard	M2.5*5 (NL)	2	

8. Remove the main board, rightside first, as shown.

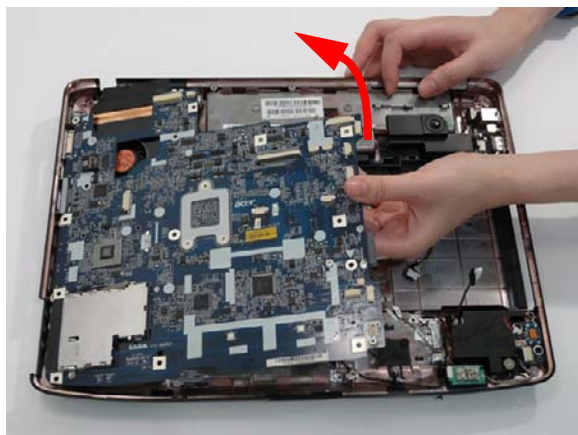

9. Lift the power jack clear of power port on the Lower Cover.



Removing the RJ-11 Port

1. See “Removing the Upper Cover” on page 72.
2. See “Removing the Right Speaker Module” on page 86.
3. See “Removing the Main Board” on page 92.
4. Remove the RJ-11 cable from its housing.

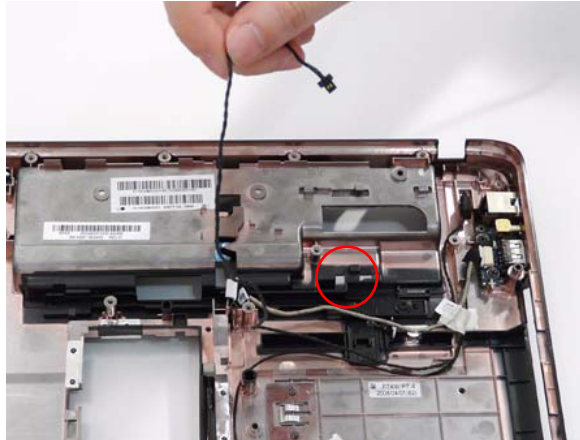

5. Using the tweezers to grasp the end of the cable to detach from the base.

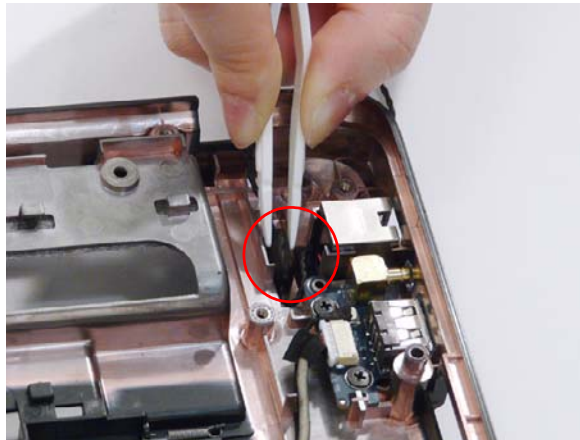

6. Insert the tweezers in the RJ-11 port and push up to detach and lift the port from the base.

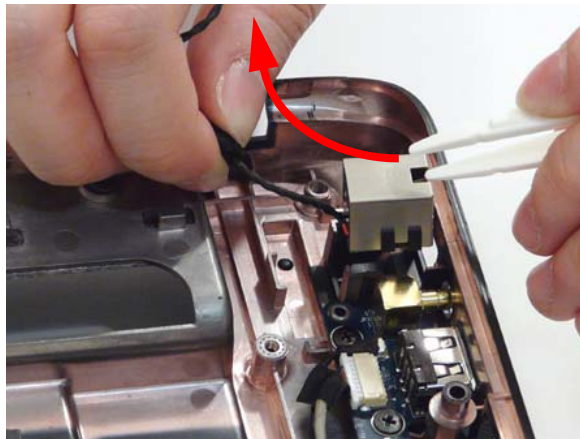

Removing the Thermal Module

1. See "Removing the Battery Pack" on page 50.
2. See "Removing the LCD Module" on page 70.
3. See "Removing the Upper Cover" on page 72.
4. See "Removing the Main Board" on page 92.
5. Remove the eight securing screws from the Thermal Modules.

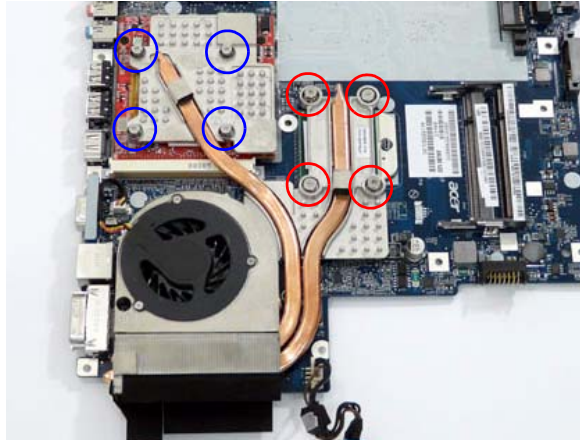

Step	Size	Quantity	Screw Type
CPU Thermal Module (red callout)	M2*6.5	4	
VGA Thermal Module (blue callout)	M2*L3	4	

6. Disconnect the fan module cable from mainboard.

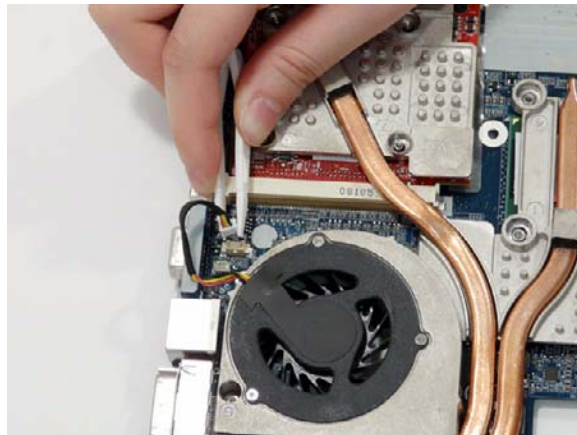

7. Lift the Thermal Module clear of the Mainboard.



Removing the CPU

1. See “Removing the Battery Pack” on page 50.
2. See “Removing the Upper Cover” on page 72.
3. See “Removing the Main Board” on page 92.
4. See “Removing the Thermal Module” on page 95.
5. Using a flat screwdriver, turn the CPU socket latch counter-clockwise 180° to release the CPU.



6. Lift the CPU clear of the Mainboard.



Removing the VGA Module

1. See "Removing the Battery Pack" on page 50.
2. See "Removing the Upper Cover" on page 72.
3. See "Removing the Main Board" on page 92.
4. Remove the two securing screws from the VGA Module.

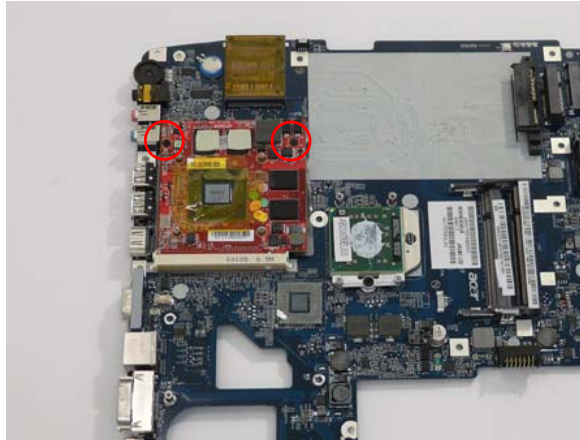

Step	Size	Quantity	Screw Type
VGA Module	M2*4-NI (NL)	2	

5. The VGA module lifts automatically from the mainboard. Remove the VGA Module as shown.

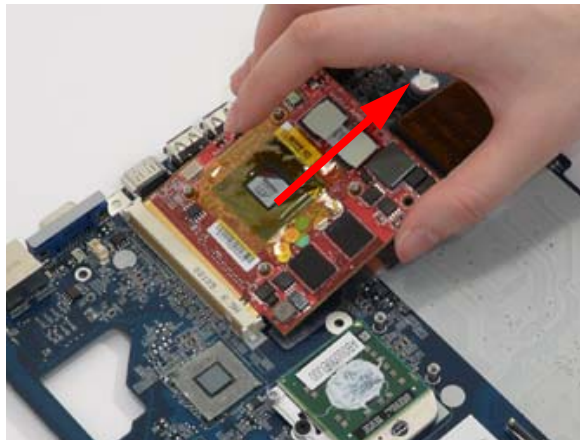

LCD Module Disassembly Process

LCD Module Disassembly Flowchart

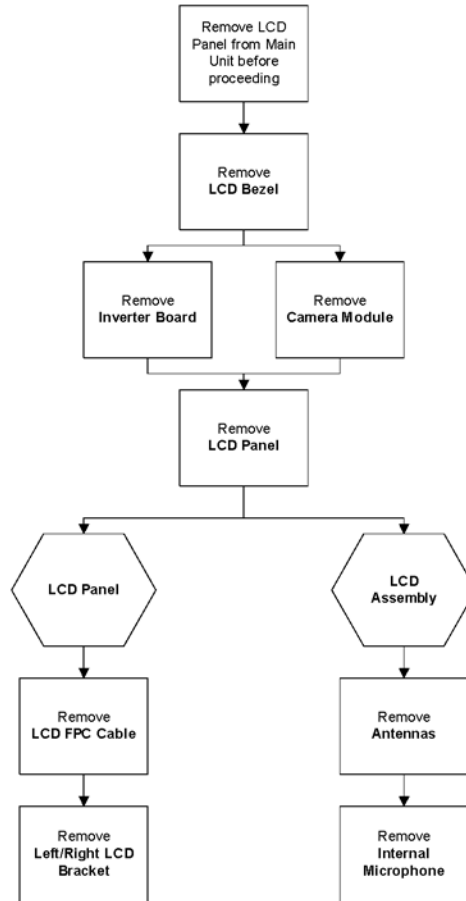

Screw List

Step	Screw	Quantity	Color	Part No.
LCD Bezel	M2.5*5 (NL)	4	Black	
Inverter Board	M2.5*5 (NL)	1	Black	
Camera Module	M2*3 (NL)	2	Black	
Camera Board	M2*3 (NL)	1	Black	
LCD Panel	M2.5*5 (NL)	2	Black	
LCD Brackets	M2*3 (NL)	8	Black	

Removing the LCD Bezel

1. See "Removing the Battery Pack" on page 50.
2. See "Removing the LCD Module" on page 70.
3. Remove the two upper and two lower bezel screw caps. Remove the four securing screws from the LCD module.

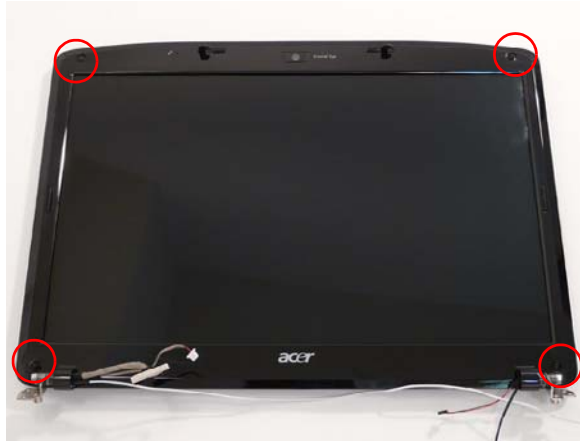

Step	Size	Quantity	Screw Type
LCD Bezel	M2.5*5 (NL)	4	

4. Lift up the bezel, topside first, and remove it from the LCD Module.



Removing the Inverter Board

1. See "Removing the Battery Pack" on page 50.
2. See "Removing the LCD Module" on page 70.
3. See "Removing the LCD Bezel" on page 100.
4. Remove the securing tapes from the left and right sides of the Inverter board as shown.



5. Remove the two securing screws from the Inverter board and lift the board clear of the LCD Module.



Step	Size	Quantity	Screw Type
Inverter Board	M2.5*6 (NL)	2	

6. Disconnect the left and right Inverter board cables as shown.

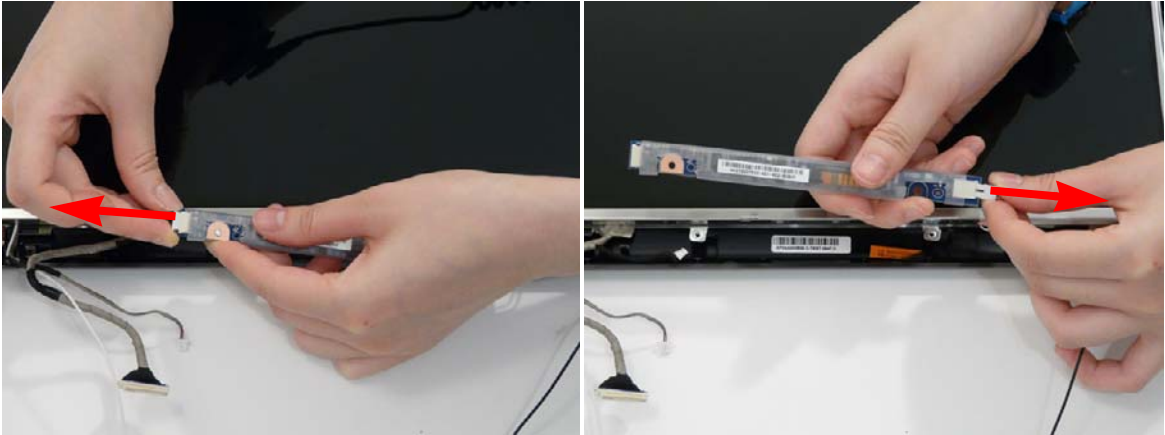

Removing the Camera Module

1. See "Removing the Battery Pack" on page 50.
2. See "Removing the Lower Covers" on page 53.
3. See "Removing the WLAN Module" on page 56.
4. See "Removing the Keyboard" on page 67.
5. See "Removing the LCD Module" on page 70.
6. See "Removing the LCD Bezel" on page 100.
7. Disconnect the Camera Module cable as shown.

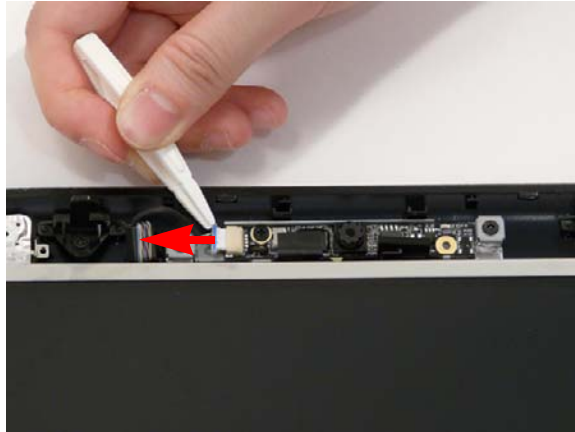

8. Remove the two securing screws from the Camera Module bracket.

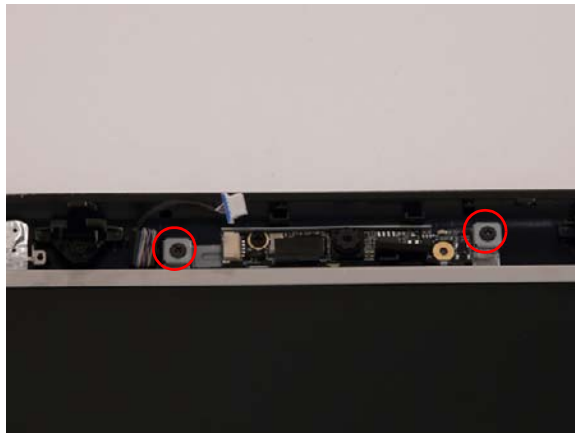

Step	Size	Quantity	Screw Type
Camera Module bracket	M2*3 (NL)	2	

9. Lift the Camera Module clear of the LCD Module.



10. Remove the securing screw from the camera board.

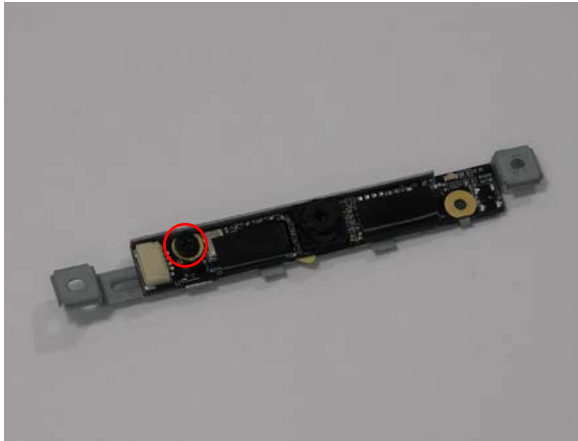

Step	Size	Quantity	Screw Type
Camera Board	M2*3 (NL)	1	

11. Remove the camera board from the bracket.

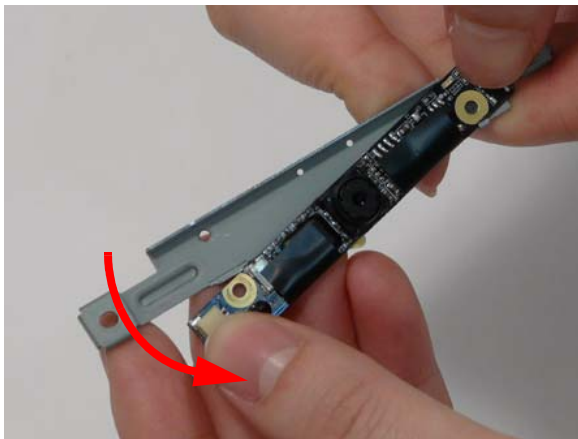

Removing the LCD Panel

1. See "Removing the Battery Pack" on page 50.
2. See "Removing the Lower Covers" on page 53.
3. See "Removing the WLAN Module" on page 56.
4. See "Removing the Keyboard" on page 67.
5. See "Removing the LCD Module" on page 70.
6. See "Removing the LCD Bezel" on page 100.
7. Remove the two securing screws from the LCD Module.



Step	Size	Quantity	Screw Type
LCD Panel	M2.5*6 (NL)	2	

8. Lift the LCD Panel clear of the LCD Module.



Removing the LCD Brackets and FPC Cable

1. See "Removing the Battery Pack" on page 50.
2. See "Removing the Lower Covers" on page 53.
3. See "Removing the WLAN Module" on page 56.
4. See "Removing the Keyboard" on page 67.
5. See "Removing the LCD Panel" on page 105.
6. Turn the LCD panel over to expose the rear. Disconnect the cable from the LCD Panel using the tab provided.



7. Grip the FPC cable and lift upward to detach the adhesive pads.
8. Remove the eight securing screws (four on each side) from the LCD Panel brackets.

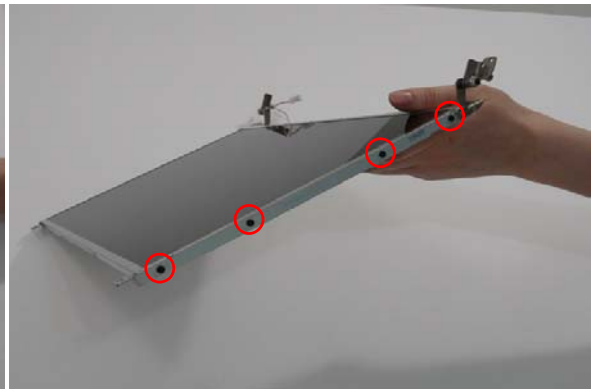
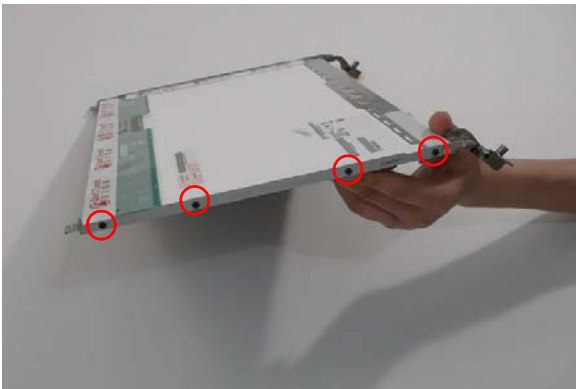

Step	Size	Quantity	Screw Type
LCD Brackets	M2*3 NL	8	

9. Remove the LCD brackets by pulling away from the LCD Panel.

Removing the Antennas

1. See "Removing the Battery Pack" on page 50.
2. See "Removing the Lower Covers" on page 53.
3. See "Removing the WLAN Module" on page 56.
4. See "Removing the LCD Panel" on page 105.
5. Remove the strips holding the antenna cables in place. Ensure the cables are free from obstructions.



6. Remove the tabs securing the left and right antennas to the LCD module.

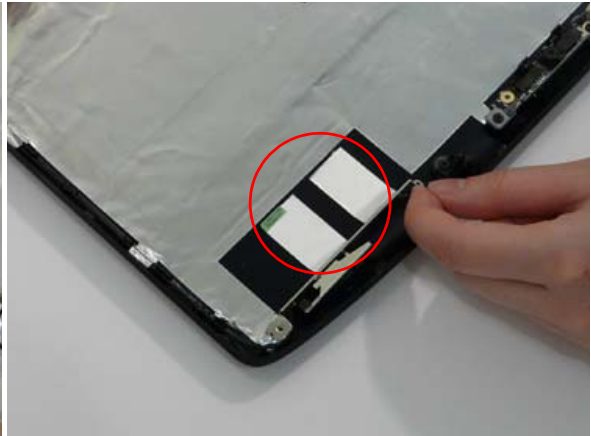
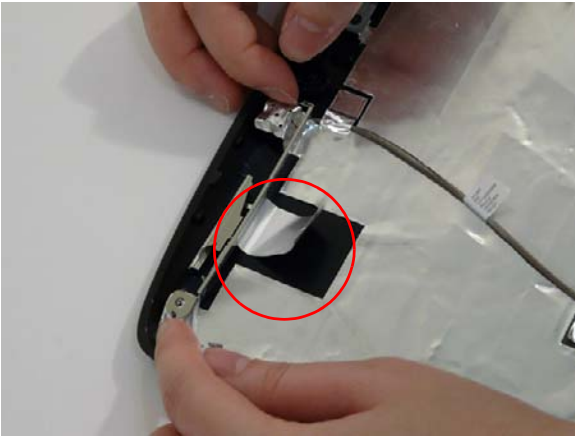

7. Remove the antenna cables and assembly from the LCD module.

Removing the MIC Module

1. See “Removing the Battery Pack” on page 50.
2. See “Removing the Lower Covers” on page 53.
3. See “Removing the WLAN Module” on page 56.
4. See “Removing the LCD Panel” on page 105.
5. Remove the strips holding the MIC Module cable in place. Ensure the cable is free from obstructions.

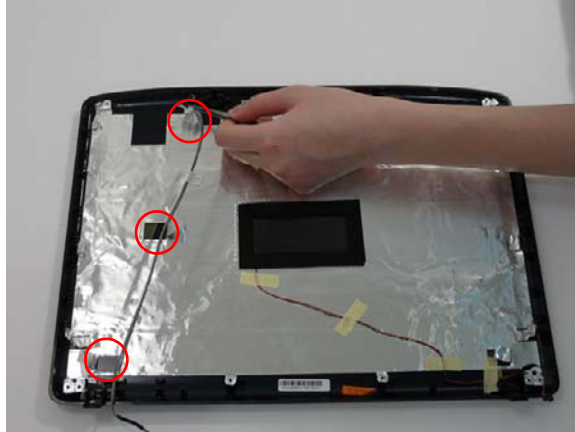

6. Remove the MIC cable and Module from the LCD module.

LCD Module Reassembly Procedure

Replacing the LCD Panel

1. Align the LCD brackets with the eight screw holes (four on each side) on the LCD Panel as shown.

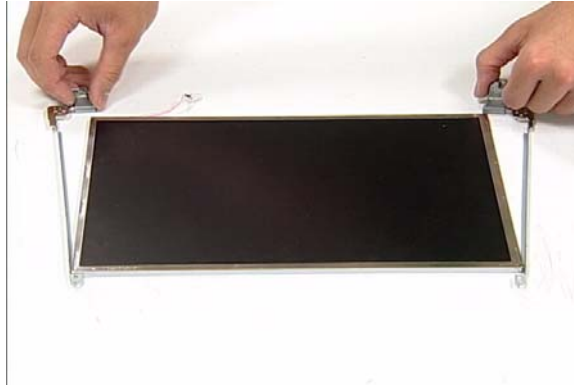

2. Secure the LCD brackets to the LCD panel.

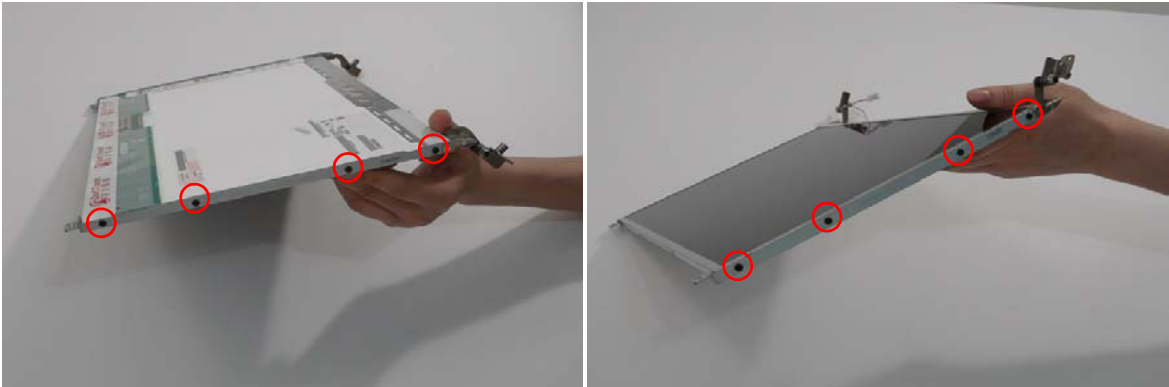

3. Turn the panel over. Insert the LCD Panel cable into the LCD Panel as shown.



4. Replace the MIC cable under the mylar tab strips, and replace the MIC as shown. Secure the cable by pressing down on the strips.

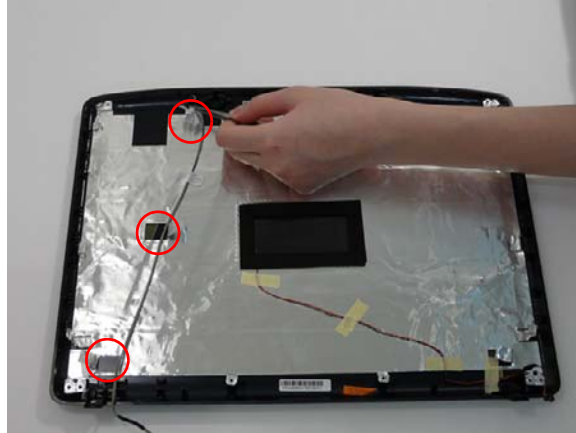

5. Replace the antenna cables and assembly.
6. Replace the tabs securing the left and right antennas to the LCD module.

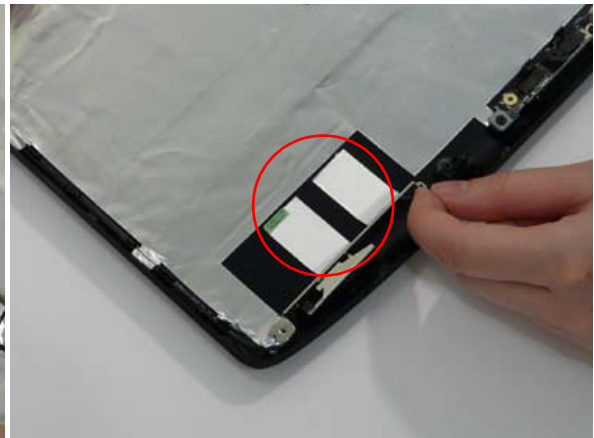
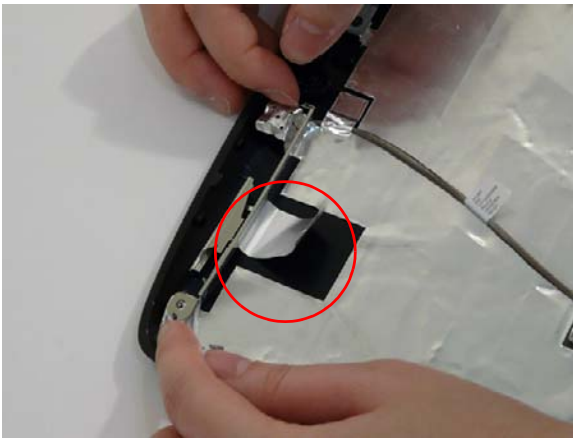

7. Replace the strips holding the antenna cables in place. Ensure the cables are free from obstructions.

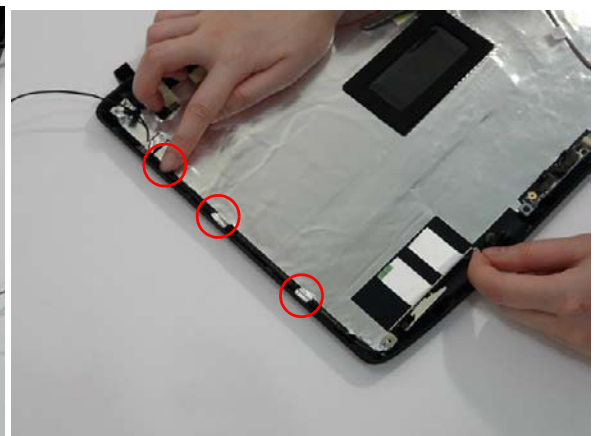
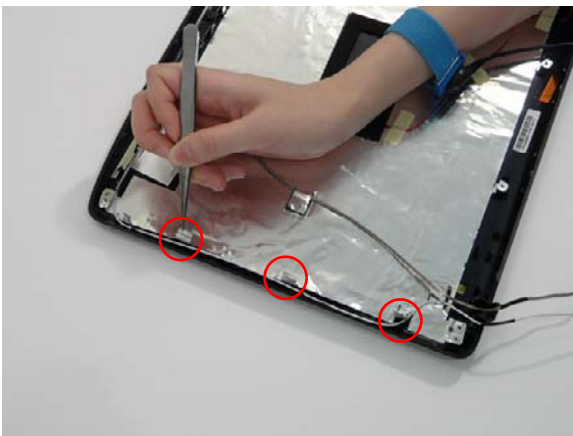

8. Secure the cable by pressing down on the securing strip.



9. Replace the two securing screws on the LCD Module.



10. Replace the camera board in the bracket.

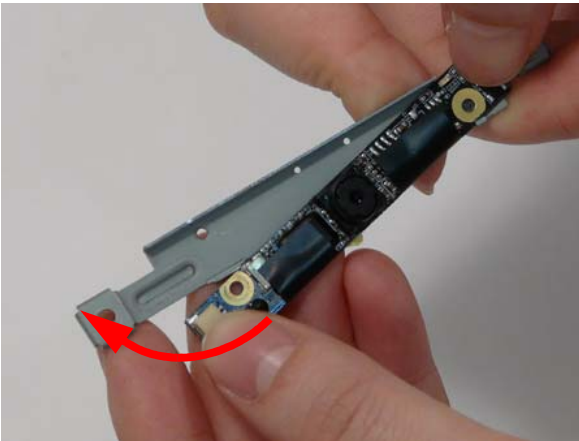

11. Replace the securing screw on the camera board.

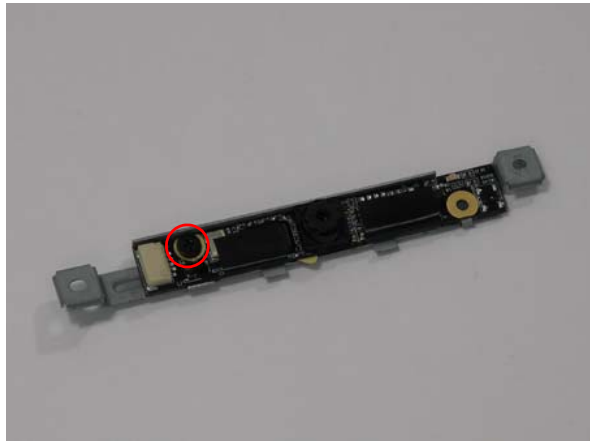

12. Replace the Camera Module in the bottom cover.

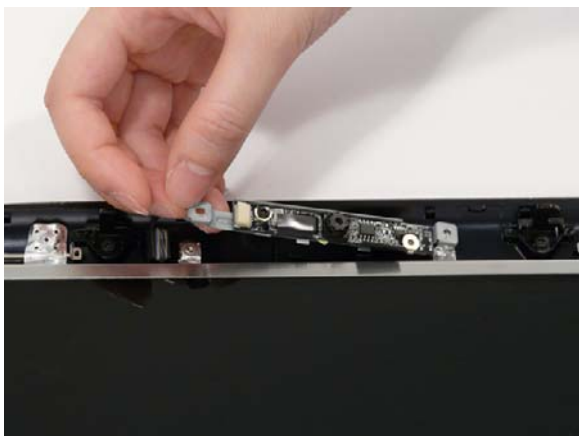

13. Replace the two securing screws on the Camera Module bracket.

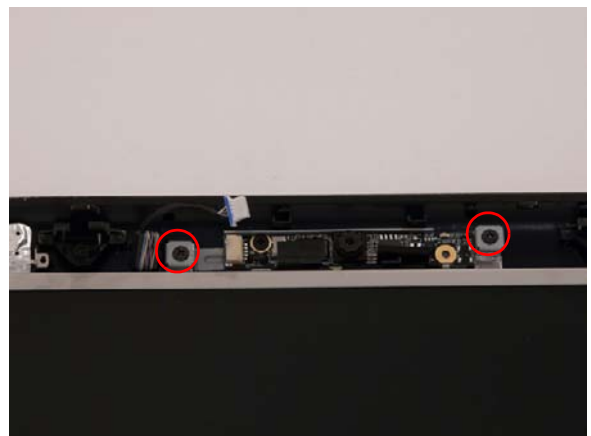

14. Connect the Camera Module cable as shown.



15. Connect the left and right Inverter board cables as shown.

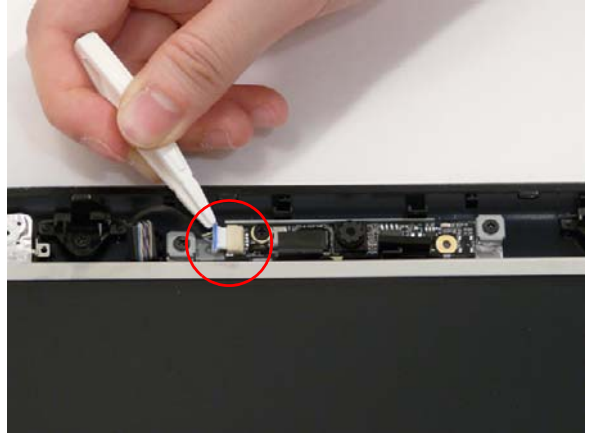

16. Connect the left and right Inverter board cables as shown.

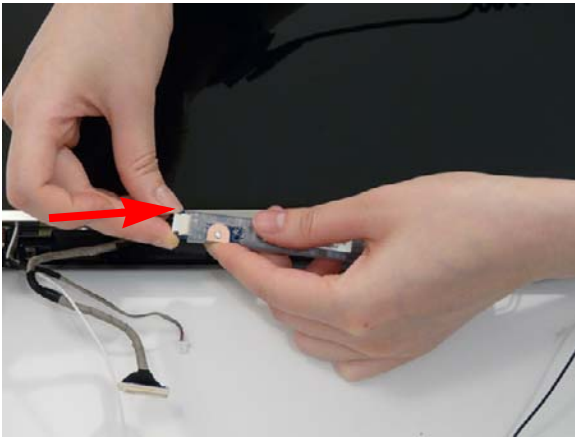

17. Replace the inverter board and secure with the two provided screws.



18. Replace the securing tapes from the left and right sides of the Inverter board as shown.

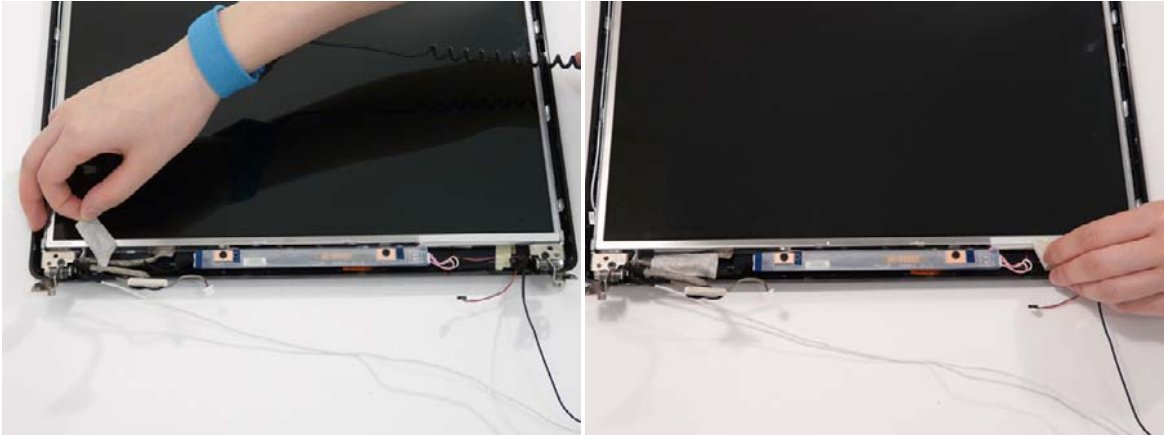

NOTE: Tuck the cables securely to prevent damage to the cables or module.

Replacing the LCD Bezel

1. Align the edge of the bezel with the bottom cover and replace the LCD Module.



2. Replace the two upper and two lower bezel screw caps. Remove the four securing screws from the LCD module.

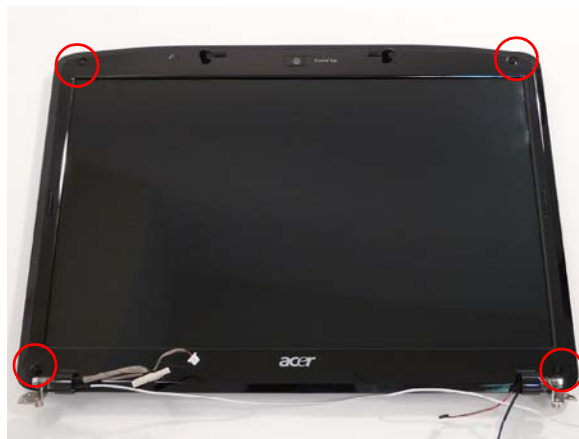

Main Module Reassembly Procedure

Replacing the VGA Module

1. Insert the VGA Module as shown.
2. Replace the two securing screws on the VGA Module.

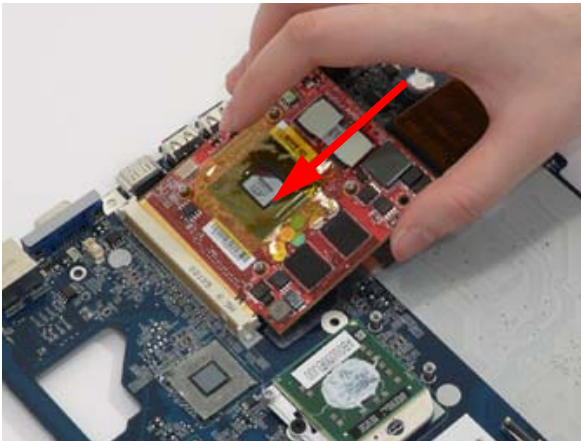

Replacing the CPU

1. Carefully turn the mainboard upside down (CPU side up), and insert the CPU into the CPU bracket as shown.
2. Using a flat-tipped screw driver, lock the CPU in the socket as shown.

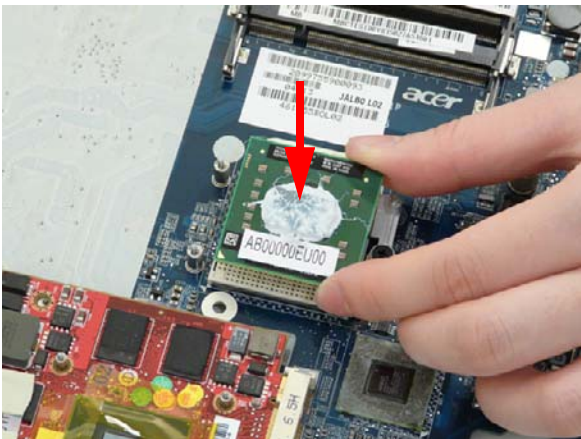

Replacing the Thermal Module

1. Align and place the Thermal Module in the mounting as shown.
2. Connect the fan module cable to the mainboard.

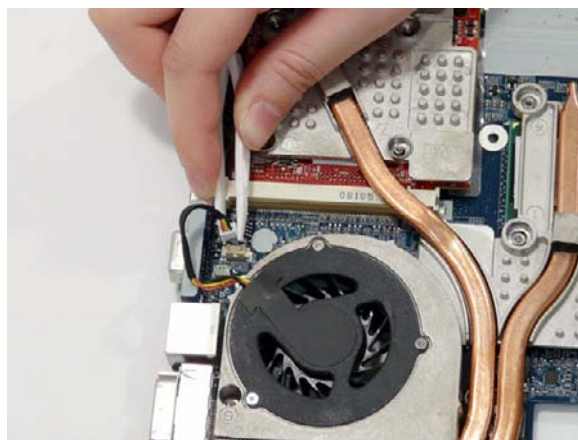

3. Replace the eight securing screws from the Thermal Module.

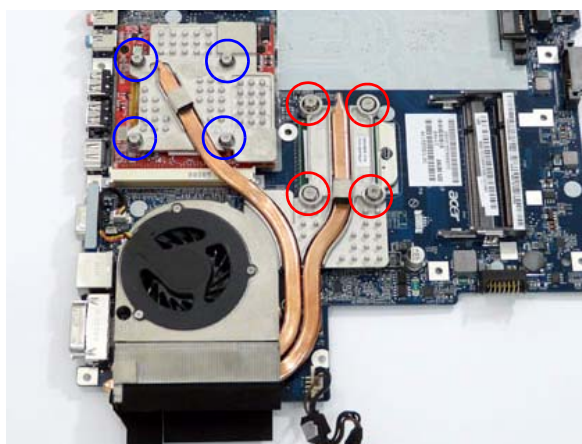

Replacing the RJ-11 Port

1. Insert the RJ-11 port into the base as shown.
2. Using the tweezers, grasp the end of the cable and press down to attach it to the base.

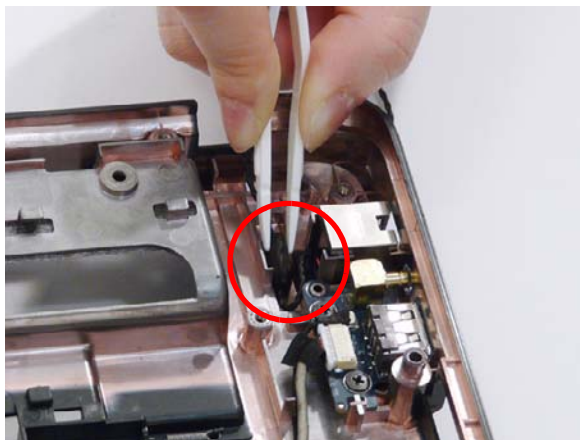
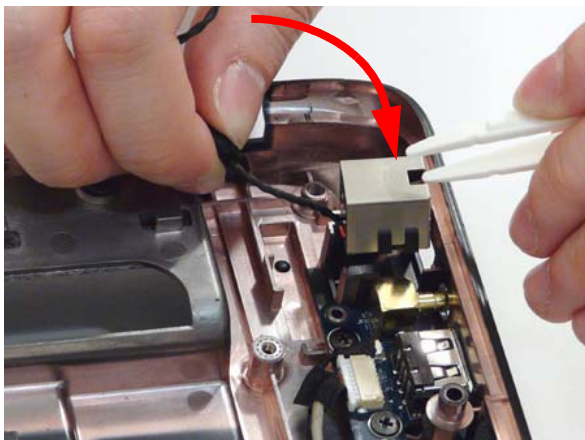

3. Replace the RJ-11 cable in its housing.

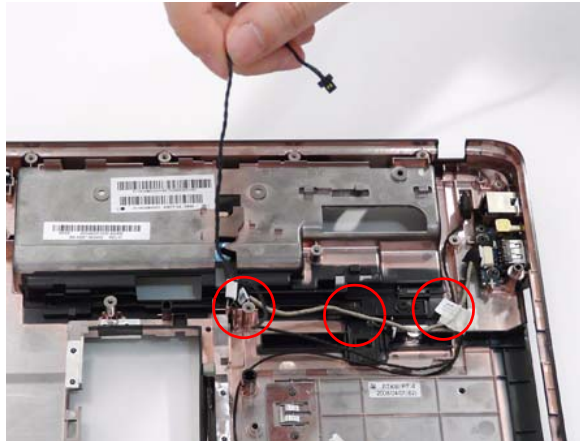

Replacing the Mainboard

1. Replace the power jack in the Lower Cover.
2. Gently lower the mainboard, leftside first, on the lower base. Ensure the screw sockets are aligned.

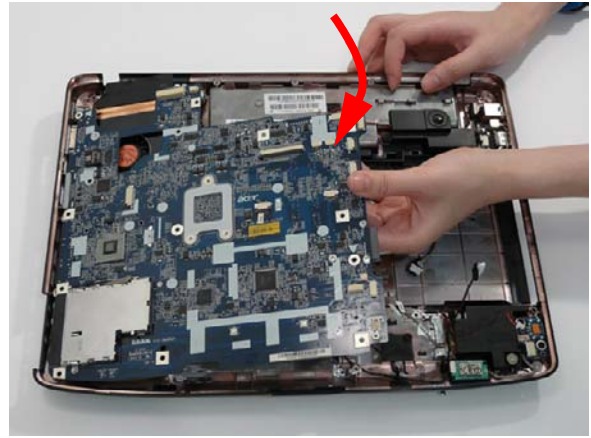
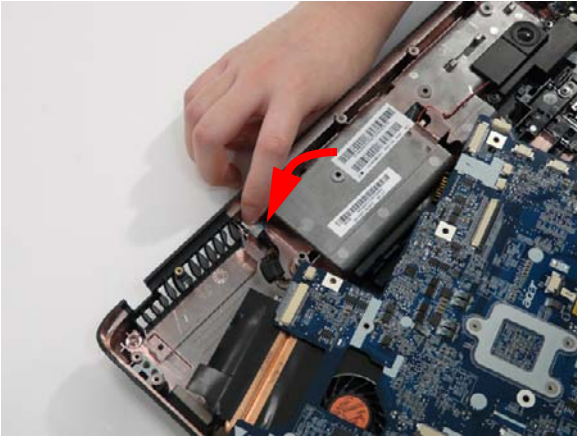

3. Ensure that the Mainboard is face up (the Heatsink and CPU are not visible). Place the Mainboard in the chassis, rear edge first, and press down to install. Replace the two securing screws as shown.
NOTE: Make sure the I/O ports are positioned correctly through the lower cover, and the screw sockets are visible through the mainboard.

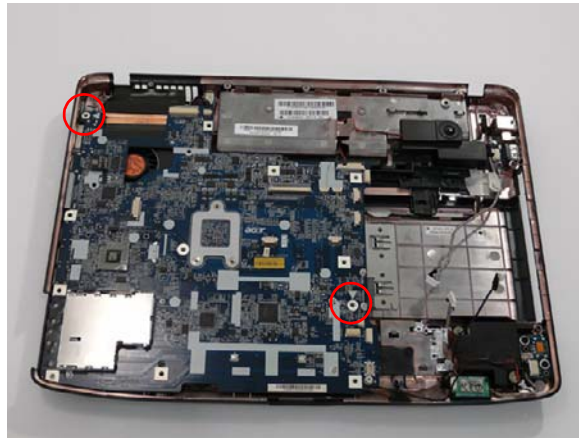

4. Connect the two cables on the top right of the mainboard as shown.
5. Connect the three cables from the bottom right of the mainboard as shown.

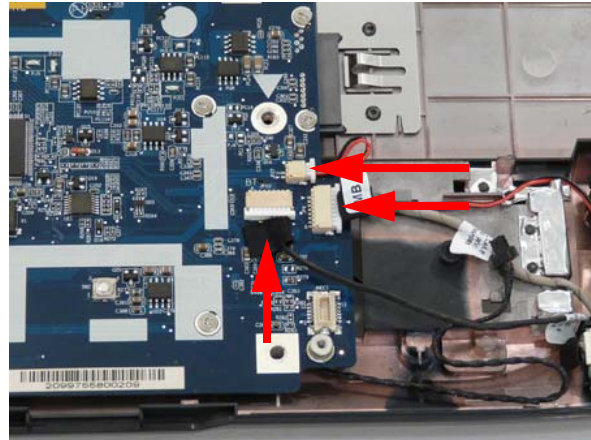
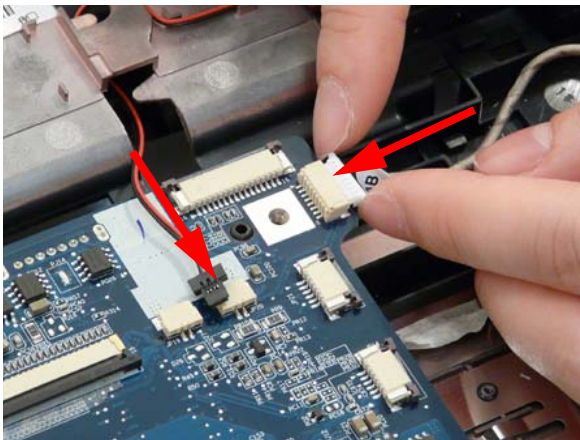

Replacing Subwoofer Module

6. Locate the Subwoofer on the lower cover, and replace the two securing screws.

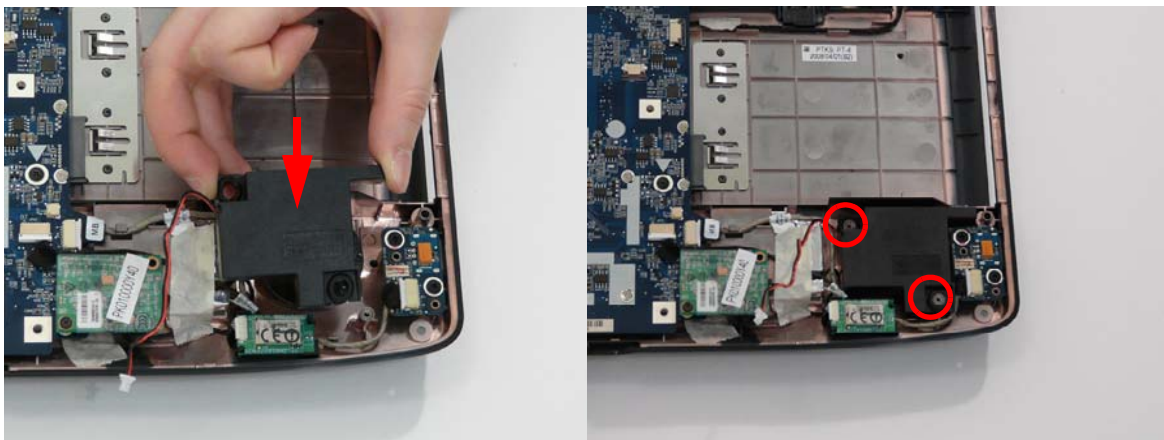

7. Connect the subwoofer cable as shown.

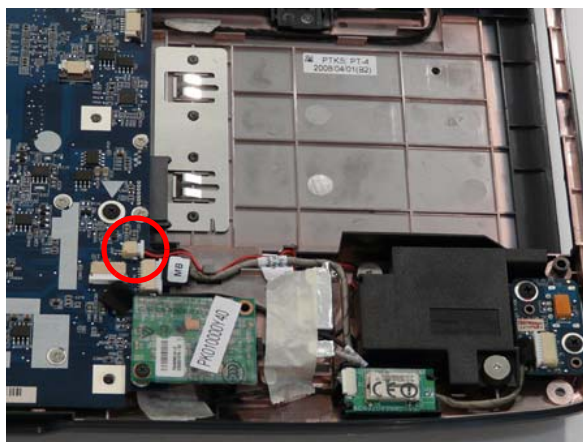

Replacing the Modem Module

1. Connect the modem cable and locate it over the screw socket.
2. Insert module in mainboard.

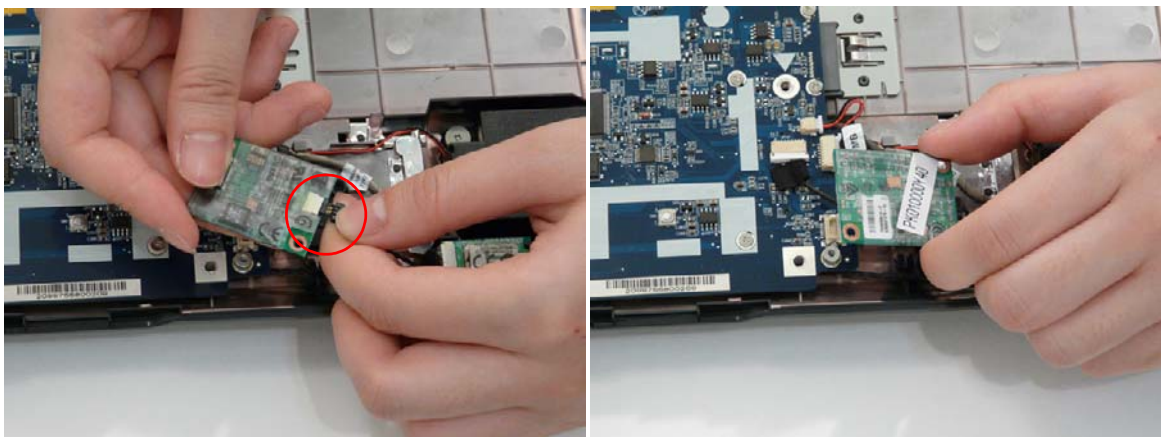

3. Replace the securing screw on the modem module.



Replacing the USB Board

1. Angle the right side of the USB board into the lower base. Align the screw sockets and replace the two securing screws.

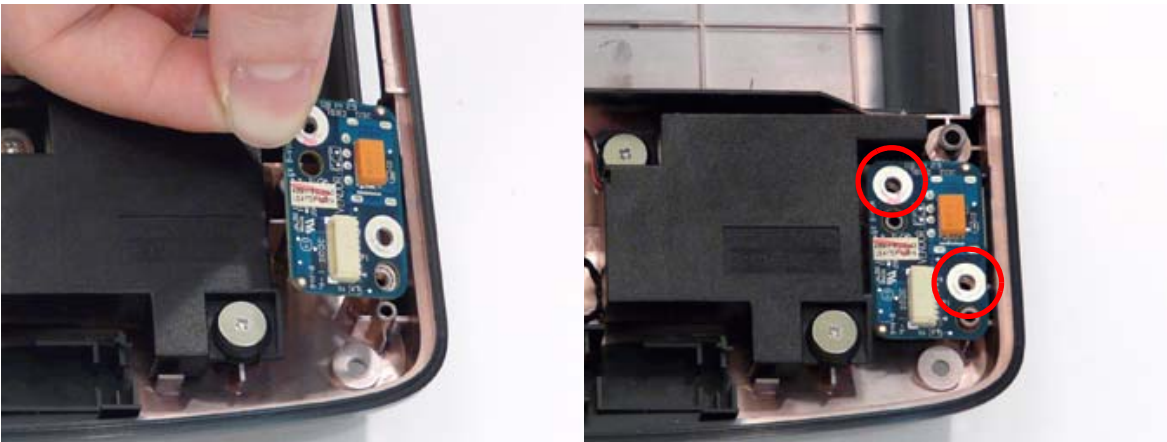

2. Replace the cable on the USB board.



Replacing the Bluetooth Board

1. While holding the Bluetooth module, connect the cable as shown.
2. Position the module over the aligning pins and insert in place.

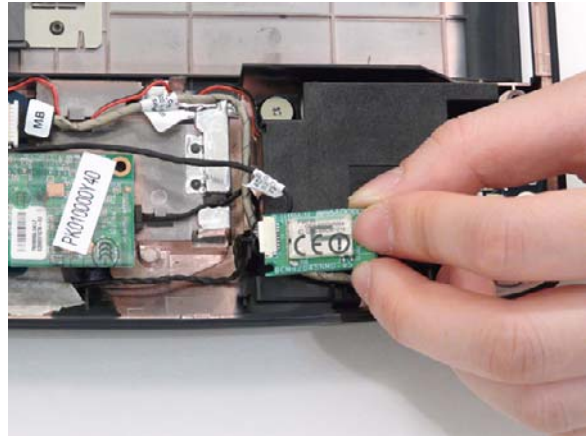
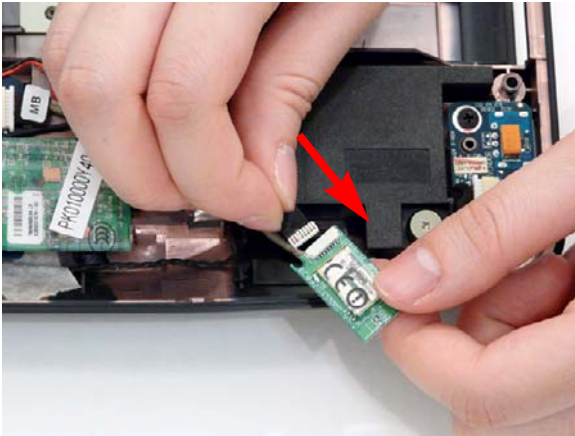

Replacing the TV Board

1. Angle the TV board into the lower base and lower into position.

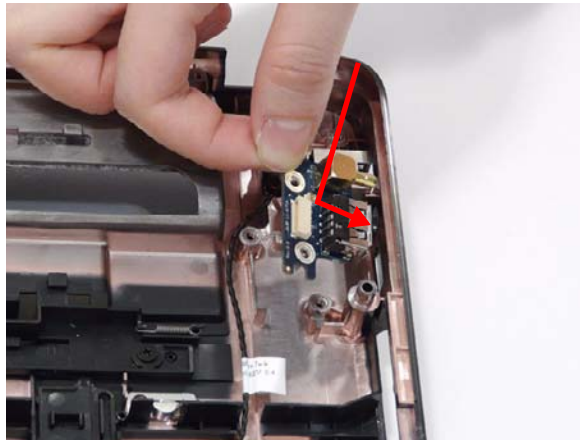

2. Replace the two securing screws on the TV board.

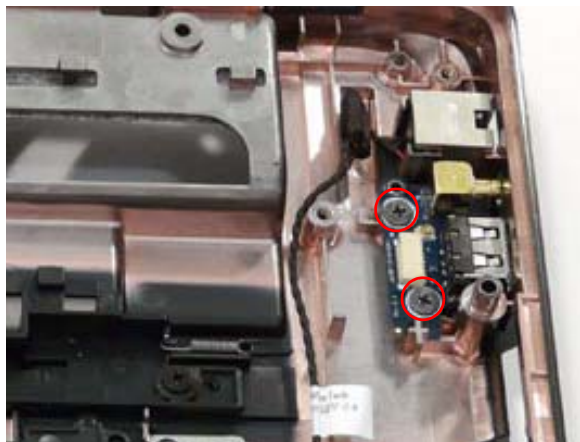

3. Connect the antenna and single cable to the board.

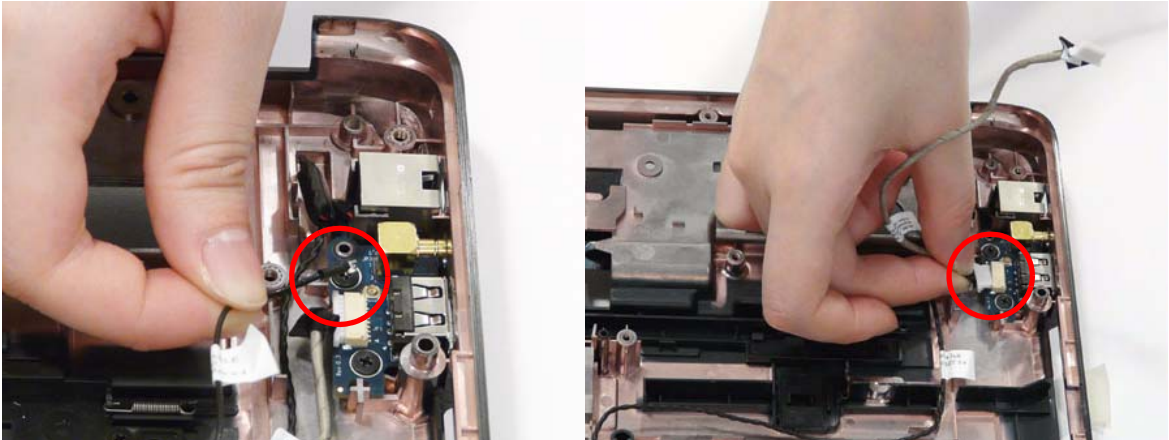

Replacing the Right Speaker Module

1. Replace the speaker module and insert the cable completely through the housing as shown.

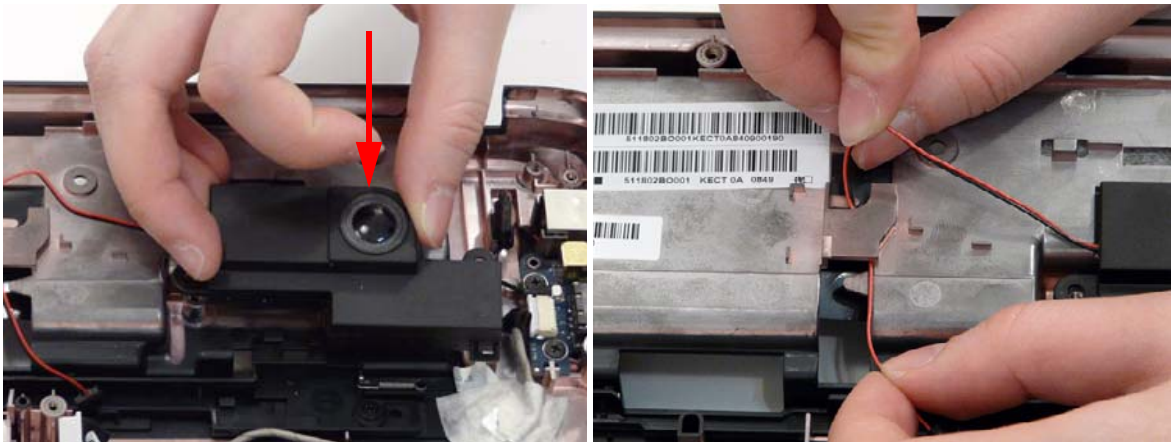

2. Connect the speaker cable to the mainboard.

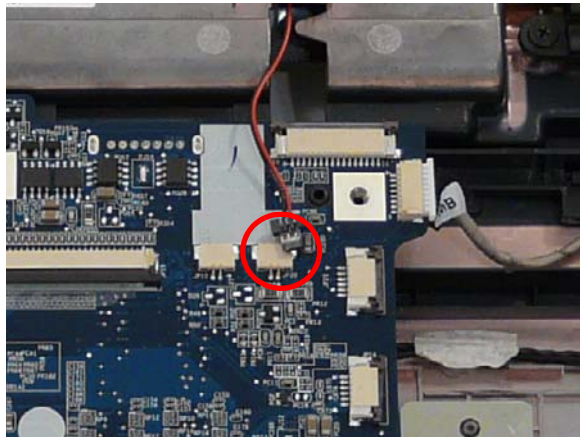

3. Replace the two securing screws on the speaker module.

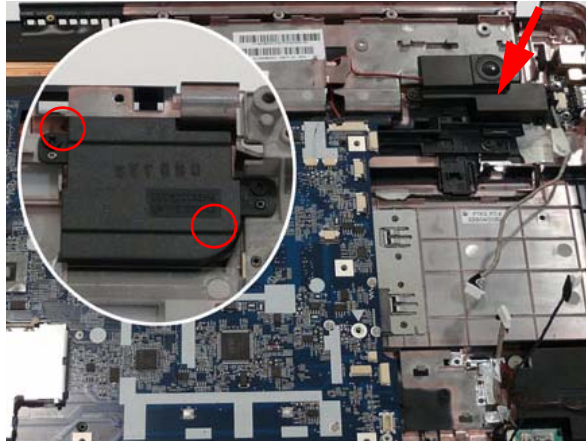

Replacing the Switch Board

1. Position the Switch Board over the screw socket.
2. Replace the single securing screw.

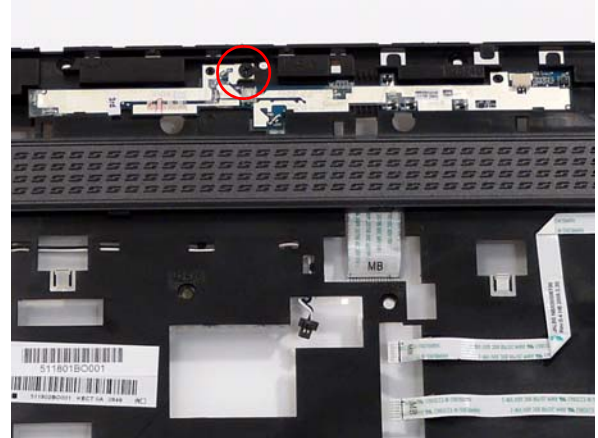
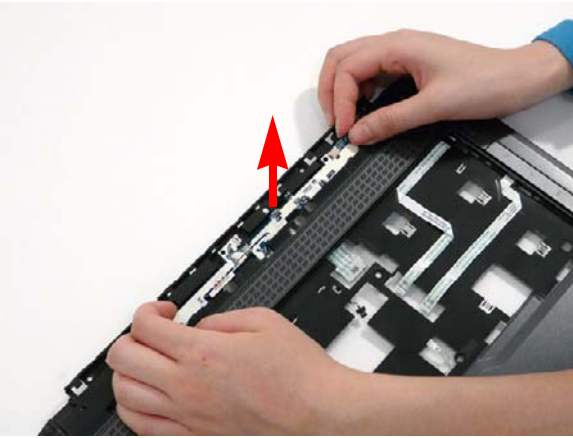

Replacing the eKey Board

1. Insert the FFC through the Upper Cover.



2. Insert the eKey board at an angle and press down to situate.

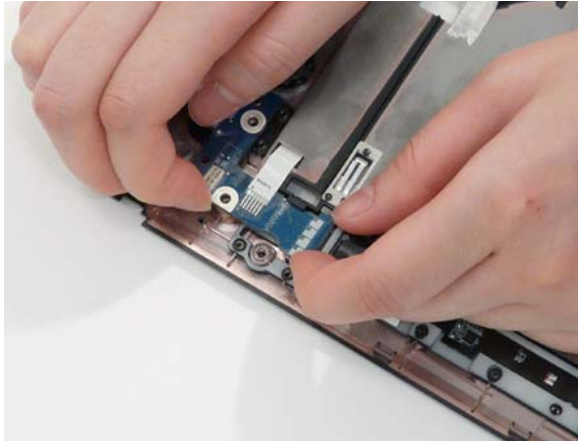

3. Replace the single screw

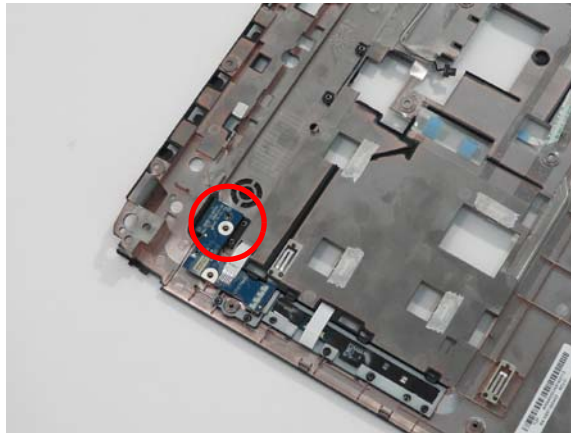

4. Turn the Upper Cover over and press the FFC down to secure in place.

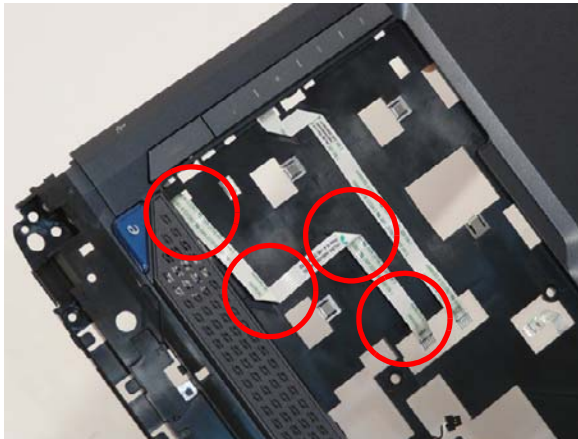

Replacing the Media Board

1. Insert the Media Board into the lower cover. If necessary, use a pry to press the board in place.

IMPORTANT: Do not press on components to prevent damage.

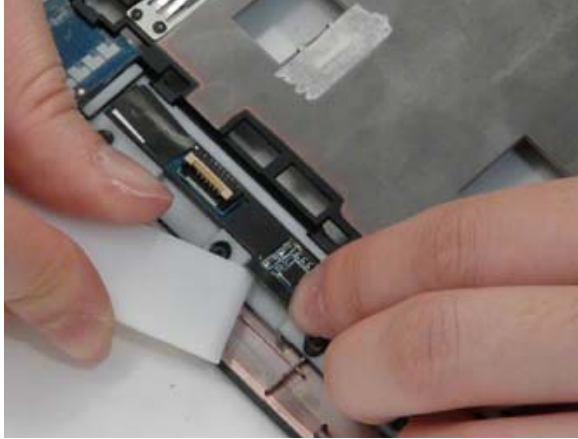

2. Insert the FFC flush with the connector and press the locking lever down to secure.

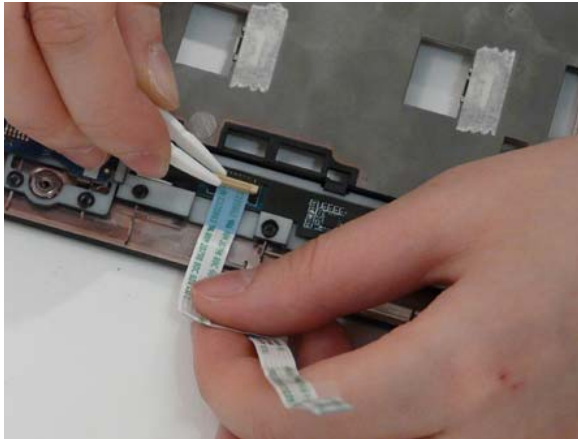

3. Insert the FFC through the chassis.

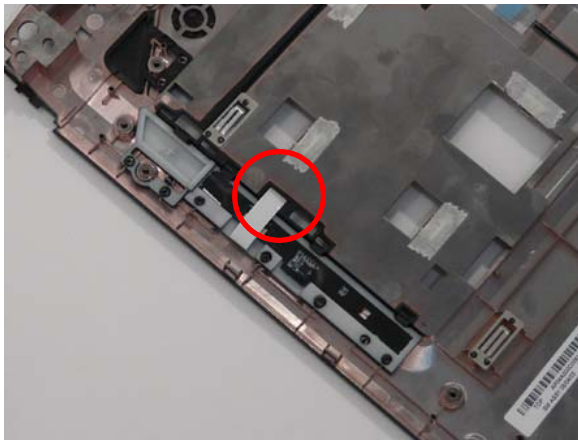

Replacing the Upper Right Saddle

1. Insert the left edge into position and pivot the upper saddle in place.

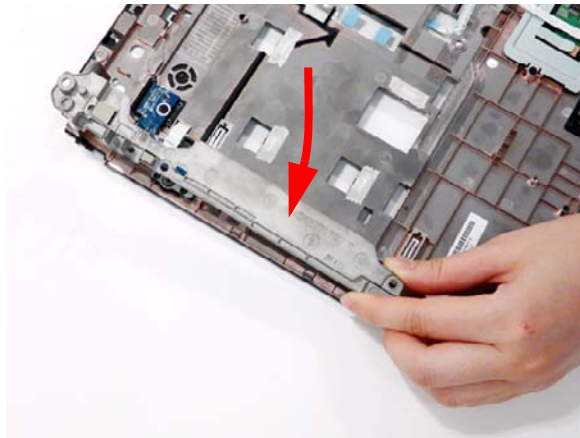

2. Replace the two securing screws on the upper saddle.

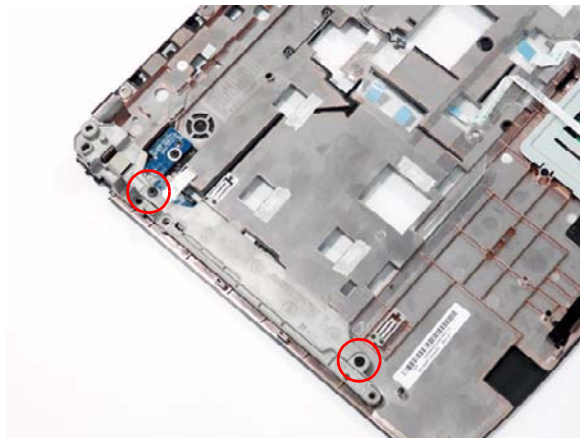

Replacing the Launch Board

1. Insert the left edge of the Launch Board into place and pivot the board down in place.
2. Insert the saddle in place, taking care to locate it over the alignment pins.

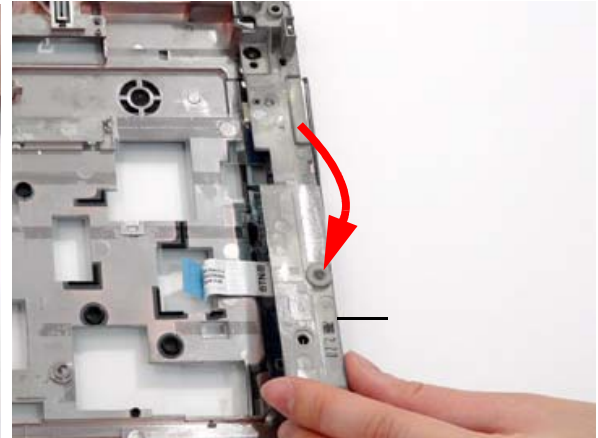
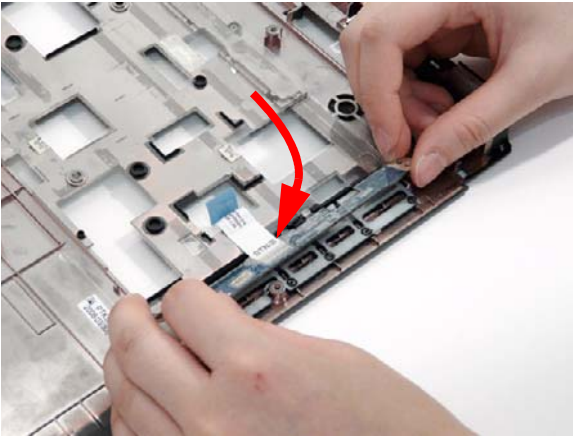

3. Replace the two securing screws.

4. Replace the mylar cover to secure the saddle.

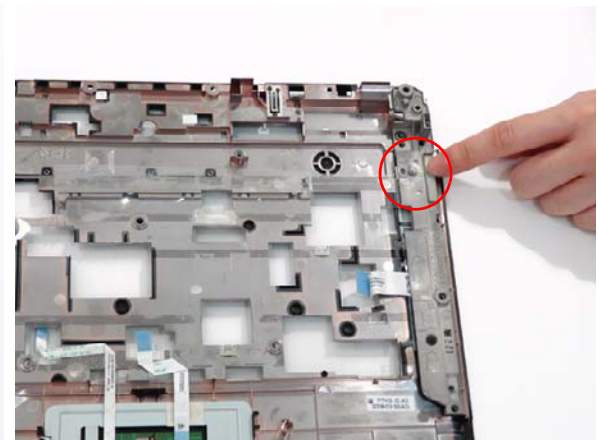

Replacing the Finger Print Reader

1. Replace the Finger Print Reader board in the upper cover.

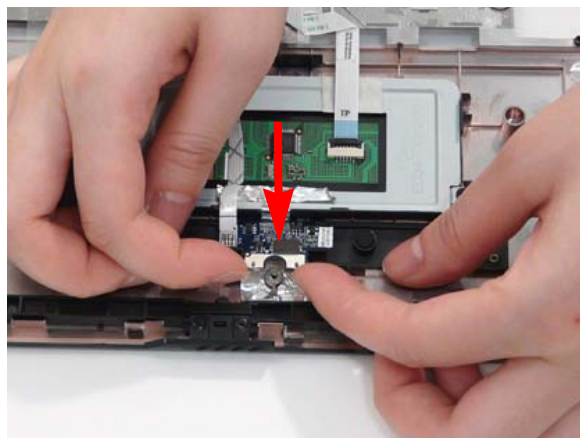

2. Replace the bracket as shown.

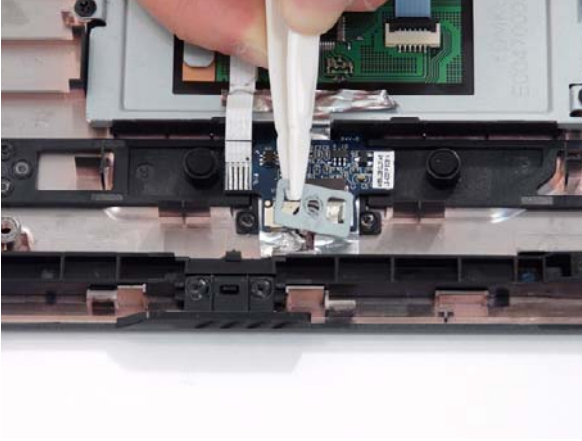

3. Replace the single securing screw.

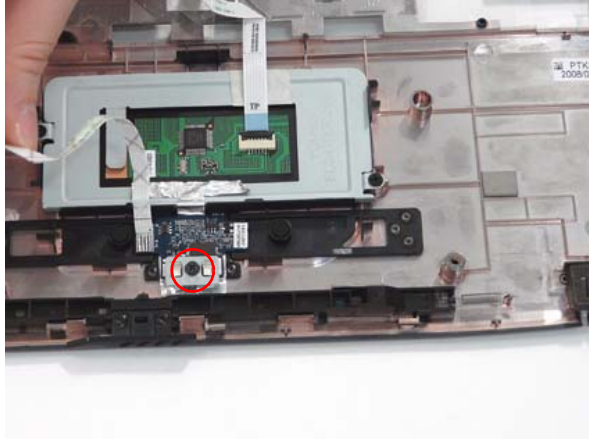

Replacing the Touch Pad Bracket

IMPORTANT: The Touch Pad cannot be removed individually. To replace the Touch Pad, replace the entire Upper Cover.

1. Replace the Touch Pad bracket.

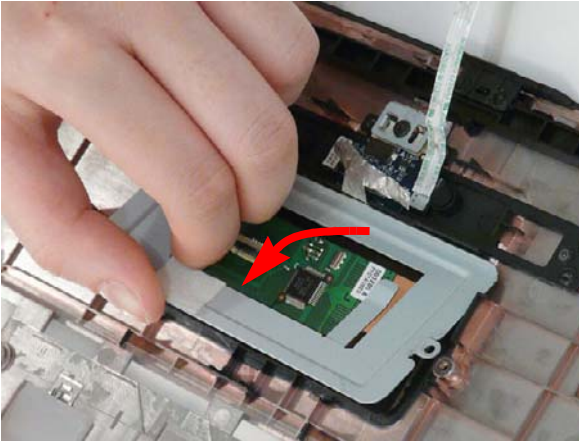

2. Replace the two securing screws from the Touch Pad bracket.

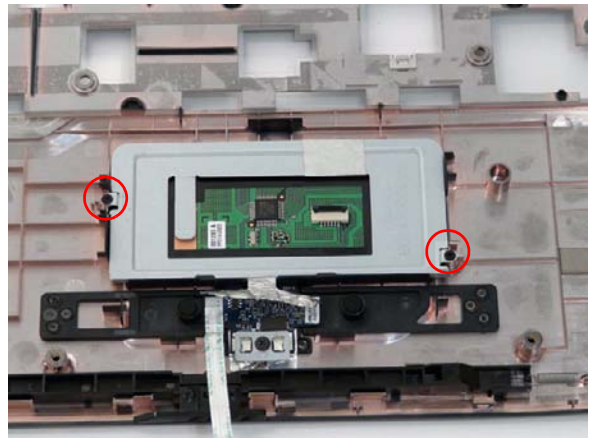

3. Replace the Finger Print reader FFC and secure with the adhesive strips.

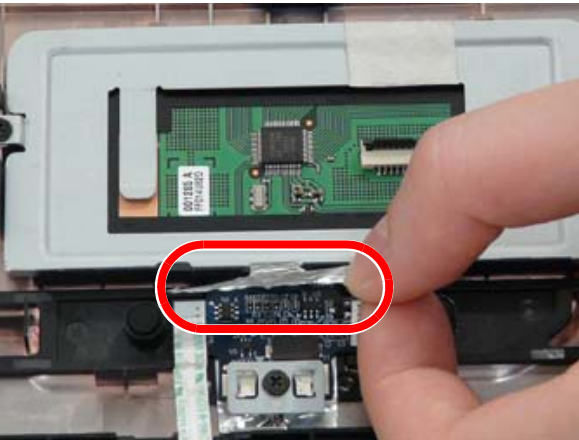

4. Replace the Touch Pad FFC as shown.

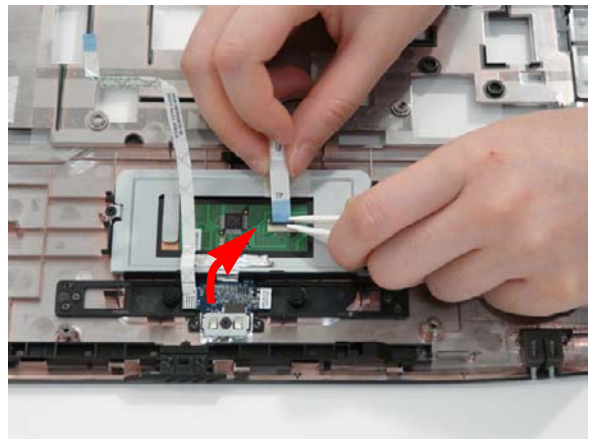

Replacing the Left Speaker Module

1. Align and replace the Speaker Module in the upper case.
2. Grasp both ends of the mylar cover to expose the housing.
3. Replace the speaker cable as shown.

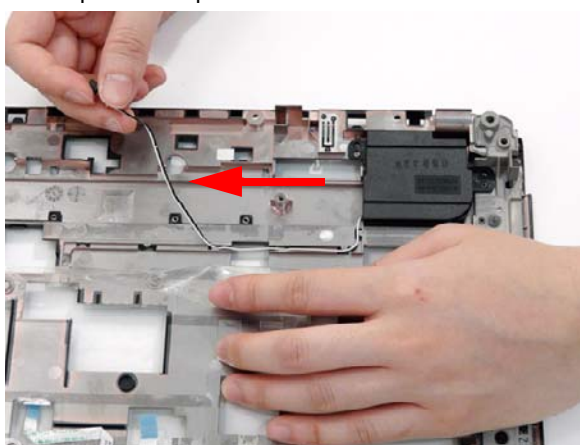
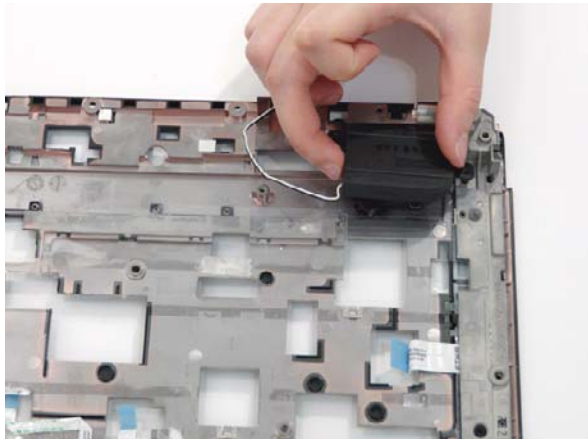

4. While holding the mylar cover back with one hand, replace the speaker cable in its housing.
5. Replace the mylar cover to secure the cable.
6. Replace the two securing screws on the left speaker.

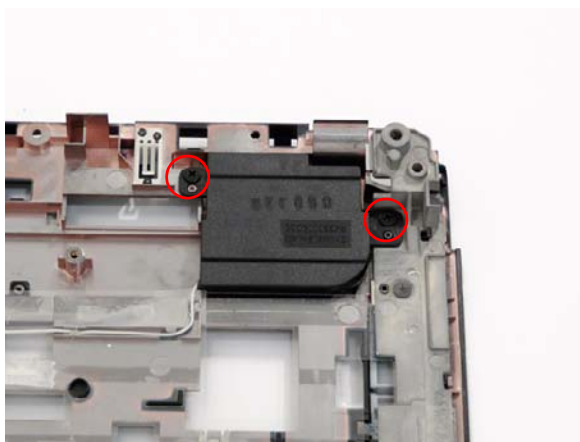
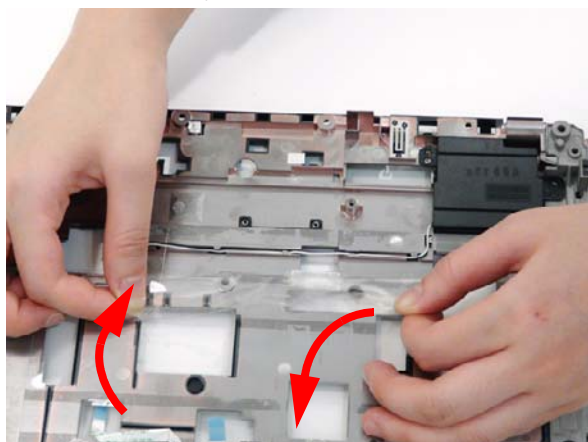

Replacing the Upper Cover

1. Starting with the rear, align the upper cover with the lower cover, taking care to not force in place.



2. Connect the seven cables on the mainboard as shown.

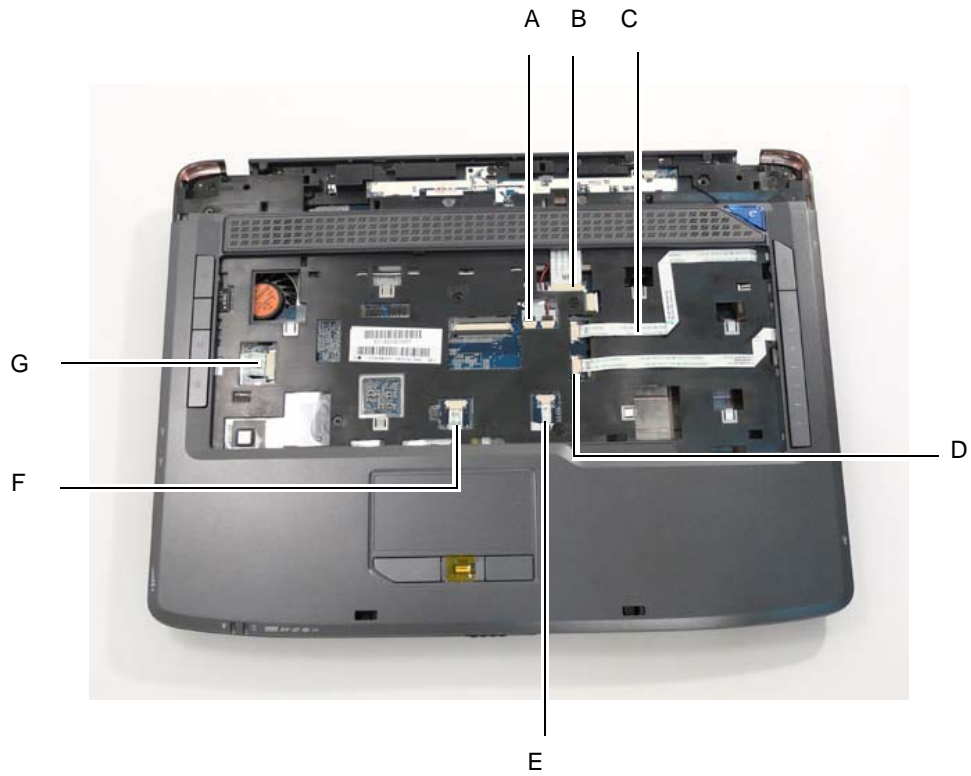

3. Replace the five screws on the top panel.



4. Turn the computer over. Replace the nine screws on the bottom panel.

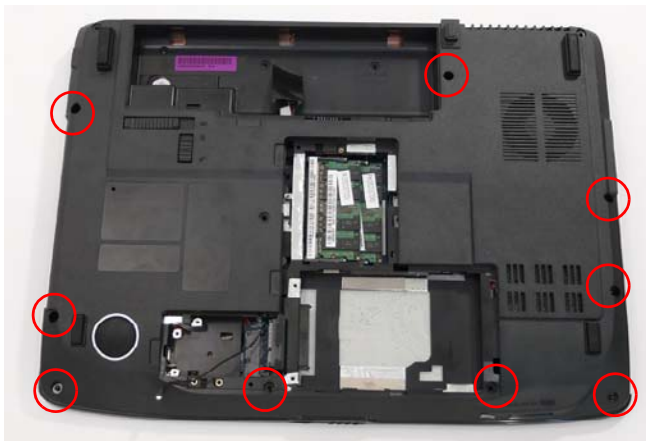

Replacing the LCD Module

1. Carefully align the LCD module over the hinge sockets and lower the module into the chassis.



2. Replace the four securing screws (two on each side) securing the LCD module.

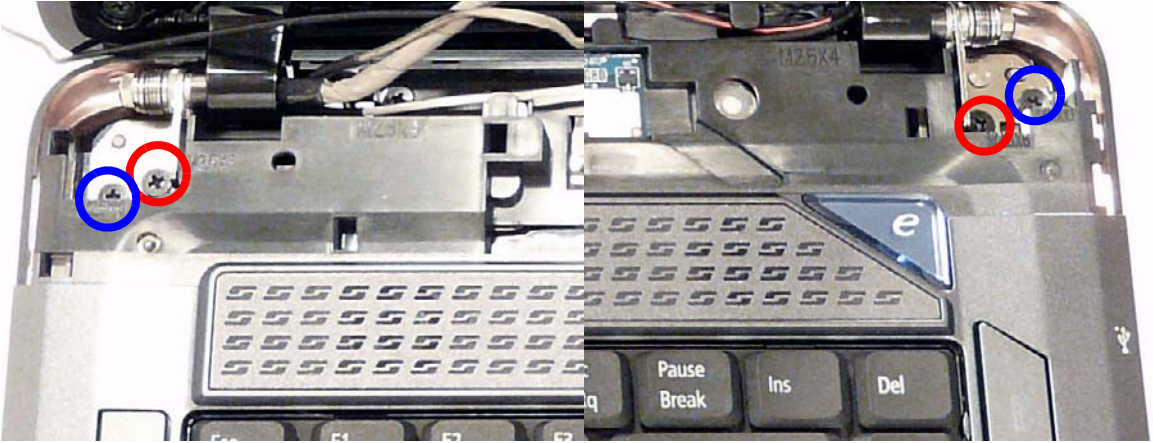

3. Connect the LCD, MIC and back light cables.

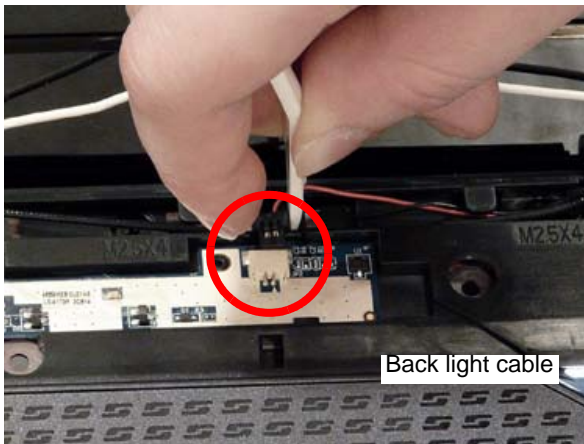
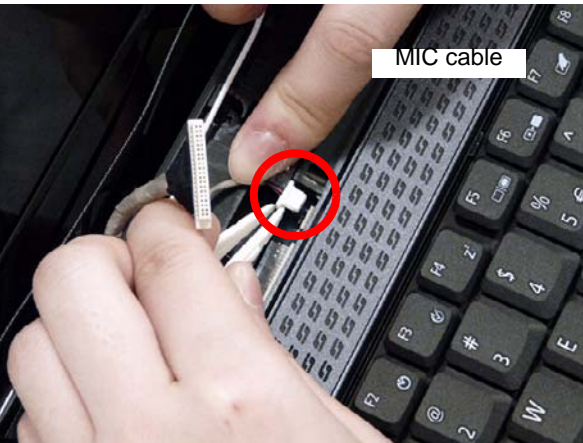
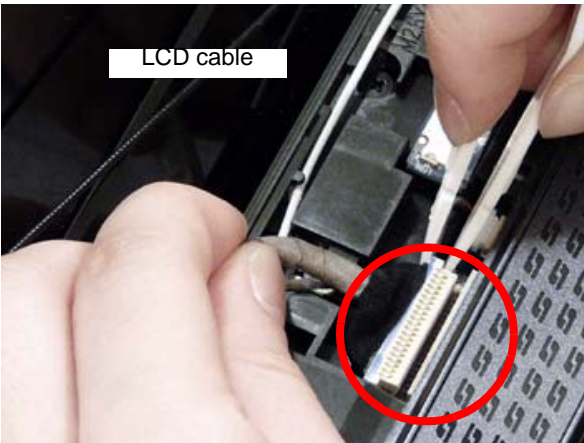

4. Turn the computer over and replace the two securing screws on the bottom of the chassis.

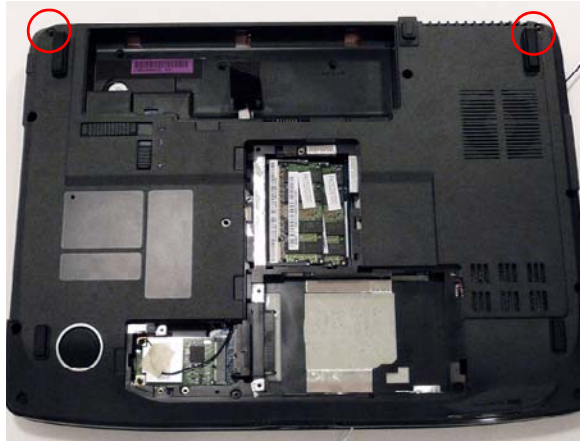

Replacing the Antenna Cables

Ensure that the three Antenna cables pass through the Mainboard and are accessible from the underside of lower cover.

1. Insert the Antenna Cables through the Upper Cover. Make sure they are accessible from the underside.
2. Pull the cables through.

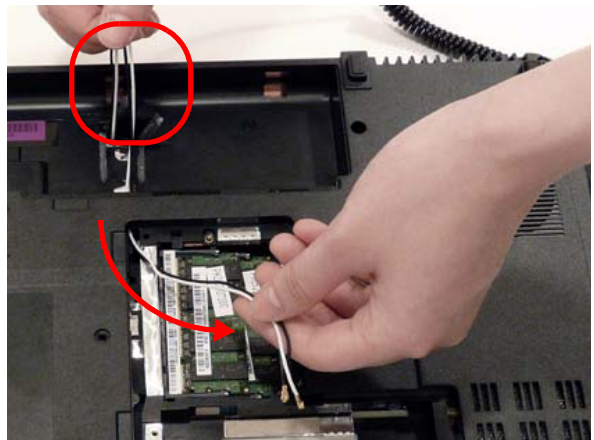

3. Secure the cables in place as shown.
4. Place the cabling in the wiring conduit as shown.

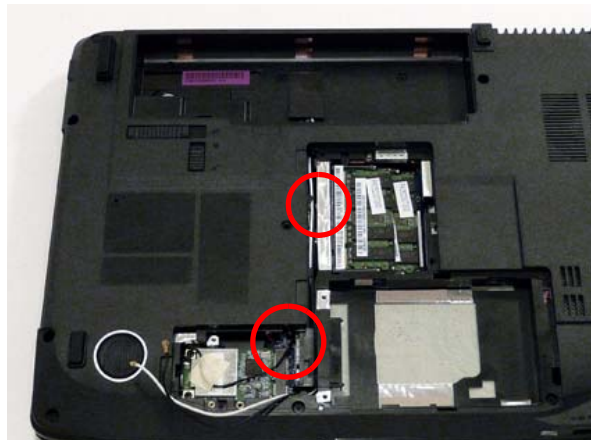
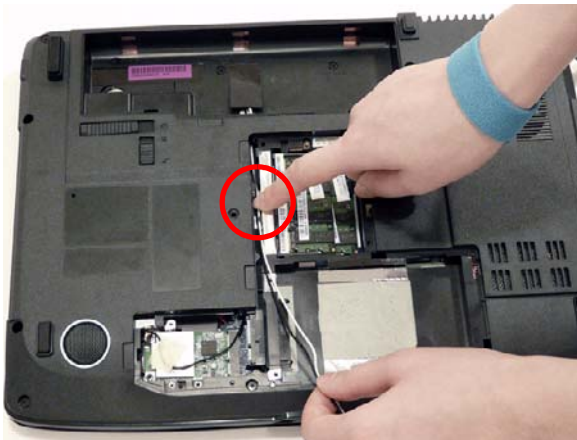

Replacing the Keyboard

1. Align the FFC with the connector and press the latch down to secure.
2. Turn the keyboard over and press down to secure.



Replacing the Switch Cover

1. Insert the left side of the switch cover and angle down in place.
2. Starting from the left, press down on the Switch Cover to secure.



3. Turn the computer over and replace the three securing screws.

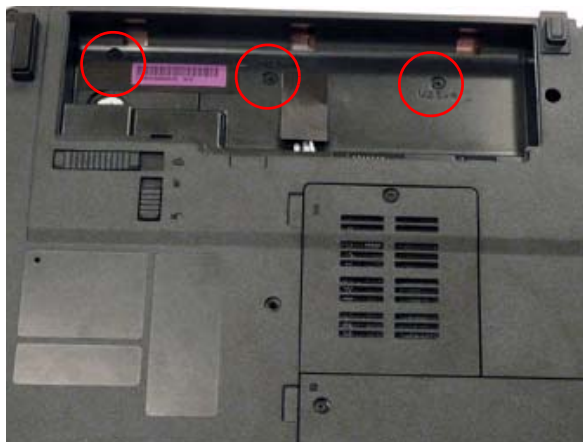

Replacing the TV Tuner Module

4. Replace the tv tuner module.

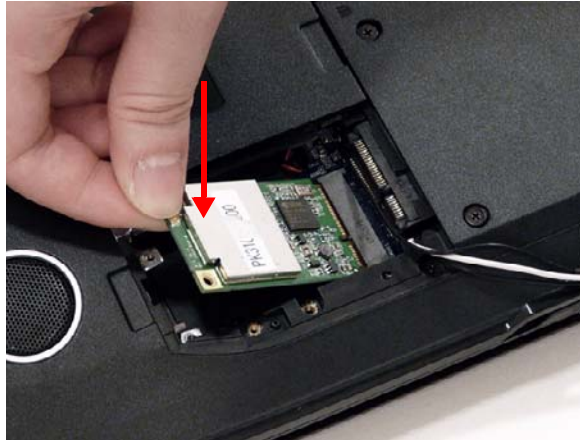

5. Replace the two securing screws.

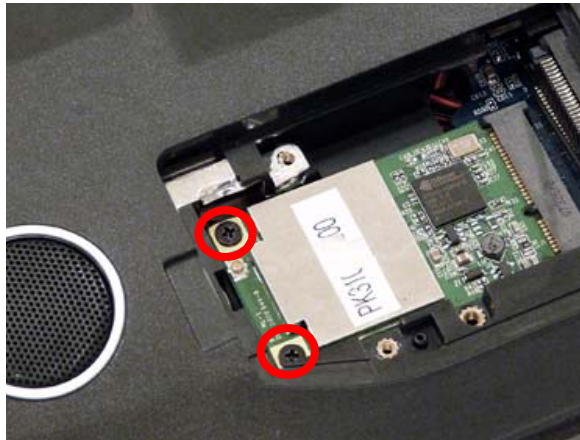

6. Connect the cable to the TV tuner module.

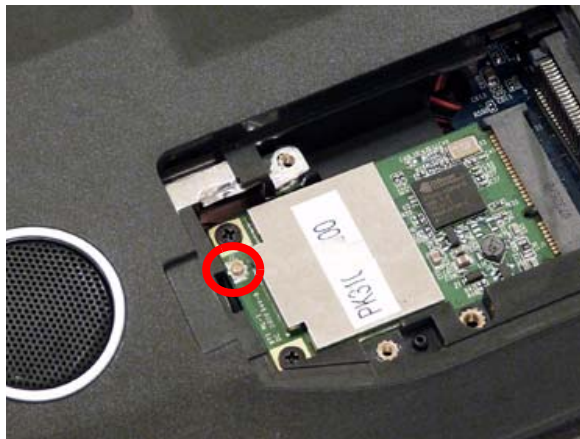

7. Replace the adhesive strip to secure the cable.



8. Replace bracket and secure with provided screw.

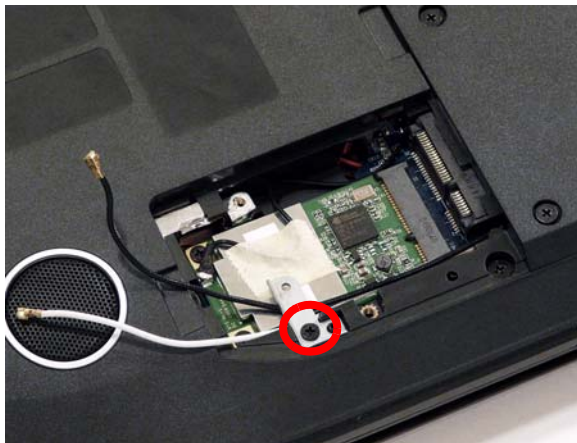

Replacing the WLAN Module

1. Insert the WLAN board into the WLAN socket.
2. Replace the two screws to secure the module.

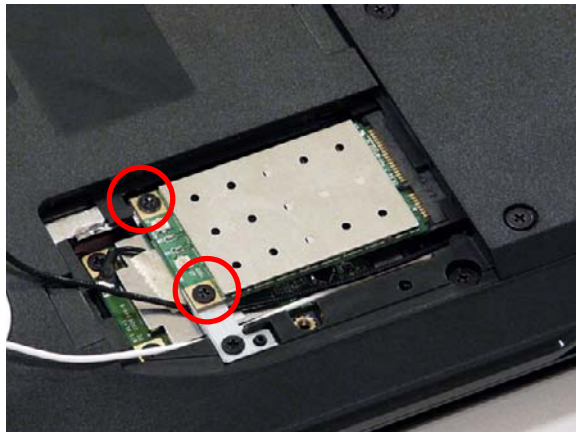

3. Connect the two antenna cables to the module.

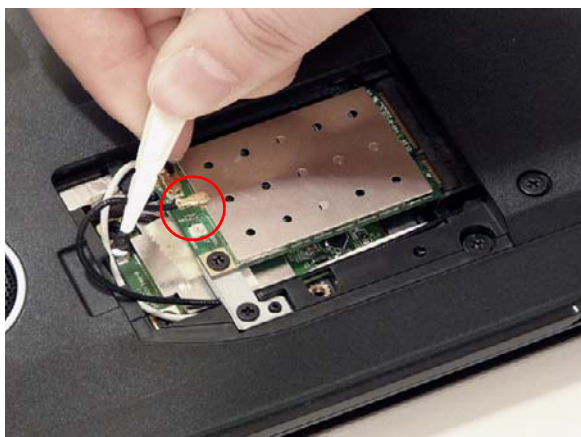

Replacing the Hard Disk Drive Module

1. Place the HDD in the HDD carrier.
2. Replace the four screws to secure the carrier.

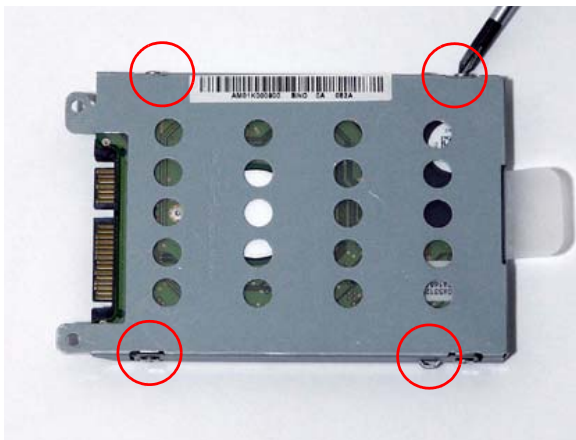
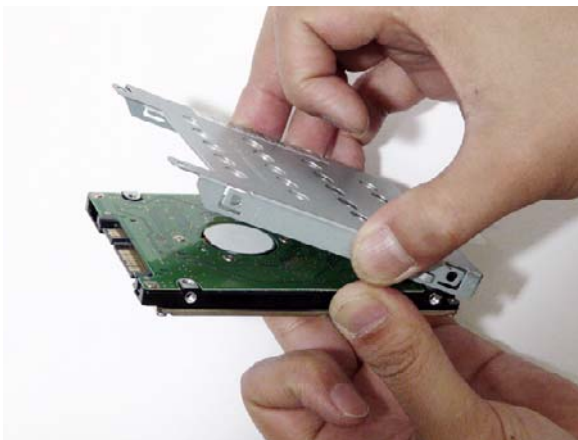

3. Insert the HDD, interface side first, until HDD firmly slides in place.

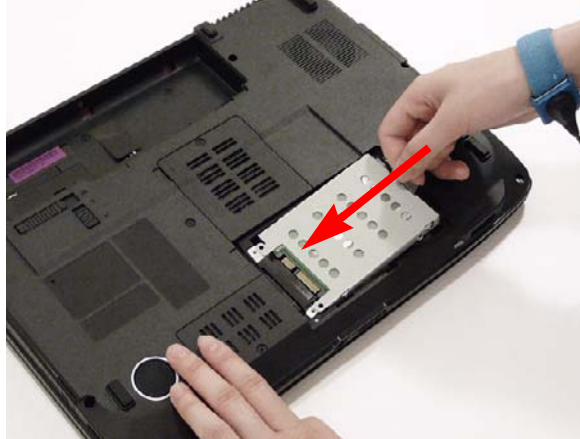

Replacing the DIMM Modules

NOTE: To replace DIMM Module 2, first remove DIMM Module 1. In this procedure, only DIMM Module 1 is shown.

1. Insert the DIMM Module flush with the connector and press down to lock in place.

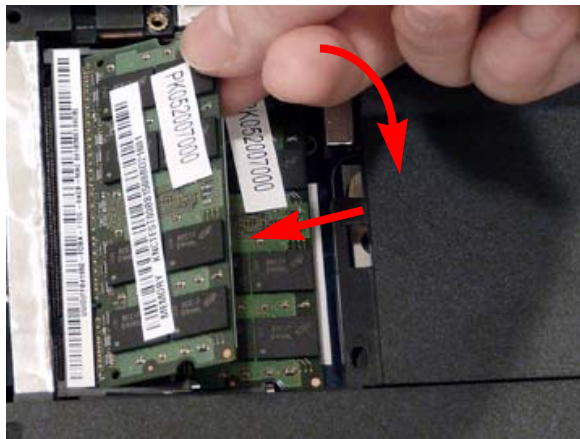

Replacing the ODD Module

1. With the ODD tray in the eject position, replace the ODD cover on the new ODD Module.
2. Press the cover into the tray, bottom edge first, to secure.

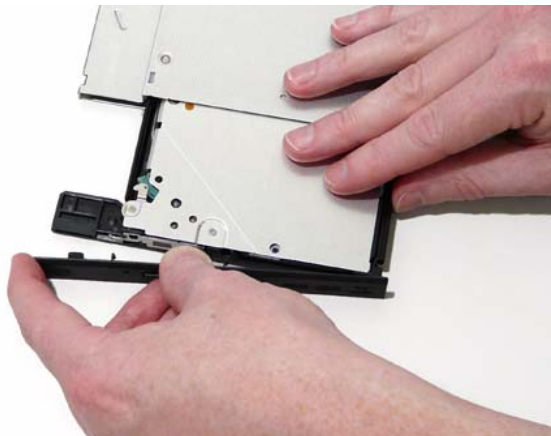
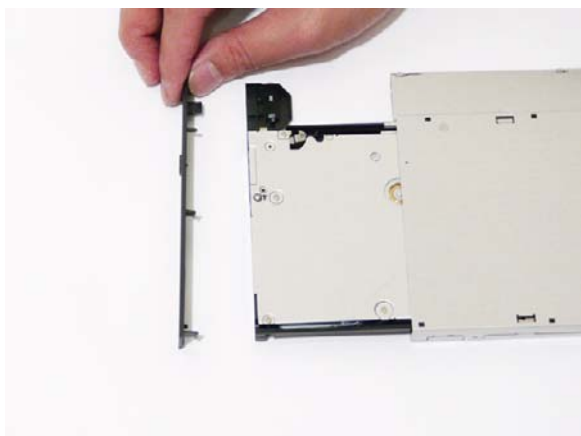

3. Turn the ODD over and replace the three securing screws.
4. Slide Module in chassis and press until Module is flush with chassis.

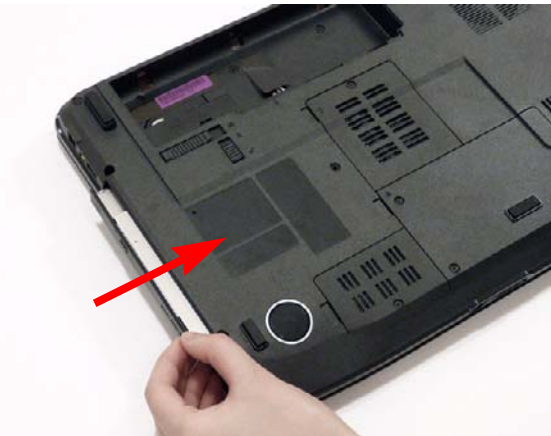

5. Replace the single screw to secure the Module.

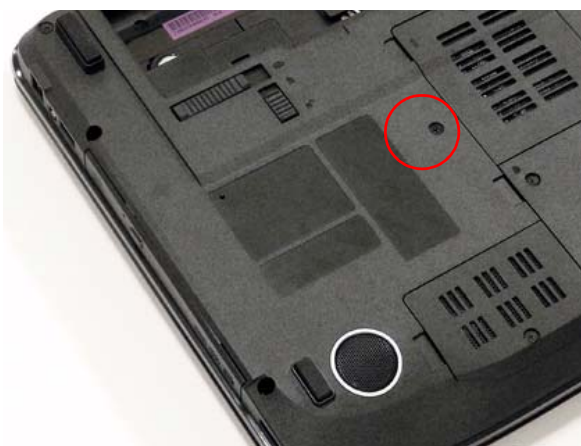

Replacing the Lower Covers

1. Replace the Memory Cover.

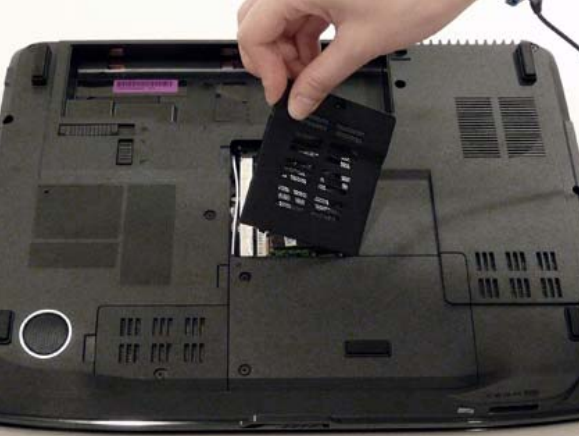

2. Replace the single screw to secure in place.



3. Replace the WLAN Cover.



4. Replace the screw to secure in place.

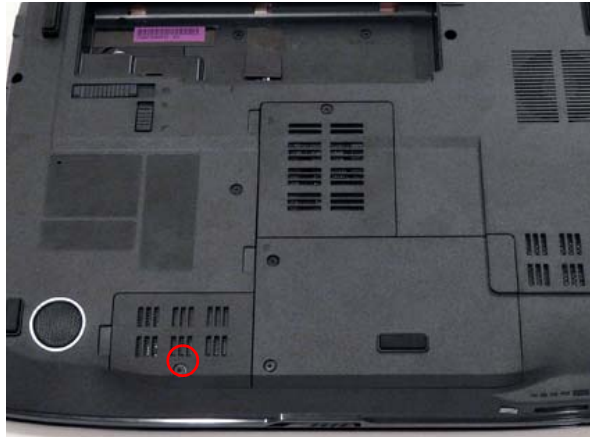

5. Replace HDD Cover.



6. Replace the two screws to secure in place.

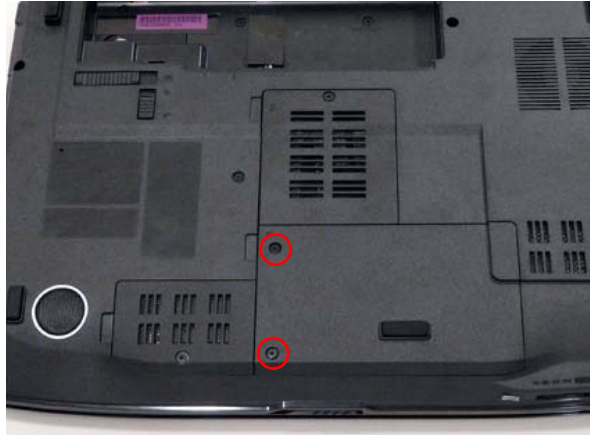

Replacing the Express and SD Card Trays

1. Insert the Express Card and push into the slot until flush with the chassis cover.
2. Insert the SD Card and push into the slot until flush with the chassis cover.



Troubleshooting

Common Problems

Use the following procedure as a guide for computer problems.

NOTE: The diagnostic tests are intended to test only Acer products. Non-Acer products, prototype cards, or modified options can give false errors and invalid system responses.

1. Obtain the failing symptoms in as much detail as possible.
2. Verify the symptoms by attempting to re-create the failure by running the diagnostic test or by repeating the same operation.
3. Use the following table with the verified symptom to determine which page to go to.

Symptoms (Verified)	Go To
Power On Issue	Page 144
No Display Issue	Page 145
LCD Failure	Page 147
Internal Keyboard Failure	Page 147
Touchpad Failure	Page 148
Internal Speaker Failure	Page 148
Internal Microphone Failure	Page 150
ODD Failure	Page 152
Rightside USB Failure	Page 155
Modem Failure	Page 155
WLAN Failure	Page 156
Acer EasyLaunch Button Failure	Page 156
Acer MediaTouch Failure	Page 157
Fingerprint Reader Failure	Page 157
Thermal Unit Failure	Page 158
HDTV Switch Failure	Page 158
Other Functions Failure	Page 159
Intermittent Failures	Page 160
Undermined Failures	Page 160

4. If the Issue is still not resolved, see "Online Support Information" on page 193.

Power On Issue

If the system doesn't power on, perform the following actions one at a time to correct the problem. Do not replace a non-defective FRUs:

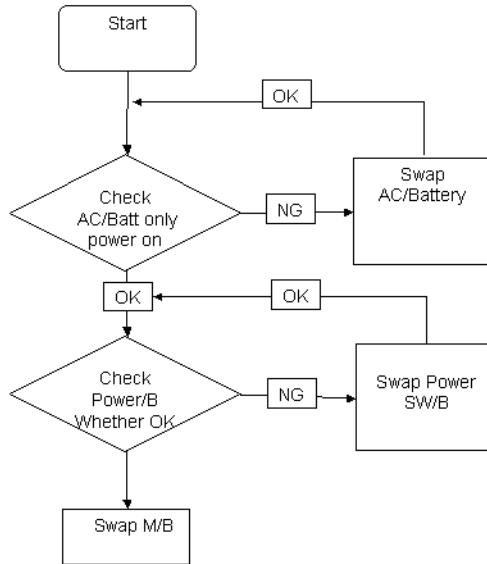

Computer Shutdown Intermittently

If the system powers off at intervals, perform the following actions one at a time to correct the problem.

1. Check the power cable is properly connected to the computer and the electrical outlet.
2. Remove any extension cables between the computer and the outlet.
3. Remove any surge protectors between the computer and the electrical outlet. Plug the computer directly into a known good electrical outlet.
4. Disconnect the power and open the casing to check the Thermal Unit (see "Thermal Unit Failure" on page 158) and fan airways are free of obstructions.
5. Disable the power management settings in the BIOS to ensure they are not the cause of the problem (see "Power" on page 35).
6. Remove all external and non-essential hardware connected to the computer that are not necessary to boot the computer to the failure point.
7. Remove any recently installed software.
8. If the Issue is still not resolved, see "Online Support Information" on page 193.

No Display Issue

If the **Display** doesn't work, perform the following actions one at a time to correct the problem. Do not replace a non-defective FRUs:

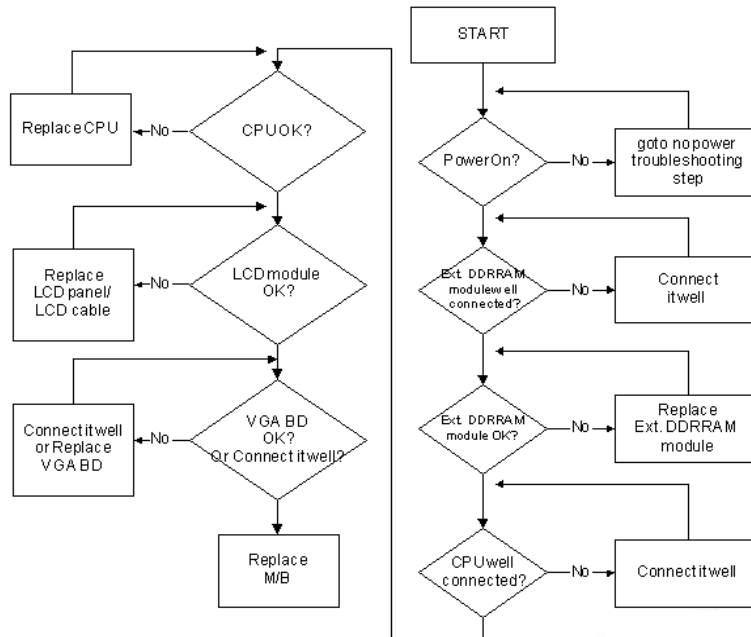

No POST or Video

If the POST or video doesn't display, perform the following actions one at a time to correct the problem.

1. Make sure that the internal display is selected. On this notebook model, switching between the internal display and the external display is done by pressing **Fn+F5**. Reference Product pages for specific model procedures.
2. Make sure the computer has power by checking at least one of the following occurs:
 - Fans start up
 - Status LEDs light up

If there is no power, see "Power On Issue" on page 144.

3. Drain any stored power by removing the power cable and battery and holding down the power button for 10 seconds. Reconnect the power and reboot the computer.
4. Connect an external monitor to the computer and switch between the internal display and the external display is by pressing **Fn+F5** (on this model).

If the POST or video appears on the external display, see "LCD Failure" on page 147.

5. Disconnect power and all external devices including port replicators or docking stations. Remove any memory cards and CD/DVD discs. Restart the computer.

If the computer boots correctly, add the devices one by one until the failure point is discovered.

6. Reseat the memory modules.
7. Remove the drives (see "Disassembly Process" on page 48).
8. If the Issue is still not resolved, see "Online Support Information" on page 193.

Abnormal Video Display

If video displays abnormally, perform the following actions one at a time to correct the problem.

1. Reboot the computer.
2. If permanent vertical/horizontal lines or dark spots display in the same location, the LCD is faulty and should be replaced. See “Disassembly Process” on page 48.
3. If extensive pixel damage is present (different colored spots in the same locations on the screen), the LCD is faulty and should be replaced. See “Disassembly Process” on page 48.
4. Adjust the brightness to its highest level. See the User Manual for instructions on adjusting settings.
NOTE: Ensure that the computer is not running on battery alone as this may reduce display brightness.
If the display is too dim at the highest brightness setting, the LCD is faulty and should be replaced. See “Disassembly Process” on page 48.
5. Check the display resolution is correctly configured:
 - a. Minimize or close all Windows.
 - b. If display size is only abnormal in an application, check the view settings and control/mouse wheel zoom feature in the application.
 - c. If desktop display resolution is not normal, right-click on the desktop and select **Personalize**→ **Display Settings**.
 - d. Click and drag the Resolution slider to the desired resolution.
 - e. Click **Apply** and check the display. Readjust if necessary.
6. Roll back the video driver to the previous version if updated.
7. Remove and reinstall the video driver.
8. Check the Device Manager to determine that:
 - The device is properly installed. There are no red Xs or yellow exclamation marks.
 - There are no device conflicts.
 - No hardware is listed under Other Devices.
9. If the Issue is still not resolved, see “Online Support Information” on page 193.
10. Run the Windows Memory Diagnostic from the operating system DVD and follow the onscreen prompts.
11. If the Issue is still not resolved, see “Online Support Information” on page 193.

Random Loss of BIOS Settings

If the computer is experiencing intermittent loss of BIOS information, perform the following actions one at a time to correct the problem.

1. If the computer is more than one year old, replace the CMOS battery.
2. Run a complete virus scan using up-to-date software to ensure the computer is virus free.
3. If the computer is experiencing HDD or ODD BIOS information loss, disconnect and reconnect the power and data cables between devices.
If the BIOS settings are still lost, replace the cables.
4. If HDD information is missing from the BIOS, the drive may be defective and should be replaced.
5. Replace the Motherboard.
6. If the Issue is still not resolved, see “Online Support Information” on page 193.

LCD Failure

If the **LCD** fails, perform the following actions one at a time to correct the problem. Do not replace a non-defective FRUs:

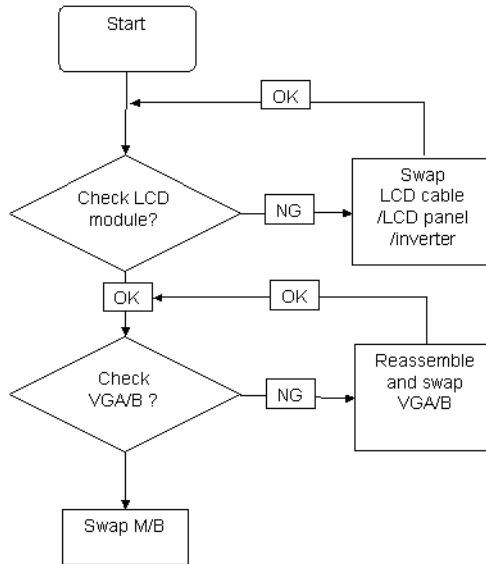

Built-In Keyboard Failure

If the built-in **Keyboard** fails, perform the following actions one at a time to correct the problem. Do not replace a non-defective FRUs:

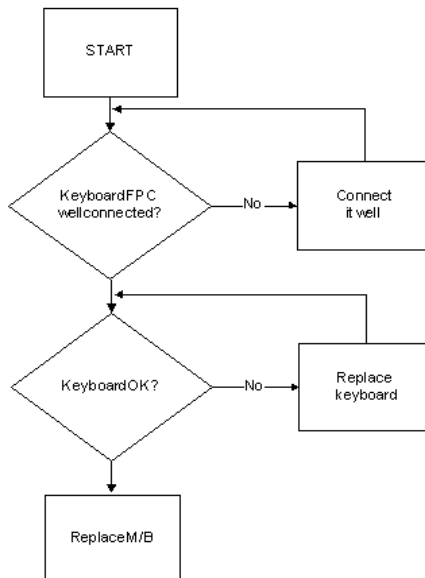

Touchpad Failure

If the **Touchpad** doesn't work, perform the following actions one at a time to correct the problem. Do not replace a non-defective FRUs:

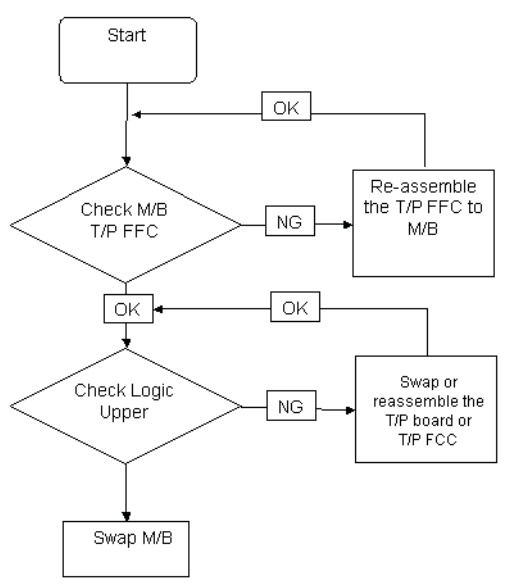

Internal Speaker Failure

If the internal **Speakers** fail, perform the following actions one at a time to correct the problem. Do not replace a non-defective FRUs:

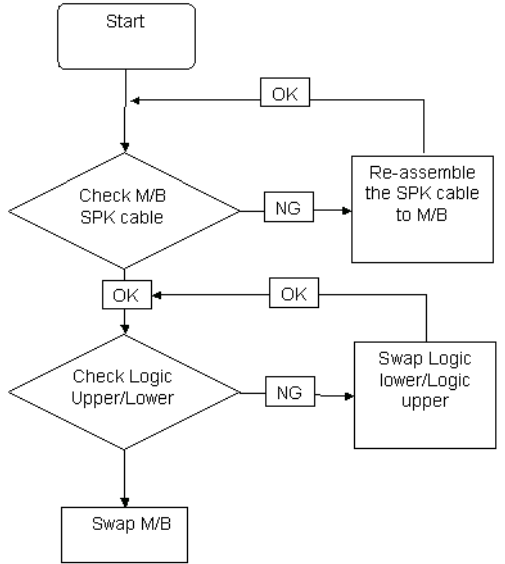

Sound Problems

If sound problems are experienced, perform the following actions one at a time to correct the problem.

1. Reboot the computer.
2. Navigate to **Start** → **Control Panel** → **System and Maintenance** → **System** → **Device Manager**. Check the Device Manager to determine that:
 - The device is properly installed.
 - There are no red Xs or yellow exclamation marks.
 - There are no device conflicts.
 - No hardware is listed under Other Devices.
3. Roll back the audio driver to the previous version, if updated recently.
4. Remove and reinstall the audio driver.
5. Ensure that all volume controls are set mid range:
 - a. Click the volume icon on the taskbar and drag the slider to 50. Ensure that the volume is not muted.
 - b. Click Mixer to verify that other audio applications are set to 50 and not muted.
6. Navigate to **Start** → **Control Panel** → **Hardware and Sound** → **Sound**. Ensure that Speakers are selected as the default audio device (green check mark).

NOTE: If Speakers does not show, right-click on the **Playback** tab and select **Show Disabled Devices** (clear by default).
7. Select Speakers and click **Configure** to start **Speaker Setup**. Follow the onscreen prompts to configure the speakers.
8. Remove and recently installed hardware or software.
9. Restore system and file settings from a known good date using **System Restore**.

If the issue is not fixed, repeat the preceding steps and select an earlier time and date.
10. Reinstall the Operating System.
11. If the Issue is still not resolved, see “Online Support Information” on page 193.

Internal Microphone Failure

If the internal **Microphone** fails, perform the following actions one at a time to correct the problem. Do not replace a non-defective FRUs:

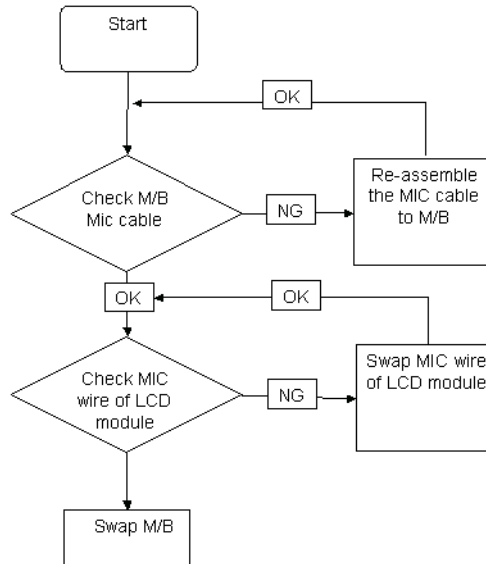

Microphone Problems

If internal or external **Microphones** do not operate correctly, perform the following actions one at a time to correct the problem.

1. Check that the microphone is enabled. Navigate to **Start** → **Control Panel** → **Hardware and Sound** → **Sound** and select the **Recording** tab.
2. Right-click on the **Recording** tab and select **Show Disabled Devices** (clear by default).
3. The microphone appears on the **Recording** tab.
4. Right-click on the microphone and select **Enable**.
5. Select the microphone then click **Properties**. Select the **Levels** tab.
6. Increase the volume to the maximum setting and click **OK**.
7. Test the microphone hardware:
 - a. Select the microphone and click **Configure**.
 - b. Select **Set up microphone**.
 - c. Select the microphone type from the list and click **Next**.
 - d. Follow the onscreen prompts to complete the test.
8. If the Issue is still not resolved, see "Online Support Information" on page 193.

HDD Not Operating Correctly

If the **HDD** does not operate correctly, perform the following actions one at a time to correct the problem.

1. Disconnect all external devices.
2. Run a complete virus scan using up-to-date software to ensure the computer is virus free.
3. Run the Windows Vista Startup Repair Utility:
 - a. insert the Windows Vista Operating System DVD in the ODD and restart the computer.
 - b. When prompted, press any key to start to the operating system DVD.
 - c. The **Install Windows** screen displays. Click **Next**.
 - d. Select **Repair your computer**.
 - e. The **System Recovery Options** screen displays. Click **Next**.
 - f. Select the appropriate operating system, and click **Next**.

NOTE: Click **Load Drivers** if controller drives are required.

- g. Select **Startup Repair**.
- h. Startup Repair attempts to locate and resolve issues with the computer.
- i. When complete, click **Finish**.

If an issue is discovered, follow the onscreen information to resolve the problem.

4. Run the Windows Memory Diagnostic Tool. For more information see Windows Help and Support.
5. Restart the computer and press F2 to enter the BIOS Utility. Check the BIOS settings are correct and that CD/DVD drive is set as the first boot device on the Boot menu.
6. Ensure all cables and jumpers on the HDD and ODD are set correctly.
7. Remove any recently added hardware and associated software.
8. Run the Windows Disk Defragmenter. For more information see Windows Help and Support.
9. Run Windows Check Disk by entering **chkdsk /r** from a command prompt. For more information see Windows Help and Support.
10. Restore system and file settings from a known good date using **System Restore**.

If the issue is not fixed, repeat the preceding steps and select an earlier time and date.
11. Replace the HDD. See "Disassembly Process" on page 48.

ODD Failure

If the **ODD** fails, perform the following actions one at a time to correct the problem. Do not replace a non-defective FRUs:

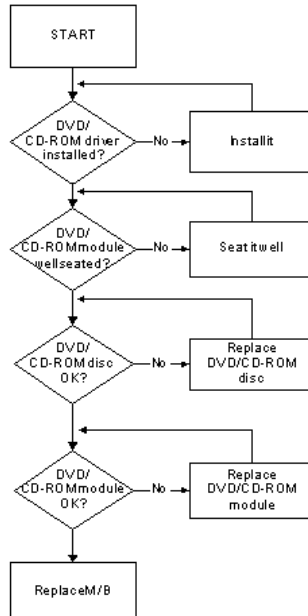

ODD Not Operating Correctly

If the **ODD** exhibits any of the following symptoms it may be faulty:

- Audio CDs do not play when loaded
- DVDs do not play when loaded
- Blank discs do not burn correctly
- DVD or CD play breaks up or jumps
- Optical drive not found or not active:
 - Not shown in My Computer or the BIOS setup
 - LED does not flash when the computer starts up
 - The tray does not eject
- Access failure screen displays
- The ODD is noisy

Perform the following general solutions one at a time to correct the problem.

1. Reboot the computer and retry the operation.
2. Try an alternate disc.
3. Navigate to **Start** → **Computer**. Check that the ODD device is displayed in the **Devices with Removable Storage** panel.
4. Navigate to **Start** → **Control Panel** → **System and Maintenance** → **System** → **Device Manager**.
 - a. Double-click **IDE ATA/ATAPI controllers**. If a device displays a down arrow, right-click on the device and click **Enable**.
 - b. Double-click **DVD/CD-ROM drives**. If the device displays a down arrow, right-click on the device and click **Enable**.

-
- c. Check that there are no yellow exclamation marks against the items in **IDE ATA/ATAPI controllers**. If a device has an exclamation mark, right-click on the device and uninstall and reinstall the driver.
 - d. Check that there are no yellow exclamation marks against the items in **DVD/CD-ROM drives**. If a device has an exclamation mark, right-click on the device and uninstall and reinstall the driver.
 - e. If the exclamation marker is not removed from the item in the lists, try removing any recently installed software and retrying the operation.

Discs Do Not Play

If discs do not play when inserted in the drive, perform the following actions one at a time to correct the problem.

1. Check that the disc is correctly seated in the drive tray and that the label on the disc is visible.
2. Check that the media is clean and scratch free.
3. Try an alternate disc in the drive.
4. Ensure that **AutoPlay** is enabled:
 - a. Navigate to **Start** → **Control Panel** → **Hardware and Sound** → **AutoPlay**.
 - b. Select **Use AutoPlay for all media and devices**.
 - c. In the Audio CD and DVD Movie fields, select the desired player from the drop down menu.
5. Check that the Regional Code is correct for the selected media:

IMPORTANT:Region can only be changed a limited number of times. After Changes remaining reaches zero, the region cannot be changed even Windows is reinstalled or the drive is moved to another computer.

- a. Navigate to **Start** → **Control Panel** → **System and Maintenance** → **System** → **Device Manager**.
- b. Double-click **DVD/CD-ROM drives**.
- c. Right-click **DVD drive** and click **Properties**, then click the **DVD Region** tab.
- d. Select the region suitable for the media inserted in the drive.

Discs Do Not Burn Properly

If discs can not be burned, perform the following actions one at a time to correct the problem.

1. Ensure that the default drive is record enabled:
 - a. Navigate to **Start** → **Computer** and right-click the writable ODD icon. Click **Properties**.
 - b. Select the **Recording** tab. In the **Desktop disc recording** panel, select the writable ODD from the drop down list.
 - c. Click **OK**.
2. Ensure that the software used for burning discs is the factory default. If using different software, refer to the software's user manual.

Playback is Choppy

If playback is choppy or jumps, perform the following actions one at a time to correct the problem.

1. Check that system resources are not running low:
 - a. Try closing some applications.
 - b. Reboot and try the operation again.
2. Check that the ODD controller transfer mode is set to DMA:
 - a. Navigate to **Start** → **Control Panel** → **System and Maintenance** → **System** → **Device Manager**.
 - b. Double-click **IDE ATA/ATAPI controllers**, then right-click ATA Device 0.
 - c. Click **Properties** and select the **Advanced Settings** tab. Ensure that the **Enable DMA** box is checked and click **OK**.

-
- d. Repeat for the other ATA Devices shown if applicable.

Drive Not Detected

If Windows cannot detect the drive, perform the following actions one at a time to correct the problem.

1. Restart the computer and press F2 to enter the BIOS Utility.
2. Check that the drive is detected in the **ATAPI Model Name** field on the Information page.
NOTE: Check that the entry is identical to one of the ODDs specified in “Hardware Specifications and Configurations” on page 18.
3. Turn off the power and remove the cover to inspect the connections to the ODD. See “Disassembly Process” on page 48.
 - a. Check for broken connectors on the drive, motherboard, and cables.
 - b. Check for bent or broken pins on the drive, motherboard, and cable connections.
 - c. Try an alternate cable, if available. If the drive works with the new cable, the original cable should be replaced.
4. Reseat the drive ensuring and all cables are connected correctly.
5. Replace the ODD. See “Disassembly Process” on page 48.

Drive Read Failure

If discs cannot be read when inserted in the drive, perform the following actions one at a time to correct the problem.

1. Remove and clean the failed disc.
2. Retry reading the CD or DVD.
 - d. Test the drive using other discs.
 - e. Play a DVD movie
 - f. Listen to a music CD

If the ODD works properly with alternate discs, the original disc is probably defective and should be replaced.

3. Turn off the power and remove the cover to inspect the connections to the ODD. See “Disassembly Process” on page 48.
 - a. Check for broken connectors on the drive, motherboard, and cables.
 - b. Check for bent or broken pins on the drive, motherboard, and cable connections.
 - c. Try an alternate cable, if available. If the drive works with the new cable, the original cable should be replaced.
4. Replace the ODD. See “Disassembly Process” on page 48.

USB Failure (Rightside)

If the rightside **USB** port fails, perform the following actions one at a time to correct the problem. Do not replace a non-defective FRUs:

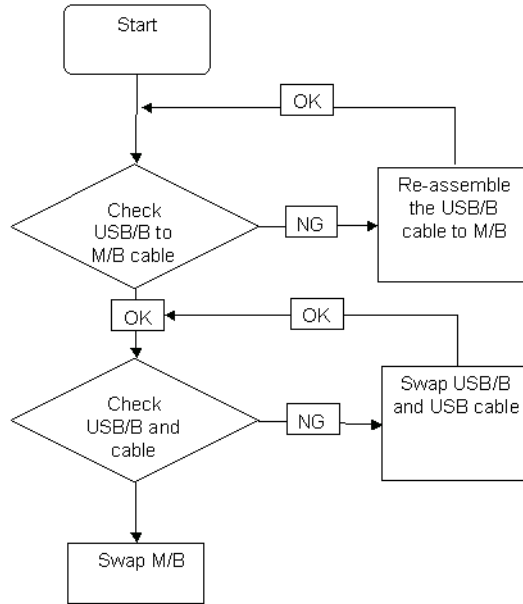

Modem Function Failure

If the internal **Modem** fails, perform the following actions one at a time to correct the problem. Do not replace a non-defective FRUs:

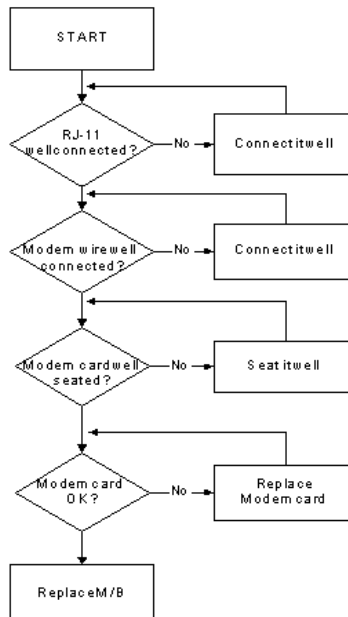

Wireless Function Failure

If the **WLAN** fails, perform the following actions one at a time to correct the problem. Do not replace a non-defective FRUs:

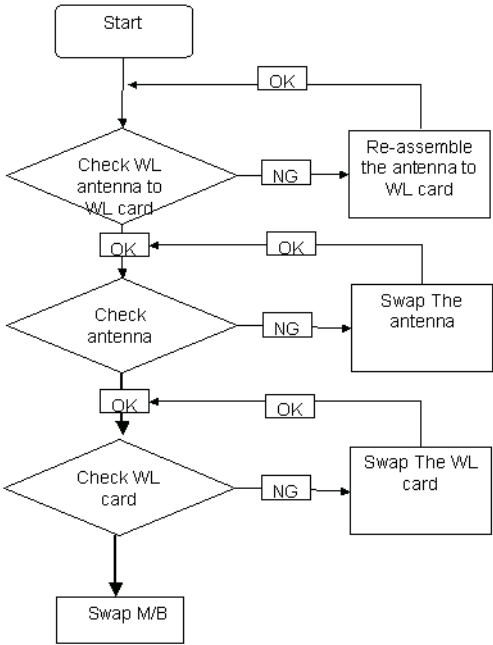

EasyTouch Button Failure

If the **Acer EasyTouch** buttons fail, perform the following actions one at a time to correct the problem. Do not replace a non-defective FRUs:

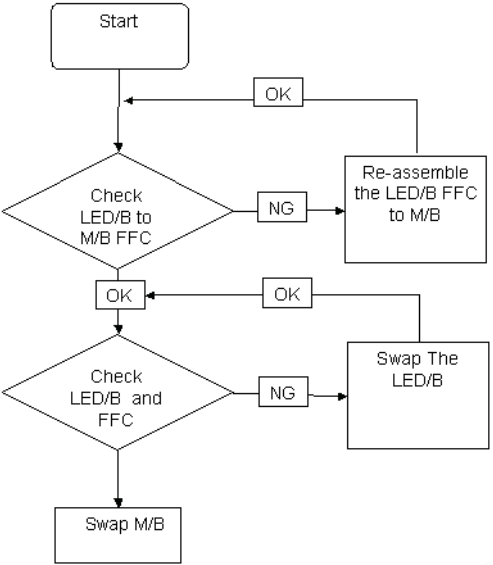

MediaTouch Button Failure

If the **Acer MediaTouch** buttons fail, perform the following actions one at a time to correct the problem. Do not replace a non-defective FRUs:

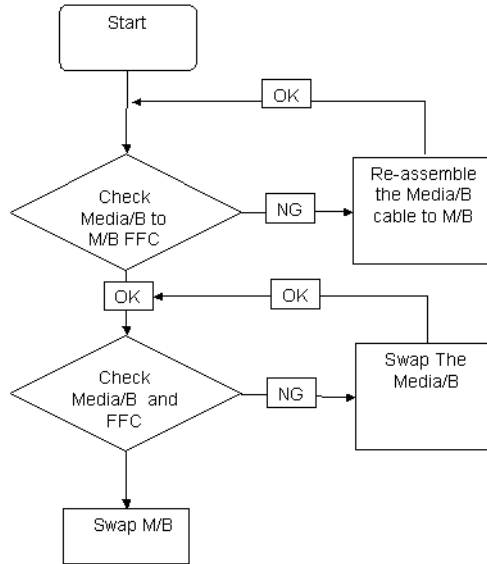

Fingerprint Reader Failure

If the **Fingerprint Reader** fails, perform the following actions one at a time to correct the problem. Do not replace a non-defective FRUs:

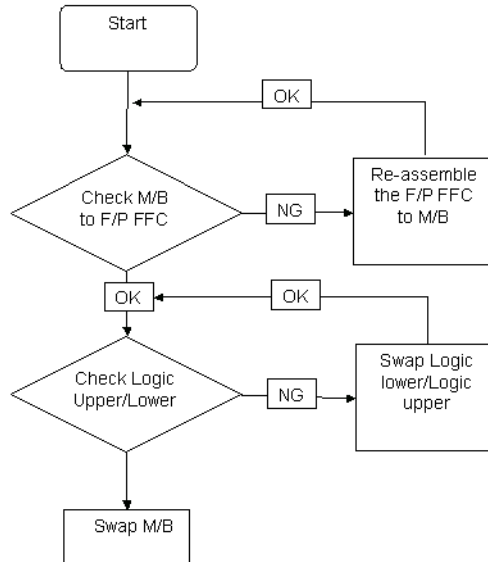

Thermal Unit Failure

If the **Thermal Unit** fails, perform the following actions one at a time to correct the problem. Do not replace a non-defective FRUs:

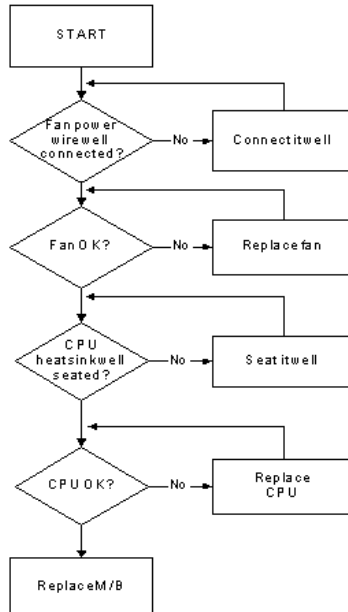

HDTV Switch Failure

If the **HDTV Switch** fails, perform the following actions one at a time to correct the problem. Do not replace a non-defective FRUs:

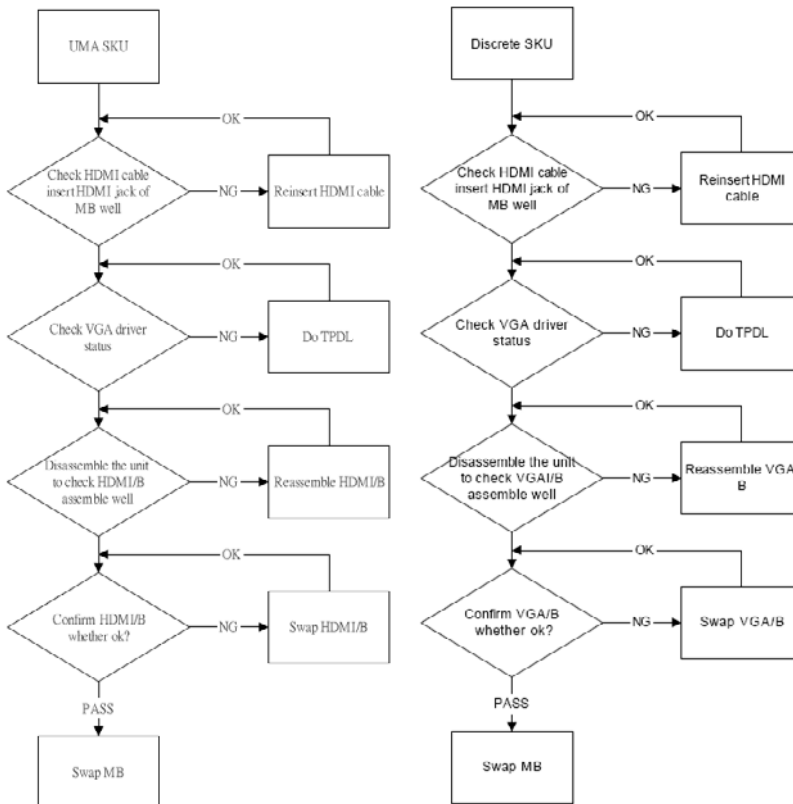

External Mouse Failure

If an external **Mouse** fails, perform the following actions one at a time to correct the problem.

1. Try an alternative mouse.
2. If the mouse uses a wireless connection, insert new batteries and confirm there is a good connection. See the mouse user manual.
3. If the mouse uses a USB connection, try an alternate USB port.
4. Try an alternative program to verify mouse operation. Reinstall the program experiencing mouse failure.
5. Restart the computer.
6. Remove any recently added hardware and associated software.
7. Remove any recently added software and reboot.
8. Restore system and file settings from a known good date using **System Restore**.

If the issue is not fixed, repeat the preceding steps and select an earlier time and date.

9. Run the Event Viewer to check the events log for errors. For more information see Windows Help and Support.
10. Roll back the mouse driver to the previous version if updated recently.
11. Remove and reinstall the mouse driver.
12. Check the Device Manager to determine that:
 - The device is properly installed. There are no red Xs or yellow exclamation marks.
 - There are no device conflicts.
 - No hardware is listed under Other Devices.
13. If the Issue is still not resolved, see "Online Support Information" on page 193.

Other Failures

If the CRT Switch, Dock, LAN Port, external MIC or Speakers, PCI Express Card, 5-in-1 Card Reader or Volume Wheel fail, perform the following general steps to correct the problem. Do not replace a non-defective FRUs:

1. Check Drive whether is OK.
2. Check Test Fixture is ok.
3. Swap M/B to Try.

Intermittent Problems

Intermittent system hang problems can be caused by a variety of reasons that have nothing to do with a hardware defect, such as: cosmic radiation, electrostatic discharge, or software errors. FRU replacement should be considered only when a recurring problem exists.

When analyzing an intermittent problem, do the following:

1. Run the advanced diagnostic test for the system board in loop mode at least 10 times.
2. If no error is detected, do not replace any FRU.
3. If any error is detected, replace the FRU. Rerun the test to verify that there are no more errors.

Undetermined Problems

The diagnostic problems does not identify which adapter or device failed, which installed devices are incorrect, whether a short circuit is suspected, or whether the system is inoperative.

Follow these procedures to isolate the failing FRU (do not isolate non-defective FRU).

NOTE: Verify that all attached devices are supported by the computer.

NOTE: Verify that the power supply being used at the time of the failure is operating correctly. (See “Power On Issue” on page 144.):

1. Power-off the computer.
2. Visually check them for damage. If any problems are found, replace the FRU.
3. Remove or disconnect all of the following devices:
 - Non-Acer devices
 - Printer, mouse, and other external devices
 - Battery pack
 - Hard disk drive
 - DIMM
 - CD-ROM/Diskette drive Module
 - PC Cards
4. Power-on the computer.
5. Determine if the problem has changed.
6. If the problem does not recur, reconnect the removed devices one at a time until you find the failing FRU.
7. If the problem remains, replace the following FRU one at a time. Do not replace a non-defective FRU:
 - System board
 - LCD assembly

POST Codes Tables

These tables describe the POST codes, functions, phases, and components for the POST.

Chipset POST Codes

The following table details the chipset POST codes and functions used in the POST.

Code	Beeps	POST Routine Description
02h		Verify Real Mode
03h		Disable Non-Maskable Interrupt (NMI)
04h		Get CPU type
06h		Initialize system hardware
08h		Initialize chipset with initial POST values
09h		Set IN POST flag
0Ah		Initialize CPU registers
0Bh		Enable CPU cache
0Ch		Initialize caches to initial POST values
0Eh		Initialize I/O component
0Fh		Initialize the local bus IDE
10h		Initialize Power Management
11h		Load alternate registers with initial POST values
12h		Restore CPU control word during warm boot
13h		Initialize PCI Bus Mastering devices
14h		Initialize keyboard controller
16h	1-2-2-3	BIOS ROM checksum
17h		Initialize cache before memory autosize
18h	8254	timer initialization
1Ah	8237	DMA controller initialization
1Ch		Reset Programmable Interrupt Controller
20h	1-3-1-1	Test DRAM refresh
22h	1-3-1-3	Test 8742 Keyboard Controller
24h		Set ES segment register to 4 GB
26h		Enable A20 line
28h		Autosize DRAM
29h		Initialize POST Memory Manager
2Ah		Clear 512 KB base RAM
2Ch	1-3-4-1	RAM failure on address line xxxx*
2Eh	1-3-4-3	RAM failure on data bits xxxx* of low byte of memory bus
2Fh		Enable cache before system BIOS shadow
30h	1-4-1-1	RAM failure on data bits xxxx* of high byte of memory bus
32h		Test CPU bus-clock frequency
33h		Initialize Phoenix Dispatch Manager
36h		Warm start shut down
38h		Shadow system BIOS ROM
3Ah		Autosize cache

Code	Beeps	POST Routine Description
3Ch		Advanced configuration of chipset registers
3Dh		Load alternate registers with CMOS values
42h		Initialize interrupt vectors
45h		POST device initialization
46h	2-1-2-3	Check ROM copyright notice
48h		Check video configuration against CMOS
49h		Initialize PCI bus and devices
4Ah		Initialize all video adapters in system
4Bh		QuietBoot start (optional)
4Ch		Shadow video BIOS ROM
4Eh		Display BIOS copyright notice
50h		Display CPU type and speed
51h		Initialize EISA board
52h		Test keyboard
54h		Set key click if enabled
58h	2-2-3-1	Test for unexpected interrupts
59h		Initialize POST display service
5Ah		Display prompt Press F2 to enter SETUP
5Bh		Disable CPU cache
5Ch		Test RAM between 512 and 640 KB
60h		Test extended memory
62h		Test extended memory address lines
64h		Jump to UserPatch1
66h		Configure advanced cache registers
67h		Initialize Multi Processor APIC
68h		Enable external and CPU caches
69h		Setup System Management Mode (SMM) area
6Ah		Display external L2 cache size
6Bh		Load custom defaults (optional)
6Ch		Display shadow-area message
6Eh		Display possible high address for UMB recovery
70h		Display error messages
72h		Check for configuration errors
76h		Check for keyboard errors
7Ch		Set up hardware interrupt vectors
7Eh		Initialize coprocessor if present
80h		Disable onboard Super I/O ports and IRQs
81h		Late POST device initialization
82h		Detect and install external RS232 ports
83h		Configure non-MCD IDE controllers
84h		Detect and install external parallel ports
85h		Initialize PC-compatible PnP ISA devices
86h		Re-initialize onboard I/O ports.

Code	Beeps	POST Routine Description
87h		Configure Motherboard Configurable Devices (optional)
88h		Initialize BIOS Data Area
89h		Enable Non-Maskable Interrupts (NMIs)
8Ah		Initialize Extended BIOS Data Area
8Bh		Test and initialize PS/2 mouse
8Ch		Initialize floppy controller
8Fh		Determine number of ATA drives (optional)
90h		Initialize hard-disk controllers
91h		Initialize local-bus hard-disk controllers
92h		Jump to UserPatch2
93h		Build MPTABLE for multi-processor boards
95h		Install CD ROM for boot
96h		Clear huge ES segment register
97h		Fixup Multi Processor table
98h	1-2	Search for option ROMs. One long, two short beeps on checksum failure
99h		Check for SMART Drive (optional)
9Ah		Shadow option ROMs
9Ch		Set up Power Management
9Dh		Initialize security engine (optional)
9Eh		Enable hardware interrupts
9Fh		Determine number of ATA and SCSI drives
A0h		Set time of day
A2h		Check key lock
A4h		Initialize Typematic rate
A8h		Erase F2 prompt
AAh		Scan for F2 key stroke
ACh		Enter SETUP
A Eh		Clear Boot flag
B0h		Check for errors
B2h		POST done - prepare to boot operating system
B4h	1	One short beep before boot
B5h		Terminate QuietBoot (optional)
B6h		Check password (optional)
B9h		Prepare Boot
BAh		Initialize DMI parameters
BBh		Initialize PnP Option ROMs
BCh		Clear parity checkers
BDh		Display MultiBoot menu
BEh		Clear screen (optional)
BFh		Check virus and backup reminders
C0h		Try to boot with INT 19
C1h		Initialize POST Error Manager (PEM)
C2h		Initialize error logging

Code	Beeps	POST Routine Description
C3h		Initialize error display function
C4h		Initialize system error handler
C5h		PnPnd dual CMOS (optional)
C6h		Initialize notebook docking (optional)
C7h		Initialize notebook docking late
C8h		Force check (optional)
C9h		Extended checksum (optional)
D2h		Unknown interrupt

Code	Beeps	For Boot Block in Flash ROM
E0h		Initialize the chipset
E1h		Initialize the bridge
E2h		Initialize the CPU
E3h		Initialize system timer
E4h		Initialize system I/O
E5h		Check force recovery boot
E6h		Checksum BIOS ROM
E7h		Go to BIOS
E8h		Set Huge Segment
E9h		Initialize Multi Processor
EAh		Initialize OEM special code
EBh		Initialize PIC and DMA
ECh		Initialize Memory type
EDh		Initialize Memory size
EEh		Shadow Boot Block
EFh		System memory test
F0h		Initialize interrupt vectors
F1h		Initialize Run Time Clock
F2h		Initialize video
F3h		Initialize System Management Mode
F4h	1	Output one beep before boot
F5h		Boot to Mini DOS
F6h		Clear Huge Segment
F7h		Boot to Full DOS

* If the BIOS detects error 2C, 2E, or 30 (base 512K RAM error), it displays an additional word-bitmap (xxxx) indicating the address line or bits that failed. For example, **2C 0002** means address line 1 (bit one set) has failed. **2E 1020** means data bits 12 and 5 (bits 12 and 5 set) have failed in the lower 16 bits. Note that error 30 cannot occur on 386SX systems because they have a 16 rather than 32-bit bus. The BIOS also sends the bitmap to the port-80 LED display. It first displays the check point code, followed by a delay, the high-order byte, another delay, and then the low-order byte of the error. It repeats this sequence continuously.

Jumper and Connector Locations

Top View

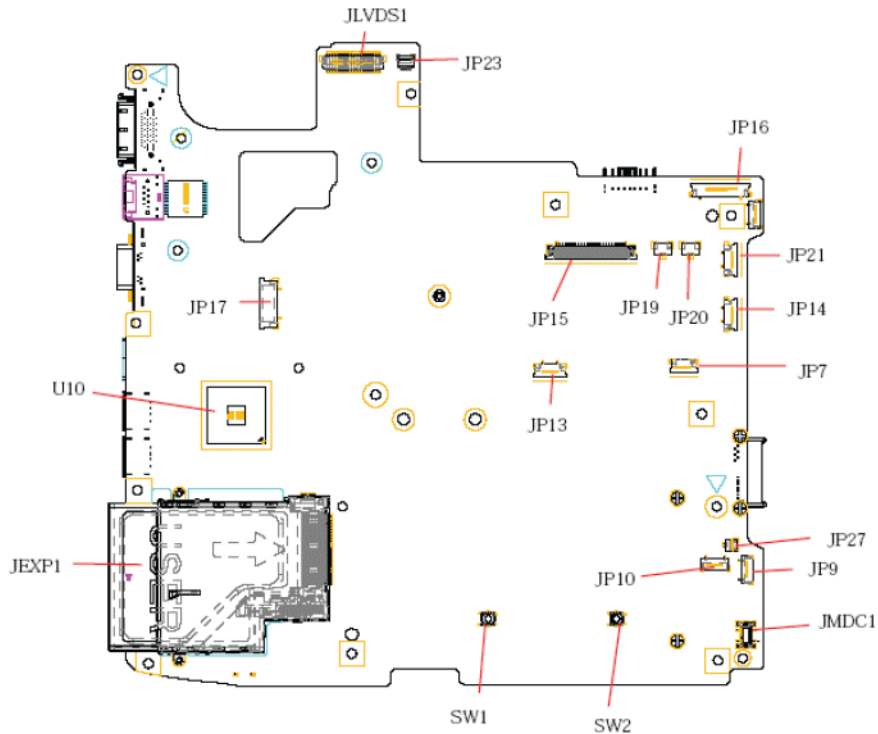

Item	Description	Item	Description
JLVDS1	LCD Connector	JP13	FP/B Connector
JP23	Acer backlight Connector	JP27	Sub-Woofers Connector
JP16	Power/B Connector	JP9	USB/B Connector
JP8	TV/B Connector	JP10	Bluetooth Connector
JP21	Fun/B Connector	JMDC1	MDC Connector
JP14	Media/B Connector	JEXP1	Express Card Socket
JP19	Speaker (Left) Connector	JP17	BTN/B Connector
JP20	Speaker (Right) Connector	SW1	Touch pad (right) Button
JP15	Internal Keyboard Connector	SW2	Touch pad (left) Button
JP7	Touch Pad Connector	U10	South Bridge

Bottom View

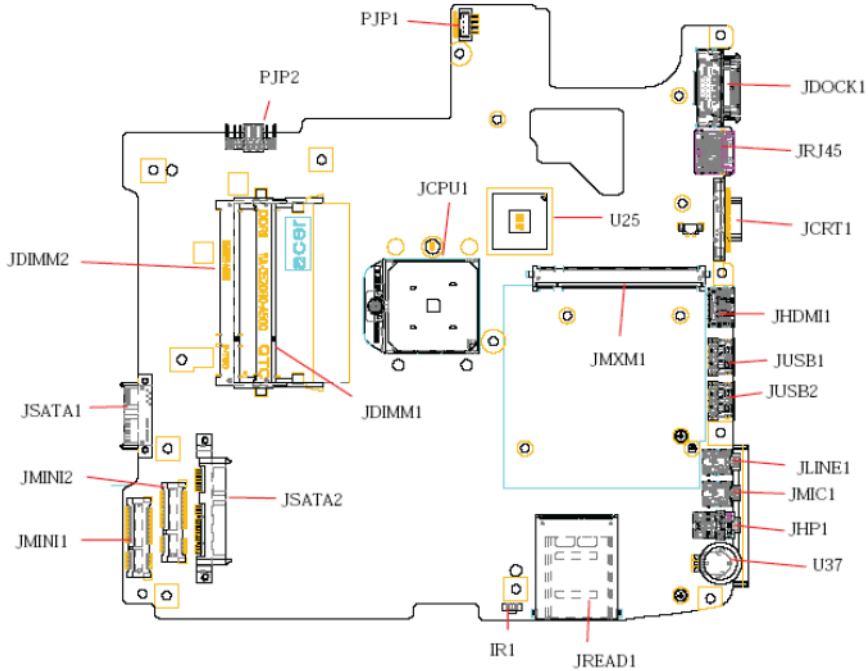

Item	Description	Item	Description
PJP1	AC-IN Connector	JSATA2	HDD Connector
JDOCK1	Dock Connector	JMINI2	TV-Tuner Card Connector
JRJ45	RJ45 Connector	JMINI1	Wireless Card Connector
JMXM1	MXM Board Connector	JSATA1	ODD Connector
JCRT1	CRT Connector	JDIMM2	Memory DIMM2 Connector
JHDMI1	HDMI Connector	JDIMM1	Memory DIMM1 Connector
JUSB1	USB Connector	PJP2	Battery Connector
JUSB2	USB Connector	JCPU1	CPU Socket
JLINE1	Line-In Jack	U25	North Bridge
JMIC1	MIC-In Jack	U37	Volume control wheel
JHP1	Head-Phone Connector	IR1	IR receiver
JREAD1	Card Reader Socket		

Clearing Password Check and BIOS Recovery

This section provide you the standard operating procedures of clearing password and BIOS recovery for Aspire 5530. Aspire 5530 provide one Hardware Open Gap on main board for clearing password check, and one Hotkey for enabling BIOS Recovery.

Clearing Password Check

Hardware Open Gap Description

Item	Description
J1	Clear CMOS Jumper



Steps for Clearing BIOS Password Check

If users set BIOS Password (Supervisor Password and/or User Password) for a security reason, BIOS will ask the password during systems POST or when systems enter to BIOS Setup menu. However, once it is necessary to bypass the password check, users need to short the HW Gap to clear the password by the following steps:

- Power Off a system, and remove HDD, AC and Battery from the machine.
- Open the back cover of the machine, and find out the HW Gap on M/B as picture.
- Use an electric conductivity tool to short the two points of the HW Gap.
- Plug in AC, keep the short condition on the HW Gap, and press Power Button to power on the system till BIOS POST finish. Then remove the tool from the HW Gap.
- Restart system. Press F2 key to enter BIOS Setup menu.
- If there is no Password request, BIOS Password is cleared. Otherwise, please follow the steps and try again.

NOTE: The steps are only for clearing BIOS Password (Supervisor Password and User Password).

BIOS Recovery by Crisis Disk

BIOS Recovery Boot Block:

BIOS Recovery Boot Block is a special block of BIOS. It is used to boot up the system with minimum BIOS initialization. Users can enable this feature to restore the BIOS firmware to a successful one once the previous BIOS flashing process failed.

BIOS Recovery Hotkey:

The system provides a function hotkey: **Fn+Esc**, for enable BIOS Recovery process when system is powered on during BIOS POST. To use this function, it is strongly recommended to have the AC adapter and Battery present. If this function is enabled, the system will force the BIOS to enter a special BIOS block, called Boot Block.

Steps for BIOS Recovery by Crisis Disk:

Before doing this, one Crisis Diskette should be prepared ready in hand. The Crisis Diskette could be made by executing the Crisis Disk program in another system with Windows XP OS.

Follow the steps below:

1. Power Off failed system.
2. Attach a USB floppy drive to the failed system.
3. Copy **jalb028.wph** to tool's folder and rename it as **BIOS.wph**.
4. Execute **wincris.exe** to start the Crisis Disk Build.
5. Select **Removable** and click **Start**.

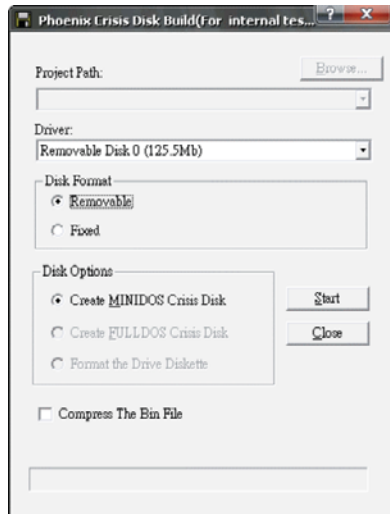

6. Select **Format Disk** and click **Start**.

A progress screen displays.

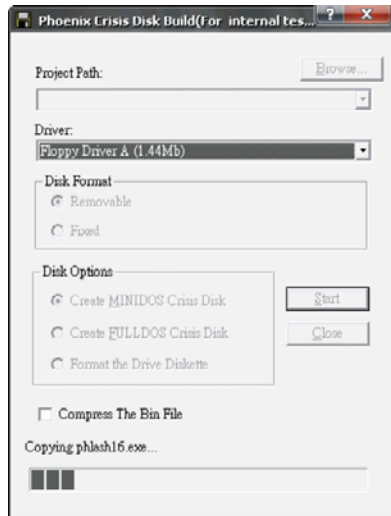

7. The following message displays when the Crisis Diskette is created successfully.



8. Click **OK** to complete the process.
9. Insert the Crisis Disk in to the USB floppy drive attached to the BIOS flash failed system.
10. In the power-off state, press and hold **Fn+Esc** then press the Power button.

The system powers on and the Crisis BIOS Recovery process begins.

BIOS Boot Block begins restoring the BIOS code from the Crisis floppy disk to BIOS ROM on the failed systems.

When the Crisis flash process is finished, the system restarts with a workable BIOS.

Update to the latest version BIOS for the system using the regular BIOS flashing process.

FRU (Field Replaceable Unit) List

This chapter gives you the FRU (Field Replaceable Unit) listing in global configurations of Aspire 5530. Refer to this chapter whenever ordering for parts to repair or for RMA (Return Merchandise Authorization).

Please note that WHEN ORDERING FRU PARTS, you should check the most up-to-date information available on your regional web or channel. For whatever reasons a part number change is made, it will not be noted on the printed Service Guide. For ACER AUTHORIZED SERVICE PROVIDERS, your Acer office may have a DIFFERENT part number code from those given in the FRU list of this printed Service Guide. You MUST use the local FRU list provided by your regional Acer office to order FRU parts for repair and service of customer machines.

NOTE: To scrap or to return the defective parts, you should follow the local government ordinance or regulations on how to dispose it properly, or follow the rules set by your regional Acer office on how to return it.

Aspire 5530 Exploded Diagrams

Discrete SKU

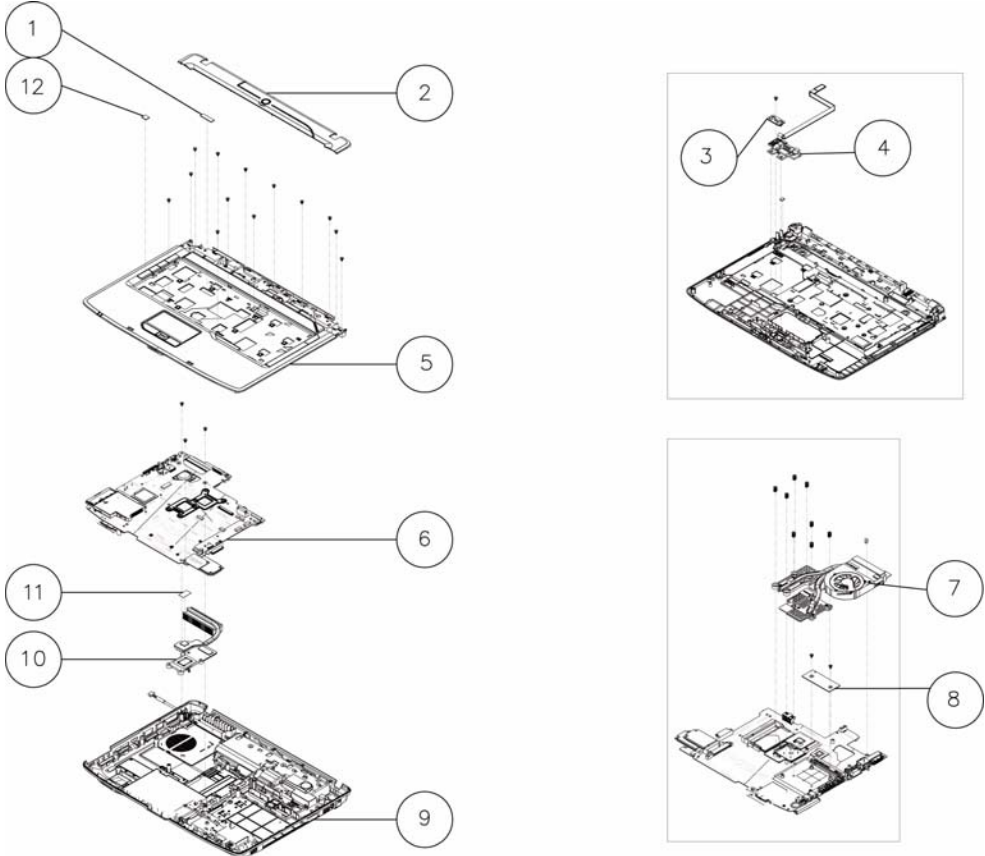

Item	Description	Part Number
1	Heat Pad	
2	Strip Cover	
3	F/P Board Bracket	
4	F/P Board Module	
5	Upper Case with F/P Reader	
6	Mainboard	
7	Thermal Unit with Fan Module	
8	HDMI Module	
9	Lower Case	
10	Thermal Module	
11	CPU	
12	Heat Pad	



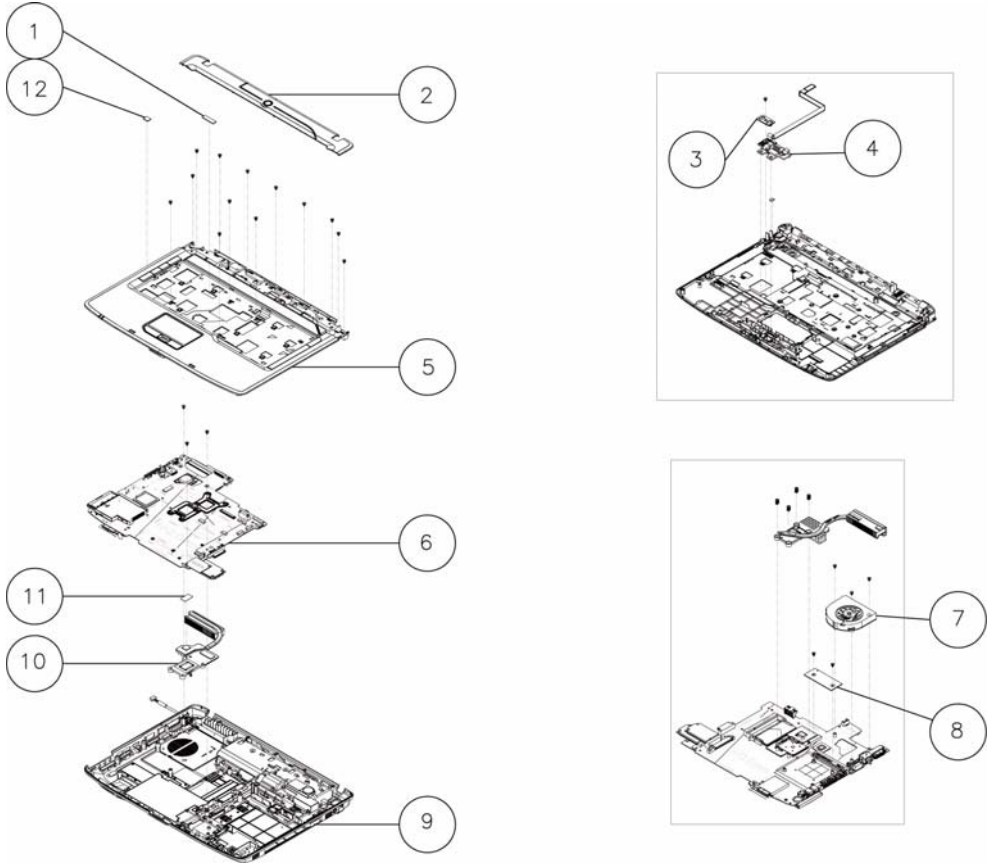





UMA SKU

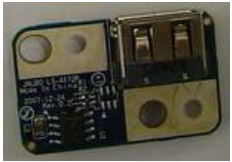
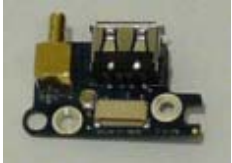
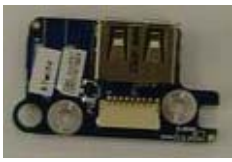



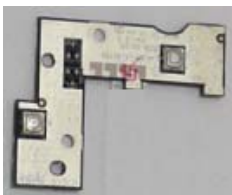





Item	Description	Part Number
1	Heat Pad	
2	Strip Cover	
3	F/P Board Bracket	
4	F/P Board Module	
5	Upper Case with F/P Reader	
6	Mainboard	
7	Fan Module	
8	HDMI Module	
9	Lower Case	
10	Thermal Module	
11	CPU	
12	Heat Pad	







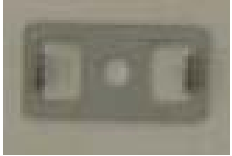

Aspire 5530 FRU List

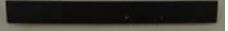

Category	Description	Part Number
Adapter		
	ADAPTER 65W 3PIN DELTA SADP-65KB DFA	
	ADAPTER 65W 3PIN DELTA SADP65KB BFJA	
	ADAPTER 65W 3PIN LITE-ON PA-1650-02AC	
	ADAPTER 65W 3PIN HIPRO AC-OK065B13	
	ADAPTER 90W 3PIN DELTA ADP-90SB BBEA	
	ADAPTER 90W 3PIN DELTA ADP90SB BBEN	
	ADAPTER 90W 3PIN LITE-ON PA-1900-24AR	
	ADAPTER 90W 3PIN HIPRO AC-OL093B13P	
Battery		
	BATTERY 6CELL 2.2AH SANYO SA SA 3S2P 4.4AH	
	BATTERY 6CELL 2.2AH SONY SY SY 3S2P 4.4AH	
	BATTERY 6CELL 2.2AH SIMPLO SP PA 3S2P 4.4AH	
	BATTERY 6CELL 2.2AH PANASONIC PA PA 3S2P 4.4AH	
	BATTERY 8CELL 2.4AH SANYO SA SA 4S2P 4.8AH	
	BATTERY 8CELL 2.4AH PANASONIC PA PA 4S2P 4.8AH	
	BATTERY 8CELL 2.4AH SIMPLO SP PA 4S2P 4.8AH	
	BATTERY 8CELL 2.4AH SONY SY SY 4S2P 4.8AH	
Board		
	MODEM CARD	
	MODEM CARD-AUS	
	BLUE TOOTH	
	TV TUNER	
	WLAN CARD FOXCONN T60H976.00 (FW-06) 54M XB63	
	WLAN CARD FOXCONN T77H030.00 54MBPS BCM4312	
	VGA BOARD-M86ME	

Category	Description	Part Number
	USB BOARD	
	TV BOARD W/RF	
	TV BOARD W/O RF	
	MEDIA BOARD	
	FINGER PRINT BOARD	
	POWER BOARD	
	FUNCTION BOARD	
	BUTTON BOARD	
	HDMI BOARD-UMA	
Cable		
	RJ11 CABLE	
	BLUE TOOTH CABLE	
	USB CABLE	



Category	Description	Part Number
	TV BOARD CABLE	
	MEDIA BOARD FFC	
	ANTENNA-R	
	ANTENNA-L	
	T/P FFC	
	POWER CORD US 3 PIN	27.TAVV5.001
	POWER CORD EU 3 PIN	27.TAVV5.002
	POWER CORD AUS 3 PIN	27.TAVV5.003
	POWER CORD UK 3 PIN	27.TAVV5.004
	POWER CORD CHINA 3 PIN	27.TAVV5.005
	POWER CORD SWISS 3 PIN	27.TAVV5.006
	POWER CORD ITALIAN 3 PIN	27.TAVV5.007
	POWER CORD DENMARK 3 PIN	27.TAVV5.008
	POWER CORD JP 3 PIN	27.TAVV5.009
	POWER CORD SOUTH AFRICA 3 PIN	27.TAVV5.010
	POWER CORD KOERA 3 PIN	27.TAVV5.011
	POWER CORD ISRAEL 3 PIN	27.TAVV5.012
	POWER CORD INDIA 3 PIN	27.TAVV5.013
	POWER CORD TWN 3 PIN	27.TAVV5.014
POWER CORD ARGENTINA 3 PIN		







Category	Description	Part Number
Assembly		
	STRIP COVER	
	UPPER CASE ASSY W/FP	
	UPPER CASE ASSY W/O FP	
	T/P BRACKET	
	LOWER CASE ASSY W/TV	
	LOWER CASE ASSY W/OTV	
	UPPER SADDLE-R	
	UPPER SADDLE-L	
	MINI PCI BRACKET-L	
	FINGER PRINT BOARD BRACKET	
	EXPRESS DUMMY CARD	
	SD DUMMY CARD	

Category	Description	Part Number
	RAM DOOR	
	HDD DDOR	
	MINI PCI DOOR	
CPU		
		
ODD		
	DVD SUPER MULTI DRIVE PIONEER DVR-TD08RS 0FA	
	DVD SUPER MULTI DRIVE TSST TS-L633A 0FA	
	DVD SUPER MULTI DRIVE PANASONIC UJ-870S 0FA	
	DVD SUPER MULTI DRIVE HLDS GSA-T50N 0FA	
	DVD SUPER MULTI DRIVE SONY AD-7560S 0FA	
	DVD SUPER MULTI DRIVE PLDS DS-8A2S 0FA	
	ODD BEZEL-SUPER MULTI	
	ODD BRACKET	
	BLUE RAY DRIVE SONY BC-5500S AR 0FA	
		ODD BEZEL-BR
	ODD BRACKET	

Category	Description	Part Number
HDD		
	HDD SATA 120G 5400RPM HGST HTS542512K9SA00 0FA	
	HDD SATA 120G 5400RPM TOSHIBA MK1246GSX 0FA	
	HDD SATA 120G 5400RPM SEAGATE ST9120817AS 0FA	
	HDD SATA 120G 5400RPM WD WD1200BEVS-22UST0 0FA	
	HDD SATA 160G 5400RPM HGST HTS542516K9SA00 0FA	
	HDD SATA 160G 5400RPM HGST HTS543216L9A300 0FA	
	HDD SATA 160G 5400RPM TOSHIBA MK1646GSX 0FA	
	HDD SATA 160G 5400RPM TOSHIBA MK1652GSX 0FA	
	HDD SATA 160G 5400RPM SEAGATE ST9160827AS 0FA	
	HDD SATA 160G 5400RPM SEAGATE ST9160310AS 0FA	
	HDD SATA 160G 5400RPM WD WD1600BEVS-22ZCT0	
	HDD SATA 250G 5400RPM HGST HTS542525K9SA00 0FA	
	HDD SATA 250G 5400RPM TOSHIBA MK2546GSX 0FA	
	HDD SATA 250G 5400RPM SEAGATE ST9250827AS 0FA	
	HDD SATA 250G 5400RPM WD WD2500BEVS-22UST0 0FA	
	HDD SATA 320G 5400RPM WD WD3200BEVT-22ZCT0 0FA	
	HDD SATA 320G 5400RPM HGST HTS543232L9A300 0FA	
HDD SATA 320G 5400RPM SEAGATE ST9320320AS 0FA		
	HDD CARRIER	

Category	Description	Part Number
Keyboard		
	KEYBOARD INTE(UI) BLACK AS	
	KEYBOARD ARE BLACK AS	
	KEYBOARD BE BLACK AS	
	KEYBOARD BZ BLACK AS	
	KEYBOARD CF BLACK AS	
	KEYBOARD CH BLACK AS	
	KEYBOARD CZ BLACK AS	
	KEYBOARD DM BLACK AS	
	KEYBOARD NL BLACK AS	
	KEYBOARD FR BLACK AS	
	KEYBOARD GR BLACK AS	
	KEYBOARD GK BLACK AS	
	KEYBOARD HG BLACK AS	
	KEYBOARD IT BLACK AS	
	KEYBOARD KO BLACK AS	
	KEYBOARD NW BLACK AS	
	KEYBOARD PO BLACK AS	
	KEYBOARD RU BLACK AS	
	KEYBOARD SA/CR BLACK AS	
	KEYBOARD SV BLACK AS	
	KEYBOARD SP BLACK AS	
	KEYBOARD SD/FN BLACK AS	
	KEYBOARD SW BLACK AS	
	KEYBOARD TI BLACK AS	
	KEYBOARD TR BLACK AS	
	KEYBOARD UK BLACK AS	
KEYBOARD HB BLACK AS		
KEYBOARD JP BLACK AS		
KEYBOARD ND BLACK AS		
KEYBOARD AR/FR BLACK AS		
KEYBOARD CB BLACK AS		
LCD Display		
	LCD PANEL G 15.4" WXGA AUO B154EW08 V1 3A	
	LCD PANEL G 15.4" WXGA CMO N154I3-L03	
	LCD PANEL G 15.4" WXGA LG LP154WX4-TLB4	
	LCD PANEL G 15.4" WXGA SEC LTN154AT01-A01	
	INVERTER	
	LCD CABLE	

Category	Description	Part Number
	LCD COVER	
	LCD BEZEL	
	LCD BRACKET-R	
	LCD BRACKET-L	
	CAMERA MODULE-0.3M	
	CAMERA BRACKET	
	SCREW PAD	
Mainboard		
	MB ASSY-UMA	
	MB ASSY-DIS	
	THERMAL PAD-L	
	THERMAL PAD-S	

Category	Description	Part Number
Memory		
	RAM 512MB DDRII 667 NANYA NT512T64UH8B0FN-3C	
	RAM 512MB DDRII 667 SAMSUNG M470T6464QZ3-CE6	
	RAM 512MB DDRII 667 SAMSUNG M470T6554EZ3-CE6	
	RAM 512MB DDRII 667 HYNIX HYMP164S64CP6-Y5	
	RAM 1G DDRII 667 NANYA NT1GT64U8HB0BN-3C	
	RAM 1G DDRII 667 HYNIX HYMP112S64CP6-Y5	
	RAM 1G DDRII 667 SAMSUNG M470T2864QZ3-CE6	
	RAM 1G DDRII 667 SAMSUNG M470T2864DZ3-CE6	
	RAM 2G DDRII 667 MICRON MT16HTF25664HY-667E1	
	RAM 2G DDRII 667 HYNIX HYMP125S64CP8-Y5	
	RAM 2G DDRII 667 SAMSUNG M470T5663QZ3-CE6	
Heatsink		
	CPU THERMAL MODULE-DIS	
	CPU THERMAL MODULE-UMA	
Speaker		
	SPEAKER-R	
	SPEAKER-L	
	SUB WOOFER	
	MIC SET	
Misc		
	VGA MYLAR	
	NAME PLATE-AS5530	
	NAME PLATE-AS5230	

Category	Description	Part Number
	RUBBER FOOT-L	
	RUBBER FOOT-S	
Accessories		
	DVB-T ANTENNA	
	SMB-PAL CONNECTOR	
	PAL-F CONNECTOR	

Screw List

Category	Description	Part Number
SCREW	SCREW M2.5X4(NL)	
SCREW	SCREW M2.5X6(NL)	
SCREW	SCREW M2.5X10(NL)	
SCREW	SCREW M 2D 2.5L K 4.05D NI NL	
SCREW	SCREW M2D 3.0L K 8.0D(Ni)	
SCREW	SCREW M2X3(NL)	
SCREW	SCREW M2X5(Ni-NL)	
SCREW	SCREW M3.0D 3.0L K 4.9D(Ni)	
SCREW	SCREW CPU_THERMAL_SCREW_ASSY	
SCREW	SCREW M2.0D 3L K 5D(Ni)	
SCREW	SCREW F 4# 5L K 4.5D ZK NL +CR3+	

Model Definition and Configuration

Aspire 5530 Series

Model	RO	Country	Acer Part no	Description	CPU	LCD	DIMM 1	DIM M2	HDD 1 (GB)	ODD	Wireless LAN	Bluetooth	Finger Print
AS5530G702G2 5Mi	PA	USA	LX.AR V0X.0 01	AS5530G702G 25Mi VHP32ATUS1 MC 82MEXTHM2 56CO 2*1G/ 250/6L/5R/ CB_bg_FP_0. 3D_HG_EN32	ATRM 70	N15.4 WXGA G8	SO1 GBII6	SO1 GBII 6	N250 GB5.4 KS	NSM8 XS	3rd WiFi BG	N	AES16 10
AS5530G702G2 5Mi	PA	Canada	LX.AR V0X.0 02	AS5530G702G 25Mi VHP32ATCA2 MC 82MEXTHM2 56CO 2*1G/ 250/6L/5R/ CB_bg_FP_0. 3D_HG_FR31	ATRM 70	N15.4 WXGA G8	SO1 GBII6	SO1 GBII 6	N250 GB5.4 KS	NSM8 XS	3rd WiFi BG	N	AES16 10
AS5530G702G2 5Mi	PA	ACLA-Portuguese	LX.AR V0X.0 03	AS5530G702G 25Mi EM VHP32ATXC1 MC 82MEXTHM2 56CO 2*1G/ 250/6L/5R/ CB_bg_FP_0. 3D_HG_XC22	ATRM 70	N15.4 WXGA G8	SO1 GBII6	SO1 GBII 6	N250 GB5.4 KS	NSM8 XS	3rd WiFi BG	N	AES16 10
AS5530G702G2 5Mi	PA	ACLA-Spanish	LX.AR V0X.0 04	AS5530G702G 25Mi EM VHP32ATEA1 MC 82MEXTHM2 56CO 2*1G/ 250/6L/5R/ CB_bg_FP_0. 3D_HG_ES22	ATRM 70	N15.4 WXGA G8	SO1 GBII6	SO1 GBII 6	N250 GB5.4 KS	NSM8 XS	3rd WiFi BG	N	AES16 10
AS5530G702G2 5Mi	PA	ACLA-Spanish	LX.AR V0X.0 05	AS5530G702G 25Mi EM VHP32ATEA3 MC 82MEXTHM2 56CO 2*1G/ 250/6L/5R/ CB_bg_FP_0. 3D_HG_ES22	ATRM 70	N15.4 WXGA G8	SO1 GBII6	SO1 GBII 6	N250 GB5.4 KS	NSM8 XS	3rd WiFi BG	N	AES16 10
AS5530G823G3 2Bi	PA	ACLA-Spanish	LX.AR V0X.0 09	AS5530G823G 32Bi EM VHP32ATEA1 MC 82MEXTHM2 56CO 2G+1G/ 320/BT/8L/5R/ CB_bg_FP_0. 3D_HG_ES22	ATUZ M82	N15.4 WXGA G8	SO2 GBII6	SO1 GBII 6	N320 GB5.4 KS	NBD C B2XS	3rd WiFi BG	BT 2.0	AES16 10
Model	RO	Country	Acer Part no	Description	CPU	LCD	DIMM 1	DIM M 2	HDD 1 (GB)	ODD	Wireless LAN	Bluetooth	Finger Print

Model	RO	Country	Acer Part no	Description	CPU	LCD	DIMM 1	DIM M2	HDD 1 (GB)	ODD	Wireless LAN	Bluetooth	Finger Print
AS553 0G823 G3 2Bi	PA	ACLA-Spanish	LX.AR V0X.0 10	AS5530G823G 32Bi EM VHP32ATEA3 MC 82MEXTHM2 56CO 2G+1G/ 320/BT/8L/5R/ CB_bg_FP_0. 3D_HG_ES22	ATUZ M82	N15.4 WXGA G8	SO2 GBII6	SO1 GBII 6	N320 GB5.4 KS	NBD C B2XS	3rd WiFi BG	BT 2.0	AES16 10
AS553 0G823 G3 2Bi	PA	USA	LX.AR V0X.0 06	AS5530G823G 32Bi EM VHP32ATUS1 MC 82MEXTHM2 56CO 2G+1G/ 320/BT/8L/5R/ CB_bg_FP_0. 3D_HG_EN32	ATUZ M82	N15.4 WXGA G8	SO2 GBII6	SO1 GBII 6	N320 GB5.4 KS	NBD C B2XS	3rd WiFi BG	BT 2.0	AES16 10
AS553 0G823 G3 2Bi	PA	ACLA-Portuguese	LX.AR V0X.0 07	AS5530G823G 32Bi EM VHP32ATXC1 MC 82MEXTHM2 56CO 2G+1G/ 320/BT/8L/5R/ CB_bg_FP_0. 3D_HG_XC22	ATUZ M82	N15.4 WXGA G8	SO2 GBII6	SO1 GBII 6	N320 GB5.4 KS	NBD C B2XS	3rd WiFi BG	BT 2.0	AES16 10
AS553 0G823 G3 2Bi	PA	Canada	LX.AR V0X.0 08	AS5530G823G 32Bi EM VHP32ATCA2 MC 82MEXTHM2 56CO 2G+1G/ 320/BT/8L/5R/ CB_bg_FP_0. 3D_HG_FR31	ATUZ M82	N15.4 WXGA G8	SO2 GBII6	SO1 GBII 6	N320 GB5.4 KS	NBD C B2XS	3rd WiFi BG	BT 2.0	AES16 10
AS553 0G701 G2 5Mi	TW N	GCTWN	LX.AR V0X.0 11	AS5530G701G 25Mi VHP32ATTW 1 MC 82MEXTHM2 56CO 1*1G/ 250/BT/8L/5R/ CB_bg_FP_0. 3D_HG_TC11	ATRM 70	N15.4 WXGA G8	SO1 GBII6	N	N250 GB5.4 KS	NSM8 XS	3rd WiFi BG	BT 2.0	AES16 10
AS553 0G702 G2 5Mi	AA P	Japan	LX.AR V0X.0 12	AS5530G702G 25Mi VHP32AJP1 MC 82MEXTHM2 56CO 2*1G/ 250/BT/6L/5R/ CB_bg_FP_0. 3D_HG_JA11	ATRM 70	N15.4 WXGA G8	SO1 GBII6	SO1 GBII 6	N250 GB5.4 KS	NSM8 XS	3rd WiFi BG	BT 2.0	AES16 10
AS553 0G702 G2 5Mi	AA P	Thailand	LX.AR V0X.0 13	AS5530G702G 25Mi EM VHP32ATTH1 MC 82MEXTHM2 56CO 1*2G/ 250/BT/8L/5R/ CB_bg_FP_0. 3D_HG_TH22	ATRM 70	N15.4 WXGA G8	SO2 GBII6	N	N250 GB5.4 KS	NSM8 XS	3rd WiFi BG	BT 2.0	AES16 10
AS553 0G701 G2 5Mi	TW N	GCTWN	LX.AR V0X.0 14	AS5530G701G 25Mi VHP32ATTW 1 MC 82MEXTHM2 56CO 1*1G/ 250/BT/6L/5R/ CB_bg_FP_0. 3D_HG_TC11	ATRM 70	N15.4 WXGA G8	SO1 GBII6	N	N250 GB5.4 KS	NSM8 XS	3rd WiFi BG	BT 2.0	AES16 10

Test Compatible Components

This computer's compatibility is tested and verified by Acer's internal testing department. All of its system functions are tested under Windows® XP Home, Windows® XP Pro environment.

Refer to the following lists for components, adapter cards, and peripherals which have passed these tests. Regarding configuration, combination and test procedures, please refer to the Aspire 5530 series Compatibility Test Report released by the Acer Mobile System Testing Department.

Microsoft® Windows® Vista Environment Test With Fingerprint Reader SKU

Vendor	Type	Description
Adapter Test		
DELTA	90W	Adapter DELTA 90W 1.7x5.5x11 ADP-90SB BBEA LF level 4
DELTA	90W-DE	Adapter DELTA 90W 1.7x5.5x11 ADP-90SB BBEN (for OBL Spec.) LV4 LF
Audio Codec Test		
Realtek	ALC888S	
Battery Test		
SANYO	6CELL2.2	Battery SANYO AS-2007B Li-Ion 3S2P SANYO 6 cell 4400mAh Main COMMON Normal Type
SANYO	8CELL2.4	Battery SANYO AS-2007B Li-Ion 4S2P SANYO 8 cell 4800mAh Main COMMON
Bluetooth Test		
Foxconn	BT 2.0	Foxconn Bluetooth FOX_BRM_2.0 F/W 300
Camera Test		
Suyin	0.3M DV	Suyin 0.3M DV Camellia_2
Card Reader Test		
For all	5 in 1-Build in	5 in 1-Build in MS, MS Pro, SD, SC, XD
Card Bus 1 Test		
JMicron	JMB385	JMicron JMB385 Card Reader: SD/MMC/MS/MS Duo/MS-HG (1/4/8-bit) & xD (PCI Express)
CPU Test		
AMD	AAQL60	CPU AMD Athlon64X2 QL60 PGA 1.9G 1M 638 35W Griffin B1
AMD	ATRM70	CPU AMD TurionX2 RM70 PGA 2.0G 1M 638 35W Griffin B1
AMD	ATUZM80	CPU AMD TurionX2 ZM80 PGA 2.1G 2M 638 35W Griffin B1
AMD	ATUZM82	CPU AMD TurionX2 ZM82 PGA 2.2G 2M 638 35W Griffin B1
AMD	ATUZM84	CPU AMD TurionX2 ZM84 PGA 2.3G 2M 638 35W Griffin B1
AMD	ATUZM86	CPU AMD TurionX2 ZM86 PGA 2.4G 2M 638 35W Griffin B1
Fingerprint Reader Test		
Authentec	AES1610	Authentec AES1610
HDD Test		
TOSHIBA	N120GB5.4KS	HDD TOSHIBA 2.5" 5400rpm 120GB MK1246GSX Leo BS SATA I LF F/W:LB213J
SEAGATE	N160GB5.4KS	HDD SEAGATE 2.5" 5400rpm 160GB ST9160310AS Crockett SATA LF F/W:0303
TOSHIBA	N160GB5.4KS	HDD TOSHIBA 2.5" 5400rpm 160GB MK1652GSX Virgo - BS SATA LF F/W:LV010J
SEAGATE	N250GB5.4KS	HDD SEAGATE 2.5" 5400rpm 250GB ST9250827AS Corsair SATA LF F/W:3.AAA
HGST	N250GB5.4KS	HDD HGST 2.5" 5400rpm 250GB HTS543225L9A300 Falcon-B SATA LF F/W:C40C
HGST	N320GB5.4KS	HDD HGST 2.5" 5400rpm 320GB HTS543232L9A300 Falcon-B SATA LF F/W:C40C

Vendor	Type	Description
Keyboard Test		
None	14_15KB-FV3 Black	Keyboard 14_15KB-FV3 Black McKinley/Eiger Standard (Aspire Black)
LAN Test		
Broadcom	BCM5764	Broadcom BCM5764
LCD Test		
LPL	N15.4WXGAG8	LCD LPL 15.4" WXGA Glare LP154WX4-TLB4 LF 220nit 8ms
Memory Test		
NANYA	SO1GBII6	SO-DIMM DDRII 667 1GB NT1GT64U8HB0BN-3C (0.09U)
NANYA	SO1GBII6	Memory NANYA SO-DIMM DDRII 667 1GB NT1GT64UH8D0FN-3C LF 64*16 0.07um
NANYA	SO2GBII6	Memory NANYA SO-DIMM DDRII 667 2GB NT2GT64U8HD0BN-3C LF 128*8 0.07um
MICRON	SO2GBII6	Memory MICRON SO-DIMM DDRII 667 2GB MT16HTF25664HY-667E1 LF
NANYA	SO512MBII6	Memory NANYA SO-DIMM DDRII 667 512MB NT512T64UH8B0FN-3C LF 32*16 0.09um
Modem Test		
Foxconn	Fox+Con MC4Z 1.5_3.3V	Foxconn Conexant -Unizion 1.5_3.3v T60M955.02
Northbridge Chipset Test		
AMD	AMDRS780MN	AMD RS780MN w/ HDCP EEPROM
ODD Test		
SONY	NBDCB2XS	ODD SONY BD COMBO 12.7mm Tray DL 2X BC-5500S LF W/O bezel SATA
TOSHIBA	NSM8XS	ODD TOSHIBA Super-Multi DRIVE 12.7mm Tray DL 8X TS-L633A LF W/O bezel SATA
Remote Controller Test		
Fomosa21	RC804V-B	Fomosa21 Remote Controller RC804V-B EU
Southbridge Chipset Test		
AMD	AMDSB700	AMD SB700
Software Test		
None	McAfee	Antivirus application McAfee
VGA Chip Test		
AMD	86MEHM	AMD 86MEHM w/ HDCP w/o Macrovision
VoIP Phone Test		
Wistron	BT VoIP Xpress	Wistron Acer Xpress Card Phone Kit Rev 2.0
VRAM Test		
ODM	256M-GD3	256M GDDR2
WiFi Antenna Test		
WNC	PIFA	WiFi Antenna
WLAN Test		
Foxconn	3rd WiFi BG	Foxconn Atheros XB63 minicard b/g

Without Fingerprint Reader SKU

Vendor	Type	Description
Adapter Test		
DELTA	90W-DE	Adapter DELTA 90W 1.7x5.5x11 ADP-90SB BBEN (for OBL Spec.) LV4 LF
LITE-ON	90W	Adapter LITE-ON 90W 19V 1.7x5.5x11 Blue PA-1900-24AR LED LF level 4
Audio Codec Test		
Realtek	ALC888S	
Battery Test		
SANYO	6CELL2.2	Battery SANYO AS-2007B Li-Ion 3S2P SANYO 6 cell 4400mAh Main COMMON Normal Type
SANYO	8CELL2.4	Battery SANYO AS-2007B Li-Ion 4S2P SANYO 8 cell 4800mAh Main COMMON
Bluetooth Test		
Foxconn	BT 2.0	Foxconn Bluetooth FOX_BRM_2.0 F/W 300
Camera Test		
Bison	0.3M DV	Bison 0.3M DV Lotus_2
Card Reader Test		
For all	5 in 1-Build in	5 in 1-Build in MS, MS Pro, SD, SC, XD
Card Bus 1 Test		
JMicron	JMB385	JMicron JMB385 Card Reader: SD/MMC/MS/MS Duo/MS-HG (1/4/8-bit) & xD (PCI Express)
CPU Test		
AMD	AAQL60	CPU AMD Athlon64X2 QL60 PGA 1.9G 1M 638 35W Griffin B1
AMD	ATRM70	CPU AMD TurionX2 RM70 PGA 2.0G 1M 638 35W Griffin B1
AMD	ATUZM80	CPU AMD TurionX2 ZM80 PGA 2.1G 2M 638 35W Griffin B1
AMD	ATUZM82	CPU AMD TurionX2 ZM82 PGA 2.2G 2M 638 35W Griffin B1
AMD	ATUZM84	CPU AMD TurionX2 ZM84 PGA 2.3G 2M 638 35W Griffin B1
AMD	ATUZM86	CPU AMD TurionX2 ZM86 PGA 2.4G 2M 638 35W Griffin B1
HDD Test		
SEAGATE	N120GB5.4KS	HDD SEAGATE 2.5" 5400rpm 120GB ST9120817AS Corsair SATA LF F/W:3.AAA
WD	N120GB5.4KS	HDD WD 2.5" 5400rpm 120GB WD1200BEVS-22UST0 ML125 SATA LF F/W:01.01A01
SEAGATE	N160GB5.4KS	HDD SEAGATE 2.5" 5400rpm 160GB ST9160827AS Corsair SATA LF F/W:3.AAA
TOSHIBA	N160GB5.4KS	HDD TOSHIBA 2.5" 5400rpm 160GB MK1652GSX Virgo - BS SATA LF F/W:LV010J
SEAGATE	N250GB5.4KS	HDD SEAGATE 2.5" 5400rpm 250GB ST9250827AS Corsair SATA LF F/W:3.AAA
HGST	N250GB5.4KS	HDD HGST 2.5" 5400rpm 250GB HTS543225L9A300 Falcon-B SATA LF F/W:C40C
WD	N320GB5.4KS	HDD WD 2.5" 5400rpm 320GB WD3200BEVT-22ZCT0 ML160 SATA LF F/W:11.01A11
Keyboard Test		

Vendor	Type	Description
None	14_15KB-FV3 Black	Keyboard 14_15KB-FV3 Black McKinley/Eiger Standard (Aspire Black)
LAN Test		
Broadcom	BCM5764	Broadcom BCM5764
LCD Test		
SAMSUNG	N15.4WXGAG8	LCD SAMSUNG 15.4" WXGA Glare LTN154AT01-A LF 220nit 8ms NON-bracket
Memory Test		
NANYA	SO1GBII6	SO-DIMM DDRII 667 1GB NT1GT64U8HB0BN-3C (0.09U)
NANYA	SO1GBII6	Memory NANYA SO-DIMM DDRII 667 1GB NT1GT64UH8D0FN-3C LF 64*16 0.07um
NANYA	SO2GBII6	Memory NANYA SO-DIMM DDRII 667 2GB NT2GT64U8HD0BN-3C LF 128*8 0.07um
SAMSUNG	SO2GBII6	Memory SAMSUNG SO-DIMM DDRII 667 2GB M470T5663QZ3-CE6 LF
HYNIX	SO512MBII6	Memory HYNIX SO-DIMM DDRII 667 512MB HYMP164S64CP6-Y5 LF 64*16 0.065um
Modem Test		
Foxconn	Fox+Con MC4Z 1.5_3.3V Aus	Foxconn Conexant -Unizion 1.5_3.3v AUS T60M955.0x
Northbridge Chipset Test		
AMD	AMDRS780MN	AMD RS780MN w/ HDCP EEPROM
ODD Test		
SONY	NBDCB2XS	ODD SONY BD COMBO 12.7mm Tray DL 2X BC-5500S LF W/O bezel SATA
TOSHIBA	NSM8XS	ODD TOSHIBA Super-Multi DRIVE 12.7mm Tray DL 8X TS-L633A LF W/O bezel SATA
Remote Controller Test		
Fomosa21	RC804V-B	Fomosa21 Remote Controller RC804V-B EU
Southbridge Chipset Test		
AMD	AMDSB700	AMD SB700
Software Test		
None	McAfee	Antivirus application McAfee
VGA Chip Test		
AMD	82MEXTHM	AMD 82MEXTHM w/ HDCP w/o Macrovision
VoIP Phone Test		
Wistron	BT VoIP Xpress	Wistron Acer Xpress Card Phone Kit Rev 2.0
VRAM Test		
ODM	256M-GD2	256M GDDR2
WiFi Antenna Test		
WNC	PIFA	WiFi Antenna
WLAN Test		
Foxconn	3rd WiFi BG	Foxconn Atheros XB63 minicard b/g

Online Support Information

This section describes online technical support services available to help you repair your Acer Systems.

If you are a distributor, dealer, ASP or TPM, please refer your technical queries to your local Acer branch office. Acer Branch Offices and Regional Business Units may access our website. However some information sources will require a user i.d. and password. These can be obtained directly from Acer CSD Taiwan.

Acer's Website offers you convenient and valuable support resources whenever you need them.

In the Technical Information section you can download information on all of Acer's Notebook, Desktop and Server models including:

- Service guides for all models
- User's manuals
- Training materials
- Bios updates
- Software utilities
- Spare parts lists
- TABs (Technical Announcement Bulletin)

For these purposes, we have included an Acrobat File to facilitate the problem-free downloading of our technical material.

Also contained on this website are:

- Detailed information on Acer's International Traveler's Warranty (ITW)
- Returned material authorization procedures
- An overview of all the support services we offer, accompanied by a list of telephone, fax and email contacts for all your technical queries.

We are always looking for ways to optimize and improve our services, so if you have any suggestions or comments, please do not hesitate to communicate these to us.

A

AFLASH Utility 39
Antennas 107

B

Battery Pack 50
BIOS
 package 18
 ROM size 18
 ROM type 18
 vendor 18
 Version 18
BIOS Passwords
 Removing 45
BIOS Supports protocol 18
BIOS Utility 27–39
 Advanced 30
 Boot 36
 Exit 38
 Navigating 27
 Onboard Device Configuration 33
 Power 35
 Save and Exit 38
 Security 32
 System Security 38
Bluetooth module 88
Board Layout
 Top View 165
brightness
 hotkeys 14

C

Cache
 controller 18
 size 18
Camera Module 103
caps lock
 on indicator 10
Common Problems 144
computer
 on indicator 10
CPU 97

D

DIMM Module 55
Display 4
display
 hotkeys 14

E

EasyTouch Failure 156
Ekey Board 83
eKey Board 83
Euro 15
External Module Disassembly
 Flowchart 49

F

Features 1
Fingerprint Reader Failure 157
Flash Utility 39
FPC Cable 106
FRU (Field Replaceable Unit) List 171

H

Hard Disk Drive Module 60
HDD Passwords
 Removing 42
HDTV Switch Failure 158
Hibernation mode
 hotkey 14
Hot Keys 12

I

Indicators 10
Intermittent Problems 160
Internal Microphone Failure 150
Internal Speaker Failure 148
inverter board 101

J

Jumper and Connector Locations 165
 Top View 165

K

Keyboard 67
Keyboard Failure 147

L

Launch Board 82
LCD Bezel 100
LCD Brackets 106
LCD Failure 147
LCD Module Disassembly
 Flowchart 99
LCD Panel 105
lower cover 53

M

Main Unit Disassembly
 Flowchart 64
Mainboard 92
media access
 on indicator 10
MediaTouch Button Failure 157
Memory Check 144
Model Definition 184
Modem Failure 155
Modem Module 90

N

No Display Issue 145
Notebook Manager
 hotkey 14
num lock
 on indicator 10

O

ODD Failure 152
Online Support Information 193
optical drive module 62

P

Panel 5
 Bottom 9
 left 5
PC Card 10
Power On Failure 144

R

Right Speaker Module 86

S

speakers
 hotkey 14
System
 Block Diagram 4

T

Test Compatible Components 187
Thermal Unit Failure 158
Top 165
Touch Pad Bracket 80
touchpad
 hotkey 14
Touchpad Failure 148
Troubleshooting
 Built-in KB Failure 147
 EasyTouch Buttons 156
 Fingerprint Reader 157
 HDTV Switch 158
 Internal Microphone 150
 Internal Speakers 148
 LCD Failure 147
 MediTouch Buttons 157
 Modem 155
 No Display 145
 ODD 152
 Other Failures 159
 Power On 144
 Thermal Unit 158
 Touchpad 148
 USB 155
 WLAN 156
TV tuner 58

U

Undetermined Problems 160
USB Failure (Rightside) 155
utility
 BIOS 27–39

V

VGA Module 98

W

Windows 2000 Environment Test 188

Wireless Function Failure 156

WLAN Board 56

